

IBM InfoSphere Master Data Management Standard and
Advanced Editions
Version 11 Release 3

Installation Guide



IBM InfoSphere Master Data Management Standard and
Advanced Editions
Version 11 Release 3

Installation Guide



Note

Before using this information and the product that it supports, read the information in “Notices and trademarks” on page 191.

Edition Notice

This edition applies to version 11.3 of IBM InfoSphere Master Data Management and to all subsequent releases and modifications until otherwise indicated in new editions.

© Copyright IBM Corporation 1996, 2014.

US Government Users Restricted Rights – Use, duplication or disclosure restricted by GSA ADP Schedule Contract with IBM Corp.

Contents

Tables	v
-------------------------	----------

Figures	vii
--------------------------	------------

Chapter 1. Installing IBM InfoSphere Master Data Management Standard and Advanced Editions 1

Installation requirements	2
32-bit libraries needed on 64-bit operating systems	4

Chapter 2. Installation overview 7

Features installed by IBM Installation Manager	8
Installation Startup Kit for custom installations	10
Multiple instance support.	11
User accounts, groups, and defaults used by the installation application	12
Password storage and exposure	14
Encrypting passwords with WebSphere Application Server	14
Directory structures.	14
MAD_ROOTDIR and MAD_HOMEDIR use	16

Chapter 3. Installing the product. 19

Planning an installation	20
Stand-alone or custom installation deployment types	21
Graphical or silent installation	25
Support for high availability environments	26
Worksheets for installation and configuration	26
Installation scenarios	43
Installing a stand-alone server with DB2.	56
Acquiring and extracting the installation files	56
Preparing for a stand-alone installation with DB2	57
Starting a stand-alone with DB2 installation using LaunchPad	58
Installing a stand-alone server with DB2.	58
Installing a stand-alone workstation with DB2.	63
Acquiring and extracting the installation files	63
Preparing for a stand-alone installation with DB2	64
Starting a stand-alone with DB2 installation using LaunchPad	64
Installing a stand-alone workstation installation with DB2	65
Installing a custom deployment	70
Acquiring and extracting the installation files	70
Preparing for a custom deployment	71
Installing a custom deployment of InfoSphere MDM	113
Silent installation	132
Manual installation using the madconfig utility	143
Installing a hybrid MDM solution	148
Installing client applications and individual components	149
Installing the Business Administration UI	150

Installing Data Stewardship UI	151
Installing the Product Maintenance UI	153
Installing InfoSphere MDM Workbench.	155
Samples installation	157
Verifying the base installation	159
Verifying the installation with the Test Client on WebSphere Application Server.	159
Test Client properties.	161
Installation logs	161
Modifying your installation	163
Adding a new node to an existing cluster	164
Updating the deployed properties files for physical MDM	166

Chapter 4. Applying fix packs 169

Downloading and installing a fix pack	169
Excluding specified components from a fix pack	170
Rolling back an applied fix pack	170

Chapter 5. Troubleshooting installations of Standard or Advanced Editions. 173

Installation errors	173
Installation error: Access is denied for the checkIfAppExists operation on AppManagement MBean	173
Installation error: AdminTask	174
Installation error: AdminTask object is not available	175
Installation error: Bind process is not active	177
Installation error: Blank page displays after logging in to UI	177
Installation error: Cannot add asset com.ibm.mdm.hub.server.app.eba	178
Installation error: httpPort property cannot be blank	179
Uninstallation error: Installer does not drop virtual MDM tables	180
Installation error: "java.lang.RuntimeException: Application could not be initialized	181
Installation error: OutOfMemoryError - PermGen space.	181
Installation error: SSL handshake failure	182
Uninstallation error: The system cannot create a SOAP connector to connect to host localhost at port 88xx	183
Installation error: Virtual MDM IVT failure	184

Chapter 6. Uninstalling InfoSphere MDM 185

Uninstalling your InfoSphere MDM instance	185
Uninstalling a stand-alone server installation with DB2	186

Uninstalling a stand-alone workstation installation with DB2	186
Uninstalling a single component	187
Uninstalling in silent mode.	188
Removing the CBA from internal bundle repository	189
Notices and trademarks	191
Index	197
Contacting IBM	201

Tables

1. Installation requirements	2	18. System checks.	68
2. Installed InfoSphere MDM features	9	19. Database checks	68
3. InfoSphere MDM user accounts.	12	20. Operational server checks.	70
4. InfoSphere MDM user groups	12	21. System checks	116
5. <i>MDM_INSTALL_HOME</i> directories.	15	22. Database checks.	117
6. InfoSphere MDM installation directory worksheet	27	23. Operational server checks	119
7. IBM DB2 or DB2 for z/OS data source worksheet	28	24. Basic madconfig utility targets	143
8. Microsoft SQL Server data source worksheet	30	25. madconfig utility targets for operational server installation	145
9. Oracle data source worksheet	32	26. madconfig utility targets for database installation	145
10. IBM WebSphere Application Server installation worksheet	34	27. madconfig utility targets for web-based user interfaces	146
11. MDM application installation worksheet	37	28. madconfig utility targets for Flexible Search	147
12. User application installation worksheet	39	29. madconfig utility targets for uninstall	148
13. InfoSphere MDM user applications.	40	30. Installation verification tests	160
14. History installation worksheet	41	31. Properties that can be set in the Test Client properties file	161
15. System checks.	61	32. IBM resources	201
16. Database checks	61	33. Providing feedback to IBM	201
17. Operational server checks.	62		

Figures

1. InfoSphere MDM Installation Overview . . .	1	4. Stand-alone workstation installation with DB2	23
2. InfoSphere MDM Installation Overview	19	5. Custom installation in a clustered environment	25
3. Stand-alone server installation with DB2	22		

Chapter 1. Installing IBM InfoSphere Master Data Management Standard and Advanced Editions

The InfoSphere® MDM components are installed using IBM® Installation Manager, which ensures a simple and consistent installation experience.

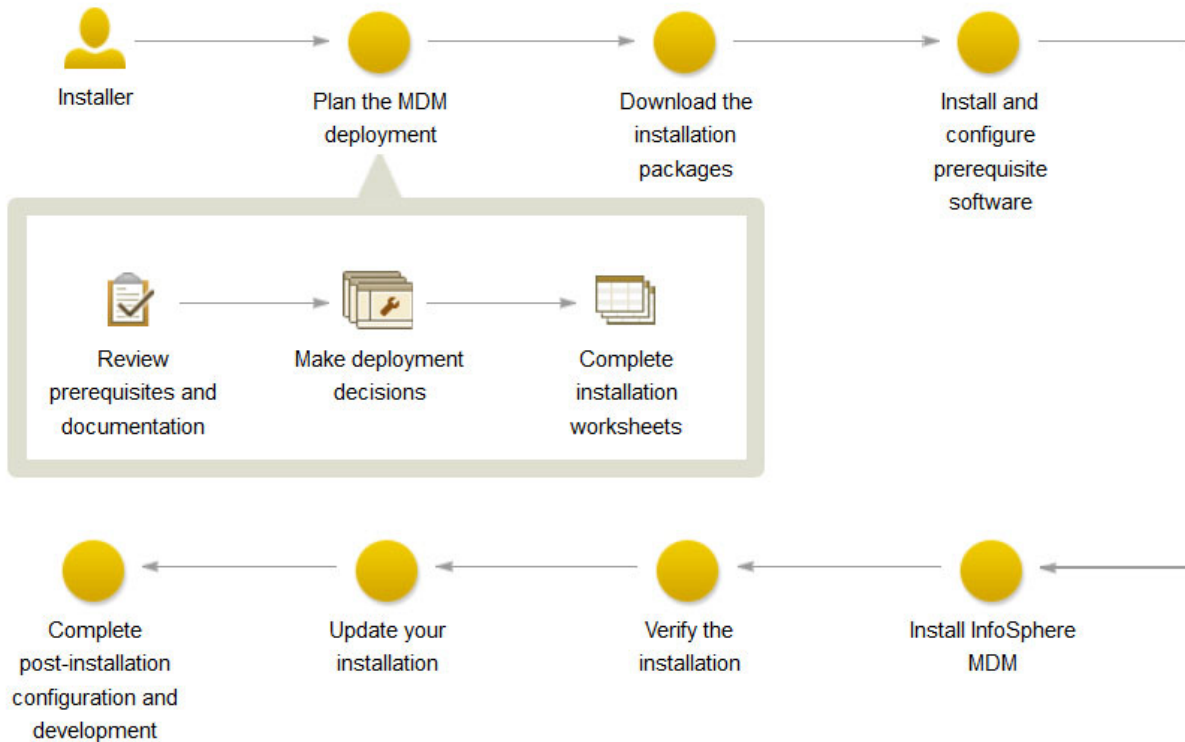

Figure 1. InfoSphere MDM Installation Overview

Important: Before you begin the process of installing InfoSphere MDM, review the known problems. Some of the known installation problems require you to complete specific preinstallation configuration tasks. Failure to complete these configuration tasks can result in a failed installation.

The installation topics describe how to prepare your environment, including the application server and database, for installation of InfoSphere MDM and how to install InfoSphere MDM. You can run an installation in graphical or silent mode.

IBM Installation Manager is also used to uninstall components and to modify an existing installation by adding or removing components.

Tip: You can download a PDF version of the installation topics.

Related information:

[Download IBM InfoSphere Master Data Management installation packages based on edition](#)

Installation requirements

Use this list as a reference before you start the installation. If you are also installing IBM DB2®, IBM WebSphere® Application Server, or IBM Rational® Application Developer, the list also offers a guideline for choosing the correct features to install.

Attention: For an accurate listing of supported hardware and software and required versions, always review the IBM InfoSphere Master Data Management System Requirements page. The link to this page can be found in the release notes for this version.

To install any of the features and applications, you must have IBM Installation Manager 1.7 installed on the system from which you are running the installation. IBM Installation Manager is packaged with InfoSphere MDM. IBM Installation Manager can be run only on a 64-bit machine.

The servers or workstations on which you install require a minimum of 30 GB available space.

Stand-alone server installations require 40 to 50 GB available space. Stand-alone workstation installations require 60 to 70 GB.

If the feature or application that you want to install is not listed in this table, see the documentation for that feature to learn about specific requirements.

Table 1. Installation requirements

If you are planning to install this feature	You need this prerequisite:
InfoSphere MDM Standard, Advanced, or Enterprise Edition	All servers and workstations on which you install and use InfoSphere MDM components have a supported operating system installed and configured. Use the product-specific documentation for guidance. Important: The Advanced Edition supports installation on Microsoft Windows operating system for a customization environment only. A production environment on Windows is not supported for Advanced Edition. Only Standard Edition is supported on Windows for both customization and production environments.
Installation Startup Kit	Important: Make sure that you install the Installation Startup Kit if you plan to perform a custom installation. You do not need to install the kit if you are performing a stand-alone server installation or a stand-alone workstation installation.

Table 1. Installation requirements (continued)

If you are planning to install this feature	You need this prerequisite:
MDM operational server	<p>This feature installs the core IBM WebSphere Application Server bundles, EBAs, and so on for your operational server.</p> <p>If you are performing a stand-alone installation, IBM Installation Manager installs the IBM WebSphere Application Server and configures it with default settings.</p> <p>If you are performing a custom installation, you must have the supported version of IBM WebSphere Application Server installed and an administrative profile (user name and password) created. After you install IBM WebSphere Application Server, use the preparing your application server topics to configure the server.</p>
MDM Database	<p>The database component creates the InfoSphere MDM tables and schema.</p> <p>If you are performing a stand-alone installation, IBM DB2 is installed and configured with default settings by IBM Installation Manager.</p> <p>For custom installations, you must have a supported database installed and configured with a user account name and password that you intend to use to connect to your MDM operational server.</p> <p>Use the product-specific documentation for guidance. After you install the database software, use the preparing database topics to configure the database to support InfoSphere MDM.</p>
User applications	<p>A supported web browser must be installed on the workstations that access the application.</p>
InfoSphere MDM Workbench	<p>You must install IBM Rational Application Developer for WebSphere (64-bit) before you install the workbench on your workstation.</p>
IBM DB2	<p>For a stand-alone installation:</p> <p>Install the DB2 database wrapper that is included with the InfoSphere MDM installation. Use the selected default features. Important: This software is required if you are performing a stand-alone installation.</p> <p>For a custom installation:</p> <p>If you wish to configure a DB2 database as part of a custom installation, you must have installed IBM DB2 Enterprise Edition.</p>

Table 1. Installation requirements (continued)

If you are planning to install this feature	You need this prerequisite:
IBM WebSphere Application Server	<p>Select these features to install for your application server:</p> <ul style="list-style-type: none"> • IBM WebSphere Application Server <ul style="list-style-type: none"> – IBM WebSphere Application Server Full Profile – IBM WebSphere Application Server SDK for Java™ Technology Edition 6 <p>Always check the system requirements page for the supported version number.</p>
IBM Rational Application Developer	<p>When you install IBM Rational Application Developer , you must select, at a minimum, these additional required features in IBM Installation Manager:</p> <ul style="list-style-type: none"> • Web Developer Tools <ul style="list-style-type: none"> – AJAX, Dojo, and HTML – JSF – JSP and servlet • Enterprise Developer Tools <ul style="list-style-type: none"> – Data access – OSGi application • IBM WebSphere Application Server <ul style="list-style-type: none"> – Development tools – Remote server stub <p>You must also make sure that the required 32-bit libraries are available on your 64-bit operating system.</p>

Related tasks:

“Installing InfoSphere MDM Workbench” on page 155

“Preparing for a custom deployment” on page 71

“Acquiring and extracting the installation files” on page 56

Related reference:

“User applications and operational server associations” on page 40

32-bit libraries needed on 64-bit operating systems

When you install InfoSphere MDM Workbench and IBM Rational Application Developer on a 64-bit workstation, you must have certain 32-bit libraries available on the workstation for a successful installation.

You must either install the 32-bit libraries that are listed here or install IBM Rational Application Developer in 64-bit mode before you install InfoSphere MDM features.

The required 32-bit libraries are:

- libatk-1.0.so.0
- libfontconfig.so.1
- libfreetype.so.6
- libgdk_pixbuf-2.0.so.0
- libgdk-x11-2.0.so.0

- libglib-2.0.so.0
- libgmodule-2.0.so.0
- libgobject-2.0.so.0
- libgthread-2.0.so.0
- libgtk-x11-2.0.so.0
- libpango-1.0.so.0
- libpangoft2-1.0.so.0
- libpng12.so.0
- libselinux.so.1
- libX11.so.6
- libXcomposite.so.1
- libXcursor.so.1
- libXdamage.so.1
- libXext.so.6
- libXfixes.so.3
- libXft.so.2
- libXinerama.so.1
- libXi.so.6
- libXrandr.so.2
- libXrender.so.1
- libXtst.so.6
- libz.so.1

Related tasks:

“Installing a stand-alone workstation installation with DB2” on page 65

“Installing InfoSphere MDM Workbench” on page 155

Chapter 2. Installation overview

Most IBM InfoSphere Master Data Management components can be installed on a server or workstation, a combination of the two, or across multiple servers to support clustered environments.

Important: Before you begin the process of installing InfoSphere MDM, review the known problems. Some of the known installation problems require you to complete specific preinstallation configuration tasks. Failure to complete these configuration tasks can result in a failed installation.

Tip: Use the Download IBM InfoSphere Master Data Management page to help determine the parts that you need for your licensed edition and version.

You must set up both a client system and one or more server systems. The application server, database server, and HTTP server can all be on the same server, or they can each be on their own server. The HTTP server is recommended, but is optional.

The time that is required to install InfoSphere MDM depends on a number of factors and, as such, time estimates cannot be provided. Some factors that influence the amount of time to prepare and install can include:

- The number of components that are being installed.
- The number of servers or workstations in your environment.
- Your network load capacity if you are installing in a clustered environment.
- Whether IBM WebSphere Application Server is already installed.
- Whether your database software is already installed.

The first step in the installation process is to determine the best deployment type for your requirements: one of the stand-alone with DB2 installation types (server or workstation) or the custom installation type. Most production implementations require a custom deployment.

Optionally, you can use the LaunchPad to start either a stand-alone with DB2 or custom installation. LaunchPad enables you to choose the installation type, and then it configures IBM Installation Manager to use the installation files appropriate to your selection. For custom installations, you have the opportunity to change the selected offerings to install after Installation Manager starts.

Tip: LaunchPad is a browser-based application that is used as the starting point for a stand alone server or workstation installation. LaunchPad requires the Mozilla Firefox browser. If Firefox is unavailable, you might be unable to use LaunchPad. If you cannot use LaunchPad:

1. Log in as the root user.
2. Install IBM Installation Manager in admin mode.
3. Manually configure the InfoSphere MDM installation repositories.

After IBM Installation Manager is started, the basic order in which it works is described in these steps.

1. Select the features of InfoSphere MDM that you want to install.

Important: The MDM Database and MDM operational server are both required components. The MDM Database includes the core database tables for the edition that you are installing. The MDM Operational Server provides critical processing functionality.

2. After you select the features and installation directory location, the installer does some basic checks on the operating system, disk space, and supporting software before continuing with the installation. If the installation directory specified is an existing directory, IBM Installation Manager verifies whether there is an existing installation and, if found, warns you about overwriting the installation.
3. You are then prompted to enter information in a series of configuration panels. This information is used to automatically configure the MDM database and application server with specific connection information and to identify the cell, node, and servers on which the InfoSphere MDM artifacts are deployed. If you are using a stand alone installation, the configuration panels do not display. Default values are used to automatically configure the database, application server, and operational server settings.
4. Static data is extracted into the *MDM_INSTALL_HOME* directory that you selected at the beginning of the process. Static data includes items like the Batch Processor, Management Agent, Management Console, and the **madconfig** utility scripts among other items.
5. Database tables and indexes are created.
6. Next, the native components and web services are deployed to the application server. That means that all artifacts are deployed in all specified nodes.
7. User interfaces and web applications that are selected for installation are also deployed to the application server. The installer packages web-based application WAR files into an EAR file and deploys the EAR file to the application server. During deployment, the application server unpacks the content of the EAR files.
8. Native configuration files *.cfg* are created.
9. After deployment, the database is bootstrapped.
10. Before the installation is complete, the installer completes a verification process by running transactions through the operational server.

In addition to the verification tests that the installation application runs, you can use the Test Client to run test transactions to ensure a successful installation.

Related concepts:

“Verifying the base installation” on page 159

Related information:

 [Download IBM InfoSphere Master Data Management](#)

Features installed by IBM Installation Manager

The features that you can install are dependent upon the InfoSphere MDM edition that you choose.

This table shows the features that you can install with IBM Installation Manager. In this table, an asterisk * indicates that the feature can be installed only on a workstation. Two asterisks ** indicate that the product is not supported for use with a Microsoft SQL Server database.

Table 2. Installed InfoSphere MDM features

If you install:	These features are available:
InfoSphere MDM Standard Edition	<p>MDM Database</p> <p>MDM Operational Server (includes Enterprise Service Oriented Architecture (ESOA) Toolkit, Java, and Web Services SDKs)</p> <p>User applications:</p> <ul style="list-style-type: none"> • Inspector • Enterprise Viewer • Web Reports • Provider Direct • Pair Manager* <p>Samples</p> <p>Patient - Advanced edition component (this item is automatically installed with Standard Edition and is not listed as an option on IBM Installation Manager)</p>
InfoSphere MDM Advanced Edition	<p>Advanced Edition includes all features that are listed for Standard Edition plus these applications:</p> <ul style="list-style-type: none"> • Business Administration UI** • Data Stewardship UI** • Product Maintenance UI**
InfoSphere MDM Enterprise Edition	<p>Includes all of the Advanced Edition features, plus Collaborative Edition, and InfoSphere MDM Extension for Unstructured Text Correlation</p>
InfoSphere MDM Workbench	<p>MDM Workbench* (supports virtual, physical, and hybrid implementations). IBM Rational Application Developer is also bundled with InfoSphere MDM and must be installed before you install InfoSphere MDM Workbench.</p>
IBM DB2	<p>If you are planning to perform a stand alone installation, you can elect to install a DB2 database wrapper. The wrapper contains the native DB2 database installer and runs in silent mode through IBM Installation Manager.</p> <p>If you plan to use a custom installation, then you must install DB2 on your own by using the native DB2 installer.</p>
IBM WebSphere Application Server	<p>IBM WebSphere Application Server is required for the implementation of InfoSphere MDM. If you do not have this application server installed, you can elect to install it when you install InfoSphere MDM. This feature is installed when you perform a stand alone installation.</p>

In addition to InfoSphere MDM Standard Edition and Advanced Edition, other IBM MDM components, editions, and products are also installed using IBM Installation Manager. Those components are listed here and their installation instructions are provided in their online documentation.

- IBM Stewardship Center

- InfoSphere MDM Application Toolkit
- Master Data Policy Monitoring
- InfoSphere MDM Collaboration Server
- InfoSphere MDM Custom Domain Hub and InfoSphere MDM Reference Data Management Hub

Related concepts:

“Stand-alone installation deployment types” on page 21

“Stand-alone server installation with DB2” on page 22

“Stand-alone workstation installation with DB2” on page 23

Related reference:

“User applications and operational server associations” on page 40

Installation Startup Kit for custom installations

The Installation Startup Kit includes files and scripts to help you prepare your environment before you install InfoSphere MDM.

The files and scripts for the Installation Startup Kit are deployed to the folder that you define as the *STARTUPKIT_INSTALL_HOME*. These items can be used to help you to complete a custom installation.

Database creation and configuration

Tip: The database scripts in the Installation Startup Kit must be run before you begin the InfoSphere MDM installation.

The scripts automatically create the appropriate tables, tablespaces, buffer pools, encoding specifications, and triggers that are required for your edition.

The installation application can create the necessary tablespaces for your deployment. Alternatively, you can create them prior to installing InfoSphere MDM using the provided scripts.

Tip: Create one temporary tablespace for each blocksize. For example, if you have 16K tablespaces, then create a 16K temporary tablespace.

- The scripts to create IBM DB2 databases and tablespaces are located in *STARTUPKIT_INSTALL_HOME/CoreData/Full/DB2/Standard/ddl/*
 - *CreateDB.sql*
 - *CreateTS.sql*
- The scripts to create a DB2 for z/OS® database and install core and domain data:
 - *STARTUPKIT_INSTALL_HOME/CoreData/Full/DB2/ZOS/pds/*
 - *STARTUPKIT_INSTALL_HOME/Full/DB2/ZOS/pds/*

The scripts are configured to run from a TSO session using JCL scripts in the mainframe.

- Script to create an Oracle database: *STARTUPKIT_INSTALL_HOME/CoreData/Full/Oracle/Standard/ddl/create_schema_ora.sql*
- Script to create a Microsoft SQL Server database: *STARTUPKIT_INSTALL_HOME/CoreData/Full/SQLServer/ddl/CreateDB.sql*
- Microsoft SQL Server files that are used for XA transactions are located in *STARTUPKIT_INSTALL_HOME/SQLServer JTA:*

- sqljdbc.dll files to support either 32-bit or 64-bit SQL Server are in win32 and win64_amd64
- instjdbc.sql

Messaging component setup

The Installation Startup Kit includes scripts that you can use to install the InfoSphere MDM messaging component when WebSphere MQ is on a machine that is different than the one where IBM Installation Manager is running, use the scripts `custSetupMQServer.mqsc` and `ChannelAuth.mqsc`.

Prerequisite checking tool

The prerequisite checking command line tool helps to prevent you from beginning an installation that will be unable to successfully complete due to missing prerequisites. This tool has the following capabilities:

- Runs prerequisite checks for InfoSphere MDM installation.
- Performs basic data collection – Collects logs and configuration files.
- Performs extended data collection – Collects logs, configuration files, and metadata stored in the database

The prerequisite checking tool's data collection capabilities can be useful after an InfoSphere MDM has completed or if you need to troubleshoot an installation. The results of these collections are stored in a compressed file.

Silent installation response files

The Installation Startup Kit includes sample response files (.res). These files are samples that can be used as templates for running silent installations. The sample response files are located in `STARTUPKIT_INSTALL_HOME` at the root level.

Related tasks:

“Installing silently by using a response file” on page 142

“Installing the Installation Startup Kit” on page 73

“Installing and setting up the database” on page 81

“Checking prerequisites using the command line tool” on page 112

Related reference:

“Silent installation” on page 132

Multiple instance support

Multiple instances of InfoSphere MDM is supported by installing the application in a clustered environment.

All InfoSphere MDM application instances in the clustered nodes within a WebSphere Application Server cell must be deployed with the same version of InfoSphere MDM product code and must have the same version of the InfoSphere MDM customization code.

If you want to use the same physical machine (or LPAR) to deploy a second InfoSphere MDM application instance that is running a different version of InfoSphere MDM product code, you must create a second WebSphere Application Server cell, deployment manager, and node profile.

If you want to configure a simple functional test environment, you can use the same WebSphere Application Server cell and node to deploy multiple instances of InfoSphere MDM with the same version of InfoSphere MDM product code and different version of the InfoSphere MDM customization code. However, some

limitations do apply. Once you uninstall any one of InfoSphere MDM instances in the WebSphere Application Servercell, the other InfoSphere MDM instances are no longer functional. Do not attempt this configuration in a production environment.

Related tasks:

“Installing InfoSphere MDM into a clustered environment” on page 124

“Preparing for a custom deployment” on page 71

User accounts, groups, and defaults used by the installation application

When InfoSphere MDM is installed, default users and user groups are created on the application server.

Users (stand-alone with DB2 installations only)

The following table lists the default user accounts and passwords created by the installation application during a stand-alone with DB2 installation. During a custom installation, you can define whatever user name and password values you would like.

Table 3. InfoSphere MDM user accounts

User name	Password	Description
mdmins11	mdmins11	If you perform a stand-alone installation on a Linux or UNIX operating system, this user name and password combination is created for your IBM DB2 database. Important: For security purposes, if you use the default mdmadmin password, you are encouraged to change the user password after installation.
db2admin	db3Admin	If you perform a stand-alone installation on a Microsoft Windows operating system, this user name and password combination is created for your IBM DB2 database. Important: For security purposes, if you use the default db2admin password, you are encouraged to change the database password after installation.

Before you begin a custom installation of InfoSphere MDM, create a IBM WebSphere Application Server profile with security enabled. The user name and password can be anything that you want.

Groups

The following table lists the groups and roles that are created by the installation application. You can add users to these groups through the IBM WebSphere Application Server Integrated Solutions Console (admin console).

Table 4. InfoSphere MDM user groups

InfoSphere MDM group	Description
mdm_admin	Administrative role that is equivalent to a super user.

Table 4. InfoSphere MDM user groups (continued)

InfoSphere MDM group	Description
DataSteward	This role is available only if user interface components are installed.
mdm_default	This role allows user access to the application server container without granting the user-specific permissions.
mdm_all_ops	This role allows user access to all InfoSphere MDM operations.
mdm_all_cvws	This role allows user access to all composite views.
mdm_all_ixns	This role allows user access to all InfoSphere MDM interactions.
mdm_all_segs_rw	This role allows read and write access to all segments.
mdm_all_segs_ro	This role allows read only access to all segments.
ServiceConsumer	This role maps to all authenticated users and is associated with all entry point modules.
ServiceProvider	This role maps to one default user: mdm. This role is associated with all modules that are not considered entry points.

Other defaults used for stand-alone with DB2 installations

If you use a stand-alone with DB2 installation type, the installer uses a number of default values.

If you are installing on Linux or UNIX (for server deployments), the following defaults are used:

- DB2 database name: MDM11DB
- DB2 home directory: /home/mdmins11

If you are installing on Microsoft Windows (for workstation deployments), the following defaults are used:

- DB2 database name: MDM11DB

Tip: For security reasons, after the installation is complete, ensure that the passwords of these default accounts are unique and different from the default values. For information about changing the passwords, refer to the relevant WebSphere Application Server and DB2 documentation.

Related concepts:

“Account prerequisites for custom installations” on page 74

“Verifying the base installation” on page 159

Related tasks:

“Installing a stand-alone server with DB2” on page 58

“Installing a stand-alone workstation installation with DB2” on page 65

“Preparing for a stand-alone installation with DB2” on page 57

“Creating a new user and adding the user to an MDM group” on page 79

Related reference:

“Database user accounts and connections” on page 82

Related information:

 [Managing users](#)

- Enabling user security for the operational server
- Configuring users and user groups for virtual MDM

Password storage and exposure

During installation, passwords are encrypted by using WebSphere Application Server encryption.

All user interface applications and client applications have a user name and password to connect to the MDM operational server. These passwords are also encrypted by using the WebSphere Application Server encryption mechanism. If any of the passwords are changed on the application server, then you must also apply the change in the respective component properties file as well.

Be aware that when the installer generates response files that can be used for silent installations, these files contain user passwords in plain text. If plain text passwords stored in the files are against your organizational policies, use the graphical installation mode.

Related information:

- Configuring secure MDM environments

Encrypting passwords with WebSphere Application Server

If you must change a user name and password in a properties file after installation, you can use this task to encrypt the new password.

About this task

To prevent the password from being stored in clear text in your properties file, you can use WebSphere Application Server to encrypt the password.

Procedure

1. Create a text file called `mypassword.txt`.
2. Add this line to the file: `mypassword=user_password` and save the file.
3. Run the following command to encode the password value:
 - For Microsoft Windows: `$NODE_HOME\bin\PropFilePasswordEncoder.bat path\mypassword.txt mypassword`
 - For Linux and UNIX: `$NODE_HOME/bin/PropFilePasswordEncoder.sh path/mypassword.txt mypassword`

Where `$NODE_HOME` represents the home directory of the WebSphere Application Server node and `path` represents the directory location of the `mypassword.txt` file.

4. Open the `mypassword.txt` file and copy the encrypted password value to the password field in your properties file.

Related information:

- Configuring secure MDM environments

Directory structures

There are three directories you want to understand when you install and use InfoSphere MDM: the installation directory, the shared directory, and the application server directory.

When you run IBM Installation Manager, you choose an installation path. This path and root directory are defined in the installation topics as *MDM_INSTALL_HOME*. *MDM_INSTALL_HOME* contains resources that are unique to the installed package. Within this directory are subdirectories for each of the components that you selected for installation. It also has directories that are specific to the operating system on which you install.

The MDMSHared directory contains resource files that are shared by multiple installed package groups. The contents can include resources that are needed to run IBM Installation Manager scripts, Java custom code libraries, and IBM Rational Application Developer for example. For more information about this directory, see the online documentation for IBM Installation Manager.

The application server path to which the installed components are deployed is defined in the installation topics as *WAS_PROFILE_HOME*.

MDM_INSTALL_HOME

Contents of the installation directory includes, but is not limited to, the subdirectories that are listed in the following table. The specific directories that you see depends on the features that you install.

Table 5. *MDM_INSTALL_HOME* directories

Directory	Description
aix, linux, solaris, win32, win64, zlinux	These directories contain operating system-specific files.
BatchProcessor	Contains subdirectories and files that are required to run the Batch Processor tool. The Batch Processor is designed primarily to work with physical MDM data.
com.ibm.mdm.tools	Contains OSGi bundles. An MDM Workbench workspace can be configured to use these bundles so that reference models and Java class references can be resolved.
database	Contains static schema files.
documentation	Contains a <code>messages.properties</code> file in the <code>/nl/</code> subdirectory, which is used by the installer during run time. For example, it contains messages that are used by the installer progress monitor.
EnterpriseIntegrator	Contains subdirectories and files that are required to configure and use the InfoSphere MDM Healthcare Point of Service Integrator search application.
eventManagmentClient	Contains subdirectories and files to support the Event Manager component. The Event Manager is a triggering component that can detect events and activities in MDM.
InstallableApps	Contains subdirectories and files for any installed user applications. Applications include, but are not limited to, Data Stewardship UI, Product Maintenance UI, Inspector, and Web Reports.
IVT	Contains subdirectories and scripts that are used to run the installation verification tests.
logs	Contains the logs that are recorded during the installation process.

Table 5. MDM_INSTALL_HOME directories (continued)

Directory	Description
ManagementAgent	Contains subdirectories and files that are used to run the configuration management agent, which is used to configure and manage several MDM features.
ManagementConsole	Contains subdirectories and files that are used by the Management Console. The Management Console is the user interface that supports the management agent.
MDMCollector	Contains subdirectories and files that are used to run IBM Support Assistant Data Collector.
mds	This directory contains files for virtual MDM (formerly IBM Initiate Master Data Service®). Java and Web Service SDK examples are installed in the /lib/sdk/examples directory. It also contains utilities in the /scripts directory, like the madconfig utility.
MessageBrokerSuite	Contains subdirectories and configuration files that are used to implement and manage the Message Broker components. Message Broker components are typically used in virtual implementations to support messaging between source systems and the operational server and MDM database.
PCDS	Contains subdirectories and files that support the Patient Clinical Data Search user interface.
properties	Contents in this directory provide input parameters that are used when you reset the MDM database and server from MDM Workbench.
Samples	Contains mappings and source code files that can be used in development environments.
temp	Contains all database logs. After installation, if you reset the database, this directory is used to copy all temporary SQL files.
tmp	Contains temporary files that are used during the installation process.
Uninstall	This directory contains the scripts that are needed to uninstall the MDM components.
utils	Contains common entity name instance private key generator assets.

Related concepts:

“Installing client applications and individual components” on page 149

MAD_ROOTDIR and MAD_HOMEDIR use

MAD_ROOTDIR and MAD_HOMEDIR are both terms and variables that are familiar to users of IBM Initiate Master Data Service. The definitions of these terms with regards to InfoSphere MDM installation and operational server changes.

In earlier versions of the product (before version 11.0), the MAD_ROOTDIR contained the installed files, including all binary files. MAD_HOMEDIR contained all instance configuration information. Now, however, the contents of the two directories are

combined in a sense. `MAD_ROOTDIR` contains both the installed binary files and the operational server configuration information. The concept of a pure `MAD_HOMEDIR` is no longer valid.

In the documentation, the term `MDM_INSTALL_HOME` represents the root path where all InfoSphere MDM features are installed.

During the installation process, a working `MAD_ROOTDIR` path is created in the `MDM_INSTALL_HOME` directory. The path is noted in documentation as `MDM_INSTALL_HOME/mds`. This path contains the configuration for the operational server installation and is the location from which all virtual MDM-related tools and utilities are run.

During deployment to the `WAS_PROFILE_HOME`, relevant binary files and a copy of the configuration are created in a runtime `MAD_ROOTDIR`. In a sense, this location becomes your instance directory. The path to this runtime configuration is noted in the WebSphere Application Server JVM custom properties file as the `mad.root.dir` property.

The configuration in `MDM_INSTALL_HOME` is primarily there to support the command-line tools. The configuration in `WAS_PROFILE_HOME` is used by the operational server during run time. Editing the deployed files in `WAS_PROFILE_HOME` affects changes on the running operational server.

Important: Users of IBM Initiate Master Data Service must also understand that the concept of a single installation directory supporting multiple instances is no longer valid. You must have a separate installation for every instance of InfoSphere MDM that you require. For example, if you need instances for production, testing, and training, then you must have three separate installation directories and three separate deployments of the MDM operational server and database in your `WAS_HOME_PROFILE`.

In the Message Broker component topics, both `MAD_ROOTDIR` and `MAD_HOMEDIR` terms and variables are still used.

Chapter 3. Installing the product

There are two main paths to install InfoSphere MDM: custom or stand-alone with IBM DB2. The instructions for each deployment style are the same for all InfoSphere MDM editions.

Before you begin

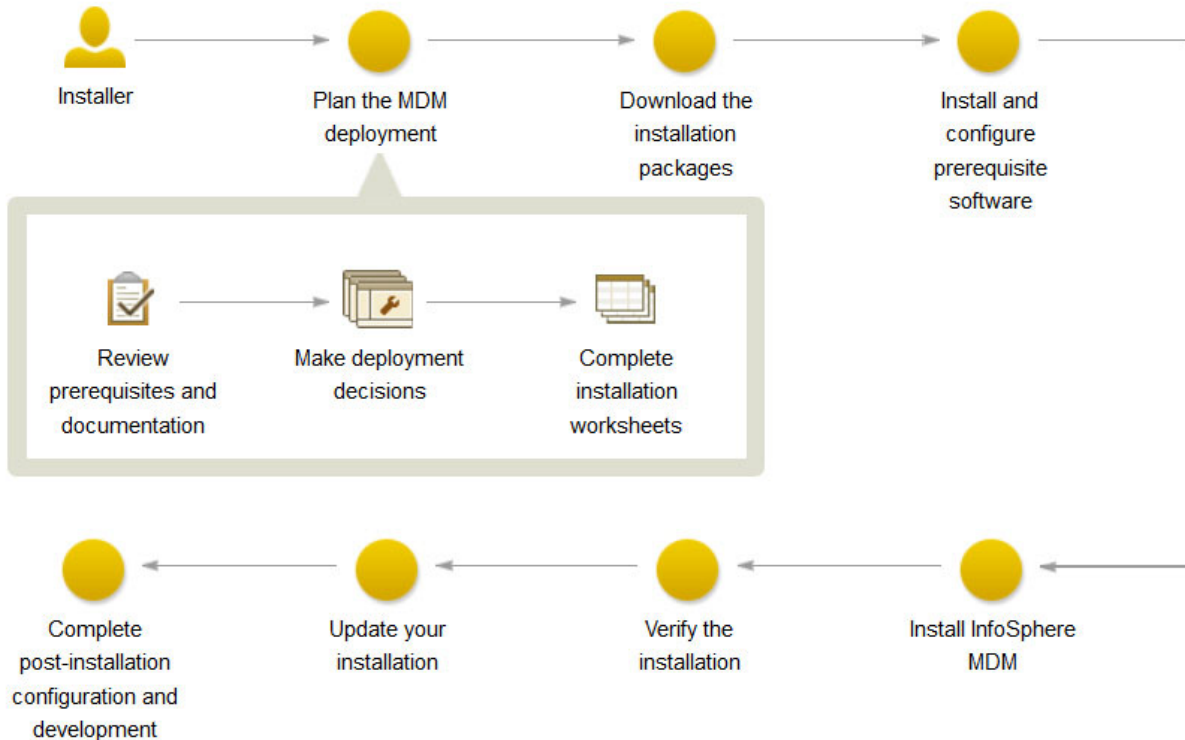

Figure 2. InfoSphere MDM Installation Overview

Important: Before you begin the process of installing InfoSphere MDM, review the known problems. Some of the known installation problems require you to complete specific preinstallation configuration tasks. Failure to complete these configuration tasks can result in a failed installation.

Make sure that you meet these prerequisites:

- You have reviewed the known problems for InfoSphere MDM.
- Your environment meets the hardware and software requirements for components you plan to install.
- You have completed the installation worksheets.
- You have access to the InfoSphere MDM offering.
- You have completed the preparation steps.

About this task

The decision to deploy using either the custom deployment style or one of the stand-alone with DB2 deployment styles depends largely on the goals of your installation:

- Use the custom deployment style if you wish to deploy into an environment that uses a database other than DB2, uses a pre-installed database, or uses a clustered environment.
- Use the stand-alone server with DB2 deployment style if you wish to install InfoSphere MDM deployed on IBM WebSphere Application Server and DB2 using all of the default installation values.
- Use the stand-alone workstation with DB2 deployment style if you wish to install a new InfoSphere MDM development environment on a Microsoft Windows workstation.

Regardless of your environment and deployment style, you can perform any InfoSphere MDM installation in either graphical or silent mode.

Procedure

If you plan to install using the custom deployment style:

1. Add the necessary repositories to IBM Installation Manager.
2. Install your application and components.

If you plan to install using a stand-alone with DB2 deployment style:

3. Determine whether you are installing a stand-alone server or stand-alone workstation.
4. Use the procedure specific to your deployment type.

What to do next

A success message on the final installer panel indicates that the verification tests were automatically run as part of the installation process. You can also view the log files to verify a successful installation. If the installation is not successful, view the log files and use the information in the troubleshooting topics to assist you.

After installation, if you want to add or remove a feature (for example, add an application or another language translation), or modify any of your configuration settings, you can run IBM Installation Manager again and select **Modify**.

Related concepts:

“Stand-alone or custom installation deployment types” on page 21

“Verifying the base installation” on page 159

Related tasks:

“Preparing for a custom deployment” on page 71

Viewing the InfoSphere MDM installation logs

Troubleshooting an installation

Planning an installation

Before you begin installing, you must make important decisions about your InfoSphere MDM deployment style. There are also several installation and configuration worksheets that can help you to plan and gather critical installation information.

Stand-alone or custom installation deployment types

Installation of IBM InfoSphere Master Data Management can be accomplished by using either a stand-alone installation with DB2 or a custom installation.

The InfoSphere MDM editions bundle the master data capabilities and are installed by using IBM Installation Manager. Additional software, such as IBM WebSphere Application Server, IBM DB2 (if you are using a DB2 database), and IBM Rational Application Developer (if you are using InfoSphere MDM Workbench) are also installed by IBM Installation Manager.

The type of installation you choose depends on a number of considerations:

- Whether you are installing on a clean server or workstation
- Whether you have an existing database and application server installed
- The number of servers or workstations on which you want to deploy the components
- What messaging servers you install
- The degree of automation you want to employ in the installation process

Related tasks:

Chapter 3, “Installing the product,” on page 19

Stand-alone installation deployment types

A stand-alone installation installs InfoSphere MDM, IBM WebSphere Application Server, and IBM DB2 in a single run of IBM Installation Manager.

Stand-alone workstation installations additionally include InfoSphere MDM Workbench and IBM Rational Application Developer.

The stand-alone installation deployment type offers the quickest time between completing the installation and running your first transaction.

Stand-alone installations for servers or workstations are supported for InfoSphere MDM Standard, Advanced, and Enterprise Editions.

Important: Stand-alone installation deployments must be performed on a clean server or a clean workstation. Your server or workstation machine must not have any preexisting InfoSphere MDM components, IBM WebSphere Application Server, or IBM DB2 already installed. This means that you cannot run both the workstation and server stand-alone installations on the same machine, as they will each try to install similar pieces, causing a conflict.

Use a stand-alone installation for server or workstation when you:

- Must be up and running in a short amount of time.
- Plan to use a new IBM DB2 for Linux, UNIX, and Windows database.
- Are installing IBM WebSphere Application Server for the first time.
- Are installing on Microsoft Windows (workstation only), IBM AIX® (server only), Linux (server only), or Solaris (server only) operating systems.

Stand-alone installations install all InfoSphere MDM operational server and database capabilities on a single target computer and can be run in graphical or silent mode.

Stand-alone installations are started using LaunchPad. When LaunchPad opens, you can select to use a stand-alone server installation or a stand-alone workstation installation. That selection then does one of two actions:

- Installs IBM Installation Manager if it is not already installed.
- Starts IBM Installation Manager if it is installed. If you do not have the current version of IBM Installation Manager, an update automatically begins.

After the installation is complete, you can opt to return and install any additional components using the *Modify installation* option.

Related reference:

“Features installed by IBM Installation Manager” on page 8

Stand-alone server installation with DB2:

A stand-alone server installation implies that you are selecting to install an InfoSphere MDM edition, IBM WebSphere Application Server, and IBM DB2 for Linux, UNIX, and Windows on a server.

This illustration shows a stand-alone server installation with DB2.

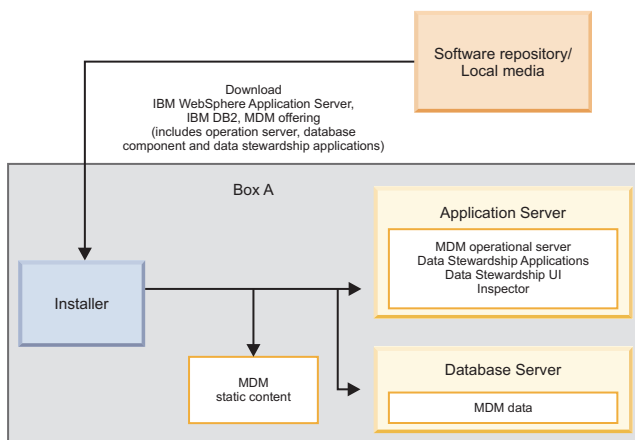

Figure 3. Stand-alone server installation with DB2

For a stand-alone server installation with DB2, IBM Installation Manager completes the following process.

1. Installs IBM WebSphere Application Server (network deployment) with default messaging and IBM DB2 for Linux, UNIX, and Windows.
2. Installs the InfoSphere MDM operational server, database component, and the two data stewardship applications (InfoSphere MDM Data Steward UI and InfoSphere MDM Inspector). The MDM static content is content that the installer extracts into the installation directory (*MDM_INSTALL_HOME*). Static content can include client applications like Batch Processor, Management Agent, Management Console, MDM Collector, MDM configuration scripts (**madconfig** utility scripts), and other applications using default settings.
3. Automatically creates your IBM WebSphere Application Server profile and configures your database, application server, and data stewardship applications.
4. The installation process finally deploys the MDM components to the application server.

You can install more components by using the modify option after the stand-alone server installation with DB2 is complete.

Related tasks:

“Installing a stand-alone server with DB2” on page 58

Related reference:

“Features installed by IBM Installation Manager” on page 8

Stand-alone workstation installation with DB2:

A stand-alone workstation installation with DB2 implies that you are selecting to install an InfoSphere MDM edition, IBM WebSphere Application Server, IBM DB2 for Linux, UNIX, and Windows, IBM Rational Application Developer, and InfoSphere MDM Workbench on a Microsoft Windows or Linux workstation.

This illustration shows a stand-alone workstation installation with DB2. Like the server scenario, you download IBM WebSphere Application Server (base deployment), IBM DB2, your InfoSphere MDM edition, and InfoSphere MDM Workbench.

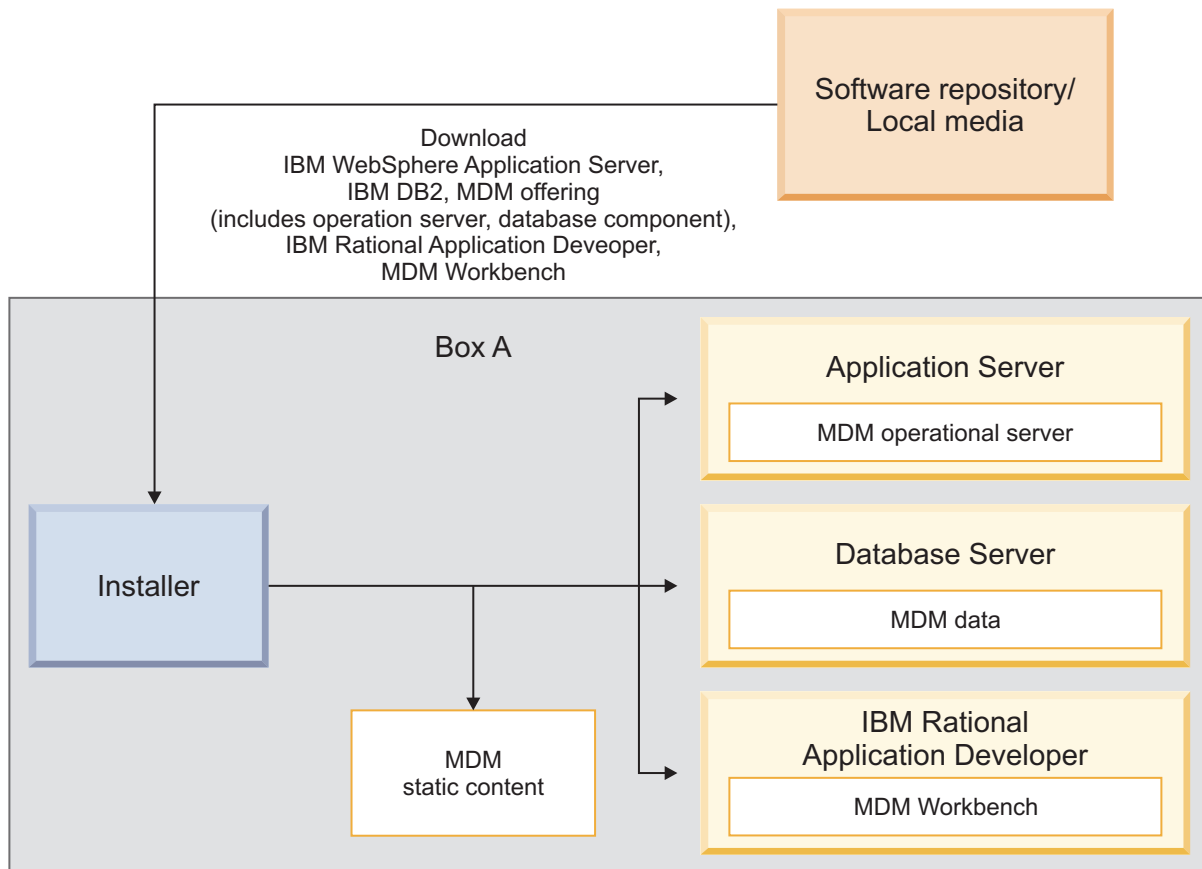

Figure 4. Stand-alone workstation installation with DB2

For a stand-alone workstation installation with DB2, IBM Installation Manager completes the following actions:

1. Installs IBM WebSphere Application Server (base deployment) with default messaging, IBM DB2 for Linux, UNIX, and Windows, and IBM Rational Application Developer.

2. Installs InfoSphere MDM Workbench in IBM Rational Application Developer.
3. Installs the MDM operational server and database components. The MDM static content is content that the installer extracts into the installation directory (*MDM_INSTALL_HOME*). Static content can include client applications like Batch Processor, Management Agent, Management Console, MDM Collector, MDM configuration scripts (**madconfig** utility scripts) and other applications.
4. Automatically creates your IBM WebSphere Application Server profile and configures your database, application server, and data stewardship applications using default settings.
5. Deploys the InfoSphere MDM components to the application server.

Related tasks:

“Installing a stand-alone workstation installation with DB2” on page 65

Related reference:

“Features installed by IBM Installation Manager” on page 8

Custom installation deployment type

Custom installations deploy InfoSphere MDM to almost any possible deployment scenario. Most InfoSphere MDM deployments require the custom installation deployment type.

A custom installation is used to deploy InfoSphere MDM under any of the following conditions:

- Your deployment uses an IBM DB2 for z/OS, Microsoft SQL Server, or Oracle database.
- You plan to use a database that is already installed and configured.
- You are installing in a clustered environment.
- You are installing on a server or workstation that has IBM WebSphere Application Server installed and Deployment Manager (DMgr) is running.
- You are installing on a configured IBM WebSphere Application Server cluster and all node agents are running.
- WebSphere MQ is installed and the listener is running.
- You are installing only one InfoSphere MDM offering (such as Standard Edition, Advanced Edition, or Enterprise Edition).

When you perform a custom installation, you can select multiple target servers for the InfoSphere MDM application and the user interface applications, or you can install everything on a single target server. A custom installation can be run in graphical or silent mode.

This illustration shows a custom deployment in a clustered environment.

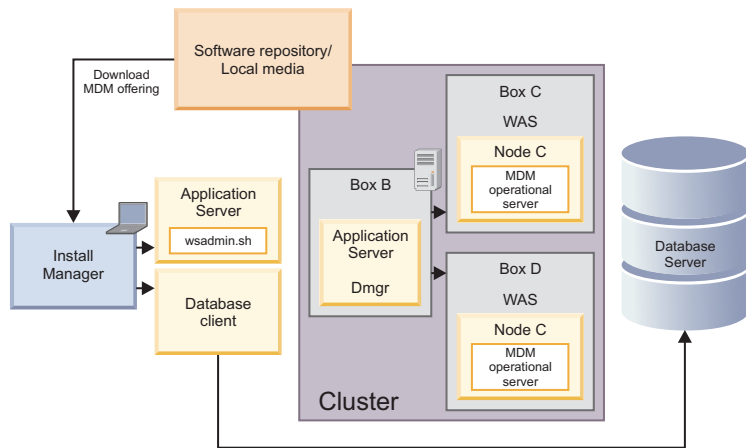

Figure 5. Custom installation in a clustered environment

After the InfoSphere MDM installation is complete, you can opt to return and install any additional component by using the modify installation option.

Related concepts:

“Support for high availability environments” on page 26

Related tasks:

“Preparing for a custom deployment” on page 71

“Installing a custom deployment of InfoSphere MDM” on page 113

Graphical or silent installation

You can install InfoSphere MDM in graphical mode or silent mode. Consider which installation method works best for your environment.

Graphical mode

If the computer on which you are running IBM Installation Manager can render a graphical user interface, then graphical mode is the preferred option. IBM Installation Manager displays a series of screens that walk you through the selection of features, basic parameter configuration, and provides a summary of the options that you selected before the installation began.

Silent mode

If you are planning identical installations on multiple computers, you might consider the silent option. A silent installation is started from the command line and uses a response file. This option does not require you to specify the installation options. Instead, the installation options are read from a response file. You can create a response file manually or by using the graphical installation wizard. A response file can be created without installing any software or during an installation. The steps that are taken in the installation process and errors that are encountered are logged to a file.

Related reference:

“Silent installation” on page 132

Support for high availability environments

To support installation of InfoSphere MDM in high availability environments, you can configure multiple instances on multiple host servers. By doing so, if one server or instance goes down, the others can continue to process traffic.

Tip: To deploy InfoSphere MDM to a high availability environment, you must deploy using the custom installation path.

The MDM operational server uses an IBM WebSphere Application Server container and can be deployed on single server or on a cluster as configured in the container. The cluster can be pre-configured on the server. The installer can detect a clustered environment and deploy to that environment by using a custom installation.

Review the installation scenarios before you begin the installation to better understand how to support high availability and clustered environment requirements.

Related concepts:

“Installation scenarios” on page 43

“Custom installation deployment type” on page 24

Related tasks:

“Installing a custom deployment” on page 70

Worksheets for installation and configuration

The installation worksheets list all of the values that you must specify during an InfoSphere MDM installation process. Completing the installation worksheets before you install the components can help you plan your installation, save time, and enforce consistency during the installation and configuration process.

If you are performing a stand-alone installation with DB2, the installation application uses several default configurations. This limits the amount of input that you are required to provide.

Reuse the worksheets for each runtime environment that you plan to implement. For example, you might have a production environment, a test environment, and a training environment.

Use the worksheets for gathering key details about applications and components, including their base configuration settings that are defined within IBM Installation Manager. Any operational server, user application, or component configuration steps that are required outside of IBM Installation Manager are described in separate individual application or component topics.

Related tasks:

“Installing a stand-alone server with DB2” on page 58

“Installing a stand-alone workstation installation with DB2” on page 65

“Installing a custom deployment of InfoSphere MDM” on page 113

“Installing InfoSphere MDM into a clustered environment” on page 124

Installation directory worksheet

Use this worksheet to record the root directory of the host on which you want to install InfoSphere MDM.

If you install more runtime environments later, they might not point to the same database as the one used for the initial environment. If you are installing multiple runtime environments, reuse the installation worksheet to define the unique directory values for each environment.

If you are installing on Microsoft Windows:

- You must be running in Administrator mode for IBM Installation Manager to write to the Windows registry. Administrator mode is not used for IBM AIX, Linux, or Solaris.
- On a Microsoft Windows 7 operating system, you must install MDM into a directory that is not virtualized.

The parameters that are listed in the following table equate to prompts or fields that you see in IBM Installation Manager.

Table 6. InfoSphere MDM installation directory worksheet

Parameter	Description	Your value
Use the existing package group	<p>Choose this option if you want the InfoSphere MDM components to be installed into an existing Eclipse shell or directory. You cannot modify the directory name if you choose this option.</p> <p>Do not choose this option if you previously installed other products by using IBM Installation Manager, such as IBM Rational Application Developer.</p> <p>InfoSphere MDM Workbench must be installed into the same package group as IBM Rational Application Developer.</p>	
Create a new package group	<p>This option is the default setting. IBM Installation Manager creates a default IBM/MDM directory under the root directory that you choose. Or, you can name the directory as you want.</p> <p>For example <code>MDM_INSTALL_HOME/IBM/MDM_test</code> or <code>MDM_INSTALL_HOME/IBM/MDM_prod</code></p>	

DB2 or DB2 for z/OS data source worksheet

Use this data source worksheet to identify parameters for the IBM DB2 for Linux, UNIX, and Windows or IBM DB2 for z/OS data source to which your MDM operational server is connecting.

For virtual MDM, all IBM AIX®, Linux, or Solaris data source information is stored in an `odbc.ini` file in the `MDM_INSTALL_HOME/conf` directory. The physical MDM does not require data source information to be stored.

When you define the names for your databases and user accounts, consider giving the associated database instance, user account, and data source configuration the same name. You might also want to include the InfoSphere MDM version in your name. Using this naming convention can help other members of your organization and IBM Software Support understand the mapping between instances, accounts, and databases.

The parameters that are listed in the following table equate to prompts or fields that you see in IBM Installation Manager.

Table 7. IBM DB2 or DB2 for z/OS data source worksheet

Parameter	Description	Your value
Database type	Both DB2 for Linux, UNIX, and Windows and DB2 for z/OS are supported for all InfoSphere MDM editions.	
Database host name	Identify the fully qualified address of the host on which the database is installed. The default is localhost.	
Database port	Identify the database port or use the default port number provided. The DB2 default is 50000.	
Database user name	<p>The database user name must have DBA privileges.</p> <p>Restrictions on length and supported characters for user names and passwords are dependent upon any restrictions that might be imposed by your operating system.</p> <p>If you install InfoSphere MDM using a stand-alone installation, the DB2 database user name and password defaults to <code>mdminst11</code> on Linux and UNIX and to <code>db2admin</code> on Microsoft Windows.</p>	
Database password	Provide a password for the database user name.	
Database name	<p>Provide a name that identifies the InfoSphere MDM database. The default is <code>MDMDB</code>.</p> <p>The name must consist of 12 or fewer alphanumeric characters. Underscore (<code>_</code>) characters can be used in the name. Other characters are not supported.</p>	

Table 7. IBM DB2 or DB2 for z/OS data source worksheet (continued)

Parameter	Description	Your value
Database home	<p>For custom installations, provide the fully qualified directory where the database is installed. Provide the parent directory of SQLLIB. For example:</p> <p>Windows: C:\Program Files\IBM\SQLLIB</p> <p>IBM AIX, Linux, or Solaris: /home/db2inst1/sqllib</p>	
Database schema	<p>Specify the database schema name. By default the schema name is the same as the database application user.</p>	
Installing MDM Database manually	<p>If you are planning to install the physical MDM database manually, you can select the Extract scripts for manual database installation option. The installation application will extract the scripts that enable you to complete manual installation.</p> <p>Virtual MDM tables are installed even if this option is selected.</p> <p>This parameter is only available when the MDM database is being installed alone, without any other components.</p>	
Tablespace names	<p>If you have created your tablespaces ahead of time, then you must take note of their names so that you can specify them in the installation application. The following tablespaces are required (default names are in parentheses):</p> <ul style="list-style-type: none"> • 4K tablespace (TBS4K) • 8K tablespace (TBS8K) • 16K tablespace (TBS16K) • IndexSpace (INDEXSPACE) • EME tablespace (EMESPACE1) • PME tablespace (EMESPACE2) • LongSpace (LONGSPACE) 	

Related tasks:

“Installing and setting up the database” on page 81

“Preparing a DB2 database” on page 82

Microsoft SQL Server data source worksheet

Use the Microsoft SQL Server data source worksheet to identify parameters for the data source to which your MDM operational server is connecting.

For InfoSphere MDM Standard Edition, all IBM AIX®, Linux, or Solaris data source information is stored in an `odbc.ini` file in the `MDM_INSTALL_HOME/conf` directory.

When you define the names for your databases and user accounts, consider giving the associated database instance, user account, and data source configuration the same name. You might also want to include the InfoSphere MDM version in your name. Using this naming convention can help other members of your organization and IBM Software Support understand the mapping between instances, accounts, and databases.

Attention: The Business Administration, Data Stewardship, and Product Management user applications are not supported for use with a Microsoft SQL Server database.

The parameters that are listed in the following table equate to prompts or fields that you see in IBM Installation Manager.

Table 8. Microsoft SQL Server data source worksheet

Parameter	Description	Your value
Database type	Microsoft SQL Server is supported for InfoSphere MDM Standard Edition only. The type must be MSSQLU.	
Database host name	Identify the fully qualified address of the host on which the database is installed. The default is localhost.	
Database port	Identify the database port or use the default port number provided. The Microsoft SQL Server default is 1433.	
Database user name	The database user name must have DBA privileges. Restrictions on length and supported characters for user names and passwords are dependent upon any restrictions that might be imposed by your operating system.	
Database password	Provide a password for the database user name.	
Database name	Provide a name that identifies the MDM database. The default is MDMDB.	

Table 8. Microsoft SQL Server data source worksheet (continued)

Parameter	Description	Your value
Database server name	Specify the name of the database server to which the MDM database instance connects.	
Database file group	Specify the name of a file group for the database. A file group is a logical structure to group objects (collections of files) in a database. In Microsoft SQL Server, file groups are used to help with data placement and administrative tasks such as backup and restore operations.	
Use Windows Native Authentication	Choose whether you want the operational server to authenticate to the database by using Microsoft Windows credentials. The default is to use SQL Server credentials. If you plan to use Windows authentication, your DBA must set the default schema of the login user to the schema that will be used by IBM Installation Manager.	
Installing MDM Database manually	If you are planning to install the physical MDM database manually, select this option to extract the scripts that are used for manual installation. Virtual MDM tables are installed even if this option is selected.	

Related tasks:

“Installing and setting up the database” on page 81

“Preparing a Microsoft SQL Server database” on page 85

Oracle data source worksheet

Use the Oracle data source worksheet to identify parameters for the data source to which your MDM operational server is connecting.

For InfoSphere MDM Standard Edition, all IBM AIX, Linux, or Solaris data source information is stored in an `odbc.ini` file in the `MDM_INSTALL_HOME/conf` directory.

When you define the names for your databases and user accounts, consider giving the associated database instance, user account, and data source configuration the same name. You might also want to include the InfoSphere MDM version in your name. Using this naming convention can help other members of your organization and IBM Software Support understand the mapping between instances, accounts, and databases.

The parameters that are listed in the following table equate to prompts or fields that you see in IBM Installation Manager.

Table 9. Oracle data source worksheet

Parameter	Description	Your value
Database type	Oracle is supported for all InfoSphere MDM editions.	
Database host name	Identify the fully qualified address of the host on which the database is installed. The default is localhost.	
Database port	Identify the database port or use the default port number provided. The Oracle default is 1521.	
Database user name	<p>The database user name must have DBA privileges. For Oracle, the DB user name and schema name must be the same.</p> <p>Restrictions on length and supported characters for user names and passwords are dependent upon any restrictions that might be imposed by your operating system.</p>	
Database password	Provide a password for the database user name.	
Database name	Provide the database name.	
Database home	<p>Provide the fully qualified directory where the database is installed. For example:</p> <p>Windows: C:\App\oracle\product\ 11.2.0\db_1</p> <p>IBM AIX, Linux, or Solaris: /home/mdm/oracle/product/ 11.2.0/db_1</p>	

Table 9. Oracle data source worksheet (continued)

Parameter	Description	Your value
Installing MDM Database manually	<p>If you are planning to install the physical MDM database manually, you can select the Extract scripts for manual database installation option. The installation application will extract the scripts that enable you to complete manual installation.</p> <p>Virtual MDM tables are installed even if this option is selected.</p> <p>This option is only available when the MDM database is being installed alone, without any other components.</p>	
Tablespace names	<p>If you have created your tablespaces ahead of time, then you must take note of their names so that you can specify them in the installation application. The following tablespaces are required (default names are in parentheses):</p> <ul style="list-style-type: none"> • 4K tablespace (<i>TBS4K</i>) • 8K tablespace (<i>TBS8K</i>) • 16K tablespace (<i>TBS16K</i>) • IndexSpace (<i>INDEXSPACE</i>) • EME tablespace (<i>EMESPACE1</i>) • PME tablespace (<i>EMESPACE2</i>) • LongSpace (<i>LONGSPACE</i>) 	

Related tasks:

“Installing and setting up the database” on page 81

“Preparing an Oracle database” on page 87

WebSphere Application Server installation worksheet

Use the IBM WebSphere Application Server configuration worksheet to identify parameters for the application server that is used to host your MDM operational server.

The parameters that are listed in the following table equate to prompts or fields that you see in IBM Installation Manager.

Table 10. IBM WebSphere Application Server installation worksheet

Parameter	Description	Your value
Deployment type	<p>Specify the deployment type and note the IBM WebSphere Application Server profile name. Your options are Network Deployment Edition or Base Edition (unmanaged).</p> <p>Network Deployment is used for server or cluster installations. A base deployment is typically used in workstation or demonstration installations.</p> <p>If you choose Network Deployment, the installer runs a sequence of commands against the IBM WebSphere Application Server deployment manager process to configure application servers and deploy applications. The deployment manager and node agents must be configured and running before the deployment can proceed. For example, use a profile name of Dmgr01.</p> <p>If you select Network Deployment, the installer can also run against an IBM WebSphere Application Server cluster. The installation program automatically detects the cluster. If the cluster is configured, the default is to deploy the applications on a cluster. You can select to deploy the applications on a single server instead.</p> <p>If you choose Base, then the operational server is deployed on server1 of the IBM WebSphere Application Server Base. The installer runs a sequence of commands against server1 to configure the application server and deploy applications. Make sure that server1 is running before you proceed with the deployment. For example, use a profile name of AppSrv1.</p>	
IBM WebSphere Application Server home	<p>Specify the fully qualified directory in which IBM WebSphere Application Server is installed. The default on Linux and UNIX is /opt/IBM/WebSphere/AppServer. The default on Microsoft Windows is C:\Program Files (x86)\IBM\WebSphere\AppServer.</p>	

Table 10. IBM WebSphere Application Server installation worksheet (continued)

Parameter	Description	Your value
IBM WebSphere Application Server profile home	If you are using a base deployment, specify the fully qualified path of the application server profile home directory. The default on Linux and UNIX is /opt/IBM/WebSphere/AppServer/profiles. The default on Microsoft Windows is C:\Program Files (x86)\IBM\WebSphere\AppServer\profiles.	
Federate into an existing Deployment Manager	If you want to federate a newly created managed node into an existing deployment manager, select the Federate into an existing Deployment Manager option.	
Deployment Manager profile name	Provide the deployment manager profile name. Ensure that the name is not already in use. This is only applicable if the deployment type is Network Deployment and the Federate into an existing Deployment Manager option is selected.	
Deployment Manager profile home	Specify the fully qualified path of the deployment manager profile home directory.	
Host name	Identify the fully qualified address of the host on which IBM WebSphere Application Server is installed. The default is localhost.	
SOAP port	Identify the SOAP port of the deployment manager on the remote computer, if you are using remote deployment. The default is 8879.	
User name	Identify the IBM WebSphere Application Server user name. The user must have administrative privileges.	
Password	The IBM WebSphere Application Server user password.	
Cell	Specify the IBM WebSphere Application Server cell where you want to deploy InfoSphere MDM. If you have IBM WebSphere Application Server already installed and configured, you can click Retrieve Host Details during the installation process and have IBM Installation Manager retrieve the information for Cell, Node, and Server.	

Table 10. IBM WebSphere Application Server installation worksheet (continued)

Parameter	Description	Your value
Node	Specify the IBM WebSphere Application Server cell where you want to deploy InfoSphere MDM. After you select the cell in IBM Installation Manager, all of the nodes within that cell are available in the list.	
Server	Specify the server where you want to deploy InfoSphere MDM. After you select the node in IBM Installation Manager, all of the servers that are available for that node show in the list. If you want to create a new server for deployment, you can specify the new name on the configuration panel and it is created in IBM WebSphere Application Server during the installation process.	
Managed node profile name	Provide the managed node profile name. Ensure that the name is not already in use. This is only applicable if the deployment type is Network Deployment.	
Managed node profile home	Specify the fully qualified path of the managed node profile home directory.	
Install MDM application on cluster	If you have an existing WebSphere Application Server cluster, this option is available on the configuration panel. Select this option if you want to install the InfoSphere MDM application in a clustered environment.	
Cluster	If you are installing in a clustered environment, select the cluster where you want to deploy your applications.	

Related concepts:

“Installing and setting up the application server” on page 75

InfoSphere MDM application configuration worksheet

Use the application configuration worksheet to identify parameters for the MDM operational server.

The parameters that are listed in the following table equate to prompts or fields that you see in IBM Installation Manager on the Application Configuration panel.

Table 11. MDM application installation worksheet

Parameter	Description	Your value
MDM application name	Specify the name of the MDM operational server. This name is used in IBM WebSphere Application Server. The default is E001.	
MDM user name	Specify the user name that this instance of InfoSphere MDM will use to log into the MDM client applications and user interfaces. Note: This user is not the WebSphere Application Server admin user who administers the InfoSphere MDM instance, and does not need to match that user name.	
MDM user password	Specify the password for the MDM user.	
RMI port	Specify the port on which the Remote Method Invocation (RMI) registry service listens for connections from other services. In a clustered environment, all nodes must use the same RMI port to communicate. The default is 9999. Note: The MDM operational server uses RMI to receive and send transaction requests and responses.	
Matching style	Specify whether you want to use a probabilistic or deterministic matching style.	
Enable multiple time zone deployment	Select this option if your application is running across different time zones, or your data has time-sensitive values under different time zones.	
Default time zone	Select the client default time zone from the list. If a time zone is not specified, the application server time zone is used.	

Table 11. MDM application installation worksheet (continued)

Parameter	Description	Your value
Messaging	<p>Specify the messaging type for your implementation.</p> <p>If you want to use the internal WebSphere messaging, select IBM WebSphere Default Messaging.</p> <p>Most virtual MDM configurations will select IBM WebSphere Default Messaging and install the Message Brokers feature.</p> <p>IBM WebSphere MQ is a separate enterprise product and must be installed before you install InfoSphere MDM. If you opt for IBM WebSphere MQ, specify values for the following parameters.</p>	
Message queue home	Specify the fully qualified directory of the messaging queue home. The default on Linux and UNIX is /usr/mqm. The default on Microsoft Windows is C:\Program Files (x86)\IBM\WebSphere\MQ.	
Queue manager name	Specify the name for the queue manager. For example, CUSTOMER.QUEUE.MANAGER.	
MQ host name	Specify the name of the server that is hosting WebSphere MQ.	
MQ port	Specify the WebSphere MQ listening port number.	
Channel name	Specify the channel name. Channels are used to transmit messages between queue managers.	
User name	Specify the WebSphere MQ user name.	
Password	Specify the password.	
Configure Messaging Server	Select this option to deploy your parameters and configure your messaging server.	

Related information:

 Multi-time-zone support

☞ Probabilistic vs. deterministic matching styles

User applications installation worksheet

Use this worksheet to record parameters for the user applications that you are planning to install.

Reuse this worksheet for each user application or note any differences between applications in the worksheet.

The parameters that are listed in the following table equate to prompts or fields that you see in IBM Installation Manager.

Table 12. User application installation worksheet

Parameter	Description	Your value
Deployment type	Specify whether your IBM WebSphere Application Server deployment is Base or Network. Network deployment is used for server or cluster installations. A base deployment is typically used in workstation or demonstration installations.	
IBM WebSphere Application Server profile home	If you are using a base deployment, specify the fully qualified path of the application server profile home directory. The default is /opt/IBM/WebSphere/AppServer/profiles	
Host name	Specify the name of the IBM WebSphere Application Server where the MDM operational server is deployed.	
SOAP port	Specify the port number for the MDM operational server or use the default of 8879.	
User name	Specify the administrative user name for this application.	
Password	Specify the administrative user password.	
Cell	Specify the IBM WebSphere Application Server cell where you want to deploy the application. If you have IBM WebSphere Application Server already installed and configured, click Retrieve Host Details during the installation process to retrieve the information for Cell, Node, and Server.	

Table 12. User application installation worksheet (continued)

Parameter	Description	Your value
Node	Specify the IBM WebSphere Application Server node where you want to deploy the application.	
Server	Specify the IBM WebSphere Application Server server or servers where you want to deploy the application.	
Install MDM application on cluster	If you have an existing WebSphere Application Server cluster, this option is available on the configuration panel. Select this option if you want to install InfoSphere MDM application in a clustered environment.	
Cluster	If you are installing in a clustered environment, select the cluster where you want to deploy your applications.	

Related tasks:

“Installing the Business Administration UI” on page 150

“Installing Data Stewardship UI” on page 151

“Installing the Product Maintenance UI” on page 153

Related information:

 Installing Inspector

 Installing Enterprise Viewer

 Installing Web Reports

 Installing Provider Direct

User applications and operational server associations:

Certain user applications are designed to support either a virtual or physical MDM configuration.

The following table associates user applications with the InfoSphere MDM configuration that they support.

Table 13. InfoSphere MDM user applications

Virtual MDM applications	Physical MDM Applications
InfoSphere MDM Inspector	InfoSphere MDM Business Administration
InfoSphere MDM Enterprise Viewer	InfoSphere MDM Data Stewardship
InfoSphere MDM Web Reports	InfoSphere MDM Product Maintenance
InfoSphere MDM Provider Direct	
InfoSphere MDM Pair Manager	

Note: Not all of the user applications are installed through IBM Installation Manager panels.

Related reference:

“Features installed by IBM Installation Manager” on page 8

“Installation requirements” on page 2

History installation worksheet

Use this worksheet to record parameters for your history trigger configuration.

History triggers are used by physical MDM operational servers.

There are two sets of triggers that generate data for physical MDM database history tables. The first set is for the core and domain tables. The second set is for the configuration management tables. Each set consists of history triggers and delete triggers.

The parameters that are listed in the following table equate to prompts or fields that you see in IBM Installation Manager.

Table 14. History installation worksheet

Parameter	Description	Your value
Industry	<p>Specify the industry type that is supported in this implementation. You can specify only one type.</p> <p>There are four supported industry types. Each option installs the code tables and data for that industry type.</p> <ul style="list-style-type: none"> • Insurance - Choose this option for lines of business such as Life, Health, Annuities, Pensions, Property and Casualty, and others. • Banking - Choose this option for lines of business such as Retail Banking, Commercial Banking, Credit Cards, Loans, and others. • Telecommunication - Choose this option for lines of business such as Wireless, Cable Television, Satellite Television, Internet, Telephone Services, and others. • Manufacturing - Choose this option for lines of business such as Precision Tools, Aerospace, Electrical, Heating, Mechanical, and others. 	

Table 14. History installation worksheet (continued)

Parameter	Description	Your value
History triggers	<p>There are three history trigger options. You can specify only one.</p> <ul style="list-style-type: none"> • None. Choose this option if you do not want to install any triggers. Choosing this option prevents history from being stored in the database. • Simple. Choose this option to install only the update triggers. When a record is updated in the database, a copy of that record (before the update) is added to the history table. Past versions of the record are stored in the history table. • Compound. Choose this option if you want to install both insert and update triggers. When a record is added to the database, or when a record is updated in the database, a copy of the record is added to the history table. Copies of both the current and past versions of the record are stored in the history table. 	
Case sensitive searches	<p>By default, name searches for contracts, products, and categories are not case-sensitive. Check the Enable case-sensitive searches check box only if you want to place case-sensitive restrictions on your searches.</p> <p>Once this feature is activated, database objects are created and you cannot deactivate the option.</p>	
Code table languages	<p>Translated code table values used for predefined lists and error messages are included with the physical MDM operational server.</p> <p>English is the default language.</p>	

Table 14. History installation worksheet (continued)

Parameter	Description	Your value
Application resource language	Specify the corresponding language translations for the user interface to install.	

Related information:

 Non-case-sensitive search

Installation scenarios

There are some common installation scenarios, which you can use as guidelines when installing InfoSphere MDM in similar environments. The scenarios are not meant to address every possible configuration or environment, but show the basic steps involved in a custom installation involving multiple products and machines.

Before you install, ensure that the system or systems that you choose meet the necessary operating system, hardware, software, communications, disk, and memory requirements.

These scenarios assume that you have completed the following tasks:

- “Acquiring and extracting the installation files” on page 56
- “Prepare IBM Installation Manager” on page 72
- “Installing the Installation Startup Kit” on page 73

Before you begin any installation, ensure that these conditions are met:

- Ensure any Dmgr node agents are deployed and running.
- Ensure any AppSrv node agents are deployed and running. For some installation scenarios, the WebSphere Application Server AppSrv profile is called server1.
- Ensure the *JAVA_HOME* and *PATH* environment variables are set correctly on each machine.
- For WebSphere Application ServerNetwork Deployment, ensure the *DB2_JDBC_DRIVER_PATH* application server variables are targeted to the respective nodes containing the DB2 JDBC drivers for the machines. This is not applicable if you are using WebSphere Application Server base.
- Know your machine host names and SOAP port numbers for Dmgr processing.
- Know your host name and bootstrap port number of the application server, where the InfoSphere MDM application was previously installed as a result of running the IBM Installation Manager.

Related concepts:

“Support for high availability environments” on page 26

Related tasks:

“Installing InfoSphere MDM into a clustered environment” on page 124

“Preparing for a custom deployment” on page 71

Scenario: Installing InfoSphere MDM on a WebSphere Application Server cluster, using an IBM DB2 database and IBM WebSphere MQ messaging

Use this scenario as a reference when planning and installing InfoSphere MDM on a WebSphere Application Server cluster with a DB2 database and IBM WebSphere MQ messaging. This scenario is applicable for DB2 on Microsoft Windows, Linux, or UNIX operating systems.

This scenario is accomplished through four procedures.

1. Prepare your application server.
2. Prepare your DB2 database.
3. Prepare IBM WebSphere MQ messaging.
4. Install InfoSphere MDM.

In this scenario, the topology is:

- Machine A:
 - WebSphere Application Server Deployment Manager
 - DB2 client software
 - IBM Installation Manager and InfoSphere MDM
- Machines B, C, and D:
 - WebSphere Application Server managed nodes
 - DB2 client software
- Machine E:
 - DB2 database
- Machine F:
 - IBM WebSphere MQ

Preparing the IBM DB2 database:

Use this procedure to install and prepare your DB2 database as a second step in completing this scenario.

About this task

The resulting topology from this procedure is that machine E hosts the DB2 software and database, and machines A, B, C, and D have the DB2 client software.

Procedure

1. Install DB2 database. Use the IBM DB2 installation documentation as a guide.
 - a. Install DB2 on machine E.
 - b. Install DB2 client software on machines A, B, C, and D.
 - c. Catalog DB2 client on machine A to connect to the DB2 database server on machine E. Repeat this step for machines B, C, and D.
2. Create the database and table spaces by using the scripts that are provided in the Installation Startup Kit.
3. Make sure that DB2 Client `$HOME/sql1lib/bin` is included in the PATH on machine A. This step is required for IBM Installation Manager to implement the `$HOME/sql1lib/bin/db2` utility when running the SQL scripts.

Related tasks:

“Installing and setting up the database” on page 81

“Preparing a DB2 database” on page 82

“Installing the Installation Startup Kit” on page 73

Related reference:

“DB2 or DB2 for z/OS data source worksheet” on page 27

Preparing WebSphere Application Server Network Deployment:

For the first step in completing this installation scenario, install and prepare your application server.

About this task

The resulting topology from this procedure is that machine A has WebSphere Application Server Deployment Manager and machines B, C, and D have WebSphere Application Server managed nodes.

Procedure

1. Install and configure WebSphere Application Server on machines A, B, C, and D. Use the WebSphere Application Server Network Deployment documentation as a guide.
2. Create two WebSphere Application Server clusters. CLUSTER1 for the MDM operational server and CLUSTER2 for the user applications.
3. Create a DB2_JDBC_DRIVER_PATH WebSphere Application Server environment variable for each node in the cluster. The path must point to the JDBC drivers for each machine. For example, if the DB2 client and JDBC drivers are installed at `$USER_HOME/sql11ib/java`, specify the DB2_JDBC_DRIVER_PATH equal to `$USER_HOME`.
4. Make sure that all managed nodes are properly synchronized before you begin installing InfoSphere MDM.
5. Make sure that you know the WebSphere Application Server Deployment Manager host name and SOAP port before you start the InfoSphere MDM installation. Use the WebSphere Application Server configuration worksheet to record your values.
6. Make sure your cluster is started before you begin the InfoSphere MDM installation.

Related concepts:

“Installing and setting up the application server” on page 75

Related tasks:

“Preparing WebSphere Application Server Network Deployment for a managed server deployment” on page 76

“Preparing your DB2 database to use InfoSphere MDM in a clustered environment” on page 84

Related reference:

“WebSphere Application Server installation worksheet” on page 33

Preparing IBM WebSphere MQ:

Use this procedure to install and prepare IBM WebSphere MQ as a third step in completing this scenario.

Procedure

1. Install IBM WebSphere MQ on machine F. Use the IBM WebSphere MQ installation documentation as a guide.
2. Create the WebSphere MQ queue manager, channel, and queues by using the `custSetupMQServer.mqsc` and `ChannelAuth.mqsc` scripts. These scripts are included in the Installation Startup Kit.

Related tasks:

“Installing the Installation Startup Kit” on page 73

Related reference:

“InfoSphere MDM application configuration worksheet” on page 36

“Installation Startup Kit for custom installations” on page 10

Installing InfoSphere MDM:

Use this procedure to install InfoSphere MDM and any selected user applications as the final step in completing this scenario.

About this task

Make sure that your application server and database are started before you begin the InfoSphere MDM installation.

Procedure

1. Start IBM Installation Manager on machine A and choose your InfoSphere MDM offering. Continue through the prompts.
2. Specify the InfoSphere MDM installation home and shared directories. For example, MDM_INSTALL home - /usr/IBM/MDM/E001/mdm and Shared - /usr/IBM/MDM/E001/Shared
3. Choose the **MDM Database**, **MDM Operational Server**, and any user applications or other features you want to install. For example: select the **Applications** feature to install all user applications, or select specific applications.
4. On the Database Configuration panel, specify the database type and database parameters. You can choose whether you want to test the database connection by selecting **Test Connection** or select **No connection test required**.
5. On the WebSphere Application Server Configuration panel, specify the application server parameters. Select **Retrieve Host Details** to obtain your Cell, Node, and Server information. Select **Install MDM application on cluster**. Choose CLUSTER1 from the **Cluster** list.
6. On the **Application Configuration** panel, select **IBM WebSphere MQ** messaging and enter the parameters. Clear the **Configure messaging server** option to prevent IBM Installation Manager from creating a queue manager on machine A (because the queue manager is enabled on machine F).
7. On each individual user application configuration panel, provide the parameters. Select **Install MDM application on cluster**. Choose CLUSTER2 from the **Cluster** list.
8. Click **Verify Installation Requirements** to run the prerequisite checks. Review and correct any errors or warnings, then click **Recheck**.
9. When the verification checks pass successfully, click **Install**.
10. When the installation is complete, view the logs and use the installation verification tools.

Related concepts:

“Prepare IBM Installation Manager” on page 72

“Worksheets for installation and configuration” on page 26

“Verifying the base installation” on page 159

Related tasks:

“Installing a custom deployment of InfoSphere MDM” on page 113

Troubleshooting an installation

Scenario: Installing InfoSphere MDM on a WebSphere Application Server cluster, using an Oracle database and WebSphere Default Messaging

Use this scenario as a reference when planning and processing an InfoSphere MDM installation on a WebSphere Application Server cluster. This scenario uses an Oracle database and WebSphere Default Messaging.

This scenario is accomplished through three procedures.

1. Prepare your application server.
2. Prepare your Oracle database.
3. Install InfoSphere MDM.

In this scenario, the topology is:

- Machine A:
 - WebSphere Application Server Deployment Manager
 - Oracle client software
 - IBM Installation Manager and InfoSphere MDM
- Machines B, C, and D:
 - WebSphere Application Server managed nodes
 - Oracle client software
- Machine E:
 - Oracle database

Preparing the Oracle database:

Use this procedure to install and prepare your Oracle database as a second step in completing this scenario.

About this task

The resulting topology from this procedure is that machine E hosts the Oracle software and database, and machines A,B,C, and D have the Oracle client software.

Procedure

1. Install Oracle database. Use the Oracle installation documentation as a guide.
 - a. Install Oracle on machine E.
 - b. Install the Oracle client software on machines A, B, C, and D.
 - c. Point the TNS name on machine A to connect to the remote Oracle database server on machine E.
2. Create the database and table spaces by using the scripts that are provided in the Installation Startup Kit.

To install MDM with Oracle, your DB user name and schema name must be the same.
3. Make sure Oracle Client sqlplus is included in the PATH on machine A. This step is required for IBM Installation Manager to implement the sqlplus utility when running the SQL scripts.

Related tasks:

“Installing and setting up the database” on page 81

“Preparing an Oracle database” on page 87

“Installing the Installation Startup Kit” on page 73

Related reference:

“Oracle data source worksheet” on page 31

Preparing WebSphere Application Server Network Deployment:

Use this procedure to install and prepare your application server as a first step in completing this scenario.

About this task

The resulting topology from this procedure is that machine A has WebSphere Application Server Deployment Manager, and machines B, C, and D have WebSphere Application Server managed nodes.

Procedure

1. Install and configure WebSphere Application Server on machines A, B, C, and D. Use the WebSphere Application Server Network Deployment documentation as a guide.
2. Create a WebSphere Application Server cluster named CLUSTER1 for the MDM operational server.
3. Create an ORACLE_JDBC_DRIVER_PATH WebSphere Application Server environment variable for each node in the cluster. The path must point to the JDBC drivers for each machine. For example, if the Oracle client and JDBC drivers are installed at `$USER_HOME/jdbc/lib/ojdbc6.jar`, specify the ORACLE_JDBC_DRIVER_PATH equal to `$USER_HOME`.
4. Make sure that all managed nodes are properly synchronized before you begin installing InfoSphere MDM.
5. Make sure that you know the WebSphere Application Server Deployment Manager host name and SOAP port before you start the InfoSphere MDM installation. Use the WebSphere Application Server configuration worksheet to record your values.
6. Make sure your cluster is started before you begin the InfoSphere MDM installation.

Related concepts:

“Installing and setting up the application server” on page 75

Related tasks:

“Preparing WebSphere Application Server Network Deployment for a managed server deployment” on page 76

“Preparing your Oracle database to use InfoSphere MDM in a clustered environment” on page 89

Related reference:

“WebSphere Application Server installation worksheet” on page 33

Installing InfoSphere MDM:

Use this procedure to install InfoSphere MDM and any selected user applications as the final step in completing this scenario.

About this task

Make sure that your application server and database are started before you begin the InfoSphere MDM installation.

Procedure

1. Start IBM Installation Manager on machine A and choose your InfoSphere MDM offering. Continue through the prompts.
2. Specify the InfoSphere MDM installation home and shared directories. For example, MDM_INSTALL Home - /usr/IBM/MDM/E001/mdm and Shared - /usr/IBM/MDM/E001/Shared
3. Choose the **MDM Database**, **MDM Operational Server**, and any user applications or other features you want to install. For example: select the **Applications** feature to install all user applications, or select specific applications.
4. On the Database Configuration panel, specify the database type and database parameters. You can choose whether you want to test the database connection by selecting **Test Connection** or select **No connection test required**.
5. On the WebSphere Application Server Configuration panel, specify the application server parameters. Select **Retrieve Host Details** to obtain your Cell, Node, and Server information. Select **Install MDM application on cluster**. Choose CLUSTER1 from the **Cluster** list.
6. On the **Application Configuration** panel, select **IBM WebSphere Default Messaging**.
7. On each individual user application configuration panel, provide the parameters. Select **Install MDM application on cluster**. Choose CLUSTER1 from the **Cluster** list.
8. Click **Verify Installation Requirements** to run the prerequisite checks. Review and correct any errors or warnings, then click **Recheck**.
9. When the verification checks pass successfully, click **Install**.
10. When the installation is complete, view the logs and use the installation verification tools.

Related concepts:

“Prepare IBM Installation Manager” on page 72

“Worksheets for installation and configuration” on page 26

“Verifying the base installation” on page 159

Related tasks:

“Installing a custom deployment of InfoSphere MDM” on page 113

Troubleshooting an installation

Scenario: Installing InfoSphere MDM on a WebSphere Application Server Network Deployment on Windows with an SQL Server database

Use this scenario as a reference when planning and processing a virtual MDM deployment of InfoSphere MDM on a WebSphere Application Server Network Deployment. This scenario uses a Microsoft SQL Server database and IBM WebSphere MQ messaging. This scenario is applicable for a Microsoft Windows operating system.

Restriction: Since this scenario is on a Windows system with SQL Server, only virtual MDM features are supported. Physical MDM is not supported in this scenario.

This scenario is accomplished through four procedures.

1. Prepare your application server.
2. Prepare your SQL Server database.

3. Prepare IBM WebSphere MQ messaging.
4. Install InfoSphere MDM.

In this scenario, the topology is:

- Machine A:
 - WebSphere Application Server Deployment Manager and WebSphere Application Server managed node
 - IBM WebSphere MQ
 - IBM Installation Manager and InfoSphere MDM
- Machine B:
 - SQL Server database

Prepare Microsoft SQL Server database:

For the second step in completing this scenario, install and prepare your SQL Server database.

Procedure

1. Install SQL Server database on machine B. Use the Microsoft SQL Server installation documentation as a guide.
2. Create the database and table spaces by using the scripts that are provided in the InfoSphere MDM Installation Startup Kit.

Related tasks:

“Installing and setting up the database” on page 81

“Preparing a Microsoft SQL Server database” on page 85

“Installing the Installation Startup Kit” on page 73

Related reference:

“Microsoft SQL Server data source worksheet” on page 30

Prepare WebSphere Application Server Network Deployment:

As the first step in completing this scenario, install and prepare your application server.

About this task

The resulting topology from this procedure is that machine A has WebSphere Application Server Deployment Manager and a managed node.

Procedure

1. Install and configure WebSphere Application Server on machine A. Use the WebSphere Application Server Network Deployment documentation as a guide.
2. Make sure that your managed node is properly synchronized before you begin installing InfoSphere MDM.
3. Make sure that you know the WebSphere Application Server Deployment Manager host name and SOAP port before you start the InfoSphere MDM installation. Use the WebSphere Application Server configuration worksheet to record your values.
4. Make sure your application server is started before you begin the InfoSphere MDM installation.

Related concepts:

“Installing and setting up the application server” on page 75

Related tasks:

“Preparing WebSphere Application Server Network Deployment for a managed server deployment” on page 76

Related reference:

“WebSphere Application Server installation worksheet” on page 33

Preparing IBM WebSphere MQ:

Use this procedure to install and prepare IBM WebSphere MQ as a third step in completing this scenario.

Procedure

1. Install IBM WebSphere MQ on machine A. Use the IBM WebSphere MQ installation documentation as a guide.
2. Create the WebSphere MQ queue manager, channel, and queues by using the `custSetupMQServer.mqsc` and `ChannelAuth.mqsc` scripts. These scripts are included in the Installation Startup Kit.

Installing InfoSphere MDM:

Use this procedure to install InfoSphere MDM and any selected user applications as the final step in completing this scenario.

About this task

Make sure that your application server and database are started before you begin the InfoSphere MDM installation.

Procedure

1. Start IBM Installation Manager on machine A and choose your InfoSphere MDM offering. Continue through the prompts.
2. Specify the InfoSphere MDM installation home and shared directories. For example, MDM_INSTALL home - `c:\Program Files\IBM\MDM\E001\mdm` and Shared - `c:\Program Files\IBM\MDM\E001\Shared`
3. Choose the **MDM Database**, **MDM Operational Server**, and any user applications or other features you want to install. For example: select the **Applications** feature to install all user applications, or select specific applications.

Tip: Since this scenario is on a Windows system with SQL Server, you can only select virtual MDM user applications. Physical MDM is not supported in this scenario.

4. On the Database Configuration panel, specify the database type and database parameters. You can choose whether you want to test the database connection by selecting **Test Connection** or select **No connection test required**.
5. On the WebSphere Application Server Configuration panel, specify the application server parameters. Select **Retrieve Host Details** to obtain your Cell, Node, and Server information. Click **Verify MDM Instance on Server** to ensure that an InfoSphere MDM instance does not already exist.

6. On the **Application Configuration** panel, select **IBM WebSphere MQ** messaging and enter the parameters. Keep the **Configure messaging server** option selected to instruct IBM Installation Manager to create a queue manager on machine A.
7. On each individual user application configuration panel, provide the parameters.
8. Click **Verify Installation Requirements** to run the prerequisite checks. Review and correct any errors or warnings, then click **Recheck**.
9. When the verification checks pass successfully, click **Install**.
10. When the installation is complete, view the logs and use the installation verification tools.

Related concepts:

“Prepare IBM Installation Manager” on page 72

“Worksheets for installation and configuration” on page 26

“Verifying the base installation” on page 159

Related tasks:

“Installing a custom deployment of InfoSphere MDM” on page 113

Troubleshooting an installation

Scenario: Installing InfoSphere MDM Workbench on Windows, then connecting to a remote operational server

Use this scenario as a reference when planning and deploying an InfoSphere MDM development environment (MDM Workbench) installation on Microsoft Windows that connects to a remote InfoSphere MDM operational server and a remote database instance.

The steps outlined in this scenario are focused on the physical MDM aspect of InfoSphere MDM Workbench configuration and deployment.

Important: This scenario assumes that an operational server has already been installed on a remote machine.

This scenario is accomplished through the following procedures:

1. On a local machine, install the MDM Workbench.
2. Configure your local MDM Workbench instance to connect to the remote application server.
3. Configure your local MDM Workbench instance to connect to the remote database.
4. After completing development work, deploy your changes from MDM Workbench to the remote InfoSphere MDM instance.

In this scenario, the topology is:

- Machine A (local Microsoft Windows machine):
 - IBM Installation Manager and InfoSphere MDM Workbench
 - IBM Rational Application Developer
- Machine B (AIX server machine):
 - WebSphere Application Server Deployment Manager and WebSphere Application Server managed node
 - IBM Installation Manager and InfoSphere MDM operational server
 - IBM DB2 database

Related tasks:

“Installing a custom deployment of InfoSphere MDM” on page 113

Installing the local InfoSphere MDM development environment:

Prepare your local InfoSphere MDM development environment by installing MDM Workbench and IBM Rational Application Developer (RAD).

Before you begin

If you have already installed Rational Application Developer, ensure that you install MDM Workbench and Rational Application Developer into the same package group.

Tip: To view a video demonstration of the steps described in this procedure, see <http://youtu.be/96CkbrwASik>.

Procedure

1. Start IBM Installation Manager.
2. Add the MDM Workbench and Rational Application Developer repositories to IBM Installation Manager:
 - a. Click **File > Preferences**. The Preferences dialog opens.
 - b. Click **Add Repository...**
 - c. Select the MDM Workbench `.inf` file from the directory that contains the InfoSphere MDM installation images.
 - d. Click **Add Repository...**
 - e. Select the Rational Application Developer `.inf` file from the directory that contains the InfoSphere MDM installation images.
 - f. Click **OK**.
3. On the IBM Installation Manager home screen, click **Install**.
4. On the second Install Packages panel, select the Installation Directory into which you want to install the MDM Workbench. If you want to install in a directory other than the default, select the MDM Workbench and click **Browse** in the **Installation Directory** field.

Note: On Microsoft Windows 7 operating systems, install MDM Workbench into a directory that is not virtualized.

5. Click **Next**.
6. On the language panel, English is selected by default.
 - If you want any languages other than English, select the languages and click **Next**.
7. Select the **IBM Rational Application Developer for WebSphere Software** and **IBM InfoSphere Master Data Management Workbench** packages to install and click **Next**.
8. Click **Next** again to view the License panel. Read and accept the license, then click **Next**.
9. Complete the remaining Installation Manager panels and review the installation summary information, then click **Verify Installation Requirements** to run the prerequisite checks. Review and correct any errors or warnings, then click **Recheck**.
10. When the verification checks pass successfully, click **Install**.

11. Click **Finish** to close IBM Installation Manager.

Related tasks:

“Installing a custom deployment of InfoSphere MDM” on page 113

Configuring the remote server connection:

Create a new entry in the MDM Workbench Servers view to connect to the remote application server.

Procedure

1. Open the MDM Workbench on your local machine.
2. Open the Servers view.
3. Right-click in the Servers view and choose **New > Server**. The Define a New Server dialog opens.
4. Select the server type and version, such as **IBM > WebSphere Application Server v8.5.5.2**.
5. Enter the host name of your remote server.
6. Type the server name.
7. Select the server runtime environment and click **Next**.
8. Select **Manually provide connection settings** (always selected for remote servers) and configure the connection settings with the correct port numbers. You must select at least one connection type and ensure that the correct port is specified.
9. Select **Security is enabled on this server**, then provide the user ID and password.
10. Type the application server name.
11. Click **Test Connection** to confirm that all of your connection settings are accurate, then click **Finish**.

Related concepts:

“Installing and setting up the application server” on page 75

Configuring the remote database connection:

Configure a connection to the remote database so that you can test your InfoSphere MDM development and run any generated SQL.

Procedure

1. In the MDM Workbench, open the Data perspective.
2. In the Data Source Explorer view, right-click on **Database Connections**.
3. Click **New...** The New Connection dialog opens.
4. On the Connection Parameters screen, provide the details of your remote database instance:
 - a. Select the database manager type.
 - b. Select the JDBC driver.
 - c. Type the database name.
 - d. Type the host address and port number.
 - e. Provide the client authentication user name and password.
 - f. Type the default schema name.
 - g. Confirm the connection URL.

5. After configuring the remote database instance, click **Test Connection** to confirm that your settings are correct.
6. Click **Finish**.

Related tasks:

“Installing and setting up the database” on page 81

Related information:

 Running the SQL scripts to prepare for deployment

Deploying local changes to the remote InfoSphere MDM instance:

In this scenario, the MDM Workbench development process is identical to the normal process, but you must deploy your CBA to the remote operational sever using the WebSphere Application Server Integrated Solutions Console (admin console).

Procedure



1. Complete your MDM Workbench development tasks.
2. Ensure that you have generated the code for your project after adding it to the CBA.
3. Run the SQL scripts in the MDMSHaredResources/sql directory that corresponds to your remote database instance.
4. In the MDM Workbench, right-click the CBA project and click **Export**.
5. Select the export destination **OSGi > OSGi Composite Bundle (CBA)**. Verify that the bundles that you are exporting include your operational server module bundle.

Important: Ensure that you are only exporting the customization bundles, and not the core referenced bundles from InfoSphere MDM. If you select all of the bundles when exporting the CBA, then you will have duplicates of the core bundles.

6. Click **Browse** and choose a location to save the CBA file, then click **Finish**.
7. Open the remote WebSphere Application Server Integrated Solutions Console and, in the navigation frame, click **Environment > OSGi bundle repositories > Internal bundle repository** and, at the top of the table, click **New**
8. Select the local file system and browse to where you saved the CBA you exported from the MDM Workbench, then click **OK**, then click **Save directly to the master configuration**.
9. In the navigation frame, click **Applications > Application Types > Business-level applications**
10. Click on the InfoSphere MDM application and select the EBA deployed asset (for example, `com.ibm.mdm.server.app_0001.eba`). This step can take several minutes.
11. From the right-hand column, click **Extensions for this composition unit**, then at the top of the table, click **Add**.
12. Select the check box next to the imported CBA, then click **Add** at the top of the table. It can take a few minutes to load the next page.
13. Click **Save directly to the master configuration**. This returns you to the composition unit page.
14. Near the bottom of the page, click the **Update to latest deployment**, examine the preview of changes, and then click **OK**. For your extension CBA, it should show a change from Not deployed to a version number.

15. Click **Next** through the options wizard, accepting the default options on each page, then click **Finish**.
16. Click **Save directly to the master configuration**.
17. Restart the remote InfoSphere MDM business level application (BLA).

Related information:

-  Addition and extension deployment
-  Running the SQL scripts to prepare for deployment
-  Deploying a CBA to the operational server from admin console

Installing a stand-alone server with DB2

Complete the tasks in this section to install a stand-alone InfoSphere MDM server with IBM DB2.

About this task

A stand-alone server installation with DB2 enables you to deploy an InfoSphere MDM edition, IBM WebSphere Application Server, and IBM DB2 for Linux, UNIX, and Windows on a server.

Stand-alone installations with DB2 must be run as a root user on UNIX and Linux, or an administrator user on Microsoft Windows.

Important: Before you begin the process of installing InfoSphere MDM, review the known problems. Some of the known installation problems require you to complete specific preinstallation configuration tasks. Failure to complete these configuration tasks can result in a failed installation.

Acquiring and extracting the installation files

The installation media for installing InfoSphere MDM is available as downloadable installation image files.

About this task

Use the Download IBM InfoSphere Master Data Management page to help determine the parts that you need for your licensed edition and version. Use the information in the system requirements topic to determine the supported versions for WebSphere Application Server and fix packs.

Important: Before you begin installing InfoSphere MDM, ensure that you have downloaded all of the latest installation packages and fix packs required for your licensed edition and version.

Procedure

To obtain installation image files from IBM Passport Advantage®, download and extract the files into a directory called MDM. When you extract the files, they will be placed into a folder structure that reflects the parts that you have downloaded.



Related tasks:

“Starting a stand-alone with DB2 installation using LaunchPad” on page 58

Related reference:

“Installation requirements” on page 2

Related information:

-  System requirements for InfoSphere MDM
-  Download IBM InfoSphere Master Data Management

Preparing for a stand-alone installation with DB2

Before you begin a stand-alone server installation with DB2 or stand-alone workstation installation with DB2, make sure that you complete the planning steps and meet the prerequisites. These steps are applicable only to stand-alone installations with DB2.

About this task

A stand-alone installation with DB2 deployment type must be done on a clean server or a clean workstation.

Procedure

- Review the readme file for system requirements and potential issues that might affect your installation.
- Read the release notes for information about supported product features or enhancements to the release.
- Review and complete the installation worksheets.
- Complete the “Acquiring and extracting the installation files” on page 56 task.
- Review “Installation requirements” on page 2.
- Review “Stand-alone installation deployment types” on page 21.
- If you are installing in a Dynamic Host Configuration Protocol (DHCP) environment, you must set the host IP in the `/etc/hosts` file. This setting is not required if your host uses a static IP. This setting is not required for custom installations either.
- For stand-alone installations with DB2, ensure that you are logged in as the root user, assuming that IBM DB2, InfoSphere MDM, and IBM WebSphere Application Server will all be installed using root.

Important: To perform installations as a root user, you must install IBM Installation Manager in *admin* mode. To install IBM Installation Manager in admin mode, log in as the root user, then run the `install` command.

What to do next

Continue with starting your installation with LaunchPad and use the installation instructions for your stand-alone with DB2 deployment type.

Related concepts:

“Worksheets for installation and configuration” on page 26

Related tasks:

“Starting a stand-alone with DB2 installation using LaunchPad” on page 58

“Installing a stand-alone server with DB2” on page 58

“Installing a stand-alone workstation installation with DB2” on page 65

Related reference:

“User accounts, groups, and defaults used by the installation application” on page 12

Starting a stand-alone with DB2 installation using LaunchPad

Use LaunchPad to start the stand-alone with DB2 installation process. This method is the only way to begin a stand-alone server with DB2 or stand-alone workstation with DB2 installation.

Before you begin

LaunchPad is a browser-based application that is used as the starting point for a stand-alone server installation with DB2 or stand-alone workstation installation with DB2. LaunchPad requires the Mozilla Firefox browser.

Tip: If Firefox is unavailable, you might be unable to use LaunchPad. If you cannot use LaunchPad:

1. Log in as the root user.
2. Install IBM Installation Manager in admin mode.
3. Manually configure all of the stand-alone with DB2 InfoSphere MDM installation repositories.

From LaunchPad you can:

- Start the installation process
- Exit the installation process

Attention: Your installation media must be in the correct locations for LaunchPad to start. See “Acquiring and extracting the installation files” on page 56.

Procedure

1. Go to the directory in which you downloaded the InfoSphere MDM media and open Disk1. For example. *download_path*/MDM/disk1
2. From the *download_path*/MDM/disk1, start LaunchPad using one of these scripts:
 - Microsoft Windows: `launchpad.exe` - On Microsoft Windows, right-click on the script and choose **Run as Administrator**.
 - Linux and UNIX: `launchpad.sh` - Run as root user

Related tasks:

“Installing InfoSphere MDM Workbench” on page 155

“Acquiring and extracting the installation files” on page 56

“Preparing for a stand-alone installation with DB2” on page 57

Installing a stand-alone server with DB2

Use this procedure to run a stand-alone server installation with DB2 for Linux, UNIX, or Windows. A stand-alone server installation implies that you are selecting to install an IBM InfoSphere Master Data Management edition, IBM WebSphere Application Server, and IBM DB2 for Linux, UNIX, or Windows on a clean server.

Before you begin

Make sure that you meet these prerequisites:

- The server on which you are installing does not have any existing instances of MDM, IBM WebSphere Application Server, or IBM DB2.
- You have access to InfoSphere MDM, IBM WebSphere Application Server, and IBM DB2 offerings.

If you are installing on Microsoft Windows:

- You must be running in Administrator mode for IBM Installation Manager to write to the Windows registry. Administrator mode is not used for IBM AIX, Linux, or Solaris.
- On a Microsoft Windows 7 operating system, you must install MDM into a directory that is not virtualized.

Your installation media must be in the correct locations for LaunchPad to start. See “Acquiring and extracting the installation files” on page 56.

During a stand-alone installation, the default configuration values are automatically used by the installation application. You can review the configuration worksheets if you want to know what the defaults are before you begin the installation.

For server installations, you must use IBM WebSphere Application Server network deployment.

Attention: The stand-alone installation is configured to use specific TCP or SOAP ports for the application server. For a successful installation, first verify that the following TCP or SOAP ports are not in use: 50000 - 50002 and 60000 - 60004.

Procedure

1. From the *download_path*/MDM/disk1, start LaunchPad using one of these scripts:
 - Microsoft Windows: `launchpad.exe` - On Microsoft Windows, right-click on the script and choose **Run as Administrator**.
 - Linux and UNIX: `launchpad.sh` - Run as root user
2. On the Install Packages panel, verify that the following items are selected:
 - IBM WebSphere Application Server network deployment
 - IBM DB2
 - InfoSphere MDM Standard or Advanced Edition

Attention: Clearing any of the preselected components automatically changes the installation mode from a stand-alone installation to a custom installation.

3. Click **Next**.
4. Review and accept the license agreement, then click **Next**.
5. Choose whether to install into an existing package group or create a new package group.

Tip: If you are unsure of what to choose, then accept the default. Most installations should create a new package group.

Important: If you have IBM Rational Application Developer installed, make sure that you do not install InfoSphere MDM into the same package group. Select **Create a new package group**.

6. On the same panel, define the **Installation Directory** into which you want to install each component. If you choose to install a component in a directory other than the default, select that component and click **Browse** in the **Installation Directory** field.

Review the disk space information, then click **Next**.

7. On the language panel, English is always selected.
 - a. If you want to support any languages in addition to English, select them.
 - b. Some packages support more languages than others. If you want more languages, click the twistie for **Translations Supported by Only Some Packages** and select each additional language that you want.
 - c. Click **Next**.
8. On the Features panel, select **Data Stewardship UI** or **Inspector** if you want to install one or both of the user applications.
9. Review the installation summary information to ensure that the details are accurate, then click **Verify Installation Requirements** to run the prerequisite checks. The checks will help to ensure that your environment and configuration is sufficient to successfully complete the installation. Click **Show details** to view more details for each result.
10. Take corrective action to address any warnings or errors in the prerequisite checks, then click **Install**.
11. When the installation is complete, click **None** in the Which program do you want to start pane.
12. On the final IBM Installation Manager panel, click **View Log Files** if you want to open the log file viewer.
13. Click **Finish**, then close IBM Installation Manager.

Results

A success message on the final installer panel indicates that the verification tests were automatically run as part of the installation process. You can also view the log files to verify a successful installation. If the installation is not successful, view the log files and use the information in the troubleshooting topics to assist you.

What to do next

After installation, if you want to add or remove a feature (for example, add an application or another language translation), or modify any of your configuration settings, you can run IBM Installation Manager again and select **Modify**.

For a list of user names and passwords that are created by the installer, see the topic about default user accounts created during a stand-alone installation deployment (see related reference topics).

Related concepts:

“Stand-alone server installation with DB2” on page 22

“Worksheets for installation and configuration” on page 26

“Verifying the base installation” on page 159

Related tasks:

“Uninstalling a stand-alone server installation with DB2” on page 186

Troubleshooting an installation

“Preparing for a stand-alone installation with DB2” on page 57

Related reference:

“User accounts, groups, and defaults used by the installation application” on page 12

Prerequisite checks for stand-alone installations with DB2

The InfoSphere MDM installer application runs tests to ensure that certain prerequisites are in place before each stand-alone installation with DB2 begins.

The prerequisite checking tool helps to prevent you from beginning an installation that will be unable to successfully complete due to any missing prerequisites.

Tip: Run the prerequisite checks from within Installation Manager from the Installation Configuration Review panel by clicking **Verify Installation Requirements**.

When running a stand-alone installation with DB2, the installation application runs the following prerequisite checks.

Table 15. System checks

Prerequisite check	Description	Resolution
Installation disk space verification	This check validates that there is sufficient disk space to install InfoSphere MDM and all required software for a stand-alone with DB2 deployment, including the WebSphere Application Server profile and the database.	Ensure that there is at least 32 GB of disk space available on the installation target machine.
Memory verification for running the installation application	This check validates that there is sufficient memory to run the installation. This message is a warning only.	Ensure that the system that you are installing on has at least 8 GB of RAM. Note: You can choose to ignore this warning, but the installation may fail.

Table 16. Database checks

Prerequisite check	Description	Resolution
Database instance verification	The check validates that the database does not already exist. Stand-alone installations with DB2 require an environment without a preexisting database.	If your installation environment has a preexisting database, remove it before attempting to complete the installation.
Database name verification	The check validates that the database name is valid.	The database name must consist of 12 or fewer alphanumeric characters. Underscore (_) characters can be used in the name. Other characters are not supported.
Database user verification	This check determines if the database user specified in the installation panels exists. This user should not already be present in the system. This message is a warning only.	Delete the database user if it already exists. The stand-alone installation with DB2 will create the user during installation. Alternately, ensure that the db2admin database user has the same default password. Note: You can choose to ignore this warning, but the installation may fail.

Table 16. Database checks (continued)

Prerequisite check	Description	Resolution
Global Security Kit v8 verification	<p>This check determines if the Global Security Kit library is present from a previous DB2 installation.</p> <p>If the Global Security Kit library is present and the installed version is below the minimum requirement for InfoSphere MDM, then the check will fail. If the Global Security Kit library is the wrong version, then the DB2 database manager is unable to start.</p>	<p>Delete the Global Security Kit library folder (GSK8\lib64), then continue with the installation.</p> <p>Tip: On Microsoft Windows, You can locate the GSK8 folder by checking the Path in your System variables and looking for a directory path similar to C:\Program Files\IBM\GSK8\lib64</p>
ODBC datasource verification	<p>This check determines whether an ODBC datasource exists in a Microsoft Windows registry. This check will fail with an error if an ODBC datasource already exists.</p> <p>Note: For non-Windows systems, this check will always pass.</p>	<p>If an ODBC datasource exists in your Windows registry, remove the datasource:</p> <ol style="list-style-type: none"> 1. Open the Windows Registry Editor by running the command regedit. 2. Find the entry HKEY_LOCAL_MACHINE\SOFTWARE\ODBC\ODBC.INI. 3. Expand ODBC.INI, locate the ODBC datasource entry, then right-click it and select Delete. 4. Under ODBC.INI, select the ODBC Data Sources entry. In the display pane, all of the subentries are shown. 5. Locate the ODBC datasource entry in the list of subentries. Right-click the entry and select Delete.

Table 17. Operational server checks

Prerequisite check	Description	Resolution
SOAP port verification	<p>This check determines if the required port numbers for SOAP are available. Both of the required port numbers, 8879 and 8880, must be available.</p>	<p>Ensure that both ports 8879 and 8880 are available for use by SOAP.</p>

Related reference:

“Database user accounts and connections” on page 82

Related information:

 InfoSphere MDM system requirements

Installing a stand-alone workstation with DB2

Complete the tasks in this section to install a stand-alone InfoSphere MDM workstation with IBM DB2.

About this task

A stand-alone workstation installation with DB2 enables you to deploy an InfoSphere MDM edition, IBM WebSphere Application Server, IBM DB2 for Linux, UNIX, and Windows, IBM Rational Application Developer, and InfoSphere MDM Workbench on a Microsoft Windows workstation.

Your workstation must be a Microsoft Windows or Linux operating system. Other operating systems are not supported for stand-alone workstation installations. Stand-alone installations with DB2 must be run as a root user on Linux or an administrator user on Microsoft Windows.

Important: Before you begin the process of installing InfoSphere MDM, review the known problems. Some of the known installation problems require you to complete specific preinstallation configuration tasks. Failure to complete these configuration tasks can result in a failed installation.

Acquiring and extracting the installation files

The installation media for installing InfoSphere MDM is available as downloadable installation image files.

About this task

Use the Download IBM InfoSphere Master Data Management page to help determine the parts that you need for your licensed edition and version. Use the information in the system requirements topic to determine the supported versions for WebSphere Application Server and fix packs.

Important: Before you begin installing InfoSphere MDM, ensure that you have downloaded all of the latest installation packages and fix packs required for your licensed edition and version.

Procedure

To obtain installation image files from IBM Passport Advantage, download and extract the files into a directory called MDM. When you extract the files, they will be placed into a folder structure that reflects the parts that you have downloaded.

Related tasks:

“Starting a stand-alone with DB2 installation using LaunchPad” on page 58

Related reference:

“Installation requirements” on page 2

Related information:

 System requirements for InfoSphere MDM

 Download IBM InfoSphere Master Data Management

Preparing for a stand-alone installation with DB2

Before you begin a stand-alone server installation with DB2 or stand-alone workstation installation with DB2, make sure that you complete the planning steps and meet the prerequisites. These steps are applicable only to stand-alone installations with DB2.

About this task

A stand-alone installation with DB2 deployment type must be done on a clean server or a clean workstation.

Procedure

- Review the readme file for system requirements and potential issues that might affect your installation.
- Read the release notes for information about supported product features or enhancements to the release.
- Review and complete the installation worksheets.
- Complete the “Acquiring and extracting the installation files” on page 56 task.
- Review “Installation requirements” on page 2.
- Review “Stand-alone installation deployment types” on page 21.
- If you are installing in a Dynamic Host Configuration Protocol (DHCP) environment, you must set the host IP in the `/etc/hosts` file. This setting is not required if your host uses a static IP. This setting is not required for custom installations either.
- For stand-alone installations with DB2, ensure that you are logged in as the root user, assuming that IBM DB2, InfoSphere MDM, and IBM WebSphere Application Server will all be installed using root.

Important: To perform installations as a root user, you must install IBM Installation Manager in *admin* mode. To install IBM Installation Manager in admin mode, log in as the root user, then run the `install` command.

What to do next

Continue with starting your installation with LaunchPad and use the installation instructions for your stand-alone with DB2 deployment type.

Related concepts:

“Worksheets for installation and configuration” on page 26

Related tasks:

“Starting a stand-alone with DB2 installation using LaunchPad” on page 58

“Installing a stand-alone server with DB2” on page 58

“Installing a stand-alone workstation installation with DB2” on page 65

Related reference:

“User accounts, groups, and defaults used by the installation application” on page 12

Starting a stand-alone with DB2 installation using LaunchPad

Use LaunchPad to start the stand-alone with DB2 installation process. This method is the only way to begin a stand-alone server with DB2 or stand-alone workstation with DB2 installation.

Before you begin

LaunchPad is a browser-based application that is used as the starting point for a stand-alone server installation with DB2 or stand-alone workstation installation with DB2. LaunchPad requires the Mozilla Firefox browser.

Tip: If Firefox is unavailable, you might be unable to use LaunchPad. If you cannot use LaunchPad:

1. Log in as the root user.
2. Install IBM Installation Manager in admin mode.
3. Manually configure all of the stand-alone with DB2 InfoSphere MDM installation repositories.

From LaunchPad you can:

- Start the installation process
- Exit the installation process

Attention: Your installation media must be in the correct locations for LaunchPad to start. See “Acquiring and extracting the installation files” on page 56.

Procedure

1. Go to the directory in which you downloaded the InfoSphere MDM media and open Disk1. For example, `download_path/MDM/disk1`
2. From the `download_path/MDM/disk1`, start LaunchPad using one of these scripts:
 - Microsoft Windows: `launchpad.exe` - On Microsoft Windows, right-click on the script and choose **Run as Administrator**.
 - Linux and UNIX: `launchpad.sh` - Run as root user

Related tasks:

“Installing InfoSphere MDM Workbench” on page 155

“Acquiring and extracting the installation files” on page 56

“Preparing for a stand-alone installation with DB2” on page 57

Installing a stand-alone workstation installation with DB2

Use this procedure to run a stand-alone workstation installation with DB2. Stand-alone workstation installations are supported on Microsoft Windows or Linux operating systems only. A stand-alone workstation installation implies that you are selecting to install an IBM InfoSphere Master Data Management edition, IBM WebSphere Application Server, IBM DB2 for Linux, UNIX, or Windows, InfoSphere MDM Workbench, and IBM Rational Application Developer (RAD) on a clean workstation.

Before you begin

Make sure that you meet these prerequisites:

- The server on which you are installing does not have any existing instances of MDM, IBM WebSphere Application Server, or IBM DB2.
- You have access to InfoSphere MDM, IBM WebSphere Application Server, IBM DB2, IBM Rational Application Developer (RAD), and MDM Workbench offerings.

If you are installing on Microsoft Windows:

- You must be running in Administrator mode for IBM Installation Manager to write to the Windows registry. Administrator mode is not used for IBM AIX, Linux, or Solaris.
- On a Microsoft Windows 7 operating system, you must install MDM into a directory that is not virtualized.

Make sure that the required 32-bit libraries are available on your 64-bit operating system.

Your installation media must be in the correct locations for LaunchPad to start. See “Acquiring and extracting the installation files” on page 56.

About this task

During a stand-alone installation with DB2, default configuration values are used automatically by the installation application. You can review the configuration worksheets if you want to know what the defaults are before you begin the installation.

For workstation installations, you must use IBM WebSphere Application Server base deployment.

Attention: The stand-alone installation with DB2 is configured to use specific TCP or SOAP ports for the application server. For a successful installation, first verify that the following TCP or SOAP ports are not in use: 50000 - 50002 and 60000 - 60004.

Procedure

1. Review and ensure that your system meets the prerequisites listed in the preceding sections of this topic.
2. From the *download_path/MDM/disk1*, start LaunchPad using one of these scripts:
 - Microsoft Windows: `launchpad.exe` - On Microsoft Windows, right-click on the script and choose **Run as Administrator**.
 - Linux and UNIX: `launchpad.sh` - Run as root user
3. On the Install Packages panel, verify that the following items are selected:
 - IBM WebSphere Application Server
 - IBM DB2
 - IBM Rational Application Developer (RAD)
 - InfoSphere MDM Standard or Advanced Edition
 - InfoSphere MDM Workbench

Attention: Clearing any of the preselected components automatically changes the installation mode from a stand-alone installation to a custom installation.

4. Click **Next**.
5. On the extend eclipse panel, define whether you wish to extend an existing installation of Eclipse, then click **Next**.
6. Review and accept the license agreement, then click **Next**.
7. Choose whether to install into an existing package group or create a new package group.

Tip: If you are unsure of what to choose, then accept the default. Most installations should create a new package group.

Important: If you have IBM Rational Application Developer installed, make sure that you do not install InfoSphere MDM into the same package group. Select **Create a new package group**.

8. On the same panel, define the **Installation Directory** into which you want to install each component. If you choose to install a component in a directory other than the default, select that component and click **Browse** in the **Installation Directory** field.
Review the disk space information, then click **Next**.
9. On the language panel, English is always selected.
 - a. If you want to support any languages in addition to English, select them.
 - b. Some packages support more languages than others. If you want more languages, click the twistie for **Translations Supported by Only Some Packages** and select each additional language that you want.
 - c. Click **Next**.
10. On the features panel, select the InfoSphere MDM features, applications, and optional components to install and click **Next**.
11. On the user credentials panel, provide the connection credentials for your WebSphere Application Server and database instances.
12. Review the installation summary information to ensure that the details are accurate, then click **Verify Installation Requirements** to run the prerequisite checks. Click **Show details** to view more details for each result. The checks will help to ensure that your environment and configuration is sufficient to successfully complete the installation.
13. Take corrective action to address any warnings or errors in the prerequisite checks, then click **Install**.
14. On the Help System Common Configurations panel, select one of the options for how you want to access IBM Rational Application Developer (RAD) help and click **Next**.
15. Click **Install**.
16. On the final IBM Installation Manager panel, click **View Log Files** if you want to open the log file viewer.
17. Click **Finish**, then close IBM Installation Manager.

What to do next

A success message on the final installer panel indicates that the verification tests were automatically run as part of the installation process. You can also view the log files to verify a successful installation. If the installation is not successful, view the log files and use the information in the troubleshooting topics to assist you.

After installation, if you want to add or remove a feature (for example, add an application or another language translation), or modify any of your configuration settings, you can run IBM Installation Manager again and select **Modify**.

For a list of user names and passwords that are created by the installer, see the topic about default user accounts created during a stand-alone installation deployment (see related reference topics).

Related concepts:

“Stand-alone workstation installation with DB2” on page 23

“Worksheets for installation and configuration” on page 26

“Verifying the base installation” on page 159

Related tasks:

“Uninstalling a stand-alone workstation installation with DB2” on page 186

Troubleshooting an installation

“Preparing for a stand-alone installation with DB2” on page 57

Related reference:

“User accounts, groups, and defaults used by the installation application” on page 12

“32-bit libraries needed on 64-bit operating systems” on page 4

Prerequisite checks for stand-alone installations with DB2

The InfoSphere MDM installer application runs tests to ensure that certain prerequisites are in place before each stand-alone installation with DB2 begins.

The prerequisite checking tool helps to prevent you from beginning an installation that will be unable to successfully complete due to any missing prerequisites.

Tip: Run the prerequisite checks from within Installation Manager from the Installation Configuration Review panel by clicking **Verify Installation Requirements**.

When running a stand-alone installation with DB2, the installation application runs the following prerequisite checks.

Table 18. System checks

Prerequisite check	Description	Resolution
Installation disk space verification	This check validates that there is sufficient disk space to install InfoSphere MDM and all required software for a stand-alone with DB2 deployment, including the WebSphere Application Server profile and the database.	Ensure that there is at least 32 GB of disk space available on the installation target machine.
Memory verification for running the installation application	This check validates that there is sufficient memory to run the installation. This message is a warning only.	Ensure that the system that you are installing on has at least 8 GB of RAM. Note: You can choose to ignore this warning, but the installation may fail.

Table 19. Database checks

Prerequisite check	Description	Resolution
Database instance verification	The check validates that the database does not already exist. Stand-alone installations with DB2 require an environment without a preexisting database.	If your installation environment has a preexisting database, remove it before attempting to complete the installation.

Table 19. Database checks (continued)

Prerequisite check	Description	Resolution
Database name verification	The check validates that the database name is valid.	The database name must consist of 12 or fewer alphanumeric characters. Underscore (_) characters can be used in the name. Other characters are not supported.
Database user verification	This check determines if the database user specified in the installation panels exists. This user should not already be present in the system. This message is a warning only.	Delete the database user if it already exists. The stand-alone installation with DB2 will create the user during installation. Alternately, ensure that the db2admin database user has the same default password. Note: You can choose to ignore this warning, but the installation may fail.
Global Security Kit v8 verification	This check determines if the Global Security Kit library is present from a previous DB2 installation. If the Global Security Kit library is present and the installed version is below the minimum requirement for InfoSphere MDM, then the check will fail. If the Global Security Kit library is the wrong version, then the DB2 database manager is unable to start.	Delete the Global Security Kit library folder (GSK8\lib64), then continue with the installation. Tip: On Microsoft Windows, You can locate the GSK8 folder by checking the Path in your System variables and looking for a directory path similar to C:\Program Files\IBM\GSK8\lib64
ODBC datasource verification	This check determines whether an ODBC datasource exists in a Microsoft Windows registry. This check will fail with an error if an ODBC datasource already exists. Note: For non-Windows systems, this check will always pass.	If an ODBC datasource exists in your Windows registry, remove the datasource: <ol style="list-style-type: none">1. Open the Windows Registry Editor by running the command regedit.2. Find the entry HKEY_LOCAL_MACHINE\SOFTWARE\ODBC\ODBC.INI.3. Expand ODBC.INI, locate the ODBC datasource entry, then right-click it and select Delete.4. Under ODBC.INI, select the ODBC Data Sources entry. In the display pane, all of the subentries are shown.5. Locate the ODBC datasource entry in the list of subentries. Right-click the entry and select Delete.

Table 20. Operational server checks

Prerequisite check	Description	Resolution
SOAP port verification	This check determines if the required port numbers for SOAP are available. Both of the required port numbers, 8879 and 8880, must be available.	Ensure that both ports 8879 and 8880 are available for use by SOAP.

Related reference:

“Database user accounts and connections” on page 82

Related information:

 [InfoSphere MDM system requirements](#)

Installing a custom deployment

Complete the tasks in this section to install a custom deployment of InfoSphere MDM.

About this task

Custom installations deploy InfoSphere MDM to almost any possible deployment scenario. Most InfoSphere MDM deployments require the custom installation deployment type.

Custom installations are the required method if you are using an Oracle or Microsoft SQL Server database or if you are installing in a clustered environment. Custom installations also support IBM DB2 databases.

Custom installations must be run as a non-root user on UNIX and Linux.

Important: Before you begin the process of installing InfoSphere MDM, review the known problems. Some of the known installation problems require you to complete specific preinstallation configuration tasks. Failure to complete these configuration tasks can result in a failed installation.

Related concepts:

“Support for high availability environments” on page 26

Acquiring and extracting the installation files

The installation media for installing InfoSphere MDM is available as downloadable installation image files.

About this task

Use the Download IBM InfoSphere Master Data Management page to help determine the parts that you need for your licensed edition and version. Use the information in the system requirements topic to determine the supported versions for WebSphere Application Server and fix packs.

Important: Before you begin installing InfoSphere MDM, ensure that you have downloaded all of the latest installation packages and fix packs required for your licensed edition and version.

Procedure

To obtain installation image files from IBM Passport Advantage, download and extract the files into a directory called MDM. When you extract the files, they will be placed into a folder structure that reflects the parts that you have downloaded.

Related tasks:

“Starting a stand-alone with DB2 installation using LaunchPad” on page 58

Related reference:

“Installation requirements” on page 2

Related information:

 System requirements for InfoSphere MDM

 Download IBM InfoSphere Master Data Management

Preparing for a custom deployment

Before you install InfoSphere MDM, make sure that you complete the planning steps and meet the prerequisites. These steps are applicable to custom installations only.

About this task

Important: These steps are not required if you plan to perform a stand-alone server with DB2 or stand-alone workstation with DB2 installation. Refer to the section about preparing for stand-alone installations.

- Review the readme file for system requirements and potential issues that might affect your installation.
- Read the release notes for information about supported product features or enhancements to the release.
- Review the installation scenarios section, and determine the installation topology that you are going to use.
- Review and complete the installation worksheets.
- Set up your installation media.
- Use a different database user for each deployment of the offering.
- Note the following items if you plan on using an IBM DB2 database:
 - For installation purposes, set up one or more restricted users on a system for database schema users. Because DB2 uses the operating system to authenticate a new user, use a user ID such as mdmdb1 with a restricted shell. This user is not required to be a member of any of the DB2 groups.
 - You can also do a simple installation by using a single ID for both the DB2 installation ID and the schema ID. The default ID is db2inst1. For more information, see your DB2 documentation.

In addition to these general prerequisites, there are other specific prerequisite tasks for installing InfoSphere MDM. These tasks are outlined in the following topics.

Related concepts:

“Custom installation deployment type” on page 24

“Installation scenarios” on page 43

“Multiple instance support” on page 11

“Worksheets for installation and configuration” on page 26

Related tasks:

Chapter 3, “Installing the product,” on page 19

“Installing a custom deployment of InfoSphere MDM” on page 113

Related reference:

“Installation requirements” on page 2

Prepare IBM Installation Manager

All components of the InfoSphere MDM editions are installed by using IBM Installation Manager.

IBM Installation Manager uses defined repositories to determine what packages are available for you to install. These repositories point to your installation media.

Offerings must be manually added to the IBM Installation Manager repositories.

Launchpad is included in the InfoSphere MDM download and can be used to start IBM Installation Manager for stand alone server and workstation installations. If you have IBM Installation Manager already installed, LaunchPad checks the version number. If you do not have the current version, it is automatically updated. If you do not have IBM Installation Manager installed, Launchpad initiates the installation.

If you are planning a custom installation, continue with the tasks for installing IBM Installation Manager and adding your repositories. If you are planning a stand alone server or stand alone workstation installation, these tasks are not required.

Related tasks:

“Installing InfoSphere MDM into a clustered environment” on page 124

Installing IBM Installation Manager:

Use this procedure if IBM Installation Manager is not installed.

About this task

If you use the LaunchPad to initiate your installation, the Launchpad installs IBM Installation Manager automatically. In this case, completing this task is not necessary.

Do not install IBM Installation Manager in admin mode.

Procedure

1. From the Passport Advantage page for your InfoSphere MDM version and edition, download the IBM Installation Manager package.
2. Extract the compressed file.
3. From a command prompt, run the command to install in non-admin mode:
 - On Microsoft Windows systems: `userinst.exe`
 - On Linux, AIX, or Solaris systems: `userinst`
4. Complete the installation wizard.

What to do next

Continue with adding offerings to IBM Installation Manager.

Adding offerings to IBM Installation Manager:

Use this procedure to add InfoSphere MDM to the list of offerings that are installed by IBM Installation Manager.

Before you begin

Perform this task if you are performing a custom installation. If you are performing a stand-alone server installation or stand-alone workstation installation, this task is not necessary.

Make sure that you installed IBM Installation Manager and that you did not install it in admin mode.

Procedure

1. Start IBM Installation Manager.
2. Click **File > Preferences**.
3. On the Preferences dialog, select **Repositories > Add Repository**.
4. On the Add Repository dialog, click **Browse**.
5. Locate and select the InfoSphere MDM packages that you want to install. For example, *download_path/MDM/disk1/diskTag.ini*.
6. Add any additional offerings, such as the Installation Startup Kit, IBM WebSphere Application Server, IBM DB2, or InfoSphere MDM Workbench.
7. On the Add Repository dialog, click **OK**.
8. On the Preferences dialog, click **OK**.

What to do next

Continue with preparing for and installing the MDM operational server and applications.

Installing the Installation Startup Kit

Install the Installation Startup Kit before you begin preparing your environment for installation.

About this task

The Installation Startup Kit contains scripts that are used to create databases and profiles that are needed to prepare your installation environment. The kit also includes a command line prerequisite checking tool that can help you to know when your environment is ready to begin the installation.

Procedure

1. Start IBM Installation Manager.
2. Add the Installation Startup Kit offering to the IBM Installation Manager repositories
 - a. Open IBM Installation Manager.
 - b. Select **File > Preferences...**
 - c. From the Repositories panel, choose **Add Repository**.
 - d. Click **Browse** and navigate to the location of the Installation Startup Kit package directory (*MDM_INSTALL_HOME\StartupToolkit*). Select *disk1.inf* and click **OK**.

3. On the IBM Installation Manager home screen, click **Install**.
4. On the Install Packages panel, select **IBM MDM Operational Server Installation Startup Kit** and click **Next**.
5. Continue through the panels, selecting the default package group and installation packages.
6. Click **Install**.
7. Click **Finish** when the installation is complete and close IBM Installation Manager.

Results

The Installation Startup Kit scripts and files are extracted to the directory that you define as the `STARTUPKIT_INSTALL_HOME`.

What to do next

You can use the Installation Startup Kit scripts and files to help you to prepare your database and application server.

Related concepts:

“Prepare IBM Installation Manager” on page 72

Related tasks:

“Installing silently by using a response file” on page 142

“Installing and setting up the database” on page 81

Manually installing the InfoSphere MDM messaging server component

“Preparing a DB2 database” on page 82

“Preparing an Oracle database” on page 87

“Preparing a Microsoft SQL Server database” on page 85

“Checking prerequisites using the command line tool” on page 112

Related reference:

“Installation Startup Kit for custom installations” on page 10

Account prerequisites for custom installations

Before you begin a custom installation, you must have certain account prerequisites in place.

- You must be logged on with an account that owns the IBM WebSphere Application Server directories and binary files. The database JDBC drivers must be accessible by this account. The instructions in the preparation topics assume that you are doing the installation locally on the server.
- Install InfoSphere MDM as a non-root user:
 - For IBM WebSphere Application Server, use the *wasadmin* ID.
This ID must own a DB2 client or a DB2 instance and be a member of the *mqm* management group.
 - For DB2:
 - The suggested installation method is to set up one or more restricted users on a system for database schema users. Because DB2 uses the operating system to authenticate to a new user, a user ID such as *mdmdb1* with a restricted shell is the best choice. This user is not required to be a member of any of the DB2 groups.

- You can also do a simple installation by using a single ID for both the DB2 installation ID and the schema ID. The default ID is db2inst1. For more information about IBM DB2, see the product documentation.
- A different database user and schema must exist for each deployment of InfoSphere MDM. Different databases for each deployment are not required.
- When you install on IBM WebSphere Application Server, ensure that no server named *server* or cluster named *cluster* is being used on IBM WebSphere Application Server. The names *server* and *cluster* are used by the InfoSphere MDM installation.

Related tasks:

“Checking prerequisites using the command line tool” on page 112

Related reference:

“Database user accounts and connections” on page 82

“User accounts, groups, and defaults used by the installation application” on page 12

Installing and setting up the application server

If you are planning to install InfoSphere MDM by performing a custom installation, you must prepare an application server before you begin the installation process.

InfoSphere MDM components run inside WebSphere Application Server. The application server provides infrastructure for component-to-component communication, authentication, and logging.

Note: If you are planning to perform a stand alone installation, your application server is automatically installed and configured.

You can choose to prepare a new application server or reuse an existing application server.

Review these prerequisites before you prepare the application server for InfoSphere MDM installation.

- Ensure that you installed any prerequisite software and that the correct environment is set up.
- Set the database utility for DB2 or Oracle to your system path. Microsoft SQL Server does not require this step.
- Review the application server configuration worksheet to understand the basic parameters that are requested during the installation process. Completing the worksheet ensures that you have the basic information necessary to complete the installation. For multiple instances, copy the worksheet and prepare a separate worksheet for each deployment.
- Use the *wasadmin* ID when you prepare the application server.
 - If you are using DB2, this ID must own a DB2 client or a DB2 instance.
 - The ID must be a member of the WebSphere MQ *mqm* group if you are using WebSphere MQ for messaging. This group is used to administer WebSphere MQ.
- Ensure that you set up the *WAS_HOME* and the *JAVA_HOME* Java path for IBM WebSphere Application Server.
- Ensure that there is no server named *server* or cluster named *cluster*.

Important: For custom installations, you must have the WebSphere Application Server deployment manager (Dmgr) JVM Heap size arguments set to 512MB and 1024MB. This is especially important if you plan to install the Product Maintenance UI. To increase the heap size:

1. Open the WebSphere Application Server Integrated Solutions Console and go to **System Administration > Deployment Manager**.
2. Under **Server Infrastructure**, expand **Java and Process Management**, then click **Process definition**.
3. Under **Additional Properties**, click **Java Virtual Machine**.
4. Set the **Initial heap size** to 512 MB and the **Maximum heap size** to 1024 MB.
5. Click **OK**, save your changes, and synchronize your changes with the nodes.

Related tasks:

“Installing InfoSphere MDM into a clustered environment” on page 124

Related reference:

“WebSphere Application Server installation worksheet” on page 33

Preparing WebSphere Application Server Network Deployment for a managed server deployment:

Set up IBM WebSphere Application Server Network Deployment for a managed server deployment.

About this task

Use this procedure for custom InfoSphere MDM installations only.

Note: If you are planning a stand-alone installation, this procedure is not required.

This procedure assumes that you have IBM WebSphere Application Server already installed.

Procedure

1. Create a deployment manager (dmgr).
 - a. Open a command prompt and browse to your IBM WebSphere Application Server installation directory.
 - b. At the command-line prompt, run this command from the *WAS_HOME\bin* directory:

For Microsoft Windows: `manageprofiles.bat -create -profileName dmgrName -profilePath WAS_PROFILE_HOME\dmgrName -templatePath WAS_HOME\profileTemplates\management -serverType DEPLOYMENT_MANAGER -enableAdminSecurity true -adminUserName userName -adminPassword password`

For Linux or UNIX: `manageprofiles.sh -create -profileName dmgrName -profilePath WAS_PROFILE_HOME/dmgrName -templatePath WAS_HOME/profileTemplates/management -serverType DEPLOYMENT_MANAGER -enableAdminSecurity true -adminUserName userName -adminPassword password`
2. Start the deployment manager by running this command from the *WAS_HOME\bin* directory: Microsoft Windows: `startManager.bat -profileName dmgrProfileName` or Linux and UNIX: `startManager.sh -profileName dmgrProfileName`
3. Find out which ports are assigned for the deployment manager.

- a. Open the `profiles/dmgrProfileName/logs/AboutThisProfile.txt` file.
 - b. Find the entry for the Management SOAP connector port and make note of this number.
 - c. Find the entry for the Integrated Solutions Console (admin console) port and make note of this number.
4. Create a node that is attached to the deployment manager by running this command from the `WAS_HOME\bin` directory:

For Microsoft Windows: `manageprofiles.bat -create -profileName profileName -profilePath WAS_PROFILE_HOME\profileName -templatePath WAS_HOME\profileTemplates\managed -hostName hostName -nodeName nodeName -cellName cellName -dmgrHost dmgrHost -dmgrPort dmgrPort -dmgrAdminUserName userName -dmgrAdminPassword password`

For Linux or UNIX: `manageprofiles.sh -create -profileName profileName -profilePath WAS_PROFILE_HOME/profileName -templatePath WAS_HOME/profileTemplates/managed -hostName hostName -nodeName nodeName -cellName cellName -dmgrHost dmgrHost -dmgrPort dmgrPort -dmgrAdminUserName userName -dmgrAdminPassword password`

Where:

- *nodeProfileName* - is name of the node.
 - *username* - is the user you specified in step 1.
 - *password* - is the password you specified in step 1.
 - *dmgrPort* - is the management SOAP connector port number from step 3b.
5. Start the node by running this command from the `WAS_HOME\bin` directory:
Microsoft Windows: `startNode.bat -profileName nodeProfileName` or Linux and UNIX: `startNode.sh -profileName nodeProfileName`
 6. Open IBM WebSphere Application Server Integrated Solutions Console and enable node synchronization.
 - a. Open a browser and go to `https://localhost:port/ibm/console`. The port number is the Integrated Solutions Console port number from step 3c.
 - b. If you encounter a warning that states that the connection is not trusted, you can ignore the message or add an exception as necessary for your browser.
 - c. Log in using the credentials from step 1.
 - d. Browse to **System administration > Console Preferences**.
 - e. Select **Synchronize changes with Nodes** and click **Apply**.
 7. Set the database driver path in the Integrated Solutions Console.
 - a. Go to **Environment > WebSphere variables**.
 - b. For each of the driver path entries that are named for your database type, click the entry. For example: **DB2_JDBC_DRIVER_PATH**, **ORACLE_JDBC_DRIVER_PATH**, or **MICROSOFT_JDBC_DRIVER_PATH**.
 - c. Enter the path to the parent directory of your database client installation directory and click **OK**.

Tip: Replace single slashes with double slashes. For example, if the path is `C:\IBM\SQLLIB`, then enter `C:\\IBM\\SQLLIB`.

- For DB2, use `DB2_HOME/SQLLIB`.
 - For Microsoft SQL Server, use `SQL_PLUS_HOME`.
 - For Oracle, use `ORACLE_HOME/jdbc/lib`.
- d. Select **Save directly to the master configuration**.

Preparing WebSphere Application Server Network Deployment for an unmanaged server:

Set up IBM WebSphere Application Server Network Deployment for an unmanaged server deployment.

About this task

Use this procedure for custom InfoSphere MDM installations only.

If you are planning a stand-alone installation, this procedure is not required.

This procedure assumes that you have IBM WebSphere Application Server already installed.

Procedure

1. Create an unmanaged node on the application server that creates a server named **server1** on the node. Use this command from the *WAS_HOME\bin* directory:
For Microsoft Windows: `manageprofiles.bat -create -profileName nodeProfileName -templatePath profileTemplates\default -federateLater false -dmgrAdminUserName username -enableAdminSecurity true -adminUserName username -adminPassword password`
For Linux or UNIX: `manageprofiles.sh -create -profileName nodeProfileName -templatePath profileTemplates/default -federateLater false -dmgrAdminUserName username -enableAdminSecurity true -adminUserName username -adminPassword password`
When you use an unmanaged server, the name of the node server is **server1**.
2. Start the node with this command from the *WAS_HOME\bin* directory: Microsoft Windows: `startServer.bat -server1` or Linux and UNIX: `startServer.sh -server1`
3. Open the IBM WebSphere Application Server Integrated Solutions Console (admin console) and set the database driver path:
 - a. Go to **Environment > WebSphere variables**.
 - b. For each of the driver path entries that are named for your database type, click the entry. For example: **DB2_JDBC_DRIVER_PATH**, **ORACLE_JDBC_DRIVER_PATH**, or **MSSQLSERVER_JDBC_DRIVER_PATH**.
 - c. Enter the path to the parent directory of your database installation directory and click **OK**. Replace single backslashes with double backslashes. For example, if the path is `C:\IBM\SQLLIB`, then enter `C:\\IBM`.
 - d. Select **Save directly to the master configuration**.

Preparing WebSphere Application Server for base deployment:

Set up IBM WebSphere Application Server for base deployment.

About this task

If you are planning to use a base deployment, IBM Installation Manager creates a IBM WebSphere Application Server profile named *server1*. If you choose to use this profile, you do not have to create one before installation.

Important: Do not register *server1* as a Microsoft Windows service. If you do, then IBM Installation Manager cannot restart *server1* during the process of installing the InfoSphere MDM deployment modules.

Use this procedure for custom InfoSphere MDM installations only.

If you are planning a stand-alone installation, this procedure is not required.

This procedure assumes that you have the application server already installed.

Procedure

1. Create the IBM WebSphere Application Server base profile:
 - To create the base profile using the profile management tool:
 - a. Go to the *WAS_HOME/bin/ProfileManagement* directory and run the profile management tool.
 - For Microsoft Windows, run *pmt.bat*
 - For Linux and UNIX, run *pmt.sh*
 - b. On the Environment Selection panel, click **Application Server** and click **Next**.
 - c. On the Profile Creation Options panel, select **Typical profile creation** and click **Next**.

Tip: Optionally, if you do not want to use the default configuration, select **Advanced profile creation** and provide your configuration details. This procedure assumes a typical profile creation.

- d. On the Administrative Security panel, make sure the **Enable administrative security** option is selected. Add a user name and password, and then click **Next**.
- e. Review the summary and click **Create**. The profile management tool will create a base profile.
- To create the base profile using the command line, run the following command:

Note: Substitute the correct values for *WAS_HOME*, *was_user*, and *was_password*.

```
WAS_HOME/bin/manageprofiles.sh -create -templatePath
WAS_HOME/profileTemplates/default -enableAdminSecurity true
-adminUserName was_user -adminPassword was_password
```

Note: The following optional parameters enable you to provide more detail in the profile creation command:

- If you do not want to use the default profile path, you can add *-profilePath profile_path* into the command.
 - If you do not want to use the default profile name, you can add *-profileName profile_name* into the command.
2. After the base profile is created, start the server. You can use the First Steps console or a command line. For example: */opt/IBM/WebSphere/AppServerBASE/profiles/AppSrv01/bin/startServer.sh server1*

Creating a new user and adding the user to an MDM group:

Use this procedure to create a IBM WebSphere Application Server user and then add that user to an InfoSphere MDM group.

About this task

IBM Installation Manager creates all of the groups and an MDM admin user (mdmadmin) with the required rights and privileges. Use this procedure to add new users.

Restriction: In the event that the mdmadmin user has to be created before the installation (such as if the application server is set up and controlled by a third party and inherits all user accounts from a Federated Repository), then ensure that the mdmadmin password is 16 characters or less. Passwords longer than this will be truncated to 16 characters in the virtual MDM API before being passed to the application server for authentication. As a result, authentication will fail for virtual MDM clients.

Review the user accounts and groups topic for information about available groups.



Procedure

1. In the IBM WebSphere Application Server Integrated Solutions Console (admin console), go to **Users and Groups > Manage Users** and click **Create**.
2. On the Create a User page, type a user ID, name, and password.
3. Click **Group Membership**.
4. On the Group Membership page, search for groups with search key of '*' and click **Search**.
5. In the **Available** column, highlight the groups to which you want the user to belong and click **Add** to move the group to the Mapped To column.
6. On the Group Membership page, click **Close**.
7. On the Create a User page, click **Create**.

Related reference:

"User accounts, groups, and defaults used by the installation application" on page 12

Related information:

-  [Managing users](#)
-  [Enabling user security for the operational server](#)
-  [Configuring users and user groups for virtual MDM](#)

Change the security roles for the channels in MDM:

The security mechanism in MDM has some channel role configurations.

MDM accepts requests from these channels only if the role of the caller is configured in the respective product configurations:

- /IBM/DWLCommonServices/Security/TrustedClientMode/Batch/roles
- /IBM/DWLCommonServices/Security/TrustedClientMode/EventManager/roles
- /IBM/DWLCommonServices/Security/TrustedClientMode/OtherChannels/roles

By default these configurations have the default value mdm_admin. If the new user is created and is not assigned to the mdm_admin role, then a valid role of the created user must be configured by updating these configurations.

For more information, see the 'Defining security services' topic.

Installing and setting up the database

Prepare your database to support a custom installation of InfoSphere MDM. You must complete this procedure if you are running a custom installation.

About this task

Note: If you are planning to perform a stand-alone installation, this task is not required because the database is created automatically.

When you define names for your databases and user accounts, consider giving the associated database instance, user account, and data source configuration the same name. You might also want to include the InfoSphere MDM version in the name. For example, you might name each of these elements `mdmprod_113` for the production database. Using this naming convention can help other members of your organization and IBM Software Support understand the mapping between instances, accounts, and databases.

Procedure

1. Complete the applicable database worksheets that are listed as related reference.
2. Install the database software and create database user accounts with appropriate permissions. Use the documentation provided by the database vendor to complete your installation. Review the database user accounts topic before installing the database software.

Note: Stand-alone server and stand-alone workstation installations install an IBM DB2 wrapper. For custom installations, use the standard DB2 installation media.

3. Optionally, install the Installation Startup Kit. This toolkit provides scripts that you can use to create the MDM database, but is not mandatory.

Note: If you do not install the Installation Startup Kit, then the installation application will display a warning during InfoSphere MDM installation.

4. Create the MDM database using one of the following methods:
 - Run the Installation Startup Kit script that is applicable to your database type. The scripts automatically create the appropriate table spaces, buffer pools, and encoding specifications that are required for your InfoSphere MDM edition. For details about some of these settings, see the related reference topics.
 - Manually create the database using another method.

Note: For details about the required database configuration and settings, see the related reference topics.

Related tasks:

“Installing InfoSphere MDM into a clustered environment” on page 124

“Installing the Installation Startup Kit” on page 73

Related reference:

“DB2 or DB2 for z/OS data source worksheet” on page 27

“Oracle data source worksheet” on page 31

“Microsoft SQL Server data source worksheet” on page 30

“Installation Startup Kit for custom installations” on page 10

Database user accounts and connections:

All installations require at least one database user account.

To bootstrap the database (which is typically done during installation), process an upgrade, define new entity types, or create implementation-defined segments, the database user account must have certain permissions. This primary user account must have permission to:

- Create table and drop table
- Create index and drop index
- Select, insert, update, and delete

After the database is bootstrapped and entity types and implementation-defined segments are configured, you can opt to restrict the user account if required. A restricted user account has only select, insert, update, and delete permissions.

Consider configuring a one-to-one relationship between the database user and the database so that users do not have access to multiple databases. This model provides a security layer that can prevent one database user from dropping the tables of another.

Record the database user account credentials; you need this information to complete the installation.

The database connection count is the sum of connections that are used by the operational server and by any entity managers that you plan to use. Some operational server or InfoSphere MDM Workbench processes also require more database connections, which are closed when the process is completed. Allow more connections for these processes in your configuration.

Related concepts:

“Account prerequisites for custom installations” on page 74

Related reference:

“User accounts, groups, and defaults used by the installation application” on page 12

“Prerequisite checks for custom installations” on page 116

“Prerequisite checks for stand-alone installations with DB2” on page 61

Preparing a DB2 database:

Use this procedure to set up an IBM DB2 database for an installation of InfoSphere MDM.

Before you begin

- These steps assume that the database has already been installed.
- To create the MDM database, you must be logged in to DB2 with the admin user account that you created when you installed DB2.
- You must have the IBM DB2 Enterprise Server edition installed.
- You must have the Installation Startup Kit installed.

About this task

Attention: If you are installing InfoSphere MDM on z/OS, skip the database preparation steps and go to “Installing on z/OS” on page 127.

Procedure

1. Go to the `STARTUPKIT_INSTALL_HOME/CoreData/Full/DB2/Standard/dd1/` directory (where `STARTUPKIT_INSTALL_HOME` is the location of the installed kit).
2. Modify the `CreateDB.sql` script.
 - a. Open the `CreateDB.sql` file in a text editor.
 - b. Replace the variables in the script with values as described at the beginning of the script. Variables are enclosed in `<>`, such as `<DBNAME>`. For example, the `<TERRITORY>` variable in `CreateDB.sql` must be replaced with the appropriate country code. In the case of installations in the United States, replace `<TERRITORY>` with `US`.
3. Change to the DB2 admin user account.

For Microsoft Windows:

- a. Open the **Start** menu and go to **All Programs > IBM DB2 > DB2COPY1** (default).
- b. Press Shift and right-click on **Command Window** and the select **Run as different user...**
- c. Enter the DB2 admin user name and password.

For Linux and UNIX:

- a. Open the Linux or UNIX terminal.
 - b. At the command-line prompt, type `su - user` where `user` is the DB2 admin user.
4. Run the `CreateDB.sql` script to create the database.
 - a. Go to the directory where your `CreateDB.sql` file is located.
 - b. Run the applicable command.
 - **For Microsoft Windows:** `db2 -td; -f CreateDB.sql`
 - **For Linux and UNIX:** `db2 -tvf STARTUPKIT_INSTALL_HOME/database/CoreData/Full/DB2/Standard/dd1/CreateDB.sql`

Important: The remaining steps in this procedure are optional. If you do not wish to manually create the tablespaces, then you can skip the following steps, in which case the installation application will automatically create the tablespaces during installation.

5. Modify the `CreateTS.sql` script.
 - a. Open the `CreateTS.sql` file in a text editor.
 - b. Replace the variables in the script with values as described at the beginning of the script. Variables are enclosed in `<>`, such as `<DBNAME>` or `<TABLE_MDS4K>`.

Attention: The values substituted for variables in this file must match how your database is set up, or the installer will not be able to complete successfully.

- a. Run the applicable command.
 - **For Microsoft Windows:** `db2 -td; -f CreateTS.sql`
 - **For Linux and UNIX:** `db2 -tvf STARTUPKIT_INSTALL_HOME/database/CoreData/Full/DB2/Standard/dd1/CreateTS.sql`
7. After you run `CreateTS.sql`, verify that your table space settings are as you expect.

For Microsoft Windows:

- Open a command prompt and type db2cmd
- Connect to database using this command: db2 connect to *MDMDB* user *DBUSER* using *DB2PWD*
- When you are connected, type: db2 list tablespaces

For Linux and UNIX:

- Open new terminal and type db2
- Connect to database using this command: db2 connect to *MDMDB* user *DBUSER* using *DB2PWD*
- When you are connected, type: db2 list tablespaces

Related tasks:

“Installing the Installation Startup Kit” on page 73

Related reference:

“DB2 or DB2 for z/OS data source worksheet” on page 27

Preparing your DB2 database on a separate server from InfoSphere MDM:

Set up the IBM DB2 database for deployments where the database and InfoSphere MDM installations are on different servers.

Procedure

1. On the machine where you plan to install InfoSphere MDM, you must do the following:
 - a. Install the DB2 client software.
 - b. Catalog the remote database to the local server. Use the following commands, replacing the placeholders with appropriate values:

```
db2 catalog tcpip node <NODE_NAME> remote <DB_SERVER> server <PORT_NUMBER>
db2 catalog db <DB_NAME> as <DB_NAME> at node <NODE_NAME> authentication server
```
2. Use the WebSphere Application Server Integrated Solutions Console to create a DB2_JDBC_DRIVER_PATH WebSphere Application Server environment variable, pointing to the DB2 instance home on the local machine and targeting the node level.

Preparing your DB2 database to use InfoSphere MDM in a clustered environment:

Set up your DB2 database for deployments with InfoSphere MDM in a clustered environment.

Procedure

1. Install the DB2 client software.
2. Catalog the database for every machine in the cluster.
3. Create a DB2_JDBC_DRIVER_PATH WebSphere Application Server environment variable that points to the DB2 home that is present locally on that machine for every node in the cluster.

Related tasks:

“Adding a new node to an existing cluster” on page 164

Configuring database user permissions for DB2 for z/OS:

If your deployment of InfoSphere MDM uses IBM DB2 for z/OS, you must ensure that your database user ID has BINDADD privileges on the MDM database.

About this task

The DB2 Wire Protocol driver does not work properly unless the appropriate packages exist on every server to which you intend to connect. Your database user ID must have BINDADD privileges so that the driver can create and bind packages.

Note: By default, the packages contain 200 dynamic sections and are created in the collection named NULLID.

If the bind packages are not in place, then the following message appears while testing connections for the InfoSphere MDM datasource on the operational server:

```
java.sql.SQLException: [IBM][DB2 JDBC Driver]Bind process is not active.  
Please ensure that the user has permissions to create packages.  
Packages cannot be created in an XA Connection. DSRA0010E: SQL State = HY000, Error Code = 0.
```

Procedure

1. Log in as the database administrator (DBA) user.
2. Connect to the MDM database.
3. Grant BINDADD privileges to the database user (*dbuser*).
4. Log out from the DBA user account.
5. Log in with the database user account. When the database user account connects to the database with the DB2 Wire Protocol driver, the correct package is created automatically.

Related information:

 [The DB2 Wire Protocol Driver and Packages](#)

Bind process is not active

Setting a DB2 utility path:

If you are using an IBM DB2 database, you must set the database utility to your system path.

Procedure

At a command line, add the DB2 database utilities to the PATH variable on your system.

For example:

```
export PATH=DB2_HOME/sql1lib/bin:$PATH
```

What to do next

You can also add the export line to your user profile.

Preparing a Microsoft SQL Server database:

Set up a Microsoft SQL Server database before beginning an installation of InfoSphere MDM.

About this task

To create the MDM database, you must be logged in to Microsoft SQL Server either with Windows Authentication or with the admin user account that you created when you installed Microsoft SQL Server.

If you plan to use Windows authentication, your DBA must set the default schema of the login user to the schema that will be used by IBM Installation Manager.

You must also have the Installation Startup Kit installed before you begin database preparation.

Procedure

1. Modify the CreateDB.sql script that is provided in the Installation Startup Kit.
 - a. Go to the *STARTUPKIT_INSTALL_HOME/CoreData/Full/SQLServer/dd1/directory* (where *STARTUPKIT_INSTALL_HOME* is the location of the installed kit).
 - b. Open the CreateDB.sql file in a text editor.
 - c. Replace the variables in the script with values as described at the beginning of the script. Variables are enclosed in <>, such as <DBNAME>.
2. Run the CreateDB.sql script by using sa user to create the database.

When you use Windows authentication rather than SQL authentication to access database, you must do one of the following options:

 - If the client and SQL Server are in same domain, the login user that the client uses must be added into the SQL Server Security logins
 - If the client and SQL Server are in different domains, then the two domains must be trusted
3. Copy the sqljdbc.dll file to the /Binn directory for the instance of SQL Server that is running.
 - If you are using SQL Server 32-bit, the sqljdbc.dll file is in *STARTUPKIT_INSTALL_HOME/SQLServer JTA/win32*
 - If you are using SQL Server 64-bit, the file is in *STARTUPKIT_INSTALL_HOME/SQLServer JTA/win64_amd64*
4. Install the XA stored procedures that are used by the JDBC driver. From the *STARTUPKIT_INSTALL_HOME/SQLServer JTA* directory, run the instjdbc.sql script as the sa user.
5. Enable MS DTC for XA transactions.

For Windows 7 and Windows 2008

 - a. From the desktop, click the **Start** icon and open Component Services using one of these options.
 - Type dcomcnfg in the **Start Search** box.
 - Type %windir%/system32/comexp.msc in the **Start Search** box.
 - b. Go to **Computers > My Computer > Distributed Transaction Coordinator**.
 - c. Right-click on **Local DTC** and select **Properties**.
 - d. On the Local DTC Properties dialog, open the Security tab.
 - e. Select **Enable XA Transactions** and click **OK**. This step restarts the MS DTC service.
 - f. Click **OK** on the Local DTC Properties dialog and close Component Services.
 - g. Restart Microsoft SQL Server to ensure that it syncs up with the MS DTC changes. Verify that **XATransactions=1** in Microsoft operating system registry.

Related tasks:

“Installing the Installation Startup Kit” on page 73

Related reference:

“Microsoft SQL Server data source worksheet” on page 30

Preparing your Microsoft SQL Server database on a different server than InfoSphere MDM:

Set up your Microsoft SQL Server database when it is on a different server than your InfoSphere MDM installation.

Procedure

Install a Microsoft SQL Server client on the machine where you plan to install MDM.

After you install the client, the client account is automatically added into the database user account. You are not required to set the `MSSQLSERVER_JDBC_DRIVER_PATH` in your IBM WebSphere Application Server environment.

Preparing your Microsoft SQL Server database to use InfoSphere MDM in a clustered environment:

Set up your Microsoft SQL Server database when you are installing InfoSphere MDM in a clustered environment.

Procedure

Install a Microsoft SQL Server client on every machine on which you plan to install InfoSphere MDM components.

After you install the client, the client account is automatically added into the database user account. You are not required to set the `MSSQLSERVER_JDBC_DRIVER_PATH` in your IBM WebSphere Application Server environment.

Preparing an Oracle database:

Set up an Oracle database before beginning an installation of InfoSphere MDM.

Before you begin

- These steps assume that the database has already been installed.
- Optionally, install the Installation Startup Kit.
- To create the MDM database, you must be logged in to Oracle with the database administrator user account that you created when you installed Oracle.
- To install InfoSphere MDM with Oracle, your database user name and schema name must be the same.

Procedure

1. Verify that your character set is UTF-8. If it is not, create your database by using this command: **CREATE DATABASEname...CHARACTER SET AL32UTF8**
2. Set the character length semantics for Unicode. The variable `NLS_LANG_SEMANTICS` must be set to `CHAR` (the default setting is `BYTE`). Run this command: **ALTER SYSTEM SET NLS_LENGTH_SEMANTICS=CHAR SCOPE=BOTH**
3. If you are using a non-wire connect driver with an Oracle client, you must set the `NLS_LANG` variable for the user that is connecting to the operational server. Set the variable to `NLS_LANG=AMERICAN_AMERICA.AL32UTF8`

Important: The remaining steps in this procedure are **optional**. If you do not wish to manually create the tablespaces, then you can skip the following steps, in which case the installation application will automatically create the tablespaces during installation.

4. Modify the `create_schema_ora.sql` script that is provided in the Installation Startup Kit.

- a. Go to `STARTUPKIT_INSTALL_HOME/CoreData/Full/Oracle/Standard/dd1/` directory (where `STARTUPKIT_INSTALL_HOME` is the location of the installed kit).
- b. Open the `create_schema_ora.sql` file in a text editor. The file contains the following variables that must be replaced with appropriate values:
- c. If the database is being created on Microsoft Windows, replace the `<TABLESPACE_LOCATION>` variable with the location of the table spaces. The location value should follow the syntax `<ORACLE_HOME>\<DBNAME>`

Attention: If you are creating a database on Microsoft Windows, you must also change all forward slash characters (`/`) in file paths to backslash characters (`\`).

- d. In the `<ORACLE_HOME>/oradata` folder, create an empty subfolder with a name that matches your `<DBNAME>` value.
- e. Set up the table space names:
 - To use the default table space values, replace the variables in the `create_schema_ora.sql` script with values as described at the top of the script. Variables are enclosed in angle brackets `< >`:
 - `<DBNAME>` - The database name.
 - `<NEWPASSWORD>` - The password for the database.
 - `<INDEX_SPACE>` - The table space name for index data. The installation application expects the value to be `IDXSPACE`.
 - `<LONG_SPACE>` - The table space name for CLOB and XML data types. The installation application expects the value to be `LOBSPACE`.
 - `<TABLE_SPPMD>` - The table space name for Probabilistic Matching Engine user table data. The installation application expects the value to be `EMESPACE1`.
 - `<TABLE_SPPMI>` - The table space name for Probabilistic Matching Engine index data. The installation application expects the value to be `EMESPACE2`.
 - `<TABLE_MDS4K>` - The table space name for 4K user table data. The installation application expects the value to be `TBS4K`.
 - `<TABLE_SPACE>` - The table space name for 8K user table data. The installation application expects the value to be `TBS8K`.
 - `<TABLE_SPMDS>` - The table space name for 16K virtual MDM user table data. The installation application expects the value to be `TBS16K`.
 - To use customized table space names:
 - 1) Create a database that uses your custom table space names.
 - 2) Create or edit an InfoSphere MDM installation input response file and modify the table space name variables so that your custom table space names are mapped to the InfoSphere MDM installer:

```
<data key='user.L2.long.space.ora.com.ibm.mdm.advanced' value='LOBSPACE' />
<data key='user.L2.index.space.ora.com.ibm.mdm.advanced' value='IDXSPACE' />
<data key='user.L2.eme.sppmd.space.com.ibm.mdm.advanced' value='EMESPACE1' />
<data key='user.L2.eme.sppmi.space.com.ibm.mdm.advanced' value='EMESPACE2' />
```

Attention: InfoSphere MDM provides sample installation input response files that you can modify to define customized table spaces. For more information about the sample input response files, see “Silent installation” on page 132.

- 3) Start the InfoSphere MDM installer in either GUI mode or silent mode, including the following argument in the startup command so that the installer uses parameters from your modified input response file: `IBMIM -input ./mdm_input.res` (where `mdm_input.res` is the name of the silent input response file).
5. Run the script `create_schema_ora.sql` to create the Oracle schema.

What to do next

If you omit the execution of the `create_schema_ora.sql` script, then you must alter the Oracle database system:

- Inside the `create_schema_ora.sql` script, make sure that the `ALTER SYSTEM SET open_cursors` statement is set as `ALTER SYSTEM SET open_cursors = 1500 SCOPE=BOTH;`
- Verify that the grants are done specifically as `GRANT CREATE SEQUENCE TO SCHEMA;`, replacing `SCHEMA` with the schema name.
- Configure the Oracle `CURSOR_SHARING` property to `CURSOR_SHARING=FORCE`.

Related tasks:

“Installing the Installation Startup Kit” on page 73

Related reference:

“Oracle data source worksheet” on page 31

Preparing your Oracle database on a different server than InfoSphere MDM:

Set up your Oracle database for deployments where the database and InfoSphere MDM installations are on different servers.

Procedure

1. Install an Oracle client on the machine where you plan to install InfoSphere MDM.
2. Point the TNS entry in the client machine to the database server.
3. Use the WebSphere Application Server Integrated Solutions Console to create an `ORACLE_JDBC_DRIVER_PATH` environment variable that points to the Oracle database home on the local machine and targets the node level.

Preparing your Oracle database to use InfoSphere MDM in a clustered environment:

Set up your Oracle database to support installing InfoSphere MDM in a clustered environment.

Procedure

1. Install the Oracle client on every machine.
2. Point the TNS entry to the database server machine.
3. Create an `ORACLE_JDBC_DRIVER_PATH` WebSphere Application Server environment variable that points to the Oracle database home that is present locally on that machine for every node in the cluster.

Related tasks:

“Adding a new node to an existing cluster” on page 164

Setting an Oracle utility path:

If you are using an Oracle database, you must set the database utility to your system path.

Procedure

At the command line, add the Oracle database utilities to the PATH variable on your system.

For example:

```
export ORACLE_HOME=ORACLE_HOME
export PATH=$ORACLE_HOME/bin:$PATH
```

What to do next

You can also add the export lines to your user profile.

ODBC drivers installed with Standard Edition:

The ODBC drivers that are applied by the installation application when installing InfoSphere MDM Standard Edition are determined by the database type that you define.

A wire driver enables an operational server that supports a virtual MDM configuration to communicate with the database and write data to the schema. In this case, the operational server host requires installation of the applicable database client to enable bulk load operations.

The operational server includes the following ODBC drivers. Other drivers are not supported.

- Oracle Wire
- Oracle Net
- IBM DB2 Wire (DB2 and DB2 for z/OS)
- Microsoft SQL Server Wire

For Oracle databases, the properties passed to the **madconfig** utility during the installation process determine whether to install the Oracle Wire or Oracle Net driver. If empty values are passed for the database host, the Oracle Net driver is installed, which requires installation of the Oracle client on the operational server host.

Tip: When installing on a Microsoft Windows platform, if you want to manually create a separated ODBC data source rather than creating it through the installation application, you must invoke the command `madconfig.bat register_odbc` to ensure that the ODBC driver is registered successfully.

Related tasks:

“Enabling support for Oracle non-wired driver” on page 131

Manually installing the physical MDM database:

You can manually install the physical MDM database on DB2 for UNIX or Linux, DB2 for z/OS, and Oracle.

About this task

You can always use IBM Installation Manager to create the physical MDM database. However, you also have the option to install it manually.

The virtual MDM database is always installed by using IBM Installation Manager.

Attention: The core database is required for InfoSphere MDM Advanced Edition (physical MDM). It is also required for some InfoSphere MDM Standard Edition (virtual MDM) transactions to process correctly. If you use IBM Installation Manager to install InfoSphere MDM, the required core database components are automatically installed. If you are using a Microsoft SQL Server database, be aware that InfoSphere MDM Standard Edition (virtual MDM implementations) is the only edition that is supported for SQL Server.

Before you begin the manual installation, read the following details and make any necessary decisions about creating table spaces and installing triggers.

Table spaces

For DB2 databases on UNIX or Linux and Oracle databases, you can create table spaces for user data, user indexes, and user large objects to improve database performance. Placeholder values are provided in relevant scripts as *TABLE_SPACE*, *INDEX_SPACE*, and *LONG_SPACE*. You can adjust the table space sizes in the provided scripts to the appropriate size for your production environment.

There are two separate table spaces for the InfoSphere MDM Probabilistic Matching Engine, requiring that the InfoSphere MDM Probabilistic Matching Engine table spaces have the same names as *TABLE_SPACE* and *INDEX_SPACE*, but with an additional letter *E* at the end of the table space name.

Triggers

Two types of triggers are provided with the InfoSphere MDM installation: simple triggers and compound triggers. Select one of these types of triggers to install:

- **Simple triggers:** Create a copy of the *before* image of the current data to the HISTORY table when a base table is created, updated, or deleted. The HISTORY table contains only old records; it does not contain the current record in base table. If you choose to install simple triggers, you must install the simple update triggers. You can also install the simple delete triggers, which are optional.
- **Compound triggers:** Create a copy of the *before* and *after* images of the current data from the base table to the HISTORY table when a base table is inserted, updated, or deleted. The HISTORY table contains all old records and the current record in base table. If you choose to install compound triggers, you must install the insert and update triggers. You can also install the compound delete triggers, which are optional.
- **None:** No history triggers will be installed.

Multi-time Zone (UTC)

If your application is running across different time zones, or your data has time values under different time zones, you must enable the multi-time zone feature.

Once this feature is activated, you cannot deactivate it.

If you do not require the multi-time zone feature, you must disable it when you install InfoSphere MDM.

Case sensitive or non-case sensitive search capability

You can add the capability to search for contracts, products, and categories by name, but without case sensitivity restrictions. Once the non-case sensitive feature is activated, you cannot deactivate it. It is available on DB2 UDB, DB2 for z/OS version 9 and later, and Oracle.

Procedure

1. Open IBM Installation Manager and click **Install**.
2. In the Installation Packages list, select **InfoSphere MDM Standard Edition or Advanced Edition** and click **Next**.
3. In the Features list, expand **InfoSphere MDM Standard Edition or Advanced Edition** and ensure that only **MDM Database** is selected. Click **Next**.
4. Complete the Database Configuration fields to provide the database type, location, and connection details, then select **Extract scripts for manual database installation**. Click **Install**. IBM Installation Manager will install virtual MDM data and extract SQL scripts that you can use to install physical MDM data.
5. Run the SQL scripts to install physical MDM data.
6. After the scripts have completed and the physical MDM data is installed, open IBM Installation Manager again and click **Modify**.
7. In the Features list, select **MDM Operational Server**, in addition to the already selected **MDM Database** feature, then click **Next**.
8. Click **Install** to complete the installation of the physical MDM database.

Setting the XA configuration in WebSphere Application Server to connect with DB2 for z/OS:

When manually installing the MDM database on DB2 for z/OS, use this procedure to set the XA configuration in IBM WebSphere Application Server.

About this task

Note: You must change the sample values in this procedure to match your server environment.

Procedure

1. Log in to the UNIX system as the root user and go to the DB2 instance directory. For example: `cd /usr/opt/db2_10_01/instance`
2. Run the following command from the instance directory to create an instance:
`db2icrt -s client db2inst`
3. Log in as the instance user (db2inst1 in this example) after the instance is created and catalog the z/OS database.
4. Copy `db2jcc_license_cisuz.jar` from DB2 for z/OS to the client `<DB2_HOME>/sqllib/java` folder.
5. Add the following line to your CLASSPATH:
`<DB2_HOME>/sqllib/java/db2jcc.jar:<DB2_HOME>/sqllib/java/db2jcc_license_cisuz.jar`

Related tasks:

“Installing the core database manually on DB2 for z/OS by using TSO and JCLs ” on page 99

z/OS database creation and installation:

When you are creating the subsystem and associating databases to it, keep in mind that InfoSphere MDM is developed on DB2 for z/OS with Unicode data and more than one language. You also need to set XA configuration.

To address Unicode, there are two setup options for you to choose from:

- 1. Set up one DB2 for z/OS subsystem with **UNICODE** parameter in the **DSNZPARM**, for example:

```
Unicode CCSID = 1208 CCSID of Unicode UTF-8 data.  
DEF ENCODING SCHEME = UNICODE  
LOCALE LC_CTYPE = UNI  
APPLICATION ENCODING = UNICODE
```
 2. Work with the default DB2 for z/OS subsystem and rebind all MDM packages with Unicode by using `LOCALE LC_CTYPE = UNI.`, which is required for aggregate functions like `UPPER` and `LOWER`.
- If you are using a new DB2 subsystem, set all **DSNZPARM** to Unicode, including the **DSNHDECP** macro parameter **LC_TYPE**. Unicode databases and access plans are required for full functionality.
- Space allocation: before physical objects are created, it is necessary to provide space on DASD. To simplify storage allocation, the recommendation is to use storage groups under SMS. Create HLQ MDMIBM for all z data files.
- Table spaces and index spaces: for easier maintenance and to avoid performance issues, separate tables and their related indexes into different table spaces and index spaces. For small tables, use segmented table spaces; for large tables, use simple table spaces. You can also use partitioned table spaces.
- Authorization and qualifier: Create and access all objects by using one authorization ID.
- Buffer pools: if buffer pools do not exist, you must create them. A minimum size of 1000 is good. A sample SQL statement to create buffer pools is: `ALTER BUFFERPOOL (bp3) VPSIZE (1000);`

XA configuration for DB2 for z/OS

Make sure that you complete the procedure for the WebSphere Application Server JDBC provider and data source. This procedure is necessary for WebSphere Application Server to work properly against DB2 for z/OS.

Granting connection privileges on DB2 for z/OS:

If you are manually installing a physical MDM database on DB2 for z/OS, use this procedure to grant the necessary connection privileges.

Procedure

1. Ensure SYSADM is granted to the installation user for table spaces and initial database creation.
2. Ensure that the following list of privileges is granted to the installation user:

Attention: You must change the sample values in the procedure to match your server environment.

 - `GRANT CREATETAB, CREATETS ON DATABASE DSNCB04 TO <USER_ID>;`
 - `GRANT USE OF BUFFERPOOL BP0 TO <USER_ID>;`
 - `GRANT USE OF STOGROUP SYSDEFLT TO <USER_ID>;`

- GRANT USE OF TABLESPACE DSNDB04.SYSDEFLT TO <USER_ID>;
- GRANT EXECUTE ON PLAN DSNESPCS TO <USER_ID>;
- GRANT EXECUTE ON PLAN DSNESPRR TO <USER_ID>;
- GRANT EXECUTE ON PLAN DSNEDCL TO <USER_ID>;
- GRANT EXECUTE ON PLAN DSNHYCRD TO <USER_ID>;
- GRANT SELECT ON SYSIBM.SYSDUMMY1 TO <USER_ID>;
- GRANT EXECUTE ON PLAN DSNTIA<DB2 VERSION> TO <USER_ID>;
- GRANT EXECUTE ON PROCEDURE SYSPROC.DSNWZP TO <USER_ID>;
- GRANT EXECUTE ON PROCEDURE SYSPROC.DSNWSPM TO <USER_ID>;
- GRANT EXECUTE ON PACKAGE DSNUTILS.DSNUTILS TO <USER_ID>;
- GRANT EXECUTE ON PROCEDURE SYSPROC.DSNUTILS TO <USER_ID>;
- GRANT EXECUTE ON PACKAGE DSNUTILU.DSNUTILU TO <USER_ID>;
- GRANT EXECUTE ON PROCEDURE SYSPROC.DSNUTILU TO <USER_ID>;

Related tasks:

“Installing the core database manually on DB2 for z/OS by using TSO and JCLs ” on page 99

Oracle database setting:

When manually installing the physical MDM database on Oracle, if you omit the execution of the create_schema_ora.sql script then you must alter the Oracle database system.

Inside the create_schema_ora.sql script, make sure that the ALTER SYSTEM SET open_cursors statement is set as:

```
ALTER SYSTEM SET open_cursors = 1500 SCOPE=BOTH;
```

Also verify that the grants are done specially as GRANT CREATE SEQUENCE TO <SCHEMA>;

Manual installation of the physical MDM database on DB2 for Linux or UNIX:

You can manually install the physical MDM database on DB2 for Linux or UNIX.

There are separate instructions for installing the configuration and management database, and the core domain database.

Before you start the installation, read about manual installation of the database.

Installing the core database manually on DB2 for UNIX or Linux:

Install the core physical MDM database on DB2 for UNIX or Linux.

Procedure

1. Go to the `MDM_INSTALL_HOME/database/CoreData/Full/DB2/Standard/dd1` directory.
2. Edit the scripts in this directory by replacing the placeholder values with the values to use in your database.

Remember: To run most scripts, use the command syntax

```
db2 -tvf SCRIPT_NAME -l LOG_FILE_NAME
```

where *SCRIPT_NAME* is the name of the script you are running, and *LOG_FILE_NAME* is the name of the history file where the commands are logged. If you must use a different command syntax, the syntax is shown in the procedure.

Change the placeholder values:

- a. Replace *DBNAME* with the database name you want to use.
 - b. Replace *TERRITORY* with the territory.
 - c. Replace the following tablespace placeholders:
 - *<INDEX_SPACE>* - The tablespace name for index data. The installation application expects the value to be *IDXSPACE*.
 - *<LONG_SPACE>* - The tablespace name for CLOB and XML data types. The installation application expects the value to be *LOBSPACE*.
 - *<TABLE_SPPMD>* - The tablespace name for Probabilistic Matching Engine user table data. The installation application expects the value to be *EMESPACE1*.
 - *<TABLE_SPPMI>* - The tablespace name for Probabilistic Matching Engine index data. The installation application expects the value to be *EMESPACE2*.
 - *<TABLE_MDS4K>* - The tablespace name for 4K user table data. The installation application expects the value to be *TBS4K*.
 - *<TABLE_SPACE>* - The tablespace name for 8K user table data. The installation application expects the value to be *TBS8K*.
 - *<TABLE_SPMDS>* - The tablespace name for 16K virtual MDM user table data. The installation application expects the value to be *TBS16K*.
 - d. Replace *SCHEMA* with the schema name assigned to hold the database assets.
 - e. Replace *DBUSER* with the database user ID that owns the schema.
 - f. Change the *DTYPE* placeholder value to one of the following values in lowercase:
 - banking
 - insurance
 - telco
 - manufacturing
 - g. *CONFIG_LANG* to the configuration language to be used.
For example, for English, use *en*; for French, use *fr*.
 - h. *CODE_LANG* to the language of any additional code table data to be loaded.
For example, for Japanese, use *ja*; for French, use *fr*.
3. Ensure that you have DBA privileges to run the *CreateDB.sql* script.
 4. Create the database and tablespaces, and grant required privileges to authorized users and schemas by running the *CreateDB.sql* file.
 5. Create the tablespaces, and grant required privileges to authorized users and schemas by running the *CreateTS.sql* file. In this script, four extra tablespaces for InfoSphere MDM Probabilistic Matching Engine database objects are created. The names of the two tablespaces are created based on *TABLE MDS4K*, *TABLE_SPACE*, *TABLE_SPMDS*, *TABLE_SPPMI*, *LONG SPACE* and *INDEX_SPACE*. You can change them if you want.
 6. Connect to the database you just created.

7. From the command line in *MDM_INSTALL_HOME/database/CoreData/Full/DB2/Standard/ddl*, run the scripts in the order listed:
 - a. *CreateTables.sql*: Creates all base tables and primary key definitions.
 - b. *CreateTables_H.sql*: Creates all history tables and primary key definitions.
 - c. *CreateIndexes.sql*: Creates all indexes, including unique index constraints.
 - d. *CreateFK.sql*: Creates all foreign keys.
 - e. *CreateCHK.sql*: Creates all check constraints.

8. Determine whether you must enable the multi-time zone feature:

If your application is running across different time zones, or your data has time values under different time zones, you must enable the multi-time zone feature.

If you do not require the multi-time zone feature, you must disable it when you install InfoSphere MDM.

- To enable the multi-time zone feature:
 - a. Go to the *.ddl* subdirectory.
 - b. From the command line, run the script:
Create_function_utc_enabled.sql
- To disable the multi-time-zone feature:
 - a. Go to the *.ddl* subdirectory.
 - b. From the command line, run the script:
Create_function_utc_disabled.sql

9. Run the scripts for either compound triggers or simple triggers.

Remember: To run scripts to create triggers, use the command syntax
db2 -v -td@ -f SCRIPT_NAME -l LOG_FILE_NAME

where *SCRIPT_NAME* is the name of the script you are running, and *LOG_FILE_NAME* is the name of the history file where the commands are logged. If you must use a different command syntax, the syntax is shown in the procedure.

- To install simple triggers, run the script:
 - a. *CreateTriggers_simple.sql*: Installs simple triggers.
 - b. **Optional:** *CreateTriggers_delete_simple.sql*: Installs simple triggers for deletes.
 - To install compound triggers, run the script:
 - a. *CreateTriggers_compound.sql*: Installs compound triggers for inserts and updates.
 - b. **Optional:** *CreateTriggers_delete_compound.sql*: Installs compound triggers for deletes.
10. To populate the code tables with English language data for the industry that is entered in the *DTYPE* placeholder and the configuration data in the language that is entered in the *CONFIG_LANG* placeholder. Run the *ImpReqData.sql* script.
 11. To populate the configuration manager table with English language data, the data path is entered in the *DEL_DATA_PATH* placeholder (if you did not modify the directory location, the path is 'data') and the logs are entered in the *DEL_DATA_LOGS* placeholder. Run the *ImpReqDataCfgMgr.sql* script.

12. Install supplemental sets of code table data. For the industry entered in the *DTYPE* placeholder and for language code that is entered in the *CODE_LANG* placeholder, run the script:

```
ImpCodeTableData.sql
```

Repeat this step for every language you are installing, including English.

13. **Optional:** To enable non-case sensitive searching, run the following script:

```
Insensitive_search_enabled.sql
```

Installing the domain database manually on DB2 for Linux or UNIX:

Manually install the domain database on DB2.

Before you begin

Before you start the installation:

- Make sure that you created the core database, and that you have the correct level of access to it. The domain database assets are added to the same database.
- Read the manual installation of the physical MDM database topic, and make the same decisions on the optional steps as you made when you install the core database.

Procedure

1. Go to the *MDM_INSTALL_HOME/database/Full/DB2/Standard/dd1* directory.
2. Edit all of the scripts in this directory by replacing the placeholder values with the values you want to use in your database as follows:
 - a. Replace *DBNAME* with the database name you want to use.
 - b. Replace *SCHEMA* with the schema name assigned to hold the database assets.
 - c. Replace *TABLE_SPACE* with the table space name where base and history table data are to be stored.
 - d. Replace *INDEX_SPACE* with the table space name where indexed data is stored.
 - e. Replace *LONG_SPACE* with the table space name where long user column data like CLOB and XML is stored.
 - f. Replace *DBUSER* with the database user ID that owns the schema.
 - g. Change the *DTYPE* placeholder value to one of the following values in lowercase:
 - banking
 - insurance
 - telco
 - manufacturing
 - h. *CONFIG_LANG* to the configuration language to be used. For example, for English, use en; for French, use fr.
 - i. *CODE_LANG* to the language of any additional code table data to be loaded. For example, for Japanese, use ja; for French, use fr.

Attention: The *CreateDB.sql* statement creates two separate table spaces for the InfoSphere MDM Probabilistic Matching Engine, as follows: *TABLE_SPACE* and *INDEX_SPACE*.

3. Connect to the core database that you created.

Remember: To run most scripts, use the command syntax

```
db2 -tvf SCRIPT_NAME -l LOG_FILE_NAME
```

where *SCRIPT_NAME* is the name of the script you are running, and *LOG_FILE_NAME* is the name of the history file where the commands are logged. If you must use a different command syntax, the syntax is shown in the procedure.

4. Run the following scripts in the order that they are listed from the command line in *MDM_INSTALL_HOME/database/Full/DB2/Standard/dd1*
 - *CreateTables.sql*: Creates all base tables and primary key definitions.
 - *CreateTables_H.sql*: Creates all history tables and primary key definitions.
 - *CreateIndexes.sql*: Creates all indexes, including unique index constraints.
 - *CreateFK.sql*: Creates all foreign keys.
 - *CreateCHK.sql*: Creates all check constraints.
 - *Create_eME.sql*: Creates all InfoSphere MDM Probabilistic Matching Engine objects. In this script, you must replace the two place holder for real table spaces and the index space name.
5. Run the scripts for either compound triggers or simple triggers:

Remember: To run scripts to create triggers, use the command syntax

```
db2 -v -td@ -f SCRIPT_NAME -l LOG_FILE_NAME
```

where *SCRIPT_NAME* is the name of the script you are running, and *LOG_FILE_NAME* is the name of the history file where the commands are logged. If you must use a different command syntax, the syntax is shown in the procedure.

- To install simple triggers:
 - *CreateTriggers_simple.sql* installs simple triggers
 - **Optional:** *CreateTriggers_delete_simple.sql* installs simple triggers for deletes.
 - To install compound triggers, run the scripts:
 - *CreateTriggers_compound.sql* installs compound triggers for inserts and updates.
 - **Optional:** *CreateTriggers_delete_compound.sql* installs compound triggers for deletes.
6. To populate the code tables with English language data for the industry that is entered in the *DTYPE* placeholder and the configuration data in the language that is entered in the *CONFIG_LANG* placeholder, run the script:
ImpReqData.sql
 7. To populate the configuration manager table with English language data, the data path is entered in the *DEL_DATA_PATH* placeholder (if you did not modify the directory location, the path is 'data') and the logs are entered in the *DEL_DATA_LOGS* placeholder. Run the *ImpReqDataCfgMgr.sql* script.
 8. Install supplemental sets of code table data. For the industry entered in the *DTYPE* placeholder and for language code that is entered in the *CODE_LANG* placeholder, run the script:
ImpCodeTableData.sql

Repeat this step for every language you are installing, including English.

9. If non-case sensitive searching is enabled in the core database, you must run the following script: *Insensitive_search_enabled.sql*.

10. Check the installation log files to verify that the installation is complete.

Manual installation of the physical MDM database on DB2 for z/OS:

You can manually install the physical MDM database on DB2 for z/OS.

Note: The following tasks assume you are installing on AIX client application servers.

Before you start the installation, read the *Manually installing the physical MDM database* topic, including the notes and the information about z/OS database creation and installation, and make you consider all the issues presented.

Installing the core database manually on DB2 for z/OS by using TSO and JCLs :

You can use Job Control Language (JCL) to manually install the InfoSphere MDM core database on DB2 for z/OS.

Before you begin

This task contains a number of placeholder values. Make sure that you have the necessary system information before you begin. Contact your system administrator or developer for this information as necessary.

Create, or ensure that your system administrator or developer has created, a mainframe High Level Qualifier (HLQ) called MDMHLQ with 3 GB of space that is allocated to store all files and libraries for InfoSphere MDM. The HLQ is needed only for installation and can be dropped after you complete the install.

About this task

These steps assume that you are using an AIX client application server.

Tip: The FTP commands defined in the following procedure assume an AIX to z/OS ISPF environment. To work from a different environment, you must convert the commands accordingly.

Procedure

1. Go to the `MDM_INSTALL_HOME/database/CoreData/Full/DB2/ZOS/pds/dd11ib` directory and take the following steps:
 - a. Modify the script `.netrc` to create and transfer the DDLs to the mainframe.
 - b. Replace `USER` with an authorized name to FTP to the mainframe.
 - c. Replace `PASSWORD` with the password for the authorized user.
 - d. Replace `HOSTNAME` with the host name of the mainframe.
 - e. Replace `MDMHLQ` with the HLQ that you created for installation on the mainframe.
 - f. Make sure that the permission of the file is `600`. If it is not, run the command `chmod 600 .netrc`. This `.netrc` file must be inside the `$HOME` directory.
 - g. Run the following command:

```
echo "\$ transferdd1" | ftp hostname
```

The `MDMHLQ.MIHDDL.LIB` library is added to your system on the mainframe.

2. Go to the *MDM_INSTALL_HOME/database/CoreData/Full/DB2/ZOS/pds/jc1lib* directory and take the following steps:
 - a. Modify the script *.netrc* to create and transfer the DDLs to the mainframe.
 - b. Replace *USER* with an authorized name to FTP to the mainframe.
 - c. Replace *PASSWORD* with the password for the authorized user.
 - d. Replace *HOSTNAME* with the host name of the mainframe.
 - e. Replace *MDMHLQ* with the HLQ that you created for installation on the mainframe.
 - f. Ensure that the permission of the file is *600*. If it is not, run the command `chmod 600 .netrc`. This *.netrc* file must be inside the *\$HOME* directory.
 - g. Run the following command:

```
echo "\$ transferjc1" | ftp hostname
```

The *MDMHLQ.MIHJCL.LIB* library is added to your system on the mainframe.

3. Go to the *MDM_INSTALL_HOME/database/CoreData/Full/DB2/ZOS/pds* directory and take the following steps:
 - a. Modify the script *.netrc* to create and transfer the DDLs to the mainframe.
 - b. Replace *USER* with an authorized name to FTP to the mainframe.
 - c. Replace *PASSWORD* with the password for the authorized user.
 - d. Replace *HOSTNAME* with the host name of the mainframe.
 - e. Make sure that the permission of the file is *600*. If it is not, run the command `chmod 600 .netrc`. This *.netrc* file must be inside the *\$HOME* directory.
 - f. Run the following command:

```
echo "\$ transferbins" | ftp hostname
```
4. Log in to TSO on the database server.
5. Using TSO/ISPF, go to *MDMHLQ.MIHDDL.LIB* and edit each of the scripts in the data sets one at a time as follows:
 - a. Replace *DBA ACCOUNT* with a DB account with DBADM authority.
 - b. Replace *USER ACCOUNT* with a user account with the appropriate authority level.
 - c. Replace *STOGROUP_NAME* with the storage group name.
 - d. Replace *db_prefix* with the three-character database prefix assigned by the database administrative authority.
 - e. Replace *VCATNAME* with the actual VCAT name.

For more information, see the CREATE STOGROUP statement in the *MDMHLQ.MIHDDL.LIB* library data set member .

6. Using TSO/ISPF, browse to *MDMHLQ.MIHJCL.LIB* and modify the data set member *MDMICOR* to replace the following placeholder values with appropriate values for use in your database:
 - a. Replace *JOB NAME* with the name of the job.
 - b. Replace *db-hlq* with a valid DSN High Level Qualifier value.
 - c. Replace *SYSTEM* with a valid DB2 Subsystem ID.
 - d. Replace *USRQ* with the High Level Qualifier of the user account.
 - e. Replace *MDMHLQ* with the HLQ that you created for installation on the mainframe.
 - f. Replace *PLANNAME* with DB2 plan for the utility *DSNTEP2*.

- g. Multiple time zone (MTZ) is disabled by default. If you want to ENABLE MTZ, then comment out the line //SYSIN DD DSN=MDMHLQ.MIHDDL.LIB(Z08CRUTE),DISP=SHR inside the JCL MDMICOR (see step 8). For MDMICOR job, return codes of 0 or 4 indicate that the JCL ran successfully.
- h. Submit the MDMICOR JCL by using the sub command. Return codes of 0 or 4 indicate that the JCL ran successfully.

Related tasks:

“Setting the XA configuration in WebSphere Application Server to connect with DB2 for z/OS” on page 92

“Granting connection privileges on DB2 for z/OS” on page 93

Installing the domain database manually on DB2 for z/OS:

Manually install the domain database on DB2 for z/OS by editing several placeholder values.

Before you begin

Before you start the installation:

- Make sure that you created the core database, and that you have the correct level of access to it. The domain database assets are added to the same database.
- Read the manual installation of the physical MDM database topic, and make the same decisions on the optional steps as you made when you install the core database.

This task contains a number of placeholder values. Make sure that you have the necessary system information before you begin. Contact your system administrator or developer for this information as necessary.

In the mainframe, the High Level Qualifier (HLQ) called *MDMHLQ*, has 3 GB of space that is allocated to store all files and libraries for InfoSphere MDM.

About this task

Tip: The FTP commands defined in the following procedure assume an AIX to z/OS ISPF environment. To work from a different environment, you must convert the commands accordingly.

Procedure

1. Go to the MDM/database/Full/DB2/ZOS/pds/dd1lib directory where the WAS.jar was expanded.
2. Modify the script .netrc to create and transfer the DDLs to the mainframe by taking the following steps.
 - a. Change *USER* with an authorized user name to FTP to the mainframe.
 - b. Change *PASSWORD* with the password for that user. Before you run the command, make sure that the permission of the file is 600. If it is not, run the command `chmod 600 .netrc`. This .netrc file must be inside the \$HOME directory.
 - c. Replace *MDMHLQ* with the name of the HLQ that you created for installation on the mainframe.
 - d. Run the following command:

```
echo "\$ transferdd1" | ftp host-name
```

The library *MDMHLQ.MDMJCL.LIB* is added to your system on the mainframe.

3. Go to the *MDM/database/Full/DB2/ZOS/pds/jcllib* directory and modify the script *.netrc* to create and transfer the DDLs to the mainframe by taking the following steps.
 - a. Replace *USER* with an authorized user name to FTP to the mainframe
 - b. Replace *PASSWORD* with the password for that user.
 - c. Change *HOSTNAME* with the host name of the mainframe.
 - d. Replace *MDMHLQ* with the name of the HLQ that you created for installation on the mainframe.
 - e. Make sure that the permission of the file is 600. If it is not, run the command `chmod 600 .netrc`. This *.netrc* file must be inside the *\$HOME* directory.
 - f. Run the following command:

```
echo "\$ transferjcl" | ftp host-name
```

The library *MDMHLQ.MDMJCL.LIB* is added to your system on the mainframe.

4. Log on to TSO on the database server.
5. Using TSO/ISPF, browse to *MDMHLQ.MDMDDL.LIB* and edit each of the scripts in the data sets one at a time to replace the following placeholder values with appropriate values for use in your database:
 - a. Replace *DBA ACCOUNT* with a DB account with DBADM authority. For example, run the CHG command: `CHG 'DBA ACCOUNT' 'DB2OPER' all`
 - b. Replace *USER ACCOUNT* with a user account with the appropriate authority level.
 - c. Replace *STOGROUP_NAME* with the storage group name.
 - d. Replace *db_prefix* with the three-character database prefix assigned by the database administrative authority.
 - e. Replace *MDMHLQ* with the name of the HLQ that you created for installation on the mainframe.
 - f. Replace *VCATNAME* with the actual VCAT name.

For more information, see the CREATE STOGROUP statement in the data set member @01crdb of the *MDMHLQ.MDMDDL.LIB* library.

6. Using TSO/ISPF, go to *MDMHLQ.MDMJCL.LIB* and edit the data set member *MDMIDOM* to replace the following placeholder values with values appropriate to your database:
 - a. Replace *JOB NAME* with the name of the job.
 - b. Replace *db-hlq* with a valid DSN High Level Qualifier value.
 - c. Replace *SYSTEM* with a valid DB2 Subsystem ID.
 - d. Replace *USRQ* with the High Level Qualifier of the user account.
 - e. Replace *PLANNAME* with DB2 plan for the utility DSNTEP2.
 - f. Replace *MDMHLQ* with the name of the HLQ that you created for installation on the mainframe.
 - g. Submit the *MDMIDOM JCL* by using the sub command. Return codes of 0 or 4 indicate that the JCL ran successfully.

Installing the core database manually on Microsoft SQL Server:

Use this procedure to install the full core database manually on Microsoft SQL Server.

About this task

Before you start the installation, read about manual installation of the physical MDM database.

Procedure

1. Go to the *MDM_INSTALL_HOME*/database/CoreData/Full/SQL Server/ddl directory.
2. Edit all of the scripts in this directory by replacing the placeholder values with the values you want to use in your database. Change the following placeholders:
 - *db_name* to the name of the database
 - *MDMSEFG* to the name of the filegroup
 - *Logical_FG_Namex* to the name of the new file to be added to the filegroup and where x is a number starting from 1 if more than one filegroup must be created or added
 - *location* to the location of the filegroup “file”; for example:
 - Microsoft SQL Server 2008R2: C:/Program Files/Microsoft SQL Server/MSSQL10_50.MSSQLSERVER/MSSQL/DATA
 - Microsoft SQL Server 2012: C:/Program Files/Microsoft SQL Server/MSSQL11.DBSQL2/MSSQL/DATA
 - *dbuser* to a database object owner
 - *password* to the dbuser password
 - *schema* to the object owner
 - *CODE_LANG* to the language of any additional code table data to be loaded, for example: for Japanese, use ja or for French, use fr
 - *CONFIG_LANG* to the configuration language to be used; for example, for English, use en or for French, use fr
 - *DTYPE* to the type of data to be loaded; specify one of the following values in lowercase: banking; insurance, manufacturing, telco
 - *mds_home* to the location of your virtual MDM operational server
 - *datasource_name* to the name of your database
 - *dbadmin user* to the name of the database user
 - *dbadmin password* to the password for your database user
3. From the command line in the *MDM_INSTALL_HOME*/database/CoreData/Full/SQL Server/ddl directory, run the commands in the order that they are listed.
 - a. `Sqlcmd -S Server Name -U dbadmin user -P dbadmin password -i Create_DB.sql > logfile name`
 - b. `Sqlcmd -S Server Name -U dbuser -P password -d db_name -i CreateTable.sql > logfile name`
 - c. `Sqlcmd -S Server Name -U dbuser -P password -d db_name -i CreateFK.sql > logfile name`
 - d. `Sqlcmd -S Server Name -U dbuser -P password -d db_name -i CreateIndexes.sql > logfile name`
 - e. `Sqlcmd -S Server Name -U dbuser -P password -d db_name -i CreateCHK.sql > logfile name`
4. Use IBM Installation Manager to load the data. On the features to install panel, select **MDM database**.

Manual installation of the physical MDM database on Oracle:

You can manually install the physical MDM database on Oracle.

Before you start the installation, read manual installation of the physical MDM database topic.

Installing the core database manually on Oracle:

Manually install the core database on Oracle.

Procedure

1. Go to the `MDM_INSTALL_HOME/database/CoreData/Full/Oracle/Standard/dd1` directory.
2. Edit all of the scripts in this directory by replacing the placeholder values with the values you want to use in your database. Change the following placeholders:
 - a. `DBNAME` to the name of the database.
 - b. `SCHEMA` to a database user with the required privileges.
 - c. `NEWPASSWORD` to the password of the schema user.
 - d. Replace the following tablespace placeholders:
 - `<INDEX_SPACE>` - The tablespace name for index data. The installation application expects the value to be `IDXSPACE`.
 - `<LONG_SPACE>` - The tablespace name for CLOB and XML data types. The installation application expects the value to be `LOBSPACE`.
 - `<TABLE_SPPMD>` - The tablespace name for Probabilistic Matching Engine user table data. The installation application expects the value to be `EMESPACE1`.
 - `<TABLE_SPPMI>` - The tablespace name for Probabilistic Matching Engine index data. The installation application expects the value to be `EMESPACE2`.
 - `<TABLE_MDS4K>` - The tablespace name for 4K user table data. The installation application expects the value to be `TBS4K`.
 - `<TABLE_SPACE>` - The tablespace name for 8K user table data. The installation application expects the value to be `TBS8K`.
 - `<TABLE_SPMDS>` - The tablespace name for 16K virtual MDM user table data. The installation application expects the value to be `TBS16K`.
 - e. `TABLESPACE_LOCATION` to the location where the table space is created. This is usually in the database directory that is in `ORACLE_HOME`. For example, `D:/oracle/product/10.2.0/oradata/MDMDB` where `MDMDB` is the name of the database and `10.2.0` is the version of Oracle that is being used.
 - f. `DTYPE` to the type of data to be loaded. Specify one of the following values in lowercase:
 - banking
 - insurance
 - telco
 - manufacturing
 - g. `CONFIG_LANG` to the configuration language to be used. For example, for English use `en`; for French use `fr`
 - h. `CODE_LANG` to the language of any additional code table data to be loaded. For example, for Japanese use `ja`; for French use `fr`

- i. *DBUSER* to a database user with DBA Authority
 - j. *DBPASSWORD* to the password of the dbuser
3. From the command line in *MDM_INSTALL_HOME/database/CoreData/Full/Oracle/Standard/ddl*, run the commands in the order that they are listed:
 - a. `sqlplus DBUSER/DBPASSWORD@DBNAME @create_schema_ora.sql>>`
LOG_FILE_NAME creates the database schema.
 - b. `sqlplus SCHEMA/NEWPASSWORD@DBNAME @create_tables_ora.sql>>`
LOG_FILE_NAME creates the base tables and primary key definitions.
 - c. `sqlplus SCHEMA/NEWPASSWORD@DBNAME @create_hist_tables_ora.sql>>`
LOG_FILE_NAME creates the history tables and primary key definitions.
 - d. `sqlplus SCHEMA/NEWPASSWORD@DBNAME @create_ix_ora.sql>>` *LOG_FILE_NAME* creates all indexes, including unique index constraints.
 - e. `sqlplus SCHEMA/NEWPASSWORD@DBNAME @create_fk_ora.sql>>` *LOG_FILE_NAME* creates the foreign keys.
 - f. `sqlplus SCHEMA/NEWPASSWORD@DBNAME @create_chk_ora.sql>>` *LOG_FILE_NAME* creates the check constraints.
 - g. `sqlplus SCHEMA/NEWPASSWORD@DBNAME @create_eME_ora.sql>>` *LOG_FILE_NAME* creates the InfoSphere MDM Probabilistic Matching Engine objects
 4. If your application is running across different time zones, or your data has time values under different time zones, you must enable the multi-time zone feature. If the multi-time zone feature is not required, you must disable it when you install the database
 - To enable the multi-time zone feature:
 - a. Go to the *.ddl* subdirectory.
 - b. From the command line, run the script:
`sqlplus SCHEMA/NEWPASSWORD@DBNAME`
`@Create_function_utc_enabled.sql >> LOG_FILE_NAME`
 - To disable the multi-time-zone feature:
 - a. Go to the *.ddl* subdirectory.
 - b. From the command line, run the script:
`sqlplus SCHEMA/NEWPASSWORD@DBNAME`
`@Create_function_utc_disabled.sql >> LOG_FILE_NAME`
 5. Run the commands for either compound triggers or simple triggers.
 - To install simple triggers, run the scripts:
 - `sqlplus SCHEMA/NEWPASSWORD@DBNAME @create_triggers_simple_ora.sql>>`
LOG_FILE_NAME installs simple triggers
 - **Optional:** `sqlplus SCHEMA/NEWPASSWORD@DBNAME`
`@create_delete_triggers_simple_ora.sql>>` *LOG_FILE_NAME* installs simple triggers for deletes.
 - To install compound triggers, run the scripts:
 - `sqlplus SCHEMA/NEWPASSWORD@DBNAME`
`@create_triggers_compound_ora.sql>>` *LOG_FILE_NAME* installs compound triggers for inserts and updates.
 - **Optional:** `sqlplus SCHEMA/NEWPASSWORD@DBNAME`
`@create_delete_triggers_compound_ora.sql>>` *LOG_FILE_NAME* installs compound triggers for deletes.
 6. Convert the *ImpReqData.script* file to a shell script, and run the shell script from the command line. This script populates the required code tables and required system configuration tables with English code table data for the

industry that is entered in the *DTYPE* placeholder, and the configuration data in the language that is entered in the *CONFIG_LANG* placeholder.

7. Choose whether to install code table data for languages other than English.

- If you are installing the product in English only, skip this step.
- To install code table data for languages other than English for the industry that is entered in the *DTYPE* placeholder and the language code that is entered in the *CODE_LANG* placeholder, convert the `Imp_CodeTables_Data.script` file to a shell script, and run the shell script from the command line. Repeat this step for each language you want to install.

8. **Optional:** To enable non-case sensitive searching, run the script:

```
sqlplus SCHEMA/NEWPASSWORD@DBNAME @Insensitive_search_enabled.sql >> LOG_FILE_NAME
```

Attention: The `create_schema_ora.sql` statement creates two separate table spaces for the InfoSphere MDM Probabilistic Matching Engine, as follows: *TABLE_SPACE>E* and *INDEX_SPACE>E*

Installing the domain database manually on Oracle:

Manually install the domain database on Oracle by replacing several placeholder values and running a number of commands.

Before you begin

Before you start the installation:

- Make sure that you created the core database, and that you have the correct level of access to it. The domain database assets are added to the same database.
- Read the manual installation of the physical MDM database topic, and make the same decisions on the optional steps as you made when you install the core database.

Procedure

1. Go to the *MDM_INSTALL_HOME/database/Full/Oracle/Standard/ddl* directory:
2. Edit all of the scripts in this directory by replacing the placeholder values with the values you want to use in your database as follows:
 - a. Replace *DBNAME* with the name of the database.
 - b. Replace *SCHEMA* with the schema name assigned to hold the database assets.
 - c. *NEWPASSWORD* to the password of the schema user.
 - d. *TABLE_SPACE* to the table space name where base and history table data will be stored.
 - e. *INDEX_SPACE* to a table space name where indexed data will be stored.
 - f. *LONG_SPACE* to a table space where long user column data like CLOB and XML will be stored
 - g. *TABLESPACE_LOCATION* to the location where the table space will be created. This is usually in the database directory that is in *ORACLE_HOME*. For example, `D:/oracle/product/10.2.0/oradata/MDMDB` where *MDMDB* is the name of the database and 10.2.0 is the version of Oracle being used.
 - h. *DTYPE* to the type of data to be loaded. Specify one of the following values in lowercase:
 - banking

- insurance
 - telco
 - manufacturing
- i. *CONFIG_LANG* to the language to be used. For example, for English use en; for French use fr.
 - j. *CODE_LANG* to the language of any additional code table data to be loaded. For example, for Japanese use ja; for French use fr.
3. From the command line in *MDM_INSTALL_HOME/database/Full/Oracle/Standard/ddl*, run these commands in the order that they are listed:
 - a. `sqlplus SCHEMA/NEWPASSWORD@DBNAME @create_tables_ora.sql>>`
LOG_FILE_NAME creates the base tables and primary key definitions
 - b. `sqlplus SCHEMA/NEWPASSWORD@DBNAME @create_hist_tables_ora.sql>>`
LOG_FILE_NAME creates the history tables and primary key definitions
 - c. `sqlplus SCHEMA/NEWPASSWORD@DBNAME @create_ix_ora.sql>>` *LOG_FILE_NAME* creates all indexes, including unique index constraints
 - d. `sqlplus SCHEMA/NEWPASSWORD@DBNAME @create_fk_ora.sql>>` *LOG_FILE_NAME* creates the foreign keys
 - e. `sqlplus SCHEMA/NEWPASSWORD@DBNAME> @create_chk_ora.sql>>`
LOG_FILE_NAME creates the check constraints
 - f. `sqlplus SCHEMA/NEWPASSWORD@DBNAME @create_eME_ora.sql>>` *LOG_FILE_NAME* creates the InfoSphere MDM Probabilistic Matching Engine objects.

Important: Before you run the `create_eME_ora.sql` script in the next step, edit the script and replace the place holders *TABLE_SPACE* and *INDEX_SPACE* with the table space and index space names created for the InfoSphere MDM Probabilistic Matching Engine database objects.

4. Run the scripts for either compound triggers or simple triggers:
 - To install simple triggers:
 - `sqlplus SCHEMA/NEWPASSWORD@DBNAME @create_triggers_simple_ora.sql>>`
LOG_FILE_NAME installs simple triggers
 - **Optional:** `sqlplus SCHEMA/NEWPASSWORD@DBNAME @create_delete_triggers_simple_ora.sql>>` *LOG_FILE_NAME* installs simple triggers for deletes
 - To install compound triggers, run the scripts:
 - `sqlplus SCHEMA/NEWPASSWORD@DBNAME @create_triggers_compound_ora.sql>>` *LOG_FILE_NAME* installs compound triggers for inserts and updates.
 - **Optional:** `sqlplus SCHEMA/NEWPASSWORD@DBNAME @create_delete_triggers_compound_ora.sql>>` *LOG_FILE_NAME* installs compound triggers for deletes.
5. Convert the `ImpReqData.script` file to a shell script, and run the shell script from the command line. This script populates the required code tables and required system configuration tables with English code table data for the industry that is entered in the *DTYPE* placeholder, and the configuration data in the language that is entered in the *CONFIG_LANG* placeholder.
6. Choose whether to install code table data for languages other than English.
 - If you are installing the product in English only, skip this step.
 - To install code table data for languages other than English for the industry that is entered in the *DTYPE* placeholder and the language code that is entered in the *CODE_LANG* placeholder, convert the

Imp_CodeTables_Data.script file to a shell script, and run the shell script from the command line. Repeat this step for each language you want to install.

7. To populate the configuration manager table with English language data, the data path is entered in the `DEL_DATA_PATH` placeholder (if you did not modify the directory location, the path is `/data`) and the logs are entered in the `DEL_DATA_LOGS` placeholder. Convert the `ImpReqDataCfgMgr.script` file to a shell script, and run the shell script from the command line. This script populates the required system configuration tables with English data.
8. If you enabled non-case sensitive searching in the core database, you must run the following script:

```
Sqlplus SCHEMA/NEWPASSWORD@DBNAME @Insensitive_search_enabled.sql >> LOG_FILE_NAME
```

Preparing a Solaris system for InfoSphere MDM installation

If you are installing on a Solaris operating system, you must complete this procedure before you begin the installation.

About this task

If you do not complete these steps, your InfoSphere MDM installation can potentially take more than 8 hours to complete. The result is that the installation either times out or completes with a corrupted installation.

Procedure

Set the Java virtual machine argument for your deployment manager:

1. Create a WebSphere Application Server profile (Deployment Manager and node).
2. Open the WebSphere Application Server Integrated Solutions Console (admin console) and go to **System Administration > Deployment Manager > Java and Process Management > Process Definition > Java Virtual Machine**.
3. In the **Generic JVM Arguments** field on the Configuration tab, enter the following argument: `-XX:MaxPermSize=384m`. Click **Apply** and **Save directly to the master configuration**.
4. Restart the node and the deployment manager.

On a T-series, complete these steps:

5. Go to `WAS_PROFILE_HOME/deployment manager properties` directory and open the `soap.client.props` file.
6. Change the value of `com.ibm.SOAP.requestTimeout` from 180 to 1800:
`com.ibm.SOAP.requestTimeout=1800`
7. Restart the node and deployment manager.

WebSphere Application Server embedded messaging configuration

The InfoSphere MDM application uses Message Driven Beans (MDBs) that, on startup of the enterprise bundle archive (EBA), look for their associated activation specifications and a JMS provider.

If a JMS provider does not exist, the MDBs timeout and fail to start. To simplify the installation and configuration process, the InfoSphere MDM installation automatically configures a JMS provider and engine.

If you have an existing WebSphere Application Server embedded messaging (message bus) already configured, or if you are installing InfoSphere MDM on z/OS, there are some steps that you must complete before you begin the installation.

If you are installing on z/OS and you do not have an existing messaging bus, then there are steps that you must complete after you install InfoSphere MDM. Post installation configuration is not required for non-z/OS operating systems.

Related tasks:

“Configuring your message bus on z/OS after installation” on page 129

Preparing an existing WebSphere Application Server messaging bus for InfoSphere MDM installation on z/OS:

If you are installing InfoSphere MDM on z/OS, the database user for the InfoSphere MDM installation must have permission to create tables and table spaces. If they do not, the WebSphere Application Server might not successfully create the Service Integration Bus (SIB) tables.

About this task

If you have an existing WebSphere Application Server messaging bus and you are installing with a user that does not have table and table space creation permissions, you must complete these steps before you begin the InfoSphere MDM installation.

If you do not have an existing messaging bus, then proceed with first installing InfoSphere MDM and then completing the steps in “Configuring your message bus on z/OS after installation” on page 129.

Procedure

1. Open WebSphere Application Server Integrated Solutions Console (admin console).
2. Go to **Service Integration > Buses > your application bus > Bus Members**.
3. On the bus members page, click **your application bus member > your application SIB server > Message Store**.
4. Clear the **Create tables** option to prevent WebSphere Application Server from attempting to create the SIB tables.
5. Verify that the **Schema Name** points to your InfoSphere MDM schema. If not, change the schema name.
6. Click **Apply** and then click **Save directly to the master configuration**.
7. Stop the application server.
8. Create the SIB tables for your instance by modifying the ZSIB.sql file for your schema, prefix, and database owner. In the file, replace <SCHEMA> with your schema name, <PREFIX> with your three character prefix, and <DBA ACCOUNT> with your database owner. Run the SQL as DB Owner.
9. Synchronize your nodes and start the application server.

Related tasks:

“Installing on z/OS” on page 127

Preparing an existing WebSphere Application Server messaging bus for InfoSphere MDM installation:

If you are installing on an operating system other than z/OS, the installer can successfully create the SIB tables because special permission is not required. If you are pointing your existing messaging bus to an instance of InfoSphere MDM, ensure that the messaging data source and the schema name in the message store are pointing to the InfoSphere MDM schema.

About this task

Use this procedure to point the messaging schema to the InfoSphere MDM schema before you begin installation.

Procedure

1. Open the WebSphere Application Server Integrated Solutions Console (admin console).
2. Go to **Service Integration > Buses > *your application bus* > Bus Members**.
3. On the bus members page, click ***your application bus member* > *your application SIB server* > Message Store**.
4. Verify that the **Schema Name** points to your InfoSphere MDM schema. If not, change the schema name.
5. Click **Apply** and then click **Save directly to the master configuration**.
6. Synchronize your nodes and restart the application server.

Manually installing the InfoSphere MDM messaging server component

You can use IBM Installation Manager to create the InfoSphere MDM messaging server component, or you can install it manually.

Before you begin

Ensure that you have installed the Installation Startup Kit before you start manually installing the InfoSphere MDM messaging server component.

About this task

Use IBM Installation Manager to install the InfoSphere MDM messaging component if IBM WebSphere MQ is on the same machine as the one on which you plan to run the installer to install the MDM operational server component.

The InfoSphere MDM messaging server component is installed by IBM Installation Manager by default when you choose WebSphere MQ messaging provider rather than WebSphere Application Server default messaging provider on the MDM application configuration panel.

Procedure

1. Obtain the `custSetupMQServer.mqsc` script from the `STARTUPKIT_INSTALL_HOME` directory.
2. Create and start the queue manager to be used by the InfoSphere MDM messaging server component (replace `MDM1011.QMANAGER` with whatever name you choose) by running the script:

```
/usr/mqm/crtmqm MDM1011.QMANAGER
```

Skip this step if you intend to use an existing queue manager.

3. Start the queue manager by running the script:

```
/usr/mqm/strmqm MDM1011.QMANAGER
```

4. Prepare `custSetupMQServer.mqsc` by replacing the `CHANNEL_NAME` placeholder in the `custSetupMQServer.mqsc` script with the actual value of the WebSphere MQ channel to be used.

5. Create the InfoSphere MDM messaging server component configuration objects by running the script:

```
/usr/mqm/runmqsc < $HOME/custSetupMQServer.mqsc MDM1011.QMANAGER
```

Replace the `CHANNEL_NAME` placeholder in the `custSetupMQServer.mqsc` script with the actual value of the WebSphere MQ channel to be used.

6. Enable support for the event broker by running the script:

```
/usr/mqm/runmqsc < /usr/mqm/java/bin/MQJMS PSQ.mqsc MDM1011.QMANAGER
```

7. Start the event broker by running the script:

```
/usr/mqm/strmqbrk -m MDM1011.QMANAGER
```

8. Start the queue listener by running the script:

```
/usr/mqm/runmlsr -m MDM1011.QMANAGER -t TCP -p 1414&
```

You can use any valid port number for the WebSphere MQ listener port.

Related tasks:

“Installing the Installation Startup Kit” on page 73

Set the locale and character encoding on target computers

Globalization settings are automatically set for physical operational servers during installation. For operational servers with virtual configurations, there are some settings that you must manually make after installation.

Unicode settings are made when you run the create database script applicable for your database type. Language settings are made during the installation. Use this procedure to set any additional settings for operational servers if you plan to implement a language other than US English.

Log files that are created by the operational server are in ASCII encoding. Code points that are not encompassed by ASCII are in the standard Unicode form of U+XXXX.

Ensure that the following Unicode items were set by the create database script:

- Microsoft SQL Server: new `MAD_DBTYPE` is “mssql”
- Oracle: `CREATE DATABASE dname...CHARACTER SET AL32UTF8`. You must also set the character length semantics for Unicode. Set the variable `NLS_LANG_SEMANTICS` to `CHAR` (the default setting is `BYTE`). Use the command:

```
ALTER SYSTEM SET NLS_LENGTH_SEMANTICS=CHAR SCOPE=BOTH
```

If you are using a non-wire connect driver with an Oracle client, you must also set this variable for the user who is connecting to the operational server. (A non-wire connect driver uses Oracle client libraries.)

```
NLS_LANG=AMERICAN_AMERICA.AL32UTF8
```

- IBM DB2: `CREATE DATABASE dname USING CODESET UTF-8 TERRITORY territory code`. For example: create database prod using codeset UTF-8 territory us, where prod is the database name and us is the territory.

After you install the MDM operational server, you must manually set the `MAD_ENCODING` variable for your virtual MDM configuration. This variable is set in the `com.ibm.mdm.mds.jni.cfg` configuration file.

Translated strings are stored in the `/smt` directory. These files, such as `fr_FR.smt` or `en_US.smt`, contain the interaction messages that are returned to clients. To set the language for the translated strings, you must also set the `MAD_SMTLIST` environment variable in the `com.initiate.server.system.cfg` configuration file. This variable points to the appropriate `*.smt` file. If you use multiple languages, you can separate the languages with a comma in the variable property.

When the `MAD_SMTLIST` option is set to multiple languages (smtcode), the operational server can potentially load multiple languages (strings) at one time. However, the InfoSphere MDM components display the strings for only one language at a time. For example, the same operational server is configured to send a French client French messages and an English client English messages.

If client software is not configured to use an alternative language, only operational server level information is returned in the chosen language. Translation or globalization of the data that is stored in the MDM database, such as dates, are not converted when displayed in user applications. Rather, this information displays in the locale in which it was received from the source.

Checking prerequisites using the command line tool

Before installing a custom InfoSphere MDM deployment, run the prerequisite checking command line tool that is included with the Installation Startup Kit.

Before you begin

You must install the Installation Startup Kit before you can run the prerequisite checking command line tool.

About this task

The prerequisite checking command line tool helps to prevent you from beginning an installation that will be unable to successfully complete due to missing prerequisites. This tool has the ability to test your environment to ensure that the expected prerequisites are in place, and also to collect basic and extended data from logs, configuration files, and metadata stored in the database.

Note: The prerequisite checking command line tool includes functionality provided by the IBM Support Assistant Data Collector.

Procedure

1. Navigate to the Installation Startup Kit prerequisite checker directory, `STARTUPKIT_INSTALL_HOME\MDMStartupKit\prereq_checker\MDMCollector\isadc`.
2. Run the prerequisite checking script:
 - On Microsoft Windows, run `isadc.bat`.
 - On Linux or UNIX, run `isadc.sh`.

The prerequisite checking command line tool will guide you through the steps to:

- Check for installation prerequisites.
- Collect basic data.
- Collect extended data.

Related concepts:

“Account prerequisites for custom installations” on page 74

Related tasks:

“Installing the Installation Startup Kit” on page 73

Related reference:

“Installation Startup Kit for custom installations” on page 10

“Prerequisite checks for custom installations” on page 116

Installing a custom deployment of InfoSphere MDM

Use this procedure to run a custom installation. A custom installation is the required method if you are using an Oracle or Microsoft SQL Server database or if you are installing in a clustered environment. You can also use a custom installation if you are using IBM DB2 database.

Before you begin

Make sure that you meet these prerequisites:

- You have completed all of the installation preparation tasks, including preparing your IBM WebSphere Application Server and database.
- You have installed IBM Installation Manager and added the necessary repositories.
- Your IBM WebSphere Application Server deployment manager and node are started.
- Your database is started.
- You have installed IBM Rational Application Developer if you are installing InfoSphere MDM Workbench on a workstation.
- Optionally, you have installed the Installation Startup Kit, which includes scripts and other tools to help with your installation and configuration. If the Installation Startup Kit is not installed, then the installation application will display a warning.

If you are installing on Microsoft Windows:

- You must be running in Administrator mode for IBM Installation Manager to write to the Windows registry. Administrator mode is not used for IBM AIX, Linux, or Solaris.
- On a Microsoft Windows 7 operating system, you must install MDM into a directory that is not virtualized.

Important: For custom installations, you must have the WebSphere Application Server deployment manager (Dmgr) JVM Heap size arguments set to 512MB and 1024MB. This is especially important if you plan to install the Product Maintenance UI. To increase the heap size:

1. Open the WebSphere Application Server Integrated Solutions Console and go to **System Administration > Deployment Manager**.
2. Under **Server Infrastructure**, expand **Java and Process Management**, then click **Process definition**.
3. Under **Additional Properties**, click **Java Virtual Machine**.
4. Set the **Initial heap size** to 512 MB and the **Maximum heap size** to 1024 MB.
5. Click **OK**, save your changes, and synchronize your changes with the nodes.

About this task

Note: If you are installing a clustered deployment, skip directly to Installing in a clustered environment.

Note: If you are installing on a z/OS system, skip directly to “Installing on z/OS” on page 127.

If you have IBM Rational Application Developer installed, make sure that you do not install InfoSphere MDM into the same package group.

Procedure

1. Review the prerequisites listed earlier in this topic and ensure that you have completed all of the necessary preparation steps. These steps are not optional.
2. Start IBM Installation Manager.
3. On the IBM Installation Manager home screen, click **Install**.
4. On the Install Packages panel, select the InfoSphere MDM edition and any additional packages that you may require (such as Workbench, if you are installing a workstation). Click **Next**.

Tip: If you do not select the Installation Startup Kit, or have not previously installed it, then the installation application will display a warning. However, you can still proceed with the installation.

5. Review and accept the license agreement, then click **Next**.
6. Choose whether to install into an existing package group or create a new package group.

Tip: If you are unsure of what to choose, then accept the default. Most installations should create a new package group.

Important: If you have IBM Rational Application Developer installed, make sure that you do not install InfoSphere MDM into the same package group. Select **Create a new package group**.

7. On the same panel, define the **Installation Directory** into which you want to install each component. If you choose to install a component in a directory other than the default, select that component and click **Browse** in the **Installation Directory** field.

Review the disk space information, then click **Next**.

8. On the language panel, English is always selected.
 - a. If you want to support any languages in addition to English, select them.
 - b. Some packages support more languages than others. If you want more languages, click the twistie for **Translations Supported by Only Some Packages** and select each additional language that you want.
 - c. Click **Next**.
9. On the features panel, select the InfoSphere MDM features, applications, and optional components to install and click **Next**.
10. On the next set of panels, enter the configuration information:

Tip: Use your completed installation worksheets for guidance. As you move through each of these configuration panels, the screen displays a green checkmark or red x to indicate whether the panel has been completed successfully.

- a. On the Database Configuration panel:
 - Enter the database details. If your database home value is valid, then the **Test Connection** button becomes active.
 - Click **Test Connection**. The database must be accessible and running for the test to be successful.
 - After a successful connection test, you can set up tablespaces. Select either **Use existing tablespaces** or **Create new tablespaces**. If you choose to create new tablespaces, then you must define the new names.
- b. On the History Configuration panel, select the industry, triggers, and language options necessary for your business requirements.
- c. On the WebSphere Application Server Configuration panel:
 - Enter the information that you used to set up your application server.
 - Select **Retrieve Host Details** to obtain your cell, node, and server information. Use each drop down list to select the retrieved cell, node, and server. If you need to provide a different value, you can type it in the field.
 - Click **Verify MDM Instance on Server**.
- d. On the Application Configuration panel:
 - Provide the new application name, user password, and RMI port. The installation application will use these details to set up InfoSphere MDM.
 - Select either **Probabilistic matching** or **Deterministic matching** for your matching style.
 - If your application is running across different time zones or your data has time-sensitive values under different time zones, select **Enable multiple time zone deployment** and select a **Default time zone**.
 - Select the messaging type to use for this installation. If you select IBM WebSphere MQ, then you will be asked to provide the details of your WebSphere MQ instance.

Tip: If you installed WebSphere MQ on a different machine than the one where you are running IBM Installation Manager, make sure that you clear the **Configure messaging server** option to prevent the installer from creating a queue manager. Keep the option selected if you do want to create a queue manager.

- e. On the Install Configuration Review panel:
 - Select the install type. You can either choose to automatically configure the application components as part of the main installation process or run scripts after the main installation to configure them later.

Note: See the related topics at the end of this page for more information about separating the configuration from the installation.

- Expand the Properties headings to review the details that you have configured for this installation.
- Click **Verify Installation Requirements** to run a number of prerequisite checks. The checks will help you to confirm that your environment and configuration is sufficient to successfully complete the installation.
- Review the prerequisite validation test results. Click **Show details** to see more information of for each test, and follow the provided links to view the log file and help for each result.

Tip: You can ignore warnings by clicking **Show details**, then selecting **Ignore the warning. I understand the risks**. Errors cannot be ignored.

- If necessary, take any corrective action to address any warnings or errors, then click **Recheck Status**.
- When the checks pass successfully, click **Install**.

The installation application will install InfoSphere MDM. Depending on your configuration, the installation process can take a significant amount of time.

11. On the final IBM Installation Manager panel, click **View Log Files** if you want to open the log file viewer.
12. Click **Finish**, then close IBM Installation Manager.

Results

A success message on the final installer panel indicates that the verification tests were automatically run as part of the installation process. You can also view the log files to verify a successful installation. If the installation is not successful, view the log files and use the information in the troubleshooting topics to assist you.

What to do next

After installation, if you want to add or remove a feature (for example, add an application or another language translation), or modify any of your configuration settings, you can run IBM Installation Manager again and select **Modify**.

Related concepts:

“Custom installation deployment type” on page 24

“Worksheets for installation and configuration” on page 26

“Verifying the base installation” on page 159

Related tasks:

“Preparing for a custom deployment” on page 71

“Installing on z/OS” on page 127

Troubleshooting an installation

Prerequisite checks for custom installations

The InfoSphere MDM installer application runs tests to ensure that certain prerequisites are in place before each custom installation begins.

The prerequisite checking tool helps to prevent you from beginning an installation that will be unable to successfully complete due to any missing prerequisites.

Tip: Run the prerequisite checks from within Installation Manager from the Installation Configuration Review panel by clicking **Verify Installation Requirements**.

When running a custom installation, the installation application runs the following prerequisite checks.

Table 21. System checks

Prerequisite check	Description	Resolution
Installation disk space verification	This check validates that there is sufficient disk space to install InfoSphere MDM in the <code>MDM_INSTALL_HOME</code> directory.	Ensure that there is at least 2 GB of disk space available in the <code>MDM_INSTALL_HOME</code> location.

Table 21. System checks (continued)

Prerequisite check	Description	Resolution
Memory verification for running the installation application	This check validates that there is sufficient memory to run the installation. This message is a warning only.	Ensure that the system that you are installing on has at least 8 GB of RAM. Note: You can choose to ignore this warning, but the installation may fail.

Table 22. Database checks

Prerequisite check	Description	Resolution
Database version verification	This check validates that the database version is supported.	Ensure that the database for this installation is one of the database versions listed in the InfoSphere MDM system requirements.
Disk space verification for the database	This check validates that there is sufficient disk space available for the MDM database in the default database location (the database home folder).	Ensure that there is at least 6 GB of disk space for the database. Note: This requirement only considers the basic disk space requirements for database creation.
Database parameters verification	This check validates that all of your database connection credentials (such as host, port, user, and password) are correct by attempting to connect to the database. This check also validates that the character set for the database is Unicode (UTF-8).	Ensure that the specified database user can connect to the database using the host name, port, and specified database credentials. Each of these parameters must be correct, and the required JARs must be available to connect the client to the database server. <ul style="list-style-type: none"> • For DB2 databases, ensure that your codeset is UTF-8. • For Oracle databases, ensure that the value of NLS_CHARACTERSET is AL32UTF8. For details about the specific reasons that this check failed, refer to the log file.
Database buffer pools verification	This check determines whether the database buffer pools meet the InfoSphere MDM system requirements.	Ensure that the database buffer pools meet the InfoSphere MDM system requirements. For details about the specific reasons that this check failed, refer to the log file.

Table 22. Database checks (continued)

Prerequisite check	Description	Resolution
Database user permission verification	This check validates that the specified database user exists and has the required permissions.	<p>Ensure that the database user being used for the installation has all of the required permissions.</p> <p>For details about the specific reasons that this check failed, refer to the log file.</p> <p>MDM database users must have the ability to create and edit tablespaces, tables, triggers, functions, views, procedures, and sequences. For details about the required database permissions, install the InfoSphere MDM Startup Toolkit and refer to the operations run by the database setup scripts:</p> <ul style="list-style-type: none"> • DB2: <code>STARTUP_TOOLKIT_HOME\database\CoreData\Full\DB2\Standard\ddl\CreateTS.sql</code> • Oracle: <code>STARTUP_TOOLKIT_HOME\database\CoreData\Full\Oracle\Standard\ddl\create_schema_ora.sql</code> <p>Note: Permissions are specific to DB2 and Oracle.</p>
Tablespace definition verification	This check validates that the required database tablespaces are present in the database.	<p>Ensure that the tablespaces are correct.</p> <p>Refer to the log file for information about the missing tablespaces.</p> <p>Note: Tablespaces are specific to DB2 and Oracle.</p>

Table 22. Database checks (continued)

Prerequisite check	Description	Resolution
ODBC datasource verification	<p>This check determines whether an ODBC datasource exists in a Microsoft Windows registry. This check will fail with an error if an ODBC datasource already exists.</p> <p>Note: For non-Windows systems, this check will always pass.</p>	<p>If an ODBC datasource exists in your Windows registry, remove the datasource:</p> <ol style="list-style-type: none"> 1. Open the Windows Registry Editor by running the command <code>regedit</code>. 2. Find the entry <code>HKEY_LOCAL_MACHINE\SOFTWARE\ODBC\ODBC.INI</code>. 3. Expand <code>ODBC.INI</code>, locate the ODBC datasource entry, then right-click it and select Delete. 4. Under <code>ODBC.INI</code>, select the ODBC Data Sources entry. In the display pane, all of the subentries are shown. 5. Locate the ODBC datasource entry in the list of subentries. Right-click the entry and select Delete.
Database state verification	<p>This check validates that there are no preexisting MDM data tables in the database schema. If the schema is already populated, then a warning message is displayed.</p> <p>Tip: Do not attempt to install InfoSphere MDM into a database that is already populated with MDM data. Installing over an existing database can result in the data being lost if there is an installation failure.</p>	<p>Ensure that your database starts with an empty schema before installing InfoSphere MDM. The installation will create the MDM tables.</p> <p>If you intend to perform an upgrade installation, refer to the <i>Upgrading from a previous version</i> topic (see the related links at the end of this topic).</p> <p>Note: You can choose to ignore this warning, but data may be lost if the installation fails.</p>

Table 23. Operational server checks

Prerequisite check	Description	Resolution
WebSphere Application Server version verification	<p>This check validates that the correct version of WebSphere Application Server is installed and available.</p> <p>There are two potential failure scenarios for this validation:</p> <ul style="list-style-type: none"> • <i>Not connected</i> - The installation verification tool cannot connect to WebSphere Application Server. • <i>Old version</i> - The WebSphere Application Server version is not supported. 	<p>If the failure message indicates that the validation check cannot connect, double-check the connection details that you specified. The log file indicates the reasons that the connection failed.</p> <p>If the failure message indicates that the version is not supported, then you must install the correct version of WebSphere Application Server. The log file indicates both the detected version and the required version.</p>

Table 23. Operational server checks (continued)

Prerequisite check	Description	Resolution
Disk space verification for the profile	This check validates that there is sufficient disk space to install the InfoSphere MDM operational server in the <i>MDM_INSTALL_HOME</i> location. A failure of this validation prompts a warning.	Ensure that there is enough disk space available in the <i>MDM_INSTALL_HOME</i> location. The required amount of disk space varies depending on the features that you choose to install. For details about the specific requirements for your installation, refer to the log file. Note: You can choose to ignore this warning, but the installation may fail.
SOAP connection timeout verification	This check validates that the <code>soap.client.props</code> file is present and that the SOAP connection timeout value (<code>com.ibm.SOAP.requestTimeout</code>) is sufficient. A failure of this validation prompts a warning.	If the warning message indicates that the <code>soap.client.props</code> file is not found, then refer to the log file for details. If the warning message indicates that the SOAP connection timeout value is not long enough, set the value of <code>com.ibm.SOAP.requestTimeout</code> to one of the following values: <ul style="list-style-type: none"> • a number greater than or equal to 1800 • 0, which indicates that there will be no timeout Note: You can choose to ignore this warning, but the installation may fail.
WebSphere Application Server status verification	This check validates that WebSphere Application Server is running.	Ensure that WebSphere Application Server is running. Refer to the log file for details about the reason that this check failed.

Related tasks:

“Checking prerequisites using the command line tool” on page 112

Related reference:

“Database user accounts and connections” on page 82

Related information:

 [InfoSphere MDM system requirements](#)

 [Upgrading from a previous version](#)

Separating configuration from installation

The InfoSphere MDM installation application enables you to install or modify the product while generating configuration properties files that you can use to configure the product at a later point in time.

About this task

The standard InfoSphere MDM installation process involves configuring key properties of the deployment at the same time as the installation occurs. However, with the separation feature, you can separate the installation from the configuration of application properties, the database, user interfaces, and other key properties and variables.

Restriction: The configuration separation capability is only available if you are using the custom installation type. Stand-alone installations with DB2 do not support separating configuration from installation.

When you select the option to separate the configuration from installation, the installation application will generate a number of properties files that track the selections you have made in the IBM Installation Manager session. These properties files are stored in *MDM_INSTALL_HOME/properties*. You can manually edit these generated properties files to change the product configuration, and then use scripts to apply the new configuration to an existing instance without having to complete a full reinstallation.

The configuration separation capability can also be used when you modify an installed product to include new components. Once the separation option is selected, you must always follow an IBM Installation Manager **Modify** session by running the *madconfig* script to complete the modification.

Procedure

1. Start the Launchpad or IBM Installation Manager to start the custom installation. Complete the installation application panels to provide the details of your deployment as normal.
2. On the Install Configuration Review panel, under **Install Type**, select the option to **Manually run the scripts to configure InfoSphere MDM components after installation**.
3. Click **Verify Installation Requirements** to run the installation verification checks.
4. Correct any verification check errors, and then click **Install** to run the installation. When the installation completes, InfoSphere MDM will be installed and the installation application will have generated some or all of the following properties files, depending on the features that you selected to install, in *MDM_INSTALL_HOME/properties*:

db.properties

When the MDM Database feature is installed through IBM Installation Manager, this properties file is created. It contains the configuration details of your database instance.

app.properties

When the MDM Application feature is installed through IBM Installation Manager, this properties file is created. It contains the configuration details of your InfoSphere MDM operational server instance.

<user interface>.properties

Depending on the user interface application components that you selected in IBM Installation Manager, a number of properties files are created. These files contain the configuration details of your InfoSphere MDM user interface application components.

MDM_isInstalled.properties

This property file stores configuration information about what InfoSphere MDM components are installed. This file has a key/value pair for each component that tracks whether each feature is installed (YES) or not (NO).

MDM_Rollback.properties

This property file is used in case of serious errors that cause the installation to be rolled back. It stores details about each InfoSphere MDM component and the state of that feature. This file has a key/value pair for each component that tracks whether each feature is successfully installed (YES), partially installed (PARTIAL), or not installed (NO).

If the status of any component is PARTIAL due to an error that the installation application encountered, then after the error has been corrected and the installation is rerun, the installation application will roll back only the partially installed component and rerun the installation for that and any other failed components.

This file also maintains the set of targets that are run while installing each component. These targets help to manage the rollback process.

MDM_Variables.properties

This property file is the default property file created during any InfoSphere MDM installation. The value of the property `user.L2.mdm.feature.list` contains a list of features that were selected in IBM Installation Manager.

5. If a configuration change is required, edit one or more of the properties files in `MDM_INSTALL_HOME/properties` to reflect the needed change.
6. Run the following madconfig script to apply the new configuration defined in the properties files:
 - On Microsoft Windows systems, run
`madconfig.bat Configure_MasterDataManagement`
 - On Linux or UNIX systems, run
`madconfig.sh Configure_MasterDataManagement`

Tip: If you encounter any issues while running the configuration script, review the log files and take steps to correct the problem, then rerun the script. The InfoSphere MDM product is reconfigured by the madconfig script based on the values in the properties files.

7. Optional: To remove an entire product configuration that was applied using the `Configure_MasterDataManagement` madconfig script, run the following madconfig script to remove all configuration files.
 - On Microsoft Windows systems, run
`madconfig.bat Uninstall_MDM`
 - On Linux or UNIX systems, run
`madconfig.sh Uninstall_MDM`

Important: Be careful about running the `Uninstall_MDM` madconfig script. Running `Uninstall_MDM` removes the configuration of all features, and not just the configuration of a particular component.

8. Optional: To remove an individual feature configuration that was applied using the `Configure_MasterDataManagement` madconfig script:
 - a. Open IBM Installation Manager and select **Modify**.

- b. Remove the feature on the feature selection panel.
- c. Run the madconfig script to configure the new product configuration:
 - On Microsoft Windows systems, run
madconfig.bat Configure_MasterDataManagement
 - On Linux or UNIX systems, run
madconfig.sh Configure_MasterDataManagement

Related concepts:

“Installing client applications and individual components” on page 149

Related tasks:

“Modifying your installation” on page 163

Configuration separation scenarios:

The scenarios in this topic are a few examples of instances when the configuration separation scripts are useful.

Modifying the installation to add components

Scenario

- During the initial IBM Installation Manager session, the MDM Database and MDM Application features were installed and configured.
- At a later time, the installer decides that this InfoSphere MDM instance additionally requires the Business Administration UI application and the Data Stewardship UI application.

Remedy

- Run IBM Installation Manager in **Modify** mode and complete the panels to add the Business Administration and Data Stewardship features.
- Run the Configure_MasterDataManagement madconfig script.

Result The InfoSphere MDM instance is configured by the script to use the additional user interface applications.

Fixing an installation after a failure leaves a partially installed component

Scenario

- During the initial IBM Installation Manager session, the MDM Database and MDM Application features were installed and the **Manually run the scripts to configure InfoSphere MDM components after installation** option was selected.
- To configure the components, the Configure_MasterDataManagement madconfig script was run.
- While configuring the MDM database, an error occurred and the installation stopped, leaving the MDM Database partially installed.

Remedy

Review the logs and fix the issue, then rerun the Configure_MasterDataManagement madconfig script.

Result When the script is rerun, the partially installed MDM Database component is uninstalled and then reinstalled with the fresh configuration. The MDM Application is also configured.

Rolling back a failed component installation and reconfiguring the component

Scenario

- During the initial IBM Installation Manager session, the MDM Database and MDM Application features were installed and the **Manually run the scripts to configure InfoSphere MDM components after installation** option was selected.
- To configure the components, the `Configure_MasterDataManagement madconfig` script was run.
- The MDM Database installed successfully, but an error occurred while installing the MDM Application component and the installation stopped, leaving the MDM Application partially installed.

Remedy

Review the logs and fix the issue, then rerun the `Configure_MasterDataManagement madconfig` script.

Result When the script is rerun, the partially installed MDM Application component is rolled back and then reinstalled with the fresh configuration. The MDM Database component is left untouched, since it was correctly configured during the first attempt.

Installing InfoSphere MDM into a clustered environment

Use this procedure to run a custom installation of InfoSphere MDM into a clustered environment.

Before you begin

Make sure that you meet these prerequisites:

- You have completed all of the installation preparation tasks, including preparing your IBM WebSphere Application Server and database.
- You have installed IBM Installation Manager and added the necessary repositories.
- Your IBM WebSphere Application Server deployment manager and node are started.
- Your database is started.
- You have installed IBM Rational Application Developer if you are installing InfoSphere MDM Workbench on a workstation.
- Optionally, you have installed the Installation Startup Kit, which includes scripts and other tools to help with your installation and configuration. If the Installation Startup Kit is not installed, then the installation application will display a warning.

If you are installing on Microsoft Windows:

- You must be running in Administrator mode for IBM Installation Manager to write to the Windows registry. Administrator mode is not used for IBM AIX, Linux, or Solaris.
- On a Microsoft Windows 7 operating system, you must install MDM into a directory that is not virtualized.

Important: For custom installations, you must have the WebSphere Application Server deployment manager (Dmgr) JVM Heap size arguments set to 512MB and 1024MB. This is especially important if you plan to install the Product Maintenance UI. To increase the heap size:

1. Open the WebSphere Application Server Integrated Solutions Console and go to **System Administration > Deployment Manager**.

2. Under **Server Infrastructure**, expand **Java and Process Management**, then click **Process definition**.
3. Under **Additional Properties**, click **Java Virtual Machine**.
4. Set the **Initial heap size** to 512 MB and the **Maximum heap size** to 1024 MB.
5. Click **OK**, save your changes, and synchronize your changes with the nodes.

About this task

Tip: Review the installation scenarios before you begin a clustered installation. While the scenarios might not exactly fit your environment, they can offer a guideline for installation.

Procedure

1. Review the prerequisites listed earlier in this topic and ensure that you have completed all of the necessary preparation steps. These steps are not optional.
2. Verify that these items are completed for your application server:
 - a. WebSphere Application Server is installed on each required machine in your cluster.
 - b. The necessary clusters are created in WebSphere Application Server.
 - c. If you are using a DB2 or Oracle database, you must set the `JDBC_DRIVER_PATH` environment variable.
 - d. Synchronize all managed nodes.
 - e. Note the WebSphere Application Server host name and port in your installation worksheet.
3. Verify that your database and database client software are installed on the necessary machines, and that the database is started.
4. If you are using IBM WebSphere MQ messaging, complete these steps for each machine in the cluster. If you are using IBM WebSphere Default Messaging, continue to the next step.
 - a. Verify that WebSphere MQ is installed.
 - b. Run the `custSetupMQServer.mqsc` and `ChannelAuth.mqsc` scripts to create the WebSphere MQ queue manager, channel, and queues. These scripts are part of the Installation Startup Kit.
5. Open IBM Installation Manager and click **Install**.
6. On the Install Packages panel, select the edition and click **Next**.
7. Continue through the prompts to accept the license agreement, select an installation location, and select languages.
8. Configure your InfoSphere MDM installation details:

Tip: Use your completed installation worksheets for guidance. As you move through each of these configuration panels, the screen displays a green checkmark or red x to indicate whether the panel has been completed successfully.

- a. On the Database Configuration panel:
 - Enter the database details. If your database home value is valid, then the **Test Connection** button becomes active.
 - Click **Test Connection**. The database must be accessible and running for the test to be successful.

- After a successful connection test, you can set up tablespaces. Select either **Use existing tablespaces** or **Create new tablespaces**. If you choose to create new tablespaces, then you must define the new names.
- b. On the History Configuration panel, select the industry, triggers, and language options necessary for your business requirements.
- c. On the WebSphere Application Server Configuration panel:
 - Enter the information that you used to set up your application server.
 - Select **Retrieve Host Details** to obtain your cell, node, and server information. Use each drop down list to select the retrieved cell, node, and server. If you need to provide a different value, you can type it in the field.
 - Click **Verify MDM Instance on Server**.
- d. On the Application Configuration panel:
 - Provide the new application name, user password, and RMI port. The installation application will use these details to set up InfoSphere MDM.
 - Select either **Probabilistic matching** or **Deterministic matching** for your matching style.
 - If your application is running across different time zones or your data has time-sensitive values under different time zones, select **Enable multiple time zone deployment** and select a **Default time zone**.
 - Select the messaging type to use for this installation.
If you select IBM WebSphere MQ, then you will be asked to provide the details of your WebSphere MQ instance.

Tip: If you installed WebSphere MQ on a different machine than the one where you are running IBM Installation Manager, make sure that you clear the **Configure messaging server** option to prevent the installer from creating a queue manager. Keep the option selected if you do want to create a queue manager.

- e. On the Install Configuration Review panel:
 - Select the install type. You can either choose to automatically configure the application components as part of the main installation process or run scripts after the main installation to configure them later.
 - Expand the Properties headings to review the details that you have configured for this installation.
 - Click **Verify Installation Requirements** to run a number of prerequisite checks. The checks will help you to confirm that your environment and configuration is sufficient to successfully complete the installation.
 - Review the prerequisite validation test results. Click **Show details** to see more information of for each test, and follow the provided links to view the log file and help for each result.

Tip: You can ignore warnings by clicking **Show details**, then selecting **Ignore the warning. I understand the risks**. Errors cannot be ignored.

- If necessary, take any corrective action to address any warnings or errors, then click **Recheck Status**.
- When the checks pass successfully, click **Install**.

The installation application will install InfoSphere MDM. Depending on your configuration, the installation process can take a significant amount of time.

- 9. On the final IBM Installation Manager panel, click **View Log Files** if you want to open the log file viewer.

10. Click **Finish**, then close IBM Installation Manager.

Results

A success message on the final installer panel indicates that the verification tests were automatically run as part of the installation process. You can also view the log files to verify a successful installation. If the installation is not successful, view the log files and use the information in the troubleshooting topics to assist you.

What to do next

After installation, if you want to add or remove a feature (for example, add an application or another language translation), or modify any of your configuration settings, you can run IBM Installation Manager again and select **Modify**.

Related concepts:

“Worksheets for installation and configuration” on page 26

“Prepare IBM Installation Manager” on page 72

“Installing and setting up the application server” on page 75

“Installation scenarios” on page 43

“Verifying the base installation” on page 159

“Multiple instance support” on page 11

Related tasks:

“Installing and setting up the database” on page 81

“Installing on z/OS”

“Modifying your installation” on page 163

Troubleshooting an installation

“Adding a new node to an existing cluster” on page 164

Installing on z/OS

Use this procedure if you are installing with IBM DB2 for z/OS.

Before you begin

Make sure that you meet these prerequisites:

- You added the InfoSphere MDM offering to IBM Installation Manager.
- You completed the preparation tasks for creating the database and application server.
- You completed the “Preparing an existing WebSphere Application Server messaging bus for InfoSphere MDM installation on z/OS” on page 109.
- The IBM WebSphere Application Server (deployment manager and node) and database are started.

About this task

This process requires three distinct steps or sessions. During two of those sessions, you must run the installer process. In the first session, the installer extracts the JCLs that are used to manually install the physical MDM database.

After the physical database load is complete, the third installation session installs the virtual part of the MDM database, the operational server, and any other features you select.

Procedure

For the first session, extract the physical MDM JCLs. Install the **Installation Startup Kit** to extract the InfoSphere MDM DB2 for z/OS assets to the `STARTUPKIT_INSTALL_HOME` directory.

1. Start IBM Installation Manager and click **Install** on the home panel.
2. On the Install Packages panel, select **Installation Startup Kit** and click **Next**.
3. Continue through the prompts to accept the license agreement, select an installation location, and select languages.
4. Review the installation summary information and click **Install**.
5. Click **Finish** when the installation is complete.

For the second session, transfer DB2 assets and load the physical MDM data manually.

6. Go to `STARTUPKIT_INSTALL_HOME`.
7. Copy the MDM Operational Server z/OS assets from the `STARTUPKIT_INSTALL_HOME/CoreData/Full/DB2/ZOS/pds` and `STARTUPKIT_INSTALL_HOME/Full/DB2/ZOS/pds` directories to the z/OS system.

For the third session, install the **MDM Operational Server** and other features:

8. Start IBM Installation Manager and click **Install** on the home panel.
9. On the Install Packages panel, select the edition and click **Next**.
10. Continue through the prompts to accept the license agreement, select an installation location, and select a language.
Attention: If you have IBM Rational Application Developer installed, make sure that you do not install InfoSphere MDM into the same package group. On the Install Packages panel, select **Create a new package group**.
11. Select the **MDM Operational Server**, **MDM Database**, and any other features you want to install.
12. Enter the configuration information:
 - On the database configuration panel, select **DB2 Z/OS**.
 - For IBM WebSphere Application Server configuration, make sure that you enter the information that you used during application server preparation. Use the `mdmadmin` user and password. Click **Verify MDM Instance on Server** before you exit the panel.
 - On the Messaging Server panel, select **IBM WebSphere Default Messaging or MQ Messaging Provider**. For information about manually installing SIB tables on WebSphere Application Server, see the *Creating data store tables* topic in the WebSphere Application Server online documentation.
13. Review the installation summary information to ensure that the details are accurate, then click **Verify Installation Requirements** to run the prerequisite checks. The checks will help to ensure that your environment and configuration is sufficient to successfully complete the installation.
14. Take corrective action to address any warnings or errors in the prerequisite checks, then click **Install**.
15. On the final IBM Installation Manager panel, click **View Log Files** if you want to open the log file viewer.
16. Click **Finish** and close IBM Installation Manager.

What to do next

A success message on the final installer panel indicates that the verification tests were automatically run as part of the installation process. You can also view the

log files to verify a successful installation. If the installation is not successful, view the log files and use the information in the troubleshooting topics to assist you.

Related tasks:

“Installing a custom deployment of InfoSphere MDM” on page 113

“Installing InfoSphere MDM into a clustered environment” on page 124

“Preparing an existing WebSphere Application Server messaging bus for InfoSphere MDM installation on z/OS” on page 109

Configuring your message bus on z/OS after installation

If you did not have an existing WebSphere embedded messaging (message bus) created before installation, then you must complete this procedure after you install InfoSphere MDM on z/OS.

About this task

After the installation completes, an error displays stating that the Install Verification Test did not pass. You can ignore this error if you complete these steps.

Procedure

1. Open the WebSphere Application Server Integrated Solutions Console (admin console).
2. Go to **Service Integration > Buses > *your application bus* > Bus Members**.
3. On the bus members page, click *your application bus member* > *your application SIB server* > **Message Store**.
4. Clear the **Create tables** option.
5. Click **Apply** and then click **Save directly to the master configuration**.
6. Synchronize your nodes and restart the application server. Stopping the server prevents WebSphere Application Server from attempting to create and connect to the SIB tables.
7. Create the SIB tables for your instance by modifying the `ZSIB.sql` file for your schema, prefix, and database owner. In the file, replace `<SCHEMA>` with your schema name, `<PREFIX>` with your three character prefix, and `<DBA ACCOUNT>` with your database owner. Run the SQL as DB Owner.

Note: The value of `<PREFIX>` is typically the last three characters of the schema name.

8. Restart your application server.
9. From the `MDM_INSTALL_HOME/IVT` directory, run the `Verify.sh` script. For example, use the command: `verify.sh DB_Schema DB_Password WAS_user WAS_password`
10. View the installation response files to ensure that the IVT was successful. Response files are in the `MDM_INSTALL_HOME/IVT/testCases/xml/response` and `MDM_INSTALL_HOME/IVT/testCases/xml_virtual/response` directories.

Related concepts:

“WebSphere Application Server embedded messaging configuration” on page 108

Installing on Oracle RAC

Use this procedure if you are using virtual MDM and installing on Oracle Real Application Clusters (RAC).

Before you begin

Make sure that you meet these prerequisites:

- You have completed all of the installation preparation tasks, including installing and preparing your IBM WebSphere Application Server and database.
- You have installed IBM Installation Manager and added the necessary repositories.
- The IBM WebSphere Application Server (deployment manager and node) and database are started.

Procedure

1. Start IBM Installation Manager and click **Install**.
 - a. On the Install Packages panel, select the edition and click **Next**.
 - b. Continue through the prompts to accept the license agreement, select an installation location, and select languages.
 - c. Select the **MDM Database** and **MDM Operational Server** features and click **Next**.
 - d. Complete the configuration panels and click **Next**.
 - e. Click **Install**. The installation application creates the ODBC data source with the SID, and runs the **madconfig bootstrap_datasource** target to create all virtual MDM tables.

Tip: Refer to the parent topic of this task for details about completing the preceding substeps.

2. Open the WebSphere Application Server Integrated Solutions Console (admin console) and select **Resources > JDBC > Data sources**.
 - a. On the Data sources page, click the name of your MDM data source.
 - b. On the next Data sources page, click **Custom properties**.
 - c. Remove the SID by selecting it and clicking **Delete**.
 - d. Click **New** and add a new custom property **Name** for serviceName and the **Value**.
 - e. Click **OK**.
3. Run the following commands from the native.war/scripts directory. For a clustered deployment of InfoSphere MDM, you must run these commands on each machine in the cluster.
 - `madconfig remove_datasource -Dmad.db.dsn=DB_NAME_MDM_INSTANCE_ID`
 - `madconfig create_datasource -Dmad.db.type=oracle -Dmad.db.host=DB_HOST -Dmad.db.port=DB_PORT -Dmad.db.service=SERVICE_NAME -Dmad.db.dsn=DB_NAME_MDM_INSTANCE_ID`

When running this command, you are prompted to enter the SID. Leave the prompt blank and press Enter.

What to do next

Always review the installation logs to verify that the process completed successfully.

If you determine that the virtual data did not load successfully after you review the logs, you can use the **madconfig** utility to either reload the data or run a bootstrap.

Enabling support for Oracle non-wired driver

If you are using a virtual MDM and plan to use a non-wired Oracle database driver, complete these steps after you install the InfoSphere MDM database and features.

Before you begin

Complete the steps in “Deploying the MDM Native Component feature on remote Windows server.”

Procedure

1. On the machine where you installed the native Oracle client and drivers and deployed the native EAR file:
 - a. Configure the operating system environment variable as:
`ORACLE_HOME=PATH_TO_ORACLE_HOME.`
 - b. Configure the operating system environment variable as:
 - For Microsoft Windows: `LIB=PATH_TO_ORACLE_HOME/lib`
 - For IBM AIX: `LIBPATH=PATH_TO_ORACLE_HOME/lib`
 - For other operating systems: `LD_LIBRARY_PATH=PATH_TO_ORACLE_HOME/lib`
2. Go to the `native.war/scripts` directory and run these commands:
 - a. `madconfig remove_datasource -Dmad.db.dsn=DB_NAME_MDM_INSTANCE_ID`
 - b. `madconfig create_datasource -Dmad.db.type=oracle -Dmad.db.dsn=DB_NAME_MDM_INSTANCE_ID-Dmad.db.server=TNS_NAME`
The `create_datasource` command prompts you to enter a database host. You can leave that prompt blank and press Enter.
3. If you have a clustered environment, repeat the steps on each cluster member.

Related reference:

“ODBC drivers installed with Standard Edition” on page 90

Deploying the MDM Native Component feature on remote Windows server

The Master Data Management Native Component feature is the ODBC data source that virtual MDM configurations require to operate successfully. If you are planning to install the MDM operational server and implement a virtual MDM configuration on a WebSphere Application Server cluster and a Microsoft Windows operating system, there are steps that you must take after you install your operational server.

About this task

The installer automatically runs the `madconfig create_datasource` target to create an ODBC data source on a remote server by using an Ant agent. However, the Ant agent does not have permission to modify the Windows registry.

If you are running IBM Installation Manager and WebSphere Application Server deployment manager on machine A and must deploy your operational server and virtual configuration to managed nodes on other machines (for example B, C, and D), use this procedure. This procedure manually creates the ODBC data source on each of the remote Windows servers after you first run IBM Installation Manager to install your operational server.

Procedure

1. Run IBM Installation Manager on machine A and install the MDM operational server.
2. On machine B, go to your *WAS_PROFILE_HOME\installedApps\YOUR_CELL_NAME\MDM-native-IDENTIFIER.ear\native.war\scripts* directory.
3. Open a command-line prompt.
4. Type this command: `madconfig.bat register_odbc.`
5. Type this command: `madconfig.bat create_datasource -Dmad.db.type=DBTYPE -Dmad.db.name=DBNAME -Dmad.db.port=DBPORT -Dmad.db.host=DBHOST -Dmad.db.dsn=DSN`

Where:

- *DBTYPE*: is your database type; specify DB2, ORACLE, or MSSQLU on machine B
 - *DBHOST*: is your database host name or IP address on machine B
 - *DBPORT*: is your database port on machine B
 - *DBNAME*: is your database name on machine B, for example `mdmins11`
 - *DSN*: the data source name; DSN naming convention is *DB_NAME_MDM_INSTANCE_IDENTIFIER.MDM_INSTANCE_IDENTIFIER*. *MDM_INSTANCE_IDENTIFIER* must match the **MDM application name** value that you entered on the Application Configuration panel during installation on machine A.
6. Repeat steps 2 - 5 for each additional machine in your cluster (for example, C and D).

Silent installation

IBM Installation Manager can generate a properties file when you are running the interactive installation program. To run silent installations, you can edit this file or create your own file.

Sample silent mode response files are provided in the *STARTUP_INSTALL_HOME/StartupKit* directory.

Operating system-specific files are available for supported systems.

The following sample silent mode response files for IBM WebSphere Application Server are available:

- `standalone_install_server.res` – use this response file to install the MDM operational server, MDM database, IBM DB2 database server, and WebSphere Application Server Network Deployment
- `standalone_install_workstation.res` – use this response file to install the MDM operational server, MDM database, IBM DB2 database server, WebSphere Application Server, IBM Rational Application Developer (RAD), and InfoSphere MDM Workbench
- `install_single_servers_aix.res` – use this response file to install the operational server with a custom installation deployment type that uses the following parameters:
 - Platform: AIX
 - Messaging provider: WebSphere Application Server default messaging provider
 - MDM Operational Server deployment target (single server): **mdm-s1-E001**
 - Business Administration UI deployment target (single server): **mdm-s2-E001**

- Data Stewardship UI deployment target (single server): **mdm-s2-E001**
- Product Maintenance UI deployment target (single server): **mdm-s2-E001**
- Inspector deployment target (single server): **mdm-s3-E001**
- Enterprise Viewer deployment target (single server): **mdm-s3-E001**
- Web Reports deployment target (single server): **mdm-s3-E001**
- `install_cluster_aix_mq.res` – use this response file to install the Operational Server with a custom installation deployment type that uses the following parameters:
 - Platform: AIX
 - Messaging provider: WebSphere MQ messaging provider
 - MDM Operational Server deployment target (cluster): **mdm-CL01**
 - Business Administration UI deployment target (cluster): **mdm-CL02**
 - Data Stewardship UI deployment target (cluster): **mdm-CL02**
 - Product Maintenance UI deployment target (cluster): **mdm-CL02**
 - Inspector deployment target (cluster): **mdm-CL02**
 - Enterprise Viewer deployment target (cluster): **mdm-CL02**
 - Web Reports deployment target (cluster): **mdm-CL02**
- `install_single_servers_linux.res` – use this response file is to install the Operational Server with a custom installation deployment type that uses the following parameters:
 - Platform: Linux
 - Messaging provider: WebSphere Application Server default messaging provider
 - MDM Operational Server deployment target (single server): **mdm-s1-E001**
 - Business Administration UI deployment target (single server): **mdm-s2-E001**
 - Data Stewardship UI deployment target (single server): **mdm-s2-E001**
 - Product Maintenance UI deployment target (single server): **mdm-s2-E001**
 - Inspector deployment target (single server): **mdm-s3-E001**
 - Enterprise Viewer deployment target (single server): **mdm-s3-E001**
 - Web Reports deployment target (single server): **mdm-s3-E001**
- `install_cluster_linux_mq.res` – use this response file to install the MDM Operational Server with a custom installation deployment type that uses the following parameters:
 - Platform: Linux
 - Messaging provider: WebSphere MQ messaging provider
 - MDM Operational Server deployment target (cluster): **mdm-CL01**
 - Business Administration UI deployment target (cluster): **mdm-CL02**
 - Data Stewardship UI deployment target (cluster): **mdm-CL02**
 - Product Maintenance UI deployment target (cluster): **mdm-CL02**
 - Inspector deployment target (cluster): **mdm-CL02**
 - Enterprise Viewer deployment target (cluster): **mdm-CL02**
 - Web Reports deployment target (cluster): **mdm-CL02**
- `install_single_servers_win.res` – use this response file to install the MDM Operational Server with a custom installation deployment type that uses the following parameters. If there is a validation error in the response file, silent installations on Windows might shut down without displaying any indication of why. If your installation shuts down, review the log files to locate the reason.

- Platform: Microsoft Windows 7
- Messaging provider: WebSphere Application Server default messaging provider
- MDM Operational Server deployment target (single server): **mdm-s1-E001**
- Business Administration UI deployment target (single server): **mdm-s2-E001**
- Data Stewardship UI deployment target (single server): **mdm-s2-E001**
- Product Maintenance UI deployment target (single server): **mdm-s2-E001**
- Inspector deployment target (single server): **mdm-s3-E001**
- Enterprise Viewer deployment target (single server): **mdm-s3-E001**
- Web Reports deployment target (single server): **mdm-s3-E001**
- `install_cluster_win_mq.res` – use this response file to install the MDM Operational Server with a custom installation deployment type that uses the following parameters:
 - Platform: Microsoft Windows 7
 - Messaging provider: WebSphere MQ messaging provider
 - MDM Operational Server deployment target (cluster): **mdm-CL01**
 - Business Administration UI deployment target (cluster): **mdm-CL02**
 - Data Stewardship UI deployment target (cluster): **mdm-CL02**
 - Product Maintenance UI deployment target (cluster): **mdm-CL02**
 - Inspector deployment target (cluster): **mdm-CL02**
 - Enterprise Viewer deployment target (cluster): **mdm-CL02**
 - Web Reports deployment target (cluster): **mdm-CL02**
- `install_single_servers_solaris.res` – use this response file to install the MDM Operational Server with a custom installation deployment type that uses the following parameters:
 - Platform: Solaris
 - Messaging provider: WebSphere Application Server default messaging provider
 - MDM Operational Server deployment target (single server): **mdm-s1-E001**
 - Business Administration UI deployment target (single server): **mdm-s2-E001**
 - Data Stewardship UI deployment target (single server): **mdm-s2-E001**
 - Product Maintenance UI deployment target (single server): **mdm-s2-E001**
 - Inspector deployment target (single server): **mdm-s3-E001**
 - Enterprise Viewer deployment target (single server): **mdm-s3-E001**
 - Web Reports deployment target (single server): **mdm-s3-E001**
- `install_cluster_solaris_mq.res` – use this response file to install the MDM Operational Server with a custom installation deployment type that uses the following parameters:
 - Platform: Solaris
 - Messaging provider: WebSphere MQ messaging provider
 - MDM Operational Server deployment target (cluster): **mdm-CL01**
 - Business Administration UI deployment target (cluster): **mdm-CL02**
 - Data Stewardship UI deployment target (cluster): **mdm-CL02**
 - Product Maintenance UI deployment target (cluster): **mdm-CL02**
 - Inspector deployment target (cluster): **mdm-CL02**
 - Enterprise Viewer deployment target (cluster): **mdm-CL02**

- Web Reports deployment target (cluster): **mdm-CL02**

Related concepts:

“Graphical or silent installation” on page 25

Related tasks:

“Viewing the InfoSphere MDM installation logs” on page 163

Troubleshooting an installation

“Uninstalling in silent mode” on page 188

Related reference:

“Installation Startup Kit for custom installations” on page 10

Customizing the silent mode response file

Use this procedure to customize your silent mode installation response file.

About this task

Attention: Although code examples might show with line breaks in the following content, the text between `<.../>` must be entered in the response file as one line without breaks.

For more information about working in silent mode and using response files, see the online documentation for IBM Installation Manager.

Procedure

1. Open your response file.
2. Specify the home and shared resource directories.
 - a. To specify the MDM_INSTALL_HOME directory, add these lines to your response file:

```
<profile id='IBM InfoSphere Master Data Management'  
  installLocation='/usr/IBM/MDM/H087/mdm' />  
<data key='eclipseLocation' value='/usr/IBM/MDM/H087/mdm' />
```

Where `usr/IBM/MDM/H087/mdm` is the installation home directory.

- b. To specify the Installation Manager Shared Resource directory.

```
<preference name='com.ibm.cic.common.core.preferences.eclipseCache'  
  value='/usr/IBM/MDM/H087/  
Shared' />
```

Where `usr/IBM/MDM/H087/Shared` is the Installation Manager Shared Resource directory.

3. Specify the InfoSphere MDM offering version and the features that you want to install by adding this line:

```
<offering id='com.ibm.mdm.advanced' version='<offering_version>  
  profile='IBM InfoSphere Master Data  
Management'  
features='com.ibm.mdm.install.iu.localization.feature,com.ibm.im.mdm.db.feature,  
com.ibm.im.mdm.app.feature' installFixes='none' />
```

Where `<offering_version>` is the version number of InfoSphere MDM.

You can find the version number by looking in your installation media folder (`download_path/MDM/disk1/`) and locating the `diskTag.inf` file. Open `disk1/diskTag.inf` and copy the value of the `diskSet0OfferingVersion` value to use as your replacement for the `<offering_version>` placeholder.

4. Specify the feature to install during the single IBM Installation Manager session by adding this line:

```
<offering id='com.ibm.mdm.advanced' version='<offering_version>  
profile='IBM InfoSphere Master Data  
Management'  
features='com.ibm.mdm.install.iu.localization.feature,com.ibm.im.mdm.db.  
feature, com.ibm.im.mdm.app.feature' installFixes='none'>
```

Where

```
features='com.ibm.mdm.install.iu.localization.feature,com.ibm.im.mdm.db.feature,com.ibm.im.mdm.app.  
feature'
```

is the specific feature to install. For guidance, see “Examples for specifying features for a silent installation” on page 137.

`com.ibm.mdm.install.iu.localization.feature` must always be included in a feature list. This feature is an internal feature that provides multi-language support for the installer logging system.

5. Specify your database parameters. For guidance, use the applicable database parameters topic for your database. The topics are listed in the related reference links.

The following parameters must not be modified in your response file:

```
<data key='user.L2.db.vertype,com.ibm.mdm.advanced' value='DB2UDBNT_V82_1' />  
<data key='user.L2.mdm.mad.type.db2,com.ibm.mdm.advanced' value='DB2' />  
<data key='user.L2.mdm.mad.type.db2z,com.ibm.mdm.advanced' value='DB2Z' />  
>  
<data key='user.L2.mdm.mad.type.oracle,com.ibm.mdm.advanced' value='ORACLE' />
```

6. Specify your WebSphere Application Server parameters. For guidance, use the application server parameters topic that is listed at the end of this procedure.
7. Specify your messaging server parameters:
 - a. Specify the type of messaging server:
 - If installing with WebSphere Application Server default messaging, specify:

```
<data key='user.L2.messaging.type,com.ibm.mdm.advanced' value='WEM' />
```
 - If installing with IBM WebSphere Message Queue, specify:

```
<data key='user.L2.messaging.type,com.ibm.mdm.advanced' value='WMQ' />
```
 - b. If WebSphere MQ is on the same machine where Installation Manager is running the silent installation of InfoSphere MDM, or to allow the installation application to create message queues and topics:

```
<data key='user.config.messaging.server,com.ibm.mdm.advanced' value='true' />
```
 - c. If WebSphere MQ is on a remote machine or to disable the installation application from creating message queues and topics:

```
<data key='user.config.messaging.server,com.ibm.mdm.advanced' value='false' />
```

Tip: Before running a silent installation with the message queue creation disabled (`value='false'`), ensure that you have already created the message queues and topics ahead of time. You can manually create these queues and topics by running the `custSetupMQServer.mqsc` script.

8. Specify the search and matching engine that this installation of InfoSphere MDM will use:
 - For the Probabilistic Matching Engine:

```
<data key="user.L2.engine.type,com.ibm.mdm.advanced" value="PME" />
```
 - For the Deterministic Matching Engine (MDM Classic Matching Engine):

```
<data key="user.L2.engine.type,com.ibm.mdm.advanced" value="DME" />
```

What to do next

Continue with disabling the installer splash screen and running the silent installation.

Related tasks:

“Uninstalling in silent mode” on page 188

“Installing silently by using a response file” on page 142

Examples for specifying features for a silent installation:

You must edit your response file and specify the exact features that you want to install during a silent installation.

Attention: Although code examples might show with line breaks in the following content, the text between `<.../>` must be entered in the response file as one line without breaks.

Specify the features in the following line in the `<offering id.../>` section of your response file:

```
features='com.ibm.mdm.install.iu.localization.feature,com.ibm.im.mdm.db.feature,com.ibm.im.mdm.app.feature'
```

For example:

```
<offering id='com.ibm.mdm.advanced' version='11.0.0.v20130415-1124' profile='IBM InfoSphere Master Data Management' features='com.ibm.mdm.install.iu.localization.feature,com.ibm.im.mdm.db.feature,com.ibm.im.mdm.app.feature' installFixes='none'>
```

Example 1: Installing MDM Database and InfoSphere MDM Operational Server

To install only the database and operational server, add this line:

```
features='com.ibm.mdm.install.iu.localization.feature,com.ibm.im.mdm.db.feature,com.ibm.im.mdm.app.feature'
```

Example 2: Installing MDM Database, InfoSphere MDM Operational Server, and user applications

To install the database, operational server, and all of the user applications and features, include this line:

```
features='com.ibm.mdm.install.iu.localization.feature,com.ibm.im.mdm.db.feature,com.ibm.im.mdm.app.feature,com.ibm.mdm.ba.webapp.feature,com.ibm.mdm.ds.webapp.feature,com.ibm.mdm.pui.webapp.feature,com.ibm.mdm.inspector.webapp.feature,com.ibm.mdm.ev.webapp.feature,com.ibm.mdm.wb.webapp.feature,com.ibm.mdm.pd.webapp.feature,com.ibm.im.mdm.message.broker.feature,com.ibm.im.mdm.ei.feature,com.ibm.im.mdm.eutc,com.ibm.mdm.ba.webapp.sample.feature'
```

Silent installation database parameters for DB2:

You must specify parameters for your IBM DB2 database in your silent installation response file.

Enter the following lines in your response file if you are using a DB2 database. Change `value=` to the specific value used by your database.

Attention: Although code examples might show with line breaks in the following content, the text between `<.../>` must be entered in the response file as one line without breaks.

Database type

```
<data key='user.db.type,com.ibm.mdm.advanced' value='DB2' />
<data key='user.db.type.cm,com.ibm.mdm.advanced' value='DB2' />
```

Database alias in a database catalog for the DB2 Client

```
<data key='user.db.name,com.ibm.mdm.advanced' value='MDM11E' />
<data key='user.db.name.cm,com.ibm.mdm.advanced' value='MDM11E' />
```

Database name

```
<data key='user.db.name.remote,com.ibm.mdm.advanced' value='YOURBASENAME' />
<data key='user.db.name.remote.cm,com.ibm.mdm.advanced' value='YOURBASENAME' />
```

Database schema name

```
<data key='user.db.schema,com.ibm.mdm.advanced' value='SCHEMANAME' />
<data key='user.db.schema.cm,com.ibm.mdm.advanced' value='SCHEMANAME' />
```

Database server host name

```
<data key='user.db.host,com.ibm.mdm.advanced' value='your.host.com' />
<data key='user.db.host.cm,com.ibm.mdm.advanced' value='your.host.com' />
```

Database server port number

```
<data key='user.db.port,com.ibm.mdm.advanced' value='50000' />
<data key='user.db.port.cm,com.ibm.mdm.advanced' value='50000' />
```

Database user name (should be the same as the schema name)

```
<data key='user.db.user,com.ibm.mdm.advanced' value='USERNAME' />
<data key='user.db.user.cm,com.ibm.mdm.advanced' value='USERNAME' />
```

Database password

```
<data key='user.db.password,com.ibm.mdm.advanced' value='' />
<data key='user.db.password.cm,com.ibm.mdm.advanced' value='' />
```

DB2 Client home directory

```
<data key='user.db2.home,com.ibm.mdm.advanced' value='/home/ws8admin' />
<data key='user.db2.home.cm,com.ibm.mdm.advanced' value='/home/ws8admin' />
```

Database JDBC URL

```
<data key='user.user.db.url,com.ibm.mdm.advanced' value='jdbc:db2://HOSTNAME:PORT/
DBASENAME' />
<data key='user.user.db.url.cm,com.ibm.mdm.advanced' value='jdbc:db2://HOSTNAME:PORT/
DBASENAME' />
```

The following parameters must not be modified in your response file:

```
<data key='user.L2.db.verttype,com.ibm.mdm.advanced' value='DB2UDBNT_V82_1' />
<data key='user.L2.mdm.mad.type.db2,com.ibm.mdm.advanced' value='DB2' />
<data key='user.L2.mdm.mad.type.db2z,com.ibm.mdm.advanced' value='DB2Z' />
>
```

Silent installation database parameters for Microsoft SQL Server:

You must specify parameters for your Microsoft SQL Server database in your silent installation response file.

Enter the following lines in your response file if you are using an SQL Server database. Change value= to the specific value used by your database.

Attention: Although code examples might show with line breaks in the following content, the text between <.../> must be entered in the response file as one line without breaks.

Database type

```
<data key='user.db.type,com.ibm.mdm.advanced' value='MSSQLU' />
<data key='user.db.type.cm,com.ibm.mdm.advanced' value='MSSQLU' />
```

Database name

```
<data key='user.db.name,com.ibm.mdm.advanced' value='YOURDBASENAME' />
<data key='user.db.name.cm,com.ibm.mdm.advanced' value='YOURDBASENAME' />
<data key='user.db.name.remote,com.ibm.mdm.advanced' value='YOURDBASENAME' />
<data key='user.db.name.remote.cm,com.ibm.mdm.advanced' value='YOURDBASENAME' />
```

Database user name (should be the same as the schema name)

```
<data key='user.db.user,com.ibm.mdm.advanced' value='USERNAME' />
<data key='user.db.user.cm,com.ibm.mdm.advanced' value='USERNAME' />
```

Database password

```
<data key='user.db.password,com.ibm.mdm.advanced' value='' />
<data key='user.db.password.cm,com.ibm.mdm.advanced' value='' />
```

Database JDBC URL

```
<data key='user.user.db.url,com.ibm.mdm.advanced'  
value='jdbc:ibm:sqlserver://HOSTNAME:PORT/  
DBASENAME' />  
<data key='user.user.db.url.cm,com.ibm.mdm.advanced'  
value='jdbc:ibm:sqlserver://HOSTNAME:PORT/  
DBASENAME' />
```

Database host name

```
<data key='user.db.host,com.ibm.mdm.advanced' value='DBHOSTNAME' />  
<data key='user.db.host.cm,com.ibm.mdm.advanced' value='DBHOSTNAME' />
```

Database port

```
<data key='user.db.port,com.ibm.mdm.advanced' value='1433' />  
<data key='user.db.port.cm,com.ibm.mdm.advanced' value='1433' />
```

Database schema name

```
<data key='user.db.schema,com.ibm.mdm.advanced' value='SCHEMANAME' />  
<data key='user.db.schema.cm,com.ibm.mdm.advanced' value='SCHEMANAME' />
```

Database home directory

```
<data key='user.L2.db.home,com.ibm.mdm.advanced' value='DBHOMEDIR' />
```

Additional parameters

```
<data key='user.db.servername,com.ibm.mdm.advanced' value='SERVERNAME' />  
<data key='user.db.filegroup,com.ibm.mdm.advanced' value='FILEGROUPNAME_FG' />  
<data key='user.db.auth.native,com.ibm.mdm.advanced' value='false' />
```

Set user.db.auth.native to true if you use Windows Native Authentication.

Silent installation database parameters for Oracle:

You must specify parameters for your Oracle database in your silent installation response file.

Enter the following lines in your response file if you are using an Oracle database. Change value= to the specific value used by your database.

Attention: Although code examples might show with line breaks in the following content, the text between `<.../>` must be entered in the response file as one line without breaks.

Database type

```
<data key='user.db.type.cm,com.ibm.mdm.advanced' value='ORACLE' />  
<data key='user.db.type,com.ibm.mdm.advanced' value='ORACLE' />
```

Oracle client TNS name

```
<data key='user.db.name.cm,com.ibm.mdm.advanced' value='TNSNAME' />  
<data key='user.db.name,com.ibm.mdm.advanced' value='TNSNAME' />
```

Oracle server database name

```
<data key='user.db.name.remote,com.ibm.mdm.advanced' value='DBASENAME' />  
<data key='user.db.name.remote.cm,com.ibm.mdm.advanced' value='DBASENAME' />
```

Database user name (should be the same as the schema name)

```
<data key='user.db.user.cm,com.ibm.mdm.advanced' value='USERNAME' />  
<data key='user.db.user,com.ibm.mdm.advanced' value='USERNAME' />
```

Database user password

```
<data key='user.db.password.cm,com.ibm.mdm.advanced' value='DBPASSWORD' />  
<data key='user.db.password,com.ibm.mdm.advanced' value='DBPASSWORD' />
```

Database JDBC URL

```
<data key='user.user.db.url,com.ibm.mdm.advanced'  
value='jdbc:oracle:thin:@HOSTNAME:PORT/DBASENAME' />  
<data key='user.user.db.url.cm,com.ibm.mdm.advanced'  
value='jdbc:oracle:thin:@HOSTNAME:PORT/DBASENAME' />
```

Database server host name

```
<data key='user.db.host,com.ibm.mdm.advanced' value='DBHOSTNAME' />  
<data key='user.db.host.cm,com.ibm.mdm.advanced' value='DBHOSTNAME' />
```

Database server port

```
<data key='user.db.port,com.ibm.mdm.advanced' value='1521' />  
<data key='user.db.port.cm,com.ibm.mdm.advanced' value='1521' />
```

Database schema name

```
<data key='user.db.schema,com.ibm.mdm.advanced' value='SCHEMANAME' />  
<data key='user.db.schema.cm,com.ibm.mdm.advanced' value='SCHEMANAME' />
```

Oracle client home directory

```
<data key='user.L2.db.home,com.ibm.mdm.advanced' value='ORACLEHOMEPATH' />
```

The following parameter must not be modified in your response file:

```
<data key='user.L2.mdm.mad.type.oracle,com.ibm.mdm.advanced' value='ORACLE' />
```

Silent installation WebSphere Application Server parameters:

You must specify parameters for WebSphere Application Server in your silent installation response file.

Enter the following lines in your response file. Change the placeholders following value= to the specific values used by your application server instance.

Attention: Although code examples might show with line breaks in the following content, the text between <.../> must be entered in the response file as one line without breaks.

WebSphere Application Server installation home directory

```
<data key='user.L1.was.home,com.ibm.mdm.advanced' value='/WAS_INSTALL_HOME' />
```

WebSphere Application Server type, either Network Deployment or Base

```
<data key='user.was.type,com.ibm.mdm.advanced' value='ND' />
```

Profile Home (required if installing the MDM database only using INSTALL mode)

```
<data key='user.was.profile.home,com.ibm.mdm.advanced'  
value='/opt/IBM/WebSphere/AppServer/profiles/AppSrv01' />
```

WebSphere Application Server Network Deployment Manager or WebSphere Application Server Base server1 SOAP port

```
<data key='user.deploy.port,com.ibm.mdm.advanced' value='8880' />
```

WebSphere Application Server Deployment Manager or WebSphere Application Server Base server1 host name

```
<data key='user.deploy.host,com.ibm.mdm.advanced' value='HOSTNAME' />
```

WebSphere Application Server deployment target (single server)

```
<data key='user.was.cell,com.ibm.mdm.advanced' value='CELLNAME' />  
<data key='user.was.node,com.ibm.mdm.advanced' value='NODENAME' />  
<data key='user.was.server,com.ibm.mdm.advanced' value='SERVERNAME' />  
<data key='user.was.cluster,com.ibm.mdm.advanced' value='None' />  
<data key='user.was.cluster.flag,com.ibm.mdm.advanced' value='false' />
```

WebSphere Application Server deployment target (cluster)

```
<data key='user.was.cell,com.ibm.mdm.advanced' value='CELLNAME' />  
<data key='user.was.node,com.ibm.mdm.advanced' value='None' />  
<data key='user.was.server,com.ibm.mdm.advanced' value='None' />  
<data key='user.was.cluster,com.ibm.mdm.advanced' value='CLUSTERNAME' />  
<data key='user.was.cluster.flag,com.ibm.mdm.advanced' value='true' />
```

WebSphere Application Server security parameters - WebSphere administration security user

```
<data key='user.was.user.com.ibm.mdm.advanced' value='USERNAME' />
<data key='user.was.password.com.ibm.mdm.advanced' value='' />

<data key='user.security.user.name.com.ibm.mdm.advanced' value='USERNAME' />
<data key='user.security.user.password.com.ibm.mdm.advanced' value='' />

<data key='user.was.user.ba.com.ibm.mdm.advanced' value='USERNAME' />
<data key='user.was.password.ba.com.ibm.mdm.advanced' value='' />

<data key='user.was.user.ds.com.ibm.mdm.advanced' value='USERNAME' />
<data key='user.was.password.ds.com.ibm.mdm.advanced' value='' />

<data key='user.was.user.pui.com.ibm.mdm.advanced' value='USERNAME' />
<data key='user.was.password.pui.com.ibm.mdm.advanced' value='' />

<data key='user.was.user.inspector.com.ibm.mdm.advanced' value='USERNAME' />
<data key='user.was.password.inspector.com.ibm.mdm.advanced' value='' />

<data key='user.was.user.ev.com.ibm.mdm.advanced' value='USERNAME' />
<data key='user.was.password.ev.com.ibm.mdm.advanced' value='' />

<data key='user.was.user.wb.com.ibm.mdm.advanced' value='USERNAME' />
<data key='user.was.password.wb.com.ibm.mdm.advanced' value='' />
```

Important: The following security parameters cannot be changed:

```
<data key='user.was.security.com.ibm.mdm.advanced' value='1' />
<data key='user.was.security.on.off.com.ibm.mdm.advanced' value='on' />
```

WebSphere Application Server security parameters - WebSphere application security role mapping user for securing OSGI and web services

```
<data key='user.L2.was.admin.user.com.ibm.mdm.advanced' value='USERNAME' />
<data key='user.L2.was.admin.password.com.ibm.mdm.advanced' value='' />
```

Disabling the installer splash screen during silent installation

Use this procedure to disable the IBM Installation Manager splash screen for silent installations. This task must be completed for the silent installation to run successfully.

About this task

Follow these steps to add the **-nosplash** parameter in the IBMIM.ini file.

Procedure

1. Go to the `INSTALLATIONMANAGER_INSTALL_HOME/eclipse` directory.
2. Open the IBMIM.ini file.
3. Add the **-nosplash** parameter. For example:

- Microsoft Windows:

```
-toolId ibmim
-accessRights nonAdmin
-vm
/home/ws7admin/IBM/InstallationManager/eclipse/jre_5.0.1.sr8a_20080811c/jre/bin/java
-nosplash
-vmargs
-Xms40m
-Xmx512m
-Xquickstart
-Xgcpolicy:gencon
```

- Linux and UNIX:

```
vi IBMIM.ini
/opt/IBM/InstallationManager/eclipse/jre_6.0.0.sr9_20110208_03/jre/bin/java
-nosplash
-vmargs
-Xquickstart
-Xgcpolicy:gencon
```

4. Save and close the file.

Installing silently by using a response file

You can install InfoSphere MDM silently, where the installation choices are provided in an options file instead of in the interactive IBM Installation Manager panels. This type of installation is helpful when you are doing multiple identical installations.

Before you begin

Verify that the installation startup kit is installed. The response files in the kit can be used for a silent installation.

Make sure that you complete the steps in “Disabling the installer splash screen during silent installation” on page 141.

About this task

A properties file is generated when you run the interactive installation program. To use a silent installation, you must edit the properties file or create your own file by editing one of the sample response files.

Procedure

1. To use a sample response file, go to *STARTUPKIT_INSTALL_HOME*. Response files have a *.res* extension. Use the file that is applicable to your operating system.
2. Edit the response file and make any necessary changes before you start the installation.
3. Start the installation with the applicable command:
 - Use this command to run IBM Installation Manager and then generate the corresponding response file:
`IBMIM -record recordedFile`
 - Use this command to run IBM Installation Manager in silent mode:
`IBMIM -acceptLicense -silent -input inputFile`
4. If an unrecoverable problem occurs during the silent installation, look for the cause of the problem in the log files in the *MDM_INSTALL_HOME/logs/logs* directory. After you correct the issue, run the silent installation again.

Related tasks:

“Installing the Installation Startup Kit” on page 73

“Customizing the silent mode response file” on page 135

Troubleshooting an installation

“Uninstalling in silent mode” on page 188

Related reference:

“Installation Startup Kit for custom installations” on page 10

Creating a response file while you are running a graphical installation

Use this procedure to capture responses and create a response file when you are running IBM Installation Manager in graphical mode.

Before you begin

The password values in the file are encrypted. If the password value is changed in the system, you must input the correct password value to the response file before

you use it for a silent installation. You can enter a new unencrypted value for the password, and the system encrypts it when the file is used during installation.

Procedure

Create the response file by starting the installation with the following command:

```
../IBMIM -record $YOUR_PATH/mysilent.res
```

Modifying an installation silently

Use this procedure to modify an existing silent installation.

About this task

To use a silent installation to modify an existing installation, you must edit your installation response file.

Attention: Although code examples might show with line breaks in the following content, the text between `<.../>` must be entered in the response file as one line without breaks.

Procedure

To modify your installation, set the modify parameter to true and list the features that you want to add. For example:

```
<install modify='true'>
<offering id='com.ibm.mdm.advanced' version='11.0.0.v20130412-1501'
profile='IBM InfoSphere Master Data Management'
features='com.ibm.mdm.install.iu.localization.feature,com.ibm.im.mdm.db.feature,
com.ibm.im.mdm.app.feature,com.ibm.mdm.ba.webapp.feature,com.ibm.mdm.ds.webapp.feature,
com.ibm.mdm.pui.webapp.feature,com.ibm.mdm.pd.webapp.feature,
com.ibm.mdm.wb.webapp.feature,com.ibm.mdm.ev.webapp.feature,
com.ibm.mdm.inspector.webapp.feature,com.ibm.mdm.ba.webapp.sample.feature'
installFixes='none' />
</install>
```

Manual installation using the madconfig utility

The **madconfig** utility can be used to manually install MDM operational server and database components. IBM Installation Manager uses the utility targets during installation.

To run any **madconfig** target, you must open a command-line prompt from the `MDM_INSTALL_HOME/mds/scripts` directory.

The targets listed in the following table are the basic utility targets. There are more **madconfig** utility targets that are specific to InfoSphere MDM and are described in a separate topic.

Table 24. Basic madconfig utility targets

Command	Description
-projecthelp	Lists all valid options and usage information for this utility
-propertyfile	Loads properties from a recorded file
-recordfile	Record response properties to file

When commands are run, you are prompted to provide more information. For example, to configure the server on which your MDM operational server is

installed, you are prompted to provide certain configuration parameters. This example shows a partial output of a `madconfig install_server_config` target (where *user input* is a blank line where you enter your response).

```
C:/MDM/mds/scripts:madconfig install_server_config
```

```
Buildfile: build.xml
```

```
install_server_config:
```

```
#
# Enter WAS home:
#
WAS_INSTALL_HOME/IBM/WebSphere/AppServer

#
# Enter WAS host:
#
localhost

#
# Enter WAS port:
#
8879
```

The utility further prompts for more WebSphere Application Server parameters, database parameters (JDBC providers and data source in the application server), application name, messaging types to use (connection factories, queues, and topics), and JVM heap size.

An alternative way to run a target is by using the `-propertyfile` option. The following example shows how to use `-propertyfile` to run the `install_mdm_eba` target. This target installs the MDM Enterprise Bundle Archive (.eba) file onto an application server. The properties that are required for deployment include details of the server, the `ebaID`, the `ebaName`, the `blaName` (business level application name), and `blaDes` (business level application description).

```
C:/MDM/mds/scripts:madconfig -propertyfile install_mdm_eba.properties install_mdm_eba
```

The properties that are required by the target are read from the property file. When this option is being used, the values are provided with the exact property names as expected by the target because it can be run only when the property names are known.

madconfig utility targets for InfoSphere MDM

Use the **madconfig** utility to manually install the MDM operational server and database components for physical and virtual implementations. IBM Installation Manager uses the utility targets during InfoSphere MDM installation.

This utility is run from the operational server installation `MDM_INSTALL_HOME/mds/scripts` directory.

This following tables list the **madconfig** targets for InfoSphere MDM and their usage.

Operational server installation

The following table lists the targets that are related to installing the operational server. Each target requests values for parameters that pertain to the server and database. The server targets are used to configure the server on which InfoSphere MDM is installed.

Table 25. `madconfig` utility targets for operational server installation

Command	Description
<code>-install_native_engine_ear</code>	Installs the native operational server (engine) for a virtual MDM implementation.
<code>-install_server_config</code>	Configures the application server for physical and virtual components; including JDBC, class path, and environment variables.
<code>-stop_server</code>	Stops an operational server in WebSphere Application Server Network Deployment. Stopping and starting the server is required after you install an operational server configuration. The option <code>-stop_base_server</code> must be used when the server is unmanaged (Base server).
<code>-start_server</code>	Starts an operational server in a managed application server deployment. Use the option <code>-start_base_server</code> when the application server is unmanaged.
<code>-install_mdm_old_ws_ear</code>	Installs the physical MDM web services JAR in the application server.
<code>-install_mdm_eba</code>	Installs the InfoSphere MDM OSGi.
<code>-install_prop_file_jar</code>	Installs the property file JAR required by InfoSphere MDM applications.
<code>-install_mdm_ws_ear</code>	Installs the InfoSphere MDM web services enterprise archive.
<code>-install_mds_ws_api</code>	Installs the API for virtual MDM.
<code>-enable_app_security</code>	Creates users, creates groups, adds users to groups, creates policy set, and creates policy set binding for web services EAR file.
<code>-map_roles_to_users</code>	Creates the Security role mapping and RunAs role mapping for the EBA and web services EAR file.
<code>-full_sync</code>	Synchronizes nodes in a managed server deployment to reflect the user security for InfoSphere MDM. This target must be run after you run the <code>map_roles_to_users</code> target.
<code>-enable_deployment_target</code>	Checks the status of the operational server; if the server is stopped you can use this target to restart the server.

InfoSphere MDM database installation

The following table lists the targets that are used to install and configure physical and virtual schemas for the MDM database.

Table 26. `madconfig` utility targets for database installation

Command	Description
<code>-install_core_db_db2</code>	Creates tables, triggers, constraints, and functions for the InfoSphere MDM core database that is installed on IBM DB2.
<code>-install_domain_db_db2</code>	Creates tables, triggers, constraints, and functions for InfoSphere MDM domains on a DB2 database.
<code>-install_core_db_ora</code>	Creates tables, triggers, constraints, and functions for an InfoSphere MDM core database on Oracle.
<code>-install_domain_db_ora</code>	Creates tables, triggers, constraints, and functions for InfoSphere MDM domains on an Oracle database.

Table 26. **madconfig** utility targets for database installation (continued)

Command	Description
-install_core_db_sql	Creates tables, triggers, constraints, and functions for the InfoSphere MDM core database on Microsoft SQL Server.
-Update_confielement_matching	Updates the Confielement table for the selected matching type.
-Update_appsoftware_eba	Updates the appsoftware table by providing the appropriate name of the EBA in the software name column.
-create_datasource	Creates the data source that is used by a virtual MDM.
-create_odbc	Creates an ODBC for use by virtual MDM.
-register_odbc	Registers ODBC for virtual MDM.
-bootstrap_datasource	Creates the tables for virtual MDM.
-test_datasource	<p>To test your data source, you must provide the database name and DSN name. The DSN name can be found in the <code>odbc.ini</code> file in the <code>mds/conf</code> directory, or you can use the <code>./madconfig.sh list_datasources</code> command.</p> <p>Provide the database name and DSN name as follows:</p> <pre>./madconfig.sh test_datasource -Dmad.db.name=dbname -Dmad.db.dsn=DSNname</pre>

InfoSphere MDM web UI installations

The **madconfig** utility supports the installation of the InfoSphere MDM web-based user interfaces.

Important: Before running any of the web UI installation targets, you must first run the appropriate target to create and start the application server:

- For WebSphere Application Server Network Deployment Edition, run `-enable_deployment_target`.
- For WebSphere Application Server Base Edition, run `-start_base_server`.

The following table describes the targets that are used to install and configure the web interfaces.

Table 27. **madconfig** utility targets for web-based user interfaces

Command	Description
-config_mdm_web_app	<p>Configures the following:</p> <ul style="list-style-type: none"> • Adds the port defined by <code>WC_defaulthost_secure</code> into the <code>default_host</code> as the host alias. • Adds the custom property <code>com.ibm.CORBA.RequestTimeout</code> into the ORB Service. • Sets Requires SSL to true in the Global Security > Single sign-on settings.
-mds_ui_prop_config	Configures the properties files for the virtual MDM web applications, including Inspector, Web Reports, and Enterprise Viewer.
-mdm_ui_prop_config	Configures the properties files for the physical MDM web applications, including Data Stewardship UI, Business Administration UI, and Product Maintenance UI.

Table 27. **madconfig** utility targets for web-based user interfaces (continued)

Command	Description
-install_mds_web_app	Deploys the virtual MDM web applications. For Inspector and Web Reports, this target sets the class loader mode to PARENT_LAST and the policy to SINGLE.
-install_mdm_web_app	Deploys the physical MDM web applications.
-import_ssl_certificate	Imports the SSL certificate. This target is required when: <ul style="list-style-type: none"> • Installing the virtual MDM web interfaces. • Enabling SSL for the virtual MDM web interfaces. • Deploying the virtual MDM web interfaces and operational server are deployed to different application server cells.

To install the physical MDM web interfaces, run the following **madconfig** targets in sequence:

1. `mdm_ui_prop_config`
2. `config_mdm_web_app`
3. `install_mdm_web_app`

To install the virtual MDM web interfaces, run the following **madconfig** targets in sequence:

1. `mds_ui_prop_config`
2. `config_mdm_web_app`
3. `install_mds_web_app`

Flexible Search configuration

The **madconfig** utility supports the configuration and management of Flexible Search.

The following table describes the targets that are used to configure and manage Flexible Search.

Table 28. **madconfig** utility targets for Flexible Search

Command	Description
-flexsearch_config	Configures Flexible Search to index InfoSphere MDM attributes in Data Explorer as entities that are composed of these attributes are created/updated/deleted.
-flexsearch_syncdb	Indexes entities to Data Explorer by specifying entrecno (entity id) range values to index from the operational server database.
-flexsearch_sync_svc_enable	Enables the Flexible Search index synchronization service.
-flexsearch_sync_svc_disable	Disables the Flexible Search index synchronization service.

InfoSphere MDM uninstall



The **madconfig** utility also supports uninstalling the application server and database.

Attention: Reset of the MDM operational server and database components is supported by the Test Environment tool in InfoSphere MDM Workbench. Even though **madconfig** targets are available for reset, the best practice is to always use the workbench tool.

Table 29. **madconfig** utility targets for uninstall

Command	Description
-uninstall_mds_ws_api	Uninstalls the API for virtual MDM.
-uninstall_mdm_ws_ear	Uninstalls the InfoSphere MDM web services enterprise archive.
-uninstall_mdm_web_app	Uninstalls the InfoSphere MDM web interfaces: <ul style="list-style-type: none"> • Business Administration UI • Data Stewardship UI • Product Maintenance UI • Inspector • Web Reports • Enterprise Viewer
-uninstall_prop_file_jar	Uninstalls the property file JAR required by an InfoSphere MDM application.
-uninstall_mdm_eba	Uninstalls the InfoSphere MDM OSGi.
-uninstall_mdm_old_ws_ear	Uninstalls the physical MDM web services JAR in the application server.
-uninstall_server_config	Removes the InfoSphere MDM-related configuration changes made to the application server.
-uninstall_native_engine_ear	Uninstalls the native operational server (engine) for virtual MDM.
-remove_datasource	Removes the data source that is used by a virtual MDM.
-unregister_odbc	Unregisters ODBC used by virtual MDM.

Related information:

-  [Creating an automated madconfig utility script](#)
-  [Overview of setting Test Environment preferences](#)

Installing a hybrid MDM solution

If you plan to use InfoSphere MDM as a hybrid MDM solution, you must install InfoSphere MDM Advanced Edition, and then complete some post-installation tasks to set up the hybrid deployment.

About this task

The hybrid MDM deployment style of InfoSphere MDM is installed using the same process as the Advanced Edition (which includes both virtual MDM and physical MDM deployment styles). The hybrid MDM features must be configured after installing the application.

Procedure

1. Complete the installation procedures to deploy InfoSphere MDM Standard and Advanced Editions.

2. Enable hybrid MDM features by completing the procedures documented in the *Post installation configuration* section of the documentation.
3. Configure your hybrid MDM solution using the procedures documented in the *Developing for Standard and Advanced Editions > Hybrid MDM* section of the of the documentation.

Related information:

 [Hybrid configuration](#)

 [Hybrid MDM](#)

Installing client applications and individual components

IBM Installation Manager gives you the option of selecting to install individual components. This option is used when you want to install components on workstations or on a server that is different from the server on which you install the operational server and MDM database.

If you are electing to install an individual component on a machine with other InfoSphere MDM components that are already installed, use the Modify option rather than the Install option.

Use IBM Installation Manager to uninstall client applications.

If you are installing on Microsoft Windows:

- You must be running in Administrator mode for IBM Installation Manager to write to the Windows registry. Administrator mode is not used for IBM AIX, Linux, or Solaris.
- On a Microsoft Windows 7 operating system, you must install MDM into a directory that is not virtualized.

After installing your feature, verify a successful installation by viewing the log files.

When the InfoSphere MDM web interfaces are installed and running, you can access them with a web browser at the following URLs:

Business Administration UI

`https://<hostname>:<port>/CustomerBusinessAdminWeb/faces/login.jsp`

Data Stewardship UI

`https://<hostname>:<port>/CustomerDataStewardshipWeb/faces/login.jsp`

Product Maintenance UI

`https://<hostname>:<port>/ProductWeb/faces/login.jsp`

Inspector

`https://<hostname>:<port>/inspector/common/login.ihtml`

Enterprise Viewer

`https://<hostname>:<port>/accessweb/empi/MITLogin.jsp`

Web Reports

`https://<hostname>:<port>/webreports/common/login.html`

Note: The `<hostname>` and `<port>` values differ depending on the details of each installation. By default, the typical workstation installation uses port 9443 in each

URL, but other types of installations can use different ports. Use the WebSphere Application Server Integrated Solutions Console (admin console) to look up each actual port value.

Related tasks:

“Modifying your installation” on page 163

“Uninstalling a single component” on page 187

“Viewing the InfoSphere MDM installation logs” on page 163

Troubleshooting an installation

“Separating configuration from installation” on page 120

Related reference:

“Directory structures” on page 14

Related information:

 [Configuring application security for web applications](#)

Installing the Business Administration UI

Use this procedure to install the Business Administration UI. Administrators can use the Business Administration UI to manage certain elements of the MDM operational server without having to manually modify properties files or database tables.

Before you begin

Before installing the Business Administration UI, ensure that you meet these prerequisites:

- Your environment meets the hardware and software requirements for this component.
- You completed the IBM Installation Manager preparation steps.
- You reviewed and completed the user applications installation worksheet.
- You have IBM WebSphere Application Server installed and running.
- If you are upgrading from an earlier version of the application and have custom settings in your property files, make a copy of the files.

About this task

The Business Administration application can be installed on either a server or workstation. It can also be installed on a remote machine by choosing a remote WebSphere Application profile.

This application is not supported for use with a Microsoft SQL Server database.

You have two options available for installation: Install or Modify. The Install option assumes that you are installing the application on a clean server or workstation. That means that the server or workstation does not have any InfoSphere MDM components that are already installed (for example the MDM operational server, database component, or another user application). If any InfoSphere MDM components are present on the machine on which you are installing the application, you must use the Modify option.

Procedure

1. Start IBM Installation Manager.
2. On the IBM Installation Manager home panel, select **Install** or **Modify**.

3. If you selected **Install**, complete these steps.
 - a. On the Install Packages panel, select the InfoSphere MDM offering and click **Next**.
 - b. Continue through the panels to accept the license agreement, select the installation directory, and the language.
 - c. On the Install Packages panel, select **Business Administration UI**. Click **Next**.
 - d. Enter the configuration information for the application.
 - e. Review the installation summary information and click **Install**.
4. If you selected **Modify**, complete these steps.
 - a. On the Modify Packages panel, select the InfoSphere MDM package and click **Next**.
 - b. Select the language and click **Next**.
 - c. On the Modify Packages panel, select **Business Administration UI**. Previously installed components are automatically selected. Make sure that they remain selected, otherwise IBM Installation Manager removes them. Click **Next**.
 - d. Enter the configuration information for the application. Use the MDM user applications worksheet as a guideline. Click **Next**.
 - e. Review the summary information and verify that the component that you want to install is listed in the Adding Features box and that no components are listed in the Removing Features box. Click **Modify**.
5. Click **Finish** when the installation is complete and close IBM Installation Manager.
6. Open the IBM WebSphere Application Server Integrated Solutions Console (admin console) and verify that the application is deployed to the server specified during installation.

What to do next

To access the Business Administration UI after it has been installed and started, navigate your web browser to the following URL (replacing `<hostname>` and `<port>` with the appropriate values): `https://<hostname>:<port>/CustomerBusinessAdminWeb/faces/login.jsp`

Learn more about using Business Administration UI by reviewing the related concept.

Related reference:

“User applications installation worksheet” on page 39

Related information:

 [Configuring application security for web applications](#)

Installing Data Stewardship UI

Use this procedure to install the Data Stewardship UI. The Data Stewardship UI application supports data governance for physical MDM data.

Before you begin

Make sure that you meet these prerequisites:

- Your environment meets the hardware and software requirements for this component

- You completed the IBM Installation Manager preparation steps
- You reviewed and completed the MDM user applications installation worksheet
- You have IBM WebSphere Application Server installed and running
- If you are upgrading from an earlier version of the application and have custom settings in your property files, make a copy of the files.

About this task

Data Stewardship UI is used for maintaining data quality within the core physical MDM application.

This application can be installed on either a server or workstation. It can also be installed on a remote machine by choosing a remote WebSphere Application Profile.

This application is not supported for use with a Microsoft SQL Server database.

You have two options available for installation: Install or Modify. The Install option assumes that you are installing the application on a clean server or workstation. That means that the server or workstation does not have any InfoSphere MDM components that are already installed (for example the MDM operational server, database component, or another user application). If any MDM components are present on the machine on which you are installing the application, you must use the Modify option.

Procedure

1. Start IBM Installation Manager.
2. On the IBM Installation Manager home panel, select **Install** or **Modify**.
3. If you selected **Install**, complete these steps.
 - a. On the Install Packages panel, select the InfoSphere MDM offering and click **Next**.
 - b. Continue through the panels to accept the license agreement, select the installation directory, and the language.
 - c. On the Install Packages panel, select **Data Stewardship UI**. Click **Next**.
 - d. Enter the configuration information for the application. Use the MDM user applications worksheet as a guideline.
 - e. Review the installation summary information and click **Install**.
4. If you selected **Modify**, complete these steps.
 - a. On the Modify Packages panel, select the InfoSphere MDM package and click **Next**.
 - b. Select the language and click **Next**.
 - c. On the Modify Packages panel, select **Data Stewardship UI**. Previously installed components are automatically selected. Make sure that they remain selected, otherwise IBM Installation Manager removes them. Click **Next**.
 - d. Enter the configuration information for the application. Use the MDM user applications worksheet as a guideline. Click **Next**.
 - e. Review the summary information and verify that the component that you want to install is listed in the Adding Features box and that no components are listed in the Removing Features box. Click **Modify**.
5. Click **Finish** when the installation is complete and close IBM Installation Manager.

6. Go to IBM WebSphere Application Server Integrated Solutions Console (admin console) and verify that the application is deployed to the server specified during installation.

What to do next

To access the Data Stewardship UI after it has been installed and started, navigate your web browser to the following URL (replacing *<hostname>* and *<port>* with the appropriate values): `https://<hostname>:<port>/CustomerDataStewardshipWeb/faces/login.jsp`

Learn more about using Data Stewardship UI by reviewing the related concept.

Related reference:

“User applications installation worksheet” on page 39

Related information:

 Getting started with Data Stewardship

 Configuring application security for web applications

Manually creating a Task Management user for the Data Stewardship UI

In certain circumstances, you must manually create a Task Management user for the Data Stewardship UI.

About this task

When you install MDM operational server and database component, the component and Configuration Repository are included in the installation set, and the installer automatically creates the Task Management user. If the MDM database component and Configuration Repository are not included in the installation set, for example because of being installed manually, you must manually create the Task Management User to properly run the Data Stewardship UI.

Procedure

Choose the appropriate option for creating the Task Management user for the Data Stewardship UI according to how the WebSphere Application Server global security is configured in your environment:

- To create a Task Management User when WebSphere Application Server global security is disabled, configure and run the following SQL statement:

```
MDM_INSTALL_HOME/TaskManagement/TaskManagementGSOFF.sql
```

- To create a Task Management User when WebSphere Application Server global security is enabled, configure and run the following SQL statement:

```
MDM_INSTALL_HOME/TaskManagement/TaskManagementGSON.sql
```

Installing the Product Maintenance UI

Use this procedure to install the Product Maintenance UI. The Product Maintenance UI is used to maintain product data quality.

Before you begin

Make sure that you meet these prerequisites:

- Your environment meets the hardware and software requirements for this component.

- You completed the IBM Installation Manager preparation steps.
- You reviewed and completed the MDM user applications installation worksheet.
- You have IBM WebSphere Application Server installed and running.
- If you are upgrading from an earlier version of the application and have custom settings in your property files, make a copy of the files.

Before installing this application, ensure that you have the WebSphere Application Server deployment manager (Dmgr) JVM Heap size arguments set to 512MB and 1024MB.

About this task

Administrators are responsible for installing, deploying, and supporting users of the Product Maintenance UI application.

This application can be installed on either a server or workstation. It can also be installed on a remote machine by choosing a remote WebSphere Application Profile.

This application is not supported for use with a Microsoft SQL Server database.

You have two options available for installation: Install or Modify. The Install option assumes that you are installing the application on a clean server or workstation. That means that the server or workstation does not have any InfoSphere MDM components that are already installed (for example the MDM operational server, database component, or another user application). If any MDM components are present on the machine on which you are installing the application, you must use the Modify option.

Procedure

1. Start IBM Installation Manager.
2. On the IBM Installation Manager home panel, select **Install** or **Modify**.
3. If you selected **Install**, complete these steps.
 - a. On the Install Packages panel, select the InfoSphere MDM offering and click **Next**.
 - b. Continue through the panels to accept the license agreement, select the installation directory, and the language.
 - c. On the Install Packages panel, select **Product Maintenance UI**. Click **Next**.
 - d. Enter the configuration information for the application. Use the MDM user applications worksheet as a guideline.
 - e. Review the installation summary information and click **Install**.
4. If you selected **Modify**, complete these steps.
 - a. On the Modify Packages panel, select the InfoSphere MDM package and click **Next**.
 - b. Select the language and click **Next**.
 - c. On the Modify Packages panel, select **Product Maintenance UI**. Previously installed components are automatically selected. Make sure that they remain selected, otherwise IBM Installation Manager removes them. Click **Next**.
 - d. Enter the configuration information for the application. Use the MDM user applications worksheet as a guideline. Click **Next**.

- e. Review the summary information and verify that the component that you want to install is listed in the Adding Features box and that no components are listed in the Removing Features box. Click **Modify**.
5. Click **Finish** when the installation is complete and close IBM Installation Manager.
6. Open the IBM WebSphere Application Server Integrated Solutions Console (admin console) and verify that the application is deployed to the server specified during installation.

What to do next



To access the Product Maintenance UI after it has been installed and started, navigate your web browser to the following URL (replacing `<hostname>` and `<port>` with the appropriate values): `https://<hostname>:<port>/ProductWeb/faces/login.jsp`

Learn more about using Product Maintenance UI by reviewing the related concept.

Related reference:

“User applications installation worksheet” on page 39

Related information:

-  Getting started with Product Maintenance UI
-  Configuring application security for web applications

Installing InfoSphere MDM Workbench

Install InfoSphere MDM Workbench using these steps if you are using a custom installation deployment type and are installing only the Workbench.

Before you begin

Make sure that you meet these prerequisites:

- Your environment meets the hardware and software requirements
- You completed the IBM Installation Manager preparation steps if this is a custom installation
- You installed IBM Rational Application Developer
- You installed InfoSphere MDM
- The login that you use on the computer must have permission to write to the registry.

If you plan to install Workbench as part of a stand-alone workstation installation for DB2 deployment, see the instructions for starting a stand alone installation (see the related tasks).

About this task

InfoSphere MDM Workbench is used by implementers and administrators to manage the InfoSphere MDM environment. By using this application, you can manage algorithms, create composite views, edit data dictionary tables, and develop member logical models, flows, and mappings to data sources.

InfoSphere MDM Workbench is an Eclipse-based technology and runs on computers that use Microsoft Windows.

You must have IBM Rational Application Developer installed to use the workbench.

Procedure

1. Shut down IBM Rational Application Developer if it is running.
2. Start IBM Installation Manager.
3. On the IBM Installation Manager home screen, click **Install**.
4. On the Install Packages panel, select **IBM InfoSphere Master Data Management Workbench** and click **Next**.
5. Accept the license agreement.
6. Select the package group where IBM Rational Application Developer is installed and click **Next**.
7. Click **Install**.
8. Click **Finish** when complete.

What to do next

You can now use InfoSphere MDM Workbench to configure your operational server.

Related tasks:

“Starting a stand-alone with DB2 installation using LaunchPad” on page 58

Viewing the installation logs

Related reference:

“32-bit libraries needed on 64-bit operating systems” on page 4

“Installation requirements” on page 2

Setting Workbench server definitions

Within the InfoSphere MDM Workbench, configure parameters for your WebSphere Application Server to ensure that your installation runs smoothly.

About this task

Set certain parameters within MDM Workbench to reflect the underlying function of the application and its configuration.

Begin by choosing the option to **Run server with resources on Server**. This option installs and copies the full application and its server-specific configuration from the Workbench into the directories of the server. This option reflects the way that the application and configuration are deployed to the production environment. In particular, a CBA is physically built, packaged, and deployed in the internal bundle repository of the WebSphere Application Server.

Second, choose the option to **Never publish automatically**. If you do not choose this option, a time-consuming publishing operation occurs every time a simple change occurs in the workspace.

Third, unchecking the option to **Start server with a generated script** allows MDM logging to occur without issues.

Procedure

1. In the Servers view, double-click your WebSphere Application Server to open the server editor.

2. On the Publishing settings for WebSphere Application Server page, navigate to the **Modify the publishing settings** list.
3. Choose the option for **Run server with resources on Server**.
4. On the Publishing page, navigate to the **Modify settings for publishing** list.
5. Choose the option for **Never publish automatically**.
6. On the Overview page, navigate to the **Optimize server start for development** list.
7. Uncheck the check box for **Start server with a generated script**.
8. Type Ctrl+S to save the server configuration settings.
9. Close the editor.
10. Start the server:
 - a. In the Servers view, right-click the server.
 - b. Select **Start**.

Samples installation

The samples include mappings and source code files that demonstrate the consumption of InfoSphere MDM. Install these samples only on development environments.

Samples are available from the following locations:

- Code snippets in the documentation
- Package within IBM Installation Manager
- Samples and Assets site for InfoSphere MDM

Related information:

 [Sample list](#)

Installing the samples with IBM Installation Manager

Use this procedure to install the Samples feature that is part of IBM Installation Manager.

About this task

Other samples are available in the documentation, or you download them from the Samples and Assets site.

You have two options available for installation: Install or Modify. The Install option assumes that you are installing the application on a clean server or workstation. That means that the server or workstation does not have any InfoSphere MDM components that are already installed (for example the MDM operational server, database component, or another user application). If any MDM components are present on the machine on which you are installing the application, you must use the Modify option.

Procedure

1. Start IBM Installation Manager.
2. On the IBM Installation Manager home panel, select **Install** or **Modify**.
3. If you selected **Install**, complete these steps.
 - a. On the Install Packages panel, select the InfoSphere MDM offering and click **Next**.

- b. Continue through the panels to accept the license agreement, select the installation directory, and the language.
 - c. On the Install Packages panel, select **Samples**. Click **Next**.
 - d. Review the installation summary information and click **Install**.
4. If you selected **Modify**, complete these steps.
 - a. On the Modify Packages panel, select the InfoSphere MDM package and click **Next**.
 - b. Select the language and click **Next**.
 - c. On the Modify Packages panel, select **Samples**. Previously installed components are automatically selected. Make sure that they remain selected, otherwise IBM Installation Manager removes them. Click **Next**.
 - d. Enter the configuration information for the application. Use the MDM user applications worksheet as a guideline. Click **Next**.
 - e. Review the summary information and verify that the component that you want to install is listed in the Adding Features box and that no components are listed in the Removing Features box. Click **Modify**.
 5. Click **Finish** when the installation is complete and close IBM Installation Manager.
 6. Verify that the sample files have been created in the *MDM_INSTALL_HOME* directory.

Installing the samples from the Samples and Assets site for InfoSphere MDM

An access key in a text file on IBM Passport Advantage is required to download samples. Then to install them, you decompress the downloaded file on your local computer.

About this task

Other samples are available in the documentation, or you install them along with the editions, by using IBM Installation Manager.

Procedure

1. Obtain the access key for the samples:
 - a. Log in to IBM Passport Advantage and search for the samples eAssembly.

Tip: Expand the eAssembly listing to select the item to download.
 - b. Download the eAssembly and decompress the downloaded file. The access key is in a text file that is inside the downloaded file.
2. Download the samples:
 - a. Log in to the Samples and Assets site, select the package, and click **Continue**.
 - b. Enter the access key for the samples and other information to complete the download process.
3. Install the samples, by decompressing the files on your local computer.

What to do next

For some samples, you complete extra setup steps.

Related reference:

 IBM Passport Advantage

Verifying the base installation

The IBM Installation Manager automatically runs a verification routine to test the installation by running three physical transactions to add a person, an organization, and a contract, and one virtual transaction. If these transactions are successful, then the installation completes successfully.

Additionally, you can use the Test Client to run test transactions to ensure that InfoSphere MDM is installed correctly.

Related tasks:

Chapter 3, “Installing the product,” on page 19

“Installing a stand-alone server with DB2” on page 58

“Installing a stand-alone workstation installation with DB2” on page 65

“Installing a custom deployment of InfoSphere MDM” on page 113

“Installing InfoSphere MDM into a clustered environment” on page 124

Troubleshooting an installation

Related reference:

Chapter 2, “Installation overview,” on page 7

“User accounts, groups, and defaults used by the installation application” on page 12

Verifying the installation with the Test Client on WebSphere Application Server

Verify your installation with the application server Test Client, which completes a number of preset test cases.

About this task

The Test Client only supports DB2 and Oracle databases.

Procedure

1. In the `TestClient.properties` file in the `MDM_INSTALL_HOME/IVT/properties` folder, enter the user name at `user=` and the password at `password=` if application security is enabled.
2. Edit any other required properties to create the parameters for the test you want to run. For information about the properties you can edit, see the test client properties topic.
3. Go to the `MDM_INSTALL_HOME/IVT` directory:
4. Clear the data by following the steps for your installation type:
 - Run the following script at the command line to clear the data if you installed InfoSphere MDM on Oracle:

```
sqlplus <DB_USER>/<DB_PASSWORD>@TNS0./sql/clearOperationData.sql
```
 - Take these steps to clear the data if you installed InfoSphere MDM on DB2:
 - a. Connect to the DB2 database.
 - b. Clear the DB2 data by running the following script at the command line:

```
db2 -tvf ./sql/deleteIVTdata
```
5. From the command line, to run the test cases, run the script:

TestClient.sh *TEST_CHANNEL XML_FOLDER [USER_NAME PASSWORD]* where:

- *TEST_CHANNEL* is the method to send the test cases to the server, either:
 - For RMI, enter rmi
 - For HTTP, enter soap
 - For JMS, enter jms
- *XML_FOLDER* is the folder that contains the XML test cases that you want to run, either:
 - For TCRM test cases, enter ./testCases/xml
 - For virtual MDM test cases, enter ./testCases/xml_virtual
 - For admin test cases, enter ./testCases/xml_admin
 - For TCRM composite test cases, enter ./testCases/xml_composite
 - For a messaging test case, enter ./testCases/xml_msg
- If security is enabled, enter the user name to log on to the system at *USER_NAME*
- If security is enabled, enter the password for the user name at *PASSWORD*

For example, to run the admin test cases on WebSphere Application Server through HTTP with security not enabled, enter

```
TestClient.sh soap testCases/xml_admin
```

6. When the test is complete, you can see the results in the following directories:
 - To see the responses that were created by the tests, check the ./response folder for each test case (such as ./testCases/xml/response).
 - To see the logs, the list of test cases run, and their statuses, check the log files in *MDM_INSTALL_HOME/IVT/logs*.

Example

The following table shows the tests, with corresponding command lines, that you can run:

Table 30. Installation verification tests

To run the test:	Use the command:
To provide a request file to run single TCRM test case	TestClient.sh rmi ./testCases/xml/TCRMaddPerson.xml
To run JMS test cases	Provide the queue connection factory, request queue name, and response queue name in the TestClientJMS.properties file, then run TestClient.sh jms ./testCases/xml
To run messaging test cases	<ul style="list-style-type: none"> • For Oracle: <ol style="list-style-type: none"> 1. Run @./sql/Oracle/update_event_active.sql to activate an event 2. Restart WebSphere Application Server 3. Run TestClientWL.sh rmi ./testCases/xml_msg • For DB2: <ol style="list-style-type: none"> 1. Run IVT/sql/db2/update_event_active.sql to activate an event 2. Restart the WebSphere Application Server 3. Run TestClientWL.sh rmi ./testCases/xml_msg

Table 30. Installation verification tests (continued)

To run the test:	Use the command:
To run the admin test cases	TestClient.sh rmi ./testCases/xml_admin

Test Client properties

You can edit the entries in the TestClient.properties file in the `MDM_INSTALL_HOME/IVT/properties` folder to set the parameters for the test.

Table 31. Properties that can be set in the Test Client properties file

To set the parameter for:	Set the following parameter to:
To run test cases without sorting	sort=
To sort the test cases by directory. See regex=for sort criteria	sort=d
To sort the test cases. See regex=for sort criteria	sort=f
To sort directories and test cases. See regex=for sort criteria	sort=d f
To extract the first match as sorting comparison key. The sort order is based on the key. The default is to extract the last digital number from request file.	regex= [0-9]*[0-9]\$
To sort by string order	regex=
To add a user name	user=
To add a password	password=
To test the extracted value by using a regular expression	java -cp ./lib/TestClient.jar -regex tcrmtest_001
For information about using Java to run test cases	java -cp ./lib/TestClient.jar ?
To use the MDM JMS adapter, enter the queue connection factory name	QueueConnectionFactory=
Enter the request queue destination name	RequestQueue=
Enter the response queue destination name	ResponseQueue=

Installation logs

There are two types of logs that are created during the installation process. One set logs IBM Installation Manager related information and the other logs InfoSphere MDM related information.

The location of IBM Installation Manager logs depends on how the application was installed. If IBM Installation Manager was installed in admin mode (root user on UNIX), the logs are in `/var/ibm/InstallationManager/logs`. If the application was not installed in admin mode, the logs are in `$HOME/var/ibm/InstallationManager/logs`.

You can also specify a location for the IBM Installation Manager logs by updating the Agent Location variable (`cic.appDataLocation`) in the `config.ini` file. The `config.ini` is in the `InstallationManager_INSTALL_HOME/eclipse/configuration` directory.

InfoSphere MDM logs are in the `MDM_INSTALL_HOME/logs/database` directory.

The following directories contain logs that are created when the physical MDM database SQL scripts are run (by manual installation and by the installer):

- `MDM_INSTALL_HOME/logs/database/DomainData`
- `MDM_INSTALL_HOME/logs/database/CoreData`
- `MDM_INSTALL_HOME/logs/database/CMData`

Log files that are created by bootstrapping a virtual MDM database that uses ODBC are in `MDM_INSTALL_HOME/logs/database/Virtual`

Viewing Installation Manager log files

The IBM Installation Manager application creates log files during the installation process. These logs can be viewed through a browser.

Before you begin

You must have a browser available in which to view the log files. If you are on a server that does not have a browser, copy the logs to a workstation.

About this task

The logs contain messages with INFO, DEBUG, WARNING, or ERROR labels. If the installation is successful, all messages have an INFO or DEBUG label. Messages that are identified as WARNING or ERROR must be reviewed.

Procedure

1. Go to the `./InstallationManager/logs` directory.
2. Open the `index.xml` file.
3. From the **All Log Files** table, click a link that corresponds to the IBM Installation Manager session that installed InfoSphere MDM.
4. Locate the following link: **Custom operation MDM Operational Server, verifying install location in unit mdmv.app.set.install.location**.
That link, and subsequent links, show installation process messages.
5. Look for messages that are identified as WARNING or ERROR. The messages must be reviewed to identify potential problems with your installation.
6. Click a link to view native log file representations of an installation process segment.

Such processes can include running custom Java code to manage InfoSphere MDMfiles, to run the **madconfig** utility Ant-based tool that in turn runs SQL scripts, and to implement the WebSphere Application Server MBean API that deploys InfoSphere MDM deployment archives like EBA and EAR files, and other actions.

Results

If you have messages that are identified as WARNING or ERROR, try to determine the cause of the issue by searching for Java or Ant exception errors. If you locate a

workaround for the WARNING or ERROR, attempt to fix the installation or contact IBM Software Support.

Related tasks:

Troubleshooting an installation

Viewing the InfoSphere MDM installation logs

During the installation process, logs are created in the *MDM_INSTALL_HOME/logs/* database directory. Use these logs to help you when troubleshooting or verifying your installation.

About this task

Logs are stored in .xml files with the date and time of the installation as the file name. For example, a file with the name 20130312_1101.xml, indicates the installation occurred on March 12, 2013 at 11:01. You can access the logs in two different ways.

Procedure

- On the final IBM Installation Manager panel after the installation is complete, click **View Log File**.
- Go to the *MDM_INSTALL_HOME/logs/database* directory and open the .xml file.

Related concepts:

“Installing client applications and individual components” on page 149

Related tasks:

Chapter 3, “Installing the product,” on page 19

Troubleshooting an installation

Related reference:

“Silent installation” on page 132

Modifying your installation

Use this procedure to install other InfoSphere MDM components on a workstation or server that already has components of the same version installed.

Procedure

1. Start IBM Installation Manager and click **Modify**.
2. Select the InfoSphere MDM package and click **Next**.
3. Select the language and click **Next**.
4. On the Modify Packages panel, select the component that you want to install. Previously installed components are automatically selected. Make sure that they remain selected, otherwise IBM Installation Manager removes them. Click **Next**.
5. Review the summary information and verify that the component that you want to install is listed in the Adding Features box and that no components are listed in the Removing Features box. Click **Modify**.
6. On the final IBM Installation Manager panel, click **View Log Files** if you want to open the log file viewer.
7. Click **Finish** and close IBM Installation Manager.

What to do next

A message on the final installer panel indicates whether the installation modification was successful or not. If the modification was unsuccessful, then there will be an error message and a log file that you can review. You can also view the log files after a successful modification. Use the troubleshooting topics to assist you with errors.

Related concepts:

“Installing client applications and individual components” on page 149

Related tasks:

“Installing InfoSphere MDM into a clustered environment” on page 124

Troubleshooting an installation

“Separating configuration from installation” on page 120

Adding a new node to an existing cluster

To add a new InfoSphere MDM node member to an existing IBM WebSphere Application Server cluster, you must create the node, attach it to the cluster, and then configure the node-cluster relationship.

About this task

A node in a WebSphere Application Server cluster is defined as a profile. It can exist on a separate machine or on a machine that already has one or more existing profiles configured.

Procedure

1. Create a new InfoSphere MDM node and attach it to an existing WebSphere Application Server cluster by running the following command from a command line on the application server:

```
cd /opt/IBM/WebSphere/AppServer/bin
./manageprofiles.sh -create -profileName profile_name -profilePath
/opt/IBM/WebSphere/AppServer/profiles/profile_name -templatePath /opt/IBM/WebSphere/AppServer/
profileTemplates/managed -federateLater false
-dmgrAdminUserName username -dmgrAdminPassword password -dmgrHost
dmgr_host -dmgrPort dmgr_port
```

Replace the variables in the command with the appropriate profile name, path, user name, password, DMgr host, and DMgr port with the values appropriate for your deployment. For example:

```
cd /opt/IBM/WebSphere/AppServer/bin
./manageprofiles.sh -create -profileName AppSrv03 -profilePath /opt/IBM/WebSphere/AppServer/profiles/AppSrv03
-templatePath /opt/IBM/WebSphere/AppServer/profileTemplates/managed
-federateLater false -dmgrAdminUserName perf01
-dmgrAdminPassword perf01 -dmgrHost warhol-10ge -dmgrPort 8879
```

When the command completes, an additional node will appear in the WebSphere Application Server Integrated Solutions Console (admin console).

2. Navigate to **System administration > Nodes** to confirm that the new node is present.
3. Add a new server instance to the cluster on the new node:
 - a. In the WebSphere Application Server Integrated Solutions Console, navigate to **WebSphere application server clusters > SECluster > Cluster members** and click **New**.
 - b. Give a name to the new member, select the new node from the drop down list, then save and synchronize the settings.

- c. Navigate to **WebSphere application server clusters > SECluster > Cluster members** to confirm that the new member is present in the list of nodes.
4. Add a new row in the APPINSTANCE table to represent your new node:

```
id|1000|server_name|current_timestamp|installer
```

Replace the variables in the row with the appropriate details of your node.

5. Run madconfig tasks to configure the new node:
 - a. Copy the file `MDM_INSTALL_HOME/properties/install_native_engine.ear.properties` to the folder `MDM_INSTALL_HOME/mds/scripts`, and rename the copied file `install_native_engine.ear.local.properties`.
 - b. In `install_native_engine.ear.local.properties`, modify all of the encrypted passwords to plain text passwords.

Tip: The value of the `trustFilePwd` property is WebAS.

- c. In addition to the passwords, modify or add the following properties:

```
cluster.flag=false
cluster=None
node=node_name
server=server_name
configForNewNode=true
```

- d. Run the `install_native_engine` madconfig script using the following command:

```
MDM_INSTALL_HOME/mds/scripts/madconfig.sh install_native_engine.ear
```

- e. Copy the file `MDM_INSTALL_HOME/properties/install_server_config.properties` to the folder `MDM_INSTALL_HOME/mds/scripts`, and rename the copied file `install_server_config.local.properties`.

- f. In `install_server_config.local.properties`, modify all of the encrypted passwords to plain text passwords.

Tip: The value of the `trustFilePwd` property is WebAS.

- g. In addition to the passwords, modify or add the following properties:

```
cluster.flag=false
cluster=None
node=node_name
server=server_name
configForNewNode=true
```

- h. Run the `install_server_config` madconfig script using the following command:

```
MDM_INSTALL_HOME/mds/scripts/madconfig.sh install_server_config
```

- i. Run the `map_roles_to_users` madconfig script using the following command:

```
MDM_INSTALL_HOME/mds/scripts/madconfig.sh map_roles_to_users
```

- j. Provide the following details for the `map_roles_to_users` script:

- EBA prefix: `com.ibm.mdm.hub.server.app`
- WAS application name: `MDM-web-services-instance_id`.

Note: You can find the application name in the Integrated Solutions Console.

- BLA user: the admin user of InfoSphere MDM, such as `mdmadmin`.
 - BLA password: the password of the InfoSphere MDM admin user
- k. Run the `full_sync` madconfig script using the following command:

```
MDM_INSTALL_HOME/mds/scripts/madconfig.sh full_sync
```

1. Delete the local.properties files that you created in `MDM_INSTALL_HOME/mds/scripts`.

Important: These files must be deleted as soon as possible. They represent a potential security issue because they contain plain text passwords.

6. Restart the WebSphere Application Server cluster.

Related tasks:

Preparing your DB2 database to use InfoSphere MDM in a clustered environment

“Preparing your Oracle database to use InfoSphere MDM in a clustered environment” on page 89

“Installing InfoSphere MDM into a clustered environment” on page 124

Updating the deployed properties files for physical MDM

After you install or upgrade InfoSphere MDM, you might need to update the deployed properties files if they require changes that cannot be made by using the Configuration Manager. Use this procedure to update deployed properties files.

About this task

Attention: Updating properties dynamically is not ideal. Whenever possible, port your custom properties to the Configuration Manager.

Because the properties files are packaged in a .jar and deployed as a business level application (BLA) shared library asset, they cannot be changed by only altering a property value. When installed, a duplicated properties.jar file is extracted to a deployment subdirectory of the BLA composition unit. This extraction allows updates to be done in near real time without having to reinstall the enterprise bundle application (EBA). For example, if the name of the application deployment is E001 and the WebSphere Application Server installation home directory is `opt/IBM/WebSphere/AppServer/`, then the location of deployed property files is in the installed asset directory of the application profile. In this case, `opt/IBM/WebSphere/AppServer/profiles/Node01/installedAssets/com.ibm.mdm.server.resources.properties-E001.jar/BASE`

You can modify the content of the JAR file directly on the node. In a multinode or cluster topology, the changes must be manually replicated to all nodes and servers. The best way to update the properties is by using the WebSphere Application Server Integrated Solutions Console (admin console), which handles the propagation for you.

Procedure

1. Start the WebSphere Application Server Integrated Solutions Console and go to **Applications > Application Types > Assets**.
 - a. Select the `com.ibm.mdm.server.resources.properties-deployment_name_used_for_install.jar` file.
 - b. Click **Export** to export the currently deployed properties. From here, you can download the library to your local system for updating.
2. Edit the values and files by using the expanded properties files of the `com.ibm.mdm.server.resources.properties-deployment_name_used_for_install.jar` package that you downloaded in step 1.

3. Repackage the changed properties into a new `com.ibm.mdm.server.resources.properties-deployment_name_used_for_install.jar` file. Ensure that you keep the same name as the original library.
4. In the WebSphere Application Server Integrated Solutions Console, select the `com.ibm.mdm.server.resources.properties-deployment_name_used_for_install.jar` file again.
 - a. Click **Update**.
 - b. On the next screen, choose the type of update you want and select the new properties JAR. For example: select the **Replace entire asset** option along with the new or updated properties JAR. Updating the properties asset by using this option automatically propagates the changes to all nodes and servers.
5. After the update is complete, you must restart the BLA application.

Chapter 4. Applying fix packs

When IBM releases a fix pack for InfoSphere MDM, you can apply it using IBM Installation Manager.

About this task

To apply a fix pack, you must download and extract the fix pack artifacts, then run a command line tool to configure the fix pack. Optionally, you can configure the fix pack to skip specified components if you do not wish to apply the fixes for any reason.

If necessary, you can use IBM Installation Manager to roll back an applied fix pack.

Downloading and installing a fix pack

Use IBM Installation Manager to download and extract the fix pack artifacts, then run a script to install the fix pack files.

Before you begin

- Ensure that you have updated the installation application, if applicable.
- Review the Installation Manager documentation to learn about using Update mode to locate and download fix packs. See the related links for details.
- If you are behind a firewall, configure your proxy to ensure that Installation Manager can connect to the predefined fix pack repository. See the related links for details.

About this task

Restriction: You cannot install both the full InfoSphere MDM product and a fix pack in a single Installation Manager session. You must fully install InfoSphere MDM first in Installation Manager Install mode, and then apply the fix pack in a second Installation Manager session in Update mode.

Procedure

1. Start IBM Installation Manager.
2. Click **Update**.
3. Select **Update all**, then click **Next**.
4. Read and accept the license terms.
5. On the Upgrade Summary page, read about the fix pack and the issues that it resolves, then click **Upgrade**. Installation Manager downloads and extracts the fix pack artifacts into the file system. You will find the extracted fix pack files in `<MDM_INSTALL_HOME>/updates/<fix_pack_version>`.

Important: If you wish to exclude any InfoSphere MDM components from being updated by the fix pack, you must modify the extracted `FeatureFixpackApplied.properties` file before completing this procedure. See the related links for details.

6. Open a command prompt and navigate to `<MDM_INSTALL_HOME>/mds/scripts`.
7. Run the script to apply the fix pack: `./madconfig.sh Apply_Fixpack`

Related tasks:

“Excluding specified components from a fix pack”

Related information:

 IBM Installation Manager: Updating packages using wizard mode

 IBM Installation Manager: Internet preferences

Excluding specified components from a fix pack

If you wish to exclude any InfoSphere MDM components from being updated by a fix pack, you must modify the extracted `FeatureFixpackApplied.properties` file before running the script that installs the fix pack.

Before you begin

You must already have downloaded and extracted the fix pack artifacts before you can complete this procedure. See the related links for details.

About this task

If your InfoSphere MDM instance includes components that have been modified or extended, then you may wish to exclude those components from being updated by a fix pack. For example, if you have made changes to a specific InfoSphere MDM user interface, then you can choose to exclude that user interface from the fix pack update to preserve your customizations.

Procedure

1. Navigate to `<MDM_INSTALL_HOME>/backup/<fix_pack_version>`.
2. Open `FeatureFixpackApplied.properties`.
This properties file contains a list of properties, with each property corresponding to an InfoSphere MDM component. You can choose to include or exclude each component in the fix pack update. By default, all of the component properties have a value of `NO`, meaning that the component is not excluded, and will be updated.
3. To exclude a component from being updated by the fix pack, change its corresponding value to `YES`.
4. Save any changes in the file. When you run the fix pack installation script, components that you marked `YES` will not be updated.

Related tasks:

“Downloading and installing a fix pack” on page 169

Rolling back an applied fix pack

If you have applied a fix pack, but later determine that you wish to remove it, you can roll back the updates.

Procedure

1. Refer to the readme file that was included with the fix pack (IBM InfoSphere Master Data Management Readme for `<fix_pack_version>.htm`) for details about how to manually roll back the fix pack. Manual rollback is the first step in the rollback process.
2. Remove the fix pack from IBM Installation Manager.
3. Start Installation Manager and select **Roll Back**, then click **Next**.

4. Select the version that you want to roll back, then click **Next**.
5. Click **Roll Back**. Installation Manager will complete the rollback process.

Chapter 5. Troubleshooting installations of Standard or Advanced Editions

If the installation of the Standard or Advanced Editions fails, you can try troubleshooting steps and review the known errors.

Symptoms

After the installation is complete, you might see error messages in IBM Installation Manager on the Installation Complete panel. You might also see errors in the installation logs or from the installation verification tests.

A success message on the final installer panel indicates that the verification tests were automatically run as part of the installation process.

For database, application server, or IBM Installation Manager problems, use their tools to diagnose and correct individual error conditions.

Resolving the problem

1. Review the messages in the installation logs to locate error conditions.
2. Review the error conditions that are described in the error topics for solutions or workarounds. The documented errors are not a comprehensive list of all the errors that you might encounter. If the error that you are seeing in your logs is not listed, contact IBM Software Support.
3. After you correct the errors, rerun the installation program.

Related tasks

Verifying the installation with the Test Client on WebSphere Application Server
Viewing the InfoSphere MDM installation logs

Installation errors

The errors that are listed are a sampling of the errors that you might encounter during MDM installation. This list is not a comprehensive list of all the errors. If the error that you are seeing in your logs is not listed, contact IBM Software Support.

Attention: The log content that you see in the error topics are only examples. Actual log file names, paths, time stamps, and so on that you see in your implementation are different from what is shown in the examples.

Related information

 [IBM Installation Manager documentation](#)

Installation error: Access is denied for the checkIfAppExists operation on AppManagement MBean

Access is denied for the checkIfAppExists operation on AppManagement MBean.

Description

During an uninstall, if the wrong SOAP password is entered on the uninstall panel, the uninstall can fail. If this problem occurs, the installer interrupts the uninstall session and shown an error message.

The error message is similar to this IBM Installation Manager log file example message:

```
Error uninstalling. CRIMA1076E: Error executing
"/opt/IBM/MDM/E455/mdm/mds/scripts/madconfig.sh" operation (status=255).
See agent output log for more information:
/home/var/ibm/InstallationManager_LocalTesting_AE007/logs/native/TIME_STAMP.log
CRIMA1076E: Error executing "/opt/IBM/MDM/E455/mdm/mds/scripts/madconfig.sh"
operation (status=255). See agent output log for more information:
/home/var/ibm/InstallationManager_LocalTesting_AE007/logs/native/TIME_STAMPa.log
CRIMA1076E: Error executing "/opt/IBM/MDM/E455/mdm/mds/scripts/madconfig.sh"
operation (status=1). See agent output log for more information:
/home/var/ibm/InstallationManager_LocalTesting_AE007/logs/native/20130506_1551b.log
CRIMA1076E: Error executing "/opt/IBM/MDM/E455/mdm/mds/scripts/madconfig.sh"
operation (status=1). See agent output log for more information:
/home/var/ibm/InstallationManager_LocalTesting_AE007/logs/native/TIME_STAMPc.log
CRIMA1076E: Error executing "/opt/IBM/MDM/E455/mdm/mds/scripts/madconfig.sh"
operation (status=255). See agent output log for more information:
/home/var/ibm/InstallationManager_LocalTesting_AE007/logs/native/TIME_STAMP.log
CRIMA1076E: Error executing "/opt/IBM/MDM/E455/mdm/mds/scripts/madconfig.sh" operation
(status=255). See agent output log for more information:
/home/var/ibm/InstallationManager_LocalTesting_AE007/logs/native/TIME_STAMP.log
Buildfile: build.xml

uninstall_mds_ws_api:
.....
trustFilePwd is *****
com.ibm.websphere.management.exception.AdminException:
  at com.ibm.websphere.management.application.AppManagementProxy.proxyInvoke
(AppManagementProxy.java:192)
  at com.ibm.websphere.management.application.AppManagementProxy.checkIfAppExists
(AppManagementProxy.java:269)
  at com.ibm.mdm.de.config.appserver.core.MDSAppDeploy.checkIfAppExists
(MDSAppDeploy.java:165)
  at com.ibm.mds.de.config.appserver.configurator.MSDSDeployAppConfigurator.configure
(MSDSDeployAppConfigurator.java:24)
  at com.ibm.mdm.de.config.appserver.remoteclient.command.MSDSDeployAppRemoteCommand.performUninstall
(MSDSDeployAppRemoteCommand.java:36)
  at com.ibm.mdm.de.config.appserver.remoteclient.command.MSDSDeployAppRemoteCommand.execute
(MSDSDeployAppRemoteCommand.java:22)
  at com.ibm.mdm.de.config.appserver.remoteclient.MDSRemoteClient.execute
(MDSRemoteClient.java:26)
  at com.ibm.mdm.de.ant.task.UninstallMDSWSAPITask.execute(UninstallMDSWSAPITask.java:84)
  at org.apache.tools.ant.UnknownElement.execute(UnknownElement.java:275)
  at org.apache.tools.ant.Task.perform(Task.java:364)
```

Solution

If the uninstallation of the MDM database was successful, but the uninstall of the InfoSphere MDM operational server failed, then you must uninstall the operational server manually.

1. Uninstall the InfoSphere MDM deployment modules, business-level applications, by using IBM WebSphere Application Server Integrated Solutions Console.
2. Uninstall the `com.ibm.mdm.hub.server.app-<>.eba` and `com.ibm.mdm.server.resources.properties-<>.jar` assets by using IBM WebSphere Application Server Integrated Solutions Console.
3. Uninstall the local repository bundles: `com.ibm.mdm.mds.api.app`, `com.ibm.mdm.mds.jni.app`, `com.ibm.mdm.server.jaxrpcws.cba`, and `com.ibm.mdm.thirdparty.cba` by using IBM WebSphere Application Server Integrated Solutions Console.
4. Delete the deployment target (server or cluster) to drop InfoSphere MDM configuration objects such as JDBC Providers, data sources, and messaging provider.

Installation error: AdminTask

An AdminTask error can cause an installation failure.

Description

This problem might cause the InfoSphere MDM installation to fail and trigger a complete installation rollback. This issue might happen when you are installing the Business Administration UI, Data Stewardship UI, or Product Maintenance UI applications as part of the InfoSphere MDM installation. The issue is related to the ability of the IBM WebSphere Application Server Deployment Manager to interact with the InfoSphere MDM installation application. If encountered, the installation session is stopped, an error message is issued, and the installation rollback is triggered.

The warning message is similar to this IBM Installation Manager log file example message:

```
Error occurred in phase: install SU: com.ibm.mdm.ba.webapp 11.0.0.v20130410-1220
IU: com.ibm.mdm.ui.ba.config.server_create.config.objects.on.server
null->11.0.0.v20130410-1220
Message: Error executing the /usr/IBM/WebSphere/AppServer8502ND/bin/wsadmin.sh
command: status=105. For more information, see the agent log file:
/home/ws8admin/var/ibm/InstallationManager_H001/logs/native/TIME_STAMP.log

WASX7209I: Connected to process "dmgr" on node myCellManager01 using SOAP connector;
The type of process is: DeploymentManager
WASX8011W: AdminTask object is not available.
WASX7303I: The following options are passed to the scripting environment and are available
as arguments that are stored in the argv variable:
"[myCell01, None, myNode01, mdm-s3-H080, default_host]"
Setting up application server and VirtualHost for WCC UIs...
  Cell name           :myCell01
  Cluster name        :None
  Node name           :myNode01
  Server name         :mdm-s3-H080
  VirtualHost Name    :default_host
Setting up server mdm-s3-H080 at node myNode01 in cell myCell01...
  Server 'mdm-s3-H080' does not exist. Creating new server from template 'default'...

server is 'mdm-s3-H080'
Adding new alias with ports to virtual host...
  WC_defaulthost Port to be added : 9080
  WC_defaulthost_secure Port to be added : 9443
Added new alias with ports to virtual host!!

Added ORB timeout for server:mdm-s3-H080
modify cookie security
create property com.ibm.ws.webcontainer.HTTPOnlyCookies
WASX7017E: Exception received while running file
"/usr/IBM/MDM/H080/Shared/tmp/script/wccUISetupAppServer.py";
exception information: com.ibm.bsf.BSFException: exception from Jython:
Traceback (innermost last):
File "<string>", line 198, in ?
File "<string>", line 131, in createProperty
NameError: AdminTask

WASX7341W: No "save" was performed before the interactive scripting session exited;
configuration changes will not be saved.
```

Solution

1. Increase the IBM WebSphere Application Server Deployment Manager JVM heap size to 1024/2048.
2. Run the MDM installation again.
3. Avoid use of the IBM WebSphere Application Server Integrated Solutions Console during the MDM installation.

Installation error: AdminTask object is not available

AdminTask object is not available.

Description

This error can cause the IVT response file to show a failure because of a problem that occurred when the installer attempt to process Role Mapping settings. This problem is related to the ability of IBM WebSphere Application Server Deployment Manager to interact with the InfoSphere MDM installation application. If this problem occurs, the installer can reach the end of the installation, but indicates that IVT (Installation Verification Tool) is not successful.

IVT shows the following exception:

```
CORBA NO_PERMISSION 0x0 No; nested exception is:
org.omg.CORBA.NO_PERMISSION:
>> SERVER (id=5b5ab1aa, host=evg01.torolab.ibm.com) TRACE START:
>> org.omg.CORBA.NO_PERMISSION: java.rmi.AccessException: ; nested exception is:
com.ibm.websphere.csi.CSIAccessException: SECJ0053E: Authorization failed
for defaultWIMFileBasedRealm/mdmadmin while invoking
(Home)com.ibm.mdm.hub.server-
E457..11.0.0..com.ibm.mdm.server.dwlcommonservlets.ejb..11.0.0.FP00IF000_20130503-1713.war
#com.ibm.mdm.server.dwlcommonservlets.ejb..11.0.0.FP00IF000_20130503-1713.war
#DWLServiceController create::2 is not granted any of the required roles:
ServiceConsumer ServiceProvider vmcid: 0x0 minor code: 0 completed: 0
>> at com.ibm.ws.security.core.SecurityCollaborator.performAuthorization(SecurityCollaborator.java:626)
>> at com.ibm.ws.security.core.EJSSecurityCollaborator.preInvoke(EJSSecurityCollaborator.java:265)
>> at com.ibm.ejs.container.EJSContainer.EjbPreInvokeForStatelessCreate(EJSContainer.java:4561)
>> at com.dwl.base.requestHandler.beans.EJSRemoteCSLDWLServiceControllerHome_2c54996d.create
(EJSRemoteCSLDWLServiceControllerHome_2c54996d.java)
>> at com.dwl.base.requestHandler.beans._EJSRemoteCSLDWLServiceControllerHome_2c54996d_Tie.create
(_EJSRemoteCSLDWLServiceControllerHome_2c54996d_Tie.java:1)
>> at com.dwl.base.requestHandler.beans._EJSRemoteCSLDWLServiceControllerHome_2c54996d_Tie._invoke
(_EJSRemoteCSLDWLServiceControllerHome_2c54996d_Tie.java)
>> at com.ibm.CORBA.iiop.ServerDelegate.dispatchInvokeHandler(ServerDelegate.java:669)
>> at com.ibm.CORBA.iiop.ServerDelegate.dispatch(ServerDelegate.java:523)
>> at com.ibm.rmi.iiop.ORB.process(ORB.java:523)
>> at com.ibm.CORBA.iiop.ORB.process(ORB.java:1575)
>> at com.ibm.rmi.iiop.Connection.doRequestWork(Connection.java:3039)
>> at com.ibm.rmi.iiop.Connection.doWork(Connection.java:2922)
>> at com.ibm.rmi.iiop.WorkUnitImpl.doWork(WorkUnitImpl.java:64)
>> at com.ibm.ws.giop.threadpool.WorkQueueElement.dispatch(WorkQueueElement.java:165)
>> at com.ibm.ws.giop.filter.GiopFilterChain.processMessage(GiopFilterChain.java:203)
>> at com.ibm.ws.giop.threadpool.PooledThread.handleRequest(PooledThread.java:81)
>> at com.ibm.ws.giop.threadpool.PooledThread.run(PooledThread.java:102)
>> at com.ibm.ws.util.ThreadPool$Worker.run(ThreadPool.java:1814)
>> SERVER (id=5b5ab1aa, host=evg01.torolab.ibm.com) TRACE END.
vmcid: 0x0 minor code: 0 completed: 0
```

The warning message is similar to this IBM Installation Manager log file example message:

```
Problem with executing "/usr/IBM/WebSphere/AppServer8502ND/bin/wsadmin.sh"
operation (status=105). See agent output log for more information:
/home/ws8admin/var/ibm/InstallationManager_H001/logs/native/TIME_STAMP.log
/home/ws8admin/var/ibm/InstallationManager_H001/logs/native/TIME_STAMP.log
shows message similar to following
WASX7209I: Connected to process "dmgr" on node myCellManager01 using SOAP
connector; The type of process is: DeploymentManager
WASX8011W: AdminTask object is not available.
WASX7303I: The following options are passed to the scripting environment and
are available as arguments that are stored in the argv variable:
"[--blaname, MDM-operational-server-EBA-H085, --ebaPrefix, com.ibm.mdm.hub.server.app,
--blaname, mdmadmin, --wsName, MDM-web-services-H085,
--blaname, mdmadmin]"
Configuring application security
-----
AdminBLA: List composition units in a BLA
BLA ID (or BLA name): MDM-operational-server-EBA-H085
Optional parameter:
Display description:
Usage: AdminBLA.listCompUnits("MDM-operational-server-EBA-H085", "")
Return: List the composition units within the specified business-level application.
-----
```

```
Exception: exceptions.NameError AdminTask
WASX7017E: Exception received while running file
```

```
"/usr/IBM/MDM/H085/Shared/tmp/script/RoleMapping.py"; exception information:  
com.ibm.bsf.BSFException: exception from Jython:  
Traceback (innermost last):  
File "<string>", line 144, in ?  
File "<string>", line 28, in retrieveCompUnitID  
File "/usr/IBM/WebSphere/AppServer8502ND/scriptLibraries/application/V70/AdminBLA.py",  
line 763, in listCompUnits  
ScriptLibraryException: : 'exceptions.NameError AdminTask'
```

Solution

1. Increase the IBM WebSphere Application Server Deployment Manager JVM heap size to 1024/2048.
2. Run the InfoSphere MDM installation again.
3. Avoid use of the IBM WebSphere Application Server Integrated Solutions Console during the InfoSphere MDM installation.

Installation error: Bind process is not active

[DB2 JDBC Driver]Bind process is not active.

Description

On IBM DB2 for z/OS, the DB2 Wire Protocol driver does not work properly unless the appropriate packages exist on every server to which you intend to connect. Your user ID must have BINDADD privileges so that the driver can create and bind packages. If the bind packages are not in place, then the following message is shown when testing connections for the InfoSphere MDM datasource on the operational server:

```
java.sql.SQLException: [IBM][DB2 JDBC Driver]Bind process is not active.  
Please ensure that the user has permissions to create packages.  
Packages cannot be created in an XA Connection. DSRA0010E: SQL State = HY000, Error Code = 0.
```

Solution

Ensure that your database user ID has BINDADD privileges on the MDM database:

1. Log in as the database administrator (DBA) user.
2. Connect to the MDM database.
3. Grant BINDADD privileges to the database user (*dbuser*).
4. Log out from the DBA user account.
5. Log in with the database user account. When the database user account connects to the database with the DB2 Wire Protocol driver, the correct package is created automatically.

Note: By default, the packages contain 200 dynamic sections and are created in the collection named NULLID.

For additional details on this issue, see the related links.

Related information

 [The DB2 Wire Protocol Driver and Packages](#)

Installation error: Blank page displays after logging in to UI

After you log in to the Business Administration UI, Data Stewardship UI or Product Maintenance UI, you might encounter a blank page.

Description

Authentication error message can be found in the IBM WebSphere Application Server SystemOut.log file. The blank page can be caused by a security role to user/group mapping for the application. To verify whether the blank page is a role mapping issue:

1. Open the IBM WebSphere Application Server Integrated Solutions Console.
2. From **Applications > Application Types > WebSphere enterprise applications**, select the UI application.
3. Click **Security role to user/group mapping** and verify that all roles are set to **None**.

Solution

1. On the UI application page, select the role.
2. Click **Map Special subjects** and then select **All Authenticated in Application's Realm**.
3. Click **OK** to save.
4. Restart the server.

Installation error: Cannot add asset com.ibm.mdm.hub.server.app.eba

Cannot add the asset com.ibm.mdm.hub.server.app-*name*.eba.

Description

This error means the IVT response file is not available because there was a problem in deploying the Enterprise Bundle Archive (EBA). During InfoSphere MDM installation, if the IBM WebSphere Application Server is unable to deploy the com.ibm.mdm.hub.server.app-*name*.eba file, this error is logged. The EBA file is one of the InfoSphere MDM installation deployment archives. If this issue occurs, the installer can process to the end of the installation tasks and install InfoSphere MDM, but an indication that the IVT (Installation Verification Tool) is not successful is given. The error message can be seen in the IBM Installation Manager log file.

The error message is similar to this IBM Installation Manager log file example message:

```
Custom operation MDM Operational Server, deploying enterprise business application (EBA) on target
server1 in unit com.ibm.mdm.mdm_config.install.eba.win completed:
output in TIME_STAMP.log
```

```
Buildfile: build.xml
```

```
install_mdm_eba:
Creating new property file: C:\IBM\E443\MDM\properties\install_mdm_eba.properties
Updating property file: C:\IBM\E443\MDM\properties\install_mdm_eba.properties
Updating property file: C:\IBM\E443\MDM\properties\install_mdm_eba.properties
Updating property file: C:\IBM\E443\MDM\properties\install_mdm_eba.properties
Updating property file: C:\IBM\E443\MDM\properties\install_mdm_eba.properties
Updating property file: C:\IBM\E443\MDM\properties\install_mdm_eba.properties
Updating property file: C:\IBM\E443\MDM\properties\install_mdm_eba.properties
Updating property file: C:\IBM\E443\MDM\properties\install_mdm_eba.properties
Updating property file: C:\IBM\E443\MDM\properties\install_mdm_eba.properties
Updating property file: C:\IBM\E443\MDM\properties\install_mdm_eba.properties
Updating property file: C:\IBM\E443\MDM\properties\install_mdm_eba.properties
Updating property file: C:\IBM\E443\MDM\properties\install_mdm_eba.properties
Updating property file: C:\IBM\E443\MDM\properties\install_mdm_eba.properties
Updating property file: C:\IBM\E443\MDM\properties\install_mdm_eba.properties
Updating property file: C:\IBM\E443\MDM\properties\install_mdm_eba.properties
Expanding: C:\IBM\E443\MDM\InstallableApps\com.ibm.mdm.hub.server.app.eba into
C:\IBM\E443\MDM\tmp\mdm_eba_temp_TIME_STAMP
```

```
##### entering ConfigEBATask #####
baseDir is ../../tmp/mdm_eba_temp_TIME_STAMP/
ebaID is E443
versionFilePath is ./MDM_VERSION
Begin to modify the file.
Begin to read the File.
Read the file successfully.
Begin to write the modified file.
Write the modified file successfully.
Modify the file successfully.
Begin to read version.
Read the file successfully: 11.0.0
Begin to record version.
Record version successfully: C:\IBM\E443\MDM\mds\scripts\.\MDM_VERSION
.....
Set cuSourceID parameter to assetname=com.ibm.mdm.hub.server.app-E443.eba
Failed from asyncCmdClientHelper.processCommandParameters(cmd).
com.ibm.wsspi.management.bla.op.OpExecutionException: CWSAL0022E: Cannot add asset
com.ibm.mdm.hub.server.app-E443.eba because bundles that it requires
are not downloaded. To start the bundle download, save changes to the
master configuration after importing the asset.
at com.ibm.ws.management.bla.commands.ADTCommand.finishOp(ADTCommand.java:320)
at com.ibm.ws.management.bla.commands.ADTCommand.opCompleted(ADTCommand.java:428)
at com.ibm.wsspi.management.bla.op.Operation.notifyListeners(Operation.java:170)
at com.ibm.wsspi.management.bla.op.Operation.execute(Operation.java:242)
at com.ibm.wsspi.management.bla.op.compound.CompoundOperation.execute(CompoundOperation.java:83)
at com.ibm.ws.management.bla.commands.ADTCommand$OperationScheduler.run(ADTCommand.java:672)
at java.lang.Thread.run(Thread.java:773)
.....
```

Solution

1. Make sure that the machine where you are deploying InfoSphere MDM meets the hardware requirements and has at least 8G of RAM.
2. Shutdown other none-essential applications, especially applications that are running JVMs.
3. Uninstall InfoSphere MDM and install it again.

Installation error: httpPort property cannot be blank

The httpPort property cannot be blank

Description

This issue might cause the InfoSphere MDM installation to fail and trigger a complete installation rollback.

There are two possible cases that can cause this issue to arise:

- During InfoSphere MDM installation, the IBM WebSphere Application Server node agent is unable to process interactions with the InfoSphere MDM installation application.
- The HTTP transport chain has been disabled for the server to use as a deployment target while installing InfoSphere MDM deployment modules.

If these situations occur, the installation session is interrupted and the installation application gives an error message before the installation rollback is triggered.

The warning message is similar to this IBM Installation Manager log file example message:

```
Error occurred in phase: install SU: com.ibm.mdm.application.server.component.config.server
11.0.0.FP001F000_20130502-1800 IU: com.ibm.mdm.mdm_config.install.ws.api.unix
null->999.999.999.1127209126
Message: Error executing "/opt/IBM/MDM/E453/mdm/mds/scripts/madconfig.sh"
operation (status=1). See agent output log for more information:
/home/var/ibm/InstallationManager_LocalTesting_AE007/logs/native/TIME_STAMP.log
```

```

Buildfile: build.xml

install_mds_ws_api:
Creating new property file: /opt/IBM/MDM/E453/mdm/properties/install_mds_ws_api.properties
Updating property file: /opt/IBM/MDM/E453/mdm/properties/install_mds_ws_api.properties
Updating property file: /opt/IBM/MDM/E453/mdm/properties/install_mds_ws_api.properties
Updating property file: /opt/IBM/MDM/E453/mdm/properties/install_mds_ws_api.properties
Updating property file: /opt/IBM/MDM/E453/mdm/properties/install_mds_ws_api.properties
Updating property file: /opt/IBM/MDM/E453/mdm/properties/install_mds_ws_api.properties
Updating property file: /opt/IBM/MDM/E453/mdm/properties/install_mds_ws_api.properties
Updating property file: /opt/IBM/MDM/E453/mdm/properties/install_mds_ws_api.properties
Updating property file: /opt/IBM/MDM/E453/mdm/properties/install_mds_ws_api.properties
Updating property file: /opt/IBM/MDM/E453/mdm/properties/install_mds_ws_api.properties
Updating property file: /opt/IBM/MDM/E453/mdm/properties/install_mds_ws_api.properties
Updating property file: /opt/IBM/MDM/E453/mdm/properties/install_mds_ws_api.properties
Updating property file: /opt/IBM/MDM/E453/mdm/properties/install_mds_ws_api.properties
Updating property file: /opt/IBM/MDM/E453/mdm/properties/install_mds_ws_api.properties
Updating property file: /opt/IBM/MDM/E453/mdm/properties/install_mds_ws_api.properties
Updating property file: /opt/IBM/MDM/E453/mdm/properties/install_mds_ws_api.properties

BUILD FAILED
/opt/IBM/MDM/E453/mdm/mds/scripts/build-utils-app.xml:1508:
The following error occurred while executing this line:
/opt/IBM/MDM/E453/mdm/mds/scripts/build-utils-config.xml:618:
ERROR: httpPort property cannot be blank.

Total time: 1 second

```

Solution

1. Make sure that the IBM WebSphere Application Server node agent is up and running. Start the node agent and run the InfoSphere MDM installation again. If you are deploying in a clustered environment, start all nodes in the cluster.
2. Make sure that the IBM WebSphere Application Server node agent is properly synchronized with the Deployment Manager. Synchronize the node agent and run the InfoSphere MDM installation again. If you are deploying in a clustered environment, synchronize all nodes in the cluster.
3. Make sure that the HTTP transport chain has not been disabled for the server to use as a deployment target:
 - a. In the WebSphere Application Server Integrated Solutions Console, go to **Servers > Server Types > WebSphere application servers > <cluster member name> > Ports**.
 - b. In the list of available ports, locate **WC_defaulthost** and click **View associated transports**.
 - c. Go into **HttpQueueInboundDefault**, select **Enable**, then click **OK** and save your changes.
 - d. Go into **WCInboundDefault**, select **Enable**, then click **OK** and save your changes.
 - e. Complete the preceding steps for each cluster member, then restart the whole cluster.

Tip: Restarting cluster members will not work. You must restart the whole cluster.

Uninstallation error: Installer does not drop virtual MDM tables

When uninstalling InfoSphere MDM with an IBM DB2 for z/OS, the installer does not drop the virtual MDM tables.

Solution

You must manually drop the tables. A full list of the virtual MDM tables can be found in the `MDM_INSTALL_HOME/mds/sql/mpihub.db2z.sto` file.

Installation error: 'java.lang.RuntimeException: Application could not be initialized'

java.lang.RuntimeException: Application could not be initialized. Application Name and Version could not be resolved.

Description

This issue might cause the IVT (Installation Verification Tool) response file to show null because the InfoSphere MDM configuration repository data is missing after the InfoSphere MDM installation is complete. This issue is related to a failure during the database table creation and data population process. If this problem occurs, the installer can complete the InfoSphere MDM installation and indicate that the IVT response file is null.

The error message is similar to this example message from the IBM WebSphere Application Server SystemOut.log file.

```
TIME_STAMP] 0000006f TopologySessi E java.lang.RuntimeException: Application could
not be initialized. Application Name and Version could not be resolved.
    at com.dwl.management.config.cache.CachingLoaderHelperImpl.initApplication
(CachingLoaderHelperImpl.java:171)
    at com.dwl.management.config.cache.CachingLoaderHelperImpl.getApplicationName
(CachingLoaderHelperImpl.java:185)
```

Solution

1. Search the installation log files, stored in `MDM_INSTALL_HOME/logs/database`, for a possible cause of this error. Search for the following text to locate the messages that are known to be related to this error:
 - Custom operation MDM Operational Server, updating data in Configuration Repository tables in unit `com.ibm.mdm.mdm_config.update.appsoftware.table.unix` completed:
 - Custom operation MDM Operational Server, Updating Configuration Repository to setup matching type in unit `com.ibm.mdm.mdm_config.update.PME.tables` completed:
2. Fix any database connection problems.
3. Uninstall InfoSphere MDM and install it again.

Installation error: OutOfMemoryError - PermGen space

When there is not enough memory for the PermGen space in the default WebSphere Application Server `ws_ant.sh` process, this error occurs.

Description

This issue affects Solaris environments. Any InfoSphere MDM installation that includes one or more user interface applications can fail with the following error in the IBM Installation Manager native log file:

```
[timestamp] [main] INFO
com.ibm.mdm.de.config.appserver.core.MDMWebAppDeploy.roleMapping(Line:214) - =====
java.lang.OutOfMemoryError: PermGen space
PermGen space
```

Solution

Prior to installing InfoSphere MDM, increase the memory size for the PermGen space:

1. Open `$WAS_HOME/bin/ws_ant.sh`.

2. Add "-XX:MaxPermSize=256m" as a Java command line argument in the ws_ant.sh file:

```
eval "$JAVA_EXE" "-XX:MaxPermSize=256m"
```

Installation error: SSL handshake failure

When installing InfoSphere MDM in silent installation mode on a machine that does not support graphical user interfaces, the SSL handshake failure message can appear, causing the installation to fail.

Description

During InfoSphere MDM installation, if the IBM WebSphere Application Server SSL handshake popup window cannot open as expected, then the node agent cannot process interactions with the InfoSphere MDM installation application. This issue causes the InfoSphere MDM installation to fail and trigger a complete installation rollback.

The warning message is similar to this IBM Installation Manager log file example message:

```
Updating property file: /app_2/IBM/MDM/KM1Dev05/mdm/properties/sync_nodes.properties
Updating property file: /app_2/IBM/MDM/KM1Dev05/mdm/properties/sync_nodes.properties
Updating property file: /app_2/IBM/MDM/KM1Dev05/mdm/properties/sync_nodes.properties
Updating property file: /app_2/IBM/MDM/KM1Dev05/mdm/properties/sync_nodes.properties
Updating property file: /app_2/IBM/MDM/KM1Dev05/mdm/properties/sync_nodes.properties
##### entering SyncNodesTask #####
wasUser is mdmadmin
wasPwd is *****
hostname is M2848
port is 28879
trustFile is /m1/mdm/WebSphere85dev/AppServer/etc/DummyClientTrustFile.jks
trustFilePwd is *****
node is None
CWPKI0308I: Adding signer alias "CN=M2848, OU=Root Certifica" to local
           keystore "null" with the following SHA digest:
           33:1A:02:2A:C1:10:77:AD:09:3F:FF:CB:F8:8B:49:53:22:3F:5A:89

CWPKI0022E: SSL HANDSHAKE FAILURE: A signer with SubjectDN "CN=M2848, OU=c1_mdm_dev, OU=dm_c1_mdm_dev,
O=ACMES, C=US" was sent from target host:port "10.87.17.230:28879".
The signer may need to be added to local trust store
"/m1/mdm/WebSphere85dev/AppServer/etc/
DummyClientTrustFile.jks" located in SSL configuration alias "null" loaded from
SSL configuration file "null". The extended error message from the SSL handshake exception is:
"PKIX path building failed: java.security.cert.CertPathBuilderException:
PKIXCertPathBuilderImpl could not build a valid CertPath.; internal cause is:
    java.security.cert.CertPathValidatorException: The certificate issued by CN=M2848,
OU=Root Certificate, OU=01_mdm_dev, OU=dm_c1_mdm_dev, O=ACMES,
C=US is not trusted; internal cause is:
    java.security.cert.CertPathValidatorException: Certificate chaining error".
CWPKI0040I: An SSL handshake failure occurred from a secure client. The server's SSL signer has to be
added to the client's trust store. A retrieveSigners utility is provided
to download signers from the server but requires administrative
permission. Check with your administrator to have this utility run to
setup the secure environment before running the client. Alternatively,
the com.ibm.ssl.enableSignerExchangePrompt can be enabled in ssl.client.props
for "DefaultSSLSettings" in order to allow acceptance of the signer during the
connection attempt.
Exception in com.ibm.mdm.de.ant.task.SyncNodesTask
com.ibm.websphere.management.exception.ConnectorException: ADMC0016E: The system cannot create a SOAP
connector to connect to host M2848 at port 28879.
ADMC0016E: The system cannot create a SOAP connector to connect to host M2848 at port 28879.
##### existing SyncNodesTask #####
```

Solution

1. Apply one of the following workarounds:
 - Add the server's SSL signer to the client's trust store:
 - a. Use the retrieveSigners utility to download the signers from the server.
 - b. Add the signer to the client's trust store.

Note: The retrieveSigners utility requires administrative permissions. Check with your administrator to run this utility to set up the secure environment before running the client.

- Allow acceptance of the signer during connection attempts:
 - In the `ssl.client.props` file for `DefaultSSLSettings`, enable the `com.ibm.ssl.enableSignerExchangePrompt` property to allow acceptance of the signer during the connection attempt.
2. Run the InfoSphere MDM installation again.

Uninstallation error: The system cannot create a SOAP connector to connect to host localhost at port 88xx

The system cannot create a SOAP connector to connect to host localhost at port 88xx.

Description

The uninstall function does not verify whether the IBM WebSphere Application Server Dmgr (for Network Deployment) or Server (for Base Deployment) is running before processing the uninstall. If they are not running when you uninstall InfoSphere MDM, the installer cannot create a SOAP connector to connect to the host. The uninstall process can proceed with success, but none of the IBM WebSphere Application Server related resources are deleted.

The error message is similar to this IBM Installation Manager log file example message:

```
com.ibm.websphere.management.exception.ConnectorException: ADMC0016E:
The system cannot create a SOAP connector to connect to host localhost at port 8881.
at com.ibm.websphere.management.AdminClientFactory.createAdminClientPrivileged
(AdminClientFactory.java:634)
at com.ibm.websphere.management.AdminClientFactory.access$000(AdminClientFactory.java:126)
at com.ibm.websphere.management.AdminClientFactory$1.run(AdminClientFactory.java:209)
at com.ibm.ws.security.util.AccessController.doPrivileged(AccessController.java:63)
at com.ibm.websphere.management.AdminClientFactory.createAdminClient(AdminClientFactory.java:205)
at com.ibm.mdm.de.config.appserver.remoteclient.MDSRemoteClient.init(MDSRemoteClient.java:43)
at com.ibm.mdm.de.config.appserver.remoteclient.MDSRemoteClient.execute(MDSRemoteClient.java:21)
at com.ibm.mdm.de.ant.task.UninstallMDSWSAPITask.execute(UninstallMDSWSAPITask.java:84)
at org.apache.tools.ant.UnknownElement.execute(UnknownElement.java:275)
at org.apache.tools.ant.Task.perform(Task.java:364)
at org.apache.tools.ant.Target.execute(Target.java:341)
at org.apache.tools.ant.Target.performTasks(Target.java:369)
at org.apache.tools.ant.Project.executeSortedTargets(Project.java:1216)
at org.apache.tools.ant.Project.executeTarget(Project.java:1185)
at org.apache.tools.ant.helper.DefaultExecutor.executeTargets(DefaultExecutor.java:40)
at org.apache.tools.ant.Project.executeTargets(Project.java:1068)
at org.apache.tools.ant.Main.runBuild(Main.java:668)
at org.apache.tools.ant.Main.startAnt(Main.java:187)
at org.apache.tools.ant.Main.start(Main.java:150)
at org.apache.tools.ant.Main.main(Main.java:240)
at sun.reflect.NativeMethodAccessorImpl.invoke0(Native Method)
at sun.reflect.NativeMethodAccessorImpl.invoke(NativeMethodAccessorImpl.java:60)
at sun.reflect.DelegatingMethodAccessorImpl.invoke(DelegatingMethodAccessorImpl.java:37)
at java.lang.reflect.Method.invoke(Method.java:611)
at com.ibm.ws.bootstrap.WSLauncher.main(WSLauncher.java:277)
Caused by: java.lang.reflect.InvocationTargetException
at sun.reflect.NativeConstructorAccessorImpl.newInstance0(Native Method)
at sun.reflect.NativeConstructorAccessorImpl.newInstance(NativeConstructorAccessorImpl.java:56)
at sun.reflect.DelegatingConstructorAccessorImpl.newInstance(DelegatingConstructorAccessorImpl.java:39)
at java.lang.reflect.Constructor.newInstance(Constructor.java:527)
at com.ibm.websphere.management.AdminClientFactory.createAdminClientPrivileged(AdminClientFactory.java:456)
... 24 more
Caused by: com.ibm.websphere.management.exception.ConnectorNotAvailableException:
[SOAPException: faultCode=SOAP-ENV:Protocol; msg=; targetException=java.net.MalformedURLException]
at com.ibm.ws.management.connector.soap.SOAPConnectorClient.reconnect(SOAPConnectorClient.java:422)
at com.ibm.ws.management.connector.soap.SOAPConnectorClient.<init>(SOAPConnectorClient.java:222)
... 29 more
Caused by: [SOAPException: faultCode=SOAP-ENV:Protocol; msg=; targetException=java.net.MalformedURLException]
at org.apache.soap.rpc.Call.WASinvoke(Call.java:529)
```

```
at com.ibm.ws.management.connector.soap.SOAPConnectorClient$4.run(SOAPConnectorClient.java:380)
at com.ibm.ws.security.util.AccessController.doPrivileged(AccessController.java:118)
at com.ibm.ws.management.connector.soap.SOAPConnectorClient.reconnect(SOAPConnectorClient.java:365)
... 30 more
```

Solution

When uninstalling InfoSphere MDM, make sure that the IBM WebSphere Application Server Dmgr and AppSrv (Network Deployment) or Server (Base Deployment) are running.

Installation error: Virtual MDM IVT failure

When running Installation Verification Tests (IVT) on virtual MDM, the tests can fail with the following message if the application server has not been properly started: `com.dwl.base.exception.DWLBaseException: Could not locate business object: VirtualMDMBObj`

Description

After the installation of InfoSphere MDM has completed, the IVT of virtual MDM can fail if the application server did not start correctly.

This issue affects InfoSphere MDM installations on Microsoft Windows with WebSphere Application Server Base edition. It can arise after either a stand-alone installation with DB2 or a custom installation.

Solution

1. Manually start the application server (server1).
2. Rerun the Installation Verification Tests by running the IVT script `MDM_INSTALL_HOME\IVT\verify.bat`.

Chapter 6. Uninstalling InfoSphere MDM

Use IBM Installation Manager to uninstall your edition or remove individual components.

If you want to remove the entire edition (operational server, database, and components), use the IBM Installation Manager uninstall option.

If you want to remove only selected components, use the modify option.

Uninstalling your InfoSphere MDM instance

Use this procedure to uninstall the full InfoSphere MDM product instance.

Before you begin

If you are planning to later reinstall this InfoSphere MDM runtime environment and use the same database instance that it uses, make sure that you create a backup image of the database as a precaution.

In the environment that you want to uninstall, stop each runtime InfoSphere MDM instance (operational server, entity manager instance, client application, and so on).

About this task

Using the IBM Installation Manager uninstall option removes the entire offering. If you want to remove only selected components (for example, Inspector or Data Steward UI), use the modify option.

Procedure

1. Optional: If you used the `Configure_MasterDataManagement` `madconfig` script to separate the installation and configuration, then you must run another `madconfig` script to clean up the configuration files:
 - On Microsoft Windows systems, run
`madconfig.bat Uninstall_MDM`
 - On Linux or UNIX systems, run
`madconfig.sh Uninstall_MDM`

Important: Be careful when running the `Uninstall_MDM` `madconfig` script. Running `Uninstall_MDM` removes the configuration of all features, and not just the configuration of a particular component.

2. Start IBM Installation Manager and click **Uninstall**.
3. Select the InfoSphere MDM package and click **Next**.
4. Review the summary information and click **Uninstall**.
5. Click **Finish**.

What to do next

The uninstall process does not remove the composite bundle archive (CBA) from the internal bundle repository. You must manually remove the CBA in IBM WebSphere Application Server Integrated Solutions Console (admin console).

Related tasks:

“Removing the CBA from internal bundle repository” on page 189
Troubleshooting an installation

Uninstalling a stand-alone server installation with DB2

If you installed InfoSphere MDM using a stand-alone server installation with DB2, use this procedure to uninstall the features.

About this task

A stand-alone installation creates a database called MDM11DB. On Microsoft Windows, uninstalling InfoSphere MDM removes your MDM11DB database entirely. On Linux or UNIX, the database is not deleted (you must manually delete the MDM11DB database).

In the environment that you want to uninstall, stop each runtime InfoSphere MDM instance (operational server, entity manager instance, client application, and so on).

If you want to uninstall only the InfoSphere MDM features, use this procedure: “Uninstalling your InfoSphere MDM instance” on page 185.

IBM Installation Manager does support the selection of multiple offerings for uninstall at one time. However, you might choose to uninstall the offerings separately as described in this procedure.

Procedure

1. Start IBM Installation Manager and click **Uninstall**.
2. Uninstall InfoSphere MDM.
 - a. Select the **InfoSphere MDM** package and click **Next**.
 - b. Continue through the prompts and click **Uninstall**.
 - c. Click **Finish** and return to the IBM Installation Manager home panel.
3. Uninstall IBM DB2.
 - a. Select the **IBM DB2** package and click **Next**.
 - b. Continue through the prompts and click **Uninstall**.
 - c. Click **Finish** and return to the IBM Installation Manager home panel.
4. Uninstall WebSphere Application Server.
 - a. Ensure that both your WebSphere Application Server and Deployment Manager are stopped. WebSphere Application Server cannot be uninstalled if these processes are running.
 - b. On the IBM Installation Manager home panel, select **Uninstall**.
 - c. Select the **WebSphere Application Server** package and click **Next**.
 - d. Continue through the prompts and click **Uninstall**.
 - e. Click **Finish** and close IBM Installation Manager.

Related tasks:

“Installing a stand-alone server with DB2” on page 58

Uninstalling a stand-alone workstation installation with DB2

If you installed InfoSphere MDM using a stand-alone workstation installation with DB2, use this procedure to uninstall the features.

About this task

A stand-alone installation creates a database called MDM11DB. On Microsoft Windows, uninstalling InfoSphere MDM removes your MDM11DB database entirely. On Linux or UNIX, the database is not deleted (you must manually delete the MDM11DB database).

In the environment that you want to uninstall, stop each runtime InfoSphere MDM instance (operational server, entity manager instance, client application, and so on).

If you want to uninstall only the InfoSphere MDM features, use this procedure: Uninstalling your InfoSphere MDM instance.

IBM Installation Manager does support the selection of multiple offerings for uninstall at one time. However, you might choose to uninstall the offerings separately as described in this procedure.

Procedure

1. Start IBM Installation Manager and click **Uninstall**.
2. Uninstall InfoSphere MDM.
 - a. Select the **InfoSphere MDM** package and click **Next**.
 - b. Continue through the prompts and click **Uninstall**.
 - c. Click **Finish** and return to the IBM Installation Manager home panel.
3. Uninstall IBM DB2.
 - a. Select the **IBM DB2** package and click **Next**.
 - b. Continue through the prompts and click **Uninstall**.
 - c. Click **Finish** and return to the IBM Installation Manager home panel.
4. Uninstall InfoSphere MDM Workbench and IBM Rational Application Developer (RAD) at the same time.
 - a. Select the **MDM Workbench** and **IBM Rational Application Developer** packages and click **Next**.
 - b. Continue through the prompts and click **Uninstall**.
 - c. Click **Finish** and close IBM Installation Manager.
5. Uninstall WebSphere Application Server.
 - a. Ensure that both your WebSphere Application Server and Deployment Manager are stopped. WebSphere Application Server cannot be uninstalled if these processes are running.
 - b. On the IBM Installation Manager home panel, select **Uninstall**.
 - c. Select the **WebSphere Application Server** package and click **Next**.
 - d. Continue through the prompts and click **Uninstall**.
 - e. Click **Finish** and return to the IBM Installation Manager home panel.

Related tasks:

“Installing a stand-alone workstation installation with DB2” on page 65

Uninstalling a single component

Use this procedure to uninstall an InfoSphere MDM application or component.

About this task

This procedure removes only the selected application or component. If you want to remove the entire InfoSphere MDM edition, use the IBM Installation Manager uninstall option.

Procedure

1. Start IBM Installation Manager and click **Modify**.
2. Select the InfoSphere MDM package and click **Next**.
3. Select the language and click **Next**.
4. On the Modify Packages panel, all previously installed components are automatically selected. Make sure that only the component that you want to remove is cleared. Click **Next**.
5. Review the summary information and verify that only the component you want to remove is listed in the Removing Features box. Click **Modify**.
6. Click **Finish**.

What to do next

The uninstall process does not remove the composite bundle archive (CBA) from the internal bundle repository. You must manually remove the CBA in IBM WebSphere Application Server Integrated Solutions Console (admin console).

Related concepts:

“Installing client applications and individual components” on page 149

Related tasks:

“Removing the CBA from internal bundle repository” on page 189

Troubleshooting an installation

Uninstalling in silent mode

Use this procedure to uninstall InfoSphere MDM components in silent mode.

About this task

A properties file is generated when you are running an interactive uninstall. To use a silent uninstall, you must edit this file or create your own file.

Attention: Although code examples might show with line breaks in the following content, the text between `<.../>` must be entered in the response file as one line without breaks.

Procedure

1. To uninstall, replace the `<install modify='false'>` and `</install>` tags in your response file with `uninstall`. For example:

```
<uninstall modify='false'>
<offering id='com.ibm.mdm.advanced' version='versionNumber' profile='IBM InfoSphere Master
Data Management' features='com.ibm.mdm.install.iu.localization.feature,
com.ibm.im.mdm.db.feature,com.ibm.im.mdm.app.feature,
com.ibm.im.mdm.native.feature,com.ibm.mdm.ba.webapp.feature,com.ibm.mdm.ds.webapp.feature,
com.ibm.mdm.pui.webapp.feature,com.ibm.mdm.inspector.webapp.feature,
com.ibm.mdm.ev.webapp.feature,com.ibm.mdm.wb.webapp.feature,com.ibm.mdm.pd.webapp.feature,
com.ibm.im.mdm.pair.manager.feature,com.ibm.im.mdm.message.broker.feature,com.ibm.im.mdm.ei.feature,
com.ibm.mdm.ba.webapp.sample.feature,com.ibm.im.mdm.eutc' />
</uninstall>
```

2. Replace the default profile value with real profile values. For example:

Before the change:

```
<data key='user.was.profile.home.com.ibm.mdm.advanced'  
value='/opt/IBM/WebSphere/AppServer/profiles/AppSrv01' />  
<data key='user.was.profile.home.ba.com.ibm.mdm.advanced'  
value='/opt/IBM/WebSphere/AppServer/profiles/AppSrv01' />  
<data key='user.was.profile.home.ds.com.ibm.mdm.advanced'  
value='/opt/IBM/WebSphere/AppServer/profiles/AppSrv01' />  
<data key='user.was.profile.home.pui.com.ibm.mdm.advanced'  
value='/opt/IBM/WebSphere/AppServer/profiles/AppSrv01' />  
<data key='user.was.profile.home.inspector.com.ibm.mdm.advanced'  
value='/opt/IBM/WebSphere/AppServer/profiles/AppSrv01' />  
<data key='user.was.profile.home.wb.com.ibm.mdm.advanced'  
value='/opt/IBM/WebSphere/AppServer/profiles/AppSrv01' />  
<data key='user.was.profile.home.ev.com.ibm.mdm.advanced'  
value='/opt/IBM/WebSphere/AppServer/profiles/AppSrv01' />  
<data key='user.was.profile.home.pd.com.ibm.mdm.advanced'  
value='/opt/IBM/WebSphere/AppServer/profiles/AppSrv01' />
```

After the change:

```
<data key='user.was.profile.home.com.ibm.mdm.advanced'  
value='/home/wsadmin/WAS8502NDC1usterProfiles/DmgrCL1' />  
<data key='user.was.profile.home.ba.com.ibm.mdm.advanced'  
value='/home/wsadmin/WAS8502NDC1usterProfiles/DmgrCL1' />  
<data key='user.was.profile.home.ds.com.ibm.mdm.advanced'  
value='/home/wsadmin/WAS8502NDC1usterProfiles/DmgrCL1' />  
<data key='user.was.profile.home.pui.com.ibm.mdm.advanced'  
value='/home/wsadmin/WAS8502NDC1usterProfiles/DmgrCL1' />  
<data key='user.was.profile.home.inspector.com.ibm.mdm.advanced'  
value='/home/wsadmin/WAS8502NDC1usterProfiles/DmgrCL1' />  
<data key='user.was.profile.home.wb.com.ibm.mdm.advanced'  
value='/home/wsadmin/WAS8502NDC1usterProfiles/DmgrCL1' />  
<data key='user.was.profile.home.ev.com.ibm.mdm.advanced'  
value='/home/wsadmin/WAS8502NDC1usterProfiles/DmgrCL1' />  
<data key='user.was.profile.home.pd.com.ibm.mdm.advanced'  
value='/home/wsadmin/WAS8502NDC1usterProfiles/DmgrCL1' />
```

3. Make sure that the following three features are always included in the response when you run a silent uninstall:

```
com.ibm.mdm.install.iu.localization.feature,com.ibm.mdm.server.swtag.feature,  
com.ibm.mdm.server.bundles.feature
```

4. If you use a sample response file from the Installation Startup Kit and want to modify it for a silent uninstall, add:

```
com.ibm.mdm.server.swtag.feature,com.ibm.mdm.server.bundles.feature  
features For example:
```

```
<uninstall modify='false'>  
<offering id='com.ibm.mdm.advanced' version='versionNumberprofile=  
'IBM InfoSphere Master Data Management' features='com.ibm.mdm.install.iu.localization.feature  
,com.ibm.mdm.server.swtag.feature,com.ibm.mdm.server.bundles.feature,  
com.ibm.im.mdm.db.feature,com.ibm.im.mdm.app.feature,com.ibm.mdm.ba.webapp.feature'  
installFixes='none' />  
</uninstall>
```

What to do next

The uninstall process does not remove the composite bundle archive (CBA) from the internal bundle repository. You must manually remove the CBA in IBM WebSphere Application Server Integrated Solutions Console.

Related tasks:

“Customizing the silent mode response file” on page 135

“Installing silently by using a response file” on page 142

Related reference:

“Silent installation” on page 132

Removing the CBA from internal bundle repository

Uninstalling InfoSphere MDM does not remove the composite bundle archive (CBA) from the internal bundle repository. You must manually remove it after you finish running the uninstall process.

Procedure

1. Log in to the IBM WebSphere Application Server Integrated Solutions Console (admin console).
2. Go to **Environment > OSGI bundle repositories > Internal bundle repository**.
3. Select the MDM.ear CBAs and click **Delete**.

Related tasks:

“Uninstalling your InfoSphere MDM instance” on page 185

“Uninstalling a single component” on page 187

Notices and trademarks

This information was developed for products and services offered in the U.S.A.

Notices

This information was developed for products and services offered in the U.S.A. This material may be available from IBM in other languages. However, you may be required to own a copy of the product or product version in that language in order to access it.

IBM may not offer the products, services, or features discussed in this document in other countries. Consult your local IBM representative for information on the products and services currently available in your area. Any reference to an IBM product, program, or service is not intended to state or imply that only that IBM product, program, or service may be used. Any functionally equivalent product, program, or service that does not infringe any IBM intellectual property right may be used instead. However, it is the user's responsibility to evaluate and verify the operation of any non-IBM product, program, or service.

IBM may have patents or pending patent applications covering subject matter described in this document. The furnishing of this document does not grant you any license to these patents. You can send license inquiries, in writing, to:

IBM Director of Licensing
IBM Corporation
North Castle Drive
Armonk, NY 10504-1785
U.S.A.

For license inquiries regarding double-byte character set (DBCS) information, contact the IBM Intellectual Property Department in your country or send inquiries, in writing, to:

Intellectual Property Licensing
Legal and Intellectual Property Law
IBM Japan Ltd.
19-21, Nihonbashi-Hakozakicho, Chuo-ku
Tokyo 103-8510, Japan

The following paragraph does not apply to the United Kingdom or any other country where such provisions are inconsistent with local law:

INTERNATIONAL BUSINESS MACHINES CORPORATION PROVIDES THIS PUBLICATION "AS IS" WITHOUT WARRANTY OF ANY KIND, EITHER EXPRESS OR IMPLIED, INCLUDING, BUT NOT LIMITED TO, THE IMPLIED WARRANTIES OF NON-INFRINGEMENT, MERCHANTABILITY OR FITNESS FOR A PARTICULAR PURPOSE. Some states do not allow disclaimer of express or implied warranties in certain transactions, therefore, this statement may not apply to you.

This information could include technical inaccuracies or typographical errors. Changes are periodically made to the information herein; these changes will be

incorporated in new editions of the publication. IBM may make improvements and/or changes in the product(s) and/or the program(s) described in this publication at any time without notice.

Any references in this information to non-IBM Web sites are provided for convenience only and do not in any manner serve as an endorsement of those Web sites. The materials at those Web sites are not part of the materials for this IBM product and use of those Web sites is at your own risk.

IBM may use or distribute any of the information you supply in any way it believes appropriate without incurring any obligation to you.

Licenses of this program who wish to have information about it for the purpose of enabling: (i) the exchange of information between independently created programs and other programs (including this one) and (ii) the mutual use of the information which has been exchanged, should contact:

IBM Corporation
J46A/G4
555 Bailey Avenue
San Jose, CA 95141-1003 U.S.A.

Such information may be available, subject to appropriate terms and conditions, including in some cases, payment of a fee.

The licensed program described in this document and all licensed material available for it are provided by IBM under terms of the IBM Customer Agreement, IBM International Program License Agreement or any equivalent agreement between us.

Any performance data contained herein was determined in a controlled environment. Therefore, the results obtained in other operating environments may vary significantly. Some measurements may have been made on development-level systems and there is no guarantee that these measurements will be the same on generally available systems. Furthermore, some measurements may have been estimated through extrapolation. Actual results may vary. Users of this document should verify the applicable data for their specific environment.

Information concerning non-IBM products was obtained from the suppliers of those products, their published announcements or other publicly available sources. IBM has not tested those products and cannot confirm the accuracy of performance, compatibility or any other claims related to non-IBM products. Questions on the capabilities of non-IBM products should be addressed to the suppliers of those products.

All statements regarding IBM's future direction or intent are subject to change or withdrawal without notice, and represent goals and objectives only.

This information contains examples of data and reports used in daily business operations. To illustrate them as completely as possible, the examples include the names of individuals, companies, brands, and products. All of these names are fictitious and any similarity to the names and addresses used by an actual business enterprise is entirely coincidental.

COPYRIGHT LICENSE:

This information contains sample application programs in source language, which illustrate programming techniques on various operating platforms. You may copy, modify, and distribute these sample programs in any form without payment to IBM, for the purposes of developing, using, marketing or distributing application programs conforming to the application programming interface for the operating platform for which the sample programs are written. These examples have not been thoroughly tested under all conditions. IBM, therefore, cannot guarantee or imply reliability, serviceability, or function of these programs. The sample programs are provided "AS IS", without warranty of any kind. IBM shall not be liable for any damages arising out of your use of the sample programs.

Each copy or any portion of these sample programs or any derivative work, must include a copyright notice as follows:

© (your company name) (year). Portions of this code are derived from IBM Corp. Sample Programs. © Copyright IBM Corp. _enter the year or years_. All rights reserved.

If you are viewing this information softcopy, the photographs and color illustrations may not appear.

Privacy Policy Considerations

IBM Software products, including software as a service solutions, ("Software Offerings") may use cookies or other technologies to collect product usage information, to help improve the end user experience, to tailor interactions with the end user or for other purposes. In many cases no personally identifiable information is collected by the Software Offerings. Some of our Software Offerings can help enable you to collect personally identifiable information. If this Software Offering uses cookies to collect personally identifiable information, specific information about this offering's use of cookies is set forth below.

Depending upon the configurations deployed, this Software Offering may use session and persistent cookies that collect each user's name, user name, password, profile name, or other personally identifiable information for purposes of session management, authentication, enhanced user usability, single sign-on configuration, or web page identification that the user tried to load prior to login. These cookies can be disabled, but disabling them will also likely eliminate the functionality they enable.

If the configurations deployed for this Software Offering provide you as customer the ability to collect personally identifiable information from end users via cookies and other technologies, you should seek your own legal advice about any laws applicable to such data collection, including any requirements for notice and consent.

For more information about the use of various technologies, including cookies, for these purposes, see IBM's Privacy Policy at www.ibm.com/privacy and IBM's Online Privacy Statement at www.ibm.com/privacy/details the section entitled "Cookies, Web Beacons and Other Technologies" and the "IBM Software Products and Software-as-a-Service Privacy Statement" at www.ibm.com/software/info/product-privacy.

General statement regarding product security

IBM systems and products are designed to be implemented as part of a comprehensive security approach that might require the use of other systems, products, or services to be most effective. A comprehensive security approach must be reviewed whenever systems and products are added to your environment.

No IT system or product can be made completely secure, and no single product or security measure can be completely effective in preventing improper access.

IT system security involves protecting systems and information through prevention, detection, and response to improper access from within and outside your enterprise. Improper access can result in information that is altered, destroyed, or misappropriated, or can result in misuse of your systems to attack others.

IBM does not warrant that systems and products are immune from the malicious or illegal conduct of any party.

IBM does not believe that any single process can be completely effective in helping identify and address security vulnerabilities. IBM has a multilayered approach:

- An ongoing, internal initiative promotes consistent adoption of security practices in development of products and services, with the goal of continually improving the quality and security characteristics of all IBM products and services. This initiative is described in the IBM Redguide *Security in Development: The IBM Secure Engineering Framework*, which contains public information about software development practices from IBM.
- Tests and scans of IBM products use various IBM technologies to proactively identify and remediate defects and vulnerabilities, including high or greater criticality vulnerabilities. Remediation takes place within IBM-defined response target timeframes for analysis, impact assessment, and fix delivery.
- The IBM Product Security Incident Response Team (PSIRT) manages the receipt, investigation, and internal coordination of security vulnerability information that is related to IBM offerings. The IBM PSIRT team acts as a focal point that security researchers, industry groups, government organizations, vendors, and customers can contact through the IBM PSIRT portal to report potential IBM product security vulnerabilities. This team coordinates with IBM product and solutions teams to investigate and identify the appropriate response plan.
- A global supply-chain integrity program and framework provide buyers of IT products with a choice of accredited technology partners and vendors in the Open Group Trusted Technology Forum (OTTF).

Because security of computer systems and computer software is a very complex issue, IBM does not provide information about development practices for individual products other than what is found in standard product documentation or as published through IBM's public activities.

Public information about software development practices recommended by IBM is documented in the IBM Secure Engineering Framework. This information is a compilation of practices from across IBM business units and development teams.

In most cases, published vulnerabilities are documented at timely intervals through IBM Security Bulletins that include the associated Common Vulnerability Scoring System (CVSS) base score. In some cases, IBM might contact customers directly and discreetly regarding specific vulnerabilities.

Customers who want to further validate the vulnerability of IBM Software beyond the assessments that are performed internally by IBM are welcome to conduct their own scans against licensed software. They may use the tool of their choice within the existing software licensing terms. For example, scanning is acceptable, but reverse compiling or reverse engineering IBM Software is not authorized except as expressly permitted by law without the possibility of contractual waiver.

Trademarks

IBM, the IBM logo, and ibm.com[®] are trademarks or registered trademarks of International Business Machines Corp., registered in many jurisdictions worldwide. Other product and service names might be trademarks of IBM or other companies. A current list of IBM trademarks is available on the web at "Copyright and trademark information" at www.ibm.com/legal/copytrade.shtml.

The following terms are trademarks or registered trademarks of other companies:

Adobe, the Adobe logo, PostScript, and the PostScript logo are either registered trademarks or trademarks of Adobe Systems Incorporated in the United States, and/or other countries.

IT Infrastructure Library is a registered trademark of the Central Computer and Telecommunications Agency which is now part of the Office of Government Commerce.

Linear Tape-Open, LTO, the LTO Logo, Ultrium, and the Ultrium logo are trademarks of HP, IBM Corp. and Quantum in the U.S. and other countries.

Intel, Intel logo, Intel Inside, Intel Inside logo, Intel Centrino, Intel Centrino logo, Celeron, Intel Xeon, Intel SpeedStep, Itanium, and Pentium are trademarks or registered trademarks of Intel Corporation or its subsidiaries in the United States and other countries.

Linux is a registered trademark of Linus Torvalds in the United States, other countries, or both.

Microsoft, Windows, Windows NT, and the Windows logo are trademarks of Microsoft Corporation in the United States, other countries, or both.

Java and all Java-based trademarks and logos are trademarks or registered trademarks of Oracle and/or its affiliates.

Cell Broadband Engine is a trademark of Sony Computer Entertainment, Inc. in the United States, other countries, or both and is used under license therefrom.

ITIL is a registered trademark, and a registered community trademark of The Minister for the Cabinet Office, and is registered in the U.S. Patent and Trademark Office.

UNIX is a registered trademark of The Open Group in the United States and other countries.

Index

A

- access key, samples 158
- account prerequisites 74
- adding a node to a cluster 164
- adding a user 80
- application
 - installation 149
- application name 36
- application resource language 41
- application server
 - preparing 75
 - preparing dmgr 76
 - preparing for base deployment 78
 - preparing unmanaged server 78

B

- Business Administration UI
 - installing 150

C

- case sensitive searches 41
- cell
 - WebSphere Application Server 33, 39
- character encoding
 - setting on target computers 111
- checklist 26
- checklists 26, 27, 30, 31, 33, 36, 39, 40, 41
- cluster 33, 36, 39
 - adding an InfoSphere MDM node 164
 - installation 124
 - installation scenarios 44, 47
- code table language 41
- configuration
 - configuration separation 121, 123
 - properties files 121
 - scenarios 123
 - separating from installation 121, 123
 - worksheets 26
 - DB2 data source 27
 - history triggers 41
 - installation directory 27
 - MDM application 36
 - Microsoft SQL Server data source 30
 - Oracle data source 31
 - user applications 39
 - WebSphere Application Server 33
- connections
 - database 82
- create
 - database scripts 10
- custom
 - installation 113
- custom installation
 - deployment type 24
- customer support
 - contacting 199

D

- Data Stewardship UI
 - installing 151
- database
 - connections 82
 - home 27, 30, 31
 - host name 27, 30, 31
 - manual install 27, 30, 31
 - port 27, 30, 31
 - preparing DB2 82
 - preparing Oracle 87
 - preparing SQL Server 85
 - schema 27, 30, 31
 - type 27, 30, 31
 - user accounts 82
 - user name and password 27, 30, 31
- DB2 database
 - installation scenarios 44
 - preparing for installation 82
- defaults
 - user account settings 12
- deployment
 - multiple time zone 36
- deployment type
 - custom 24
 - stand-alone 21, 22, 23
 - WebSphere Application Server 33, 39
- directory structure 15
- disable splash screen
 - silent installation 141
- downloading
 - samples 158

E

- error message
 - verification test 129

G

- globalization 111
- graphical
 - installation 25
- groups 12

H

- high availability 26, 44, 47, 164
- host name 33, 39

I

- IBM Support Assistant Data Collector 112
- industry 41
- install
 - directory structure and names 15
- installation
 - graphical 25
 - modify 163

- installation (*continued*)
 - overview 7
 - silent 25
 - viewing logs 163
 - Installation Manager 162
 - worksheets 26
- installation environment 112
- Installation Manager
 - adding MDM offerings 73
 - installing 72
- installation requirements
 - testing 61, 68, 116
 - verifying 61, 68, 116
- installation scenarios 43
- Installation Startup Kit 112
- installing
 - applications 149
 - Business Administration UI 150
 - custom 113
 - custom deployment type 24
 - Data Stewardship UI 151
 - deployment types
 - stand-alone or custom 21
 - features 8
 - in a cluster 124
 - Installation Manager 72
 - manually installing
 - Oracle database setting 94
 - manually installing the application 91
 - manually installing the application on DB2 for Linux or UNIX 94, 97
 - manually installing the application on DB2 for z/OS 92, 93, 99, 101
 - manually installing the application on Oracle 104
 - on z/OS 127
 - Product Maintenance UI 153
 - samples 157, 158
 - silent
 - application server parameters 140
 - creating response file 142
 - customize response file 135
 - DB2 parameters 137, 138
 - disable splash screen 141
 - Oracle parameters 139
 - specify features 137
 - using response file 142
 - silent installations 132
 - silent modify 143
 - stand-alone deployment type 21, 22, 23
 - stand-alone server 58
 - stand-alone workstation 65
 - uninstall silent 188
 - using LaunchPad 58, 65
 - verifying 159, 161
- installing Data Stewardship
 - to manually create a Task Management User 153

K

- key, access for samples 158

L

- language
 - application resource 41
 - code table 41

- LaunchPad
 - starting the stand-alone with DB2 installation 58, 65
- legal notices 191
- local development environment
 - installation scenarios 52
- locale
 - setting on target computers 111
- logs
 - viewing 163
 - Installation Manager 162

M

- MAD_HOMEDIR 16
- MAD_ROOTDIR 16
- manually installing
 - domain database on Oracle 106
- manually installing physical MDM database 94
- manually installing the application 91
- manually installing the application on DB2 for Linux or UNIX 94, 97
- manually installing the application on DB2 for z/OS 92, 93, 99, 101
- manually installing the application on Oracle 104
- matching style 36
- MDM groups
 - adding a user 80
- MDM_INSTALL_HOME 16
- message bus
 - configuration 129
- messaging
 - Message Brokers 36
 - WebSphere Default Messaging 36
 - WebSphere MQ 36
- messaging component
 - installing manually 110
- modify
 - installation 163
 - silent modify 143
- multiple instances
 - installing and configuring 11
- multiple time zone deployment 36

N

- node
 - WebSphere Application Server 33, 39

O

- ODBC drivers 90
- operational server
 - user application association 40
- Oracle
 - manually installing the domain database 106
- Oracle database
 - installation scenarios 47
 - preparing for installation 87

P

- package group
 - existing 27
 - new 27
- password 33, 36, 39

- prepare
 - DB2 database for installation 82
 - Oracle database for installation 87
 - SQL Server database for installation 85
- preparing
 - high availability 26
- preparing to install 71
 - account prerequisites 74
 - adding MDM offerings to installer 73
 - application server dmgr 76
 - application server for base deployment 78
 - application server unmanaged server 78
 - database 81
 - DB2 database in a clustered environment 84
 - DB2 database on a different server 84
 - Installation Startup Kit 73
 - Oracle database in a clustered environment 89
 - Oracle database on a different server 89
 - set Oracle utility path 90
 - setting DB2 utility path 85
 - setting up installation media 56, 63, 70
 - SQL Server database in a clustered environment 87
 - SQL Server database on a different server 87
 - stand-alone installation with DB2 57, 64
 - startup kit 10
 - Startup Toolkit 73
 - WebSphere Application Server 75
- prerequisite check 61, 68, 116
- prerequisite checking tool 112
- Product Maintenance UI
 - installing 153
- profile
 - WebSphere Application Server 39

R

- remote database
 - installation scenarios 52
- remote server
 - installation scenarios 52
- response file
 - application server parameters 140
 - customize 135
 - DB2 parameters 137, 138
 - graphical creation 142
 - Oracle parameters 139
 - silent installation 143
 - silent installations 132
 - specify features 137
 - using 142
- RMI port 36

S

- samples
 - install overview 157
 - installing 157
- security
 - channel roles 80
- separating installation from configuration 121
 - scenarios 123
- server
 - WebSphere Application Server 33, 39
- set Oracle utility path 90
- setting DB2 utility path 85

- silent
 - installation 25
- silent installation
 - application server parameters 140
 - creating response file 142
 - customizing response file 135
 - DB2 parameters 137, 138
 - disable splash screen 141
 - modify 143
 - Oracle parameters 139
 - specify features 137
 - uninstall 188
 - using response file 142
- silent installations 132
- SOAP port 33, 39
- software services
 - contacting 199
- SQL Server database
 - installation scenarios 49
 - preparing for installation 85
- stand-alone
 - installation 65
 - server installation 58
- stand-alone installation
 - deployment type 21
 - for server 22
 - for workstation 23
- startup kit 10
- support
 - customer 199
- system requirements 112

T

- Task Management
 - to manually create a user 153
- trademarks
 - list of 191

U

- uninstall 185
 - full product 185
 - individual applications/components 188
 - silent 188
- updating deployed properties files 166
- user accounts 12
 - database 82
- user application
 - operational server association 40
- user name 33, 39
- users
 - adding user to a group 80

V

- verification test 61, 68, 116
 - error message 129
- verifying installation requirements 61, 68, 116
- verifying the installation 159, 161

W

- WebSphere Application Server
 - cell 33

- WebSphere Application Server *(continued)*
 - deployment type 33
 - home 33
 - node 33
 - profile 33
 - server 33
- WebSphere default
 - messaging 36
- WebSphere MQ
 - messaging 36
- Windows native authentication 30
- worksheets 26
 - DB2 or DB2 for z/OS data source 27
 - history triggers 41
 - installation directory 27
 - MDM application 36
 - Microsoft SQL Server data source 30
 - Oracle data source 31
 - user applications 39
 - WebSphere Application Server 33

X

- XA configuration for DB2 for z/OS 91

Z

- z/OS
 - configure message bus 129
 - installing on 127
- z/OS database creation and installation 91

Contacting IBM

You can contact IBM for customer support, software services, product information, and general information. You also can provide feedback to IBM about products and documentation.

The following table lists resources for customer support, software services, training, and product and solutions information.

Table 32. IBM resources

Resource	Description and location
Product documentation for InfoSphere MDM	You can search and browse across all the InfoSphere MDM documents at http://www.ibm.com/support/knowledgecenter/SSWSR9_11.3.0 .
Product documentation for InfoSphere MDM Custom Domain Hub, including InfoSphere MDM Reference Data Management	You can search and browse across all the InfoSphere MDM Custom Domain Hub documents at http://www.ibm.com/support/knowledgecenter/SSLSQH_11.3.0 .
IBM Support Portal	You can customize support information by choosing the products and the topics that interest you at www.ibm.com/support/ .
Software services	You can find information about software, IT, and business consulting services, on the solutions site at www.ibm.com/businesssolutions/ .
My IBM	You can manage links to IBM web sites and information that meet your specific technical support needs by creating an account on the My IBM site at www.ibm.com/account/ .
Training and certification	You can learn about technical training and education services designed for individuals, companies, and public organizations to acquire, maintain, and optimize their IT skills at www.ibm.com/software/sw-training/ .
IBM representatives	You can contact an IBM representative to learn about solutions at www.ibm.com/connect/ibm/us/en/ .

Providing feedback

The following table describes how to provide feedback to IBM about products and product documentation.

Table 33. Providing feedback to IBM

Type of feedback	Action
Product feedback	You can provide general product feedback through the Consumability Survey at https://www.ibm.com/survey/oid/wsb.dll/studies/consumabilitywebform.htm .

Table 33. Providing feedback to IBM (continued)

Type of feedback	Action
Documentation feedback	To comment on the product documentation: <ul style="list-style-type: none">• Click the Feedback link on the bottom of any topic in IBM Knowledge Center• Online reader comment form: www.ibm.com/software/data/rcf/• E-mail: comments@us.ibm.com



Printed in USA

GI13-2658-01

