

CICS Transaction Server for z/OS
5.4

RACF Security Guide



Note

Before using this information and the product it supports, read the information in [“Notices” on page 429.](#)

This edition applies to the IBM CICS® Transaction Server for z/OS® Version 5 Release 4 (product number 5655-Y04) and to all subsequent releases and modifications until otherwise indicated in new editions.

© **Copyright International Business Machines Corporation 1974, 2023.**

US Government Users Restricted Rights – Use, duplication or disclosure restricted by GSA ADP Schedule Contract with IBM Corp.

Contents

About this PDF.....	ix
Chapter 1. Introduction to CICS security with RACF.....	1
Security facilities in CICS.....	1
What CICS security protects.....	1
CICS users.....	2
The CICS region user ID.....	3
The CICS default user ID.....	4
Terminal user security.....	5
Non-terminal security.....	5
The QUERY SECURITY command.....	5
Intercommunication security.....	6
Generating and using Passtickets for secure sign-on.....	6
Using Passtickets in FEPI applications.....	7
RACF facilities.....	8
RACF administration.....	8
Delegation of RACF administrative responsibility.....	9
RACF profiles.....	10
RACF user profiles.....	11
RACF group profiles.....	16
RACF data set profiles.....	17
RACF general resource profiles.....	18
RACF classes for CICS resources.....	19
RACF classes for protecting system resources.....	20
Resource classes for DB2ENTRYS.....	22
Summary of RACF commands.....	23
Security classification of data and users.....	25
Defining your own resource classes.....	26
Controlling access to fields in RACF profiles.....	27
Chapter 2. Implementing RACF protection in a single CICS region.....	29
CICS system resource security.....	29
CICS installation requirements for RACF.....	29
Specifying the CICS region userid.....	30
Authorizing CICS procedures to run under RACF.....	31
Defining user profiles for CICS region user IDs.....	32
Defining the default CICS user ID to RACF.....	34
Authorizing access to MVS log streams.....	35
Authorizing access to CICS data sets.....	36
Authorizing access to the temporary storage pools.....	39
Authorizing access to temporary storage servers.....	40
Authorizing access to named counter pools and servers.....	41
Authorizing access to SMSVSAM servers.....	42
Authorizing access to the CICS region.....	43
Controlling the opening of a CICS region's z/OS Communications Server ACB.....	44
Controlling userid propagation.....	44
Surrogate job submission in a CICS environment.....	45
Authorizing the CICS region userid as a surrogate user.....	45
JES spool protection in a CICS environment.....	46
Security-related system initialization parameters.....	46

Verifying CICS users.....	52
Identifying CICS terminal users.....	52
The sign-on process.....	53
The sign-off process.....	54
Controlling access to CICS from specific ports of entry.....	55
Defining port of entry profiles.....	56
Auditing sign-on and sign-off activity.....	58
Preset terminal security.....	59
Using an MVS system console as a CICS terminal.....	61
Obtaining CICS-related data for a user.....	63
Support for mixed-case passwords.....	65
National language and non-terminal transactions.....	66
Transaction security.....	66
CICS parameters controlling transaction-attach security.....	66
Defining transaction profiles to RACF.....	68
Authorization failures and error messages.....	69
Protecting non-terminal transactions.....	69
Resource security.....	70
Introduction to resource security.....	70
Security using the XRES resource security parameter.....	71
Resource security checking by CICS and RACF.....	74
Security for transient data.....	77
Security for files.....	79
Security for journals and log streams.....	80
Security for started transactions.....	81
Security for transactions started with EXEC CICS RUN TRANSID.....	84
Security for XPCT-checked transactions.....	84
Security for application programs.....	85
Security for temporary storage.....	86
Security for z/OS UNIX files.....	87
Security for program specification blocks.....	90
Security checking of transactions running under CEDF, CEDG, CEDX, or CEDY.....	91
Defining generic profiles for resources.....	91
Security using the XRES resource security parameter.....	92
Resource security.....	94
CICS and RACF resource checking summary.....	94
Defining generic profiles for resources.....	96
Resource and command check cross-reference.....	96
Surrogate user security.....	113
Situations where surrogate user checking applies.....	113
RACF definitions for surrogate user checking.....	117
Examples of RACF definitions for surrogate user checking.....	117
CICS command security.....	118
Introduction to command security.....	118
CICS resources subject to command security checking.....	120
Parameters for specifying command security.....	128
Security checking of transactions running under CEDF.....	129
CEMT considerations.....	129
Authorization failures in application programs.....	129
Security checking using the QUERY SECURITY command.....	130
How QUERY SECURITY works.....	130
The RESTYPE option.....	131
The RESCLASS option.....	136
Specifying user-defined resources to RACF.....	137
Querying a user's surrogate authority.....	139
Logging for QUERY SECURITY.....	139
Examples: Using the QUERY SECURITY command for resource security checking.....	139
Security for CICS-supplied transactions.....	140

Categories of CICS-supplied transactions.....	140
Category 1 transactions.....	141
Category 2 transactions.....	145
Category 3 transactions.....	152
When and how CICS determines the userid of the CICS region.....	153
Chapter 3. Identity propagation and distributed security.....	155
Support and requirements for identity propagation.....	156
Sample network topologies for using identity propagation.....	157
Configuring identity propagation.....	159
Configuring RACF for identity propagation.....	159
Chapter 4. Invoking an external security manager.....	161
Overview of the MVS router.....	161
How ESM exit programs access CICS-related information.....	161
The RACF user exit parameter list.....	161
The installation data parameter list.....	162
Chapter 5. Security for CICSplex SM.....	165
Implementing CICSplex SM security.....	165
Determining who requires access to CICSplex SM resources.....	165
General requirements for CICSplex SM security.....	169
Creating profiles for the CICSplex SM data sets.....	169
Determining the agent user ID for CICSplex SM components.....	170
Defining the CICSplex SM started tasks.....	172
Defining the CICSplex SM transactions in a CMAS.....	172
Defining the transactions in a managed CICS region.....	173
Setting up CICSplex SM Web User Interface security.....	174
Specifying CICSplex SM resource names in profiles.....	178
Security for platforms and applications.....	204
Activating simulated CICS security.....	207
Considerations for CICS surrogate security checks.....	208
Activating security for CICSplex SM.....	209
Refreshing RACF profiles for CICSplex SM.....	209
CICSplex SM security checking sequence.....	210
Invoking a user-supplied external security manager.....	214
An overview of the CICSplex SM ESM interface.....	214
Overview of the MVS router.....	214
CICSplex SM security control points.....	214
Example tasks: security.....	215
Example: Protecting all CICSplex SM resources.....	215
Example: Giving CICSplex SM operators appropriate authorizations.....	216
Example: Giving a user read access to all transactions on MVS system A.....	217
Chapter 6. Security for intercommunication.....	219
Overview of intercommunication security.....	219
Introduction to intercommunication security.....	219
Planning for intercommunication security.....	219
Intercommunication bind-time security.....	219
Intercommunication link security.....	220
User security for intercommunication.....	220
Transaction, resource, command, and surrogate user security for intercommunication.....	221
Summary of intercommunication security levels.....	221
Implementing LU6.2 security.....	222
Bind-time security with LU6.2.....	222
Link security with LU6.2.....	226
User security with LU6.2.....	227

SNA profiles and attach-time security.....	231
Transaction, resource, and command security with LU6.2.....	232
Transaction routing security with LU6.2.....	233
Function shipping security with LU6.2.....	234
Distributed program link security with LU6.2.....	235
Security checking done in AOR with LU6.2.....	236
Implementing LU6.1 security.....	237
Link security with LU6.1.....	238
Specifying link security for LU6.1 connections.....	238
Specifying ATTACHSEC with LU6.1.....	238
Transaction, resource, and command security with LU6.1.....	239
Function shipping security with LU6.1.....	239
Security checking done in AOR with LU6.1.....	240
APPC password expiration management.....	241
Introduction to APPC password expiration management.....	241
What you require to use APPC PEM.....	242
External security interface.....	242
Roles of PEM client and CICS PEM server.....	243
Overview of APPC PEM processing.....	245
Setting up the PEM client.....	249
PEM client input and output data.....	251
Implementing IPIC security.....	259
IPIC bind-time security.....	259
IPIC link security.....	260
IPIC user security.....	261
IPIC transaction, resource, and command security.....	263
CICS routing transaction, CRTE.....	263
Security checking done in AOR with IPIC.....	264
Implementing MRO security.....	265
Security implications of choice of MRO access method.....	265
Bind-time security with MRO.....	265
Logon security checking with MRO.....	266
Link security with MRO.....	268
Specifying link security for MRO connections.....	269
User security with MRO.....	269
Transaction, resource, and command security with MRO.....	271
Transaction routing security with MRO.....	272
Function shipping security with MRO.....	273
Distributed program link security with MRO.....	274
Security checking done in AOR with MRO.....	274
Security for data tables.....	275
Security for CICS shared data tables.....	275
Security for coupling facility data tables.....	278

Chapter 7. Security for TCP/IP clients..... 281

About security for TCP/IP clients.....	281
Message protection.....	281
Identification and authentication.....	284
Support for security protocols.....	288
Configuring CICS to use SSL.....	293
Setting up profiles in RACF.....	294
Requesting a certificate from a certificate authority.....	295
Building a key ring manually.....	296
Building a key ring with certificates using DFH\$RING.....	297
Creating new RACF certificates.....	298
Associating a RACF user ID with a certificate.....	299
Using an existing certificate that is not owned by the CICS region user ID.....	300

Configuring a RACF site certificate for use with CICS TS.....	300
Making a certificate untrusted.....	301
System initialization parameters for SSL.....	301
TCPIP SERVICE attributes for SSL.....	302
Creating an SSL cipher suite specification file.....	303
Customizing encryption negotiations.....	304
Making your CICS TS system conformant to NIST SP800-131A.....	305
Configuring LDAP for CICS use.....	307
Using certificate revocation lists (CRLs).....	308
Chapter 8. Security for data sources.....	311
Security for DB2.....	311
Controlling access to DB2-related resources in CICS.....	312
Providing authorization IDs to DB2 for the CICS region and for CICS transactions.....	319
Authorizing users to access resources in DB2.....	326
DB2 multilevel security and row-level security.....	329
Security for DBCTL.....	329
PSB authorization checking by CICS.....	330
Security for data sets: encryption.....	330
Chapter 9. Security for external interfaces.....	333
Security for EXCI.....	333
Using MRO logon and bind-time security.....	333
Link security.....	334
User security.....	334
Surrogate user checking.....	335
Security for ONC RPC.....	335
Security in ONC RPC.....	335
Security in CICS and its effect on CICS ONC RPC operations.....	336
Writing the resource checker.....	337
Chapter 10. Security for Java applications.....	341
Configuring security for OSGi applications.....	341
Configuring security for a Liberty JVM server.....	341
The Liberty angel process.....	344
Authenticating users in a Liberty JVM server.....	346
Authorizing users to run applications in a Liberty JVM server.....	348
Authorization using OAuth 2.0.....	349
Authorization using SAF role mapping.....	352
Configuring security for a Liberty JVM server by using an LDAP registry.....	353
Configuring SSL (TLS) for a Liberty JVM server using a Java keystore.....	357
Configuring SSL (TLS) for a Liberty JVM server using RACF.....	357
Setting up SSL (TLS) client certificate authentication in a Liberty JVM server.....	359
Using the syncToOSThread function	360
Enabling a Java security manager.....	361
Chapter 11. Security for CICS web support.....	363
CICS as an HTTP server: authentication and identification.....	363
CICS as an HTTP client: authentication and identification.....	364
Password expiry management for HTTP basic authentication.....	365
CICS system and resource security for CICS web support.....	367
Security for inbound ports.....	367
Security for CICS system components.....	368
Resource and transaction security for application-generated responses.....	368
Resource-level security for static responses using document templates.....	371
SSL with CICS web support.....	372
Introduction to Application Transparent Transport Layer Security (AT-TLS).....	372

Security for Atom feeds.....	382
Chapter 12. Support for securing web services.....	385
Prerequisites for Web Services Security.....	385
Planning to secure SOAP web services.....	386
Options for securing SOAP messages.....	387
Authentication using a Security Token Service.....	388
The Trust client interface.....	389
Signing of SOAP messages.....	390
Signature algorithms.....	390
Example of a signed SOAP message.....	390
CICS support for encrypted SOAP messages.....	391
Encryption algorithms.....	392
Example of an encrypted SOAP message.....	392
Configuring RACF for Web Services Security.....	393
Configuring provider mode web services for identity propagation.....	395
Configuring the pipeline for Web Services Security.....	397
Writing a custom security handler.....	400
Invoking the Trust client from a message handler.....	401
Security for z/OS Connect	402
Configuring permissions for Services and APIs.....	402
Chapter 13. Security in BTS.....	405
Resource security in BTS.....	405
Process and activity user IDs.....	405
Attach-time security for processes and activities.....	406
Command security in BTS.....	406
Chapter 14. Security for the CICS-WebSphere MQ adapter.....	407
Implementing security for CICS-MQ adapter transactions.....	407
Security for MQCONN and MQMONITOR commands.....	408
CICS-WebSphere MQ adapter user IDs.....	408
Connection security for the CICS-WebSphere MQ adapter.....	408
Chapter 15. Security for the CICS-WebSphere MQ bridge.....	411
Chapter 16. Kerberos support.....	415
Configuring RACF for Kerberos.....	415
Configuring CICS web services for Kerberos.....	416
Developing Kerberos applications.....	417
Using a Kerberos security token in a 3270 emulator sign-on.....	417
Chapter 17. Support for Multi-Factor Authentication using RACF.....	419
Chapter 18. Configuring CICS for SAML.....	421
Validating your configuration.....	421
Configuring a provider pipeline.....	422
Configuring a requester pipeline.....	424
Configuring the CICS STS.....	425
The STS configuration file.....	426
Patterns for developing SAML-aware programs.....	427
Notices.....	429
Index.....	435

About this PDF

This PDF describes how to plan and implement security across your CICS systems. It is intended for security administrators responsible for controlling access to resources used by CICS. These resources are used by CICS terminals, users, or transactions in CICS regions, and by CICS application programs running in those regions. This PDF will also be of interest for CICS system programmers who need to communicate their requirements to the security administrator for their installation.

This PDF replaces *RACF Security Guide*, SC34-7423-00.

For details of the terms and notation used, see [Conventions and terminology used in the CICS documentation](#) in IBM® Knowledge Center.

Date of this PDF

This PDF was created on 2024-01-04 (Year-Month-Date).

Chapter 1. Introduction to CICS security with RACF

This part is an introduction to CICS security. It explains at a high level how you can use the facilities provided by RACF® to make your CICS systems, and the resources in those systems, secure against unauthorized access.

Security facilities in CICS

As an online transaction-processing system (often supporting many thousands of users), CICS requires the protection of a security system to ensure that the resources to which it manages access are protected and are secure from unauthorized access. CICS provides a number of facilities that protect your resources against unauthorized access.

To provide the required security for your CICS regions, CICS uses the MVS™ system authorization facility (SAF) to route authorization requests to an external security manager (ESM), such as RACF, at appropriate points within CICS transaction processing.

For specific security information about Business Transaction Services, see [Security in BTS](#).

What CICS security protects

CICS manages application programs, the application data, and the application output. To prevent disclosure, destruction, or corruption of these assets, you must first safeguard the CICS system components themselves.

There are two distinct areas from which exposures to the CICS system can arise. The first of these is from sources external to CICS. You can use RACF data set protection as the primary means of preventing unauthorized access, from either TSO users or batch jobs, to the assets CICS manages.

The other potential area of exposure arises from CICS users. CICS provides a variety of security and control mechanisms that can limit the activities of CICS users to only those functions that any particular individual user is authorized to use:

Transaction security

Ensures that users that attempt to run a transaction are entitled to do so

Resource security

Ensures that users who use CICS resources are entitled to do so

Command security

Ensures that users who use CICS system programming commands are entitled to do so

CICS itself does **not** provide facilities to protect its own assets from external access. You must restrict access to the program libraries, to the CICS regions, and to those responsible for incorporating approved application and system changes. Similarly, the data sets and databases used by CICS and by CICS applications must be accessible only by approved batch processing and operations procedures.

CICS does not protect your system from application programs that use undocumented or unsupported interfaces to bypass CICS security. You are responsible for ensuring that such programs are not installed on your system.

CICS does not protect your application source libraries. You should ensure that procedures are established and followed that prevent the introduction of unauthorized or untested application programs into your production application base. You must also protect the integrity of your system by exercising control over libraries that are admitted to the system and changes to those libraries.

CICS users

When CICS security is active, requests to attach transactions, and requests by transactions to access resources, are associated with a *user*.

When a user makes a request, CICS calls the external security manager to determine if the user has the authority to make the request. If the user does not have the correct authority, CICS denies the request.

In many cases, a user is a human operator, interacting with CICS through a terminal or a workstation. However, this is not always the case: a user can also be a program executing in a client system. In general, a CICS user is an entity that is identified by a *user identifier* (or *userid*).

All CICS users must be defined to the security manager; when the security manager is RACF, information about each users is stored in a user profile.

Here are some of the ways that the user of a CICS transaction, or a CICS resource, can be identified:

- A human operator signs on (and so provides a userid) at the start of the terminal session. The userid remains associated with the terminal until the terminal operator signs off. Transactions executed from the terminal, and requests made by those transactions, are associated with that userid.

For more information, see [“Identifying CICS terminal users” on page 52](#)

- A userid is permanently associated with a terminal. Transactions executed from the terminal, and requests made by those transactions, are associated with the preset userid.

For more information, see [“Preset terminal security” on page 59](#).

- A client program that is communicating with CICS using the Secure Sockets Layer (SSL) supplies a client certificate to identify itself. The security manager maps the certificate to a userid. The transaction that services the client's request, and further requests made by that transaction, are associated with that userid.

For more information, see [“About security for TCP/IP clients” on page 281](#).

- A CICS application program issues a START command with the USERID option. The started transaction, and requests made by that transaction, are associated with the specified userid.

For more information, see [“Security for started transactions” on page 81](#).

- A transaction is started when the trigger level of an intrapartition transient data queue is reached. If the USERID attribute is specified in the TDQUEUE definition for the queue, then the started transaction, and requests made by that transaction, are associated with the specified userid.

For more information, see [“Protecting non-terminal transactions” on page 69](#).

- A remote program executing in another system, supplies a userid when it sends an attach request to CICS. The attached transaction, and requests made by that transaction, are associated with the specified userid.

For more information, see [“User security for intercommunication” on page 220](#).

- A remote system connects to CICS, and link security is specified for the connection to the remote system. Transactions invoked from the remote system, and requests made by that transaction, are associated with the link userid. For more information, see [“Intercommunication link security” on page 220](#).

- A CICS business transaction services (BTS) process is activated by a RUN command, and the DEFINE PROCESS command specified the USERID option.. The transaction under which the process runs, and requests made by that transaction, are associated with the specified userid.

For more information, see [Overview of BTS](#).

- A second phase PLT program runs during CICS initialization. Depending upon the value of the PLTPISEC system initialization parameter, requests made by the program are associated with the userid specified in the PLTPIUSR system initialization parameter.

For more information, see [“PLT programs” on page 70](#).

There are two user IDs that CICS uses in addition to those that identify individual users. They are

The region user ID

is used for authorization checking when the CICS system (rather than an individual user of the system) requests access to a resource.

For more information, see [“The CICS region user ID” on page 3.](#)

The default user ID

identifies the user whose security attributes are used to protect CICS resources in the absence of other, more specific, user identification.

For more information, see [“The CICS default user ID” on page 4.](#)

By itself, a userid does not protect the system from unauthorized access: in many cases, userids are known to other people than the user they identify. To prevent impersonation, another piece of information — known only to the individual user — must be supplied in order to authenticate the user. For example:

- For a terminal user, the password which the user supplies during sign on authenticates the user.
- For a client using SSL, the client certificate authenticates the client.

The CICS region user ID

The CICS region user ID is used for authorization checking when the CICS system (rather than an individual user of the system) requests access to a resource.

CICS uses the region user ID when checking authorization for these resources:

MVS system log streams

For more information, see [“Authorizing access to MVS log streams” on page 35.](#)

CICS system data sets

For more information, see [“Authorizing access to CICS data sets” on page 36.](#)

CICS user data sets

For more information, see [“Authorizing access to user data sets” on page 39.](#)

Temporary storage data sharing servers

For more information, see [“Authorizing access to temporary storage servers” on page 40.](#)

The SMSVSAM server

For more information, see [“Authorizing access to SMSVSAM servers” on page 42.](#)

Named counter servers

For more information, see [“Authorizing access to named counter pools and servers” on page 41.](#)

The z/OS Communications Server ACB

For more information, see [“Controlling the opening of a CICS region's z/OS Communications Server ACB” on page 44.](#)

JES spool data sets

For more information see [“JES spool protection in a CICS environment” on page 46.](#)

The CICS interregion program

For more information, see [“Logon security checking with MRO” on page 266.](#)

Coupling facility data tables

For more information, see [“Security for coupling facility data tables” on page 278.](#)

RACF key rings

For more information, see [“Building a key ring manually” on page 296.](#)

CICS may also use the region user ID:

When submitting jobs to the JES internal reader

For more information, see [“Controlling userid propagation” on page 44.](#)

As a surrogate for other user IDs used during CICS execution

For more information, see [“Surrogate user security” on page 113.](#)

As a prefix for resource names passed to RACF

For more information, see the description of the **SECPFRX** system initialization parameter in [“Security-related system initialization parameters”](#) on page 46.

When executing CICS-supplied non-terminal transactions

For more information, see [“Category 1 transactions”](#) on page 141.

In CICS intersystem communication using LU6.2

For more information, see [“Implementing LU6.2 security”](#) on page 222.

In CICS intersystem communication using LU6.1

For more information, see [“Implementing LU6.1 security”](#) on page 237.

In CICS intersystem communication using MRO

For more information, see [“Implementing MRO security”](#) on page 265.

In Liberty JVM server using the angel process

For more information, see [The Liberty server angel process](#).

The CICS region user ID is assigned to a CICS region at initialization, and is the user ID that is associated with the job or started task. For more information, see [“Specifying the CICS region userid”](#) on page 30.

The CICS default user ID

The CICS default user ID identifies the user whose security attributes are used to protect CICS resources in the absence of other, more specific, user identification.

The default user ID is specified in the **DFLTUSER** system initialization parameter. If you do not specify the parameter, the default user ID is CICSUSER.

- It is assigned to a terminal or a console before a user signs on, and after the user has signed off, except when the terminal or console has preset security specified. For more information, see [“Verifying CICS users”](#) on page 52.
- It is assigned to transient data trigger-level transactions that are not associated with a terminal, and when a user ID is not specified in the definition of the transient data queue. For more information, see [“Transient data trigger-level transactions”](#) on page 115.
- It is used as the link user ID for LU6.1 and LU6.2 connections when the SECURITYNAME attribute is not specified in the CONNECTION definition. For more information, see [“Link security with LU6.1”](#) on page 238 and [“Link security with LU6.2”](#) on page 226. The default user ID can also be used as the link user ID for IPIC. For more information, see [Security checking done in AOR with IPIC](#).
- It is assigned to transactions attached by LU6.2 and MRO sessions, when the attach request does not contain security parameters, and the CONNECTION definition specifies USEDFTUSER(YES). For more information, see [“SNA profiles and attach-time security”](#) on page 231 and [“User security with MRO”](#) on page 269. The default user ID can also be assigned to transactions attached by IPIC sessions. For more information see [IPIC user security](#).
- For transactions in an application-owning region (AOR) that are initiated using the CICS routing transaction (CRTE), the default user ID is used if the terminal user does not sign on to the AOR while using CRTE. For more information, see [CICS routing transaction, CRTE](#).
- It is used when an application-owning region (AOR) issues a request for a remote file that is defined as a shared data table, and the AOR is unable to sign on to the file-owning region (FOR). For more information, see [“Security for CICS shared data tables”](#) on page 275.
- In the absence of more explicit identification, it is used to identify TCP/IP clients that connect to CICS. For more information, see [“Identification”](#) on page 284.
- It is assigned to the USERID attribute of an MQMONITOR if the USERID has not been explicitly specified (for example, the dynamically installed MQMONITOR DFHMQINI).
- The initial user ID used by default by z/OS Connect, Liberty, and WEBSERVICES.
- The user ID used by default for unauthenticated z/OS Connect, Liberty, and WEBSERVICE requests.

For more information about how you can configure security for a Liberty JVM server, see [Configuring security for a Liberty JVM server](#). For more information about how you can configure permissions for z/OS Connect, see [Configuring permissions for z/OS Connect Services and APIs](#).

Terminal user security

To secure resources from unauthorized access, CICS requires some means of uniquely identifying individual users of the system.

For this purpose, first define the users to RACF by creating an entry in the RACF database, referred to as a *user profile*. To identify themselves to CICS, users sign on by specifying their RACF user identification (user ID) and the associated password, or operator identification card (OIDCARD) in the CICS-supplied sign-on transaction, CESN. Alternatively, they can use an equivalent transaction developed by your own installation by issuing the EXEC CICS SIGNON command provided for this purpose.

When users enter the CESN transaction, CICS verifies user IDs and passwords by a call to RACF. If the terminal user signon is valid, the CICS user domain keeps track of the signed-on user. Thereafter, CICS uses the information about the user when calling RACF to make authorization checks. If the user fails to complete signon, all subsequent transactions use [the CICS default user ID](#).

See [“Terminal profiles” on page 56](#) for information about the terminal security facilities provided by RACF. See [“Verifying CICS users” on page 52](#) for information about using terminal user security in CICS.

For some terminals, and for MVS consoles which are used as CICS terminals, it may be appropriate to use *preset terminal security*. Preset terminal security allows you to associate a user ID permanently with a terminal that is defined to CICS. This means that CICS implicitly "signs on" the terminal when it is being installed, instead of the terminal being signed on subsequently. Preset security is often defined for devices without keyboards, such as printers, at which users cannot sign on.

You can also use this form of security on ordinary display terminals as an alternative to terminal user security. This permits anyone with physical access to a terminal with preset security to enter the transactions that are authorized for that terminal, without the need to sign on to CICS. The terminal remains signed on as long as it is installed, and no explicit sign-off can be performed against it. If the user ID associated with a display terminal with preset security authorized to use any sensitive transactions, ensure that the terminal is in a secure location to which access is restricted. For example, terminals physically located within a CICS network control center might be appropriate for preset security.

Non-terminal security

You can specify security for transactions that are not associated with terminals.

Transactions that are not associated with terminals include:

- Started non-terminal transactions
- Transient data trigger-level transactions
- Program List Table (PLT) programs that run during CICS initialization

For more information about non-terminal security, see [“Protecting non-terminal transactions” on page 69](#).

The QUERY SECURITY command

In addition to using CICS security checking for CICS-controlled resources (or as an alternative to it), you can use the `QUERY SECURITY` command to control security access within the CICS application. This method also allows you to define security profiles to RACF for resources other than CICS resource profiles, and enables a more detailed level of security checking than is available through the standard resource classes.

See [“RACF general resource profiles” on page 18](#) for information about the resource classes that RACF supports for resource security checking within transactions. For more information about resource security checking, see [“Resource security” on page 70](#).

Intercommunication security

You can connect a number of CICS regions together by using intercommunication; for example, intersystem communication over SNA (ISC over SNA) which uses an SNA access method, such as ACF/Communications Server, to provide the required communication protocols. The basic security principles apply to interconnected systems, but the resource definition is more complex and there are additional security requirements.

APPC (LU6.2) session security

One of the ISC over SNA protocols that CICS uses is for advanced program-to-program communication (APPC), which is the CICS implementation of the LU6.2 part of the SNA architecture. CICS treats APPC sessions, connections, and partners as resources, all of which have security requirements. CICS provides the following security mechanisms for the APPC environment:

- Bind-time (or session) security prevents an unauthorized remote system from connecting to CICS.
- Link security defines the complete set of CICS transactions and resources that the remote system is permitted to access across the connection.
- User security checks that a user is authorized both to attach a CICS transaction and to access all the resources and SPI commands that the transaction is programmed to use.

See [“Implementing LU6.2 security”](#) on page 222 for more information.

Multiregion operation (MRO)

Another means of using intercommunication is multiregion operation (MRO). This is available for links between CICS regions in a single sysplex, independent of the systems network architecture (SNA) access method. See [“Implementing MRO security”](#) on page 265 for information about MRO security.

IP interconnectivity (IPIC) security

The security mechanisms for IPIC connections are similar to those provided for APPC (LU6.2) connections, although they are implemented differently:

- [Bind-time security](#) prevents an unauthorized remote system from connecting to CICS. On IPCONNs, bind security is enforced by the exchange of Secure Sockets Layer (SSL) client certificates.
- [Link security](#) defines the complete set of CICS transactions and resources that the remote system is permitted to access across the IPCONN.
- [User security](#) checks that a user is authorized both to attach a CICS transaction and to access all the resources and SPI commands that the transaction is programmed to use. User security is a subset of link security: that is, a user cannot access a resource, even if it is included in the set defined as accessible by his user ID, if it is not also included in the set of resources accessible by the link user ID.

For information about IPIC connections, see [Communication between systems](#).

Generating and using PassTickets for secure sign-on

A PassTicket is a secure representation of a password that your program can use to sign on to a particular application on a particular system, such as another CICS region. A specific PassTicket may be used for authentication once only, and it must be used within 10 minutes of being generated.

RACF, or a functionally-equivalent external security manager that supports PassTickets, generates a PassTicket when your application issues the **EXEC CICS REQUEST PASSTICKET** or **FEPI REQUEST PASSTICKET** command. The PassTicket can be used anywhere a password can be used.

Using a PassTicket in place of a password means that applications do not have to store passwords (or ask users to re-enter them) in order to sign on to the target system, and passwords are not transmitted across the network. The end user is verified by signing on to the originating system in the normal way. No changes are required in the target system to use PassTickets, because the external security manager processes the PassTicket, so the target system can use its existing procedures to sign on the user ID.

To use PassTickets, the systems involved must meet the following requirements:

- The back end can be a CICS region or IMS system. No changes are required in the CICS or IMS back-end systems to use PassTickets.

- RACF, or a functionally-equivalent external security manager that supports PassTickets, must be on both systems. The PassTicket generation and validation algorithm means that the system that creates the PassTicket and the system that validates it must both use a level of the external security manager that supports PassTickets. If the originating system has the function applied, and the target system does not, the PassTicket is invalid.
- End users must use the same user ID in the target system as the one that they use in the system where the PassTicket is requested.
- Because PassTickets are time-stamped, the system clocks for the target system and the originating system must be synchronized to within the valid time range. A PassTicket is considered to be within the valid time range when the time of generation, with respect to the clock on the generating computer, is within plus or minus 10 minutes of the time of evaluation, with respect to the clock on the evaluating computer. For more information about system time differences and synchronization, see [Using the secured signon function in z/OS Security Server RACF Security Administrator's Guide](#).

To process PassTickets, the external security manager uses Secure Signon keys that are shared by the originating and target systems. You must define a Secure Signon key for each target system. For information about how to do this with RACF by defining profiles in the PTKTDATA resource class, see [Using the secured signon function in z/OS Security Server RACF Security Administrator's Guide](#). Users of other external security managers should refer to the documentation for their product.

If the XPTKT system initialization parameter is set to YES (the default value), the region and userid have to be authorized to generate a PassTicket.

To allow an originating system to generate a PassTicket, issue the following commands to define RACF profiles for users on the originating region:

```
RDEFINE PTKTDATA IRRPTAUTH.applid.* UACC(NONE)
PERMIT IRRPTAUTH.applid.* CLASS(PTKTDATA) ID(user) ACCESS(UPDATE)
```

applid is the generic applid of the originating region.

user is the user or group of users allowed to generate PassTickets on this region.

For more information about PassTickets, see [z/OS Security Server RACF Security Administrator's Guide](#).

Using PassTickets in FEPI applications

A FEPI application uses the PassTicket and user ID to perform a sign-on in the back-end system just as if it were sending a password and user ID.

Before you begin

To process PassTickets, the external security manager uses keys, known as Secure Signon keys, that are shared by the front-end and back-end systems. You must define a Secure Signon key for each target system with which FEPI communicates. For information about how to do this with RACF by defining profiles in the PTKTDATA resource class, see [Using the secured signon function in z/OS Security Server RACF Security Administrator's Guide](#). Users of other ESMs should refer to the documentation for their product.

Procedure

1. The end user is verified by signing on to the front-end CICS system in the usual way.
2. When the end-user runs a transaction that uses FEPI, your application issues a **FEPI REQUEST PASSTICKET** command to obtain a PassTicket.

If EDF is being used, the PassTicket is not displayed. The user ID for which the PassTicket is generated is that of the currently signed-on user. Your FEPI application can use an **EXEC CICS ASSIGN** command to check the user ID of the currently signed-on user.

3. Your FEPI application uses the PassTicket and user ID to perform a sign-on in the back-end system. For example:

```
EXEC CICS FEPI SEND FORMATTED
                        CONVID(convid) FROM(CESN userid Passticket)
                        FROMLENGTH(length_of_data)
```

It is the application's responsibility to provide the sign-on processing, because CICS cannot know either the type of back-end system (CICS or IMS) or the back-end program being used for sign-on processing.

4. The back-end system uses an unchanged interface to perform the sign-on. A CICS system that receives a user ID and a PassTicket can use its existing procedures to sign on the user ID. RACF takes care of the fact that a PassTicket, rather than a password, is passed to it.

Results

If the PassTicket times out (because, for example, of a session failure), your application must generate another and try to sign on again. If sign-on continues to fail and the front-end and back-end are in different MVS systems, check that the system clocks are suitably synchronized. Too many failed sign-on attempts could result in the user ID being revoked.

What to do next

For detailed information about PassTickets, see [Using the secured signon function in z/OS Security Server RACF Security Administrator's Guide](#).

RACF facilities

CICS uses a number of RACF facilities in order to protect its resources.

RACF provides the following facilities:

- The necessary functions to record information identifying individual users of system resources, and information identifying the resources that require protection. The information you define to RACF about users and resources is stored in user and resource **profiles**.
- The facilities to define which users, or groups of users, are either permitted access, or excluded from access, to the resources for which profiles have been defined. The information recording the users, or groups of users, permitted to access any particular resource is held in an **access list** within the profile that protects a resource.
- A method to process requests, issued by subsystems or jobs running in an MVS system, to authenticate the identity of users defined to RACF, and to check their access authorization to resources.
- The facilities for logging security-related events, such as users signing on and signing off, the issuing of RACF commands, and attempts to access protected resources. Successful attempts to access protected resources may be recorded by the MVS System Management Facility (SMF). If you want to record all attempts to access protected resources, whether successful or not, use RACF auditing, as described in the [z/OS Security Server RACF Auditor's Guide](#). The RACF auditor can run the RACF report writer to generate reports based on the SMF records. For more information on logging RACF audit messages to SMF, see [“Logging RACF audit messages to SMF” on page 77](#).

For information on using RACF to perform **auditing** functions (specifying auditing operands on RACF commands, and using the RACF report writer to generate reports of audited security-related activity), see the [z/OS Security Server RACF Auditor's Guide](#).

RACF administration

As the security administrator for one or more CICS regions, and for the users of the CICS applications, it is your job to ensure that your installation's data is properly protected.

Using RACF, you are responsible for protecting all system resources, and, in the context of this manual, CICS resources in particular.

A key feature of RACF is its hierarchical management structure. The RACF security administrator is defined at the top of the hierarchy, with authority to control security for the whole system. If you are not

yourself the RACF security administrator, you must ask that person to delegate to you sufficient authority to work with RACF profiles and system-wide settings. You must also work with the RACF auditor, who can produce reports of security-relevant activity based on auditing records generated by RACF.

RACF security administrators have either the system-SPECIAL attribute, the group-SPECIAL attribute, or a combination of other authorities.

- If you have the system-SPECIAL attribute, you can issue any RACF command, and you can change any RACF profile (except for some auditing-related operands).
- If you have the group-SPECIAL attribute, your authority is limited to the scope of the RACF group for which you have the SPECIAL attribute.
- The other authorities include:
 - The CLAUTH (class authority) attribute, which allows you to define RACF profiles in specific RACF classes
 - That authority which goes with being the OWNER of existing RACF profiles, allows you to list profiles, change the access, and delete them
 - Having a group authority such as CONNECT or JOIN in a RACF group

For complete information about the authorities required to issue RACF commands, and for information on delegating authority and on the scope of a RACF group, see the [z/OS Security Server RACF Auditor's Guide](#).

For information on the RACF requirements for issuing RACF commands, see the descriptions of the commands in the [z/OS Security Server RACF Command Language Reference](#).

You can find out whether you have the system-SPECIAL or group-SPECIAL attribute by issuing the LISTUSER command from a TSO session. If you have the system-SPECIAL attribute, SPECIAL appears after the USER ATTRIBUTES phrase in the first part of the output. If you have the group-SPECIAL attribute, SPECIAL appears after the USER ATTRIBUTES phrase in the offset section that describes your connection to a RACF group. For a complete description, with an example of LISTUSER output, see the [z/OS Security Server RACF General User's Guide](#).

Delegation of RACF administrative responsibility

As CICS security administrator, you perform the following tasks (if you do not have the system-SPECIAL attribute, obtain the necessary authority):

- **Define and maintain profiles in CICS-related general resource classes.** In general, you grant authority to do this by assigning a user the CLAUTH (class authority) attribute in the specified classes. For example, the RACF security administrator could issue the following command:

```
ALTUSER your_userid CLAUTH(TCICSTRN)
```

This command gives access to all classes of the same POSIT number. The POSIT number is an operand of the ICHERCDE macro of the class descriptor table (CDT). For more information, see [“Activating the CICS classes” on page 18](#).

- **Define and maintain profiles in other resource classes.** Many of the general resource classes mentioned in this book (such as APPL, APPCLU, FACILITY, OPERCMDS, SURROGAT, TERMINAL, and VTAMAPPL) affect the operation of products other than CICS. If you are not the RACF security administrator, you may need to ask that person to define profiles at your request.
- **Add RACF user profiles to the system.** In general, you grant this authority by assigning the CLAUTH (class authority) attribute for “USER” in the user's profile. For example, the RACF security administrator could issue the following command:

```
ALTUSER your_userid CLAUTH(USER)
```

Whenever you add a user to the system, assign that user a default connect group. This changes the membership of the group (by adding the user as a member of the group). Therefore, if you have JOIN group authority in a group, the group-SPECIAL attribute in a group, or are OWNER of a group, CLAUTH(USER) lets you add users to the system and connect them to groups that are within the scope of the group.

- **List RACF system-wide settings and work with all profiles related to CICS.** You grant authority to do this by setting up a RACF group, ensuring that certain CICS-related RACF profiles are in the scope of that group, and connecting a user to the group with the group-SPECIAL attribute. For example, the RACF security administrator could issue the following command:

```
CONNECT your_userid GROUP(applicable-RACF_groupid) SPECIAL
```

With the SETROPTS GENERICOWNER command in effect and with prefixing active, administrators can be assigned. You do this by creating a generic profile in each class using the prefix as a high-level qualifier. For example:

```
RDEFINE TCICSTRN cics_region_id.** UACC(NONE)
OWNER(cics_region_administrator_userid)
```

The SETROPTS GENERIC command must be used before defining generic profiles, as described in “Summary of RACF commands” on page 23.

For more information on delegating RACF administration, see the [z/OS Security Server RACF Security Administrator's Guide](#).

RACF profiles

In RACF, a *profile* describes the security characteristics of a user, a group of users, or one or more computer resources.

User profiles

A *user profile* is a description of a RACF-defined user. The information in the profile includes the user ID, the user name, the user's password, the profile owner, user attributes, and other data. The user profile also contains user-related information for subsystems, including CICS.

Group profiles

A *group profile* defines a group of users. The information in the profile includes the group name, the profile owner, and the users in the group.

Data set profiles

A *data set profile* provides RACF protection for one or more data sets. The information in the profile includes the data set profile name, the profile owner, the universal access authority, the access list, and other data.

Data set profiles can be generic or discrete:

- A *generic profile* protects several resources with similar names and identical security requirements.
- A *discrete profile* protects a single resource.

General resource profiles

A *general resource profile* provides RACF protection for computer resources, other than data sets. The information in the profile includes the general resource profile name, the profile owner, the universal access authority, the access list, and other data. General resources with similar characteristics belong to the same *class*.

Like a generic profile, a *resource group profile* protects several resources with identical security requirements. However, the resources do not have to have similar names. Resource group profiles with similar characteristics belong to the same *resource group class*.

Resource profiles can be generic or discrete:

- A *generic profile* protects several resources with similar names and identical security requirements.
- A *discrete profile* protects a single resource.

RACF user profiles

A user profile is a description of a RACF-defined user. The information in the profile includes the user ID, the user name, the user's password, the profile owner, user attributes, and other data. The user profile also contains user-related information for subsystems, including CICS.

The user profiles consists of one or more segments—a RACF segment, and others that are optional. For CICS users, the important segments are:

- The RACF segment, which holds the basic information for a RACF user profile. See [“The RACF segment” on page 11](#).
- The CICS segment, which holds data for each CICS user. See [“The CICS segment” on page 12](#).
- The LANGUAGE segment, which specifies the user's national language preference. See [“The LANGUAGE segment” on page 15](#).

The RACF segment

You identify a RACF user by an alphanumeric userid, which RACF associates with the user profile for that user.

The "user" that you define to RACF need not be a person, such as a CICS terminal user. For example, in the CICS environment, a RACF userid can be associated with the procedure you use to start CICS as a started task; and a userid can be associated with a CICS terminal (for the purpose of preset security). The following list shows some of the basic segment information that RACF holds for a user:

Keyword

Description

USERID

The user's userid

NAME

The user's name

OWNER

The owner of the user's profile—the RACF administrator or other user authorized by the administrator, or a RACF group

DFLTGRP

The default group that the user belongs to

AUTHORITY

The user's authority in the default group

PASSWORD

The user's password

You define the RACF segment of a user profile using the ADDUSER command, or the RACF ISPF panels. When planning RACF segments of user profiles for CICS users, identify the groups that you want them to be in. Start by identifying RACF administrative units for the users. For example, you could consider all users who have the same manager, or all users within an order entry function, an administrative unit. RACF handles these units as groups of individual users who have similar requirements for access to CICS system resources.

For an overview of the steps required to add users to the system, see the [z/OS Security Server RACF Security Administrator's Guide](#).

The CICS segment

The CICS segment of the RACF user profile contains data for CICS users.

For information on the order in which CICS searches for the operator information, see [“Obtaining CICS-related data for a user”](#) on page 63.

The information you can specify in the CICS segment is as follows:

OPCLASS({1|number})

CICS uses the operator classes when routing basic mapping support (BMS) messages initiated within a CICS transaction. The operator classes are numeric values in the range 1–24.

Specify operator classes for users who use CICS transactions that issue EXEC CICS ROUTE commands with the (optional) OPCLASS parameter. For automatic routing to occur, you specify the corresponding value as an operator class in the CICS segment of the user profile.

For more information about message routing, see [Message routing](#).

OPIDENT({blank|name})

The 1- to 3-character operator identification code that you assign to each operator.

CICS stores the code in the operator's terminal entry in the CICS terminal control table (TCTTE) when the operator signs on. This operator ID is displayed in certain CICS messages and can also be used in the EXEC CICS ROUTE command for routing BMS messages. It is also used when using the CEDA LOCK command.

For more information about message routing, see [Message routing](#).

OPPRTY({0|number})

The operator priority value—a decimal number that you want CICS to use when determining the task priority for CICS transactions that the operator invokes at a CICS terminal. The priority value can be in the range 0 through 255, where 255 is the highest priority.

CICS uses the sum of operator priority, terminal priority, and transaction priority to determine the dispatching priority of a transaction.

TIMEOUT({0000|hhmm})

The time that must elapse since the user last used the terminal before CICS "times-out" the terminal.

The time must be a decimal integer in the range 0 through 9959 (the last two digits represent a number of minutes, and must be 00 through 59. Any digits to the left of these represent hours).

To specify one hour and eight minutes you would code a value here of 0108. For example:

```
ALTUSER userid CICS(TIMEOUT(0108))
```

The value of 0 (the default) means that the terminal is **not** timed out.

XRFSOFF({NOFORCE|FORCE})

The CICS persistent sessions restart and extended recovery facility (XRF) sign-off option. You specify this to indicate whether or not you want CICS to sign off the operator following a persistent sessions restart or an XRF takeover.

FORCE

Specify FORCE if you want CICS to sign off the operator automatically in the event of a persistent sessions restart or an XRF takeover.

NOFORCE

Specify NOFORCE if you want CICS to leave an operator signed on in the event of a persistent sessions restart or an XRF takeover.

You can specify the XRFSOFF function at the level of groups of similar terminals, and at the CICS system level:

- Use the RSTSIGNOFF attribute of the TYPETERM resource definition to specify the XRF SOFF function for groups of similar terminals.
- Use the **RSTSIGNOFF** system initialization parameter to specify the function at the system level.

In both cases, the default value is NOFORCE. If you specify the FORCE option in the system initialization table or the TYPETERM, it overrides a value of NOFORCE specified in the CICS segment.

Table 1 on page 13 shows how specifying FORCE or NOFORCE in the system initialization parameters, on the TYPETERM definition, and in the CICS segment together determine whether a terminal remains signed on after a persistent sessions restart or an XRF takeover. For a terminal to remain signed-on after a persistent sessions restart or an XRF takeover, NOFORCE must be specified in **all three locations**.

TYPETERM definition	CICS segment	System initialization parameter	Resulting terminal status
FORCE	FORCE	FORCE	Signed off
FORCE	FORCE	NOFORCE	Signed off
FORCE	NOFORCE	FORCE	Signed off
FORCE	NOFORCE	NOFORCE	Signed off
NOFORCE	FORCE	FORCE	Signed off
NOFORCE	FORCE	NOFORCE	Signed off
NOFORCE	NOFORCE	FORCE	Signed off
NOFORCE	NOFORCE	NOFORCE	Signed on

Note: If takeover has exceeded the time specified by the **RSTSIGNTIME** system initialization parameter, users at terminals that have a nonzero TIMEOUT value do not remain signed on after takeover. For example, suppose the following has been specified in a system that has XRF SOFF=NOFORCE:

```
ALTUSER USER1 CICS(XRFSOFF(NOFORCE) TIMEOUT(10))
ALTUSER USER2 CICS(XRFSOFF(NOFORCE) TIMEOUT(1))
```

If a persistent sessions restart or an XRF takeover occurs to a system in which XRFSTME=5 is specified in the system initialization parameters, and the restart or takeover takes longer than five minutes, USER1 does not remain signed on, but USER2 does.

Specifying default values in the CICS segment

The defaults listed are effective only when a CICS segment has been defined for that userid.

You can make the CICS segment default by defining it as follows:

```
ADDUSER userid DFLTGRP(group_name) NAME(user_name)
OWNER(group_id|userid)
PASSWORD(password)
CICS
```

For example, you may want to define a CICS segment in this way if you want to enforce the **system** defaults, rather than the default user attributes, or if you are setting up a test system and have not yet decided on the values you want to use.

If you omit the CICS segment completely, defaults are obtained as described in [“Obtaining CICS-related data for a user”](#) on page 63.

If you specify some of the CICS segment options, but omit others, the defaults described in this document apply to the omitted options.

You can remove the CICS segment as follows:

```
ALTUSER userid NOCICS
```

Creating or updating segment data for a CICS user

To create or update CICS segment data for a CICS user, specify the CICS option on the RACF ADDUSER command for a new user, or on the ALTUSER command for an existing user.

For example, the following command adds a new CICS user to the RACF database with associated CICS operator data:

```
ADDUSER userid DFLTGRP(group_name) NAME(user_name) OWNER(group_id)
PASSWORD(password)
CICS(OPCLASS(1,2,...,n) OPIDENT(identifier) OPPRTY(priority)
      TIMEOUT(timeout_value) XRFSSOFF(NOFORCE))
LANGUAGE(PRIMARY(primary_language))
```

The following example of the ALTUSER command adds CICS operator data to an existing user in the RACF database:

```
ALTUSER userid
CICS(OPCLASS(1,2,...,n) OPIDENT(identifier) OPPRTY(priority)
      TIMEOUT(timeout_value) XRFSSOFF(NOFORCE))
LANGUAGE(PRIMARY(primary_language))
```

Before issuing these commands to define CICS operator data, ensure that the CICS-supplied RACF dynamic parse validation routines are installed in an APF-authorized library in the linklist. See [“CICS-supplied RACF dynamic parse validation routines”](#) on page 29 for details of these exits.

If you do not have the system-SPECIAL attribute, ask your RACF security administrator for the authority to list or update the CICS and LANGUAGE segments in the user profiles. Listing or updating these segments is done by creating profiles in the RACF FIELD class. For more information, see [“Controlling access to fields in RACF profiles”](#) on page 27.

If you want to change the opclass but you do not want to respecify the list, you can use the ADDOPCLASS and DELOPCLASS operands. For example:

```
ALTUSER userid
CICS(ADDOPCLASS (1,2)
      DELOPCLASS (6,7))
```

Changing the RACF profile of a remote user

CICS is notified of certain changes in the RACF profile of a signed-on remote user, or a signed-on user who is not directly using a physical terminal or console, through a type 71 RACF Event Notification (ENF).

RACF sends type 71 ENFs when RACF commands such as **ALTUSER** with the REVOKE option, **CONNECT**, **REMOVE**, **DELGROUP** and **DELUSER** affect the group authorization of a user. In addition, with RACF APAR OA58677 and SAF APAR OA58678, RACF sends a type 71 ENF when a user ID is revoked automatically as a result of too many failed password attempts.

CICS monitors for such RACF type 71 ENFs. Notification of a change to the user ID overrides any setting that is specified in the **USRDELAY** system initialization parameter. Therefore, review your **USRDELAY** settings.

For example, CICS is notified when you use the REVOKE option on the **ALTUSER** command, with no date specified, to revoke a user ID with immediate effect. However, CICS is not notified when a user ID expires, or for a user ID that is signed on to a local region (for example, a TOR that uses the CESN transaction to sign on).

When a RACF profile change occurs and CICS receives a new attach request for a user ID, CICS performs an implicit sign-on for the user ID and the new RACF profile information is used. Existing tasks for that user continue with the RACF profile that was valid when the task was attached.

If you specified a low value for the **USRDELAY** system initialization parameter to ensure that CICS detects changes to RACF profiles promptly, you might want to increase this value, because CICS is now notified

immediately if RACF profile changes occur. The primary impact of a high **USRDELAY** value is that the amount of storage used for RACF control blocks is increased.

If you alter the RACF profile of a signed-on remote user, for example by revoking the user, CICS continues to use the authorization established at the first attach request until one of the following situations occurs:

- The transaction performs a syncpoint.
- The attach request ends.
- Sign off occurs because RACF notifies CICS of changes to a user profile, and an attached request associated with that signed-on user ID completes, for all operands of ATTACHSEC except LOCAL.
- Sign off occurs because RACF notifies CICS of changes to a user profile, a new attach request is made, and the value in the **USRDELAY** system initialization parameter has not expired. This sign off is followed by a sign on.

CICS default user

When you are using CICS with external security, CICS assigns the security attributes of the CICS *default user* to all CICS terminal users who do not sign on.

CICS also assigns the operator data from the CICS segment of the default user to signed-on users who do not have their own CICS segment data. To enable CICS to assign default security attributes and operator data, you define a CICS default user id to RACF. You then tell CICS which default user to use by specifying the **DFLTUSER** system initialization parameter. If you do not specify a default user id on the **DFLTUSER** parameter, CICS uses the name "CICSUSER."

Whether you use installation-defined operator data on your **DFLTUSER** parameter, or use the default, it is essential that the userid is defined to RACF and that the region user id has installed surrogate security to use the default user (see [“Surrogate user security”](#) on page 113).

CICS "signs on" the default user during system initialization. **If you specify SEC=YES as a system initialization parameter, and CICS cannot "sign on" the default userid, CICS initialization fails.**

CICS uses the security attributes of the default userid to perform all the security checks for terminal users who do not explicitly sign on. These security checks include **resource** and **command** security checking, in addition to **transaction-attach** security checking.

Note: If the default user's RACF profile specifies a non-zero TIMEOUT, that value does **not** apply to terminals that do not sign on.

The LANGUAGE segment

The language segment holds information about the national language in which the user receives messages.

You can specify two languages, but CICS assigns each user only one language. CICS assigns the primary language if the language is specified and corresponds to a [language suffix on the NATLANG system initialization parameter](#). Otherwise, CICS assigns the secondary language. If neither the primary nor the secondary language corresponds to a **NATLANG** value, the language must be provided from elsewhere. See [“Obtaining CICS-related data at signon”](#) on page 63.

To specify a preferred national languages in the LANGUAGE segment of the RACF user profile, ensure that the language is defined in the CICS system and then use the **LANGUAGE** parameter on the ADDUSER or ALTUSER command. The following example shows a language request in the ALTUSER command:

```
ALTUSER userid LANGUAGE(PRIMARY(language_code) SECONDARY(language_code))
```

The information you can specify is as follows:

LANGUAGE

Use this parameter to specify primary and secondary languages for CICS users. CICS accepts and uses the languages you define in the segment, but ignores the RACF system-wide defaults. This is because CICS has its own system default for national languages, which you specify on the CICS system initialization parameter, **NATLANG**.

PRIMARY(language_code)

Specifies the user's primary language, overriding the system default. Depending on the national language feature you have installed, you can specify this as one of the 3-character codes in [National language codes](#).

SECONDARY(language_code)

Specifies the user's secondary language, overriding the system default. Depending on the national language feature you have installed, you can specify this as one of the 3-character codes in [National language codes](#).

Notes:

1. CICS messages are supported only in UK English, Simplified Chinese, and Japanese. If any other language other than those three is specified, English is used by default.
2. CICS ignores the RACF default national language defined by the SETROPTS command:

```
SETROPTS LANGUAGE(PRIMARY(...) SECONDARY(...))
```

For more information about national language, see [“National language and non-terminal transactions” on page 66](#).

RACF group profiles

In addition to defining individual user profiles in RACF, you can define group profiles. A group profile defines a group of users.

A group profile can contain information about the group, for example, who owns it, which subgroups it has, and a list of connected users. For details of how to define and use group profiles, see the [z/OS Security Server RACF Security Administrator's Guide](#). A group profile is different from a resource group profile, which defines a group of resources and is explained in [“RACF general resource profiles” on page 18](#).

Users who are members of groups can share common access authorities to protected resources. For example, you might want to set up groups as follows:

- Users who work in the same department
- Users who work with the same sets of transactions, files, terminals, or other resources that you choose to protect with RACF
- Users who sign on to the same regions (if you have more than one CICS region)

In a CICS environment, group profiles offer a number of advantages:

- Easier control of access to resources
- The ability to assign authorities using the group-SPECIAL attribute or CONNECT group authority
- Fewer refreshes to in-storage profiles.

Aim to make your point of control the presence (or absence) of a user ID in a group, not the access list of the resource profile. When someone leaves a department, removing the user ID from the department user group revokes all privileges. No other administration of profiles is required. Thus, you keep RACF administration to a minimum and avoid an excessive number of resource profiles.

RACF maintains in-storage copies of resource profiles, so changes to those profiles do not take effect on the system until the in-storage profiles are refreshed.

The authority to access a resource is kept in an access list that is part of the resource profile. The authority can be granted to a user or to a group. To add or remove a user from the access list, refresh the profile in main storage. For more information, see [“Refreshing resource profiles in main storage” on page 18](#).

If you connect and remove a user from a group that is already in the access list, that user acquires or loses the authority of the group without needing to refresh the profile. Any user with CONNECT group authority in that group can change the membership of the group, using the CONNECT and REMOVE commands. In this way, you do not have to change the access list of the affected profiles (through the

use of the PERMIT command). If you do not change a CICS general resource profile, you do not have to refresh its in-storage copy. However, users might have to sign on again, if their group membership has been changed.

For other benefits obtained from creating groups, see the [z/OS Security Server RACF Security Administrator's Guide](#).

The following command sequence creates a new group of users and moves a user from an existing group to the new group:

```
ADDGROUP group_name2
REMOVE user1 GROUP(group_name1)
CONNECT user1 GROUP(group_name2)
```

CICS is notified of certain changes in the RACF profile of a signed-on remote user, or a signed-on user who is not directly using a physical terminal or console, through a type 71 RACF Event Notification (ENF).

RACF data set profiles

Using RACF facilities, you can protect data sets on direct access storage devices (DASD) and tape by defining profiles for the data sets you want to protect.

The rules for defining data set profiles to RACF are described in the [z/OS Security Server RACF Security Administrator's Guide](#), and the [z/OS Security Server RACF Command Language Reference](#). For examples, see the [z/OS Security Server RACF General User's Guide](#).

You define profiles to protect two RACF categories of data sets:

1. Profiles for **user data sets**, where the high-level qualifier is a RACF userid. All RACF-defined users can protect their own data sets.
2. Profiles for **group data sets**, where the high-level qualifier is a RACF group name (see “[RACF group profiles](#)” on page 16 for information about RACF groups). A RACF-defined user can RACF-protect group data sets provided the user has the necessary authority or attributes. (See the [z/OS Security Server RACF Security Administrator's Guide](#) for details.)

Note: Data set profiles do not apply to CICS terminal users, but only to the CICS region userid.

Generic data set profiles

By using generic profiles, you can reduce the number of profiles needed to protect data sets, and also reduce the required size of the RACF database. In addition, generic profiles are not volume-specific (that is, data sets protected by a generic profile can reside on any volume).

Usually, you specify generic data set profile names by specifying a generic character; for example percent (%) or asterisk (*) in the profile name. For data set profiles, RACF distinguishes between asterisk (*) and double asterisk (**) if RACF's enhanced generic naming is in effect. See the [z/OS Security Server RACF Command Language Reference](#) for the rules governing generic profile names in the RACF DATASET class.

For example, if you have a group called CICSTS54.CICS, you can define a generic profile named 'CICSTS54.CICS.**', and any user in the access list of this profile can access, at the authorized level, data sets with the high-level qualifier CICSTS54.CICS. For example:

```
ADDSD 'CICSTS54.CICS.**' UACC(NONE) NOTIFY(admin_userid)
```

Use the SETROPTS GENERIC command before defining generic profiles, as described in “[Summary of RACF commands](#)” on page 23.

Note: Examples in this book show double asterisks (**), which require that enhanced generic naming be in effect. If enhanced generic naming is not in effect, use a single asterisk (*) in place of double asterisks. (You put enhanced generic naming into effect by issuing the RACF SETROPTS EGN command. Note that SETROPTS EGN affects only data set names. Enhanced generic naming is always in effect for general resource profiles, such as TCICSTRN.)

RACF general resource profiles

RACF supplies a number of resource classes that CICS uses for its resources.

A *general resource profile* provides RACF protection for computer resources, other than data sets. The information in the profile includes the general resource profile name, the profile owner, the universal access authority, the access list, and other data. General resources with similar characteristics belong to the same *class*.

Like a generic profile, a *resource group profile* protects several resources with identical security requirements. However, the resources do not have to have similar names. Resource group profiles with similar characteristics belong to the same *resource group class*.

They are described in [“RACF classes for CICS resources”](#) on page 19. Other RACF resource classes contain profiles that are used for resources that are used by CICS and other subsystems. They are described in [“RACF classes for protecting system resources”](#) on page 20.

Protecting a resource

These are the steps that you must perform in order to protect a resource:

1. Define a profile for the resource in a suitable resource class
2. Define an *access list* which specifies:
 - the users that are permitted to access the resource
 - the level of access that each user is allowed

Activating the CICS classes

To activate the CICS resource class for use in security checking by the CICS region, use the RACF **SETROPTS** command.

As soon as the CICS resource class is defined in the active RACF class descriptor table, administrators can define general resource profiles to the class. For more information, see the descriptions of RDEFINE and PERMIT in [“RACF general resource profiles”](#) on page 18. Note that the class must be activated before the CICS system can use the profiles that the administrators define.

The format of the SETROPTS command is SETROPTS CLASSACT(*classname*). For example:

```
SETROPTS CLASSACT(TCICSTRN)
```

All sets of RACF general resource classes that have the same POSIT number in their CDT definitions are activated and deactivated together. Therefore, you need only specify one IBM-supplied CICS class to activate all the IBM-supplied CICS-related classes. If you define your own installation-defined classes with the same POSIT number as the IBM-supplied classes, they are activated and deactivated with the IBM-supplied classes. To provide separate controls for sets of installation-defined classes, define them with different POSIT numbers. (For more information on the POSIT number, see [z/OS Security Server RACF Macros and Interfaces](#).)

Refreshing resource profiles in main storage

Refresh the classes defined in RACLIST by using the TSO command:

```
SETROPTS RACLIST(xxxxxxxx) REFRESH
```

where xxxxxxxx is the RACF class to be refreshed. A **CEMT PERFORM SECURITY REBUILD** command gives a response of NOT REQUIRED.

After adding or updating a profile, either for a member class or a resource grouping class, you must issue the command:

```
SETROPTS RACLIST (TCICSTRN) REFRESH
```

Even if you have added the profile to the GCICSTRN resource grouping class, you must issue this command for the TCICSTRN member class only. When you use this command, the definitions are updated in RACF and CICS uses the changed profiles.

RACF classes for CICS resources

To protect a CICS resource, you must create a general resource profile for the resource in a suitable class or resource grouping class. RACF provides several classes for CICS resources. You can also define your own resource classes.

Notes®:

1. The initial character of the class names is significant when you define your own classes. For example, if you define your own classes for CICS programs, the names you choose must start with M and N for the member class and the resource grouping class respectively.
2. There are no default resource class names for DB2ENTRY resources. You must define your own resource classes for these resources. See [“Resource classes for DB2ENTRYs”](#) on page 22 for more information.
3. Profile names in the RCICSRES class must contain a prefix that specifies the CICS resource type to which they apply: *ATOMSERVICE.name* for ATOMSERVICE definitions, *BUNDLE.name* for bundles, *DOCTEMPLATE.name* for CICS document templates, *EPADAPTER.name* for EP adapters, *EPADAPTERSET.epadapterset_resource_name* for EP adapter sets, *EVENTBINDING.name* for event bindings, or *XMLTRANSFORM.name* for XML transforms.

Member class	Resource grouping class	Description
TCICSTRN	GCICSTRN	CICS transactions, normal attach security
PCICSPSB	QCICSPSB	CICS PSBs
ACICSPCT	BCICSPCT	CICS-started transactions and the following EXEC CICS commands: COLLECT STATISTICS TRANSACTION DISCARD TRANSACTION INQUIRE TRANSACTION SET TRANSACTION
DCICSDCT	ECICSDCT	CICS transient data queues
FCICSFCT	HCICSFCT	CICS files
JCICSJCT	KCICSJCT	CICS journals
MCICSPPT	NCICSPPT	CICS programs
SCICSTST	UCICSTST	CICS temporary storage queues
CCICSCMD	VCICSCMD	EXEC CICS SYSTEM commands and EXEC CICS FEPI system commands
RCICSRES	WCICSRES	Document templates, bundles, EP adapters, EP adapter sets, event bindings, ATOMSERVICE definitions, and XML transforms

RACF classes for CICSplex SM resources

Protection for CICSplex SM resources is provided by the following general resource classes:

CPSMOBJ

Controls access to CICSplex SM resources. The corresponding resource group class is GCPSMOBJ. For more information, see [“Implementing CICSplex SM security” on page 165.](#)

CPSMXMP

Controls exemption from simulated CICS security checking in CICSplex SM. For more information, see [“Exempting users and resources from security checking” on page 208](#)

RACF resource class names

By using the resource group profiles, you can reduce the number of profiles you need to maintain in the resource classes.

Further, provided you avoid defining duplicate member names, using this method reduces the storage requirements for the RACF in-storage profiles that CICS builds during initialization.

RACF provides an in-storage checking service to avoid the I/O operations that would otherwise be needed in RACF. (It does this by means of the RACROUTE REQUEST=FASTAUTH macro.) For this purpose, CICS requests RACF to bring its resource profiles into main storage during CICS initialization.

To make administration easier, avoid defining duplicate profiles. If duplicates are encountered as RACF loads the profiles into storage, it merges the profiles according to the ICHRLX02 selection exit. If no selection exit is installed, RACF follows the default merging rules as indicated in the RLX2P data area. For more information about this, see [Resolving Conflicts among Multiple Profiles in z/OS Security Server RACF Security Administrator's Guide.](#)

RACF classes for protecting system resources

CICS uses many system resources, and these must be protected against unauthorized access. This protection is provided by profiles in several general resource classes.

APPCLU

Verifies the identity of APPC partner logical units (LU type 6.2) during z/OS Communications Server session establishment. For more information, see [“Defining profiles in the APPCLU general resource class” on page 223.](#)

APPL

Controls terminal users' access to z/OS Communications Server applications, including CICS. For more information, see [“Authorizing access to the CICS region” on page 43.](#)

CONSOLE

Controls user access to consoles. For more information, see [“Console profiles” on page 58.](#)

DIGTCERT

Contains digital certificates, and related information. For more information, see [“Creating new RACF certificates” on page 298.](#)

FACILITY

The FACILITY general resource class is used to protect several different system resources. These are described in [“Resources protected by the FACILITY general resource class” on page 21.](#)

FIELD

Controls access to fields in RACF profiles. For more information, see [“Controlling access to fields in RACF profiles” on page 27.](#)

IDIDMAP

The IDIDMAP resource profile contains the distributed identity filter. RACF uses the term *distributed identity filter* to describe a mapping association between a RACF user ID and one or more distributed identities. For more information, see [“Configuring RACF for identity propagation” on page 159.](#)

JESSPOOL

Protects JES spool data sets. For more information, see [“JES spool protection in a CICS environment” on page 46.](#)

LOGSTRM

Controls access to the MVS logstreams that CICS uses for its system logs and general logs. For more information, see [“Authorizing access to MVS log streams” on page 35](#).

OPERCMDS

- Controls which console users are allowed to issue MODIFY commands directed to particular CICS regions. For more information, see [“Using an MVS system console as a CICS terminal” on page 61](#).
- Controls which operator commands CICS can issue; for example, commands in the command list table (CLT), and MODIFY network commands.

PROGRAM

Controls which users can start CICS. For more information, see [“Protecting CICS load libraries” on page 30](#).

PROPCNTL

Prevents the CICS region user ID being propagated to jobs that are submitted from CICS to the JES internal reader, and that do not specify the USER operand. For more information, see [“Controlling userid propagation” on page 44](#).

PTKTDATA

Contains the encryption keys used for generating and validating PassTickets. For more information, see [“Generating and using PassTickets for secure sign-on” on page 6](#).

STARTED

Contains profiles that provide the user IDs for MVS started jobs. For more information, see [“Using STARTED profiles for started jobs” on page 31](#).

SUBSYSNM

Authorizes subsystems (such as instances of CICS) to open a VSAM ACB and use VSAM Record Level Sharing (RLS) functions. For more information, see [“Authorizing access to SMSVSAM servers” on page 42](#).

SURROGAT

Specifies which user IDs can act as surrogates for other user IDs. For more information, see [“Surrogate user security” on page 113](#).

TERMINAL

Controls the ability of users to sign on at individual terminals. The corresponding resource group class is GTERMINL. For more information, see [Terminal profiles](#).

VTAMAPPL

Controls the ability of users to open an SNA ACB. For more information, see [“Controlling the opening of a CICS region's z/OS Communications Server ACB” on page 44](#).

Note: VTAM® is now z/OS Communications Server (for SNA or IP)

Resources protected by the FACILITY general resource class

The FACILITY general resource class is used to protect several different system resources.

They are:

Library lookaside (LLA) libraries

The FACILITY class controls a program's ability to use the LLACOPY macro. For more information, see [“Authorizing access with the MVS library lookaside \(LLA\) facility” on page 38](#).

The CICS interregion communication program, DFHIRP

The FACILITY class controls a region's ability to log on to the CICS interregion communication program, DFHIRP. For more information, see [“Implementing MRO security” on page 265](#).

Shared data tables

The FACILITY class controls a file-owning region's ability to act as a shared data table server. For more information, see [“Security for CICS shared data tables” on page 275](#).

Coupling facility data tables

The FACILITY class controls the following:

- The ability of a CICS region to connect to a coupling facility data table (CFDT)
- The ability of the CFDT server to act as a server for a CFDT pool
- The ability of the CFDT server region to connect to the coupling facility list structure for its CFDT pool

ability of a coupling facility data table (CFDT) server to act as a server for a CFDT pool. It also controls the server's access to the coupling facility list structure for the pool. For more information, see [“Security for coupling facility data tables” on page 278.](#)

Named counter servers

The FACILITY class controls the following:

- The ability of a CICS region to connect to a named counter server
- The ability of the named counter server to act as server for a named counter pool
- The ability of the named counter server region to connect to the coupling facility list structure for its named counter pool

For more information, see [“Authorizing access to named counter pools and servers” on page 41.](#)

Shared temporary storage

The FACILITY class controls the following:

- The ability of a CICS region to connect to a shared temporary storage (TS) server
- The ability of the shared TS server to act as server for a shared TS pool
- The ability of the shared TS server region to connect to the coupling facility list structure for its shared TS pool

For more information, see [“Authorizing access to the temporary storage pools” on page 39.](#)

Log streams

The FACILITY class controls the ability of a CICS region to connect to the coupling facility list structures used for MVS log streams. For more information, see [“Authorizing access to MVS log streams” on page 35.](#)

AUTHTYPE and COMAHTYPE userids in DB2® definitions

The FACILITY class controls the following:

- The ability of users to install DB2CONN and DB2ENTRY definitions that specify the AUTHID or COMMAUTHID attributes
- The ability of users to use a CREATE DB2CONN or CREATE DB2ENTRY command that specifies the AUTHID or COMMAUTHID attributes
- The ability of users to change the AUTHID or COMMAUTHID attributes of an installed DB2CONN or DB2ENTRY

For more information, see [Controlling access to DB2-related resources in CICS.](#)

CICSplex SM resources

The FACILITY class controls access to many CICSplex SM resources. For more information, see [“Implementing CICSplex SM security” on page 165.](#)

Resource classes for DB2ENTRYs

CICS supports resource security checking for CICS-defined DB2ENTRY resources, for which there are no IBM-supplied RACF resource classes.

For DB2ENTRYs, you define security profiles in user-defined class names, and use the XDB2 system initialization parameter to specify the class name to CICS. The syntax for the XDB2 system initialization parameter is XDB2=NO|*name*, which does not support a default class name like the other security system initialization parameters. Use the DFH\$RACF sample job as an example of how to define DB2 resource class names for CICS use.

Do not define DB2ENTRY profiles in any of the CICS default resource classes. CICS uses RACLIST to activate the profiles in the default resource classes according to the *Xname* system initialization security parameters you specify, and XDB2 should specify a user-defined class name defined specifically for DB2ENTRY resources.

Summary of RACF commands

Much of the RACF activity dealing with protected CICS resources involves creating, changing, and deleting **general resource profiles**.

Note:

1. The commands described here, and the operands used in the examples, are not exhaustive.
2. The sequences of commands shown here demonstrate one way to accomplish a given task. There may be other sequences of commands that you can use.

For full details of RACF commands, refer to [z/OS Security Server RACF Command Language Reference](#).

Creating general resource profiles

To create a general resource profile, use the RDEFINE command. Generally, once you have created a profile, you then create an access list for the profile using the PERMIT command.

In this example, the three RDEFINE commands define three profiles named CEMT, CEDA, and CEDB in the TCICSTRN resource class. The three PERMIT commands allow two groups of users to access each transaction:

```
RDEFINE TCICSTRN CEMT UACC(NONE)
        NOTIFY(sys_admin_userid)
RDEFINE TCICSTRN CEDA UACC(NONE)
        NOTIFY(sys_admin_userid)
RDEFINE TCICSTRN CEDB UACC(NONE)
        NOTIFY(sys_admin_userid)
PERMIT  CEMT CLASS(TCICSTRN) ID(group1, group2) ACCESS(READ)
PERMIT  CEDA CLASS(TCICSTRN) ID(group1, group2) ACCESS(READ)
PERMIT  CEDB CLASS(TCICSTRN) ID(group1, group2) ACCESS(READ)
```

Creating a resource group profile

To define a profile in a resource grouping class, use the RDEFINE command with the ADDMEM operand to add resources as members of the group. Generally, once you have created a profile, you then create an access list for the profile using the PERMIT command.

In this example, the RDEFINE command defines a resource group profile named CICSTRANS in the GCICSTRN resource grouping class. The PERMIT command allows two groups of users to access all transactions in the profile.

```
RDEFINE GCICSTRN CICSTRANS UACC(NONE)
        ADDMEM(CEMT, CEDA, CEDB)
        NOTIFY(sys_admin_userid)
PERMIT  CICSTRANS CLASS(GCICSTRN) ID(group1, group2) ACCESS(READ)
```

Creating a general resource profile

Use the RDEFINE command to create a profile in a general resource class:

```
RDEFINE class profile UACC(NONE)
```

where:

class is the name of the general resource class
profile is the name of the new profile

Specify UACC(NONE) to ensure that there is no default access to the profile.

Permitting access to a general resource

To permit access to a general resource, use the PERMIT command to create an access list for the general resource profile:

```
PERMIT profile CLASS(class)
      ID(user) ACCESS(authority)
```

where:

profile is the name of the new profile

class is the name of the general resource class

user is the user (or group of users) that is being given access authority to the resource

authority is the level of authority that is being granted to the user

Removing an entry from an access list

To remove the entry for a user or group from an access list, issue the PERMIT command with the DELETE operand instead of the ACCESS operand:

```
PERMIT profile_name CLASS(class_name)
      ID(user|group) DELETE
```

Changing a profile

If you want to change a profile (for example, changing UACC from NONE to READ), use the RALTER command:

```
RALTER class_name profile_name UACC(READ)
```

Deleting a profile

To delete a profile, use the RDELETE command. For example:

```
RDELETE class_name profile_name
```

Copying from a profile

You can copy an access list from one profile to another. To do so, specify the FROM operand on the PERMIT command:

```
PERMIT profile_name CLASS(class_name)
      FROM(existing_profile_name) FCLASS(class_name)
```

You can copy information from one profile to another. To do so, specify the FROM operand on the RDEFINE or RALTER command:

```
RDEFINE class_name profile_name
        FROM(existing_profile_name) FCLASS(class_name)
```

Note: Do not plan to do this if you are using resource group profiles. RACF does not copy the members (specified with the ADDMEM operand) when copying the profile. Also, there are other ways in which the new profile might not be an exact copy of the existing profile. For example, RACF places the userid of the resource profile owner in the access list with ALTER access authority. For complete information, see the description of the FROM operand on the appropriate commands in the [z/OS Security Server RACF Command Language Reference](#).

Listing profiles in a class

To list the names of profiles in a particular class, use the SEARCH command. The following command lists profiles in the TCICSTRN class:

```
SEARCH CLASS(TCICSTRN)
```

The following command lists all profiles and their details in the GICISTRN class:

```
SEARCH CLASS(GICISTRN)
RLIST GICISTRN * ALL
```

For information on resource classes, see [“RACF general resource profiles”](#) on page 18.

Note: If you are a group-SPECIAL user (not system-SPECIAL), the SEARCH command might not list all the profiles that exist in a class. To get a complete list of profiles in a class, you must have at least the authority to list each profile. For further information, see the description of RACF requirements for the SEARCH command in the [z/OS Security Server RACF Command Language Reference](#), and [Which profile is used to protect the resource?](#).

Activating protection for a class

To begin protecting all the resources protected by profiles in a RACF class, activate that class by issuing the SETROPTS command with CLASSACT specified:

```
SETROPTS CLASSACT(class_name)
```

Defining a generic profile

Before you can use RDEFINE to define a generic profile (that is, one that uses an asterisk (*), double asterisk (**), ampersand (&), or percentage (%) character), first issue the command:

```
SETROPTS GENERIC(class_name)
```

Deactivating protection for a class

Deactivating a class turns off protection without disturbing the profiles themselves. If a class is deactivated, RACF issues a "not protected" return code to CICS for **all resources** in that class. CICS treats this response as “access denied”. To deactivate a RACF class, issue the SETROPTS command with NOCLASSACT specified:

```
SETROPTS NOCLASSACT(class_name)
```

Determining active classes

To determine which RACF classes are currently active, issue the SETROPTS command with LIST specified:

```
SETROPTS LIST
```

Activating support for mixed case passwords

To turn support for mixed case passwords on, issue the SETROPTS command with PASSWORD specified:

```
SETROPTS PASSWORD(MIXEDCASE)
```

To turn support for mixed case passwords off, issue the SETROPTS command:

```
SETROPTS PASSWORD(NOMIXEDCASE)
```

Mixed case passwords are supported in z/OS Security Server (RACF) 1.7 and above.

Security classification of data and users

RACF gives you the means to classify some or all of the resources on your system. You can use security levels, security categories, or both, to protect any CICS-related resource.

Consider classifying resources if you want to control access to them without having to specify access lists in each resource profile. If you classify a resource, only users whose user profiles are appropriately classified will be able to access that resource. For information on using security levels and security categories, see the [z/OS Security Server RACF Security Administrator's Guide](#). Because CICS uses the RACROUTE REQUEST=FASTAUTH function, some services such as security labels and global access

checking are not available under CICS. See the [z/OS Security Server RACF Security Administrator's Guide](#) for information on what is available with FASTAUTH.

You can also put users with the same access or logging requirements into groups. A user can belong to one or more groups, one of which is their default. The sign-on process allows the user to override the default RACF user group name. If “list of groups checking” is inactive, signing on with different group names might give a user different authorities.

Defining your own resource classes

You can define your own resource classes so that you have a unique resource class name for each CICS region.

Defining your own resource class names can have the following benefits:

Controlling access from other regions

You can prevent users running in one CICS region from accessing the resources of other CICS regions that have different class names specified. (You can also do this by using prefixing; see the description of the SECPRFX parameter in “[Security-related system initialization parameters](#)” on page 46.)

Group administrator for each region

For each CICS region with installation-defined classes, you can authorize a different group administrator to create profiles to be used by that region.

To get this benefit, define the installation-defined classes with a POSIT number other than 5 (the POSIT number of the IBM-supplied CICS classes). Then give the group administrator the CLAUTH (class authority) for at least one of those classes.

Use the SETROPTS GENERIC command before defining generic profiles, as described in “[Summary of RACF commands](#)” on page 23.

With prefixing active, you can also assign different administrators without fear of conflict. To do this, create a generic profile in each class, using the prefix as a high-level qualifier. For example:

```
RDEFINE TCICSTRN cics_region_id.** UACC(NONE)
OWNER(cics_region_administrator_userid)
```

The administrator specified as the OWNER of each such profile can create and maintain more specific profiles. The other administrators cannot do so.

Setting up installation-defined classes

To set up installation-defined classes, work with your RACF system programmer to add new class descriptors to the installation-defined part (module ICHRR01) of the RACF class descriptor table (CDT).

For an example of how to add installation-defined classes to the CDT, see [Customizing security processing](#).

All installation-defined classes defined in the CDT must also be defined in the MVS router table. This is because the MVS router checks any class used in a router request to determine if it exists. If it does not, no request is sent to RACF. To define classes to the MVS router, add them to ICHRR01, the user-modifiable portion of the MVS router table, as described in the [z/OS Security Server RACROUTE Macro Reference](#). Also see “[Specifying user-defined resources to RACF](#)” on page 137.

When setting up installation defined classes, we recommend that you copy the IBM-supplied defaults from the CDT, an example of which is in [z/OS Security Server RACF Macros and Interfaces](#). You will then need to change the name, group or member name, POSIT number, and ID. See the description of the ICHRR01 macro in [z/OS Security Server RACF Macros and Interfaces](#) for details of valid values for these operands. See the same manual for information about creating installation-defined resource classes. For an example of how to add resource classes, see the IBM-supplied sample, DFH\$RACF, which is in CICSTS54.CICS.SDFHSAMP.

For CICS resources, the first character of the resource class name is predefined by CICS, consistent with the default resource class name. You can define the second through eighth characters of the resource

class name, but for ease of administration it is recommended that you specify the same characters for both the member and group class. The seven characters specified for the member class are the part of the resource class name you define to CICS in the various *Xname* parameters, except for the following:

- XDB2, which has no CICS-defined prefix letter, so any defined class name of 1- to 8-characters can be specified. It is recommended that you use a specific class or classes dedicated to these resources.
- XAPPC and XUSER, which have no "name" option, and are either YES or NO to say whether security is active or not.

You should avoid using the letters "CICS" in the second through fifth characters in any class name you define. RACF requires that at least one of the characters in the classname should be a national or numeric character.

Controlling access to fields in RACF profiles

Use the FIELD resource class to define profiles that control access to fields in the RACF database.

By creating profiles in the RACF FIELD class, in the following form, you can permit listing or updating of the CICS or LANGUAGE segments in the user profiles, and of appropriate fields in partner-LU profiles.

```
USER.CICS.OPIDENT
USER.CICS.OPCLASSN
USER.CICS.OPPRTY
USER.CICS.TIMEOUT
USER.CICS.XRFSOFF
USER.LANGUAGE.USERNL1
USER.LANGUAGE.USERNL2
APPCLU.SESSION.SESSKEY
APPCLU.SESSION.KEYINTVL
APPCLU.SESSION.SLSFLAGS
```

Alternatively, you can set up a generic profile `USER.CICS.**`, to control access to all fields in the CICS segment. Before defining generic profiles use the `SETROPTS GENERIC` command, as described in [“Summary of RACF commands” on page 23](#).

You need READ access to list these profiles, and UPDATE access to change them. For further guidance, see the section on field level access checking in the [z/OS Security Server RACF Security Administrator's Guide](#).

Chapter 2. Implementing RACF protection in a single CICS region

This part explains how to protect CICS resources in a single CICS region.

CICS system resource security

This topic describes how to protect the system resources that CICS requires.

CICS installation requirements for RACF

You can control access to the resources used by your CICS region (or regions) by using RACF facilities. The CICS libraries supplied on the distribution volume include the CICS modules you need to support external security management.

CICS-supplied RACF dynamic parse validation routines

To define CICS terminal operator data, use the CICS-supplied RACF dynamic parse validation routines. Install these routines in SYS1.CICSTS54.CICS.SDFHLINK, which should be made an APF-authorized library in your MVS linklist.

For more information, see [Installing CICS-required modules in the MVS linklist](#).

The routines are as follows:

DFHSNNFY

CICS segment update notification

DFHSNPTO

CICS segment TIMEOUT print formatting

DFHSNVCL

CICS segment OPCLASS keyword validation

DFHSNVID

CICS segment OPIDENT keyword validation

DFHSNVPR

CICS segment OPPRTY keyword validation

DFHSNVTO

CICS segment TIMEOUT keyword validation

Using RACF support in a multi-MVS environment

If you are operating a multi-MVS environment with shared DASD, you are likely to want the active and alternate CICS systems to have access to the same terminal user characteristics.

You can enable this by having the active and alternate CICS systems share the same RACF database.

Setting options on the MVS program properties table

If you have an entry for the DFHSIP program in your MVS program properties table (PPT), ensure that the NOPASS option is not set for DFHSIP in the PPT statement of the SCHEDxx member of the SYS1.PARMLIB library. Setting the NOPASS option would bypass password and RACF authorization checking on data sets accessed by the CICS region.

For more information about specifying CICS MVS PPT options, see [Installing CICS-required modules in the MVS linklist](#).

Protecting CICS load libraries

Although, in general, CICS runs in unauthorized state, the CICS initialization program, DFHSIP, must run in authorized state for part of its execution. For this reason, the version of the DFHSIP module supplied on the distribution tape is link-edited with the “authorized” attribute (using the linkage-editor SETCODE AC(1) control statement), and is installed in CICSTS54.CICS.SDFHAUTH. This library must be defined to the operating system as APF-authorized.

To prevent unauthorized or accidental modification of CICSTS54.CICS.SDFHAUTH, make this library RACF-protected. Without such protection, the integrity and security of your MVS system are at risk. To control the unauthorized startup of a CICS system using DFHSIP, also consider implementing the following:

- If DFHSIP is in a library that has been placed in the MVS link list, protect DFHSIP with a profile in the PROGRAM resource class. Give READ access to this profile only to those users who are allowed to execute CICS.
- If DFHSIP has been placed in the link pack area (LPA), it cannot be protected by the PROGRAM resource class. Instead, control the startup of CICS by controlling the loading of any suffixed DFHSIT load module. Ensure that no DFHSIT load module is included in the LPA, then control the loading of DFHSIT by creating a generic 'DFHSIT*' profile in the PROGRAM resource class. Give READ access to this profile only to those users who are allowed to execute CICS.

Also give RACF protection to SYS1.CICSTS54.CICS.SDFHLINK and to SYS1.CICSTS54.CICS.SDFHLPA; and the other libraries (including CICSTS54.CICS.SDFHLOAD) that make up the STEPLIB and DFHRPL library concatenations.

See “[Authorizing access to CICS data sets](#)” on page 36 for more information about protecting CICS data sets and creating suitable data set security profiles.

Note: The source statements of your application programs are sensitive; consider having RACF protect the data sets containing them.

Specifying the CICS region userid

When you start a CICS region (either as a job or as a started task) in an MVS environment that has RACF installed, the job or task is associated with a userid, referred to as the **CICS region userid**.

The authority associated with this userid determines which RACF-protected resources the CICS region can access.

Each CICS region, for either production or test use, should be subject to normal RACF data set protection based on the region userid under which the CICS region executes. You specify the region userid under which CICS executes in one of three ways:

As a started task:

- In the RACF started procedures table, ICHRIN03, when you start CICS as a started task using the MVS START command. (See “[Authorizing CICS procedures to run under RACF](#)” on page 31.) However, do not assign the “trusted” or “privileged” attributes to CICS entries in the started procedures table. For more information, see the description of associating MVS started procedures with userids in the [z/OS Security Server RACF System Programmer's Guide](#).

As a started job:

- In a STARTED general resource class profile, on the user parameter of the STDATA segment.

As a job:

- On the USER parameter of the JOB statement when you start CICS as a JOB.

To ensure the authorizations for different CICS regions are properly differentiated, run each with a unique region userid. For example, the userid under which you run the production CICS regions to process payroll and personnel applications should be the only CICS userid authorized to access production payroll and personnel data sets.

If you are using intercommunication, it is particularly important to use unique userids, unless you want to bypass link security checking. For more information, see [“Link security with LU6.2” on page 226](#), [“Link security with LU6.1” on page 238](#), or [“Link security with MRO” on page 268](#), depending on the environment you are using.

Using protected user IDs

If you run CICS as a started task, consider defining the CICS region user ID and the CICS default user ID as protected user IDs.

Protected user IDs cannot be used to enter the system by any means that requires a password, such as logging on to TSO, signing on to CICS, or running a batch job that specifies a password on the JOB card. Users cannot, by inadvertently or deliberately entering an incorrect password, cause a protected user ID to be revoked.

To create a protected user ID, specify the NOPASSWORD, NOPHRASE and NOIDCARD attributes on the user profile. For more information about protected user IDs, see [z/OS Security Server RACF Security Administrator's Guide](#).

Authorizing CICS procedures to run under RACF

You can invoke your CICS startup procedure to start CICS as a started task or as a started job. RACF provides the ICHRIN03 procedure table for started tasks, and the STARTED general resource class for started jobs. Both options are discussed here:

Using the ICHRIN03 table for started tasks

If you run CICS as a started task, you should associate the cataloged procedure name with a suitably authorized RACF user through the RACF table, ICHRIN03.

RACF supplies a default ICHRIN03 table, which you can modify. See the [z/OS Security Server RACF System Programmer's Guide](#) for more information about this table, and how you can add the default entry for the cataloged procedure name for starting CICS.

If your ICHRIN03 table contains the default entry, you need not update the table; but define a RACF user with the same name as the cataloged procedure.

If your ICHRIN03 table does not contain the default entry (or you choose not to set the default entry), update the table with an entry that contains the cataloged procedure name and its associated RACF user. This RACF user need not have the same name as the cataloged procedure.

Whether your ICHRIN03 table contains the default entry or a specific entry you have defined, ensure that the RACF user identified through ICHRIN03 has the necessary access authority to the data sets in the cataloged procedure.

For example, if you associate a cataloged procedure called DFHCICS with the RACF userid CICSR, the userid CICSR needs to have access to the CICS resources accessed by the task started by DFHCICS.

Using STARTED profiles for started jobs

If you start your CICS regions as started jobs, you can use separate userids for each started region, even though they are all started from the same procedure. Alternatively, you can use generic profiles for groups of CICS regions that are to share the same userid—for example, for all regions of the same type, such as terminal-owning regions.

The support for started jobs is provided by the RACF STARTED general resource class, and its associated STDATA segment. You define profiles in this class for each job, or group of jobs, that needs to run under a unique userid.

Ensure that the userids specified in STDATA segments are defined to RACF. Also ensure that the userids are properly authorized to the data set profiles of the CICS regions that run under them.

Example of a generic profile for multiple AORs

The following example shows how to define a generic profile for jobs that are to be started using a procedure called CICSTASK.

In this example the job names begin with the letters CICSDA for a group of CICS application-owning regions (AORs):

```
RDEFINE STARTED (CICSTASK.CICSDA*) STDATA( USER(CICSDA##) )
```

When you issue the START command to start CICSTASK with a job name of, say, CICSDAA1, MVS passes the procedure name (CICSTASK), and the job name (CICSDAA1) in order to obtain the userid under which this CICS application-owning region is to run. In this example the CICS region userid is defined as CICSDA##, for all regions started under the generic profile CICSTASK.CICSDA*.

Example of a unique profile for each region

The following example shows how to define a unique profile for jobs that are to be started using a procedure called CICSTASK, and where each started job is to run under a unique CICS region userid:

```
RDEFINE STARTED (CICSTASK.CICSDAA2) STDATA( USER(CICSDAA2) )
```

When you issue the START command to start CICSTASK with the job name CICSDAA2, MVS passes the procedure name (CICSTASK) and the job name (CICSDAA2) to obtain the userid under which this CICS application-owning region is to run. In this example the CICS region userid is defined as CICSDAA2, the same as the APPLID.

Defining user profiles for CICS region user IDs

Before bringing up a CICS region, ensure that the required user IDs are defined - the CICS region user ID and the CICS default user ID.

If you are suitably authorized, you can define a RACF user profile for a CICS region by using the **ADDUSER** command. For example, to define CICS as a user ID for a CICS region, enter the following RACF command from TSO:

```
ADDUSER CICS NAME(user-name) DFLTGRP(cics_region_group)
```

Do not assign the OPERATIONS attribute to CICS region user IDs. Doing so would allow the CICS region to access RACF-protected data sets for which no specific authorization has been performed. CICS region user IDs do not need the **OPERATIONS** attribute if the appropriate **CONNECT** or **PERMIT** commands have been issued. These commands authorize the CICS region user ID for each CICS region to access only the specific data sets required by that region.

Coding the USER parameter on the CICS JOB statement

If you start CICS from a job, include the parameters USER= and PASSWORD= on the JOB statement.

For example:

```
//CICSA JOB ... ,USER=CICS,PASSWORD=password
```

When you define a new user to RACF, the password is automatically flagged as expired. For this reason, the first time you start CICS under a new userid, change the PASSWORD parameter on the JOB statement. For example:

```
PASSWORD=(oldpassword,newpassword)
```

If you want to avoid specifying the password on the JOB statement, you can allow a surrogate user to submit the CICS job. A surrogate user is a RACF-defined user who is authorized to submit jobs on behalf of another user (the original user), without having to specify the original user's password. Jobs submitted by a surrogate user execute with the identity of the original user. See [“Surrogate job submission in a CICS](#)

environment” on page 45 for more information. The region userid must also have surrogate authority to use the default user; see [“Surrogate user security” on page 113](#).

Authorities required for CICS region user IDs

The CICS control program runs under the CICS region user ID.

Therefore, this user ID needs access to all the resources that CICS itself must use. There are two types of these resources:

1. Resources external to CICS, such as data sets, the spool system, and the SNA network.
2. Resources internal to CICS, such as system transactions and auxiliary user IDs.

Authorizing external resources

Like a batch job, each CICS region must be able to access many external resources.

The authority for CICS to access these resources is obtained from the CICS region userid. It doesn't matter which signed-on user requests CICS to perform the actions that access these resources. The external services are aware only that CICS is requesting them, under the region userid's authority.

Give access to these resources:

- The MVS system logger

CICS needs authority to use log streams defined in the MVS logger. See [“Authorizing access to MVS log streams” on page 35](#).

- External data sets used by CICS

CICS needs authority to open all the data sets that it uses. See [“Authorizing access to CICS data sets” on page 36](#).

- External data sets used by application programs

CICS needs authority to open all the data sets that your own application programs need. See [“Authorizing access to user data sets” on page 39](#).

- Temporary storage servers

CICS needs authority to access temporary storage servers if any TS queues are defined as shared. See [“Authorizing access to temporary storage servers” on page 40](#).

- SMSVSAM servers

CICS needs authority to access the SMSVSAM server if you are using VSAM record-level sharing (RLS). See [“Authorizing access to SMSVSAM servers” on page 42](#).

- z/OS Communications Server (for SNA or IP) applications

Consider carefully for each program whether you will allow it to become a z/OS Communications Server application. If you do this, CICS needs authority to open its z/OS Communications Server ACB. See [“Controlling the opening of a CICS region's z/OS Communications Server ACB” on page 44](#).

- Jobs submitted to the internal reader

If any of your applications submit JCL to the JES internal reader, you should prevent CICS from allowing them to be submitted without the USERID parameter. See [“Controlling userid propagation” on page 44](#).

However, you should not usually require your applications to provide a PASSWORD parameter on submitted jobs. So you **should** allow CICS to be a surrogate user of all the possible userids that may be submitted. See [“Surrogate job submission in a CICS environment” on page 45](#).

- System spool data sets

CICS needs authority to access data sets in the JES spool system. See [“JES spool protection in a CICS environment” on page 46](#).

Authorizing internal resources

There are several internal functions in which CICS behaves like an application program, but is performing housekeeping functions that are not directly for any user. The associated transactions execute under control of the CICS region userid, and because they access CICS internal resources, you must give the CICS region userid authority to access them.

These are:

- CICS system transactions

CICS needs authority to attach all the internal housekeeping transactions that it uses. See [“Category 1 transactions” on page 141](#).

- Auxiliary user ids

If CICS surrogate user checking is specified with the **XUSER** system initialization parameter (the default), CICS needs authority to use certain additional user ids. These are:

- The default userid

See [“CICS default user” on page 114](#).

- The userid used for post-initialization processing (PLTPIUSR)

See [“Post-initialization processing” on page 114](#).

- The userid used for transient data trigger transactions

See [“Transient data trigger-level transactions” on page 115](#).

- Resources used by PLTPI programs

If the **PLTPIUSR** system initialization parameter is omitted, the CICS region userid is used for all PLTPI programs. In this case, give the CICS region userid access to all the CICS resources that these programs use. See [“PLT programs” on page 70](#).

Defining the default CICS user ID to RACF

For each CICS region where you specify **SEC=YES**, define a RACF user profile whose user ID matches the value of the **DFLTUSER** system initialization parameter.

You can use the same default user ID on all CICS regions. You can specify this default user ID on the **DFLTUSER** system initialization parameter, or leave **DFLTUSER** set to the default of CICSUSER.

Define a different default CICS user ID for each CICS region if any of the following considerations applies:

- The default CICS user ID requires different security attributes (such as membership in RACF groups).
- The default CICS user ID requires different operator data (CICS segment of the RACF user profile).
- The default CICS user ID requires a different default language (LANGUAGE segment of the RACF user profile).

Step 1. Define the CICS default user to RACF

Use the **ADDUSER** command with the CICS operand to define a CICS default user to RACF.

Usually, the default CICS user ID should be defined as a protected user ID. This is particularly the case if the CICS region is a started task. Protected user IDs cannot be used to enter the system by any means that requires a password, and users cannot cause a protected user ID to be revoked. For more information, see [“Using protected user IDs” on page 31](#).

Example:

The following command defines CICS default user CICSUSER as a protected user ID to RACF:

```
ADDUSER CICSUSER DFLTGRP(group_id) NAME(user_name)
        OWNER(userid or group)
        NOIDCARD
        NOPASSWORD
```

Step 2. Authorize the CICS region user ID to be a surrogate user of the default user ID

If you have specified the system initialization parameter **XUSER=YES** (the default), authorize the CICS region user ID to be a surrogate user of the default user ID. For example, the following command authorizes a CICS region user ID to be a surrogate user of CICSUSER:

```
PERMIT CICSUSER.DFHINSTL CLASS(SURROGAT) ID(cics_region_userid)
```

Sign-on processing of the CICS default user

During startup, CICS signs on the default user ID. If the default user sign-on fails (because, for example, the user ID is not defined to RACF), CICS issues message DFHXS1104 and terminates CICS initialization.

When CICS successfully signs on a valid RACF user ID as the default user, it establishes the terminal user data for the default user from one of the following sources:

- The CICS segment of the default user's RACF user profile
- Built-in CICS system default values

See [“Obtaining CICS-related data for a user” on page 63](#) for details of the sign-on process for obtaining CICS terminal operator data.

How CICS assigns the security attributes of the default user

CICS assigns the security attributes of the default user ID to all CICS terminals before any terminal user begins to sign on. The security attributes and terminal user data of the default user also apply to any terminals at which users do not sign on (using either the CICS-supplied CESN transaction or a user-written equivalent), unless the security has been explicitly preset by specifying a value for the USERID option in the terminal definition.

Note: If the default user's RACF profile specifies a non-zero TIMEOUT, that value does **not** apply to terminals that do not sign on.

CICS also assigns the security attributes of the default user ID to any “trigger level transactions” that are initiated for transient data queues without a **USERID** parameter.

Ensure the default user ID gives at least the minimum authorities that ought to be granted to any other terminal user. In particular:

- Give the default user access to the region's APPLID. See [“Authorizing access to the CICS region” on page 43](#).
- Give the default user access to the CICS-supplied transactions that are intended to be used by everybody. See the definitions in [“Identifying CICS terminal users” on page 52](#), especially those transactions that are recommended for inclusion in the ALLUSER example group of transactions.

Authorizing access to MVS log streams

Ensure that you authorize the CICS region userid to write to (and create if necessary) the log streams that are used for its system log and general logs.

You do this by granting the appropriate access authorization to log stream profiles in the LOGSTRM general resource class.

The level of authorization required depends on whether log streams are always explicitly defined to the MVS system logger:

- If CICS is expected to create log streams dynamically, give CICS ALTER authority to the relevant log stream profiles, and UPDATE authority to the relevant coupling facility structures.

- If all the log streams to which CICS writes are already defined to MVS, give CICS only UPDATE authority to the log stream profiles.
- Permit READ access to those users who need to read the CICS log streams.

For example, the generic profile in the following example could be defined to cover all the log streams referenced by the CICS region and identified by its region userid and applid:

```
RDEFINE LOGSTRM region_userid.** UACC(NONE)
```

If, however, you have multiple CICS systems sharing the same region userid, but with differing security requirements, include the applid in the generic profile, as follows:

```
RDEFINE LOGSTRM region_userid.applid.* UACC(NONE)
```

The following example allows the CICS region userid under which CICS is running to write journal and log records to log streams in the named coupling facility structure:

```
PERMIT IXLSTR.structurename CLASS(FACILITY) ACCESS(UPDATE)
ID(region_userid)
```

The following examples give access to three categories of user:

```
PERMIT region_userid.applid.* CLASS(LOGSTRM) ACCESS(ALTER)
ID(region_userid)
PERMIT region_userid.applid.* CLASS(LOGSTRM) ACCESS(READ)
ID(authorized_browsers)
PERMIT region_userid.applid.* CLASS(LOGSTRM) ACCESS(UPDATE)
ID(archive_userid)
```

In these examples, `region_userid` is the CICS region userid under which CICS is running, either as a started task or batch job. The identifier `archive_userid` is the userid under which an application program runs to purge old data from CICS logs when the data is no longer needed. The identifier `authorized_browsers` refers to the userids of users allowed to read log streams, but not purge data.

If several CICS regions share the same CICS region userid, you can make profiles more generic by specifying `*` for the *applid* qualifier.

The number of profiles you define depends on the naming conventions of the logs, and to what extent you can use generic profiling.

Authorizing access to CICS data sets

When you have defined a region userid for your CICS job (or started task), permit that user id to access the CICS system data sets with the necessary authorization.

When authorizing access to CICS system data sets, choose appropriately from the following levels of access: READ, UPDATE, and CONTROL. Also define data set profiles with UACC(NONE) to ensure that only CICS region user ids can access those data sets. For information about the CICS region user id, see [“Specifying the CICS region userid” on page 30](#).

For CICS load libraries, only permit READ access.

The following four data sets require CONTROL access.

- The temporary storage data set
- The transient data intrapartition data set
- The CAVM control data set (XRF)
- The CAVM message data set (XRF)

Permit UPDATE access for all the remaining CICS data sets.

Therefore, for CICS system data sets you need at least three generic profiles to restrict access to the appropriate level. See [Table 3 on page 37](#).

<i>Table 3. Summary of generic data set profiles</i>	
Required access level	Type of CICS data sets protected
READ	Load libraries
UPDATE	Auxiliary trace; transaction dump; system definition; global catalog; local catalog; and restart
CONTROL	Temporary storage; intrapartition transient data; XRF message; and XRF control

If you use generic naming of the data set profiles, you can considerably reduce the number of profiles you need for your CICS regions. This policy is illustrated in the examples shown in [Figure 1 on page 37](#) for a number of sample CICS regions.

You can issue the RACF commands shown in the examples from a TSO session, or execute the commands using the TSO terminal monitor program, IKJEFT01, in a batch job as illustrated in [Figure 1 on page 37](#). Alternatively, you can use the RACF-supplied ISPF panels. Any of these methods enables you to create the necessary profiles and authorize each CICS region userid to access the data sets as appropriate for the corresponding CICS region.

```
//RACFDEF JOB 'accounting information',
//          CLASS=A,MSGCLASS=A,MSGLLEVEL=(1,1)
//DEFINE EXEC PGM=IKJEFT01
//SYSPRINT DD SYSOUT=A
//SYSTSPRT DD SYSOUT=A
//SYSUDUMP DD SYSOUT=A
//SYSTSIN DD *
ADDSD 'CICSTS54.CICS.SDFHLOAD' NOTIFY(cics_sys_admin_id) UACC(NONE)
PERMIT 'CICSTS54.CICS.SDFHLOAD' ID(cics_id1,...,cics_group1,..,cics_groupn)
ACCESS(READ)
ADDSD 'CICSTS54.CICS.SDFHAUTH' NOTIFY(cics_sys_admin_id) UACC(NONE)
PERMIT 'CICSTS54.CICS.SDFHAUTH' ID(cics_id1,...,cics_group1,..,cics_groupn)
ACCESS(READ)
ADDSD 'CICSTS54.CICS.applid.**' NOTIFY(cics_sys_admin_id) UACC(NONE)
PERMIT 'CICSTS54.CICS.applid.**' ID(applid_userid) ACCESS(UPDATE)
ADDSD 'CICSTS54.CICS.applid.DFHXR*' NOTIFY(cics_sys_admin_id) UACC(NONE)
PERMIT 'CICSTS54.CICS.applid.DFHXR*' ID(applid_userid) ACCESS(CONTROL)
ADDSD 'CICSTS54.CICS.applid.DFHINTRA' NOTIFY(cics_sys_admin_id) UACC(NONE)
PERMIT 'CICSTS54.CICS.applid.DFHINTRA' ID(applid_userid) ACCESS(CONTROL)
ADDSD 'CICSTS54.CICS.applid.DFHTEMP' NOTIFY(cics_sys_admin_id) UACC(NONE)
PERMIT 'CICSTS54.CICS.applid.DFHTEMP' ID(applid_userid) ACCESS(CONTROL)
ADDSD 'CICSTS54.CICS.DFHCSO' NOTIFY(cics_sys_admin_id) UACC(NONE)
PERMIT 'CICSTS54.CICS.DFHCSO' ID(cics_group1,..,cics_groupn) ACCESS(UPDATE)
/*
//
```

Figure 1. Example of a job to authorize access to CICS data sets

Note: Data sets that need to be accessed in the same way by all CICS regions (for example, with READ or UPDATE access) should be protected by profiles that do **not** include an APPLID. For example, define the partitioned data sets that contain the CICS load modules with profiles that give all CICS region groups (or userids) READ access.

You could also consider protecting all these data sets with one generic profile called 'CICSTS54.CICS.**'. However, you must strictly control who has read access to CICSTS54.CICS.SDFHAUTH, because it contains APF-authorized programs, and the profile protecting this data set **must** be defined with UACC(NONE). In [Figure 1 on page 37](#) all of the partitioned data sets are defined with UACC(NONE) and have an explicit access list.

Although CICS modules exist in libraries SYS1.CICSTS54.CICS.SDFHLP and SYS1.CICSTS54.CICS.SDFHLINK, no CICS region userid requires access to these libraries.

By establishing a naming convention for the data sets belonging to each region, and one generic profile for each CICS region, with the CICS z/OS Communications Server APPLID as one of the data set qualifiers, you can ensure that only one CICS region has access to the data sets. In the examples shown in [Figure 1](#)

on page 37, all the names have a high-level qualifier of CICS54.CICS, but your installation will have its own naming conventions for you to follow.

CICS needs UPDATE access to all the data sets covered by these profiles. The CICS DDNAMEs for the data sets in this category are as follows:

DFHGCD

Global catalog data set

DFHLCD

Local catalog data set

DFHAUXT

Auxiliary trace data set, A extent

DFHBUXT

Auxiliary trace data set, B extent

DFHDMPA

Transaction dump data set, A extent

DFHDMPB

Transaction dump data set, B extent

Note: The auxiliary trace data set, the transaction dump data set, and the MVS dump data set may contain sensitive information. Protect them from unauthorized access.

CICS needs CONTROL access for the transient data intrapartition, temporary storage, and CICS availability manager (CAVM) data sets.

The CICS DDNAMEs for the data sets in this category are as follows:

DFHINTRA

Transient data intrapartition data set

DFHTEMP

Temporary storage data set

DFHXMSG

XRF message data set

The CICS system definition data set (CSD) is protected by a discrete profile to which all CICS groups have access. This assumes that all the CICS regions are sharing a common CSD. If your CICS regions do not share a common CSD and each region has its own CSD, or if groups of regions share a CSD, define discrete or generic data set profiles as appropriate.

You must grant the CICS region user ID read access to the VSAM catalog for the DFHCSD file for the CICS system definition data set (CSD).

Authorizing access with the MVS library lookaside (LLA) facility

If you are using the library lookaside (LLA) facility of MVS, you can control a program's ability to use the LLACOPY macro.

Authorize the CICS region's userid in *one* of the following ways:

- It must have UPDATE authority to the data set that contains the LLA module.
- It must have UPDATE authority in the FACILITY class to the resource CSVLLA. *datasetname*, where *datasetname* is the name of the library that contains the LLA module. For example:

```
RDEFINE FACILITY CSVLLA.datasetname UACC(NONE) NOTIFY
PERMIT CSVLLA.datasetname CLASS(FACILITY) ID(....) ACCESS(UPDATE)
```

Authorizing access to user data sets

When you have defined the RACF user ids for your CICS regions and given them access to the CICS system data sets, permit the user IDs to access the CICS **application** data sets with the necessary authority.

You must grant the CICS region user ID read access to each VSAM catalog for files for which CICS has file definitions installed and are to be either opened during CICS startup or at any time after.

The following RACF commands permit the userid specified on the ID parameter to access some CICS user application data sets, with READ authority for the first two data sets, and UPDATE authority for the last two:

```
PERMIT 'CICSTS54.CICS.appl1.dataset1' ID(user or group) ACCESS(READ)
PERMIT 'CICSTS54.CICS.appl1.dataset2' ID(user or group) ACCESS(READ)
PERMIT 'CICSTS54.CICS.appl2.dataset3' ID(user or group) ACCESS(UPDATE)
PERMIT 'CICSTS54.CICS.appl2.dataset4' ID(user or group) ACCESS(UPDATE)
```

ACCESS(CONTROL) for VSAM entry-sequenced data sets (ESDS)

CICS file control uses control interval processing when opening a VSAM ESDS (non-RLS mode only). This means that you must specify ACCESS(CONTROL) for all such data sets, otherwise the OPEN command fails with message DFHFC0966.

ACCESS(ALTER) for VSAM data sets when using BWO

In order to use backup while open (BWO) to back up VSAM data sets that are currently in use and are defined as BACKUPTYPE(DYNAMIC), or BWO(TYPECICS) in the integrated catalog facility (ICF) catalog, give the CICS region userid RACF ALTER authority to the data set or to the ICF catalog in which that data set is defined. If you do not, the OPEN command fails with message DFHFC5803. For guidance on using BWO, see [Back-up-while-open \(BWO\)](#).

ACCESS(ALTER) for VSAM data sets when specifying SMS Data Class attribute Dynamic Volume Count

Dynamic Volume Count

You can use SMS Data Class attribute Dynamic Volume Count to extend your VSAM data to multiple volumes. Depending on your SMS release level, ACCESS(ALTER) may be required by the CICS region userid to update the ICF catalog volume list during EOVS extend processing. To determine the correct access level for your DFSMS release, see [Required RACF Authorization Tables in z/OS DFSMS Access Method Services Commands](#).

Authorizing access to the temporary storage pools

You can control access by temporary storage (TS) servers to the TS pools in the coupling facility.

Each TS server can be started as a job or started task. The name of the TS queue pool for a TS server is specified at server startup. For each TS pool there can be only one TS server running on each MVS image in the sysplex.

Two security checks are made against the TS server's userid—that is, the userid under which the job or started task is running. To ensure the server passes these checks, do the following:

- Authorize the TS server region to connect to the coupling facility list structure used for its own TS pool. This requires that the TS server userid has ALTER authority to a coupling facility resource management (CFRM) RACF profile called IXLSTR.*structure_name* in the FACILITY general resource class.

For example, if the userid of the server is DFHXQTS1, and the list structure is called DFHXQLS_TSPRODQS, the following RACF commands define the profile and provide the required access:

```
RDEFINE FACILITY IXLSTR.DFHXQLS_TSPRODQS UACC(NONE)
PERMIT IXLSTR.DFHXQLS_TSPRODQS CLASS(FACILITY) ID(DFHXQTS1) ACCESS(ALTER)
```

To reduce security administration, use the same TS server userid to start each TS server that supports the same TS pool.

- Give the TS server's userid CONTROL access to the CICS RACF profile called DFHXQ.*poolname* in the FACILITY general resource class. This authorizes the TS server to act as a server for the named TS pool.

For example, if the userid of the server is DFHXQTS1, and the pool name is TSPRODQS, the following RACF commands define the profile and provide the required access:

```
RDEFINE FACILITY DFHXQ.TSPRODQS UACC(NONE)
PERMIT DFHXQ.TSPRODQS CLASS(FACILITY) ID(DFHXQTS1) ACCESS(CONTROL)
```

See [“System authorization facility \(SAF\) responses to the TS server”](#) on page 40 for information about the responses to the TS server.

Authorizing access to temporary storage servers

You can control access by CICS regions to the TS servers.

A security check is made against the CICS region userid to verify that the region is authorized to use the services of a TS server. This check is made each time that a CICS region connects to a TS server.

Give each CICS region that connects to a TS server userid UPDATE access to the CICS RACF profile called DFHXQ.*poolname* in the FACILITY general resource class. This authorizes the CICS region to use the services of the TS server for the named TS pool.

For example, if the userid of a CICS region is CICSDA1, and the pool name is TSPRODQS, the following RACF commands define the profile and provide the required access:

```
RDEFINE FACILITY DFHXQ.TSPRODQS UACC(NONE)
PERMIT DFHXQ.TSPRODQS CLASS(FACILITY) ID(CICSDA1) ACCESS(UPDATE)
```

When a CICS region has connected to a TS pool, it can write, read, and delete TS queues without any further security checks being performed by the server. However, the CICS application-owning regions issuing TS API requests can use the existing mechanisms for TS resource security checking

System authorization facility (SAF) responses to the TS server

If the security profile for a TS pool cannot be retrieved, SAF neither grants nor refuses the access request. In this situation:

Access to the TS pool, either by a CICS region or by the TS server itself, is rejected if:

- A security manager is installed, but is either temporarily inactive or inoperative for the duration of the MVS image. This is a fail-safe action, on the grounds that, if the security manager is active, it might retrieve a profile that does not permit access to the TS pool.

Access to the TS pool, either by a CICS region or by the TS server itself, is accepted if:

- There is no security manager installed, or
- There is an active security manager, but the FACILITY class is inactive, or there is no profile in the FACILITY class. The access request is allowed in this case because there is no evidence that you want to control access to the TS server.

Access is permitted to any TS server without a specific DFHXQ.*poolname* profile, or an applicable generic profile. No messages are issued to indicate this. To avoid any potential security exposures, you can use generic profiles to protect all, or specific groups of, TS servers. For example, specifying:

```
RDEFINE FACILITY (DFHXQ.*) UACC(NONE)
```

ensures that access is allowed only to TS servers with a more specific profile to which a TS server or CICS region is authorized.

Authorizing access to named counter pools and servers

You can control access by:

- Coupling facility data table (named counter) servers to named counter pools (see [“Access to named counter pools”](#) on page 41)
- CICS regions to the named counter servers (see [“Access to named counter servers”](#) on page 41).

Access to named counter pools

You can control access by named counter servers to the named counter pools in the coupling facility.

Each named counter server can be started as a job or started task. The name of the named counter pool for a named counter server is specified at server startup. For each named counter pool there can be only one server running on each MVS image in the sysplex.

Two security checks are made against the named counter server's userid—that is, the userid under which the job or started task is running. To ensure the server passes these checks, do the following:

- Authorize the named counter server region to connect to the coupling facility list structure used for its own named counter pool. This requires that the named counter server userid has ALTER authority to a coupling facility resource management (CFRM) RACF profile called IXLSTR.*structure_name* in the FACILITY general resource class.

For example, if the user ID of the server is DFHNCSV1, and the list structure is called DFHNCLS_DFHN001, the following RACF commands define the profile and provide the required access:

```
RDEFINE FACILITY IXLSTR.DFHNC001 UACC(NONE)
PERMIT IXLSTR.DFHNC001 CLASS(FACILITY) ID(DFHNCSV1) ACCESS(ALTER)
```

To reduce security administration, use the same named counter server userid to start each named counter server that supports the same named counter pool.

- Give the named counter server's userid CONTROL access to the CICS RACF profile called DFHNC.*poolname* in the FACILITY general resource class. This authorizes the named counter server to act as a server for the named counter pool.

For example, if the user ID of the server is DFHNCSV1 and the pool name is DFHN001, the following RACF commands define the profile and provide the required access:

```
RDEFINE FACILITY DFHNC.DFHNC001 UACC(NONE)
PERMIT DFHNC.DFHNC001 CLASS(FACILITY) ID(DFHNCSV1) ACCESS(CONTROL)
```

See [“System authorization facility \(SAF\) responses to the named counter server”](#) on page 42 for information about the responses to the CFDT server.

Access to named counter servers

You can control access to the named counter servers by CICS regions.

Each time that a CICS region connects to a named counter server, a security check is made against the CICS region userid to verify that the region is authorized to use the services of that named counter server.

Give each CICS region userid that connects to a named counter server UPDATE access to the CICS RACF profile called DFHNC.*poolname* in the FACILITY general resource class. This authorizes the CICS region to use the services of the named counter server for the named counter pool.

For example, if the userid of a CICS region is CICS DAA1, and the pool name is DFHNC001, the following RACF commands define the profile and provide the required access:

```
RDEFINE FACILITY DFHNC.DFHNC001 UACC(NONE)
PERMIT DFHNC.DFHNC001 CLASS(FACILITY) ID(CICS DAA1) ACCESS(UPDATE)
```

When a CICS region has connected to a named counter pool, it can define, update, delete, get, rewind, and query named counters without any further security checks being performed by the server.

Note: Unlike shared temporary storage pools and coupling facility data table pools, named counters can also be accessed by batch application regions. Batch jobs are subject to the same security mechanisms as a CICS region.

System authorization facility (SAF) responses to the named counter server

If the security profile for a named counter pool cannot be retrieved, SAF neither grants nor refuses the access request. In this situation:

Access to the named counter pool, either by a CICS region or by the named counter server itself, is rejected if:

- A security manager is installed, but is either temporarily inactive or inoperative for the duration of the MVS image. This is a fail-safe action, on the grounds that, if the security manager is active, it might retrieve a profile that does not permit access to the named counter pool.

Access to the named counter pool, either by a CICS region or by the named counter server itself, is accepted if:

- There is no security manager installed, or
- There is an active security manager, but the FACILITY class is inactive, or there is no profile in the FACILITY class. The access request is allowed in this case because there is no evidence that you want to control access to the named counter server.

Access is permitted to any named counter server without a specific DFHCF.*poolname* profile, or an applicable generic profile. No messages are issued to indicate this. To avoid any potential security exposures, you can use generic profiles to protect all, or specific groups of, named counter servers. For example, specifying:

```
RDEFINE FACILITY (DFHNC.*) UACC(NONE)
```

ensures that access is allowed only to named counter servers with a more specific profile to which a named counter server or CICS region is authorized.

Authorizing access to SMSVSAM servers

SMSVSAM is a data-sharing subsystem running on its own address space to provide the RLS support required by CICS. For CICS regions using VSAM record-level sharing (RLS), access to SMSVSAM servers is controlled by RACF security checks made against the CICS region userid to verify that the region is authorized to register with an SMSVSAM server.

In a test environment you might want to use the default action and allow any CICS region using VSAM RLS to connect to an SMSVSAM server. If you want to protect this access, the RACF SUBSYSNM general resource class must be active and you must authorize each CICS region that connects to an SMSVSAM server to have access to that server. This means granting access to the appropriate profile in the RACF SUBSYSNM general resource class.

The general resource class, SUBSYSNM, supports authorizations for subsystems that want to connect to SMSVSAM. The SUBSYSNM profile name is the name by which a given subsystem is known to VSAM. CICS

uses its applid as its subsystem name; define a profile for the CICS applid in the SUBSYSNM resource to enable CICS to register the control ACB.

When CICS attempts to register the control ACB during initialization, SMSVSAM calls RACF to check that the CICS region userid is authorized to the CICS profile in the SUBSYSNM class. If the CICS region userid does not have READ authority, the open request fails.

For example, if the applid of a CICS AOR is CICSDAA1, and the CICS region userid (shared by a number of AORs) is CICSDA##, define and authorize the profile as follows:

```
RDEFINE SUBSYSNM CICSDAA1 UACC(NONE) NOTIFY(userid)
PERMIT CICSDAA1 CLASS(SUBSYSNM) ID(CICSDA##) ACCESS(READ)
```

You can use wildcard characters on the applid to specify more than one CICS region, for example:

```
PERMIT CICSDA%% CLASS(SUBSYSNM) ID(CICSDBGP) ACCESS(READ)
```

Authorizing access to the CICS region

You can restrict access by terminal users to specific CICS regions by defining CICS APPLID profiles in the RACF APPL class.

For this purpose, the APPLID of a CICS region is:

- The z/OS Communications Server generic resources name if GRNAME is specified as a system initialization parameter
- The generic APPLID if one is specified on the APPLID system initialization parameter
- The specific APPLID if only one is specified on the system initialization parameter

If you define a profile in the APPL class for a CICS APPLID, or a generic profile that applies to one or more CICS APPLIDs with UACC(NONE), all terminal users trying to sign on to a CICS region must have explicit access to the profile that applies to that region's APPLID, either as an individual profile, or as a member of a group. For example:

```
RDEFINE APPL cics_region_applid UACC(NONE) NOTIFY(sys_admin_userid)
```

You need to define only one APPL profile name in the RACF database for all the CICS regions that are members of the same z/OS Communications Server generic resources name. All sign-on verifications in a CICSplex, where all the terminal-owning regions have the same z/OS Communications Server generic resources name, are made against the same APPL profile.

For MRO only, the APPLID is propagated from the terminal-owning region (TOR) to the other regions that the user accesses — for example, from the TOR to the application-owning region (AOR), and from the AOR to the file-owning region (FOR). As a consequence:

- You do not need to include users of the AOR and FOR in the APPL profiles for those regions.
- You can force users to sign on through a TOR, by denying access to other APPLIDs

Use the RACF PERMIT command to add authorized users to the access list of CICS APPL profiles. For example:

```
PERMIT cics_region_applid CLASS(APPL) ID(group1,...,groupn) ACCESS(READ)
```

permits all users defined in the listed groups to sign on to `cics_region_applid`.

The APPL class must be active for this protection to be in effect:

```
SETROPTS CLASSACT(APPL)
```

Also, for performance reasons, consider activating profiles in the APPL class using RACLIST.

```
SETROPTS RACLIST(APPL)
```

If the APPL class is already active, refresh the in-storage APPL profiles with the SETROPTS command:

```
SETROPTS RACLIST(APPL) REFRESH
```

Note:

1. CICS always passes the APPLID to RACF when requesting RACF to perform user sign-on checks, and there is no mechanism within CICS to prevent this.
2. RACF treats undefined CICS APPLIDs as UACC(READ).
3. If the APPL class is active, and a profile exists for a CICS region in the APPL class, ensure that authorized remote CICS regions can sign on to a CICS region protected in this way.

See the [z/OS Security Server RACF Security Administrator's Guide](#) for more information about controlling access to applications.

Controlling the opening of a CICS region's z/OS Communications Server ACB

You can control which users among those who are running non-APF-authorized programs can OPEN the z/OS Communications Server SNA ACB associated with a CICS address space (CICS region).

This ensures that only authorized CICS regions can present themselves as z/OS Communications Server applications providing services with this APPLID, thus preventing unauthorized users impersonating real CICS regions. The CICS region user ID needs the OPEN access, not the issuer of the **SET VTAM OPEN** command.

For each APPLID, create a VTAMAPPL profile, and give the CICS region user ID READ access. For example:

```
RDEFINE VTAMAPPL applid UACC(NONE) NOTIFY(userid)  
PERMIT applid CLASS(VTAMAPPL) ID(cics_region_userid) ACCESS(READ)
```

The correct CICS APPLID to specify in the VTAMAPPL class is the specific APPLID, as specified in the CICS system initialization parameters.

The VTAMAPPL class must be activated using RACLIST for this protection to be in effect:

```
SETROPTS CLASSACT(VTAMAPPL) RACLIST(VTAMAPPL)
```

If the VTAMAPPL class is already active, refresh the in-storage VTAMAPPL profiles with the SETROPTS command:

```
SETROPTS RACLIST(VTAMAPPL) REFRESH
```

Note: VTAM is now the z/OS Communications Server (for SNA or IP)

Controlling userid propagation

Jobs submitted from CICS to the JES internal reader without the USER operand being specified on the JOB statement run under the CICS region user ID. These jobs have the access authorities of the CICS region itself, and so could potentially expose other data sets in the MVS system.

You (or the RACF security administrator) can prevent the CICS region user ID from being propagated to these batch jobs by defining a profile in the PROPCNTL class where the profile name is the CICS regions user ID. For example, if the CICS region userID is CICS1, define a PROPCNTL profile named CICS1:

```
RDEFINE PROPCNTL CICS1
```

The PROPCNTL class must be activated using RACLIST for this protection to be in effect:

```
SETROPTS CLASSACT(PROPCNTL) RACLIST(PROPCNTL)
```

If the PROPCNTL class is already active, refresh the in-storage PROPCNTL profiles with the SETROPTS command:

```
SETROPTS RACLIST(PROPCNTL) REFRESH
```

You (or the RACF security administrator) must issue the SETROPTS command to refresh these profiles. Issuing the CICS PERFORM SECURITY REBUILD command does not affect the PROPCNTL class.

Surrogate job submission in a CICS environment

Batch jobs submitted by CICS can be allowed to run with a USER parameter other than the CICS region's userid, but without specifying the corresponding PASSWORD.

This is called surrogate job submission. These jobs have the access authorities of the USER parameter specified on the JOB statement. If the PASSWORD parameter is specified on the JOB statement, surrogate processing does not occur.

You (or the RACF security administrator) can allow this by defining a profile in the SURROGAT class. For example, if the CICS region's userid is CICS1, and the job is to run for userid JOE, define a SURROGAT profile named JOE.SUBMIT:

```
RDEFINE SURROGAT JOE.SUBMIT UACC(NONE)
          NOTIFY(JOE)
```

Further, you must permit the CICS region's userid to act as the surrogate to the profile just defined:

```
PERMIT JOE.SUBMIT CLASS(SURROGAT) ID(CICS1) ACCESS(READ)
```

The SURROGAT class must be activated using RACLIST for this protection to be in effect:

```
SETROPTS CLASSACT(SURROGAT) RACLIST(SURROGAT)
```



Attention:

Any CICS user, whether signed on or not, is able to submit jobs that use the SURROGAT userid, if the CICS userid has authority for SURROGAT. If your installation is using transient data queues to submit jobs, you can control who is allowed to write to the transient data queue that goes to the internal reader. However, if your installation is using EXEC CICS SPOOLOPEN to submit jobs, you cannot control who can submit jobs (without writing an API global user exit program to screen the commands). CICS spool commands do no CICS resource or command checking.

You can use an EXEC CICS ASSIGN USERID command to find the userid of the user who triggered the application code. Application programmers can then provide code that edits a USER operand onto the JOB card destined for the internal reader.

For a complete description of surrogate job submission support, see the [z/OS Security Server RACF Security Administrator's Guide](#).

Authorizing the CICS region userid as a surrogate user

When CICS performs surrogate user checking, the CICS region userid must be authorized as a surrogate.

About this task

Grant authorization for the CICS region userid acting as a surrogate user for the following:

- The CICS default user
- The userid used for post-initialization processing (PLTPIUSR)
- All userids used for transient data trigger level transactions
- All userids specified on the AUTHID or COMAUTHID parameters of a DB2 resource definition.

For more information about surrogate user checking, see [“Surrogate user security”](#) on page 113.

JES spool protection in a CICS environment

Your installation can protect JES spool data sets with profiles in the JESSPOOL class.

Spool files created by the SPOOLOPEN commands have the userid of the CICS region in their security tokens, not the userid of the person who issued the SPOOLOPEN command. Thus, the userid qualifier in the related JESSPOOL profiles is the CICS region's userid.

When using the SPOOLOPEN INPUT command, CICS checks that the first four characters of the APPLID correspond to the external writer name of the spool file. This checking is independent of any RACF checking that may also be done.

Security-related system initialization parameters

Several system initialization parameters are available for specifying system security requirements.

SEC

The SEC system initialization parameter specifies the level of resource security management you want for your CICS region. There are two options:

YES

Initializes the CICS external security interface; control of CICS security is determined by the other security-related system initialization parameters:

CMDSEC	XAPPC	XPPT
DFLTUSER	XCMD	XPSB
ESMEXITS	XDB2	XRES
PSBCHK	XDCT	XRFSOFF
PLTPISEC	XFCT	XRFSTME
RESSEC	XHFS	XTRAN
SECPRFX	XJCT	XTST
SNSCOPE	XPCT	XUSER

NO

No security checking is performed, and no user sign-on is available, for users who want to access CICS resources and other resources in this region.

Note: Even if you have specified SEC=NO, with MRO bind-time security, the CICS region user ID is sent to the secondary system, and bind-time checking is carried out in the secondary system. See [“Bind-time security with MRO”](#) on page 265 for more information.

SECPRFX

This parameter is effective only if you also specify SEC=YES. Use the SECPRFX system initialization parameter to specify whether you want CICS to prefix the resource names that it passes to RACF for authorization. The prefix that CICS uses is the RACF user ID under which the CICS region is running.

Prefixing is useful mainly when you have more than one CICS region. It enables you to prevent users on one CICS region from accessing the resources of a different CICS region that has a different prefix. For example, you might have one CICS region with the prefix CICSPROD and another with prefix CICSTEST. Users of the CICSTEST system would be able to use profiles that included the CICSTEST prefix, and users of the CICSPROD system would be able to use profiles that included the CICSPROD prefix. Users of both systems would be able to use resources protected by profiles that included CICS*.

The SECPRFX parameter has the following options:

NO

CICS does not prefix the resource names in authorization requests that it passes to RACF from this CICS region.

YES

CICS prefixes the resource names with the CICS region user ID when passing authorization requests to RACF.

To change these values, use an ICHRTX00 SAF pre-processing exit. For more information, see [“When and how CICS determines the userid of the CICS region” on page 153.](#)

prefix

CICS prefixes the resource names with the specified prefix when passing authorization requests to RACF.

For example, if a CICS job specifies USER=CICSREG on the JOB statement, and SECPRFX=YES is specified, you can define and allow access to the CICS main terminal transaction (CEMT) in the TCICSTRN resource class as follows:

```
RDEFINE TCICSTRN CICSREG.CEMT
        UACC(NONE) NOTIFY(sys_admin_userid)
PERMIT CICSREG.CEMT CLASS(TCICSTRN)
        ID(groupid1,...,groupidn) ACCESS(READ)
```

You can also use a resource group profile in the GCICSTRN resource class. If you do, specify the prefix on the ADDMEM operand. The following example shows CICSREG specified in a profile named CICSTRANS:

```
RDEFINE GCICSTRN CICSTRANS
        ADDMEM(CICSREG.CEMT)
        UACC(NONE) NOTIFY(sys_admin_userid)
PERMIT CICSTRANS CLASS(GCICSTRN)
        ID(groupid1,...,groupidn) ACCESS(READ)
```

Note: If you protect a resource with a resource group profile, avoid protecting the same resource with another profile. If the profiles are different (for example, if they have different access lists), RACF merges the profiles for use during authorization checking. Not only can the merging have a performance impact, but it can be difficult to determine exactly which access authority applies to a particular user. For more information see the [z/OS Security Server RACF Security Administrator's Guide](#).

CMDSEC

Use CMDSEC to specify whether or not you want CICS to use the CMDSEC option specified on a transaction's resource definition. CMDSEC specified with the option ASIS means that CICS obeys the CMDSEC option. CMDSEC specified with the option ALWAYS means that CICS ignores the CMDSEC option, and always performs the command check. For more information about these options, see [CMDSEC system initialization parameter](#).

DFLTUSER

Specify a value for DFLTUSER to identify to CICS the name you have defined to RACF as the default user ID. If you omit this parameter, the name defaults to CICSUSER. See [“Defining the default CICS user ID to RACF” on page 34.](#)

ESMEXITS

Use ESMEXITS to specify whether you want CICS to pass installation data for use by the RACF installation exits.

PLTPISEC

Use PLTPISEC to specify whether or not you want CICS to perform command security or resource security checking for PLT programs that run during CICS initialization.

PLTPIUSR

Use PLTPIUSR to specify the userid that CICS is to use for security checking for PLT programs that run during CICS initialization.

PSBCHK

Code PSBCHK to specify that you want CICS to perform PSB authorization checks for remote terminal users who use transaction routing to initiate a transaction in this CICS region (to access an attached IMS system). The default PSBCHK=NO specifies that CICS is to check the remote link but not the remote user. The remote user is checked by specifying PSBCHK=YES.

RESSEC

Use RESSEC to specify whether or not you want CICS to honor the RESSEC option specified on a transaction's resource definition. RESSEC specified with the option ASIS means that CICS obeys the RESSEC option. RESSEC specified with the option ALWAYS means that CICS ignores the RESSEC option, and always performs the resource check. For more information about these options, see the *CICS System Definition Guide*.

SNSCOPE

SNSCOPE, the sign-on SCOPE, applies to all user IDs that are signing on by explicit sign-on request; for example, the EXEC CICS SIGNON command or the CESN transaction. Use SNSCOPE to specify whether or not a user ID can have more than one CICS session active at the same time.

The sign-on SCOPE is enforced with the MVS ENQ macro. The SNSCOPE values correspond to the STEP, SYSTEM, and SYSTEMS levels of ENQ scoping. This means that only those CICS systems that specify exactly the same value for SNSCOPE can check the scope of each other.

SNSCOPE affects only users signing on at local terminals, or signing on after using the CRTE transaction to connect to another system.

CICS resource class system initialization parameters

You specify at the system level (with the SEC=YES parameter) that you want CICS to use RACF to authorize access to CICS resources. You also specify at the system level which particular CICS resources you want CICS to check by means of the *Xname* system initialization parameters.

The full list of the CICS resource classes is shown in [Table 4 on page 48](#). Each class is shown with its corresponding *Xname* system initialization parameter.

System initialization parameter	Resource
XAPPC={NO YES}	APPC partner-LU verification
XCMD={YES name NO}	EXEC CICS system commands EXEC CICS FEPI system commands
XDB2={NO name}	CICS DB2 resources
XDCT={YES name NO}	Transient data queues
XFCT={YES name NO}	Files
XHFS={YES NO}	z/OS UNIX files managed by z/OS UNIX System Services
XJCT={YES name NO}	Journals and logs
XPCT={YES name NO}	Started transactions and EXEC CICS commands: COLLECT STATISTICS TRANSACTION DISCARD TRANSACTION INQUIRE TRANSACTION SET TRANSACTION
XPPT={YES name NO}	Programs
XPSB={YES name NO}	DL/I program specification blocks (PSBs)

Table 4. System initialization parameters for the CICS resource classes (continued)

System initialization parameter	Resource
XRES={YES name NO}	CICS resources subject to XRES security checks. For a list of resources subject to XRES security checks, see “Security using the XRES resource security parameter” on page 71.
XTRAN={YES name NO}	Attached transactions
XTST={YES name NO}	Temporary storage queues
XUSER={YES NO}	Surrogate user checking DB2 AUTHTYPE checking

Note:

1. The parameters are effective only with SEC=YES.
2. None of the parameters can be entered as a console override.

If you specify YES for any of the *Xname* system initialization parameters where RACF is used to manage resource security, CICS uses the default class name for that parameter. See [“RACF classes for CICS resources”](#) on page 19 for a list of these.

As an example, the effect of specifying SEC=YES with three of the resource class parameters specified as *Xname*=YES is illustrated in the following table.

Table 5. Specifying external security with default resource classes

System initialization parameter	Effect
SEC=YES	CICS initializes the external security interface.
XTRAN=YES	CICS uses the TCICSTRN and GCICSTRN resource class profiles for transaction-attach security checking.
XFCT=YES	CICS uses the FCICSFCT and HCICSFCT resource class profiles for file access security checking.
XPSB=YES	CICS uses the PCICSPSB and QCICSPSB resource class profiles for PSB access security checking.

As a second example, the effect of specifying SEC=YES with the same three associated resource class parameters specified as *Xname*=username is shown in [Table 6 on page 49](#).

Table 6. Specifying external security for user-defined resource classes

System initialization parameter	Effect
SEC=YES	CICS uses full RACF security support.
XTRAN=\$usrtrn	CICS uses the T\$usrtrn and G\$usrtrn user-defined resource class profiles for transaction-attach security checking.
XFCT=\$usrfct	CICS uses the F\$usrfct and H\$usrfct user-defined resource class profiles for file access security checking.
XPSB=\$usrpsb	CICS uses the P\$usrpsb and Q\$usrpsb user-defined resource class profiles for PSB access security checking.

When CICS is being initialized, it requests RACF to bring resource profiles into main storage to match all the resource classes that you specify on system initialization parameters. Note that (except for XAPPC and XDB2) *Xname*=YES is the default in the system initialization parameters, and CICS will use the default classnames, for example, GCICSTRN. Supply RACF profiles for all those resources for which you do not

specify *Xname=NO* explicitly. If CICS requests RACF to load a general resource class that does not exist or is not correctly defined, CICS issues a message indicating that external security initialization has failed, and terminates CICS initialization.

The system initialization parameter *XHFS* is an exception to this process. Access controls for z/OS UNIX files are not managed directly by RACF, so they do not require individual RACF profiles, even if *XHFS=YES* is specified. Access controls for z/OS UNIX files are specified in z/OS UNIX System Services, which makes use of RACF to manage user IDs and groups, but keeps control of the permissions set for the files. If you are using access control lists (ACLs) for z/OS UNIX files, the RACF class *FSSEC* must be active.

For guidance on the syntax of external security system initialization parameters, see [System initialization parameter descriptions and summary](#).

The way you define the individual transaction definitions in the CSD determines whether you want to use RACF security for the resources and commands used with transactions. See [“Verifying CICS users”](#) on page 52 and [“Transaction security”](#) on page 66 for information about specifying resource and command security for transactions.

XAPPC, XHFS, and XUSER

The syntax of the ***XAPPC***, ***XHFS***, and ***XUSER*** system initialization parameters is slightly different from the syntax of the other *Xname* parameters. You can specify only YES or NO.

XAPPC=YES indicates that you want session security for APPC sessions. If *XAPPC=YES* is specified and the *APPCLU* class is not activated in RACF, CICS fails to initialize. For more information see [CICS initialization failures related to security](#).

XAPPC enables RACF LU6.2 bind-time (also known as APPC) security. For more information see [“Bind-time security with LU6.2”](#) on page 222.

For more information see [“Defining profiles in the APPCLU general resource class”](#) on page 223.

XHFS activates access control for Web client access to z/OS UNIX files in the CICS region. For more information see [“Security for z/OS UNIX files”](#) on page 87.

XUSER activates surrogate user security, and *AUTHTYPE* checking for DB2. For more information, see [“Surrogate user security”](#) on page 113. If *XUSER=YES* is specified and the *SURROGAT* class is not activated in RACF, CICS fails to initialize.

Using IBM-supplied classes without prefixing

To set up external security for transactions, files, and PSBs, using IBM-supplied resource classes and without prefixing, take the steps described in this topic.

Before you define a profile, activate the relevant classes, using the *SETROPTS CLASSACT* and *SETROPTS GENERIC* commands, as described in [“Summary of RACF commands”](#) on page 23.

To ensure the least interruption to actual business processes, work in a test region first.

1. Plan and create RACF profiles in the relevant classes:

```
RDEFINE TCICSTRN transaction-name UACC(NONE) NOTIFY(userid)
RDEFINE FCICSFCT file-name UACC(NONE) NOTIFY(userid)
RDEFINE PCICSPSB PSB-name UACC(NONE) NOTIFY(userid)
```

2. Permit appropriate users or groups (preferably groups) to have access to the profiles:

```
PERMIT transaction-name CLASS(TCICSTRN) ACCESS(READ)
ID(userid or groupid)
PERMIT file-name CLASS(FCICSFCT) ACCESS(READ)
ID(userid or groupid)
PERMIT PSB-name CLASS(PCICSPSB) ACCESS(READ)
ID(userid or groupid)
```

3. Specify the following CICS system initialization parameters:

```
SEC=YES XTRAN=YES XCMD=NO
SECPRFX=NO XFCT=YES XDB2=NO
```

```

XPSB=YES          XDCT=NO
                 XHFS=NO
                  XJCT=NO
                  XPCT=NO
                  XPPT=NO
                  XRES=NO
                  XTST=NO
                  XUSER=NO
                  XAPPC=NO

```

4. Start the CICS region in which you will be using external security.
5. If you add, change, or delete RACF profiles in the related classes, refresh the in-storage profiles. (For more information, see [“Refreshing resource profiles in main storage”](#) on page 18.)

Using IBM-supplied classes with prefixing

To set up external security for transactions, files, and PSBs, using IBM-supplied resource classes with prefixing, take the steps described in this section.

Before you define a profile, you must activate the relevant classes, using the SETROPTS CLASSACT and SETROPTS GENERIC commands, as described in [“Summary of RACF commands”](#) on page 23.

To ensure the least interruption to actual business processes, work in a test region first.

Note: The following examples assume that the CICS region userid is CICS1, and that SECPRFX=YES.

1. Plan and create RACF profiles in the relevant classes:

```

RDEFINE TCICSTRN CICS1.transaction-name UACC(NONE) NOTIFY(userid)
RDEFINE FCICSFCT CICS1.file-name         UACC(NONE) NOTIFY(userid)
RDEFINE PCICSPSB CICS1.PSB-name          UACC(NONE) NOTIFY(userid)

```

2. Permit appropriate users or groups (preferably groups) to have access to the profiles:

```

PERMIT CICS1.transaction-name CLASS(TCICSTRN) ACCESS(READ)
      ID(userid or groupid)
PERMIT CICS1.file-name        CLASS(FCICSFCT) ACCESS(READ)
      ID(userid or groupid)
PERMIT CICS1.PSB-name         CLASS(PCICSPSB) ACCESS(READ)
      ID(userid or groupid)

```

3. Specify the following system initialization parameters:

```

SEC=YES          XTRAN=YES          XCMD=NO
SECPRFX=YES     XFCT=YES           XDB2=NO
                XPSB=YES           XDCT=NO
                XHFS=NO           XJCT=NO
                XPCT=NO           XPPT=NO
                XRES=NO           XTST=NO
                XUSER=NO          XAPPC=NO

```

4. Start the CICS region in which you will be using external security.
5. If you add, change, or delete RACF profiles in the related classes, refresh the in-storage profiles. (For more information, see [“Refreshing resource profiles in main storage”](#) on page 18.)

Using installation-defined classes without prefixing

To set up external security for transactions, files, and PSBs in installation-defined classes, without prefixing, take the steps described in this topic.

For an example of how to define installation-defined classes (T\$USRTRN and G\$USRTRN) for the XTRAN parameter, see the IBM-supplied sample, DFH\$RACF, in CICSTS54.CICS.SDFHSAMP. See also [“Specifying user-defined resources to RACF”](#) on page 137.

Before you define a profile, activate the relevant classes, using the SETROPTS CLASSACT and SETROPTS GENERIC commands, as described in [“Summary of RACF commands”](#) on page 23.

To ensure the least interruption to actual business processes, work in a test region first.

1. Set up the following installation-defined classes:

- T\$USRTRN like TCICSTRN, and G\$USRTRN like GCICSTRN
- F\$USRFCT like FCICSFCT, and H\$USRFCT like HCICSFCT
- P\$USRPSB like PCICSPSB, and Q\$USRPSB like QCICSPSB

For specific information on setting up installation-defined classes, see the [z/OS Security Server RACF System Programmer's Guide](#).

1. Plan and create RACF profiles in the relevant classes:

```
RDEFINE T$USRTRN transaction-name UACC(NONE) NOTIFY(userid)
RDEFINE F$USRFCT file-name UACC(NONE) NOTIFY(userid)
RDEFINE P$USRPSB PSB-name UACC(NONE) NOTIFY(userid)
```

2. Permit appropriate users or groups (preferably groups) to have access to the profiles:

```
PERMIT transaction-name CLASS(T$USRTRN) ACCESS(READ)
ID(userid or groupid)
PERMIT file-name CLASS(F$USRFCT) ACCESS(READ)
ID(userid or groupid)
PERMIT PSB-name CLASS(P$USRPSB) ACCESS(READ)
ID(userid or groupid)
```

3. Specify the following system initialization parameters:

```
SEC=YES          XTRAN=$USRTRN      XCMD=NO
SECPRFX=NO       XFCT=$USRFCT      XDB2=NO
                 XPSB=$USRPSB     XDCT=NO
                 XHFS=NO          XJCT=NO
                 XPCT=NO          XPPT=NO
                 XRES=NO          XTST=NO
                 XUSER=NO         XAPP=NO
```

4. Start the CICS region in which you will be using external security.

5. If you add, change, or delete RACF profiles in the related classes, refresh the in-storage profiles. (For more information, see [“Refreshing resource profiles in main storage”](#) on page 18.)

Verifying CICS users

To protect resources from unauthorized access, CICS must be able to identify users of the system when they invoke transactions.

Identifying CICS terminal users

If you are running CICS with RACF security checking, you control users' access to CICS resources through levels of authorization you define in RACF-managed resource profiles.

You define these authorizations for specific users by adding individual RACF userids (or RACF group IDs) to the resource access lists; or, for unsigned-on users, by adding the default CICS userid to selected resource access lists.

All CICS terminal-user data is defined in the CICS segment of the RACF user profile. See [“Obtaining CICS-related data for a user”](#) on page 63 for more information about CICS terminal-user data, and how CICS obtains it.

The sign-on process

When users log-on to CICS through the z/OS Communications Server, but do not sign on, they can use only those transactions that the CICS default user is permitted to use.

As these are likely to be strictly limited, users must sign on to obtain authorization to run the transactions that they are permitted to use.

Explicit sign-on

You can explicitly sign on either by using one of the CICS-supplied sign-on transactions CESL or CESN or by using an installation-provided sign-on transaction that uses the **EXEC CICS SIGNON** command.

OIDCARD users can use CESL or CESN to sign on if the card reader supports the DFHOPID identifier (AID). If it does not, use your own installation-provided sign-on transaction. When you sign on to CICS, the sign-on process involves the following phases:

Scoping

After the sign-on panel is completed and sent, CICS verifies that the user ID you entered does not match a user ID already signed on in the scope of the **SNSCOPE** definition for the CICS system.

Identification

CICS calls RACF to confirm that a profile has been defined for your user ID.

Verification

CICS passes information to RACF to verify that the user ID is genuine. For RACF, this information is either a password or an OIDCARD or both. If the password entered is between 9 and 100 characters, RACF verifies it with the password phrase associated with your user ID. If the password is 8 characters or less, RACF verifies it with your standard password. A user ID can have both a standard password and a password phrase. If the password or password phrase has expired, CICS prompts you for a new password or password phrase. When the new password conforms to the RACF password formatting rules for an installation, the new password or password phrase and the date-of-change are recorded in your RACF user profile.

Passwords and password phrases operate independently of each other. You can sign on with a valid password phrase even if your standard password has expired. Similarly, you can sign on with a valid password if your password phrase has expired.

Immediately following the request to RACF for user ID and password verification, CICS clears the internal password field. This minimizes the possibility of the password or password phrase being revealed in any dump of the CICS address space that might be taken.

The CESL and CESN transactions do not warn users when a password or password phrase is about to expire. To display expiry warnings to users, you must replace CESL or CESN with your own transaction that calls a custom sign-on program. This program can use the **EXEC CICS VERIFY PASSWORD** or **EXEC CICS VERIFY PHRASE** commands to return expiry information from RACF, before using the **EXEC CICS SIGNON** command to make a full verification request for the user ID.

Authorization

RACF performs checks on the application name and the port of entry to verify that you are allowed to use the CICS system. In the application name check, RACF determines whether you are authorized to access the application named in the APPLID or GRNAME system initialization parameter. RACF does this by checking the access list of the CICS application profile defined in the RACF APPL resource class. (See [“Authorizing access to the CICS region” on page 43](#) for information about how to define profiles in the APPL resource class.)

With the port of entry check, RACF verifies that you are authorized to sign on using that port of entry. The use of defined terminals can be restricted to certain times of the day, and to certain days of the week. See [“Controlling access to CICS from specific ports of entry” on page 55](#).

These checks restrict CICS users to signing on only to those CICS regions for which they are authorized, and only from terminals they are authorized to use.

Explicit sign-on, with the CESL or CESN transaction, or the SIGNON command, is performed at the port of entry.

<i>Table 7. Explicit and implicit signons</i>		
Phase	Explicit	Implicit
Scoping	Yes	No
Identification	Yes	Yes
Verification	Yes	No except with ATTACHSEC(IDENTIFY)
Authorization	Yes	Yes

User attributes

CICS obtains CICS user attributes from the CICS and LANGUAGE segments of the RACF database.

The sign-off process

The sign-off process dissociates a user from a terminal where the user had been previously signed on. The user can explicitly sign off using the CESF transaction or an installation-provided transaction that uses the SIGNOFF API command. If the attributes of the signed-on user include a non-zero value for TIMEOUT, an implicit sign-off occurs if this interval expires after a transaction terminates at this terminal.

When the timeout period expires, if the default GNTRAN=NO is specified, CICS performs an immediate signoff. If GNTRAN specifies a transaction-id to be scheduled and that transaction performs a signoff, the action CICS takes depends on the SIGNOFF option specified in the terminal's TYPETERM resource definition.

An exceptional case is that the goodnight transaction is not used for the user of a CRTE session. A surrogate user whose time expires is signed off, losing the security capabilities the terminal previously had. Message DFHSN1200 is sent to the CSCS log, and indicates what has happened.

For more information about the use of system initialization parameter GNTRAN, see [“Goodnight transaction” on page 55](#). The possible signoff options and the associated actions are as follows:

SIGNOFF(YES)

CICS signs off the operator from CICS, but the terminal remains connected.

SIGNOFF(LOGOFF)

CICS signs off the operator from CICS **and** logs off the terminal from z/OS Communications Server.

In addition, if the terminal is auto-installed, the delay period specified by the AILDELAY operand in the system initialization parameters commences, and if the delay period expires before the terminal attempts to log on again, CICS deletes the terminal entry (TCTTE) from the TCT.

SIGNOFF(NO)

CICS leaves the user signed on and the terminal remains logged on, effectively overriding the timeout period.

Explicit sign-off

Explicit sign-off removes the user's scoping. The user must be explicitly signed on before signing off with the CESF transaction or the SIGNOFF command. The user is returned to the default level of security.

Note: CESL or CESN will not sign the user off until a valid attempt has been made to use the CESL or CESN panel, even if the sign-on attempt subsequently fails. It is not recommended that CESL or CESN be used for the Goodnight transaction.

Implicit sign-on and implicit sign-off

Implicit sign-on means that all other user IDs added to the system by CICS are considered to be implicitly signed on without a password or password phrase.

A user is implicitly signed off if the transaction suffers a TERMERR condition while attempting to send data to its principal facility. However, the user is not subject to USRDELAY but is signed off immediately. If SNSCOPE is in use, the scope will be released at the time of sign off. If the transaction handles the ABEND, it continues running as a non-terminal task with the authority of the starting user.

Goodnight transaction

By specifying your own GNTRAN transaction, you can use the CICS API to control the TIMEOUT operation. For example, your transaction could display a screen that prompts for the password.

Specifying the USERID option on the **ASSIGN** command obtains the userid, and the **VERIFY PASSWORD** command would validate the input. Based on the response, the user could remain signed on or be signed off.

By default CICS uses the CESF transaction to sign-off a user terminal. The goodnight transaction is not available for a surrogate terminal that is timed out during a CRTE session. Sign-off occurs with a loss of the security capabilities the terminal previously had, leaving a DFHSN1200 message in the log.

Controlling access to CICS from specific ports of entry

During sign-on processing, CICS issues a request to RACF to verify the user's password, and to check whether the user is allowed to access that terminal.

This check is also performed for the userid specified for preset security terminal definitions. Autoinstalled consoles that are using automatic sign-on are treated as though they have a preset security definition (see [“Preset terminal security”](#) on page 59). If the terminal is not defined to RACF, RACF responds to CICS according to the system-wide RACF option specified by the SETROPTS command. The options are as follows:

TERMINAL(READ)

With this option in force, terminal users can sign on at any terminal covered by a profile to which they have been permitted access, or at any terminal not defined as protected by RACF.

TERMINAL(NONE)

With this option in force, terminal users can sign on at only those terminals with specific terminal profiles defined to RACF, and which they are authorized to use.

Note: The TERMINAL class does not control access from MVS consoles. These are controlled by the CONSOLE resource class. See [“Console profiles”](#) on page 58.

You can override the system-wide terminal options at the RACF group level by means of the group terminal options, TERMUACC or NOTERMUACC.

See [“Universal access authority for undefined terminals”](#) on page 57 for more information about the SETROPTS command for terminals, and about the TERMUACC|NOTERMUACC option on groups.

Defining port of entry profiles

Port of entry is the generic term for the device at which the user signs on. For CICS, the port of entry can be either a terminal or a console. You can use associated port of entry profiles to control whether a user can sign on at a particular device.

Terminal profiles

You can control user access to a terminals using profiles in the TERMINAL and GTERMINL resource classes.

This section briefly describes some aspects of terminal profiles that are of interest to CICS users. For more detailed information about defining and protecting terminals on MVS systems, particularly on the following topics, see the [z/OS Security Server RACF Security Administrator's Guide](#).

- Creating a profile in the TERMINAL or GTERMINL class
- Preventing the use of an undefined terminal
- Restricting specific groups of users to specific terminals
- Restricting the days or times when a terminal can be used
- Using a security label to control a terminal.

You can control user access to a terminal by defining it to RACF. (User access is determined at CICS sign-on time.) RACF supports two IBM-supplied resource class names for terminals:

TERMINAL

For defining a profile of an **individual** terminal.

GTERMINL

For defining a profile of a **group** of terminals.

Note: For a GTERMINL profile, RACF always uses an in-storage profile, which must be manually refreshed. Every time you create, change, or delete a GTERMINL profile, you (or the RACF security administrator) must issue a SETROPTS RACLIST(TERMINAL) REFRESH command for the change to take effect.

Defining a profile of an individual terminal

To define terminals with NETNAMEs NETID1, NETID2, and NETID3 in the TERMINAL resource class, use the command:

```
RDEFINE TERMINAL (NETID1, NETID2, NETID3) UACC(NONE)
      NOTIFY(sys_admin_userid)
```

If the terminal IDs start with the same characters, you can create a generic profile to cover a group of terminals with the same initial characters. You must use the SETROPTS GENERIC command before defining generic profiles, as described in [“Summary of RACF commands” on page 23](#). This reduces the amount of effort needed to create the access list. For example:

```
RDEFINE TERMINAL NETID* UACC(NONE)
      NOTIFY(sys_admin_userid)
PERMIT netid* CLASS(TERMINAL)
      ID(group1, group2,.., groupn) ACCESS(READ)
```

Defining a profile of a group of profiles

You can define the same terminals in the resource group class, by including them as members of a suitable terminal group. For example:

```
RDEFINE GTERMINL term_groupid
      ADDMEM(NETID1, NETID2, NETID3) UACC(NONE)
      NOTIFY(sys_admin_userid)
```

To remove a terminal from a resource group profile, specify the DELMEM operand on the RALTER command. For example:

```
RALTER GTERMINL term_groupid
      DELMEM(NETID3)
```

To allow a group of users in a particular department to have access to these terminals, use the PERMIT command as follows:

```
PERMIT term_groupid CLASS(GTERMINL) ID(dept_groupid) ACCESS(READ)
```

Profiles in the TERMINAL or GTERMINL class

For CICS, the terminal profiles to define to RACF in the TERMINAL or GTERMINL class are used only for SNA LUs.

The name of the profile is the value of the NETNAME that is specified in the RDO terminal definition or autoinstall. It is not possible to use TERMINAL profiles with non-SNA LUs.

Universal access authority for undefined terminals

RACF supports a universal access facility for undefined terminals, which you can control by means of the SETROPTS TERMINAL command (provided you have the necessary authorization). When SETROPTS TERMINAL(NONE|READ) is in effect, it affects **all** MVS terminal subsystems.

If SETROPTS TERMINAL(READ) is in effect, RACF allows any user to log on at any undefined terminal (that is, a terminal not defined in the TERMINAL or GTERMINL resource classes). If SETROPTS TERMINAL(NONE) is in effect, RACF does not allow anyone to log on at any undefined terminal.

Note: Before issuing the SETROPTS TERMINAL(NONE) command, define some TERMINAL or GTERMINL class profiles, with enough authorizations to ensure that at least some of the terminals can be used otherwise no one will be able to access any terminal.

Overriding the SETROPTS TERMINAL command

You can override the SETROPTS TERMINAL command at the group level by specifying the TERMUACC or NOTERMUACC option on the ADDGROUP or ALTGROUP command.

The effect of the TERMUACC parameter is to enforce the universal access option. For example, if SETROPTS TERMINAL(READ) is active, the TERMUACC option means that any users in the group can access any undefined terminal. On the other hand, if you specify NOTERMUACC for the group, the SETROPTS TERMINAL command has no effect for that group, and a user in the group needs explicit authorization to use a terminal. To enable a group with the NOTERMUACC option to access terminals, you must add group userid to the access list of the appropriate TERMINAL or GTERMINL profile.

Conditional access processing

Using RACF, you can permit a user to access resources when that user is signed on a particular terminal or console, but not otherwise. Access that is restricted in this way is known as *conditional access*.

To grant conditional access to a resource, add

```
WHEN(TERMINAL(netname))
```

or

```
WHEN(CONSOLE(console-name))
```

to the PERMIT command.

The following example allows members of the PAYROLL group to read the SALARY file wherever they are signed on. They would be able to update it only from the terminal with netname PAY001, by issuing the following commands:

```
RDEFINE FCICSFCT SALARY UACC(NONE)
PERMIT SALARY CLASS(FCICSFCT) ID(PAYROLL) ACCESS(READ)
PERMIT SALARY CLASS(FCICSFCT) ID(PAYROLL)
(WHEN(TERMINAL(PAY001)) ACCESS(UPDATE))
```

To allow members of the operations group OPS to be able to use the CEMT transaction only from the console names MVS1MAST, issue the following command:

```
RDEFINE TCICSTRN CEMT UACC(NONE)
PERMIT CEMT CLASS(TCICSTRN) ID(OPS) WHEN(CONSOLE(MVS1MAST)) AC(READ)
```

Note:

1. The CONSOLE class must be active before CONSOLE conditional access lists can be used.
2. Conditional access lists may only increase authority and not decrease it.

For other considerations on conditional access lists, see the [z/OS Security Server RACF Security Administrator's Guide](#).

Console profiles

Use the CONSOLE resource class to define profiles that control user access to a console.

If the CONSOLE class has been activated, you can control whether a user is allowed to sign on to a console. Console protection is implemented in a method similar to that for protecting terminals, with the exception of the following, which were discussed in [“Overriding the SETROPTS TERMINAL command” on page 57](#):

1. The SETROPTS TERMINAL command does not apply to consoles.
2. The TERMUACC group attribute does not apply to consoles.

Before activating the CONSOLE class, check [z/OS MVS Planning: Operations](#) for the effects of console protection on MVS consoles.

The profile used in the console class is the console name or number. For example:

```
RDEFINE CONSOLE CICSCONS UACC(NONE)
```

The user must have READ access to the console name to sign-on at a console. The following example shows how user CICSOPR would be permitted to sign on to the console named CONCICS1:

```
RDEFINE CONSOLE CONCICS1 UACC(NONE)
PERMIT CONCICS1 CLASS(CONSOLE) ID(CICSOPR) ACCESS(READ)
```

Note that, unlike the case with TERMINAL protection, a sign-on attempt will fail if made at a console that has not been defined in the activated CONSOLE class. The access authority to undefined consoles is NONE.

Auditing sign-on and sign-off activity

RACF can log all sign-on and sign-off activity to SMF, including any invalid or unsuccessful sign-on attempts. You can use this information in several ways: for example, as an audit trail, to identify possible attempts to breach security, and to help with capacity planning.

You can only properly interpret the logging of unsuccessful sign-on attempts by also recording successful sign-ons. For example, if a user makes one or two unsuccessful attempts followed immediately by a successful sign-on, the unsuccessful sign-ons can be interpreted as being caused by keying errors at the terminal. However, several unsuccessful attempts for a variety of userids occurring within a short space of time, and without any subsequent successful sign-on activity being recorded, may well be cause for a security concern that warrants investigation.

Recording the successful sign-on and sign-off activities establishes an audit trail of the access to particular systems by the terminal user population. This may also be useful for systems capacity planning, and generally constitutes a very modest portion of the information recorded to SMF.

CICS uses its CSCS transient data destination for security messages. Messages of interest to the security administrator for the CICS region are directed to this destination. In some instances, when security-related messages are directed to terminal users, corresponding messages are written to the CSCS transient data destination. In the case of the DFHCE3544 and DFHCE3545 messages that are sent to terminal users, for example, the corresponding messages DFHSN1118 and DFHSN1119 are sent to CSCS. The DFHSNxxxx messages include reason codes that indicate the precise nature of the invalid sign-on attempt.

Preset terminal security

For some terminals, and MVS consoles when used as CICS terminals, it is appropriate to use preset terminal security as an alternative to terminal user security.

A terminal becomes a preset security terminal when you specify the USERID attribute on the TERMINAL resource definition.

There are two types of preset security for consoles:

1. Normal preset security (the same as preset security for other terminals)
2. Automatic preset security

Normal preset security

CICS preset terminal security allows you to associate a userid permanently with a terminal, or console, that is defined to CICS.

This means that CICS implicitly signs on the device when it is being installed, instead of a subsequent sign-on of that terminal by a user. Typically, you define preset security for devices without keyboards, such as printers, at which users cannot sign on.

You can also use the normal preset security on ordinary display terminals as an alternative to terminal user security. This permits anyone with physical access to a terminal with preset security to enter the transactions that are authorized for that terminal. The terminal remains signed on as long as it is installed, and no explicit sign-off can be performed against it. If the userid associated with a display terminal with preset-security has been authorized to use any sensitive transactions, ensure that the terminal is in a secure location to which access is restricted. Preset-security might be appropriate, for example, for the terminals physically located within a CICS network control center.

You can use preset-security to assign a userid with **lower** authority than the default, for terminals in unrestricted areas.

For example, to define a terminal with preset-security, use RACF and CICS (CEDA) commands as follows:

```
ADDUSER userid NAME(preset_terminal_user_name) OWNER(owner_userid or group_id)
          DFLTGRP(group_name)
CEDA DEFINE TERMINAL(cics_termid) NETNAME(vtam_termid) USERID(userid)
          TYPETERM(cics_typeterm)
```

Note: VTAM is now z/OS Communications Server (for SNA or IP).

For further information on preset-security terminals in the transaction routing environment, refer to [“Preset-security terminals and transaction routing” on page 234](#).

Automatic preset security for consoles

Automatic preset security applies only to console definitions. CICS automatic preset security allows you to associate the userid, which MVS has already verified through RACF, with the CICS definition for the console.

Instead of specifying an actual user id on the TERMINAL definition, you specify a special value (*FIRST or *EVERY), to indicate that CICS is to use the user id passed by MVS on the MODIFY command. This means that CICS implicitly signs on the console when it is being installed, and optionally on each input message, instead of a subsequent sign-on of that console by a user. Particularly in the context of autoinstalled consoles, this allows you to gain the advantage of preset security without having to define the user

id/console relationship in the CICS terminal definition. Thus, console users do not have to sign-on with passwords in the clear to each CICS region.

You can use this automatic form of preset security on predefined consoles, autoinstalled consoles, and consoles installed with the **CREATE TERMINAL** command.

For example, to define a console with automatic preset-security, which is checked, and altered (if necessary) on every MODIFY, use CICS (CEDA) commands as follows:

```
CEDA DEFINE TERMINAL(cics_termid)
           CONSNAME(consolename) USERID(*EVERY)
           TYPETERM(cics_typeterm)
```

To define a console with automatic preset-security that is defined on the first valid MODIFY command only, use CICS (CEDA) commands as follows:

```
CEDA DEFINE TERMINAL(cics_termid)
           CONSNAME(consolename) USERID(*FIRST)
           TYPETERM(cics_typeterm)
```

Controlling the use of preset security

When a preset security terminal is installed, the specified userid is implicitly signed on at the terminal.

Ensure that only a trusted person is allowed to define and install terminals with preset security, because the userid specified on the terminal might have access to CICS resources not available to the installer. Automatic preset security for consoles does not carry the same risks because the console user is associated with their true identity (verified by RACF). For this reason, no checking is carried out when a console device is defined to CICS with either USERID(*EVERY) or USERID(*FIRST).

Surrogate user checking ensures that a user is authorized to act for another user. Surrogate user checking can be enforced when a user installs a terminal that is preset for a different userid, and is specified by the RACF SURROGAT resource class. The CICS *userid*.DFHINSTL resource can be defined in the SURROGAT resource class for authorization to install terminals that are preset for that specific userid.

When a terminal is installed with a preset userid, the surrogate user is the userid that is performing the installation. For more information, see [“Surrogate user security” on page 113](#).

The CEDA command checks the authority of the user to install preset terminals. Consider, therefore, whether to restrict the following functions with a view to controlling who can define and install terminals with preset security:

- The CEDA transaction:

Restricting the use of the CEDA transactions to authorized users gives you control over who can define resources, such as terminals, to CICS. For information about protecting CICS-supplied transactions, see [“Security for CICS-supplied transactions” on page 140](#)

- The SURROGAT resource class:

If you restrict who can install terminals with preset security, even when such terminals are defined in the CSD, only authorized users can install them on CICS. This authority is in addition to the authority needed to run CEDA; the user must already have authority to run the CEDA transaction.

To define a surrogate profile and authorize a user to install a terminal definition with preset security, use the following commands:

```
RDEFINE userid1.DFHINSTL SURROGAT UACC(NONE)
PERMIT userid1.DFHINSTL CLASS(SURROGAT) ID(userid2) ACCESS(READ)
```

This permits *userid2* to install a terminal preset with *userid1*

- The XUSER system initialization parameter:

To ensure that CICS can perform surrogate user security checks on the use of the CEDA INSTALL command for terminals with preset security, define the **XUSER** system initialization parameter. See

[“CICS resource class system initialization parameters”](#) on page 48 for information about defining this parameter.

- The LOCK command for locking CSD definitions

CICS installs resource definitions in the CSD during an initial or cold start, from the list of groups that are defined on the **GRPLIST** system initialization parameter. To control the addition of resource groups to the CICS startup group list, use the CEDA LOCK command to lock the list. This lock protects the group list from unauthorized additions. Also, lock all the groups that are specified in this list.

Note: The OPIDENT of the signed-on user is used as the key for the CEDA LOCK and CEDA UNLOCK commands. For more information about the LOCK and UNLOCK commands, see [The CEDA LOCK command](#) and [The CEDA UNLOCK command](#).

Note: When CICS installs a GRPLIST that contains preset terminal definitions, no checking is done at initialization time. However, you can still ensure that you control who can define and install terminals and sessions with preset security by using the CEDA LOCK command to control the contents of GRPLIST groups.

Other preset security considerations

If you intend to use preset security, you need to be aware of some additional considerations:

- Autoinstall models:

If you are using autoinstall models with preset security, CICS makes the same surrogate authorization check as for ordinary terminals when the model is installed. It does not check surrogate authorization when the autoinstall model is used to perform autoinstall for a device. Also, CICS does not make a surrogate authorization check when it is installing models defined with automatic preset security for consoles.

If an autoinstall model with a preset userid becomes invalid (for example, if the userid is revoked), any attempt to install a terminal with the model fails.

- Sessions with preset security:

A session becomes governed by preset security if you specify the userid operand on the session definition. The same checking is performed if you install preset security sessions.

- Terminals that are defined in the TCT:

For terminals such as BSAM terminals that are defined in the terminal control table (TCT) by using DFHTCT macros, the userid is also defined in the TCT, and, when CICS initializes, it signs on these terminals. If the sign-on fails (for example, if the userid is revoked), the terminal is put out of service. If the userid later becomes valid (for example, if it is resumed), setting the terminal in service results in a successful sign-on. CICS does not perform a surrogate user check for these terminals.

Using an MVS system console as a CICS terminal

If you intend to use an MVS system console as a CICS terminal, you might need authorization to use the MVS MODIFY command by using the OPERCMDS resource class.

You can specify automatic preset security on the console's CICS terminal definition so that the console user obtains the correct level of authority without explicitly performing a CICS sign-on (which exposes the password).

If preset security is not defined, console users must sign on to get authority different from the default user. In this case, the password or password phrase can generally be seen on the console and system log. However, if CICS is defined as an MVS subsystem in a JES2 system, you can use the HIDEPASSWORD=YES option of the DFHSSIxx member in SYS1.PARMLIB, which enables CICS to intercept the command and overwrite the password or password phrase with asterisks. For more information about defining CICS as an MVS subsystem, see [Defining CICS as an MVS subsystem](#).

You can use the CESL or CESN commands to sign on to CICS from a console. With CESL, you can use either a standard password or a password phrase as authorization. CESL treats any password over 8

characters as a password phrase. CESN does not support the use of password phrases. The format of the CESL and CESN sign-on commands, when entered from a console, is as follows:

```
MODIFY jobname,command_name [USERID=userid] [,PS=password]
      [,NEWPS=newpassword] [,GROUPID=groupid]
      [,LANGUAGE=language-code]
```

If a passphrase contains mixed-case characters, blanks, or both, the value of the PS parameter must be enclosed in single quotation marks, for example:

```
F JATP3250,CESL USERID=JAT232,PS='MOND July 17th'
```

The maximum length of the **MODIFY** command is 126 characters, including F *taskname*; the maximum length of a passphrase is 91 characters when it is specified in this way:

```
F JATP3250,CESL USERID=JAT284,PS='This is a valid long passphrase of
length 91 chars for CESL JAT testing 9XYZ0,#,.12345678!i'
```

For more information, see [Guidance for issuing console commands in z/OS](#).

With CESL, the PS (password) and NEWPS (new password) parameters must match; they must be either both password phrases or both standard passwords. You cannot authorize a new password phrase that uses a password and you cannot authorize a new password by using a password phrase. The PS and NEWPS parameters can contain spaces or punctuation characters, including single quotation marks, but each of these characters must be enclosed in two single quotation marks.

If any of the data entered on the command is invalid, or if the password or password phrase is missing or expired, CICS terminates the sign-on attempt.

You can authorize TSO users to use the TSO CONSOLE command. (For more information on this command, see [z/OS TSO/E System Programming Command Reference](#).) These users must be defined to CICS as consoles, by using the CONSNAME option of the DEFINE TERMINAL command, or be supported by autoinstall for consoles. For more information, see [Autoinstalling MVS consoles](#).

When the PS parameter is omitted from the CESL or CESN command, RACF can produce a security violation message, ICH408I. CESL and CESN cannot distinguish a user who is defined with OIDCARD, NOPASSWORD from a user who is defined with a PASSWORD authenticator who intentionally omits the password. To establish whether to prompt for a password or to reject the sign-on (a user who is defined with OIDCARD cannot sign on at a console), the sign-on must be attempted. If the sign-on fails, message ICH408I is issued, and CICS interprets the return code from RACF to determine whether the PASSWORD or OIDCARD authenticator is required.

Users can sign on using CESL or CESN, or you might prefer to use preset security (the normal preset security for CICS terminals, or automatic preset security for consoles). When the TSO user uses the CONSOLE command, that user's user ID, by default, becomes a console name. However, you can change the console name to something else by using the CONSNAME(*name*) option on the TSO CONSOLE command. This console name can then be used as a CICS terminal if there is a corresponding TERMINAL definition with the CONSNAME option in CICS (or if you autoinstall a terminal definition). If another name is specified, that name is the one CICS uses to communicate with the console. For example, it is possible for one TSO user to use a name that is the same as another TSO user's ID.

Furthermore, if the CONSOLE command is used to allow TSO operators to sign on to CICS with the CESL or CESN transaction, their passwords might be exposed on the TSO screen and in the MVS system log. You can prevent these potential exposures by defining the terminal as having preset security. It is advisable to use automated preset security for several reasons:

- TSO users do not have to sign on, which avoids exposing their IDs and passwords on the log.
- You do not have to define a relationship in a CICS definition between a console name and a user. A relationship might change frequently or become invalid.
- You can define one autoinstall model that covers most of your console definitions and gives each user the correct level of preset security.

To define automatic preset security, specify USERID(*EVERY) to ensure that the correct user ID is signed on for every command, or USERID(*FIRST) to sign on the console by using the user ID that first issues an MVS MODIFY command to CICS, and retain this for subsequent commands.

- Choose USERID(*FIRST) if use of a console is restricted to one or more users who have similar security characteristics to CICS using RACF, and you don't use the user ID as an identifier in applications.
- Use USERID(*EVERY) if you need to ensure that each input request is tested to be sure that the console user has the correct security level. You should be aware that checking the user ID imposes an overhead on MODIFY, and changing the preset user ID imposes another overhead, which is equivalent to the console user signing on using CESL or CESN.

Obtaining CICS-related data for a user

CICS obtains CICS-related data from one of the following sources: the CICS and LANGUAGE segments of the RACF profile, or built-in CICS system default values. This section explains how the data is obtained, for the default user and terminal users signing on.

Obtaining CICS-related data for the default user

When implicitly signing on the CICS default user during initialization, CICS obtains attributes in the following way:

1. CICS calls RACF to request user data for the CICS default user from the CICS segment and the LANGUAGE segment. If the CICS segment **or** the LANGUAGE segment data is present for the default userid, RACF returns this data to CICS. See [“The CICS segment” on page 12](#) for details of the information that you can define in the CICS segment. See [“The LANGUAGE segment” on page 15](#) for details of the LANGUAGE segment.
2. If RACF does not return the CICS segment or LANGUAGE segment data for the default userid, CICS assigns the following built-in system default values:

National language

Obtained from the first operand on the NATLANG system initialization parameter. This defaults to US English if not specified.

Operator class

One (OPCLASS=1)

Operator identification

Blank (OPIDENT=' ')

Operator priority

Zero (OPPRTY=0)

Timeout

Zero (TIMEOUT=0)

XRF signoff

Signoff not forced (XRFSOFF=NOFORCE)

Obtaining CICS-related data at signon

When handling an explicit sign-on for a CICS terminal user, CICS obtains the terminal user attributes in the following way:

1. CICS calls RACF to request data about the CICS terminal user from the CICS segment and the LANGUAGE segment. If the CICS segment **or** the LANGUAGE segment data is present for the terminal user, RACF returns this data to CICS. See [“The CICS segment” on page 12](#) for details of the information that you can define in the CICS segment. See [“The LANGUAGE segment” on page 15](#) for details of the LANGUAGE segment.
2. If RACF does not return the CICS segment or LANGUAGE segment data for the user, CICS uses the user attributes of the CICS default user, defined during system initialization. (See [“Obtaining CICS-related data for the default user” on page 63.](#))

CICS obtains the national language attribute in the following order:

1. The LANGUAGE option on the CICS-supplied CESN transaction, or the LANGUAGECODE or NATLANG option of the **SIGNON** command, if supported by CICS. A supported national language is a valid national language that has been specified in the **NATLANG** system initialization parameter and has the corresponding message definitions.
2. The PRIMARY *primary-language* parameter in the LANGUAGE segment of the user's RACF profile, if supported by CICS.
3. The SECONDARY *secondary-language* parameter in the LANGUAGE segment of the user's RACF profile, if supported by CICS.
4. The **NATLANG** parameter in the CSD definition of the user's terminal.
5. The language established for the default user as described in [“Obtaining CICS-related data for the default user”](#) on page 63.

See [National language codes](#) for a list of valid national languages.

Note: CICS ignores the RACF default national language defined by the command:

```
SETROPTS LANGUAGE(PRIMARY(...) SECONDARY(...))
```

Defining terminal users and user groups to RACF

You should plan to define your CICS terminal users in groups.

For this purpose, try to place the users of CICS systems in groups for ease of administration. For example, you might consider that all users who have the same manager, or all users within an order entry function, are an administrative unit. You can define such users to RACF as **groups** of individual users who have similar access requirements to CICS system resources. See the [z/OS Security Server RACF Security Administrator's Guide](#) for more information about:

- Access control and flexibility of operation for the system administrator
- Use of the group-SPECIAL attribute and its scope of control
- Reducing the need to refresh in-storage profiles

When you define a group, and then define users as members of that group, all the users in the group can access the resources to which the group has been given access.

The group structure selected depends on your own installation's requirements. Use the RACF command ADDGROUP to create a new group:

```
ADDGROUP groupname OWNER(userid)
```

Use the ADDUSER command to add new users to the group, defining the group name as the user's default group:

```
ADDUSER userid NAME(username) DFLTGRP(group_id)
        CICS(OPCLASS(1,2,...,n) OPIDENT(abc) OPPRTY(255) TIMEOUT(minutes)
        XRFSOFF(NOFORCE) LANGUAGE(PRIMARY(Language))
```

You can make a terminal user a member of more than one group by using the CONNECT command to add the user to a group other than that user's default group:

```
CONNECT userid GROUP(groupname)
```

Use the ALTUSER command to change a user's default group, as follows:

```
ALTUSER userid DFLTGRP(groupname)
```

Use the ALTUSER command to add CICS data for an existing userid. See [“The CICS segment”](#) on page 12 for details of the CICS optional data.

See the [z/OS Security Server RACF Command Language Reference](#) for the full syntax of these commands.

Example of defining terminal users and user groups to RACF

Assume there is a customer service department that:

- Takes orders
- Answers inquiries about those orders
- Establishes new customers

Consider creating the following customer service group:

```
ADDGROUP custserv OWNER(grpmangr)
```

In this example, *grpmangr* is the RACF userid of the person in charge of the customer service department system.

The person represented by *grpmangr*, or the RACF security administrator, can then create additional groups within the group CUSTSERV, as follows:

```
ADDGROUP ORDERS OWNER(SUP1) SUPGROUP(CUSTSERV)
ADDGROUP ORDINQ OWNER(SUP2) SUPGROUP(CUSTSERV)
ADDGROUP NEWCUST OWNER(SUP3) SUPGROUP(CUSTSERV)
```

The group owners, the person represented by *grpmangr* or the RACF security administrator can then define users within the groups. For example, the person represented by SUP1 could define users of the group ORDERS, as follows:

```
ADDUSER AARCHER NAME(' ANNE ARCHER') DFLTGRP(ORDERS)
ADDUSER JBRACER NAME(' JOHN BRACER') DFLTGRP(ORDERS) PASSWORD(XPRDTD)
        CICS(OPCLASS(1) OPIDENT(JBR) OPPRTY(0) TIMEOUT(15) XRFSSOFF(FORCE))
        LANGUAGE(PRIMARY(ENU))
```

Note:

1. The password of the user Anne Archer defaults to ORDERS, but the password of the user John Bracer is initially set as XPRDTD.
2. The user John Bracer is defined with a CICS segment and with a LANGUAGE segment.

Support for mixed-case passwords

Support for mixed-case passwords depends on your external security manager. All security managers that support password phrases, that is passwords between 9 and 100 characters in length, support mixed case. However, not all security managers that support standard passwords, that is passwords up to 8 characters in length support mixed case.

When the security manager used with CICS supports the use of mixed-case standard passwords, such as the z/OS Security Server (RACF) for z/OS 1.7, CICS does not convert passwords to uppercase before passing them to the security manager.

You can enter a password using one of the two signon transactions, CESL and CESN or one of the following API commands:

```
CHANGE PASSWORD
CHANGE PHRASE
VERIFY PASSWORD
VERIFY PHRASE
SIGNON
```

CESL supports password phrases and standard passwords. CESN supports only standard passwords. These transaction have two fields where passwords can be entered:

```
Password
New password
```

CICS can handle the password in one of two ways, depending upon whether the external security manager used with CICS supports mixed-case passwords.

- If the security manager supports mixed-case passwords, CICS passes the password to the security manager unchanged.
- If not, CICS converts the password to uppercase before passing it to the security manager.

To turn support for mixed-case passwords on, see [“Summary of RACF commands”](#) on page 23.

National language and non-terminal transactions

When a user specifies a national language during sign-on, the sign-on option overrides the language specified in the user's RACF CICS segment.

The language thus specified is set for the time that the user is signed on at the terminal. Any transaction invoked by the signed-on user runs with the national language specified on the sign-on.

However, if a transaction uses the `START` command to start another transaction, the national language attribute for the started transaction is derived as follows:

1. If the `USERID` parameter is specified on the `START` command, the national language is taken from the RACF CICS segment of the specified userid.
2. If the user is signed on at a terminal with a preset national language specified on the terminal definition, this preset national language is assigned to the started transaction.
3. If there is no userid on the `START` command, and no preset national language on the terminal, the started transaction inherits the national language specified in the RACF CICS segment of the signed-on user (not the national language used in the sign-on).

If the national language of the original terminal is required, the terminal's national language can be inquired about before the `START` command is issued. The information can then be passed as data in the `START` command for the use of the transaction that has been started.

Transaction security

Transaction security (also known as *attach-time security*, and *transaction-attach security*) ensures that users that attempt to run a transaction are entitled to do so.

CICS parameters controlling transaction-attach security

You control CICS transaction-attach security checking through CICS system initialization parameters.

These are:

SEC

Specify `SEC=YES` if you want to use RACF services to control access to any CICS resources—in particular, CICS transactions. (For more information, see [“Security-related system initialization parameters”](#) on page 46.)

SECPRFX

Specify `SECPRFX=YES` if your transaction profiles are defined to RACF with a prefix that corresponds to the userid of the CICS region.

Specify `SECPRFX=prefix` if your transaction profiles are defined to RACF with any other prefix.

(For more information, see [“Security-related system initialization parameters”](#) on page 46.)

XTRAN

Specify `XTRAN=YES` or `XTRAN=resource_class_name` if you want CICS to control who can initiate transactions. If you specify `YES`, CICS uses profiles defined in the RACF default resource classes `TCICSTRN` and `GCICSTRN`. (See [“RACF classes for CICS resources”](#) on page 19 for details of these resource classes.)

If you specify a resource class name, CICS uses the name you specified, prefixed with `T` for the resource class, and `G` for the grouping class.

If you specify XTRAN=NO, CICS does not perform any authorization check on users initiating transactions.

Note that the default is YES. Therefore if you specify SEC=YES and omit the XTRAN parameter, transaction-attach security is in effect, using the default resource class names.

There are no CICS parameters that allow you to control transaction-attach security at the individual transaction level. When you specify SEC=YES and XTRAN=YES (or XTRAN=resource_class_name), CICS issues an authorization request for every transaction. It does this whether the transaction is started from a terminal, by using an EXEC CICS START command, or triggered from the transient data queue, either with or without the termid operand. CICS performs this security check even if no user has signed on. Users who do not sign on can use only those transactions that are authorized to the default user.

Figure 2 on page 67 is an example which shows the main elements of CICS transaction security.

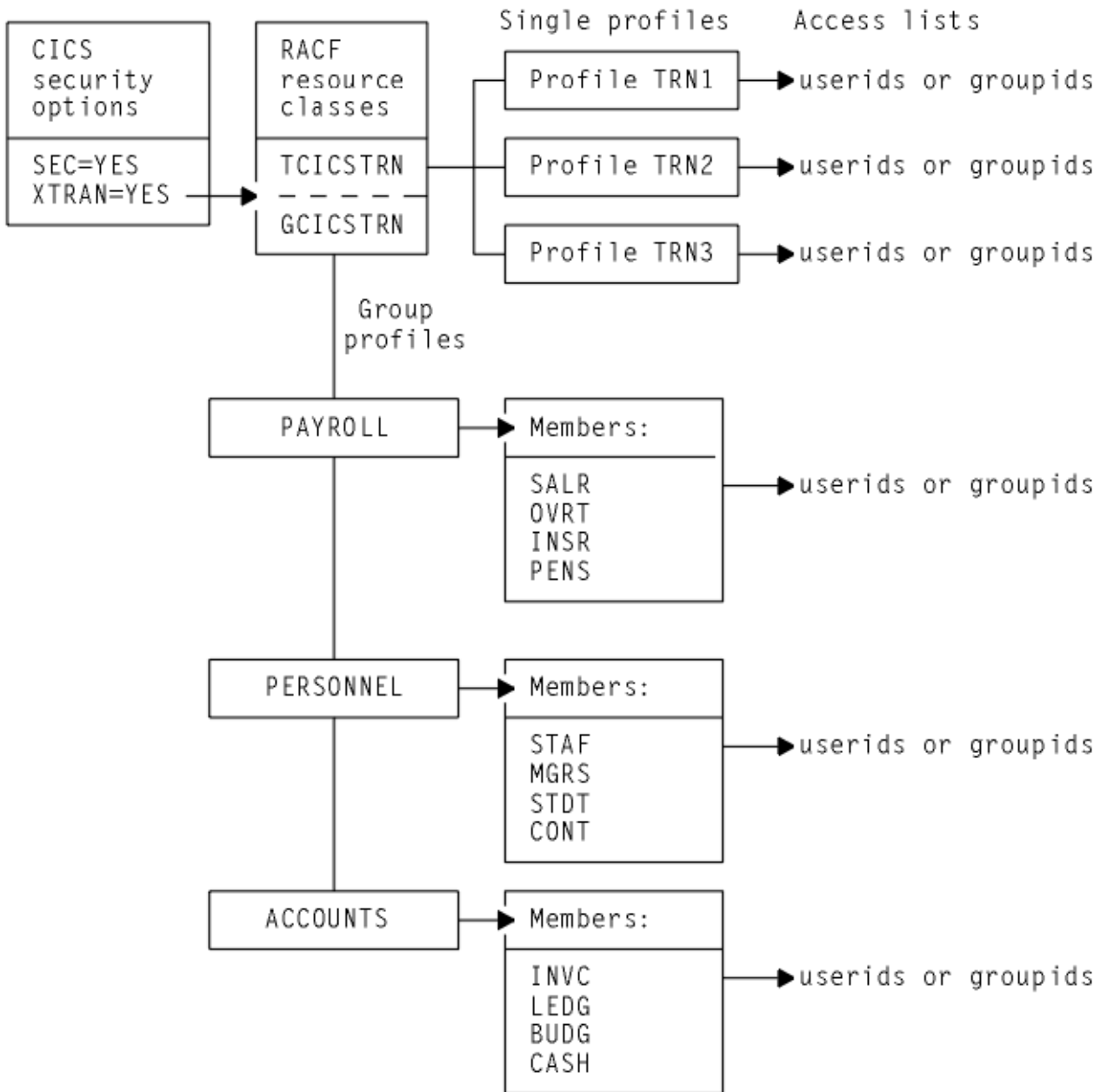

Figure 2. An example of the main elements of CICS transaction security

Transaction-attach processing when SEC=YES and XTRAN=YES

Every time a transaction is initiated at a CICS terminal, CICS issues an authorization request to determine whether the user associated with the terminal is authorized for that transaction.

CICS and RACF process the authorization request using the currently active transaction profiles in the RACF class identified by the XTRAN SIT parameter. (For more information, see [“Refreshing resource profiles in main storage”](#) on page 18.)

Defining transaction profiles to RACF

For those CICS regions running with transaction security checking, define transaction profiles for all transactions that need to be protected from unauthorized access.

About this task

You can define these profiles either in the default transaction resource classes, or in installation-defined classes that you have added to the RACF class descriptor table. (See [“RACF classes for CICS resources”](#) on page 19 for information about the transaction resource classes.)

Some recommendations

The following recommendations are intended to reduce the amount of work involved:

- Define transactions in the resource group class, GCICSTRN. This minimizes the amount of effort needed to define and maintain transaction profiles and their associated access lists, and also keeps down the size of in-storage profiles. However, note that using resource groups only reduces the amount of storage required if you avoid defining duplicate member names.
- Add users to the access list in groups rather than as individual users, and define access as READ.
- Use generic profiles or member names wherever possible.

For example, the following RDEFINE and PERMIT commands illustrate some payroll transactions, with access given to members of the payroll department:

```
RDEFINE GCICSTRN salarytrans
        NOTIFY(pay_manager)
        UACC(NONE) ADDMEM(Pay1, Pay2, Pay3,..., Payn)
PERMIT salarytrans CLASS(GCICSTRN)
        ID(paydept_group_userid) ACCESS(READ)
```

In this example, you could instead define the members generically, such as P* or Pay*.

However, before you define a generic profile you must issue the command:

```
SETROPTS GENERIC(TCICSTRN)
```

You cannot specify the GCICSTRN class, because you cannot group classes with the SETROPTS GENERIC command.

If you have transactions that anyone can use, you can avoid maintaining access lists for them by defining RACF transaction profiles for them with UACC(READ). For example:

```
RDEFINE TCICSTRN tranid UACC(READ)
```

If you want to avoid defining any of your transactions to RACF, you can specify universal access as follows:

```
RDEFINE TCICSTRN ** UACC(READ)
```

You then need to define to RACF only those transactions that require more restrictive security.

Note: If you use a profile like that described in this document, define new profiles to RACF before installing new CICS resources.

Using conditional access lists for transaction profiles

You can add another element of security by making the access list conditional upon the user being signed on at a particular terminal or console.

For example, if the earlier payroll examples are defined as generic transactions in the TCICSTRN class, you could define conditional access as follows:

```
RDEFINE TCICSTRN PAY*
        NOTIFY(pay_manager) UACC(NONE)
PERMIT  pay* CLASS(TCICSTRN) ID(userid) ACCESS(READ)
        WHEN(TERMINAL(terminal))
        WHEN(CONSOLE(*))
```

Note:

1. The TERMINAL or CONSOLE class must be active for this support to take effect.
2. WHEN(TERMINAL(*terminal*)) applies only to explicitly signed-on users, and only in the region where the user is explicitly signed on, and in regions connected to it by MRO links only.
3. CICS uses only the console and terminal ports of entry.

Authorization failures and error messages

If a terminal user tries to initiate an unauthorized transaction, CICS issues a security violation message (DFHAC2033) to the terminal.

CICS then sends a corresponding message (DFHAC2003) to the CSMT transient data destination, and a DFHXS1111 message to CSCS. RACF normally issues an ICH408I message to the CICS region's job log and to the security console (the console defined for routing code 9 messages). However, if the transaction has been defined to RACF with LOG(NONE), no ICH408I message is issued. For a description of the ICH408I message, see [z/OS Security Server RACF Messages and Codes](#).

For more information on resolving authorization problems, see [Problem determination in a CICS-RACF security environment](#).

If auditing (such as that requested by the AUDIT operand) is requested for this access, RACF writes an SMF type 80 log record. Your RACF auditor can use the RACF report writer to generate reports based on these records. For more information, see the [z/OS Security Server RACF Auditor's Guide](#).

Protecting non-terminal transactions

For all resource security checking, CICS needs a userid or an ICRX which maps to a userid to check the user's authority to access the resource.

CICS can protect resources against unauthorized use if those resources are used in transactions that are not associated with a terminal.

Types of non-terminal transactions include the following:

- Transactions started by an **EXEC CICS START** command without a terminal identifier specified
- Transactions started by a **RUN TRANSID** command
- Transactions started without a terminal when the trigger level is reached for an intrapartition transient data queue
- Programs executed from the second phase of the program list table (PLT) during CICS startup

Note: Distributed identity information is not preserved when a **START** command is run with any of the parameters **USERID** or **TERMID**, or is shipped across an LU61 or LU62 connection.

Triggered transactions

The CEDA transaction, the CEDA DEFINE TDQUEUE, the EXEC CICS CREATE, and the ATIUSERID option of the EXEC CICS SET command establish security for non-terminal transactions started by a transient data trigger level.

The user issuing the SET, INSTALL, or CREATE command must have surrogate authority for the userid specified on the ATIUSERID option. The user to be associated with the triggered transaction is specified on the USERID attribute of the transient data queue definition.

PLT programs

If PLT programs are to be executed during CICS startup, CICS performs a surrogate user security check for the region userid. See [“Defining user profiles for CICS region user IDs”](#) on page 32. This check determines whether the CICS job is authorized to be the surrogate of the userid specified on the PLTPIUSR parameter. The PLTPIUSR and PLTPISEC system initialization parameters specify security options for PLT programs that are run from the third stage of CICS startup (which is the second phase of the PLTP initialization).

If the PLTPIUSR parameter is not specified, the PLT programs are run under the CICS region userid when the PLTPISEC=NONE option is defined. No surrogate check is required for this. If your PLT programs issue START commands, the jobstep userid has surrogate authority to start them when no userid is coded. Note that the starter always has surrogate authority to itself. When the started transaction starts up, another check is made to see if the userid has authority to attach the transaction and access this transaction in the TCICSTRN class. Rather than giving the jobstep access to additional resources, you can use the PLTPIUSR and PLTPISEC parameters.

During shutdown, CICS runs PLT programs under the authority of the userid for the transaction that requested the shutdown. The values of the RESSEC and CMDSEC options for that transaction are also applied to the PLT programs. If RESSEC(YES) and CMDSEC(YES) are specified on the definition of the transaction issuing the EXEC CICS PERFORM SHUTDOWN command, security checking is done at the first stage of shutdown.

Resource security

Resource security protects CICS resources against unauthorized access.

Introduction to resource security

Resource security provides a further level of security to transaction security, by controlling access to the resources used by the CICS transactions. A user who is authorized to invoke a particular CICS transaction might not be authorized to access files, PSBs, or other general resources used within the transaction. Unlike transaction security, which cannot be turned off for individual transactions, you can control resource security checking at the individual transaction level.

Resources defined to CICS to support application programming languages are also subject to security checking if resource or command security checking is specified.

You control who can access the general resources used by CICS transactions, by:

- Specifying SEC=YES as a system initialization parameter
- Specifying RESSEC=ALWAYS as a system initialization parameter
- Specifying RESSEC (YES) in the TRANSACTION resource definition
- Specifying the types of resource you want to protect by defining CICS system initialization parameters for the RACF general resource classes
- Defining the CICS resources to RACF in resource class profiles, with appropriate access lists.

For information about the access authorization levels for system programming commands, see [“Resource and command check cross-reference”](#) on page 96.

Security using the XRES resource security parameter

Use security profiles and the **XRES** system initialization parameter to security check a subset of CICS resources. An example of how to implement resource security for CICS document templates is provided.

About this task

A CICS security profile names consist of three parts: *security_prefix.resource_type.resource_name*. CICS profiles are passed to the security manager for checking. Security checking is case sensitive.

Security prefix

The *security_prefix* is the value specified on the **SECPRFX** system initialization parameter. The default value for the **SECPRFX** parameter is NO, which means that the *security_prefix* is omitted. If the value of the **SECPRFX** parameter is YES, the *security_prefix* is the name of the region user ID. Alternatively, you can specify a 1- to 8-character value for the *security_prefix*.

Resource type

The *resource_type* specifies the type of resource against which checks are performed. In most instances, each CICS resource has a corresponding security profile; for example, the ATOMSERVICE resource has a security profile with a corresponding resource type:

```
security_prefix.ATOMSERVICE.resource_name
```

However, certain CICS resources do not have a corresponding security profile; for example, the BUNDLEPART, OSGIBUNDLE, and OSGISERVICE resources are checked using the BUNDLE security profile.

You can create security profiles that use the following resource types:

- ATOMSERVICE
- BUNDLE
- DOCTEMPLATE
- EPADAPTER
- EPADAPTERSET
- EVENTBINDING
- JVMSERVER
- XMLTRANSFORM

For a complete list of the CICS resources, resource types, and commands associated with security checks, see [“Resource and command check cross-reference”](#) on page 96.

Note: When you give a user authority to perform an action on a platform or application, you also give them authority to perform the same action on the dynamically generated resources for the platform or application. CICS resource security checks are not carried out when you create or operate on CICS bundles through an application or platform. However, CICS resource security checks do apply when you perform an action directly on an individual BUNDLE resource, or a resource that was defined in a CICS bundle, even if the bundle was created when you installed a platform or application. For more information, see [Security for bundles](#).

Resource name

The *resource_name* specifies the name of the CICS resource.

Example

This example task explains how to implement resource security for CICS document templates.

CICS document templates are controlled in the following cases:

- Document templates delivered as a static response to a web client request (specified on the `TEMPLATENAME` attribute of the `URIMAP` definition for the request).

- Document templates delivered as part of an application-generated response to a web client request (used by an application program that handles the request).
- All **EXEC CICS CREATE, INQUIRE, DISCARD, and SET DOCTEMPLATE** commands.
- All **EXEC CICS DOCUMENT INSERT and CREATE** commands with the **TEMPLATE** option.

The **EXEC CICS DOCUMENT** commands reference document templates using the 48-character name of the template, as specified in the **TEMPLATENAME** attribute of the **DOCTEMPLATE** resource. However, security checking for these commands uses the name of the **DOCTEMPLATE** resource that corresponds to the **TEMPLATENAME** attribute. So you can set up one profile name for each document template, using the name of the **DOCTEMPLATE** resource, and not the **TEMPLATENAME** attribute.

Note: Document templates can be retrieved from a variety of sources including partitioned data sets, CICS programs, CICS files, z/OS UNIX System Services files, temporary storage queues, transient data queues, and exit programs. When resource security checking is carried out for a document template, CICS does not perform any additional security checking on the resource that supplies the document template, even if resource security is specified for that type of resource in the CICS region.

Complete the following steps to implement resource security for CICS document templates:

1. Define profiles to RACF in the default **RCICSRES** resource class or **WCICSRES** grouping class, or their equivalents if you have user-defined resource class names.

For the profile names, use the name of the **DOCTEMPLATE** resource definition, prefixed by the resource type **DOCTEMPLATE**, and any additional prefix specified by the **SECPRFX** system initialization parameter for the CICS region.

For example, use the following commands to define document templates in the **RCICSRES** class, and authorize users to use them to assemble documents:

```
RDEFINE RCICSRES (DOCTEMPLATE.doc1, DOCTEMPLATE.doc2, .., DOCTEMPLATE.docn) UACC(NONE)
          NOTIFY(sys_admin_userid)
PERMIT DOCTEMPLATE.doc1 CLASS(RCICSRES) ID(group1, group2) ACCESS(READ)
```

To define document templates as members of a profile in the **WCICSRES** resource grouping class, with an appropriate access list, use the following commands:

```
RDEFINE WCICSRES (doc_groupname) UACC(NONE)
          ADDMEM(DOCTEMPLATE.doca, DOCTEMPLATE.docb) NOTIFY(sys_admin_userid)
PERMIT doc_groupname CLASS(WCICSRES) ID(group_userid) ACCESS(READ)
```

After you have issued the **RDEFINE** command for the **RCICSRES** or **WCICSRES** class, if the class is not yet active, you need to activate it by issuing a **SETROPTS** command. For example:

```
SETROPTS CLASSACT(RCICSRES) RACLIST(RCICSRES)
```

If the class is active, refresh it using the **SETROPTS** command:

```
SETROPTS RACLIST(RCICSRES) REFRESH
```

2. Specify **SEC=YES** as a CICS system initialization parameter (and **SECPRFX=YES** if you define profiles with a prefix).
3. Specify **XRES=YES** for the default resource class names of **RCICSRES** and **WCICSRES**, or **XRES=name** for user-defined resource class names.
XRES=YES is the default.
4. Specify **RESSEC(YES)** in the **TRANSACTION** resource definition of the transactions that access the CICS document templates.

For CICS web support, the transaction for all static responses is **CWXN**, or an alternate transaction that you have specified in place of **CWXN** using the **TRANSACTION** attribute on your **TCPIP SERVICE** definitions. The transaction for application-generated responses is an alias transaction, which can be specified in the **URIMAP** definition for the request or set by an analyzer program, and defaults to **CWBA**.

As supplied by CICS, the definition for CWXN specifies RESSEC(YES), but the definition for CWBA specifies RESSEC(NO), and for TRANSACTION resource definitions in general the default is RESSEC(NO).

User IDs for access to document templates and z/OS UNIX files used by CICS Web support

When resource security is active for a transaction, the external security manager checks whether the user ID associated with the transaction is authorized to access the required resources. For CICS Web support, the user ID associated with the transaction for a particular Web request can be obtained from different sources. Depending on the level of security that you require, you can arrange your CICS Web support architecture to determine the user IDs that are used for resource security checking against the secured document templates or z/OS UNIX files.

Application-generated responses

For CICS Web support, the transaction for application-generated responses is an alias transaction, which can be specified in the URIMAP definition for the request or set by an analyzer program, and defaults to CWBA. CWBA is defined as RESSEC(NO), so if you require resource security for the alias transaction, you must either copy the CWBA definition to your own group and change its RESSEC attribute, or use a different alias transaction.

When a Web client makes a request to CICS Web support, and the response is provided by an application, CICS selects a userid for the alias transaction in the following order of priority:

1. A user ID that you set using an analyzer program. This user ID can override a user ID obtained from the Web client or supplied by a URIMAP definition.
2. A user ID that you obtained from the Web client using basic authentication, or a user ID associated with a client certificate sent by the Web client. If authentication is required for the connection but the client does not provide an authenticated user ID, the request is rejected.
3. A user ID that you specified in the URIMAP definition for the request.
4. The CICS default user ID, if no other can be determined.

For application-generated responses, the user ID selected for the Web client applies to the whole alias transaction, and must be authorized to attach the transaction and use the Web application program, as well as to use secured document templates.

Web clients' user IDs do not need specific permissions on z/OS UNIX files for application-generated responses, because applications can only manipulate z/OS UNIX files using EXEC CICS commands when the files are defined as CICS document templates. Security checking is only carried out for the CICS document template, and not again for the z/OS UNIX file.

Static responses

The transaction for all static responses specified in URIMAP definitions is the default Web attach task CWXN, or any alias transaction that you have specified in place of CWXN using the TRANSACTION attribute on your TCPIP SERVICE definitions.

When a Web client makes a request to CICS Web support, and the response is a static response specified in a URIMAP definition, the user ID used for the Web client is a user ID that you obtained from the Web client using basic authentication, or a user ID associated with a client certificate sent by the Web client.

Resource security checking for document templates is controlled by the XRES system initialization parameter and the RESSEC attribute for the transaction (CWXN or its alias). Access control for z/OS UNIX files is controlled by the XHFS system initialization parameter only.

The user ID for the Web client is used only during the process of resource security checking for the document template or z/OS UNIX file that is to be delivered as the static response. The user ID must be authorized to access the document template or z/OS UNIX file.

Resource security checking by CICS and RACF

CICS uses RACF to protect the resources that you can access through a CICS application program.

CICS and RACF resource checking summary

You use the CICS resource system initialization parameters to specify the RACF class name.

Each resource is described briefly in Table 8 on page 74, with the associated CICS system initialization parameter that you use to specify the RACF class name. For comprehensive information about application programming commands and system programming commands associated with each system initialization parameter, see [“Resource and command check cross-reference”](#) on page 96.

No authorization processing is done for BMS commands.

<i>Table 8. General resource checking by CICS</i>		
CICS parameter	Resource protected	Further information
XAPPC	Partner logical units (LU6.2).	“Implementing LU6.2 security” on page 222.
XCMD	The subset of CICS application programming commands that are subject to command security checking. EXEC CICS FEPI system commands are also controlled by this parameter.	“CICS command security” on page 118
XDB2	DB2 resource classes for DB2ENTRY are specified to CICS on the XDB2 system initialization parameter.	“Resource classes for DB2ENTRYs” on page 22
XDCT	CICS extrapartition and intrapartition transient data queues. Define profiles in the transient data class to control who is allowed to access CICS transient data queues.	“Security for transient data” on page 77.
XFCT	CICS file-control-managed VSAM and BDAM files. Define profiles in the file class to control who is allowed to access CICS VSAM and BDAM files.	“Security for files” on page 79.
XHFS	z/OS UNIX files managed by z/OS UNIX System Services. This is a special case, because access controls for z/OS UNIX files are specified in z/OS UNIX System Services, so z/OS UNIX files do not require individual RACF profiles. No application programming commands or system programming commands are associated with this resource.	“Implementing security for z/OS UNIX files” on page 88.
XJCT	CICS system log and general logs. Define profiles in the journal class to control who is allowed to access CICS journals on CICS log streams.	“Security for journals and log streams” on page 80.
XPCT	CICS started transactions and EXEC CICS commands: COLLECT STATISTICS TRANSACTION, DISCARD TRANSACTION, INQUIRE TRANSACTION, INQUIRE REQID, SET TRANSACTION, and CANCEL . Define profiles in the started-transactions class to control who is allowed access to started CICS transactions.	“Security for started transactions” on page 81.
XPPT	CICS application programs. Define profiles in the program class to control who is allowed to access CICS application programs.	“Security for application programs” on page 85.

Table 8. General resource checking by CICS (continued)

CICS parameter	Resource protected	Further information
XPSB	DL/I program specification blocks (PSBs). Define profiles in the program specification block class to control who is allowed to access the DL/I PSBs used in CICS application programs.	“Security for program specification blocks” on page 90.
XRES	CICS resources that use the XRES parameter are: ATOMSERVICE, BUNDLE, DOCTEMPLATE, EPADAPTER, EPADAPTERSET, EVENTBINDING, JVMSERVER, and XMLTRANSFORM. For example, define profiles in the DOCTEMPLATE resource class to control who is allowed to access document templates.	“Security using the XRES resource security parameter” on page 71.
XTRAN	CICS transactions.	“Transaction security” on page 66.
XTST	CICS temporary storage queues. Define profiles in the temporary storage class to control who is allowed to access CICS temporary storage queues.	“Security for temporary storage” on page 86.
XUSER	Surrogate user security.	“Surrogate user security” on page 113.

RESSEC transaction resource security parameter

Specifying RESSEC(YES) in the definition of a transaction, together with the appropriate resource classes defined in the system initialization parameters, introduces another layer of security checking in addition to transaction-attach security.

For most simple (or single-function) transactions, this extra layer of security is not necessary. For example, if the transaction is designed to enable the terminal user to update a personnel file and nothing else, it should be sufficient to authorize access to the transaction without controlling access to the file also. However, if you have a complex transaction that offers users a choice of functions, or you are unsure about all the options available within a transaction, you may want to add the extra layer of security to restrict access to the data as well as to the transaction. Before implementing resource security checking, take into account the extra overhead that resource security checking involves, and only implement it if you believe the extra cost is worthwhile.

If you specify RESSEC(YES) on a transaction definition, CICS calls RACF for each CICS command (or in the case of z/OS UNIX files, each operation) that applies to one of the following resources, for which you have requested security, using an *Xname* resource class parameter:

- Extrapartition and intrapartition transient data queues (XDCT parameter)
- File-control-managed VSAM and BDAM files (XFCT parameter)
- System logs and general log (XJCT parameter)
- Started transactions and EXEC CICS commands: COLLECT STATISTICS TRANSACTION, DISCARD TRANSACTION, INQUIRE TRANSACTION, INQUIRE REQID, SET TRANSACTION, and CANCEL (XPCT parameter)
- Application programs (XPPT parameter)
- Resources subject to XRES security checks (XRES parameter), as listed in [“Security using the XRES resource security parameter” on page 71.](#)
- Temporary storage destinations (XTST parameter)

The system initialization parameters include:

```
SEC=YES
XDCT=NO
XFCT=YES
XTRAN=YES
XTST=YES
```

Transaction TRN1 contains the following EXEC CICS commands:

- 4 file control READ commands
- 1 file control WRITE command
- 2 transient data WRITEQ commands
- 1 temporary storage WRITEQ command

When TRN1 executes, the seven calls are made to RACF:

- 1 at transaction attach, because XTRAN=YES is specified
- 5 for file control access, because XFCT=YES is specified
- 1 for temporary storage access, because XTST=YES is specified

RACF is not called for transient data queue access, because XDCT=NO is specified.

The RESSEC system initialization parameter

You can force the effect of RESSEC=YES for all CICS transactions by specifying the RESSEC=ALWAYS system initialization parameter.

In general, this is not recommended, for the following reasons:

- For most simple transactions, just controlling access to the transaction is enough to control everything that the transaction can do.
- Invoking a resource check for every CICS resource consumes extra overhead that reduces the performance of all your transactions.
- Some CICS-supplied transactions may access resources of which you are unaware. It is your responsibility to ensure that users of these transactions are given enough authority to allow the transactions to continue to work.

Authorization failures

If a terminal user is not authorized to access the resource specified on a CICS command, CICS returns the NOTAUTH condition to the application program.

CICS indicates this authorization failure by setting the EIBRESP field of the EXEC interface block (DFHEIBLK) to a value of 70 (and X'46' in byte 0 of the EIBRCODE field). Design your CICS applications to handle security violations by passing control to an appropriate routine. They can do this in either of the following ways:

- Test the EIBRESP condition by adding the RESP option to each command that may receive a NOTAUTH condition. For example (in COBOL):

```
EXEC CICS FILE('FILEA')
      INTO(REC) RIDFLD(KEY)
      RESP(COMMAND-RESPONSE)
END-EXEC.

EVALUATE COMMAND-RESPONSE
  WHEN DFHRESP(NORMAL)
    CONTINUE
  WHEN DFHRESP(NOTAUTH)
```

```
PERFORM SECURITY-ERROR
END-EVALUATE.
```

- Code an EXEC CICS HANDLE CONDITION NOTAUTH(*label*) command, where *label* is the name of the security violation routine.

If an application does not cater for security violations, CICS abends the transaction with an AEY7 abend code.

Logging RACF audit messages to SMF

Except when processing certain security commands (see “Security checking using the QUERY SECURITY command” on page 130), CICS issues security authorization requests with the logging option. This means that RACF writes SMF type 80 log records to SMF. Which events are logged depends on the auditing in effect. For example, events requested by the AUDIT or GLOBALAUDIT operand in the resource profile, or by the SETROPTS AUDIT or SETROPTS LOGOPTIONS command, can be logged.

In addition to the SMF TYPE 80 log record, RACF issues an ICH408I message to consoles designated to receive messages for route code 9.

For more information on auditing, including how to use the RACF report writer to review SMF type 80 log records, see the [z/OS Security Server RACF Auditor's Guide](#).

Use of the WARNING option

The RACF WARNING option, if used on RACF profiles, is honored by CICS. The WARNING option allows users access to resources that otherwise would be denied. RACF logs to SMF those accesses that would have failed had WARNING not been in effect.

The selective use of WARNING can be particularly useful during the initial implementation of resource security for an application, as a means of checking for errors or omissions in the RACF security definitions. When WARNING results in an SMF type 80 record being recorded, you should verify whether the user should be added to the access list for the resource, and modify the RACF profiles accordingly. You should strictly limit the time during which resources are accessed with the warning option in force, and keep logging to a minimum during the warning period.

Note: Specify the NOTIFY option, if you want to be notified at once when access is denied to a user.

Security for transient data

Follow this procedure to implement security for transient data queues.

Procedure

1. Specify RESSEC(YES) in the resource definition of the appropriate transactions.
2. Define profiles to RACF in the DCICSDCT or ECICSDCT resource classes (or their equivalent if you have user-defined resource class names), with access lists as appropriate.

Transient data queue names are a maximum of 4 characters in length, such as CSMT, L86O, L86P, and so on.

For example, use the following commands to define queues in the DCICSDCT class, and to authorize users to both read from and write to these queues:

```
RDEFINE DCICSDCT (qid1, qid2, ..., qidn) UACC(NONE)
                                NOTIFY(sys_admin_userid)
PERMIT qid1 CLASS(DCICSDCT) ID(group1, group2) ACCESS(UPDATE)
PERMIT qid2 CLASS(DCICSDCT) ID(group1, group2) ACCESS(UPDATE)
```

To define transient data queues as members of a profile in the CICS transient data resource group class, with an appropriate access list, use the following commands:

```
RDEFINE ECICSDCT (queue_groupname) UACC(NONE)
                                ADDMEM(qida, qidb, ..., qidz) NOTIFY(sys_admin_userid)
PERMIT queue_groupname CLASS(ECICSDCT) ID(group_userid) ACCESS(UPDATE)
```

See also [“Considerations for defining profiles for transient data queues”](#) on page 78.

3. Specify SEC=YES as a CICS system initialization parameter (and SECPRFX if you define profiles with a prefix).
4. Specify XDCT=YES for the default resource class names of DCICSDCT and ECICSDCT (or XDCT=class_name for user-defined resource class names).

Considerations for defining profiles for transient data queues

When you are defining profile names to RACF to control access to transient data queues, define profiles only for:

- intrapartition transient data queues
- extrapartition transient data queues

Do not define profiles for indirect transient data queues; CICS directs all requests for an indirect queues to another queue, which can be extrapartition, intrapartition, or remote. The redirection can also be to another indirect queue.

If you are running CICS with security checking for transient data queues, CICS issues a call to RACF for each command that specifies a queue name. However, the resource name that CICS passes to RACF is the queue name of the final queue, which is not necessarily the name of the queue specified on the command.

For example, if an EXEC CICS command specifies queue QID2, which is defined as indirect to QID1, CICS calls RACF for an authorization check on QID1, not QID2. This is illustrated as follows:

```
TDQ definition: DEFINE TDQUEUE(QID1)
                  TYPE(EXTRA)
                  TYPEFILE(OUTPUT)
                  RECORDSIZE(132)
                  BLOCKSIZE(136)
                  RECORDFORMAT(VARIABLE)
                  BLOCKFORMAT(UNBLOCKED)
                  DDNAME(CICSMSG)
                  GROUP(DFHDTG)

                  DEFINE TDQUEUE(QID2)
                      TYPE(INDIRECT)
                      INDIRECTNAME(QID1)
                      GROUP(DFHDTG)

CICS transaction: EXEC CICS WRITEQ TD
                  QUEUE(QID2)
                  FROM(data_area)
                  LENGTH(length)

CICS calls RACF:  Does the terminal user of the CICS transaction
                  have UPDATE authorization for QID1?
```

Access authorization levels

You can read an item from a transient data queue only once, because whenever you read from a transient data queue, CICS deletes the entry (by performing a "destructive read").

Therefore, if you specify security with SEC=YES as a system initialization parameter, CICS requires a minimum authorization level of UPDATE for all TD commands (DELETEQ, WRITEQ, and READQ).

For information about the access authorization levels for system programming commands which apply to transient data queues, see [“Resource and command check cross-reference”](#) on page 96.

CICS-required transient data queue resource definitions

CICS itself uses a number of transient data queues. These queues are defined in group DFHDCTG, which is part of DFHLIST. If you want to protect access to these definitions from user application programs, define them to RACF with UACC(NONE) and without an access list.

In the supplied resource definitions, most of the transient data queues are indirect, pointing to the transient data queues CSSL or CCSO. If you use the definitions as supplied, define to RACF only the queue names CSSL and CCSO, as follows:

```
RDEFINE ECICSDCT CICSQUEUES UACC(NONE)
                ADDMEM(CSSL, CCSO)
                NOTIFY(sys_admin_userid)
```

Considerations for triggered transactions

For intrapartition transient data queues with a trigger level greater than zero, CICS obtains the user ID associated with the triggered transaction from the following sources:

- For a transient data queue defined with ATIFACILITY(FILE), CICS uses the USERID parameter specified in the resource definition for the transient data queue.
- For a transient data queue defined with ATIFACILITY(TERMINAL), CICS uses the user ID associated with the terminal. This can be the CICS default userid if no user is signed on at the terminal.
- For a transient data queue defined with ATIFACILITY(SYSTEM), CICS uses the link user ID obtained by the CONNECTION resource definition.

Security for files

CICS application programs process files, which, to CICS, are logical views of physical VSAM or BDAM data sets.

You identify a file to CICS by an 8-character file name, and you can define many files to CICS that refer to the same physical data set, which is separately identified by a 44-character data set name (DSNAME). For example, you can define file resource definitions called FILEA, FILEB, and FILEC, all of which refer to one physical VSAM data set, but with each file definition specifying different attributes.

CICS transactions access the data in physical data sets using the CICS file control name. Therefore, you control access to CICS-managed files by defining profiles in the RACF general resource classes for CICS files, not in the RACF data set class. You define the profiles using the CICS 8-character file name to identify the resource. (RACF data set authorization based on the 44-character data set name is used only during OPEN processing, to determine whether the CICS region userid is authorized to access the data set for which the OPEN has been requested. This does not depend on the userid running the transaction that caused the OPEN to be performed.)

To implement security for files managed by CICS file control:

1. Specify RESSEC(YES) in the CSD resource definition of the transactions that access the files.
2. Define profiles to RACF in the FCICSFCT or HCICSFCT resource classes (or their equivalent if you have user-defined resource class names), using the CICS file names to identify the profiles. For example, use the following commands to define files in the FCICSFCT class, and authorize users to read from or write to the files:

```
RDEFINE FCICSFCT (file1, file2, .., filen) UACC(NONE)
                NOTIFY(sys_admin_userid)
PERMIT file1 CLASS(FCICSFCT) ID(group1, group2) ACCESS(UPDATE)
PERMIT file2 CLASS(FCICSFCT) ID(group1, group2) ACCESS(READ)
```

To define files as members of a profile in the CICS file resource group class, with an appropriate access list, use the following commands:

```
RDEFINE HCICSFCT (file_groupname) UACC(NONE)
                ADDMEM(filea, fileb, ..., filez) NOTIFY(sys_admin_userid)
PERMIT file_groupname CLASS(HCICSFCT) ID(group_userid) ACCESS(UPDATE)
```

3. Specify SEC=YES as a CICS system initialization parameter (and SECPRFX if you define profiles with a prefix).
4. Specify XFCT=YES for the default resource class names of FCICSFCT and HCICSFCT (or XFCT=class_name for user-defined resource class names).

Note that RDO transactions do not use file commands to access the CSD, and are not, therefore, subject to these mechanisms.

Access authorization levels

If you specify security with SEC=YES as a system initialization parameter, CICS requires a level of authorization appropriate to the file access intended: a minimum of READ for read intent, and a minimum of UPDATE for update or delete intent.

For information about the access authorization levels for system programming commands which apply to files, see [“Resource and command check cross-reference”](#) on page 96.

Security for journals and log streams

The CICS log manager provides facilities to write to and read from the CICS system log and CICS general logs. General logs comprise user journals, forward recovery logs, and autojournals. You can implement security for journals and log streams to protect them from unauthorized access.

The system log is used only for recovery purposes; for example, during dynamic transaction backout, or during emergency restart. Do not use it for any other purpose. Do not, therefore, write to it from a user application using the [WRITE JOURNALNAME](#) command.

CICS uses journal identifier **DFHLOG** for its primary system log. Do not permit user transactions to write to this. You can prevent them doing so by using the following command to define the system log in the JCICSJCT class, without any access list:

```
RDEFINE JCICSJCT DFHLOG UACC(NONE) NOTIFY(sys_admin_userid)
```

In addition to the automatic journaling and forward recovery logging that CICS performs for user transactions (depending on the options in the file resource definitions), user applications can also write user journal records using the **WRITE JOURNALNAME** command.

Users needing to write journal records must have authority to write to the JOURNALNAME (as defined in JCICSJCT). CICS calls RACF to perform a security check only for attempts to access a user journal by a CICS API command, and not for the journaling it performs in response to journaling options in the file resource definition. The CICS API does not provide a READ command for reading journals from a CICS transaction. For this reason, with proper exercise of control over the installation of applications on your CICS systems, you might consider it unnecessary to add RACF protection for journals that cannot be read from within CICS.

If you decide to implement security for CICS journals:

1. Specify RESSEC(YES) in the CSD resource definition of the transactions that write to journals.
2. Define profiles to RACF in the JCICSJCT or KCICSJCT resource classes (or their equivalent if you have user-defined resource class names) using the CICS journal name to identify the profiles.

To define journals as members of a profile in the journal resource group class, with an appropriate access list, use the following commands:

```
RDEFINE KCICSJCT userjnl UACC(NONE)
                ADDMEM(JRNL001, JRNL002, ...)
                NOTIFY(sys_admin_userid)
PERMIT userjnl CLASS(KCICSJCT) ID(group_userid) ACCESS(UPDATE)
```

3. Specify YES on the **SEC** system initialization parameter, and YES on the **SECPRFX** if you define profiles with a prefix. CICS requires a minimum authorization of UPDATE for journal access. For information about the access authorization levels for system programming commands that apply to journals, see “Resource and command check cross-reference” on page 96.
4. Specify YES on the **XJCT** system initialization parameter for the default resource class names of JCICSJCT and KCICSJCT, or XJCT=*class_name* for user-defined resource class names. For more information, see [XJCT system initialization parameter](#).

Transactions that use WRITE JOURNALNUM command

The `WRITE JOURNALNUM` command is supported in CICS Transaction Server for z/OS, Version 5 Release 4 for compatibility with earlier releases: the `WRITE JOURNALNAME` command is preferred for new applications. If resource security applies to a transaction executing `WRITE JOURNALNUM`, the journal number is prefixed with 'DFHJ' before the security check is applied. Thus, writing to journal number 2 requires UPDATE access to the resource DFHJ02.

Security for started transactions

A CICS transaction can start other transactions by means of an **EXEC CICS START** command. Transactions started in this way are known as **started transactions**, and you can use CICS RACF security to control who can start other transactions using the **START** command.

When a transaction issues an **EXEC CICS START TRANSID** command, CICS calls RACF to check that the user of the transaction that issues the command is authorized for the started transaction.

To implement security for started transactions and for transactions checked against the XPCT class:

1. Specify SEC=YES as a CICS system initialization parameter (and SECPRFX if you define profiles with a prefix).
2. Specify RESSEC(YES) in the CSD resource definition of the transactions that issue **START** commands.
3. Specify XPCT=YES for the default resource class names of ACICSPCT and BCICSPCT (or XPCT=*class_name* for user-defined resource class names).

This ensures that when a transaction is started by a **START** command, CICS calls RACF to check that the userid associated with the transaction is authorized to attach the transaction.

4. Define profiles to RACF in the ACICSPCT or BCICSPCT resource classes (or their equivalent if you have user-defined resource class names) using the name of the started transaction to identify the profiles.

For example, use the following commands to define a transaction in the ACICSPCT class, and to authorize one user only:

```
RDEFINE ACICSPCT (tran1, tran2, ..., tranN) UACC(NONE)
          NOTIFY(sys_admin_userid)
PERMIT tran1 CLASS(ACICSPCT) ID(userid) ACCESS(READ)
PERMIT tran2 CLASS(ACICSPCT) ID(userid) ACCESS(READ)
```

To define started transactions as members of a profile in the started transaction resource group class, with an appropriate access list, use the following commands:

```
RDEFINE BCICSPCT started_trans UACC(NONE)
          ADDMEM(trana, tranb, ..., tranx)
          NOTIFY(sys_admin_userid)
PERMIT started_trans CLASS(BCICSPCT) ID(group_userid) ACCESS(READ)
```

5. Specify XTRAN=YES for the default resource class names of TCICSTRN and GCICSTRN (or XTRAN=*class_name* for user-defined resource class names).
6. Define profiles to RACF in the TCICSTRN or GCICSTRN resource classes (or their equivalent if you have user-defined resource class names) using the name of the started transaction to identify the profiles.

Transactions started at terminals

The [START](#) enables a CICS application program to start another transaction associated with a terminal other than the one from which the start command is issued. For example, the following command issued in CICS transaction `tranid1`, invoked at `termid1`, starts another transaction called `tranid2` at `termid2`:

```
EXEC CICS START
      TRANSID(tranid2)
      AT HOURS('18') MINUTES('50')
      TERMID(termid2)
```

When a `TERMID` is specified for the started transaction, CICS performs a transaction-attach security check, using the classes `TCICSTRN` and `GCICSTRN`, on the `userid` associated with the terminal (`termid2` in this example). You must therefore ensure that the `userid` associated with the terminal (`termid2`) is authorized to invoke the transaction. This `userid` is that of the signed-on user, or the CICS default `userid` if no user is signed on. If `termid2` is **not** authorized, message `DFHAC2033` is issued to the user of `termid2`. The user of the terminal that issued the `START` command gets a "normal" response. If the started transaction is defined with `RESSEC(YES)`, also ensure that the `userid` associated with the terminal (`termid2` in this example) is suitably authorized to access protected resources.

Starting tasks at terminals defined with preset security

Typically, started transactions associated with a terminal are printing tasks, where the specified terminal is a printer.

In this case, to associate a specific `userid` with the terminal, you define the terminal with preset security. See [“Preset terminal security” on page 59](#) for more information.

Transactions started without terminals

The `EXEC CICS START` command enables a CICS application program to start another transaction that is not associated with any terminal. When no `TERMID` is specified for the started transaction, the `userid` associated with the new transaction depends on whether you also specify the `USERID` option.

Userid of a non-terminal started transaction

The `USERID` option of the [START](#) command (or the terminal user if no `TERMID` or `USERID` is included in the `START` command) determines the `userid` for a non-terminal started transaction. Without the `USERID` option, the non-terminal started transaction has the same `userid` as the transaction that executed the `START` command. If the `USERID` option is specified on the `START` command, the specified `userid` is used instead.

When an `START` command is executed without the `TERMID` option, CICS performs a surrogate user check to ensure that the transaction is authorized for the `userid` to be used by the non-terminal started transaction. For information about the link authorization of surrogate users, see [“Intercommunication link security” on page 220](#). For information about EDF authorization of surrogate users, see [“Conditional access processing” on page 57](#).

Note: Distributed identity information is not preserved when a **START** command is run with any of the parameters: **USERID**, **TERMID**, or **RTERMID**, or is shipped across an LU61 or LU62 connection.

Access to resources by a non-terminal started transaction

If the `USERID` option is not specified on the [STARTBROWSE PROCESS](#) command, the non-terminal started transaction does not always inherit all of the security of the transaction that executed the command. Also, it does not inherit resource access determined by link security, or resource access determined by a `userid` for EDF when used in dual-screen mode. This means:

- If a transaction-routed transaction executes a `START` command, or if a `START` command is function shipped, the non-terminal started transaction is not subject to link security.
- If EDF is used in dual-screen mode for a transaction that issues a `START` command, the non-terminal started transaction is not subject to resource access determined by the `userid` of the EDF terminal.

If you want the started transaction to have exactly the same security capabilities as the starting transaction, omit the USERID option. Without the USERID option, resource access by the non-terminal started transaction is determined by the sign-on parameters of the terminal transaction. These include the RACF group and the port of entry at which the terminal user signed on; that is, the terminal or console used to sign on, as shown in the following example:

A terminal user signs on using the CESN transaction at a terminal with netname NETNAMEX. For RACF, therefore, the port of entry is NETNAMEX. At the CESN screen the terminal user enters userid USERID1, and groupid GROUPID2. The terminal user then runs a terminal transaction which executes an EXEC CICS START command without the TERMID option or the USERID option specified. The non-terminal started transaction has resource access determined by userid USERID1, groupid GROUPID2, and port of entry NETNAMEX.

If a non-terminal transaction is denied access to a resource by RACF, the error message produced can include the terminal sign-on parameters, userid, and groupid. It can also include a port of entry. The userid, groupid, and port of entry can be those inherited from the terminal transaction that started the non-terminal transaction.

If the USERID option is specified on a START command, the non-terminal started transaction has access to resources determined by the userid specified on the USERID option.

We recommend that you do not specify the current userid of a terminal transaction on the USERID option. The non-terminal started transaction may not have the same resource access as the terminal transaction. The following examples show how the non-terminal started transaction can have different resource access:

Example 1

RACF conditional access lists can be used by specifying WHEN(TERMINAL(...)) or WHEN(CONSOLE(...)) on the RACF PERMIT command to allow a terminal transaction access to certain resources because the specified port of entry is in use. See [“Conditional access processing” on page 57](#).

If a START TRANSID USERID command is executed by a terminal transaction specifying the same userid that the terminal user entered when signing on with CESN, the started transaction has access to resources determined by the specified userid, but not to the resources determined by the port of entry.

The started transaction is not subject to the conditional access list effective for the terminal transaction that executed the EXEC CICS START USERID command.

Example 2

Using RACF you can grant (or deny) group access to a RACF protected resource.

A terminal user can enter a groupid and a userid when signing on with CESN. When the terminal user runs a terminal transaction, the groupid can determine resource access.

If a START TRANSID USERID command is executed by a terminal transaction specifying the same userid as that entered by the terminal user when signing on with CESN, the started transaction has access to resources determined by the specified userid. Resource access is not determined by the groupid that the terminal user entered when signing on with CESN. Resource access for the non-terminal started transaction can be determined by the default groupid for the specified userid.

The started non-terminal transaction is not subject to the group access effective for the terminal transaction that executed the START USERID command.

Access authorization levels

CICS requires a minimum authorization of READ for started transactions.

For information about the access authorization levels for system programming commands which apply to transactions, see [“Resource and command check cross-reference” on page 96](#).

Security for transactions started with EXEC CICS RUN TRANSID

A CICS transaction can initiate other transactions by means of an **EXEC CICS RUN TRANSID** command. You can use CICS RACF security to control who can initiate other transactions using the **RUN TRANSID** command.

When a transaction issues an **EXEC CICS RUN TRANSID** command, CICS calls RACF to check that the user of the transaction issuing the command is authorized for the started transaction.

To implement security for asynchronous transactions, you need to do the following:

1. Specify SEC=YES as a CICS system initialization parameter (and SECPRFX if you define profiles with a prefix).
2. Specify RESSEC(YES) in the CSD resource definition of the parent transactions that issue **EXEC CICS RUN TRANSID** commands.

This ensures that when a child transaction is started by an **EXEC CICS RUN TRANSID** command, CICS calls RACF to check that the userid associated with the transaction is authorized to attach the transaction.

3. Specify XPCT=YES for the default resource class names of ACICSPCT and BCICSPCT (or XPCT=class_name for user-defined resource class names).
4. Define profiles to RACF in the ACICSPCT or BCICSPCT resource classes (or their equivalent if you have user-defined resource class names) using the name of the started child transaction to identify the profiles.
5. Specify XTRAN=YES for the default resource class names of TCICSTRN and GCICSTRN (or XTRAN=class_name for user-defined resource class names).
6. Define profiles to RACF in the TCICSTRN or GCICSTRN resource classes (or their equivalent if you have user-defined resource class names) using the name of the started child transaction to identify the profiles.

Userid of a transaction started using EXEC CICS RUN TRANSID

A child transaction started by the **EXEC CICS RUN TRANSID** command runs under the USERID of the parent transaction which issued the command.

Access to resources by transactions started using EXEC CICS RUN TRANSID

- If a transaction-routed parent transaction executes an **EXEC CICS RUN TRANSID** command, the started child transaction is not subject to link security.
- If EDF is used in dual-screen mode for a transaction that issues an **EXEC CICS RUN TRANSID** command, the started transaction is not subject to resource access determined by the userid of the EDF terminal.

Access authorization levels

CICS requires a minimum authorization of READ for transactions started by an **EXEC CICS RUN TRANSID** command.

Security for XPCT-checked transactions

The **XPCT** system initialization parameter specifies whether CICS performs transaction resource security checking on transactions started by **EXEC CICS** commands, such as **EXEC CICS START** and **EXEC CICS RUN TRANSID**. Transactions defined in the ACICSPCT and BCICSPCT resource class profiles will be subjected to XPCT security checking.

These profiles also control access to transactions specified in certain other **EXEC CICS** commands, if the transaction issuing the command is defined with RESSEC(YES). The **EXEC CICS** commands affected by XPCT-checking are:

- START

- COLLECT STATISTICS TRANSACTION
- DISCARD TRANSACTION
- INQUIRE TRANSACTION
- SET TRANSACTION
- INQUIRE REQID
- CANCEL
- RUN TRANSID

Security for application programs

You control access to the initial program specified in the transaction resource definition by authorizing the user to initiate the transaction (transaction-attach security).

However, CICS application programs can invoke other programs by means of the LINK, LOAD, and XCTL commands. Also, the load status of programs can be altered by the CICS RELEASE, ENABLE, and DISABLE commands. Note, however, that there is no separate security check on the RELEASE of programs loaded for task lifetime. This is done on the corresponding LOAD.

You control access to programs invoked using these commands by defining profiles in the CICS application program classes, and which you define to CICS on the XPPT system initialization parameter.

To control which users can invoke or change the load status of other programs:

1. Specify RESSEC(YES) in the CSD resource definition of the transactions that use the LINK, LOAD, XCTL, CICS RELEASE, ENABLE or DISABLE commands.
2. Define profiles to RACF in the MCICSPPT or NCICSPPT resource classes (or their equivalent if you have user-defined resource class names) using the name of the program invoked on the LINK, LOAD, or XCTL command to identify the profiles.

For example, use the following commands to define a program in the MCICSPPT class, and to authorize one user only:

```
RDEFINE MCICSPPT (prog1, prog2, ..., progn) UACC(NONE)
              NOTIFY(sys_admin_userid)
PERMIT prog1 CLASS(MCICSPPT) ID(userid) ACCESS(READ)
PERMIT prog2 CLASS(MCICSPPT) ID(userid) ACCESS(READ)
```

To define programs as members of a profile in the application program resource group class, with an appropriate access list, use the following commands:

```
RDEFINE NCICSPPT cics_programs UACC(NONE)
              ADDMEM(proga, progb, ..., progx)
              NOTIFY(sys_admin_userid)
PERMIT cics_programs CLASS(NCICSPPT) ID(group_userid) ACCESS(READ)
```

3. Specify SEC=YES as a CICS system initialization parameter (and SECPRFX if you define profiles with a prefix).
4. Specify XPPT=YES as a CICS system initialization parameter for the default resource class names of MCICSPPT and NCICSPPT (or XPPT=class_name for user-defined resource class names).

Exception for distributed program link (DPL) commands

If CICS finds that a program referenced on a **LINK** command is a remote program, it does not perform the security check in the region in which the link command is issued. The security check is performed only in the CICS region in which the linked-to program finally executes.

For example, if CICS function ships a DPL command to CICSB, where the program then executes, CICSB issues the security check. If the DPL request is function shipped again to CICS for execution, it is CICS that issues the security check.

Access authorization levels

CICS requires a minimum authorization of READ for programs.

For information about the access authorization levels for system programming commands which apply to programs, see [“Resource and command check cross-reference”](#) on page 96.

Security for temporary storage

Unlike the other resources for which you specify RESSEC(YES), temporary storage queues, for which you require RACF protection, also require the security attribute in a suitable TSMODEL resource definition.

You specify TSMODEL definitions in the CSD. See [TSMODEL resources](#) for information about TSMODEL resource definitions.

Implementing security for temporary storage queues

To implement security for temporary storage queues:

1. Specify RESSEC(YES) in the CSD resource definition of the appropriate transactions.
2. Specify the security attribute on suitable TSMODEL resource definitions. CICS does not perform any security checks on temporary storage queues that specify SECURITY=NO on the matching TSMODEL definition.
3. Define profiles to RACF in the SCICSTST or UCICSTST resource classes (or their equivalent if you have user-defined resource class names), with access lists as appropriate. For example, use the following commands to define queues in the SCICSTST class, and to authorize users to both read from and write to these queues:

```
RDEFINE SCICSTST (tsqueue1, tsqueue2, ..., tsqueuen) UACC(NONE)
                NOTIFY(sys_admin_userid)
PERMIT tsqueue1 CLASS(SCICSTST) ID(group1, group2) ACCESS(UPDATE)
PERMIT tsqueue2 CLASS(SCICSTST) ID(group1, group2) ACCESS(UPDATE)
```

To define temporary storage queues as members of a profile in the CICS temporary storage resource group class, with an appropriate access list, use the following commands:

```
RDEFINE UCICSTST tsqueue_group UACC(NONE)
                ADDMEM(tsqueuea, tsqueueb, ..., tsqueuex)
                NOTIFY(sys_admin_userid)
PERMIT tsqueue_group CLASS(UCICSTST) ID(group_userid) ACCESS(UPDATE)
```

For more information about defining temporary storage profiles, see [“Other temporary storage security considerations”](#) on page 86.

4. Specify SEC=YES as a CICS system initialization parameter (and SECPRFX if you define profiles with a prefix).
5. Specify XTST=YES as a CICS system initialization parameter for the default resource class names of SCICSTST and UCICSTST (or XTST=class_name for user-defined resource class names).

Other temporary storage security considerations

You can define the queue names on the PREFIX attribute of the TSMODEL resource definition as follows:

- By specifying a fully identified name that exactly matches the queue name specified on a READQ TS or WRITEQ TS command. This can be from 1 to 16 alphanumeric characters.
- By specifying a generic name, or prefix, that corresponds to the leading alphanumeric characters of a set of queue names.

It follows that a prefix can only be from 1 to 15 characters, because if you specify the full 16 characters for a queue name, it must be the name of a specific temporary storage queue.

When a CICS application issues a temporary storage command (for example, DELETEQ TS, READQ TS, or WRITEQ TS) and temporary storage security is in effect, CICS searches for a TSMODEL resource definition that corresponds to the leading characters of the queue name.

Note that if you include hexadecimal characters in a temporary storage queue name, unpredictable results may occur. Also, if a temporary storage queue name contains an imbedded blank, RACF truncates the resource name to that blank.

Access authorization levels

If you specify security with SEC=YES as a system initialization parameter, CICS requires a level of authorization appropriate to the temporary storage queue access intended, for example, a minimum of READ for READQ TS, and a minimum of UPDATE for DELETEQ TS and WRITEQ TS.

For information about the access authorization levels for system programming commands which apply to temporary storage queues, see [“Resource and command check cross-reference”](#) on page 96.

Security for z/OS UNIX files

Files stored in the z/OS UNIX System Services file system can be used to supply Web pages through CICS Web support, as static responses provided by URIMAP definitions. When access control for these files is specified, you can control access to them on the basis of the user IDs for individual Web clients. Access control for z/OS UNIX files is enabled by default.

Access control for z/OS UNIX files is activated by the XHFS system initialization parameter. The default for this parameter is YES, meaning that resource security for z/OS UNIX files is active. If you do **not** want resource security for these files, set this system initialization parameter to NO.

Access control for z/OS UNIX files is based on a user ID that is obtained from the Web client using basic authentication, or a user ID associated with a client certificate sent by the Web client. The user ID is used only during the process of security checking.

Access control for z/OS UNIX files differs from standard resource security for the other resource types controlled by *Xname* system initialization parameters, in some important ways:

- Access controls for z/OS UNIX files are not managed directly by RACF. They are specified in z/OS UNIX System Services, which makes use of RACF to manage user IDs and groups of user IDs, but keeps control of the permissions set for the files and directories. Because of this, you do not need to define RACF profiles for individual files, and you cannot use the QUERY SECURITY command to check access to them. You check and specify permissions for z/OS UNIX files and directories in the z/OS UNIX System Services shell environment, using z/OS UNIX commands. RACF is used to manage user profiles, groups and access control lists (ACLs). If you are using ACLs, you need to activate the FSSEC class for these to be checked.
- Security checking for z/OS UNIX files is not affected by the RESSEC attribute in the TRANSACTION resource definition of the transactions that access the files. If XHFS=YES is specified as a system initialization parameter for the CICS region, all z/OS UNIX files used by CICS Web support as static responses (and their directories) are subject to security checking, regardless of the RESSEC attribute for the transaction that is accessing them. (However, the SEC system initialization parameter does affect whether or not security checking is carried out, as for all resources.)
- z/OS UNIX files are not referenced directly by any CICS application programming commands or system programming commands. They can only be referenced by EXEC CICS commands when they are defined as CICS document templates. In this situation, resource security for CICS document templates (specified by the XRES system initialization parameter) controls access to them for users. CICS does **not** perform any additional permissions check on the z/OS UNIX files using the Web client's user ID. This is the case even if access control is specified for z/OS UNIX files in the CICS region, or if resource security is not active for document templates. Where z/OS UNIX files are defined as CICS document templates, you therefore need to set up Web clients' user ID access controls in RACF for the CICS document templates, rather than in z/OS UNIX System Services for the z/OS UNIX files. (However, the CICS region user ID always needs to have **read** permissions on z/OS UNIX files, even if they are defined as document templates.) Note in particular that this situation applies to all application-generated

responses from CICS Web support, and to any URIMAP definitions for static responses where the `TEMPLATENAME` attribute is used, rather than the `HFSFILE` attribute.

Implementing security for z/OS UNIX files

To implement access control for z/OS UNIX files used by CICS web support, when they are specified as static responses in URIMAP definitions that use the `HFSFILE` attribute, follow the steps listed in this topic.

Before you begin

The CICS region user ID must always have a minimum of **read** and **execute** permission to all z/OS UNIX files that it uses for CICS web support, and to the directories containing them. The user ID of the web client is only used when accessing z/OS UNIX files as a static response, but the CICS region user ID applies to all other attempts to access the file. If the CICS region user ID does not have permission to access the file, even an authorized web client is unable to view it. This is the case even when the file is defined as a CICS document template.

About this task

Procedure

1. Select an appropriate method to give permissions to web clients to access the z/OS UNIX files and directories.

You might choose to use the group permissions for the files and directories, or access control lists (ACLs).

Even if it is possible for you to use group permissions, the use of ACLs is the preferred solution for giving permissions to web clients' user IDs. With ACLs, you can allow access to multiple user groups, and the access can be set for single files or once for all the files in a directory. Directory permissions can be arranged in the same way. You can also use ACL commands to modify permissions for the files and directories. Although you work with ACLs in the z/OS UNIX System Services shell environment, they are created and checked by RACF, so if you are using a different security product, check its documentation to see if ACLs are supported.

When you have chosen your preferred method, follow the relevant steps in the remainder of this procedure.

2. Identify the authenticated user IDs used by web clients. These must be the basis of your access control. (You cannot supply an override by using an analyzer program, as you can with application-generated responses.)

Authenticated user IDs already have a user profile defined in your security manager.

3. For each web client user ID, choose and assign a suitable z/OS UNIX user identifier (UID). The UIDs are numbers that can be in the range 0 - 16 777 216. To assign UIDs, specify the UID value in the OMVS segment of the user profile for each user ID.

[“RACF user profiles” on page 11](#) tells you how to update a RACF user profile by using the `ALTUSER` command.

For example, if the web client's user ID is `WEBUSR1`, and the UID you want to assign is 2006, use the command:

```
ALTUSER WEBUSR1 OMVS(UID(2006))
```

All users must have a z/OS UNIX user identifier (UID) in their user profile in order to use z/OS UNIX function, even if you are not assigning permissions based on the UID. [z/OS UNIX System Services Planning](#) explains how to manage the UIDs and GIDs for your z/OS UNIX system.

4. Choose, or create, RACF groups that can be used by groups of web clients with the same permissions. For best performance, even if you are using ACLs, you should assign permissions to groups rather than individual users.
5. For each RACF group, choose a suitable z/OS UNIX group identifier (GID), and assign the GID to the RACF group. To assign a GID, specify the GID value in the OMVS segment of the RACF group profile.

For example, if the RACF group is CICSWEB1, and the GID you want to assign is 9, use the command:

```
ALTGROUP CICSWEB1 OMVS(GID(9))
```

6. Make sure that each of your web client user IDs connects to a RACF group to which you assigned a z/OS UNIX group identifier (GID).
If your web clients must connect to more than one RACF group, RACF list of groups must be active in your system.
7. Before you modify the permissions for the z/OS UNIX files and directories, ensure that your user ID is either a superuser on z/OS UNIX, or the owner of each z/OS UNIX file and directory you want to work with. Also, if you are working with groups, the owner of the files and directories must be connected to the RACF groups that you are using.
8. Optional: If you have chosen to use ACLs, set up ACLs that apply to all of the z/OS UNIX files and directories used by CICS web support for static responses, by using the `setfacl` command in the z/OS UNIX System Services shell environment.
[z/OS UNIX System Services Planning](#) has information about using ACLs, and examples of how to use the `setfacl` command.
 - a) For files, you can set up access ACLs, which apply to an individual file, or file default ACLs, which apply to all the files within a directory and within its subdirectories.
 - b) For directories, you can set up access ACLs, which apply to an individual directory, or directory default ACLs, which apply to the subdirectories within a directory.
 - c) To minimize the impact to performance, assign group permissions for the files to the RACF groups to which your web clients' user IDs connect, rather than using individual user IDs.
(There is also a limit on the number of items that can be specified in an ACL.)
 - d) If you must change the permissions granted to the groups (the base permission bits which specify **read**, **write** and **execute** access), you can specify this using the `setfacl` command as well.
Web clients must have **read** access to the z/OS UNIX files and directories.
 - e) If you are using ACLs, ensure that the FSSEC class is activated. Use the RACF command `SETROPTS CLASSACT(FSSEC)` to do this.
You can define ACLs before activating the FSSEC class, but you must activate the FSSEC class before ACLs can be used in access decisions.
9. Optional: If you have chosen to use group permissions without using ACLs, assign the group permissions for each z/OS UNIX file and directory to a group to which your web clients connect, and give the group **read** permissions. Use the UNIX command `chmod` to do this. [z/OS UNIX System Services Command Reference](#) and [z/OS UNIX System Services User's Guide](#) have information about using this command.
(Note that as group permissions only can be assigned to one group if you are using this method, some of your web clients' user IDs might need to connect to more than one group to acquire all the correct permissions.)
10. Specify `SEC=YES` as a CICS system initialization parameter. (`SECPRFX` is not relevant for z/OS UNIX files, as they do not have RACF profiles).
11. Specify `XHFS=YES` as a CICS system initialization parameter.
This step activates access control for all z/OS UNIX files in the CICS region.

Results

When you have completed the setup procedure, from this point onwards:

- All web clients who use a connection with basic authentication or client certificate authentication and attempt to access any HFS files, must have a user profile in the security manager which contains a valid z/OS UNIX UID, and connects to a RACF group with a valid z/OS UNIX GID.
- To be able to view a web page derived from a z/OS UNIX file, web clients who use a connection with basic authentication or client certificate authentication must have **read** permissions to the file and to the directories containing it, either individually or through the RACF groups to which they are connected.

If these conditions are not in place, web clients receive a 403 (Forbidden) status code, and CICS issues message DFHXS1116.

Access authorization levels

The user IDs of Web clients, and also the CICS region user ID, must have a minimum of **read** access for z/OS UNIX files, and the directory containing them, which are used with CICS Web support as static responses provided by URIMAP definitions (specified by the HFSFILE attribute).

If z/OS UNIX files are defined as CICS document templates, and the document templates are used either in URIMAP definitions as static responses (specified by the TEMPLATENAME attribute), or by applications, CICS does **not** perform any additional permissions check on the files using the Web client's user ID. However, the CICS region user ID still needs to have read permissions on the files, even when they are defined as document templates.

z/OS UNIX files are not manipulated directly by any CICS application programming commands or system programming commands. They can only be manipulated by EXEC CICS commands when they are defined as CICS document templates. In this situation, resource security for CICS document templates controls access to them for users.

Security for program specification blocks

DL/I program specification blocks (PSBs) are IMS control blocks that describe databases and logical message destinations used by an application program. PSBs consist of one or more program communication blocks (PCBs), which describe an application program's interface to an IMS database.

To implement security for PSBs scheduled in CICS applications:

1. Define profiles to RACF in the PCICSPSB or QCICSPSB resource classes (or their equivalent if you have user-defined resource class names), with access lists as appropriate. The resource profile names you define to RACF must correspond to the names of PSBs specified in CICS PSB schedule commands. For example, use the following commands to define PSBs in the PCICSPSB class, and to authorize users to access these queues:

```
RDEFINE PCICSPSB (psbname1, psbname2, ..., psbnamen) UACC(NONE)
          NOTIFY(sys_admin_userid)
PERMIT psbname1 CLASS(PCICSPSB) ID(group1, group2) ACCESS(READ)
PERMIT psbname2 CLASS(PCICSPSB) ID(group1, group2) ACCESS(READ)
```

To define PSBs as members of a profile in the CICS PSB resource group class, with an appropriate access list, use the following commands:

```
RDEFINE QCICSPSB psbname_group UACC(NONE)
          ADDMEM(psbnamea, psbnameb, ..., psbnamex)
          NOTIFY(sys_admin_userid)
PERMIT psbname_group CLASS(QCICSPSB) ID(group_userid) ACCESS(UPDATE)
```

2. Specify SEC=YES as a CICS system initialization parameter (and SECPRFX if you define profiles with a prefix).
3. Specify XPSB=YES as a CICS system initialization parameter for the default resource class names of PCICSPSB and QCICSPSB (or XPSB=class_name for user-defined resource class names).
4. Specify PSBCHK=YES if you want full security for PSBs that are accessed in transaction-routed transactions. This applies to both types of DL/I interface (remote and DBCTL). If you specify PSBCHK=NO, the authority of the remote user is **not used** in transaction-routed transactions.

Note: CICS requires a minimum authorization of READ for PSBs.

If you are using DBCTL, see [Security checking with DBCTL](#) for information on defining security in a CICS-DBCTL environment.

Security checking of transactions running under CEDF, CEDG, CEDX, or CEDY

When a transaction is run under one of the four EDF transactions, CICS checks the security settings for the target transaction.

The IBM-supplied definitions of CEDF, CEDG, CEDX, and CEDY in the DFHEDF group specify RESSEC(YES). Definitions in the IBM-supplied groups cannot be modified, so to change the definition, copy the transaction to another group.

When CEBR and CECI are invoked from within CEDF they are transaction-attach checked.

When one of the four EDF transactions is used to test a transaction, the authority of the user executing the transaction being tested is checked. For each resource accessed by the tested transaction, the user must have access authority, otherwise a NOTAUTH condition is raised. This requirement applies to all resource checks:

- Transaction attach
- CICS resource
- CICS command
- Non-CICS resources accessed through the QUERY SECURITY command
- Surrogate user

Defining generic profiles for resources

If you control access to CICS transactions by means of transaction-attach security, there is probably only a very small subset of other resource types for which you need a further level of RACF protection.

For example, there may be just a few programs in the CICS application program resource class that are particularly sensitive, and a much larger number that constitute no significant risk. In this case, you could protect the few by defining specific RACF profiles for only those programs that are sensitive. You ensure that everyone can access the remaining, nonsensitive, programs by defining a completely generic resource profile, as follows:

```
RDEFINE MCICSPPT * UACC(READ) ...
```

This profile applies to any authorization request for programs not covered by one of the specific profiles. RACF processing logic is such that the most specific profile for any given resource name is always used.

Note that to determine whether a profile is generic, you need only check if 'G' appears after the name of the profile when it is listed with RLIST or SEARCH. For example:

```
SEARCH CLASS(TCICSTRN)
```

may give the following output:

```
C*  
CED% (G)  
** (G)
```

This output shows that both CED% and ** are generic profiles. The C* profile is not generic because it is not followed by (G). This could have occurred if the C* profile was created before generic profiles had been enabled with a SETROPTS command. The C* profile can be deleted and redefined as a proper generic profile as follows:

```
SETROPTS NOGENERIC(TCICSTRN)  
SETROPTS NOGENCMD(TCICSTRN)  
RDEL TCICSTRN C*  
SETROPTS GENERIC(TCICSTRN)  
RDEFINE TCICSTRN C* UACC(NONE)
```

Access to all or access to none?

If RACF can find neither a specific nor generic profile, it returns a "no profile found" condition.

CICS treats this return code exactly the same as the "user not authorized" return code, and returns the NOTAUTH condition to the CICS application program. If RACF cannot find the APPL class, it returns a "READ access intent" condition.

You can either use the completely generic profile to permit access to any resources not otherwise covered by more specific profiles, or, to prevent any access, use the UACC(READ|UPDATE) or UACC(NONE) options. For example,

```
RDEFINE DCICSDCT * UACC(NONE)
```

prevents access to any transient data queue not covered by any of the other profiles defined to RACF, and results in RACF writing an SMF record.

On the other hand, you can define files as "public" by the following command:

```
RDEFINE FCICSFCT * UACC(READ)
```

If you are using generic profiles, ensure that generic profile checking has been activated for the CICS RACF resource classes (both the IBM-supplied classes and any installation-defined classes added to the RACF class descriptor table) by issuing a SETROPTS GENERIC(*classname*) command for any one of the CICS classes having the same POSIT value. This ensures generic checking for all other CICS classes with the same POSIT value. If you change a generic profile, you must issue a SETROPTS GENERIC(*classname*) REFRESH command. For more information about POSIT values and defining generic classes, see the [z/OS Security Server RACF System Programmer's Guide](#).

Security using the XRES resource security parameter

Use security profiles and the **XRES** system initialization parameter to security check a subset of CICS resources. An example of how to implement resource security for CICS document templates is provided.

About this task

A CICS security profile names consist of three parts: *security_prefix.resource_type.resource_name*. CICS profiles are passed to the security manager for checking. Security checking is case sensitive.

Security prefix

The *security_prefix* is the value specified on the **SECPRFX** system initialization parameter. The default value for the **SECPRFX** parameter is NO, which means that the *security_prefix* is omitted. If the value of the **SECPRFX** parameter is YES, the *security_prefix* is the name of the region user ID. Alternatively, you can specify a 1- to 8-character value for the *security_prefix*.

Resource type

The *resource_type* specifies the type of resource against which checks are performed. In most instances, each CICS resource has a corresponding security profile; for example, the ATOMSERVICE resource has a security profile with a corresponding resource type:

```
security_prefix.ATOMSERVICE.resource_name
```

However, certain CICS resources do not have a corresponding security profile; for example, the BUNDLEPART, OSGIBUNDLE, and OSGISERVICE resources are checked using the BUNDLE security profile.

You can create security profiles that use the following resource types:

- ATOMSERVICE
- BUNDLE
- DOCTEMPLATE
- EPADAPTER

- EPADAPTERSET
- EVENTBINDING
- JVMSERVER
- XMLTRANSFORM

For a complete list of the CICS resources, resource types, and commands associated with security checks, see [“Resource and command check cross-reference”](#) on page 96.

Note: When you give a user authority to perform an action on a platform or application, you also give them authority to perform the same action on the dynamically generated resources for the platform or application. CICS resource security checks are not carried out when you create or operate on CICS bundles through an application or platform. However, CICS resource security checks do apply when you perform an action directly on an individual BUNDLE resource, or a resource that was defined in a CICS bundle, even if the bundle was created when you installed a platform or application. For more information, see [Security for bundles](#).

Resource name

The *resource_name* specifies the name of the CICS resource.

Example

This example task explains how to implement resource security for CICS document templates.

CICS document templates are controlled in the following cases:

- Document templates delivered as a static response to a web client request (specified on the `TEMPLATENAME` attribute of the `URIMAP` definition for the request).
- Document templates delivered as part of an application-generated response to a web client request (used by an application program that handles the request).
- All **EXEC CICS CREATE, INQUIRE, DISCARD, and SET DOCTEMPLATE** commands.
- All **EXEC CICS DOCUMENT INSERT and CREATE** commands with the `TEMPLATE` option.

The **EXEC CICS DOCUMENT** commands reference document templates using the 48-character name of the template, as specified in the `TEMPLATENAME` attribute of the `DOCTEMPLATE` resource. However, security checking for these commands uses the name of the `DOCTEMPLATE` resource that corresponds to the `TEMPLATENAME` attribute. So you can set up one profile name for each document template, using the name of the `DOCTEMPLATE` resource, and not the `TEMPLATENAME` attribute.

Note: Document templates can be retrieved from a variety of sources including partitioned data sets, CICS programs, CICS files, z/OS UNIX System Services files, temporary storage queues, transient data queues, and exit programs. When resource security checking is carried out for a document template, CICS does not perform any additional security checking on the resource that supplies the document template, even if resource security is specified for that type of resource in the CICS region.

Complete the following steps to implement resource security for CICS document templates:

1. Define profiles to RACF in the default `RCICSRES` resource class or `WCICSRES` grouping class, or their equivalents if you have user-defined resource class names.

For the profile names, use the name of the `DOCTEMPLATE` resource definition, prefixed by the resource type `DOCTEMPLATE`, and any additional prefix specified by the **SECPRFX** system initialization parameter for the CICS region.

For example, use the following commands to define document templates in the `RCICSRES` class, and authorize users to use them to assemble documents:

```
RDEFINE RCICSRES (DOCTEMPLATE.doc1, DOCTEMPLATE.doc2, ..., DOCTEMPLATE.docn) UACC(NONE)
          NOTIFY(sys_admin_userid)
PERMIT DOCTEMPLATE.doc1 CLASS(RCICSRES) ID(group1, group2) ACCESS(READ)
```

To define document templates as members of a profile in the `WCICSRES` resource grouping class, with an appropriate access list, use the following commands:

```
RDEFINE WCICSRES (doc_groupname) UACC(NONE)
                ADDMEM(DOCTEMPLATE.doca, DOCTEMPLATE.docb) NOTIFY(sys_admin_userid)
PERMIT doc_groupname CLASS(WCICSRES) ID(group_userid) ACCESS(READ)
```

After you have issued the RDEFINE command for the RCICSRES or WCICSRES class, if the class is not yet active, you need to activate it by issuing a SETROPTS command. For example:

```
SETROPTS CLASSACT(RCICSRES) RACLIST(RCICSRES)
```

If the class is active, refresh it using the SETROPTS command:

```
SETROPTS RACLIST(RCICSRES) REFRESH
```

2. Specify **SEC=YES** as a CICS system initialization parameter (and **SECPRFX=YES** if you define profiles with a prefix).
3. Specify **XRES=YES** for the default resource class names of RCICSRES and WCICSRES, or **XRES=name** for user-defined resource class names.

XRES=YES is the default.

4. Specify **RESSEC(YES)** in the TRANSACTION resource definition of the transactions that access the CICS document templates.

For CICS web support, the transaction for all static responses is CWXN, or an alternate transaction that you have specified in place of CWXN using the TRANSACTION attribute on your TCPIP SERVICE definitions. The transaction for application-generated responses is an alias transaction, which can be specified in the URIMAP definition for the request or set by an analyzer program, and defaults to CWBA.

As supplied by CICS, the definition for CWXN specifies RESSEC(YES), but the definition for CWBA specifies RESSEC(NO), and for TRANSACTION resource definitions in general the default is RESSEC(NO).

Resource security

Resource security protects CICS resources against unauthorized access.

CICS and RACF resource checking summary

You use the CICS resource system initialization parameters to specify the RACF class name.

Each resource is described briefly in [Table 9 on page 94](#), with the associated CICS system initialization parameter that you use to specify the RACF class name. For comprehensive information about application programming commands and system programming commands associated with each system initialization parameter, see [“Resource and command check cross-reference” on page 96](#).

No authorization processing is done for BMS commands.

CICS parameter	Resource protected	Further information
XAPPC	Partner logical units (LU6.2).	“Implementing LU6.2 security” on page 222.
XCMD	The subset of CICS application programming commands that are subject to command security checking. EXEC CICS FEPI system commands are also controlled by this parameter.	“CICS command security” on page 118
XDB2	DB2 resource classes for DB2ENTRY are specified to CICS on the XDB2 system initialization parameter.	“Resource classes for DB2ENTRYs” on page 22

Table 9. General resource checking by CICS (continued)

CICS parameter	Resource protected	Further information
XDCT	CICS extrapartition and intrapartition transient data queues. Define profiles in the transient data class to control who is allowed to access CICS transient data queues.	“Security for transient data” on page 77.
XFCT	CICS file-control-managed VSAM and BDAM files. Define profiles in the file class to control who is allowed to access CICS VSAM and BDAM files.	“Security for files” on page 79.
XHFS	z/OS UNIX files managed by z/OS UNIX System Services. This is a special case, because access controls for z/OS UNIX files are specified in z/OS UNIX System Services, so z/OS UNIX files do not require individual RACF profiles. No application programming commands or system programming commands are associated with this resource.	“Implementing security for z/OS UNIX files” on page 88.
XJCT	CICS system log and general logs. Define profiles in the journal class to control who is allowed to access CICS journals on CICS log streams.	“Security for journals and log streams” on page 80.
XPCT	CICS started transactions and EXEC CICS commands: COLLECT STATISTICS TRANSACTION, DISCARD TRANSACTION, INQUIRE TRANSACTION, INQUIRE REQID, SET TRANSACTION , and CANCEL . Define profiles in the started-transactions class to control who is allowed access to started CICS transactions.	“Security for started transactions” on page 81.
XPPT	CICS application programs. Define profiles in the program class to control who is allowed to access CICS application programs.	“Security for application programs” on page 85.
XPSB	DL/I program specification blocks (PSBs). Define profiles in the program specification block class to control who is allowed to access the DL/I PSBs used in CICS application programs.	“Security for program specification blocks” on page 90.
XRES	CICS resources that use the XRES parameter are: ATOMSERVICE, BUNDLE, DOCTEMPLATE, EPADAPTER, EPADAPTERSET, EVENTBINDING, JVMSERVER, and XMLTRANSFORM . For example, define profiles in the DOCTEMPLATE resource class to control who is allowed to access document templates.	“Security using the XRES resource security parameter” on page 71.
XTRAN	CICS transactions.	“Transaction security” on page 66.
XTST	CICS temporary storage queues. Define profiles in the temporary storage class to control who is allowed to access CICS temporary storage queues.	“Security for temporary storage” on page 86.
XUSER	Surrogate user security.	“Surrogate user security” on page 113.

Defining generic profiles for resources

If you control access to CICS transactions by means of transaction-attach security, there is probably only a very small subset of other resource types for which you need a further level of RACF protection.

For example, there may be just a few programs in the CICS application program resource class that are particularly sensitive, and a much larger number that constitute no significant risk. In this case, you could protect the few by defining specific RACF profiles for only those programs that are sensitive. You ensure that everyone can access the remaining, nonsensitive, programs by defining a completely generic resource profile, as follows:

```
RDEFINE MCICSPPT * UACC(READ) ...
```

This profile applies to any authorization request for programs not covered by one of the specific profiles. RACF processing logic is such that the most specific profile for any given resource name is always used.

Note that to determine whether a profile is generic, you need only check if 'G' appears after the name of the profile when it is listed with RLIST or SEARCH. For example:

```
SEARCH CLASS(TCICSTRN)
```

may give the following output:

```
C*
CED% (G)
** (G)
```

This output shows that both CED% and ** are generic profiles. The C* profile is not generic because it is not followed by (G). This could have occurred if the C* profile was created before generic profiles had been enabled with a SETROPTS command. The C* profile can be deleted and redefined as a proper generic profile as follows:

```
SETROPTS NOGENERIC(TCICSTRN)
SETROPTS NOGENCMD(TCICSTRN)
RDEL TCICSTRN C*
SETROPTS GENERIC(TCICSTRN)
RDEFINE TCICSTRN C* UACC(NONE)
```

Resource and command check cross-reference

Use this cross-reference to check commands against resources.

<i>Table 10. Resource and command check cross-reference</i>					
EXEC CICS COMMAND	RESOURCE CHECK			CHECK CLASS=XCMD	
	CLAS S	ACCESS	RESOURCE	ACCESS	RESOURCE
ABEND					
ACQUIRE				UPDATE	TERMINAL
ACQUIRE FOR BTS See note “9” on page 113	XFCT	UPDATE	BTS REPOSITORY FILE		
ADDRESS					
ALLOCATE					
ASKTIME					

Table 10. Resource and command check cross-reference (continued)

EXEC CICS COMMAND	RESOURCE CHECK			CHECK CLASS=XCMD	
	CLAS S	ACCESS	RESOURCE	ACCESS	RESOURCE
BIF DEEDIT					
BIF DIGEST					
BUILD ATTACH					
CANCEL See note “1” on page 112	XPCT	READ	TRANSID		
CANCEL FOR BTS	XFCT	UPDATE	BTS REPOSITORY FILE		
CHANGE PASSWORD					
CHANGE TASK					
COLLECT STATISTICS				READ	STATISTICS
COLLECT STATISTICS FILE	XFCT	READ	FILE	READ	STATISTICS
COLLECT STATISTICS JOURNALNAME	XJCT	READ	JOURNAL	READ	STATISTICS
COLLECT STATISTICS JOURNALNUM	XJCT	READ	JOURNAL	READ	STATISTICS
COLLECT STATISTICS PROGRAM	XPPT	READ	PROGRAM	READ	STATISTICS
COLLECT STATISTICS TDQUEUE	XDCT	READ	TDQUEUE	READ	STATISTICS
COLLECT STATISTICS TRANSACTION	XPCT	READ	TRANSID	READ	STATISTICS
CONNECT PROCESS					
CONVERSE					
CREATE ATOMSERVICE	XRES	ALTER	ATOMSERVICE. <i>resource_name</i>	ALTER	ATOMSERVICE
CREATE BUNDLE	XRES	ALTER	BUNDLE. <i>resource_name</i>	ALTER	BUNDLE
CREATE CONNECTION See note “2” on page 112				ALTER	CONNECTION
CREATE DB2CONN See note “3” on page 112		ALTER			DB2CONN

Table 10. Resource and command check cross-reference (continued)

EXEC CICS COMMAND	RESOURCE CHECK			CHECK CLASS=XCMD	
	CLAS S	ACCESS	RESOURCE	ACCESS	RESOURCE
CREATE DB2ENTRY See note “3” on page 112	XDB2	ALTER	DB2ENTRY	ALTER	DB2ENTRY
CREATE DB2TRAN See note “3” on page 112	XDB2	ALTER	DB2TRAN	ALTER	DB2TRAN
CREATE DOCTEMPLATE	XRES	ALTER	DOCTEMPLATE. <i>resource_name</i>	ALTER	DOCTEMPLATE
CREATE ENQMODEL				ALTER	ENQMODEL
CREATE FILE	XFCT	ALTER	FILE	ALTER	FILE
CREATE IPCONN				ALTER	IPCONN
CREATE JOURNALMODEL				ALTER	JOURNALMODEL
CREATE JVMSERVER	XRES	ALTER	JVMSERVER. <i>resource_name</i>	ALTER	JVMSERVER
CREATE LIBRARY				ALTER	LIBRARY
CREATE LSRPOOL				ALTER	LSRPOOL
CREATE MAPSET	XPPT	ALTER	MAPSET	ALTER	MAPSET
CREATE MQCONN				ALTER	MQCONN
CREATE MQMONITOR				ALTER	MQMON
CREATE PARTITIONSET	XPPT	ALTER	PARTITIONSET	ALTER	PARTITIONSET
CREATE PARTNER				ALTER	PARTNER
CREATE PIPELINE				ALTER	PIPELINE
CREATE PROCESSTYPE See note “10” on page 113				ALTER	PROCESSTYPE
CREATE PROFILE				ALTER	PROFILE
CREATE PROGRAM	XPPT	ALTER	PROGRAM	ALTER	PROGRAM
CREATE SESSIONS See note “3” on page 112				ALTER	SESSIONS
CREATE TCPIPSERVICE				ALTER	TCPIPSERVICE

Table 10. Resource and command check cross-reference (continued)

EXEC CICS COMMAND	RESOURCE CHECK			CHECK CLASS=XCMD	
	CLAS S	ACCESS	RESOURCE	ACCESS	RESOURCE
CREATE TDQUEUE See note “3” on page 112	XDCT	ALTER	TDQUEUE	ALTER	TDQUEUE
CREATE TERMINAL See note “3” on page 112				ALTER	TERMINAL
CREATE TRANCLASS				ALTER	TCLASS
CREATE TRANSACTION	XPCT	ALTER	TRANSID	ALTER	TRANSACTION
CREATE TSMODEL				ALTER	TSMODEL
CREATE TYPETERM				ALTER	TYPETERM
CREATE URIMAP				ALTER	URIMAP
CREATE WEBSERVICE				ALTER	WEBSERVICE
CSD ADD				UPDATE	CSD
CSD ALTER				UPDATE	CSD
CSD APPEND				UPDATE	CSD
CSD COPY				UPDATE	CSD
CSD DEFINE				UPDATE	CSD
CSD DELETE				UPDATE	CSD
CSD DISCONNECT				READ	CSD
CSD ENDBRGROUP				READ	CSD
CSD ENDBRLIST				READ	CSD
CSD ENDBRRSRCE				READ	CSD
CSD GETNEXTGROUP				READ	CSD
CSD GETNEXTLIST				READ	CSD
CSD GETNEXTRSRCE				READ	CSD
CSD INQUIREGROUP				READ	CSD
CSD INQUIRELIST				READ	CSD
CSD INQUIRERSRCE				READ	CSD
CSD INSTALL				ALTER	CSD
CSD LOCK				UPDATE	CSD
CSD REMOVE				UPDATE	CSD

Table 10. Resource and command check cross-reference (continued)

EXEC CICS COMMAND	RESOURCE CHECK			CHECK CLASS=XCMD	
	CLAS S	ACCESS	RESOURCE	ACCESS	RESOURCE
CSD RENAME				UPDATE	CSD
CSD STARTBRGROUP				READ	CSD
CSD STARTBRLIST				READ	CSD
CSD STARTBRRSRCE				READ	CSD
CSD UNLOCK				UPDATE	CSD
CSD USERDEFINE				UPDATE	CSD
DEFINE ACTIVITY See notes “7” on page 113 and “9” on page 113	XFCT	UPDATE	BTS REPOSITORY FILE		
DEFINE PROCESS See notes “7” on page 113 and “9” on page 113	XFCT	UPDATE	BTS REPOSITORY FILE		
DELAY					
DELETE	XFCT	UPDATE	FILE		
DELETE ACTIVITY See note “9” on page 113	XFCT	UPDATE	BTS REPOSITORY FILE		
DELETEQ TD	XDCT	UPDATE	TDQUEUE		
DELETEQ TS See note “4” on page 112	XTST	UPDATE	TSQUEUE		
DEQ					
DISABLE PROGRAM	XPPT	UPDATE	PROGRAM	UPDATE	EXITPROGRAM
DISCARD ATOMSERVICE	XRES	ALTER	ATOMSERVICE. <i>resource_name</i>	ALTER	ATOMSERVICE
DISCARD AUTINSTMODEL				ALTER	AUTINSTMODEL
DISCARD BUNDLE	XRES	ALTER	BUNDLE. <i>resource_name</i>	ALTER	BUNDLE
DISCARD CONNECTION					
DISCARD DB2CONN				ALTER	DB2CONN
DISCARD DB2ENTRY	XDB2	ALTER	DB2ENTRY	ALTER	DB2ENTRY
DISCARD DB2TRAN	XDB2	ALTER	DB2TRAN	ALTER	DB2TRAN

Table 10. Resource and command check cross-reference (continued)

EXEC CICS COMMAND	RESOURCE CHECK			CHECK CLASS=XCMD	
	CLAS S	ACCESS	RESOURCE	ACCESS	RESOURCE
DISCARD DOCTEMPLATE	XRES	ALTER	DOCTEMPLATE. <i>resource_name</i>	ALTER	DOCTEMPLATE
DISCARD ENQMODEL				ALTER	ENQMODEL
DISCARD FILE	XFCT	ALTER	FILE	ALTER	FILE
DISCARD IPCONN				ALTER	IPCONN
DISCARD JOURNALMODEL				ALTER	JOURNALMODEL
DISCARD JOURNALNAME	XJCT	ALTER	JOURNAL	ALTER	JOURNALNAME
DISCARD JVMSERVER	XRES	ALTER	JVMSERVER. <i>resource_name</i>	ALTER	JVMSERVER
DISCARD LIBRARY				ALTER	LIBRARY
DISCARD MQCONN				ALTER	MQCONN
DISCARD MQMONITOR				ALTER	MQMON
DISCARD PARTNER				ALTER	PARTNER
DISCARD PIPELINE				ALTER	PIPELINE
DISCARD PROCESSTYPE See note “10” on page 113				ALTER	PROCESSTYPE
DISCARD PROFILE				ALTER	PROFILE
DISCARD PROGRAM	XPPT	ALTER	PROGRAM	ALTER	PROGRAM
DISCARD TCPIPSERVICE				ALTER	TCPIPSERVICE
DISCARD TDQUEUE	XDCT	ALTER	TDQUEUE	ALTER	TDQUEUE
DISCARD TERMINAL				ALTER	TERMINAL
DISCARD TRANCLASS				ALTER	TCLASS
DISCARD TRANSACTION	XPCT	ALTER	TRANSID	ALTER	TRANSACTION
DISCARD TSMODEL				ALTER	TSMODEL
DISCARD URIMAP				ALTER	URIMAP
DISCARD WEBSERVICE				ALTER	WEBSERVICE

Table 10. Resource and command check cross-reference (continued)

EXEC CICS COMMAND	RESOURCE CHECK			CHECK CLASS=XCMD	
	CLAS S	ACCESS	RESOURCE	ACCESS	RESOURCE
DOCUMENT CREATE See note 14	XRES	READ	DOCTEMPLATE.resource_name		
DOCUMENT INSERT See note 14	XRES	READ	DOCTEMPLATE.resource_name See note 13		
DUMP TRANSACTION					
ENABLE PROGRAM	XPPT	UPDATE	PROGRAM	UPDATE	EXITPROGRAM
ENDBR See note “5” on page 112					
ENQ					
ENTER TRACENUM					
EXTRACT					
EXTRACT EXIT	XPPT	READ	PROGRAM	UPDATE	EXITPROGRAM
EXTRACT STATISTICS				READ	STATISTICS
FEPI					FEPI
FORMATTIME					
FREE					
FREEMAIN					
GDS					
GETMAIN					
HANDLE ABEND PROGRAM	XPPT	READ	PROGRAM		
HANDLE AID					
HANDLE CONDITION					
IGNORE CONDITION					
INQUIRE ACTIVITYID See note “9” on page 113	XFCT	READ	BTS REPOSITORY FILE		
INQUIRE ASSOCIATION				READ	ASSOCIATION
INQUIRE ATOMSERVICE	XRES	READ	ATOMSERVICE.resource_name	READ	ATOMSERVICE
INQUIRE AUTINSTMODEL				READ	AUTINSTMODEL

Table 10. Resource and command check cross-reference (continued)

EXEC CICS COMMAND	RESOURCE CHECK			CHECK CLASS=XCMD	
	CLAS S	ACCESS	RESOURCE	ACCESS	RESOURCE
INQUIRE AUTOINSTALL				READ	AUTOINSTALL
INQUIRE BRFACILITY				READ	BRFACILITY
INQUIRE BUNDLE	XRES	READ	BUNDLE.resource_name	READ	BUNDLE
INQUIRE BUNDLEPART	XRES	READ	BUNDLE.resource_name	READ	BUNDLEPART
INQUIRE CAPDATAPRED	XRES	READ	EVENTBINDING.resource_name	READ	CAPDATAPRED
INQUIRE CAPINFOSRCE	XRES	READ	EVENTBINDING.resource_name	READ	CAPINFOSRCE
INQUIRE CAOPTPRED	XRES	READ	EVENTBINDING.resource_name	READ	CAOPTPRED
INQUIRE CAPTURESPEC	XRES	READ	EVENTBINDING.resource_name	READ	CAPTURESPEC
INQUIRE CFDTPOOL				READ	CFDTPOOL
INQUIRE CONNECTION				READ	CONNECTION
INQUIRE CONTAINER See note “9” on page 113	XFCT	READ	BTS REPOSITORY FILE		
INQUIRE DB2CONN				READ	DB2CONN
INQUIRE DB2ENTRY	XDB2	READ	DB2ENTRY	READ	DB2ENTRY
INQUIRE DB2TRAN	XDB2	READ	DB2TRAN	READ	DB2TRAN
INQUIRE DELETSHIPPED				READ	DELETSHIPPED
INQUIRE DOCTEMPLATE	XRES	READ	DOCTEMPLATE.resource_name	READ	DOCTEMPLATE
INQUIRE DSNAME				READ	DSNAME
INQUIRE DUMPDS				READ	DUMPDS
INQUIRE ENQMODEL				READ	ENQMODEL
INQUIRE EPADAPTER	XRES	READ	EPADAPTER.resource_name	READ	EPADAPTER
INQUIRE EPADAPTERSET	XRES	READ	EPADAPTERSET.resource_name	READ	EPADAPTERSET
INQUIRE EPADAPTINSET	XRES	READ	EPADAPTERSET.resource_name	READ	EPADAPTINSET

Table 10. Resource and command check cross-reference (continued)

EXEC CICS COMMAND	RESOURCE CHECK			CHECK CLASS=XCMD	
	CLAS S	ACCESS	RESOURCE	ACCESS	RESOURCE
INQUIRE EVENT See note "9" on page 113	XFCT	READ	BTS REPOSITORY FILE		
INQUIRE EVENTBINDING	XRES	READ	EVENTBINDING. <i>resource_name</i>	READ	EVENTBINDING
INQUIRE EVENTPROCESS				READ	EVENTPROCESS
INQUIRE EXCI				READ	EXCI
INQUIRE EXITPROGRAM	XPPT	READ	PROGRAM	READ	EXITPROGRAM
INQUIRE FILE	XFCT	READ	FILE	READ	FILE
INQUIRE HOST				READ	HOST
INQUIRE IPCONN				READ	IPCONN
INQUIRE IRC				READ	IRC
INQUIRE JOURNALMODEL				READ	JOURNALMODEL
INQUIRE JOURNALNAME	XJCT	READ	JOURNAL	READ	JOURNAL
INQUIRE JVMSERVER	XRES	READ	JVMSERVER. <i>resource_name</i>	READ	JVMSERVER
INQUIRE LIBRARY				READ	LIBRARY
INQUIRE MODENAME				READ	MODENAME
INQUIRE MONITOR				READ	MONITOR
INQUIRE MQCONN				READ	MQCONN
INQUIRE MQINI				READ	MQMON
INQUIRE MQMONITOR				READ	MQMON
INQUIRE MVSTCB				READ	MVSTCB
INQUIRE NETNAME				READ	TERMINAL
INQUIRE OSGIBUNDLE	XRES	READ	BUNDLE. <i>resource_name</i>	READ	OSGIBUNDLE
INQUIRE OSGISERVICE	XRES	READ	BUNDLE. <i>resource_name</i>	READ	OSGISERVICE
INQUIRE PARTNER				READ	PARTNER
INQUIRE PIPELINE				READ	PIPELINE

Table 10. Resource and command check cross-reference (continued)

EXEC CICS COMMAND	RESOURCE CHECK			CHECK CLASS=XCMD	
	CLAS S	ACCESS	RESOURCE	ACCESS	RESOURCE
INQUIRE PROCESS See note “9” on page 113	XFCT	READ	BTS REPOSITORY FILE		
INQUIRE PROCESSTYPE See note “10” on page 113	XPTT			READ	PROCESSTYPE
INQUIRE PROFILE				READ	PROFILE
INQUIRE PROGRAM	XPPT	READ	PROGRAM	READ	PROGRAM
INQUIRE REQID See note “8” on page 113	XPCT	READ	TRANSID	READ	REQID
INQUIRE RRMS				READ	RRMS
INQUIRE STATISTICS				READ	STATISTICS
INQUIRE STORAGE				READ	STORAGE
INQUIRE STREAMNAME				READ	STREAMNAME
INQUIRE SUBPOOL				READ	SUBPOOL
INQUIRE SYSDUMPCODE				READ	SYSDUMPCODE
INQUIRE SYSTEM				READ	SYSTEM
INQUIRE TASK				READ	TASK
INQUIRE TCLASS				READ	TCLASS
INQUIRE TCPIP				READ	TCPIP
INQUIRE TCPIPSERVICE				READ	TCPIPSERVICE
INQUIRE TDQUEUE	XDCT	READ	TDQUEUE	READ	TDQUEUE
INQUIRE TEMPSTORAGE				READ	TEMPSTORAGE
INQUIRE TERMINAL				READ	TERMINAL
INQUIRE TIMER See note “9” on page 113	XFCT	READ	BTS REPOSITORY FILE		
INQUIRE TRACEDEST				READ	TRACEDEST
INQUIRE TRACEFLAG				READ	TRACEFLAG

Table 10. Resource and command check cross-reference (continued)

EXEC CICS COMMAND	RESOURCE CHECK			CHECK CLASS=XCMD	
	CLAS S	ACCESS	RESOURCE	ACCESS	RESOURCE
INQUIRE TRACETYPE				READ	TRACETYPE
INQUIRE TRANCLASS				READ	TCLASS
INQUIRE TRANDUMPCODE				READ	TRANDUMPCODE
INQUIRE TRANSACTION	XPCT	READ	TRANSID	READ	TRANSACTION
INQUIRE TSMODEL				READ	TSMODEL
INQUIRE TSPOOL				READ	TSPOOL
INQUIRE TSQNAME See note “4” on page 112	XTST	READ	TSQNAME	READ	TSQUEUE
INQUIRE TSQUEUE See note “4” on page 112	XTST	READ	TSQUEUE	READ	TSQUEUE
INQUIRE UOW				READ	UOW
INQUIRE UOWDSNFAIL				READ	UOWDSNFAIL
INQUIRE UOWENQ				READ	UOWENQ
INQUIRE UOWLINK				READ	UOWLINK
INQUIRE URIMAP				READ	URIMAP
INQUIRE VTAM				READ	VTAM (now the z/OS Communications Server)
INQUIRE WEB				READ	WEB
INQUIRE WEBSERVICE				READ	WEBSERVICE
INQUIRE WLMHEALTH				READ	WLMHEALTH
INQUIRE XMLTRANSFORM	XRES	READ	XMLTRANSFORM.resource_name	READ	XMLTRANSFORM
ISSUE					
LINK	XPPT	READ	PROGRAM		
LINK ACQPROCESS See note “9” on page 113	XFCT	UPDATE	BTS REPOSITORY FILE		

Table 10. Resource and command check cross-reference (continued)

EXEC CICS COMMAND	RESOURCE CHECK			CHECK CLASS=XCMD	
	CLAS S	ACCESS	RESOURCE	ACCESS	RESOURCE
LINK ACTIVITY / ACQACTIVITY See note “9” on page 113	XFCT	UPDATE	BTS REPOSITORY FILE		
LOAD	XPPT	READ	PROGRAM		
MONITOR					
PERFORM DELETSHIPED				UPDATE	DELETSHIPED
PERFORM DUMP				UPDATE	DUMP
PERFORM PIPELINE				UPDATE	PIPELINE
PERFORM RESETTIME				UPDATE	RESETTIME
PERFORM SECURITY REBUILD				UPDATE	SECURITY
PERFORM SHUTDOWN				UPDATE	SHUTDOWN
PERFORM SSL REBUILD				UPDATE	SECURITY
PERFORM STATISTICS				UPDATE	STATISTICS
POINT					
POP HANDLE					
POST					
PURGE MESSAGE					
PUSH HANDLE					
QUERY SECURITY See note “6” on page 112					
READ	XFCT	READ	FILE		
READ NEXT See note “5” on page 112					
READ PREV See note “5” on page 112					
READQ TD	XDCT	UPDATE	TDQUEUE		

Table 10. Resource and command check cross-reference (continued)

EXEC CICS COMMAND	RESOURCE CHECK			CHECK CLASS=XCMD	
	CLAS S	ACCESS	RESOURCE	ACCESS	RESOURCE
READQ TS See note “4” on page 112	XTST	READ	TSQUEUE		
RECEIVE					
RELEASE	XPPT	READ	PROGRAM		
RESET ACTIVITY See note “9” on page 113	XFCT	UPDATE	BTS REPOSITORY FILE		
RESET ACQPROCESS See note “9” on page 113	XFCT	UPDATE	BTS REPOSITORY FILE		
RESETBR See note “5” on page 112					
RESYNC ENTRYNAME				UPDATE	EXITPROGRAM
RETRIEVE					
RETURN / RETURN ENDACTIVITY See note “9” on page 113 and “11” on page 113	XFCT	UPDATE	BTS REPOSITORY FILE		
REWRITE	XFCT	UPDATE	FILE		
ROUTE					
RUN See note “9” on page 113 and “11” on page 113	XFCT	UPDATE	BTS REPOSITORY FILE		
RUN / ASYNCH SYNC See note “9” on page 113	XFCT	UPDATE	DFHLRQ FILE		
SEND					
SET ATOMSERVICE	XRES	UPDATE	ATOMSERVICE. <i>resource_name</i>	UPDATE	ATOMSERVICE
SET AUTOINSTALL				UPDATE	AUTOINSTALL
SET BRFACILITY				UPDATE	BRFACILITY
SET BUNDLE	XRES	UPDATE	BUNDLE. <i>resource_name</i>	UPDATE	BUNDLE

Table 10. Resource and command check cross-reference (continued)

EXEC CICS COMMAND	RESOURCE CHECK			CHECK CLASS=XCMD	
	CLAS S	ACCESS	RESOURCE	ACCESS	RESOURCE
SET CONNECTION				UPDATE	CONNECTION
SET DB2CONN				UPDATE	DB2CONN
SET DB2ENTRY	XDB2	UPDATE	DB2ENTRY	UPDATE	DB2ENTRY
SET DB2TRAN	XDB2	UPDATE	DB2TRAN	UPDATE	DB2TRAN
SET DELETSHIPED				UPDATE	DELETSHIPED
SET DOCTEMPLATE	XRES	UPDATE	DOCTEMPLATE. <i>resource_name</i>	UPDATE	DOCTEMPLATE
SET DSNAME				UPDATE	DSNAME
SET DUMPDS				UPDATE	DUMPDS
SET ENQMODEL				UPDATE	ENQMODEL
SET EPADAPTER	XRES	UPDATE	EPADAPTER. <i>resource_name</i>	UPDATE	EPADAPTER
SET EPADAPTERSET	XRES	UPDATE	EPADAPTERSET. <i>resource_name</i>	UPDATE	EPADAPTERSET
SET EVENTBINDING	XRES	UPDATE	EVENTBINDING. <i>resource_name</i>	UPDATE	EVENTBINDING
SET EVENTPROCESS	XRES	UPDATE	EVENTPROCESS. <i>resource_name</i>	UPDATE	EVENTPROCESS
SET FILE	XFCT	UPDATE	FILE	UPDATE	FILE
SET HOST				UPDATE	HOST
SET IPCONN				UPDATE	IPCONN
SET IRC				UPDATE	IRC
SET JOURNALNAME	XJCT	UPDATE	JOURNAL	UPDATE	JOURNAL
SET JVMSERVER	XRES	UPDATE	JVMSERVER. <i>resource_name</i>	UPDATE	JVMSERVER
SET LIBRARY				UPDATE	LIBRARY
SET MODENAME				UPDATE	MODENAME
SET MONITOR				UPDATE	MONITOR
SET MQCONN See note “13” on page 113				UPDATE	MQCONN
SET MQMONITOR				UPDATE	MQMON
SET NETNAME				UPDATE	TERMINAL
SET PIPELINE				UPDATE	PIPELINE
SET PROCESSTYPE See note “10” on page 113	XPTT			UPDATE	PROCESSTYPE
SET PROGRAM	XPPT	UPDATE	PROGRAM	UPDATE	PROGRAM

Table 10. Resource and command check cross-reference (continued)

EXEC CICS COMMAND	RESOURCE CHECK			CHECK CLASS=XCMD	
	CLAS S	ACCESS	RESOURCE	ACCESS	RESOURCE
SET PROGRAM REPLICATION See note “16” on page 113				ALTER	REPLICATION
SET STATISTICS				UPDATE	STATISTICS
SET SYSDUMPCODE See note 15				UPDATE	SYSDUMPCODE
SET SYSTEM				UPDATE	SYSTEM
SET TASK				UPDATE	TASK
SET TCLASS				UPDATE	TCLASS
SET TCPIP				UPDATE	TCPIP
SET TCPIPSERVICE				UPDATE	TCPIPSERVICE
SET TDQUEUE See note “3” on page 112	XDCT	UPDATE	TDQUEUE	UPDATE	TDQUEUE
SET TEMPSTORAGE				UPDATE	TEMPSTORAGE
SET TERMINAL				UPDATE	TERMINAL
SET TRACEDEST				UPDATE	TRACEDEST
SET TRACEFLAG				UPDATE	TRACEFLAG
SET TRACETYPE				UPDATE	TRACETYPE
SET TRANCLASS				UPDATE	TCLASS
SET TRANDUMPCODE				UPDATE	TRANDUMPCODE
SET TRANSACTION	XPCT	UPDATE	TRANSID	UPDATE	TRANSACTION
SET TSQNAME See note “4” on page 112	XTST	UPDATE	TSQUEUE	UPDATE	TSQUEUE
SET TSQUEUE See note “4” on page 112	XTST	UPDATE	TSQNAME	UPDATE	TSQUEUE
SET UOW				UPDATE	UOW
SET UOWLINK				UPDATE	UOWLINK
SET URIMAP				UPDATE	URIMAP
SET VTAM				UPDATE	VTAM

Table 10. Resource and command check cross-reference (continued)

EXEC CICS COMMAND	RESOURCE CHECK			CHECK CLASS=XCMD	
	CLAS S	ACCESS	RESOURCE	ACCESS	RESOURCE
SET WEB				UPDATE	WEB
SET WEBSERVICE				UPDATE	WEBSERVICE
SET WLMHEALTH				UPDATE	WLMHEALTH
SET XMLTRANSFORM	XRES	UPDATE	XMLTRANSFORM.resource_name	UPDATE	XMLTRANSFORM
SIGNOFF					
SIGNON					
SPOOLCLOSE					
SPOOLOPEN					
SPOOLREAD					
SPOOLWRITE					
START See note “7” on page 113	XPCT	READ	TRANSID		
STARTBR	XFCT	READ	FILE		
STARTBROWSE ACTIVITY See note “9” on page 113	XFCT	READ	BTS REPOSITORY FILE		
STARTBROWSE CONTAINER (BTS) See note “9” on page 113	XFCT	READ	BTS REPOSITORY FILE		
STARTBROWSE EVENT See note “9” on page 113	XFCT	READ	BTS REPOSITORY FILE		
STARTBROWSE PROCESS See note “9” on page 113	XFCT	READ	BTS REPOSITORY FILE		
SUSPEND See note “9” on page 113	XFCT	UPDATE	BTS REPOSITORY FILE		
SYNCPOINT					

Table 10. Resource and command check cross-reference (continued)

EXEC CICS COMMAND	RESOURCE CHECK			CHECK CLASS=XCMD	
	CLAS S	ACCESS	RESOURCE	ACCESS	RESOURCE
TCP/IP					
UNLOCK					
VERIFY PASSWORD					
WAIT					
WAIT JOURNALNAME	XJCT	READ	JOURNAL		
WAIT JOURNALNUM	XJCT	READ	JOURNAL		
WAITCICS					
WEB					
WRITE	XFCT	UPDATE	FILE		
WRITE JOURNALNAME	XJCT	UPDATE	JOURNAL		
WRITE JOURNALNUM	XJCT	UPDATE	DFHJNN		
WRITE OPERATOR					
WRITEQ TD	XDCT	UPDATE	TDQUEUE		
WRITEQ TS See note "4" on page 112	XTST	UPDATE	TSQUEUE TSQNAME		
XCTL	XPPT	READ	PROGRAM		

Notes:

1. The **CANCEL** command can perform two checks. One check is performed against the transaction specified on the **CANCEL** command. The other check is performed against the transaction associated with the REQID that you are canceling where applicable.
2. The **CREATE CONNECTION** command is subject to command security checking when you define a connection. For example, **CREATE CONNECTION (CON1) attribute(...)**. However, when you use the **CREATE CONNECTION COMPLETE** or **CREATE CONNECTION DISCARD** command, no command security checking is performed unless you have been authorized to use **COMPLETE** and **DISCARD** commands. The **COMPLETE** and **DISCARD** commands can be used only by those authorized to perform **CREATE CONNECTION (CON1)** and **CREATE SESSIONS (SES1)** commands. Otherwise, ILLOGIC is returned.
3. An install surrogate user check can also occur. For more information, see ["Situations where surrogate user checking applies"](#) on page 113.
4. A security check is performed for temporary storage queues when SECURITY(YES) is specified in the relevant TSMODEL resource definition, or, if you use a temporary storage table (TST), when a DFHTST TYPE=SECURITY macro is coded for the temporary storage queue.
5. No security check is performed, because the **STARTBR** command must be issued before this command. A security check is issued on the **STARTBR** command.
6. The **QUERY SECURITY** command is not controlled by resource or command checks, but it can cause them to be issued.

7. A start surrogate user check can also occur.
8. The resource check for the transid is performed only if the REQID is associated with a transaction.
9. CICS BTS API commands.
10. CICS BTS commands that are subject to command security. All other CICS BTS commands are not subject to command-level security.
11. Any BTS commands that use timing operands access the BTS LRQ file.
12. The **EXEC CICS DOCUMENT CREATE** and **INSERT** commands reference document templates using the 48-character name of the template as specified in the **TEMPLATENAME** attribute of the **DOCTEMPLATE** resource definition. However, security checking for these commands uses the name of the **DOCTEMPLATE** resource definition that corresponds to the **TEMPLATENAME** attribute.
13. When command security is active for your CICS region, to use the **EXEC CICS SET MQCONN** command to start or stop the connection to IBM MQ, users must have authority to use not only the **EXEC CICS SET MQCONN** command, but also the **EXEC CICS EXTRACT EXIT** command. If a user attempts to start or stop the connection without the authority to use the **EXEC CICS EXTRACT EXIT** command, CICS issues messages DFHXS1111 and DFHM0302. When resource security for programs (XPPT) is active for your CICS region, when using SET to set the Connection Status to Connected, the user must have sufficient authority to run the supplied CICS MQ programs.
14. A minimum of READ access is required for CICS document templates used as static Web pages, document templates used by application programs as part of application-generated responses, and document templates used with all **EXEC CICS DOCUMENT INSERT** and **EXEC CICS DOCUMENT CREATE** commands with the **TEMPLATE** option.
15. For **CHECK CLASS=XCMD**, you must have at least CONTROL access to update the **JOBLIST** or **DSPLIST** option on **SET SYSDUMPCODE**.
16. If command security checking is active, besides UPDATE access already required by **SET PROGRAM**, to issue **SET PROGRAM REPLICATION**, you must also have ALTER access to the RACF REPLICATION resource. REPLICATION is treated as a CICS resource in the RACF definitions.

Surrogate user security

A surrogate user is a RACF-defined user who is authorized to act on behalf of another user (the original user). CICS uses surrogate user security in a number of different situations.

Situations where surrogate user checking applies

A surrogate user is one who has the authority to start work on behalf of another user. A surrogate user is authorized to act for that user without knowing that other user's password. To enable surrogate user checking, **XUSER=YES** must be specified as a system initialization parameter.

CICS performs surrogate user security checking in a number of situations, using the surrogate user facility of an external security manager (ESM) such as RACF. If surrogate user checking is in force, it applies to the following items:

- The CICS default user
- PLT post-initialization processing
- Preset terminal security
- Started transactions
- The user ID associated with a CICS business transaction services (BTS) process or activity that is started by a RUN command
- The user ID associated with a transient data destination
- The user ID supplied as a parameter on an EXCI call
- The user ID supplied on the AUTHID and COMAUTHID attributes of the DB2CONN and DB2ENTRY resource definitions
- The user ID supplied on the USERID attribute of URIMAP resource definitions

- The user ID supplied on the transaction user ID of an event processing transaction start adapter.
- A CICSplex SM MAS agent started with the COLM transaction
- A CICSplex SM local MAS agent started with the CORM transaction

Note: When you use the CICSplex SM interface to install a resource definition that is subject to surrogate user security, the surrogate user that is checked by CICS is the user ID that started the CICSplex SM agent in the region where the resource is installed.

CICS default user

CICS performs a surrogate user security check against its own userid (the CICS region userid) to ensure that it is properly authorized as a surrogate of the default userid specified on the DFLTUSER system initialization parameter.

Post-initialization processing

If you specify a program list table on the PLTPI system initialization parameter, CICS checks that the region user ID is authorized as a surrogate user of the user ID specified in the PLTPIUSR system initialization parameter.

The **PLTPIUSR** system initialization parameter specifies the user ID that CICS is to use for PLT programs that run during CICS initialization. All PLT programs run under the authority of the specified user ID, including the CPLT transaction, which must be authorized to all the resources referenced by the programs.

The scope of PLT security checking is defined by the PLTPISEC system initialization parameter. This parameter specifies whether command security checks and resource security checks are to apply to PLTPI programs.

If you do not specify the **PLTPIUSR** parameter, CICS runs PLTPI programs under the authority of the CICS region user ID, in which case CICS does not perform a surrogate user check. However, the CICS region user ID must be authorized to all the resources referenced by the PLT programs. Furthermore, the CICS region user ID is associated with any transactions started by PLT programs, and therefore must be authorized to run such transactions.

Preset terminal security

When you install a terminal that is defined with a preset security userid, CICS checks that the userid performing the installation is authorized as a surrogate user of the preset userid.

This is discussed in [“Preset terminal security”](#) on page 59.

Started transactions

CICS performs surrogate user checks when you use a START command to start a transaction that is not associated with a terminal.

In the following, the user ID under which the transaction issuing the START command runs is called the *starting-userid*, and the user ID under which the started transaction runs is called the *started-userid*:

- If the TERMID option is specified on the START command, surrogate user checking does not apply. The *started-userid* is inherited from the terminal at which the transaction runs.
- If the USERID option is specified on the START command, the *started-userid* is set to that specified userid.
- If neither TERMID nor USERID is specified on the START command, the *started-userid* is set to be the same as the *starting-userid*.

CICS requires that all the user IDs associated with the transaction issuing the START are surrogates of the *started-userid*. CICS also assumes that any user ID is always a surrogate of itself. So user IDs that are the same as *started-userid* are regarded as surrogates already, and the external security manager is not called for them.

A transaction can be associated with user IDs that are different from *starting-userid* when it is using CICS intercommunication, and when it is using EDF in the two-terminal mode.

If neither **USERID** nor **TERMID** is specified on the **START** command, surrogate checking is not done, because the *starting-userid* and the *started-userid* are assumed to be the same. If an ICRX is available, CICS passes it to the started task and the started task inherits the distributed identity used by the ICRX.

Intercommunication and started transactions

If a **START** command (without **TERMID**) is function shipped or is executed from a transaction-routed transaction, the command can be subject to link security. If link security is in effect, CICS also performs a surrogate user check to verify that the userid for link security is authorized as a surrogate user to the userid for the started transaction. The surrogate check is done at this stage even if the **USERID** is omitted (if the *started-userid* is different from the link userid). For more information see [“Intercommunication link security” on page 220](#).

EDF in dual-screen mode and started transactions

If an EXEC CICS **START** command (without **TERMID**) is executed under control of EDF in dual-screen mode, CICS also performs a surrogate user check, to verify that the userid for the EDF terminal is authorized as a surrogate user of the userid for the started transaction.

This check is done even if **USERID** is omitted, if the *started-userid* is different from the EDF userid.

Surrogate user checking can be subject to link security. If EDF is in use in dual-screen mode, the security of the user executing EDF is also checked. If a **NOTAUTH** condition occurs with an EXEC CICS **START** command, this can be because of link security or because of EDF user security.

BTS processes and activities

When a CICS business transaction services (BTS) process or activity is activated by a [RUN](#) command, it may run under a different userid from that of the transaction that issues the **RUN**.

The application programmer can specify under whose authority a process or activity is to run, when it is activated by a **RUN** command, by coding the **USERID** option of [DEFINE PROCESS](#) or [DEFINE ACTIVITY](#). If the **USERID** option is omitted, the value defaults to the userid of the transaction that issues the **DEFINE** command.

If the **USERID** option is specified, CICS performs (at define time) a surrogate security check to verify that the userid of the transaction that issued the **DEFINE** command is authorized to use the userid specified by **USERID**.

Transient data trigger-level transactions

When a transient data queue is defined by **RDO** with a non-terminal trigger-level transaction and a **USERID** parameter, the user installing the definition is checked.

Likewise, when such a transient data queue is created with the **CREATE TDQUEUE** command, the user executing the command is checked.

The userid for a transient data trigger-level transaction that is not associated with a terminal can be specified on the **TDQUEUE** resource definition or on the **SET TDQUEUE** command.

Intrapartition transient data resources

CICS uses the user ID specified on transient data queue definition for security checking in any trigger-level transactions that are not associated with a terminal.

Code the **USERID** operand with the userid that you want CICS to use for security checking for the trigger-level transaction specified on the **TRANSID** operand. **USERID** is valid only when the destination facility is a file.

The trigger-level transaction runs under the authority of the specified user ID, which must be authorized to all the resources used by the transaction.

If you omit the user ID from a qualifying trigger-level entry, CICS uses the default user ID specified on the `DFLTUSER` system initialization parameter. Ensure that the user ID of any CICS region in which the transient data queue definition is installed is defined as a surrogate of all the user IDs specified in the transient data destination definition. This is because, during a cold start, CICS performs a surrogate user security check for the CICS region user ID against all the user IDs specified in transient data queue definitions that are being installed. If the surrogate security check fails, the transient data queue definition is not installed.

EXEC CICS SET TDQUEUE ATIUSERID

The system programming command, `SET TDQUEUE` with the `ATIUSERID` option, specifies the userid for a transient data trigger-level transaction that is not associated with a terminal. The destination facility must be a file.

CICS performs a surrogate user security check against the userid of the transaction that issues the `SET TDQUEUE` command, to verify that the transaction userid is authorized as a surrogate user of the userid specified on the `ATIUSERID` parameter.

Surrogate user checking for EXCI calls

A surrogate user check is performed to verify that the batch region's userid is authorized to issue DPL calls for another user (that is, it is authorized as a surrogate of the userid specified on the `DPL_request` call).

External CICS interface (EXCI) client jobs are subject to surrogate user checking. So you must authorize the batch region's userid as a surrogate of the userid specified on all `DPL_request` calls. This means the batch region's userid must have `READ` access to a profile named `execution_userid.DFHEXCI` in the `SURROGAT` general resource class (where `execution_userid` is the userid specified on the DPL call). For example, the following commands define a surrogate profile for a DPL userid, and grant `READ` access to the EXCI batch region:

```
RDEFINE SURROGAT execution_userid.DFHEXCI UACC(NONE)
PERMIT execution_userid.DFHEXCI CLASS(SURROGAT) ID(batch_region_userid)
ACCESS(READ)
```

If no userid is specified on the DPL call, no surrogate user check is performed, because the userid on the DPL call defaults to the batch region's userid.

If the batch region's userid and the CICS region userid are different, link security checking is enforced. With link security, an unauthenticated userid passed on a DPL call cannot acquire more authority than that allowed by the link security check. It can acquire only the same, or less, authority than allowed by the link security check.

The userid on DB2 AUTHID and COMAUTHID parameters

When you install a `DB2CONN` resource that specifies the `AUTHID`, `SIGNID`, or `COMAUTHID` attribute, or when you install a `DB2ENTRY` resource that specifies `AUTHID`, or when you modify one of these attributes, CICS checks that the user ID performing the operation is authorized as a surrogate user of `AUTHID`, `COMAUTHID`, or `SIGNID`. This checking also applies to the CICS region user ID during group list install on a CICS cold or initial start.

For more information about these attributes, see [DB2CONN resources](#) and [DB2ENTRY resources](#).

The `XUSER` system initialization parameter is also used to control access to the `AUTHTYPE` and `COMAUTHTYPE` attributes, but the security control for these parameters is managed through the facility general resource class. For more information, see [Security in a CICS DB2 environment](#).

The userid on URIMAP resource definitions

When you install a `URIMAP` resource definition that specifies the `USERID` attribute, or when you modify this attribute, CICS checks that the userid performing the operation is authorized as a surrogate user of

the user ID specified for the USERID attribute. This also applies to the CICS region userid during group list install on a CICS cold or initial start.

URIMAP resource definitions are used for CICS Web support. For more information about this resource definition, see [URIMAP resources](#).

RACF definitions for surrogate user checking

To enable CICS surrogate user checking, you define the appropriate SURROGAT class profiles for CICS in the RACF database and you authorize CICS surrogate users to the appropriate SURROGAT profiles.

You can define two forms of surrogate class profile names for CICS surrogate user checking. The names of these SURROGAT class profiles must conform to the following naming conventions:

userid.DFHSTART

userid represents one of the following:

- The user ID under which a started transaction is to run
- The user ID associated with a CICS business transaction services (BTS) process or activity that is started by a RUN command

userid.DFHINSTL

userid represents one of the following:

- The PLT user ID specified on the PLTPIUSR system initialization parameter
- The user ID associated with a trigger-level transaction
- The CICS default user ID specified on the DFLTUSER system initialization parameter
- The user ID specified for preset terminal security
- The user ID specified on the AUTHID or COMAUTHID parameter of a DB2 resource definition
- The user ID supplied on the USERID attribute of URIMAP resource definitions
- The user ID supplied on the transaction user ID of an event processing transaction start adapter.

If the user ID that is associated with a task issuing either a CREATE IPCONN or CREATE CONNECTION command is not an authorized surrogate of the user specified in the SECURITYNAME option, a NOTAUTH error is returned.

You can also define a form of surrogate class profile for external CICS interface (EXCI) security checking:

userid.DFHEXCI

userid represents the user specified on the DPL call in the client batch region.

To authorize a surrogate to this EXCI profile, grant the user ID of the EXCI batch region READ access.

Surrogate security checks in an EXCI batch region are independent of security definitions in the target CICS region. If SURROGCHK is specified in the EXCI options table (DFHXCOPT), surrogate security checks are performed in the EXCI client program address space regardless of the CICS security settings.

To authorize a surrogate user to one of these profiles, you must grant READ access.

You do not need to define a user as its own surrogate. In this situation, CICS bypasses the surrogate check.

The [z/OS Security Server RACF Security Administrator's Guide](#) gives more information about defining surrogate resource classes. Refer to it if you need to use RACF facilities such as generic resource classes or RACFVARS profiles to help make many RACF definitions.

Examples of RACF definitions for surrogate user checking

You define surrogate users to RACF by:

- Defining a *userid.resource_name* profile in the SURROGAT general resource class for each user requiring a surrogate user to act on their behalf. For this purpose you use the RACF RDEFINE SURROGAT command.
- Authorizing each userid that is to act as a surrogate for a user defined in a SURROGAT class profile. For this purpose you use the RACF PERMIT command.

PLT security

For PLT security checking, the CICS region user ID must be authorized as a surrogate of the PLT user ID that is defined on the **PLTPIUSR** system initialization parameter.

You must grant the CICS region user ID access to a SURROGAT resource class profile owned by the PLT user ID, as shown in the following example. In the example, the CICS region user ID is CICSHT01 and the PLT security user ID is PLTUSER:

```
RDEFINE SURROGAT PLTUSER.DFHINSTL UACC(NONE) OWNER(PLTUSER)
PERMIT PLTUSER.DFHINSTL CLASS(SURROGAT) ID(CICSHT01) ACCESS(READ)
```

In addition to enabling PLT security by defining SURROGAT profiles, ensure that when PLT security is active (through the use of the **PLTPISEC** system initialization parameter) you also add the PLT user ID to the access lists of all the resources accessed by PLT programs. For example, if you specify **PLTPISEC=RESSEC**, ensure that the PLT user ID is authorized to all the CICS resources for which security is active.

Started transactions

For started transactions, CICS can require as many as three levels of surrogate user.

(See [“Started transactions” on page 114](#) for details of the different surrogate users that can be required for a START command.)

For started transaction security at the first level, the userid of the transaction that issues the START command must be authorized as a surrogate for the userid specified on the START command.

For example, a transaction running under USERID2 issues:

```
EXEC CICS START TRANSID('TBAK') USERID('USERID1')
```

USERID2 must be defined to RACF as a surrogate of USERID1 (with READ authority). This is illustrated in the following RACF commands:

```
RDEFINE SURROGAT USERID1.DFHSTART UACC(NONE) OWNER(USERID1)
PERMIT USERID1.DFHSTART CLASS(SURROGAT) ID(USERID2) ACCESS(READ)
```

For more information about surrogate security, see [“Querying a user's surrogate authority” on page 139](#).

CICS command security

CICS command security controls the use of system programming commands; that is, commands that require the special CICS translator option, SP.

Introduction to command security

CICS command security applies to system programming commands; that is, commands that require the special CICS translator option, SP. Security checking is performed for these commands, when they are issued from a CICS application program, and for the equivalent commands that you can issue with the CEMT main terminal transaction.

[Table 11 on page 119](#) shows the commands that are subject to command security checking:

Table 11. Access required for system programming commands

Command name	Access required
COLLECT CSD DISCONNECT CSD ENDBRGROUP CSD ENDBRLIST CSD ENDBRRSRCE CSD GETNEXTGROUP CSD GETNEXTLIST CSD GETNEXTRSRCE CSD INQUIREGROUP CSD INQUIRELIST CSD INQUIRERSRCE CSD STARTBRGROUP CSD STARTBRLIST CSD STARTBRRSRCE EXTRACT STATISTICS INQUIRE	READ
DISABLE CSD ADD CSD ALTER CSD APPEND CSD COPY CSD DEFINE CSD DELETE CSD LOCK CSD REMOVE CSD RENAME CSD UNLOCK CSD USERDEFINE ENABLE EXTRACT (but not EXTRACT STATISTICS) PERFORM RESYNC SET	UPDATE
CREATE CSD INSTALL DISCARD	ALTER
<p>Note: Because the PERFORM CORBASERVER SCAN might result in the dynamic creation and installation of DJAR resources, the PERFORM CORBASERVER SCAN command requires ALTER access to the DJAR command security resource as well as UPDATE authority to the CORBASERVER resource.</p>	

Command security operates in addition to any transaction or resource security that you define for a transaction. For example, if a user is permitted to use a transaction called FILA, which issues an EXEC CICS INQUIRE FILE command that the user is *not* permitted to use, CICS issues a "not authorized" (NOTAUTH) condition in response to the command, and the command fails.

Front End Programming Interface security uses the same mechanism for authorization as the system programming commands, using the FEPIRESOURCE resource name.

Note: To determine who is allowed to use the SP option on the CICS translator, you can use RACF to control who is allowed to load the DFHEITBS table at translation time. For a description of RACF program

control, see the z/OS Security Server RACF Security Administrator's Guide. DFHEITBS is the language definition table that defines the system programming commands. It is loaded only on demand.

CICS resources subject to command security checking

For transaction and resource security checking, you identify the resources to RACF using the identifiers that you have assigned to them; for example, file names, queue names, and transaction names. However, in the case of command security, the resource identifiers are all predefined by CICS, and you use these predefined names when defining resource profiles to RACF.

The full list of resource identifiers that are subject to command security checking with the associated commands is shown in [Table 12 on page 120](#). Most of these commands are common to both the CEMT and EXEC CICS interfaces; commands that are specific to CEMT have the CEMT preface.

Resource identifier	Related CICS commands
ASSOCIATION	INQUIRE ASSOCIATION
ATOMSERVICE	CREATE ATOMSERVICE DISCARD ATOMSERVICE INQUIRE ATOMSERVICE SET ATOMSERVICE
AUTINSTMODEL	DISCARD AUTINSTMODEL INQUIRE AUTINSTMODEL
AUTOINSTALL	INQUIRE AUTOINSTALL SET AUTOINSTALL
BRFACILITY	INQUIRE BRFACILITY SET BRFACILITY
BUNDLE	CREATE BUNDLE DISCARD BUNDLE INQUIRE BUNDLE SET BUNDLE
BUNDLEPART	INQUIRE BUNDLEPART
CAPDATAPRED	INQUIRE CAPDATAPRED
CAPINFOSRCE	INQUIRE CAPINFOSRCE
CAPOPTPRED	INQUIRE CAPOPTPRED
CAPTURESPEC	INQUIRE CAPTURESPEC
CFDTPOOL	INQUIRE CFDTPOOL
CONNECTION	CREATE CONNECTION DISCARD CONNECTION INQUIRE CONNECTION SET CONNECTION

Table 12. Resource identifiers and associated commands for CICS resources subject to command security checking (continued)

Resource identifier 	Related CICS commands
CSD	CSD ADD CSD ALTER CSD APPEND CSD COPY CSD DEFINE CSD DELETE CSD DISCONNECT CSD ENDBRGROUP CSD ENDBRLIST CSD ENDBRRSRCE CSD GETNEXTGROUP CSD GETNEXTLIST CSD GETNEXTSRCE CSD INQUIREGROUP CSD INQUIRELIST CSD INQUIRERSRCE CSD INSTALL CSD LOCK CSD REMOVE CSD RENAME CSD STARTBRGROUP CSD STARTBRLIST CSD STARTBRRSRCE CSD UNLOCK CSD USERDEFINE
DB2CONN	CREATE DB2CONN DISCARD DB2CONN INQUIRE DB2CONN SET DB2CONN
DB2ENTRY	CREATE DB2ENTRY DISCARD DB2ENTRY INQUIRE DB2ENTRY SET DB2ENTRY
DB2TRAN	CREATE DB2TRAN DISCARD DB2TRAN INQUIRE DB2TRAN SET DB2TRAN
DELETSHIPPED	INQUIRE DELETSHIPPED PERFORM DELETSHIPPED SET DELETSHIPPED
DISPATCHER	INQUIRE DISPATCHER SET DISPATCHER

Table 12. Resource identifiers and associated commands for CICS resources subject to command security checking (continued)

Resource identifier 4	Related CICS commands
DOCTEMPLATE	CREATE DOCTEMPLATE DISCARD DOCTEMPLATE INQUIRE DOCTEMPLATE SET DOCTEMPLATE
DSNAME	INQUIRE DSNAME SET DSNAME
DUMP	CEMT PERFORM SNAP PERFORM DUMP
DUMPDS	INQUIRE DUMPDS SET DUMPDS
ENQMODEL	CREATE ENQMODEL INQUIRE ENQMODEL SET ENQMODEL
EPADAPTER	INQUIRE EPADAPTER 4 SET EPADAPTER 4
EPADAPTERSET	INQUIRE EPADAPTERSET 4 SET EPADAPTERSET 4
EPADAPTINSET	INQUIRE EPADAPTINSET 4
EVENTBINDING	INQUIRE EVENTBINDING 4 SET EVENTBINDING 4
EVENTPROCESS	INQUIRE EVENTPROCESS SET EVENTPROCESS
EXCI	INQUIRE EXCI
EXITPROGRAM	DISABLE PROGRAM ENABLE PROGRAM EXTRACT EXIT RESYNC ENTRYNAME INQUIRE EXITPROGRAM
FEPIRESOURCE	Certain FEPI commands
FILE	CREATE FILE DISCARD FILE INQUIRE FILE SET FILE

Table 12. Resource identifiers and associated commands for CICS resources subject to command security checking (continued)

Resource identifier 4	Related CICS commands
HOST	INQUIRE HOST SET HOST
IPCONN	CREATE IPCONN DISCARD IPCONN INQUIRE IPCONN SET IPCONN
IRC	INQUIRE IRC SET IRC
JOURNALMODEL	CEMT INQUIRE JMODEL CREATE JOURNALMODEL DISCARD JOURNALMODEL INQUIRE JOURNALMODEL
JOURNALNAME	INQUIRE JOURNALNAME SET JOURNALNAME
JVMSERVER	CREATE JVMSERVER DISCARD JVMSERVER INQUIRE JVMSERVER SET JVMSERVER
LIBRARY	CREATE LIBRARY 4 DISCARD LIBRARY 4 INQUIRE LIBRARY 4 SET LIBRARY 4
LINE	CEMT INQUIRE LINE CEMT SET LINE
LSRPOOL	CREATE LSRPOOL
MAPSET	CREATE MAPSET
MODENAME	INQUIRE MODENAME SET MODENAME
MONITOR	INQUIRE MONITOR SET MONITOR
MQCONN	CREATE MQCONN DISCARD MQCONN INQUIRE MQCONN SET MQCONN

Table 12. Resource identifiers and associated commands for CICS resources subject to command security checking (continued)

Resource identifier 4	Related CICS commands
MQMON	CREATE MQMONITOR DISCARD MQMONITOR INQUIRE MQMONITOR SET MQMONITOR
MVSTCB	COLLECT STATISTICS INQUIRE MVSTCB
OSGIBUNDLE	INQUIRE OSGIBUNDLE 4
OSGISERVICE	INQUIRE OSGISERVICE 4
PARTITIONSET	CREATE PARTITIONSET
PARTNER	CREATE PARTNER DISCARD PARTNER INQUIRE PARTNER
PIPELINE	CREATE PIPELINE DISCARD PIPELINE INQUIRE PIPELINE PERFORM PIPELINE SET PIPELINE
PROCESSTYPE	CEMT INQUIRE PROCESSTYPE CEMT SET PROCESSTYPE CREATE PROCESSTYPE DISCARD PROCESSTYPE
PROFILE	CREATE PROFILE DISCARD PROFILE INQUIRE PROFILE
PROGRAM	CREATE PROGRAM 4 DISCARD PROGRAM 4 INQUIRE PROGRAM 4 SET PROGRAM 4 SET PROGRAM REPLICATION 5
REQID	INQUIRE REQID
RESETTIME	PERFORM RESETTIME 3
RRMS	INQUIRE RRMS
SECURITY	PERFORM SECURITY REBUILD PERFORM SSL REBUILD
SESSIONS	CREATE SESSIONS
SHUTDOWN	PERFORM SHUTDOWN 2

Table 12. Resource identifiers and associated commands for CICS resources subject to command security checking (continued)

Resource identifier 1	Related CICS commands
STATISTICS	COLLECT STATISTICS EXTRACT STATISTICS PERFORM STATISTICS RECORD INQUIRE STATISTICS SET STATISTICS
STORAGE	INQUIRE STORAGE
STREAMNAME	INQUIRE STREAMNAME
SUBPOOL	INQUIRE SUBPOOL
SYSDUMPCODE	INQUIRE SYSDUMPCODE 3 SET SYSDUMPCODE 3
SYSTEM	INQUIRE SYSTEM SET SYSTEM
TASK	INQUIRE TASK SET TASK
TCLASS	CREATE TRANCLASS DISCARD TRANCLASS INQUIRE TRANCLASS SET TRANCLASS INQUIRE TCLASS SET TCLASS
TCPIP	INQUIRE TCPIP SET TCPIP
TCPIPSERVICE	CREATE TCPIPSERVICE DISCARD TCPIPSERVICE INQUIRE TCPIPSERVICE SET TCPIPSERVICE
TDQUEUE	CREATE TDQUEUE DISCARD TDQUEUE INQUIRE TDQUEUE SET TDQUEUE
TEMPSTORAGE	INQUIRE TEMPSTORAGE SET TEMPSTORAGE

Table 12. Resource identifiers and associated commands for CICS resources subject to command security checking (continued)

Resource identifier 1	Related CICS commands
TERMINAL	INQUIRE NETNAME SET NETNAME CREATE TERMINAL DISCARD TERMINAL INQUIRE TERMINAL SET TERMINAL
TRACEDEST	INQUIRE TRACEDEST SET TRACEDEST
TRACEFLAG	INQUIRE TRACEFLAG SET TRACEFLAG
TRACETYPE	INQUIRE TRACETYPE SET TRACETYPE
TRANDUMPCODE	INQUIRE TRANDUMPCODE 3 SET TRANDUMPCODE 3
TRANSACTION	CREATE TRANSACTION 4 DISCARD TRANSACTION 4 INQUIRE TRANSACTION 4 SET TRANSACTION 4
TSMODEL	CREATE TSMODEL DISCARD TSMODEL INQUIRE TSMODEL
TSPool	INQUIRE TSPool
TSQUEUE	INQUIRE TSQUEUE
TSQNAME	INQUIRE TSQNAME SET TSQNAME
TYPETERM	CREATE TYPETERM
UOW	INQUIRE UOW SET UOW
UOWDSNFAIL	INQUIRE UOWDSNFAIL
UOWENQ	INQUIRE UOWENQ
UOWLINK	SET UOWLINK INQUIRE UOWLINK

Table 12. Resource identifiers and associated commands for CICS resources subject to command security checking (continued)

Resource identifier ⁴	Related CICS commands
URIMAP	CREATE URIMAP ⁴ DISCARD URIMAP ⁴ INQUIRE URIMAP ⁴ SET URIMAP ⁴
VTAM	INQUIRE VTAM SET VTAM
WEB	INQUIRE WEB SET WEB
WEBSERVICE	CREATE WEBSERVICE DISCARD WEBSERVICE INQUIRE WEBSERVICE SET WEBSERVICE
WLMHEALTH	INQUIRE WLMHEALTH SET WLMHEALTH
XMLTRANSFORM	INQUIRE XMLTRANSFORM SET XMLTRANSFORM

Note:

1. If you are using prefixing, the value specified by the SECPRFX parameter must be prefixed to the command resource name.
2. Be particularly cautious when authorizing access to these and any other CICS commands that include a SHUTDOWN option.
3. See “CEMT considerations” on page 129.
4. Bundle command security applies when you use SPI commands to perform an action on a BUNDLE resource, and in that process you install, enable, disable, or discard a dynamically generated resource of this type that was defined in the CICS bundle. No CICS command security applies when you install, enable, disable, or discard a dynamically generated resource of this type through an application or platform. For more information, see [Security for bundles](#).
5. **SET PROGRAM REPLICATION** has an additional command security checking beyond **SET PROGRAM**. For more information, see “Resource and command check cross-reference” on page 96.

Resource profile examples

If you are running CICS with command security, define resource profiles to RACF, with access lists as appropriate, using the resource names in [Table 12 on page 120](#) as the profile names. Alternatively, you can create resource group profiles in the VCICSCMD class.

In the following example, the **RDEFINE** command defines a profile named CMDSAMP. The commands that are protected by this profile are specified on the ADDMEM operand. The PERMIT command allows a group of users to issue the commands for INQUIRE:

```
RDEFINE VCICSCMD CMDSAMP UACC(NONE)
NOTIFY(sys_admin_userid)
ADDMEM(AUTINSTMODEL, AUTOINSTALL, CONNECTION,
```

```
DSNAME, TRANSACTION, TRANDUMPCODE, VTAM)
PERMIT CMLSAMP CLASS(VICSCMD) ID(operator_group) ACCESS(READ)
```

The second example defines a profile called CMLSAMP1 with the same commands in the ADDMEM operand, as in the previous example. The **PERMIT** command allows a group of users to issue PERFORM, SET, and DISCARD against these commands:

```
RDEFINE VICSCMD CMLSAMP1 UACC(NONE)
          NOTIFY(sys_admin_userid)
          ADDMEM(AUTINSTMODEL, AUTOINSTALL, CONNECTION,
               DSNAME, TRANSACTION, TRANDUMPCODE, VTAM)
PERMIT CMLSAMP1 CLASS(VICSCMD) ID(op_group_2) ACCESS(UPDATE)
```

If you are running CICS with SEC=YES, users require the access levels shown in [“Resource and command check cross-reference”](#) on page 96.

Parameters for specifying command security

In addition to the **SEC** and **SECPRFX** system initialization parameters, CICS provides the **XCMD** system initialization parameter and the CMDSEC attribute on the TRANSACTION resource definition option to enable you to specify that you want command security.

These parameters are summarized as follows:

XCMD system initialization parameter

Use the XCMD system initialization parameter to specify whether you want command security active in the CICS region, and, optionally, to specify the RACF resource class name in which you have defined the command security profiles.

If you are using the IBM-supplied RACF resource class names for CICS command profiles (CCICSCMD and VICSCMD), specify XCMD=YES. CICS then requests RACF to build the in-storage profiles from these default resource classes.

If you are using installation-defined resource class names for CICS command profiles, specify XCMD=user_class, and CICS requests RACF to build the in-storage profiles from your own installation-defined resource classes.

If you do not want command security in a CICS region, specify XCMD=NO.

The CMDSEC system initialization parameter

You can force the effect of CMDSEC=YES for all CICS transactions by specifying the CMDSEC=ALWAYS system initialization parameter. The CMDSEC option is recommended for installations that need total control of the system programming commands.

The CMDSEC transaction definition attribute

You specify which transactions you want command security to apply to by using the CMDSEC attribute on the TRANSACTION resource definition, as follows:

CMDSEC(NO)

You do not want command security checking the transaction.

CMDSEC(YES)

You want command security checking on the system programming commands in [Table 11](#) on page 119.

For each of these commands issued in a user application or by the CICS-supplied transactions CEMT and CECI, CICS calls RACF to check that the terminal operator who initiated the transaction has authority to use the command for the specified resource.

To view all of the attributes of this resource, see [TRANSACTION resources](#)

Security checking of transactions running under CEDF

When a transaction is run under the CEDF transaction, CICS takes into account the security settings for the target transaction only.

When a transaction runs under the CEDF transaction, CICS uses the CMDSEC attribute in the definition of the target transaction. The values of CMDSEC and RESSEC for CEDF are not considered.

The IBM-supplied definition of CEDF in the DFHEDF group specifies CMDSEC(YES). Definitions in the IBM-supplied groups cannot be modified, so to change the definitions, copy them to another group.

When CEBR or CECI is invoked from within EDF it is transaction-attach checked.

When CEDF is used to test a transaction, the authority of the user executing the transaction being tested is checked. For each resource accessed by the tested transaction, the user must have access authority, otherwise a NOTAUTH condition is raised. This applies to all resource checks:

- Transaction-attach
- CICS resource
- CICS command
- Non-CICS resources accessed through the QUERY SECURITY command
- Surrogate user

Note: When one of the following EXEC CICS commands are issued by a transaction running under CEDF, the password or password phrase (and new password or password phrase, where applicable) is blanked out:

```
CHANGE PASSWORD  
CHANGE PHRASE  
SIGNON  
VERIFY PASSWORD  
VERIFY PHRASE
```

CEMT considerations

In general, the resources that the CICS-supplied CEMT main terminal transaction operates on are the same as the equivalent system programming commands.

The equivalent system programming commands are shown in [Table 11 on page 119](#). If, in addition to normal transaction-attach security, you are using command security, you must ensure that authorized users of CEMT are also authorized for the CICS commands, as appropriate. If a user is authorized to initiate the CEMT transaction, but is not authorized for the resources on which the system programming commands in [Table 11 on page 119](#) depend, CICS returns a NOTAUTH condition. To allow your system programmers to use the CEMT command in a command security environment, give them UPDATE access to the group profile that protects commands on which you want them to issue the PERFORM, SET, and DISCARD commands. UPDATE authority should be given to users specifying XPPT=YES and XCMD=YES when they issue a CEMT SET PROG(yyy) command. and you should provide READ access to the group profile that protects the commands on which you want them to issue only INQUIRE and COLLECT commands.

```
PERMIT profile_name CLASS(VCICSCMD) ID(user or group) ACCESS(READ)  
PERMIT profile_name CLASS(VCICSCMD) ID(user or group) ACCESS(UPDATE)
```

Authorization failures in application programs

CICS returns a RESP2 value of 100 for command security failures, a value of 101 for resource security failures, and a value of 102 for surrogate security failures.

If you are running with CICS command security, CICS returns the NOTAUTH condition, RESP value 70, to your application, which is the same condition as for a resource security failure. CICS also issues message

DFHXS1111 to the CICS security transient data destination CSCS. To test for this value in your application, it is recommended that you code DFHRESP(NOTAUTH) rather than explicitly coding a value.

To distinguish between a command security failure, a resource security failure, and a surrogate security failure, check the RESP2 value:

- For a command security failure, CICS returns a value of 100 in RESP2.
- For a resource security failure, a value of 101 is returned in RESP2.
- For a surrogate security failure, a value of 102 is returned in RESP2.

Security checking using the QUERY SECURITY command

Use the **QUERY SECURITY** command in an application program to determine the level of access that the transaction user has to a particular resource. The **QUERY SECURITY** command does not grant or deny access to a resource. Instead, the application program uses the values returned by the command to determine what action to take.

How QUERY SECURITY works

How **QUERY SECURITY** works depends on several factors.

- Whether SEC=YES or SEC=NO is specified in the system initialization parameters
- The value that is specified for the SECPRFX system initialization parameter
- Which resource classes are active
- Whether the transaction that is issuing the request is subject to transaction routing, and if so:
 - Which ATTACHSEC parameter was specified on the connection definition
 - For RESTYPE('PSB') only, whether the PSBCHK system initialization parameter is specified as YES or NO

Note: **QUERY SECURITY** is **not** affected by the RESSEC and CMDSEC keywords on the transaction definition.

There are two distinct forms of the QUERY SECURITY command, depending on the options chosen.

- QUERY SECURITY RESTYPE
- QUERY SECURITY RESCLASS

The SEC system initialization parameter

The SEC system initialization parameter specifies what level of external security you want CICS to use.

Table 13 on page 130 assumes that the relevant resource class is active; for example, that XFCT=YES is specified when QUERY SECURITY RESTYPE('FILE') is issued.

SEC	RACF Access	Query Security Read	Query Security Update	Query Security Control	Query Security Alter
YES	NONE READ UPDATE CONTROL ALTER	notreadable readable readable readable readable	notupdatable notupdatable updatable updatable updatable	notctrlable notctrlable notctrlable ctrlable ctrlable	notalterable notalterable notalterable notalterable alterable
NO	n/a	readable	updatable	ctrlable	alterable

The SECPRFX system initialization parameter

The SECPRFX system initialization parameter determines whether CICS applies a prefix to the RESID option on the QUERY SECURITY command. For example, if you issue the following command:

```
QUERY SECURITY RESTYPE('FILE') RESID('PAYFILE')
```

- When SECPRFX=YES, CICS applies the CICS region userid as a prefix, and calls RACF to check the user's access to *cics_region_userid*.PAYFILE.
- When SECPRFX=*prefix*, CICS applies the prefix that is supplied, and calls RACF to check the user's access to *prefix*.PAYFILE.
- If SECPRFX=NO is specified, CICS does not apply a prefix, and calls RACF to check the user's access to PAYFILE.

Resource class system initialization parameters

Table 13 on page 130 shows how the **QUERY SECURITY RESTYPE** command works if the system initialization parameter for the relevant resource class (for example, XFCT) is active. If, however, the relevant *Xname* parameter is **not** active (for example, if XFCT=NO was specified), the resource is READABLE, UPDATABLE, CTRLABLE and ALTERABLE.

Transaction routing

When the QUERY SECURITY command is issued from a transaction that was routed to a remote system, CICS checks the link user's access to the specified resource, and the terminal user's access to the resource, if appropriate.

For more information, see [IPIC link security](#), [Link security with LU6.2](#), or [Link security with MRO](#), depending upon the environment you are using.

To perform a check against the terminal user as well as the link user when transaction routing a QUERY SECURITY RESTYPE('PSB') RESID(*psb_name*), the following conditions must both be satisfied:

- ATTACHSEC on the connection definition must not be LOCAL (that is, it can be IDENTIFY, PERSISTENT, MIXIDPE, or VERIFY).
- PSBCHK=YES must be specified as a system initialization parameter in the remote system.

The RESTYPE option

Use the **QUERY SECURITY** command with the RESTYPE option to query access levels to CICS resources (including DB2 resource definitions) contained in the classes activated at initialization by RACLIST.

The response to the **QUERY SECURITY** command indicates the result of a resource check on this resource. If the resource is not defined to RACF, CICS does not grant access and the response is NOTREADABLE. Ensure the length of the resource name passed to RACF with a RESTYPE request is the actual maximum length for that resource type.

RESTYPE values

RESTYPE is a resource type that corresponds to one of the *Xname* system initialization parameters.

RESTYPE can take any of the values shown in [Table 14 on page 131](#).

Table 14. QUERY SECURITY RESTYPE values	
RESTYPE value	Xname parameter
ATOMSERVICE	XRES
BUNDLE	XRES
DB2ENTRY	XDB2

Table 14. QUERY SECURITY RESTYPE values (continued)

RESTYPE value	Xname parameter
DOCTEMPLATE	XRES
EPADAPTER	XRES
EPADAPTERSET	XRES
EVENTBINDING	XRES
FILE	XFCT
JOURNALNAME	XJCT
JOURNALNUM <u>1</u>	XJCT
JVMSERVER	XRES
PROGRAM	XPPT
PSB	XPSB
SPCOMMAND <u>2</u>	XCMD
TDQUEUE	XDCT
TRANSACTION	XPCT
TRANSATTACH	XTRAN
TSQUEUE	XTST
TSQNAME	XTST
XMLTRANSFORM	XRES

1. Supported for compatibility with earlier releases.
2. SPCOMMAND is a resource type that you can use to specify a RESID for a command.

The **XHFS** system initialization parameter controls resource security for z/OS UNIX files. This parameter does not have a corresponding RESTYPE value on the **QUERY SECURITY** command. Access controls for z/OS UNIX files follow the system of permissions used by z/OS UNIX System Services, so they operate in a different way.

RESID values

In all cases (except for the SPCOMMAND resource type), the resource identifiers (RESID values) are defined by your installation.

When defining RESID values, be aware of the effects of using blanks (X'40') in resource identifiers. For example, in:

```
QUERY SECURITY RESTYPE('PSB') RESID('A B')
```

the blank delimits the RESID and causes RACF to use a resource name of A.

For SPCOMMAND, the identifiers are predetermined by CICS. The list of possible RESID values for SPCOMMAND is as follows:

- ASSOCIATION
- ATOMSERVICE
- AUTINSTMODEL
- AUTOINSTALL
- BRFACILITY

- BUNDLE
- BUNDLEPART
- CAPDATAPRED
- CAPINFOSRCE
- CAPOPTPRED
- CAPTURESPEC
- CFDTPOOL
- CONNECTION
- CSD
- DB2CONN
- DB2ENTRY
- DB2TRAN
- DISPATCHER
- DOCTEMPLATE
- DSNAME
- DUMP
- DUMPDS
- ENQUEUE
- EPADAPTER
- EPADAPTERSET
- EPADAPTINSET
- EVENTBINDING
- EVENTPROCESS
- EXCI
- EXITPROGRAM
- FEPIRESOURCE
- FILE
- HOST
- IPCONN
- IRC
- JOURNALMODEL
- JOURNALNAME
- JVMSERVER
- LIBRARY
- MODENAME
- MONITOR
- MQCONN
- MQMON
- MVSTCB
- OSGIBUNDLE
- OSGISERVICE
- PARTNER
- PIPELINE

- PROCESS
- PROFILE
- PROGRAM
- REQID
- REQUEST
- RESETTIME
- RRMS
- SECURITY
- SHUTDOWN
- STATISTICS
- STORAGE
- SUBPOOL
- SYSDUMPCODE
- SYSTEM
- TASK
- TCLASS
- TCPIP
- TCPIPSERVICE
- TDQUEUE
- TEMPSTORAGE
- TERMINAL
- TRACEDEST
- TRACEFLAG
- TRACETYPE
- TRANDUMPCODE
- TRANSACTION
- TSQUEUE
- TSMODEL
- TSPool
- TYPETERM
- UOW
- UOWDSNFAIL
- UOWENQ
- UOWLINK
- URIMAP
- VOLUME
- VTAM
- WEB
- WEBSERVICE
- XMLTRANSFORM

Note: VTAM is now the z/OS Communications Server.

QUERY SECURITY RESTYPE enables an application program to request from RACF the level of access a terminal user has to the specified resource for the environment in which the transaction is running.

Before calling RACF, CICS checks that the resource is installed. If the resource does not exist, CICS does not call RACF and returns the NOTFND condition. However, note that this check is *not* made for PSBs.

When the RESTYPE is TRANSATTACH and the transaction specified on the RESID parameter is unknown in the local region, a NOTFND condition is returned. However, if dynamic transaction routing is being used, there is no need for the transaction to be installed in the terminal-owning region. The transaction specified on the DTRTRAN system initialization parameter is attached if an unknown transaction identifier is entered.

Application programmers should be aware that the NOTFND condition does not necessarily indicate that a terminal user will be unable to enter a transaction identifier, because the transaction may be routed dynamically.

Examples of values returned by QUERY SECURITY RESTYPE

This section gives a number of examples of the values returned by **QUERY SECURITY RESTYPE**, depending on what has been specified in the system initialization parameters.

SEC=NO

When SEC=NO is specified, issuing:

```
QUERY SECURITY RESTYPE('FILE') RESID('PAYFILE') ALTER(alter_cvda)
```

returns:

```
alter_cvda = DFHVALUE(ALTERABLE)
```

because SEC=NO means that no security checking is done for the entire CICS region.

SEC=YES and XFCT=NO

When SEC=YES and XFCT=NO are specified, issuing:

```
QUERY SECURITY RESTYPE('FILE') RESID('PAYFILE') ALTER(alter_cvda)
```

returns:

```
alter_cvda = DFHVALUE(ALTERABLE)
```

because XFCT=NO means that no security checking is done for files.

SEC=YES, XDCT=YES, and SECPRFX=NO

When SEC=YES, XDCT=YES, and SECPRFX=NO are specified, issuing:

```
QUERY SECURITY RESTYPE('TDQUEUE') RESID('TDQ1') READ(read_cvda)
```

returns:

```
read_cvda = DFHVALUE(READABLE)
```

if the user has READ (or higher) access to 'TDQ1' in the DCICSDCT class or the ECICSDCT group class.

SEC=YES, XTRAN=YES, and SECPRFX=YES

When SEC=YES, XTRAN=YES, and SECPRFX=YES are specified, issuing:

```
QUERY SECURITY RESTYPE('TRANSATTACH') RESID('TRN1') READ(read_cvda)
```

returns:

```
read_cvda = DFHVALUE(NOTREADABLE)
```

if the user **does not** have READ (or higher) access to `cics_region_userid.TRN1` in the TCICSTRN class or GCICSTRN group class.

SEC=YES, XTRAN=YES, and SECPRFX=YES

When SEC=YES, XTRAN=YES, and SECPRFX=YES are specified, issuing:

```
QUERY SECURITY RESTYPE('TRANSATTACH') RESID('TRN1') READ(read_cvda)
```

returns:

```
read_cvda = DFHVALUE(NOTREADABLE)
```

if the user **does not** have READ (or higher) access to `cics_region_userid.TRN1` in the TCICSTRN class or GCICSTRN group class.

SEC=YES, XCMD=\$USRCMD, and SECPRFX=prefix

When SEC=YES, XCMD=\$USRCMD, and SECPRFX=prefix are specified, issuing:

```
QUERY SECURITY RESTYPE('TRANSATTACH') RESID('TRN1') READ(read_cvda)
```

returns:

```
read_cvda = DFHVALUE(NOTREADABLE)
```

if the user **does not** have READ (or higher) access to `prefix.TRN1` in the TCICSTRN class or GCICSTRN group class.

The RESCLASS option

Use the QUERY SECURITY command with the RESCLASS option when you want to query access levels for non-CICS resources.

RESCLASS is the name of a valid RACF general resource class, such as TERMINAL, FACILITY, or a similar installation-defined resource class. See [“RACF classes for protecting system resources”](#) on page 20. The class name identified by RESCLASS is treated literally, with no translation.

Note: The RACF classes DATASET, GROUP, and USER do not appear in the class descriptor table (CDT), which means that you cannot query against these classes.

Prefixing, as specified in the SECPRFX system initialization parameter, does not apply to QUERY SECURITY RESCLASS. That is, CICS does **not** prefix the RESID with the CICS-region userid, nor with a user-specified prefix, before calling RACF.

If SEC=NO is specified in the system initialization parameters, QUERY SECURITY RESCLASS always returns READABLE, UPDATABLE, CTRLABLE and ALTERABLE.

For QUERY SECURITY RESCLASS, both the RESID **and** the RESIDLENGTH option must be specified. The maximum length of a resource (RESID) within a RACF class is specified in the class descriptor table (CDT). When defining RESID values, you should be aware of the effects of including blanks (X'40') in RESIDs. For example, in:

```
QUERY SECURITY RESCLASS('MYCLASS') RESID('MY PROFILE') RESIDLENGTH(10)
```

the presence of a blank causes an INVREQ condition. This is because RACF does not allow blanks to be embedded in a profile name.

Note: To determine access to CICS resources you should normally use RESTYPE, when the resource class is determined by the *Xname* system initialization parameter. However, if, for special reasons, you want to inquire about specific CICS resource classes, you should note that the class name must be the member class, and **not** the group class; that is, CCICSCMD, and not VCICSCMD. The profiles in the grouping class are checked automatically if the member class has been activated by RACLIST. For example, if SEC=YES, and XCMD=YES are specified, both CCICSCMD and VCICSCMD are activated by RACLIST in the CICS region, which means that QUERY SECURITY RESCLASS('CCICSCMD') checks profiles in both CCICSCMD and VCICSCMD.

CICS can RACLIST groups only if the relevant *Xname* classes are active (for example, XCMD=YES or XCMD=\$USRCMD).

You can also use the RESCLASS option for querying access to DB2ENTRY resources defined in a user-defined resource class, which you specify to CICS on the XDB2 system initialization parameter. The rules about activating classes by means of the RACLIST command also apply to DB2ENTRY resource classes named on the XDB2 system initialization parameter. See [“Resource classes for DB2ENTRYs” on page 22](#) for more information about user-defined DB2ENTRY resource classes.

Issuing QUERY SECURITY RESCLASS('TERMINAL') checks profiles in both TERMINAL and GTERMINL (the terminal grouping class) only if the TERMINAL class has been activated by RACLIST at the system level by the command:

```
SETROPTS RACLIST(TERMINAL)
```

For **non-CICS** resource classes, you can issue the SETROPTS RACLIST(classname) command to perform a global RACLIST. See [“Specifying user-defined resources to RACF” on page 137](#) for details.

Specifying user-defined resources to RACF

If you want to use the **QUERY SECURITY** command with the RESCLASS option, you may need to create user-defined resources within user-defined classes to represent the non-CICS resources that you want to query.

To do this:

1. Add entries to the RACF class descriptor table (CDT) and to the RACF router table.
2. Activate the new classes, define your resources in the new classes, and grant your users access to the resources.

Note: To improve the performance of **QUERY SECURITY**, consider loading the new resource profiles into virtual storage.

Adding new resource classes to the class descriptor table

The RACF class descriptor table has a system-defined part, and an installation-defined part named ICHRRCDE.

Procedure

1. Add new resource classes to ICHRRCDE by coding the ICHERCDE macro:

Specify the length of the resource name in the MAXLNTH. Specify a length sufficient to contain:

- An eight-character prefix
- A period (.)
- The name of the resource type

Remember: For RDO resources, the name of the resource type can be up to 12 characters long, even though the name of the resource itself is shorter. For example, "PARTITIONSET" contains 12 characters, but the names of PARTITIONSET resources are restricted to eight characters in length. Thus for RDO resources, with resource type names of up to 12 characters, specify MAXLNTH=23.

For example, to add to the CDT a new class \$FILEREC, and a corresponding (optional) group class \$GILEREC, add the following macros to ICHRRCDE:

```
$FILEREC ICHERCDE CLASS=$FILEREC,      Entity or Member class      *
          GROUP=$GILEREC,              *
          ID=192,                        *
          MAXLNTH=17,                    *
          RACLIST=ALLOWED,              *
          FIRST=ALPHANUM,                *
          OTHER=ANY,                     *
          POSIT=42,                       *
          OPER=NO,                        *
```

```

DFTUACC=NONE
$GILEREC ICHERCDE CLASS=$GILEREC,      Group class      *
        MEMBER=$FILEREC,                *
        ID=191,                          *
        MAXLNTH=17,                      *
        FIRST=ALPHANUM,                  *
        OTHER=ANY,                       *
        POSIT=42,                        *
        OPER=NO,                         *
        DFTUACC=NONE                     *

```

Note: By default, uppercase profile names are used for the class specified by the CLASS operand. If you want to allow mixed-case profile names and preserve the case of profile names for the specified class, specify CASE=ASIS when you code the ICHERCDE macro.

2. Add the same classes to the RACF router table, ICHFR01, by coding the ICHRFRTB macro:

```

ICHRFRTB CLASS=$FILEREC, ACTION=RACF
ICHRFRTB CLASS=$GILEREC, ACTION=RACF

```

Both the ICHERCDE and ICHRFRTB macros are described in [z/OS Security Server RACF Macros and Interfaces](#).

3. When you have re-created the two modules ICHRR01 and ICHFR01, re-IPL your MVS system to bring them into use.

Activating the user-defined resource classes

Once you have installed the new classes in your system, it is necessary to activate them in RACF before they can be used.

This has to be done by a user with system-SPECIAL authority, who enters the following commands under TSO:

```

SETROPTS CLASSACT($FILEREC)
SETROPTS GENERIC($FILEREC)

```

To improve the performance of QUERY SECURITY, you should load the new resource profiles into virtual storage by using the RACLIST option. The RACLIST option is **required** if you are using the group class, because the connection between the group class and the entity class is resolved by RACLIST:

```

SETROPTS RACLIST($FILEREC)

```

You need to issue the SETROPTS commands for the entity class \$FILEREC, because the group class \$GILEREC has the same POSIT number.

Defining resources within the new class

Resources within the new classes have to be defined by a user with system-SPECIAL authority, or with CLAUTH authority in the new class.

CLAUTH authority is granted by issuing the following TSO command:

```

ALTUSER userid CLAUTH($FILEREC)

```

If you have the required authority, you can create the new resources by issuing the following TSO commands:

```

RDEFINE $FILEREC PAYFILE.SALARY UACC(NONE)
RDEFINE $FILEREC PAYFILE.TAXBAND UACC(NONE)
RDEFINE $GILEREC PERSONAL.DETAILS ADDMEM( PERSONAL.DEPT, +
                                           PERSONAL.MANAGER, +
                                           PERSONAL.PHONE) +
                                           UACC(READ)

```

Now you are ready to authorize users to use the new resources. Assume that PAYROLL is the name of a group of users who are to be permitted to update all the pay and personal details fields in an employee record. The following TSO commands grant UPDATE access to all users in the group:

```
PERMIT PAYFILE.SALARY CLASS($FILERECL) ID(PAYROLL) ACCESS(UPDATE)
PERMIT PAYFILE.TAXBAND CLASS($FILERECL) ID(PAYROLL) ACCESS(UPDATE)
PERMIT PERSONAL.DETAILS CLASS($FILERECL) ID(PAYROLL) ACCESS(UPDATE)
```

If you had previously loaded the profiles by using the RACLIST option, refresh the profiles in virtual storage by issuing the command:

```
SETROPTS RACLIST($FILERECL) REFRESH
```

Note: By default, uppercase profile names are used for the class specified by the CLASS operand. If you want to allow mixed-case profile names and preserve the case of profile names for the specified class, specify CASE=ASIS when you code the ICHERCDE macro.

Querying a user's surrogate authority

To query a user's surrogate authority, you can use the QUERY SECURITY command with the RESCLASS('SURROGAT') option.

You also need to specify the RESID and RESIDLENGTH options. The RESID value you should provide is described in “RESID values” on page 132. However, this command is **not** controlled by the XUSER system initialization parameter, so you might obtain an unexpected response of NOTREADABLE if XUSER=NO has been specified. For example, to check whether the current user is allowed to start a transaction with a new userid of NEWUSER, when XUSER=YES is specified, issue the command:

```
QUERY SECURITY RESCLASS('SURROGAT') RESID('NEWUSER.DFHSTART')
RESIDLENGTH(16) READ(read cvda)
```

Logging for QUERY SECURITY

You can control logging on the **QUERY SECURITY** command. When logging is in effect, if the terminal user does not have the requested access to the specified resource, message DFHXS1111 is issued to the CICS security transient data destination CSCS. Where relevant, RACF message ICH408I is also issued.

SMF records can also be recorded, depending on the auditing and logging options that have been specified for that resource. For more information, see the [z/OS Security Server RACF Auditor's Guide](#).

For programming information about CVDAs, refer to [CICS-value data areas \(CVDAs\)](#).

QUERY SECURITY logging options

Specify of the following options to control logging:

- LOG (the default)
- NOLOG
- LOGMESSAGE(*cvda*), where *cvda* value is 54 for LOG, or 55 for NOLOG

Examples: Using the QUERY SECURITY command for resource security checking

You can use the two forms of the **QUERY SECURITY** command in a number of different ways to customize resource security checking within an application. Typically, you can use **QUERY SECURITY** to check whether a user is authorized to use a particular transaction before displaying the transaction code in a menu. You can also use **QUERY SECURITY** to control access to data at the record or field level.

Example: Changing the level of security checking

You can use **QUERY SECURITY** to perform a different level of security checking from that which CICS would perform for application programs that specify **RESSEC(YES)** or **CMDSEC(YES)**.

For example, suppose a transaction has **RESSEC(YES)** and contains a number of **EXEC CICS READ FILE** commands and a number of **EXEC CICS WRITE FILE** commands. For each command, CICS performs a security check to ensure that the terminal user has access to the relevant file, even though the same file may be being accessed each time. An alternative to this is to switch off security checking at the transaction level by specifying **RESSEC(NO)** on the transaction definition and then, when the application starts, execute a command such as:

```
EXEC CICS QUERY SECURITY RESTYPE('FILE') RESID(file_name) UPDATE(cvda)
```

This command allows the transaction to continue without any further calls to RACF.

Note: Switching resource security checking off, using **RESSEC(NO)**, means that **all** resource checks—not just of files as in this example—are bypassed.

Example: Checking which transactions to offer a user

You can use the **QUERY SECURITY** command to check whether a user is authorized to use a particular transaction before displaying the transaction code as part of an introductory menu.

When you use the command for this purpose, you will probably want to avoid logging the checks for users who are not allowed to use certain transactions. To do this, use the **NOLOG** option.

Example: Controlling access to data at the record or field level

Normal CICS resource security checking for files operates at the file level only. You can use **QUERY SECURITY** to enable your application to control access to data at the **record** or **field** level.

To do this, define resource names (which represent records or fields within particular files) with the appropriate access authorizations for the records or fields you want to control. You could define these resources in an installation-defined RACF general resource class and then use the **QUERY SECURITY RESCLASS** command to check a terminal user's access to a specific field within a file before displaying or updating the field. (The application logic would determine which field.) For example:

```
QUERY SECURITY RESCLASS('$FILERECL') RESID('PAYFILE.SALARY')  
RESIDLENGTH(14) READ(read_cvda) NOLOG
```

where '\$FILERECL' is an installation-defined RACF general resource class.

Security for CICS-supplied transactions

This topic discusses security for CICS-supplied transactions, and contains a number of recommendations to ensure that your CICS regions are adequately protected. Where applicable, it describes the recommended security specifications that you will need for the CICS-supplied transactions defined in the group list DFHLIST, and stored in the CICS system definition data set (CSD). These recommendations cover all CICS-supplied transactions—those that are intended for use from a user terminal or console, and those that are for CICS internal use only.

Categories of CICS-supplied transactions

The RACF profile definitions for your CICS-supplied transactions are described in three categories. Each transaction is identified within a category that describes its use within CICS. Each category specifies the recommended security specifications you need, in terms of both the CICS transaction definitions and the corresponding RACF profiles.

The three categories are as follows:

Category 1 transactions

Transactions that are for CICS internal use only and must not run from a user terminal.

Category 2 transactions

Transactions that must be restricted to specific signed-on users; for example, you might want to limit access to transactions that define and install CICS resources.

Category 3 transactions

Transactions that are available to all users, whether signed-on or not. These transactions are not subject to security checking. Any security definitions for these transactions are redundant.

The three categories contain all the required CICS transactions, which are generated in their designated groups when you initialize your CICS system definition data set (CSD). The CSD does not include the CICS sample transactions (those that are in groups starting with DFH\$). Sample applications should not require RACF protection, because you are unlikely to install them on a CICS production system.

See [“Implementing CICSplex SM security” on page 165](#) for details of CICSplex SM-related transactions.

By default, all CICS transactions are subject to RACF protection (with the exception of category 3 transactions—see [“JES spool protection in a CICS environment” on page 46](#)), unless you run your CICS regions with transaction security switched off. You can do this either by:

- Specifying the system initialization parameter SEC=NO, which switches off all security checking, or
- Specifying the system initialization parameter XTRAN=NO, which switches off transaction-attach security checking only.

There is no parameter on the transaction resource definition that allows you to run with transaction security on some transactions but not others. If you are running with transaction security (SEC=YES and XTRAN=YES), CICS issues a security check for each transaction attach, other than a transaction within category 3, to establish whether the user is permitted to run that transaction.

Category 1 transactions

Category 1 transactions are never associated with a terminal. They are for CICS internal use only, and must not be started from a user terminal. CICS checks that the region user ID has the authority to attach these transactions.

If the region user ID is not authorized to access all of the category 1 transactions, CICS issues message DFHXS1113 and fails to initialize. For category 1 transactions, specify the following settings:

To CICS

RESSEC(NO) and CMDSEC(NO) on the transaction resource definition.

To RACF

UACC(NONE) and AUDIT(FAILURES) in the corresponding transaction profiles. AUDIT(FAILURES) is the default value. The access list must contain only user IDs (or groups containing user IDs) that can be specified as CICS region user IDs.

For example:

```
RDEFINE GCICSTRN CICSCAT1 UACC(NONE)
      ADDMEM(CSKP CSPQ CDBD . . . . . CXRE CSNE)
      NOTIFY(security_admin_userid)
      OWNER(userid or groupid)
PERMIT CICSCAT1 CLASS(GCICSTRN) ID(cat1grp1,...,cat1grpz) ACCESS(READ)
```

By defining these transactions to RACF with UACC(NONE) and an access list, you prevent any terminal user initiating these transactions (accidentally or otherwise). It is important, because starting these transactions at a terminal has unpredictable results. The sample CLIST DFH\$CAT1 helps you define the category 1 profiles to RACF. The sample CLIST is in library CICSSTS54.CICS.SDFHSAMP.

The table lists the category 1 transactions supported in CICS Transaction Server for z/OS, Version 5 Release 4:

- The transactions that have operator interfaces are marked by an asterisk (*). The other transactions have no operator interface.

- Transactions CGRP, CSSY, and CSTP are transaction names that are used by some CICS tasks.
- Transaction CPLT might run under a different user ID if the **PLTPIUSR** system initialization parameter is specified. For more information, see “Post-initialization processing” on page 114.

Table 15. Category 1 transactions.

The transactions that have operator interfaces are marked by an asterisk (*). The remainder therefore have no operator interface.

Transaction	Program	CSD group	Security category	Description
CATA	DFHZATA	DFHSPI	1	Defines autoinstall automatic terminal
CATD	DFHZATD	DFHSPI	1	Deletes autoinstall terminal
CDBD	DFHDBDI	DFHDBCTL	1	DBCTL disable function
CDBF	DFHD2CM3	DFHDB2	1	CICS DB2 attachment facility shutdown force transaction
CDBO	DFHDBCT	DFHDBCTL	1	DBCTL control function
CDBQ	DFHD2CM2	DFHDB2	1	CICS DB2 attachment facility shutdown quiesce transaction
CDTS	DFHZATS	DFHSPI	1	Provides remote single delete transaction
CEPD	DFHEPDS	Not required	1	Event processing dispatcher
CEPF	DFHECDF	Not required	1	Event processing deferred filtering task
CEPM	DFHEPSY	Not required	1	Event processing queue manager
CESC*	DFHCESC	DFHSIGN	1	Processes timeout and signoff for idle terminals
CEX2	DFHD2EX2	DFHDB2	1	CICS DB2 protected thread purge mechanism and other CICS DB2 services
CFCL	DFHFCDL	Not required	1	CFDT load
CFCR	DFHFERN	DFHFERN	1	Disable file in CICS bundle
CFCT	DFHFCLJ1	Not required	1	Provide tie-up records for files to a replication log at specified intervals
CFOR	DFHFCQT	Not required	1	RLS offsite recovery
CFQR	DFHFCQT	Not required	1	RLS quiesce receive
CFQS	DFHFCQT	Not required	1	RLS quiesce send
CFTL	DFHDTLX	Not required	1	Shared DT load
CFTS	DFHZATS	DFHSPI	1	Provides remote mass flag transaction
CGRP 2	DFHZCGRP	Not required	1	Provides z/OS Communications Server (previously called VTAM) persistent sessions
CHCK	DFHHCHK	Not required	1	Health Checker long running system task

Table 15. Category 1 transactions.

The transactions that have operator interfaces are marked by an asterisk (*). The remainder therefore have no operator interface.

(continued)

Transaction	Program	CSD group	Security category	Description
CIS4	DFHCIS4	DFHISCIP	1	IPIC External Security Interface (ESI) transaction
CISB	DFHISCOP	DFHISCIP	1	IPIC release IPCONN on the server side of a connection (BIS processing)
CISC	DFHISCOP	DFHISCIP	1	IPIC acquire IPCONN on the client side of a connection
CISD	DFHISCOP	DFHISCIP	1	IPIC release IPCONN on the client side of a connection
CISE	DFHISEMP	DFHISCIP	1	IPIC error and message program
CISM	DFHISRSP	DFHISCIP	1	IPIC remote scheduler
CISP	DFHISPHP	DFHISCIP	1	IPIC connection heartbeat control transaction
CISQ	DFHISLQP	DFHISCIP	1	IPIC local queue processing
CISR	DFHISRRP	DFHISCIP	1	IPIC request/response receiver
CISS	DFHISCOP	DFHISCIP	1	IPIC acquire IPCONN on the server side of a connection
CIST	DFHISCOP	DFHISCIP	1	IPIC terminate IPCONN
CISU	DFHISREU	DFHISCIP	1	IPIC recovery transaction
CISX	DFHISREX	DFHISCIP	1	IPCONN recovery and resynchronization transaction for XA clients
CIS1	DFHISPRP	DFHISCIP	1	IPIC connection heartbeat requester transaction
CITS	DFHZATS	DFHSPI	1	Provides remote autoinstall transaction
CJLR	DFHSJTHP	Not required	1	Liberty recovery transaction
CJSL	DFHSJL	Not required	1	JVM server listener (autoinstalled by CICS)
CJSP	DFHSJTHP	Not required	1	JVM server Liberty program management
CJSR	DFHSJITL	DFHJAVA	1	CICS JVM server resolution transaction
CJTR	DFHOTR	DFHOTS	1	Object Transaction Services (OTS) resynchronization transaction
CMPE	DFHMPDE	Not required	1	Policy deferred rule evaluation
CMTS	DFHZATS	DFHSPI	1	Remote mass delete transaction
COHT	EYU9XLOP	Not required	1	CICSplex SM TRAN mode history receiver task

Table 15. Category 1 transactions.

The transactions that have operator interfaces are marked by an asterisk (*). The remainder therefore have no operator interface.

(continued)

Transaction	Program	CSD group	Security category	Description
COIE	EYU9XLOP	Not required	1	CICSplex SM TRAN mode method receiver task
COIR	EYU9XLOP	Not required	1	CICSplex SM RTA EVALDEF task
COIO	EYU9XLOP	Not required	1	CICSplex SM ESSS receive task
CONA	EYU9XLOP	Not required	1	CICSplex SM MAS agent alternate long running task
COND	EYU9NPS2	Not required	1	CICSplex SM MAS shutdown transaction
CONH	EYU9XLOP	Not required	1	CICSplex SM MAS history task
CONL	EYU9XLEV	Not required	1	CICSplex SM MAS agent long running task
CONM	EYU9XLOP	Not required	1	CICSplex SM MAS monitor task
COVR	DFHZCOVR	Not required	1	Provides open z/OS Communications Server retry transaction
COWC	EYU9XLOP	Not required	1	CICSplex SM WLM garbage collection task
CPCT	DFHZPCT	DFHPSSGN	1	Catalog signed on terminals for persistent session signon retention
CPIR	DFHPIITL	DFHSTAND	1	Pipeline resolution transaction
CPIS	DFHPIR	DFHPIPE	1	WS-AT transaction that is attached when resynchronization is required
CPLT	DFHSIPLT	Not required	1	Initializes PLT processing
CRLR	DFHRLR	DFHRL	1	Bundle resource resolution transaction
CRMD	DFHZATMD	DFHSPI	1	Provides remote mass delete transaction
CRMF	DFHZATMF	DFHSPI	1	Provides remote mass flag transaction
CRSQ	DFHCRQ	DFHISC	1	Remote schedule purging (ISC)
CRST	DFHRSTK	Not required	1	Region Status long running task
CRSY	DFHRMSY	DFHRMI	1	Resource manager resynchronization
C RTP	DFHZRTP	DFHPSSGN	1	Persistent sessions restart timer transaction
CSFR	DFHFCRD	Not required	1	RLS clean up
CSFU	DFHFCU	DFHOPCLS	1	File open utility
CSHA		Not required	1	Scheduler services (autoinstalled by CICS)

Table 15. Category 1 transactions.

The transactions that have operator interfaces are marked by an asterisk (*). The remainder therefore have no operator interface.

(continued)

Transaction	Program	CSD group	Security category	Description
CSHQ	DFHSHSY	Not required	1	Scheduler services domain long running task
CSKP	DFHRMXN3	Not required	1	Writes system log activity keypoint
CSNC	DFHCRNP	DFHISC	1	Interregion control program (MRO)
CSNE	DFHZNAC	DFHVTAM	1	Provides z/OS Communications Server (previously called VTAM) node error recovery
CSOL	DFHSOL	Not required	1	TCP/IP listener (autoinstalled by CICS)
CSPQ	DFHTPQ	DFHBMS	1	Terminal page clean up (BMS)
CSQC	DFHLGQC	DFHLGQC	1	CICS quiesce after system log failure
CSSY ²	DFHAPATT	Not required	1	Provides entry point attach
CSTE	DFHTACP	DFHSTAND	1	Processes terminal abnormal conditions
CSTP ²	DFHZCSTP	Not required	1	Provides terminal control transaction
CSZI	DFHSZRMP	DFHFEPI	1	Front End Programming Interface (FEPI), only active if FEPI installed
CTSD	DFHTSDQ	Not required	1	Temporary storage delete recoverable queue
CWBG	DFHWEBGB	DFHWEB	1	CICS web support clean up transaction
CWXN	DFHWEBXN	DFHWEB	1	CICS Web support attach transaction
CWXU	DFHWEBXN	DFHWEB	1	CICS Web support USER protocol attach transaction
CXCU	DFHCXCU	DFHSTAND	1	Performs XRF tracing catchup
CXRE	DFHZXRE	DFHSTAND	1	Reconnects terminals following XRF takeover

Note:

¹ This transaction can be used only at an operating system console that has the authority to issue MODIFY commands for the CICS region.

² Transactions CGRP, CSSY, CSTP, and CSXM are transaction names that are used by some CICS tasks.

Category 2 transactions

Category 2 transactions listed here are initiated by CICS users, or are associated with CICS users. For example, a category 2 transaction can be started by an **EXEC CICS START** command that is initiated by a user running another transaction. Restrict authorizations to initiate these transactions to user IDs that belong to specific RACF groups.

For the CICS resource definitions, the supplied transactions are defined with the recommended RESSEC and CMDSEC options. Specifically, CECI, CEDF, CEMT, and CEST are supplied with RESSEC(YES) and

CMDSEC(YES). The mirror transactions are defined with RESSEC(YES). To change any of these definitions, copy them to another group. It is not advisable to change the supplied definitions of any other transactions.

For most category 2 transactions, specify them to RACF as follows:

- UACC(NONE) and AUDIT(FAILURES) in the transaction profile. AUDIT(FAILURES) is the default and does not have to be specified.
- Access list as appropriate.

It is unlikely that users require access to all the transactions in this category, so consider defining the transactions in several subcategories. You can choose to group CICS transactions in the way that best suits the needs of your installation. The following example shows one way that you might group the category 2 transactions.

The sample CLIST DFH\$CAT2 (in library CICSTS54.CICS.SDFHSAMP) can help you to define the category 2 profiles to RACF. If you want to use this example, review and edit the CLIST for your installation before running it. To use a different setup, adapt the CLIST, or provide your own. The sample groups the transactions into the following categories:

SYSADM

This category contains CCRL, CDBC, CEDA, CEMN, CEMT, CESD, CETR, and CIND.

JVMUSER

This category contains CJSA and CJSU.

Note: Depending on your security configuration, transactions CJSA and CJSU might require the CICS default user to have access. For more information, see [Security for Java applications, Configuring z/OS Connect for a CICS JSON web service](#), and [Configuring permissions for z/OS Connect Services and APIs](#).

As a security best practise, you should turn on Liberty security and avoid using the CICS default user to run application tasks. For the z/OS Connect Service, you can install a URIMAP resource that CICS uses to associate the work for the Service with a specific transaction ID in CICS and with an initial user ID.

CJSA is the default transaction ID for any web request that does not have a matching URI. Consider restricting access to CJSA to prevent any arbitrary application being run.

DEVELOPER

This category contains CADP, CEBR, CECI, CECS, CEDB, CEDF, and CEDX.

INQUIRE

This category contains CDBI, CEDC, CKBM, CKDL, CKDP, CKQC, CKRT, and CLDM.

OPERATOR

This category contains CBAM, CEOT, CEST, CIDP, CKAM, CKBM, CKBP, CKBC, CKBR, CKCN, CKDL, CKDP, CKQC, CKRS, CKRT, CKSD, CMSG, KKSQ, CRTE, CKTI, CSFE, CWTO, and DSNC.

DBCTL

This category contains CDBC, CDBI, CDBM, and CDBT.

INTERCOM

This category contains CDFS, CEHP, CEHS, CPMI, CSHR, CSMI, CSM1, CSM2, CSM3, CSM5, CTIN, and CVMI.

If you are using function shipping, the mirror transactions must be available to remote users in a function shipping environment. When a database or file is on another CICS region, CICS function ships the request to access the data. The request runs under one of the CICS-supplied mirror transactions. In this situation, the following conditions apply:

- The terminal user running the application must be authorized to use the mirror transaction. See [“Transaction security” on page 66](#).
- The terminal user must also be authorized to use the data that the mirror transaction accesses. See [“Resource security” on page 70](#). The mirror transactions are supplied with RESSEC(YES) defined;

so, even if the user's transaction specifies RESSEC(NO), the mirror transaction fails if the user is not authorized to access the data.

If you do not use resource security checking, change the mirror transaction definitions to specify RESSEC(NO). Because the mirror transactions are an IBM-protected resource, first copy these definitions into your own groups and then change them.

For a deferred **START** request, if the user transaction to be started is eligible for dynamic routing, system transaction CDFS will run and start the user transaction at the specified time. Ensure that security for CDFS is correctly configured.

WEBUSER

This category contains CWBA and CW2A.

The CICS default user requires access to the CWBA transaction initially, even if an analyzer program is then used to assign another user ID to the task. Ensure that the CICS default user that is specified in the **DFLTUSER** system initialization parameter has access to this transaction. If you use the supplied CLIST DFH\$CAT2 to create a WEBUSER RACF profile, the default user must have access to this profile.

RPCUSER

This category contains CRPA, CRPC, and CRPM.

CMCIUSER

This category contains CWWU.

PIPEUSER

This category contains CPIH, CPIL, CPIQ, and CPIA.

EVENTUSER

This category contains CEPH, CEPQ, CEPR, CEPS, and CEPT.

CEPH, CEPQ, CEPR, CEPS, and CEPT are the default EP adapter transaction IDs used when security checking is required. They are defined with RESSEC (YES) and CMDSEC (YES) options. When these options are not the ones you want, you must specify your own transaction IDs in the adapter tab **Advanced Options** section of the Event binding editor. For more information, see [Specifying EP adapter and dispatcher information](#).

ALLUSER

This category contains CMAC, CRTX, and CSGM.

Define the CICS messages and codes transaction CMAC, and the "good morning" transaction CSGM (or the transaction that is defined in the **GMTRAN** system initialization parameter) as UACC(READ) in their own group, because all users need access to them. If your installation uses CSGM, users who are not authorized to use CSGM receive message DFHAC2002 when they attempt to use CICS. Also include your "good night" transaction in this group, if you defined one with the **GNTRAN** system initialization parameter.

The following code example shows how to use RDEFINE and PERMIT commands to define the example groups for category 2 transactions.

```
RDEFINE GCICSTRN INQUIRE UACC(NONE)
        ADDMEM(CDBI, CEDC, CKBM, CKDL, CKDP, CKQC, CKRT, CLDM)
        NOTIFY(security_admin_userid)
        OWNER(userid or groupid)
RDEFINE GCICSTRN SYSADM UACC(NONE)
        ADDMEM(CCRL, CDBC, CEDA, CEMN, CEMT, CESD, CETR, CIND)
        NOTIFY(security_admin_userid)
        OWNER(userid or groupid)
PERMIT  SYSADM CLASS(GCICSTRN) ID(sysgrp1,...,sysgrpz) ACCESS(READ)
```

```
RDEFINE GCICSTRN DEVELOPER UACC(NONE)
        ADDMEM(CADP, CEBR, CECI, CECS, CEDB, CEDF, CEDG, CEDX, CEDY)
        NOTIFY(security_admin_userid)
        OWNER(userid or groupid)
PERMIT  DEVELOPER CLASS(GCICSTRN) ID(devgrp1,...,devgrpz)
RDEFINE GCICSTRN INQUIRE UACC(NONE)
        ADDMEM(CDBI, CEDC, CKBM, CKDL, CKDP, CKQC, CKRT)
        NOTIFY(security_admin_userid)
```

```

OWNER(userid or groupid)
PERMIT INQUIRE CLASS(GCICSTRN) ID(inqgrp1,..,inqgrpz)

RDEFINE GCICSTRN OPERATOR UACC(NONE)
ADDMEM(CBAM,CEOT,CEST,CIDP,CKAM,CKBM,CKBP,CKBC,CKBR,CKCN,CKDL,+
CKDP,CKQC,CKRS,CKRT,CKSD,CMMSG,CKSQ,CRTE,CKTI,CSFE,CWTO,DSNC)
NOTIFY(security_admin_userid)
OWNER(userid or groupid)
PERMIT OPERATOR CLASS(GCICSTRN) ID(opsgrp1,..,opsgrpz) ACCESS(READ)
RDEFINE GCICSTRN DBCTL UACC(NONE)
ADDMEM(CDBC,CDBI,CDBM,CDBT)
NOTIFY(security_admin_userid)
OWNER(userid or groupid)
PERMIT DBCTL CLASS(GCICSTRN) ID(dbctgrp1,..,dbctgrpz) ACCESS(READ)

RDEFINE GCICSTRN INTERCOM UACC(NONE)
ADDMEM(CEHP,CEHS,CPMI,CSHR,CSMI,CSM1,CSM2,CSM3,CSM5,CVMI,CDFS,CTIN)
NOTIFY(security_admin_userid)
OWNER(userid or groupid)
PERMIT INTERCOM CLASS(GCICSTRN) ID(intrgrp1,..,intrgrpz) ACCESS(READ)
RDEFINE GCICSTRN ALLUSER UACC(READ)
ADDMEM(CMAC,CRTX,CSGM)
NOTIFY(security_admin_userid)
OWNER(userid or groupid)
PERMIT ALLUSER CLASS(GCICSTRN) ID(allrgrp1,..,allrgrpz) ACCESS(READ)
RDEFINE GCICSTRN WEBUSER UACC(NON)
ADDMEM(CWBA,CW2A)
NOTIFY(security_admin_userid)
OWNER(userid or groupid)
PERMIT WEBUSER CLASS(GCICSTRN) ID(webgrp1,..,webgrpz) ACCESS(READ)

RDEFINE GCICSTRN RESTUSER UACC(NON)
ADDMEM(CWU)
NOTIFY(security_admin_userid)
OWNER(userid or groupid)
PERMIT WEBUSER CLASS(GCICSTRN) ID(rstrgrp1,..,rstrgrpz) ACCESS(READ)
RDEFINE GCICSTRN RPCUSER UACC(NON)
ADDMEM(CRPA,CRPC,CRPM)
NOTIFY(security_admin_userid)
OWNER(userid or groupid)
PERMIT RPCUSER CLASS(GCICSTRN) ID(rpcrgrp1,..,rpcrgrpz) ACCESS(READ)
RDEFINE GCICSTRN PIPEUSER UACC(NONE)
ADDMEM(CPIH,CPII,CPIQ,CPIA)
NOTIFY(security_admin_userid)
OWNER(userid or groupid)
PERMIT PIPEUSER CLASS(GCICSTRN) ID(pipeline_access_list)

RDEFINE GCICSTRN CMCIUSER UACC(NONE)
ADDMEM(CWU)
NOTIFY(security_admin_userid)
OWNER(userid or groupid)
PERMIT CMCIUSER CLASS(GCICSTRN) ID(cmciuser_access_list)
RDEFINE GCICSTRN EVENTUSER UACC(NONE)
ADDMEM(CEPH,CEPQ,CEPR,CEPS,CEPT)
NOTIFY(security_admin_userid)
OWNER(userid or groupid)
PERMIT EVENTUSER CLASS(GCICSTRN) ID(eventuser_access_list)
RDEFINE GCICSTRN JVMUSER UACC(NONE)
ADDMEM(CJSA)
NOTIFY(security_admin_userid)
OWNER(userid or groupid)
PERMIT JVMUSER CLASS(GCICSTRN) ID(librgrp1,..,librgrpz) ACCESS(READ)

```

Note:

1. With RESSEC(YES) and CMDSEC(YES) defined for these transactions, ensure that the user groups authorized to use the transactions are also authorized to access the CICS resources and commands that the transactions use.
2. If you protect a resource with a resource group profile, you must be careful when protecting the same resource with another profile if a user can have different access to both profiles. If the profiles are different (for example, if they have different access lists), RACF merges the profiles that are used during authorization checking. The merging might incur higher cost in checking, and it can be difficult

to determine exactly which access authority applies to a particular user. See [z/OS Security Server RACF Security Administrator's Guide](#) for further information.

Table 16. Category 2 transactions.

The transactions that have operator interfaces are marked by an asterisk (*). The remainder therefore have no operator interface.

Transaction	Program	CSD group	Security category	Description
CADP*	DFHDPLU	DFHDP	2	Application debugging profile manager
CBAM*	DFHECBAM	DFHOPER	2	BTS objects browser
CCRL*	DFHSOCRL	DFHOPER	2	CICS certificate revocation list transaction
CDBC*	DFHDBME	DFHDBCTL	2	DBCTL interface menu transaction
CDBI*	DFHDBIQ	DFHDBCTL	2	DBCTL interface inquiry transaction
CDBM*	DFHDBMP	DFHDBCTL	2	DBCTL operator transaction
CDBT	DFHDBDSC	DFHDBCTL	2	DBCTL interface disconnection transaction
CDFS	DFHDFST	DFHISC	2	Dynamic starts with interval
CEBR*	DFHEDFBR	DFHEDF	2	Browse temporary storage
CECI*	DFHECIP	DFHINTER	2	Command level interpreter
CECS*	DFHECSP	DFHINTER	2	Command level interpreter
CEDA*	DFHEDAP	DFHSPI	2	Resource definition online - full (RDO)
CEDB*	DFHEDAP	DFHSPI	2	Resource definition online - restricted (RDO)
CEDC*	DFHEDAP	DFHSPI	2	Views resource definition online (RDO)
CEDF*	DFHEDFP	DFHEDF	2	Execution diagnostic facility
CEDX*	DFHEDFP	DFHEDF	2	Execution diagnostic facility for non-terminal tasks
CEHP	DFHCHS	DFHISC	2	LU type 2 mirror transaction (obsolete)
CEHS	DFHCHS	DFHISC	2	LU type 2 mirror transaction (obsolete)
CEMN*	DFHCEMNA	DFHOPER	2	CICS monitoring facility transaction
CEMT*	DFHEMTP	DFHOPER	2	Main terminal
CEOT*	DFHEOTP	DFHOPER	2	Terminal status
CEPH	DFHECEAH	DFHEP	2	HTTP EP adapter for event processing
CEPQ	DFHECEAM	DFHEP	2	WebSphere® MQ EP adapter for event processing
CEPR	DFHECEAQ	DFHEP	2	TDQ EP adapter for event processing
CEPS	DFHECEAS	DFHEP	2	Start transaction adapter for event processing
CEPT	DFHECEAT	DFHEP	2	TSQ EP adapter for event processing

Table 16. Category 2 transactions.

The transactions that have operator interfaces are marked by an asterisk (*). The remainder therefore have no operator interface.

(continued)

Transaction	Program	CSD group	Security category	Description
CESD	DFHCESD	DFHSDAP	2	Shutdown assist
CEST*	DFHESTP	DFHOPER	2	Supervisory terminal
CETR*	DFHCETRA	DFHOPER	2	Inquire and set trace options
CHLP	DFHCMAC	DFHCMAC	2	Alias for CMAC
CIDP*	DFHDPIN	DFHDP	2	Inactivate debugging profiles utility
CIND*	DFHINDT	DFHINDT	2	CICS indoubt testing tool
CJSA	DFHSJTHP	DFHJAVA	2	JVM server request processor transaction
CJSU	DFHSJTHP	DFHJAVA	2	JVM server unclassified request processor transaction
CKAM	DFHMQMON	DFHMQ	2	CICS-MQ Adapter alert monitor
CKBC	DFHMQBP3	DFHMQ	2	CICS-MQ Bridge Program Link transaction for channel and container DPL bridge
CKBM	DFHMQBAS	DFHMQ	2	CICS-MQ Adapter base panel transaction
CKBP	DFHMQBP0	DFHMQ	2	CICS-MQ Bridge DPL bridge task (COMMAREA)
CKBR	DFHMQBR0	DFHMQ	2	CICS-MQ Bridge Monitor task
CKCN	DFHMQQCN	DFHMQ	2	CICS-MQ Adapter start connection transaction
CKDL	DFHMQDSL	DFHMQ	2	CICS-MQ Adapter, display status transaction
CKDP	DFHMQDIS	DFHMQ	2	CICS-MQ Adapter, display transaction
CKQC*	DFHMQCTL	DFHMQ	2	CICS-MQ Adapter control transaction
CKRS	DFHMQRS	DFHMQ	2	CICS-MQ Adapter modify transaction
CKRT	DFHMQRET	DFHMQ	2	CICS-MQ Adapter screen return transaction
CKSD	DFHMQDSC	DFHMQ	2	CICS-MQ Adapter stop connection transaction
CKSQ	DFHMQSSQ	DFHMQ	2	CICS-MQ Adapter start/stop CKTI transaction
CKTI	DFHMQTSK	DFHMQ	2	CICS-MQ Adapter - task initiator transaction
CLDM*	DFHLDMAP	DFHOPER	2	CICS load module map

Table 16. Category 2 transactions.

The transactions that have operator interfaces are marked by an asterisk (*). The remainder therefore have no operator interface.

(continued)

Transaction	Program	CSD group	Security category	Description
CMAC	DFHCMAC	DFHCMAC	2	Messages utility
CMSG*	DFHMSP	DFHMSPWIT	2	Message switching
CPIA*	DFHPITE	DFHPIPE	2	Invokes CPIS from the terminal
CPIH	DFHPIDSH	DFHPIPE	2	CICS pipeline HTTP inbound router
CPIL	DFHPILSQ	DFHPIPE	2	SOAP WebSphere MQ inbound listener
CPIQ	DFHPIDSQ	DFHPIPE	2	SOAP WebSphere MQ inbound router
CPMI	DFHMIRS	DFHISC	2	CICS LU 6.2 synchronization level 1 mirror
CRPA	DFHRPAS	DFHRPC	2	ONC/RPC Alias transaction
CRPC	DFHRPC00	DFHRPC	2	ONC/RPC Update transaction
CRPM	DFHRPMS	DFHRPC	2	ONC/RPC Server controller
CRTE*	DFHRTE	DFHISC	2	Transaction routing
CRTX		DFHISC	2	Dynamic transaction routing transaction definition
CSFE*	DFHFEP	DFHFE	2	Terminal test, trace, storage
CSGM	DFHGMM	DFHVTAM	2	"Good-morning" signon
CSHR	DFHMIRS	DFHISC	2	Scheduler services remote routing
CSM1	DFHMIRS	DFHISC	2	SYSMSG model
CSM2	DFHMIRS	DFHISC	2	Scheduler model
CSM3	DFHMIRS	DFHISC	2	Queue model
CSM5	DFHMIRS	DFHISC	2	DL/I model
CSMI	DFHMIRS	DFHISC	2	Mirror transaction
CTIN	DFHZCT1	DFHCLNT	2	CICS Client
CVMI	DFHMIRS	DFHISC	2	CICS LU6.2 synchronization level 1 mirror
CWBA	DFHWBA	DFHWEB	2	CICS web support alias transaction
CWTO*	DFHCWTO	DFHCONS	2	Write to console operator
CWWU	DFHWBA	DFHWU	2	Web support alias transaction for the CICS management client interface
CW2A	DFHW2A	DFHWEB2	2	Atom feed alias transaction
DSNC	DFHD2CM1	DFHDB2	2	DB2 attachment facility transaction

Category 3 transactions

Category 3 transactions are either initiated by the terminal user or associated with a terminal.

All CICS terminal users, whether they are signed on or not, require access to transactions in this category. For this reason, category 3 transactions are exempt from any security check, and CICS permits any terminal user to initiate these transactions.

For category 3 transactions you are recommended to specify RESSEC(NO) and CMDSEC(NO) on the CICS transaction resource definition. These transactions should be defined to RACF; although this definition does not affect task attach-time processing, it is required to support the [QUERY SECURITY](#) command.

Table 17. Category 3 transactions.

The transactions that have operator interfaces are marked by an asterisk (*). The remainder therefore have no operator interface.

Transaction	Program	CSD group	Security category	Description
CATR	DFHZATR	DFHSPI	3	Deletes autoinstall restart terminal
CCIN	DFHZCN1	DFHCLNT	3	CICS Client
CDBN	DFHDBCON	DFHDBCTL	3	DBCTL interface connection transaction
CEGN	DFHCEGN	DFHSIGN	3	Schedules good night transaction
CEKL*		Not required	3	Main terminal transaction for emergency use 1
CESF*	DFHSFP	DFHSIGN	3	Signs off terminal user
CESL*	DFHSNP	DFHSIGN	3	Signs on terminal user with a password or password phrase
CESN*	DFHSNP	DFHSIGN	3	Signs on terminal user with a password
CIEP	DFHIEP	DFHIPECI	3	ECI for TCP/IP listener
CLQ2	DFHLUP	DFHISCT	3	Outbound resynchronization for APPC and MRO
CLR1	DFHZLS1	DFHISCT	3	Inbound CNOS for APPC and MRO
CLR2	DFHLUP	DFHISCT	3	Inbound resynchronization for MRO
CLS1	DFHZLS1	DFHISC	3	Provides ISC LU services model
CLS2	DFHLUP	DFHISC	3	Provides ISC LU services model
CLS3	DFHCLS3	DFHISC	3	ISC LU services model
CLS4	DFHCLS4	DFHISC	3	Manages password expiry
CMPX	DFHMXP	DFHISC	3	Ships ISC local queuing
CPSS	DFHZSGN	DFHPSSGN	3	Persistent sessions signon
CQPI	DFHCLS5	DFHISC/DFHISCQ	3	Connection quiesce. Architected transaction (inbound).
CQPO	DFHCLS5	DFHISC/DFHISCQ	3	Connection quiesce. Architected transaction (outbound).
CQRY	DFHQRY	DFHSTAND	3	Provides ATI query support
CRSR	DFHCRS	DFHISC	3	Provides ISC remote scheduler

Table 17. Category 3 transactions.

The transactions that have operator interfaces are marked by an asterisk (*). The remainder therefore have no operator interface.

(continued)

Transaction	Program	CSD group	Security category	Description
CSAC	DFHACP	DFHSTAND	3	Provides program abnormal condition
CSCY	DFHCPY	DFHVTAMP	3	Provides 3270 screen print
CSPG*	DFHTPR	DFHBMS	3	Provides BMS terminal paging
CSPK	DFHPRK	DFHVTAMP	3	Provides 3270 screen print support
CSPP	DFHP3270	DFHHARDC	3	Provides 3270 print support
CSPS	DFHTPS	DFHBMS	3	Schedules BMS terminal paging
CSRK	DFHRKB	DFHVTAMP	3	Provides 3270 screen print - release keyboard
CSRS	DFHZRSP	DFHRSEND	3	Synchronizes 3614 message
CSSF	DFHRTC	DFHISC	3	Cancels CRTE transaction routing session
CSXM ²		Not required	3	The transaction used by CICS services to get and free a transaction environment
CXRT	DFHCRT	DFHISC	3	Provides Transaction routing relay

Note:

¹ This transaction can be used only at an operating system console that has the authority to issue MODIFY commands for the CICS region.

² Transactions CGRP, CSSY, CSTP, and CSXM are transaction names that are used by some CICS tasks.

When and how CICS determines the userid of the CICS region

CICS makes use of the userid of the region in which it runs for a variety of purposes.

CICS uses the region user ID in the following situations:

- To prefix resource names if SECPRFX=YES is specified. For more information about the SECPRFX system initialization parameter, see “Security-related system initialization parameters” on page 46.
- As the user to be checked for category 1 transactions. For more information, see “Category 1 transactions” on page 141.
- As the default PLTPI user for PLTPI non-terminal security, if a PLTPIUSR is not specified in the system initialization parameter.
- For SURROGAT checking (for example, authority to use the PLTPI and default userids).
- For MRO bind security. For more information, see “Implementing MRO security” on page 265.

CICS obtains the region userid by invoking the external security manager, which extracts it from the RACF control blocks relevant for the job. The security domain and MRO-bind security each obtain the region userid by issuing a RACROUTE REQUEST=EXTRACT macro. To customize the response from this macro, and thus the security identification of a CICS region, use the MVS security router exit, ICHRTX00.

Chapter 3. Identity propagation and distributed security

Identity propagation provides a mechanism to allow a user identity from an external security realm to be preserved, regardless of where the identity information was created, strengthening accountability across distributed environments.

In an external computing environment, for example, WebSphere Application Server, the identity of a user is authenticated using a user identification that applies to that environment. Applications like WebSphere Application Server often use a separate, shared external security manager user ID when communicating with a CICS system. The original identity of the user is not passed to CICS and therefore cannot be passed onto the external security manager, making it difficult to determine the initial user identity and impacting the audit trail of the request.

In the identity propagation topics, RACF represents the external security manager. If you are not using RACF with CICS, consult your system administrator to configure the settings for your external security manager.

The term *distributed identity* represents user identity information, for example, an X.500 distinguished name and associated LDAP realm, that originates from a remote system. The distributed identity is created in one system and is passed to one or more other systems over a network. A distributed identity originates outside of CICS only; CICS is never the source of a distributed identity, but is capable of propagating the distributed identity onwards.

The following does not apply to use of identity propagation CICS Liberty. For information on identity propagation mapping in Liberty, see [Configuring security for a Liberty JVM server by using distributed identity mapping](#).

When a distributed identity enters the sysplex over MRO and IPIC connections, it is automatically propagated in the sysplex, regardless of connection settings. CICS security handles the distributed identity as additional information relating to the user ID, and a distributed identity cannot exist without a user ID.

Outside the sysplex, the distributed identity can be propagated on, depending on support. Receipt of a distributed identity by another party depends on whether the party is participating in identity propagation. See [“Support and requirements for identity propagation”](#) on page 156.

Identity propagation allows the distributed identity to be preserved, regardless of where the identity information was created, for use during authorization and for auditing purposes. The distributed identity is part of the identity context that is carried with a request from the external client application to the server, and it is incorporated in the access control of the server as part of the authorization process; for example, CICS Transaction Gateway on behalf of WebSphere Application Server.

The diagram shows how the X.500 distinguished name and associated LDAP realm which identify the user externally are passed with the request from WebSphere Application Server to a CICS system. The distinguished name and realm, which are known in CICS as a distributed identity when they are transmitted across a network, are propagated into the z/OS security context and are associated with the RACF user ID. With the z/OS RACF command, **RACMAP**, you can use mapping filters to correlate the distinguished name and realm to a RACF user ID, preserve the distributed credential information and fulfill governance and auditing requirements. RACF provides information to CICS about the distinguished name and realm, allowing retrieval in CICS of the identity of the initial user.

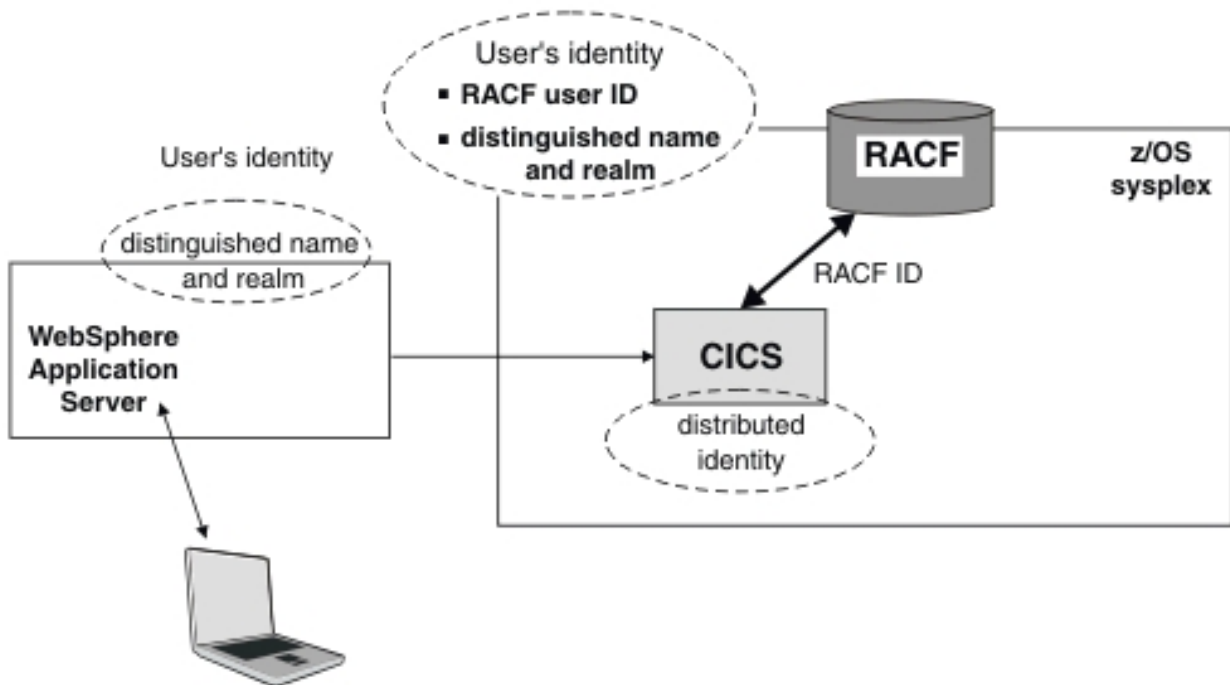

“Sample network topologies for using identity propagation” on page 157 expands on this diagram and shows how different network and product combinations provide support for distributed identities.

Support and requirements for identity propagation

CICS provides support for identity propagation between a range of products. Make sure that you meet these requirements to allow participation in identity propagation.

Summary of identity propagation participation

Identity propagation is a form of asserted identity and as a result, participation requires a number of factors:

- All parties involved must be able to process distributed identities
- A trusted connection must connect all external parties

If a system does not participate in identity propagation, distributed identity information is ignored, and user ID information is used as before.

For propagation, the outbound request must be made from a participating task, that is; a task whose user ID has an associated distributed identity.

Support for identity propagation

CICS provides support for identity propagation in the following situations:

- Inbound requests to CICS from WebSphere Application Server using the CICS ECI resource adapters over an IPIC connection.
- Using a WS-Security Header element in a web service request. Routed inbound web service requests do not support identity propagation.
- Using IPIC and MRO connections between CICS systems. The distributed identity is used by CICS only if it is passed to the MRO or IPIC connection from a participating task.
- Transactions issuing local or function shipped **START** commands. Exceptions to this support are the following situations, where the distributed identity is not propagated:

- If a **START** command specifies a USERID or TERMID.
- If a **START** command is shipped to a remote region across a LU61 or LU62 connection.
- If a dynamically routed **START** command is delayed.
- Using Liberty. For information on identity propagation mapping in Liberty, see [Configuring security for a Liberty JVM server by using distributed identity mapping](#).

[Sample network topologies for using identity propagation](#) provides diagrams and examples to explain how user security information is passed using the supported requests and connections.

Software requirements for identity propagation

Each host system participating in identity propagation requires the following minimum software:

- z/OS, Version 1 Release 11 or later.

RACF requirements for identity propagation

You must configure your RACF settings for the RACMAP and SETR RACLIST(IDIDMAP) commands before you update clients and CICS configuration definitions for identity propagation.

CICS requirements for identity propagation

CICS has a number of requirements to allow distributed identities to flow:

- Security must be enabled, by specifying the SEC=YES system initialization parameter.
- The external security manager, for example, RACF, must be configured to accept distributed identities.
- All partner systems must be able to process distributed identities.
- CICS supports distinguished names up to 246 bytes in length, and realm names up to 252 bytes in length.
- IPIC connections are limited to supporting identity contexts (ICRX identity tokens), the total size of which must not exceed 2000 bytes.

Sample network topologies for using identity propagation

Identity propagation is supported on network topologies that use either IPIC connections or web service requests to CICS. Use these sample topologies to help you plan your configuration.

Sample configuration using an IPIC connection and CICS Transaction Gateway

If you are using IPIC connections into CICS, you might be using CICS Transaction Gateway as an interface between WebSphere Application Server and the CICS ECI resource adapters. If CICS Transaction Gateway and any communicating CICS systems are not on the same sysplex, SSL is also required. The following sample topology shows how the X.500 distinguished name and associated LDAP realm are passed with the request from WebSphere Application Server through CICS Transaction Gateway over an IPIC connection to a CICS system on the same sysplex. The distinguished name and realm, which are known in CICS as a distributed identity when they are transmitted across a network, are then passed between CICS systems using either MRO or IPIC in a sysplex or between CICS systems in different sysplexes using IPIC over SSL. The multiple CICS systems shown in this scenario show how you can connect CICS systems in and outside of a sysplex, however multiple CICS systems are not a required part of the configuration to allow identity propagation. The distributed identity is propagated into the z/OS security context, also known as the Accessor Environment Element (ACEE), and is associated with the RACF user ID using the mapping rules specified in the RACF **RACMAP** command. RACF provides information to CICS about the distinguished name and realm as well as the RACF user ID, allowing retrieval in CICS of the identity of the initial user.

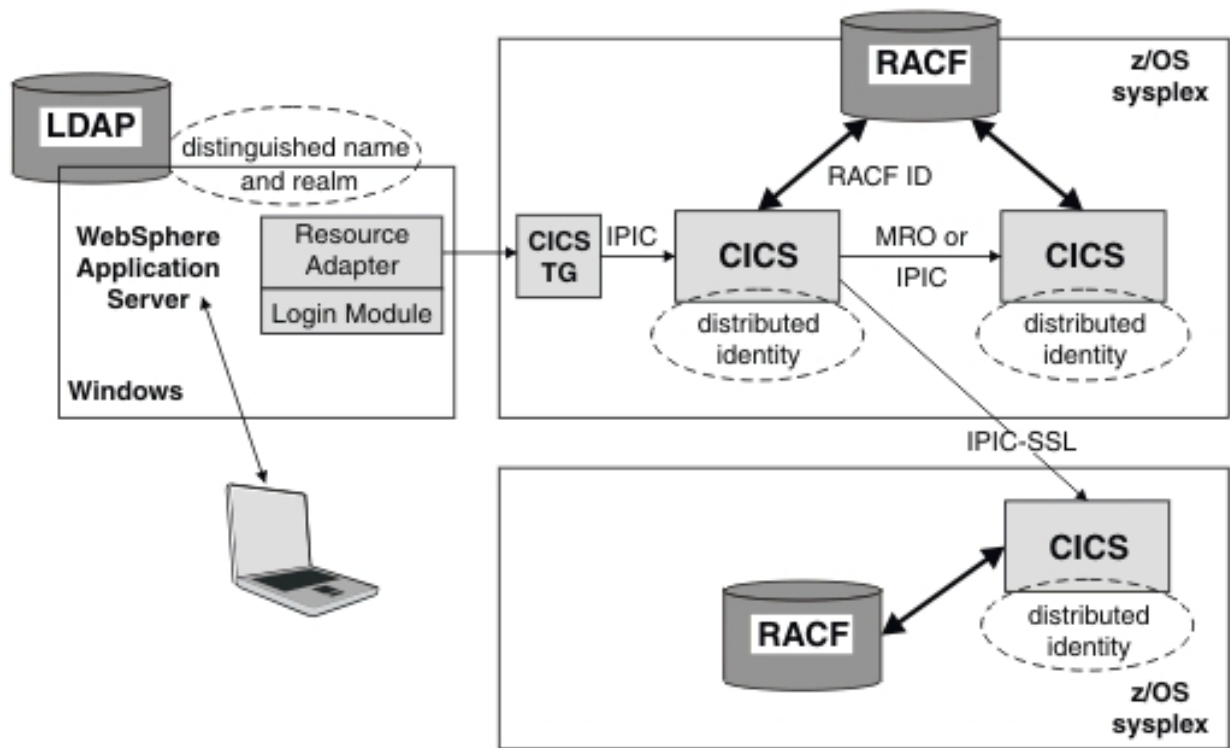

Figure 3. Example of identity propagation using WebSphere Application Server and CICS Transaction Gateway, communicating with CICS over an IPIC connection.

For more information about CICS Transaction Gateway and identity propagation, see [CICS Transaction Gateway for z/OS](#) or [CICS Transaction Gateway for Multiplatforms](#).

Sample configuration using a web service request and WebSphere DataPower

If you are sending web service requests to CICS, you might be using WebSphere DataPower® as an interface between WebSphere Application Server and CICS. You can use the WebSphere DataPower appliance with CICS web services WS-Security support to process the XML digital signature and perform mappings to a predefined RACF user ID.

The following sample topology shows how the X.500 distinguished name and associated LDAP realm are passed with the request from WebSphere Application Server through WebSphere DataPower. The distinguished name and realm are sent in the Extended Identity Context Reference WS-Security Header element of a web service request to a CICS system. For more information about ICRX identity tokens, see [z/OS Security Server RACF Data Areas](#). The distinguished name and realm, which are known in CICS as a distributed identity when they are transmitted across a network, are then passed between CICS systems using either MRO or IPIC in a sysplex or between CICS systems in different sysplexes using IPIC over SSL. The multiple CICS systems shown in this scenario show how you can connect CICS systems in and outside of a sysplex, however multiple CICS systems are not a required part of the configuration to allow identity propagation. The distributed identity is propagated into the z/OS security context, also known as the Accessor Environment Element (ACEE), and is associated with the RACF user ID using the mapping rules specified in the RACF **RACMAP** command. RACF provides information to CICS about the distinguished name and realm as well as the RACF user ID, allowing retrieval in CICS of the identity of the initial user.

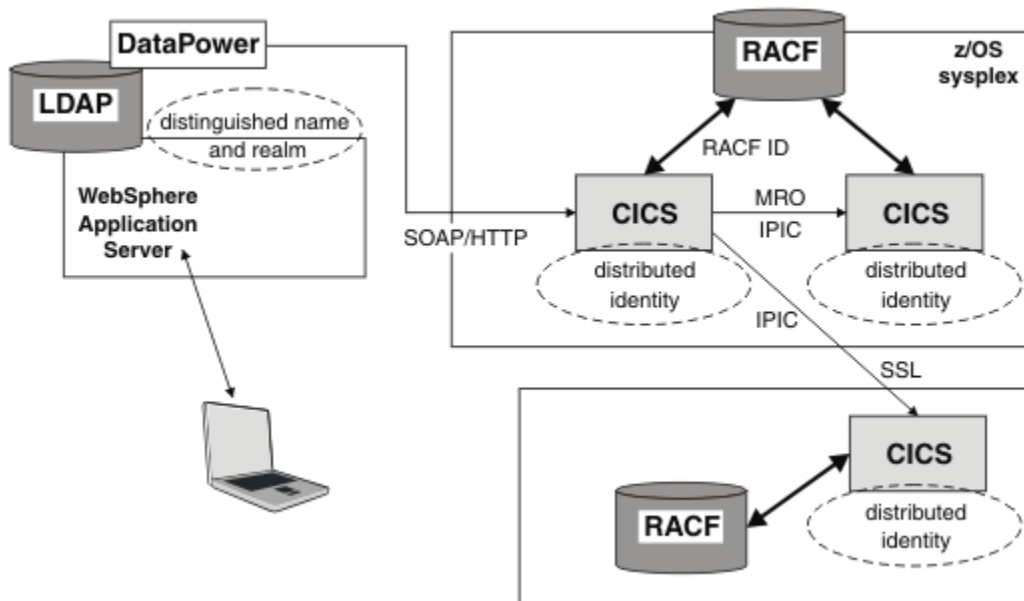

Figure 4. Example of identity propagation using WebSphere Application Server and WebSphere DataPower, communicating with CICS using a web service request.

Configuring identity propagation

You must configure RACF to be able to map distributed identities. You can configure your CICS system to accept distributed identity information from IPIC connections or from web service requests. Your CICS Liberty server can also use distributed identity mapping.

If you are using MRO connections, you can accept distributed identity information between CICS systems only. You must ensure that ATTACHSEC(IDENTIFY) is specified, but no other configuration changes are required.

Configuring RACF for identity propagation

Use the RACF **RACMAP** command to create, delete, and list a distributed identity filter. Use the RACF **SETR RACLIST(IDIDMAP)** command to refresh the IDIDMAP resource profile that contains the distributed identity filter. You must configure your RACF settings for identity propagation before you update clients and CICS configuration definitions.

Before you begin

Ensure that you have the required access to update RACF profiles for your z/OS system.

About this task

RACF uses the term *distributed identity filter* to describe a mapping association between a RACF user ID and one or more distributed identities. When you define the filter using the **RACMAP** command, you associate (or map) a distributed identity with a RACF user ID. If the distributed identity is not mapped in the **RACMAP** command, the default CICS user ID is not used and a security error is issued. Each distributed identity filter is stored in a general resource profile in the IDIDMAP class.

The owner of an IDIDMAP profile is the user ID of the **RACMAP MAP** command issuer.

When the **SETR RACLIST(IDIDMAP)** command is issued, the IDIDMAP class becomes active. When a distributed user is authenticated and the supported transaction is sent to the z/OS system, RACF receives the distinguished name and realm of the user as character strings of UTF-8 data. RACF has a number of

restrictions as a result of UTF-8 data encoding; for example, if the distinguished name exceeds 246 bytes or the realm exceeds 252 bytes, the **RACMAP MAP** command fails. See the topic about restrictions for UTF-8 data values in the [z/OS Security Server RACF Security Administrator's Guide](#).

RACF uses the distinguished name and realm to search IDIDMAP profiles for the distributed identity filter that contains the name values best matching the data. When the best matching filter is found, RACF assigns a RACF user ID.

Procedure

1. Create a generic profile called `IRR.IDIDMAP.*` in the FACILITY class in RACF.
2. Grant UPDATE access to your user group to enable general access to this profile.

Here is an example, using `dev` as the name of the user group:

```
RDEFINE FACILITY IRR.IDIDMAP.** OWNER(cpssing)
PERMIT IRR.IDIDMAP.** CLASS(FACILITY) ID(dev) ACCESS(UPDATE)
SETROPTS RACLIST(FACILITY) REFRESH
```

3. You can grant specific users authority to manage the IDIDMAP class by granting CLAUTH access.

Here is an example, using `usera`, `userb`, and `userc` as the users that are granted access:

```
ALTUSER (usera,userb,userc) CLAUTH(IDIDMAP)
```

4. Issue the following command to activate the changes:

```
SETROPTS CLASSACT(IDIDMAP) RACLIST(IDIDMAP)
```

5. If you are changing RACMAP definitions on a running system, the cached copy might not map to the same user ID as the new RACMAP definition. To reset the mapping you must wait until the cached copy is deleted. The copy is deleted if the distinguished name and realm pair (the distributed user ID) is not used for the length of time that is specified in the `USRDELAY SIT` parameter.

For performance reasons, CICS caches distinguished names and realms so that the first requests only from a distinguished name and realm require RACF to build an ACEE using the RACMAP definitions.

Results

The distributed user information is mapped in RACF. RACF is configured to map the distributed identity to a RACF user ID.

What to do next

You are now ready to configure your IPIC connections, web service connections or CICS Liberty server to CICS. For more information about the RACF **RACMAP** and **SETR RACLIST(IDIDMAP)** commands, see the information about distributed identity filters in the [z/OS Security Server RACF Security Administrator's Guide](#).

Chapter 4. Invoking an external security manager

CICS provides an interface to an external security manager (ESM), which can be the Resource Access Control Facility (RACF), a vendor product, or user-written. CICS security uses the MVS system authorization facility (SAF) interface to route authorization requests to the external security manager (ESM).

Typically, if RACF is present, the MVS router passes control to it. However, you can modify the action of the MVS router by invoking the router exit.

The router exit can be used, for example, to pass control to a user-written or vendor-supplied ESM. If you want to use your own security manager, you must supply an MVS router exit routine.

Note: This information is intended primarily for non-RACF users. For definitive information about security processing using RACF, refer to [RACF facilities](#).

Overview of the MVS router

The system authorization facility (SAF) provides your installation with centralized control over security processing by using a system service called the *MVS router*. The MVS router provides a common system interface for all products providing and requesting resource control.

The resource-managing components and subsystems (such as CICS) call the MVS router as part of certain decision-making functions in their processing, for example access control checking and authorization-related checking. These functions are called *control points*. This single SAF interface encourages the use of common control functions shared across products and across systems.

If RACF is available in the system, the MVS router might pass control to the RACF router, which in turn invokes the appropriate RACF function. The parameter information and the RACF router table, which associates router invocations with RACF functions, determine the appropriate function. However, before calling the RACF router, the MVS router calls an optional installation-supplied security-processing exit, if one has been installed. For more information, see [Passing control to a user-supplied ESM](#).

The system authorization facility and the SAF router are present on all MVS systems, even if RACF is not installed. Although the SAF router is not part of RACF, many system components and programs, such as CICS, invoke RACF through the RACROUTE macro and SAF. Therefore, installations can modify RACF parameter lists and do customized security processing within the SAF router. For information about how to code a SAF router exit, see [z/OS Security Server RACF Messages and Codes](#).

For more information about the MVS router, see [System authorization facility \(SAF\) in z/OS Security Server RACROUTE Macro Reference](#) and [ICHRTX00 - MVS Router Exit in z/OS MVS Installation Exits](#).

How ESM exit programs access CICS-related information

When CICS invokes the ESM, it passes information about the current CICS environment, for use by an ESM exit program, in an **installation data parameter list**. How your exit programs access the installation data parameter list depends on whether or not your ESM is RACF.

If you use an ESM exit program that issues a **RACROUTE REQUEST=AUTH** and the exit is running because of a security request from CICS, you must ensure that any CLASS which is referenced is listed in the RACLIST.

The RACF user exit parameter list

If you write RACF user exits, you can find the address of the installation data parameter list directly from the RACF user exit parameter list.

The name of the relevant field in the user exit parameter list varies according to the RACROUTE REQUEST type and the RACF user exit that is invoked. The relationships between REQUEST type, exit name, and field name are shown in [Table 18 on page 162](#).

Table 18. Obtaining the address of the installation data parameter list

RACROUTE REQUEST type	RACF exit	Exit list mapping macro	Parameter list field name (see Notes 1 and 2)
VERIFY	ICHPWX01	ICHPWXP	PWXINSTL
	ICHPWX11	ICHPWX2	PWX2INST
	ICHRIX01	ICHRIXP	RIXINSTL
	ICHRIX02	ICHRIXP	RIXINSTL
AUTH	ICHRXC01	ICHRXCP	RCXINSTL
	ICHRXC02	ICHRXCP	RCXINSTL
FASTAUTH	ICHRFX01	ICHRFXP	RFXANSTL
	ICHRFX02	ICHRFXP	RFXANSTL
LIST	ICHLRX01	ICHLRX1P	RLX1INST
	ICHLRX02	ICHLRX2P	RLX2PRPA

Note:

1. The 'xxxINSTL' field points to the installation parameter list only if you code ESMEXITS=INSTLN in the CICS system initialization parameters. The default value for this parameter is NOINSTLN, which means that no installation data is passed. (Note that ESMEXITS cannot be coded as a SIT override.)
2. RLX2PRPA contains the address of the ICHRLX01 user exit parameter list (RLX1P). Field RLX1INST of RLX1P points to the installation data parameter list.
3. There is no RACF user exit for REQUEST=EXTRACT, and no installation parameter data is passed. Any customization must be done using the MVS router exit, ICHRTX00.

For brief descriptions of RACF exits and their functions, see the [z/OS Security Server RACF Security Administrator's Guide](#). For full descriptions of the RACF exit parameter lists, see the [RACF installation exits](#).

Guidelines on using RACF exits for CICS RACROUTE calls

CICS runs many RACROUTE requests, in particular those that create or delete an RACF access control environment element (ACEE) such as SIGNON, CHANGE PASSWORD, and CHANGE PHRASE commands on the RO TCB. Requests run serially on the RO TCB. Therefore, the exits should not run anything with a large elapse time; otherwise, other security requests or usage of the TCB would be blocked.

The installation data parameter list

The installation data parameter list gives your external security manager (ESM) exit programs access to the CICS security event being processed and details about the current CICS environment.

Details of the current CICS environment might include, as available:

- APPLID of the CICS region
- Common work area
- Transaction being invoked
- Program being executed
- CICS terminal identifier
- SNA LUname
- Terminal user area
- An 8-byte communication area

For the format of the data parameter list, see [Mapping the installation data parameter list](#).

Chapter 5. Security for CICSplex SM

This part describes how to implement security for CICSplex SM.

Implementing CICSplex SM security

To implement CICSplex SM security using RACF, you must determine who needs access to the various CICSplex SM functions. You must also perform a number of tasks to define CICSplex SM class names and resource names, as well as activating security and refreshing RACF profiles.

About this task

If you are using a SAF-compliant external security manager (ESM) other than RACF, refer to [“Invoking a user-supplied external security manager”](#) on page 214. The following steps summarize how to set up security for CICSplex SM. Each of the steps are explained in detail in the subsequent topics.

Procedure

1. Decide who needs access to CICSplex SM.
2. Review the general security requirements for CICSplex SM.
3. Create RACF profiles for the CICSplex SM data sets.
4. Define the CICSplex SM started tasks to RACF.
5. If CICS transaction security is active in a CMAS, define the CICSplex SM transactions to RACF.
6. If CICS transaction security is active in a MAS, define the CICSplex SM transactions to RACF.
7. Create RACF profiles for the CICSplex SM views.
8. Create RACF profiles for the CICSplex SM Web User Interface resources.
See [Controlling access to Web User Interface resources](#) for more information.
9. Optional: Activate simulated security checking using the CICSSYS, CPLEXDEF, or MAS views.
10. Activate security in the CMASs and MASs using the CICSplex SM and CICS security-related system initialization parameters.

Determining who requires access to CICSplex SM resources

To determine who requires access to the CICSplex SM resources, answer the questions and complete the matrix. You can then use the results to create the PERMIT statements that are required in RACF to control access to the resources.

About this task

You can control access to CICSplex SM resources in two ways:

- By restricting access to the objects managed by CICSplex SM views. This restriction does not affect access to the views themselves, but it prevents them from displaying any data.
- By restricting access to Web User Interface view sets, menus and the View Editor. This restriction does not affect access to the objects that are being managed but prevents access to the view sets, menus, and View Editor themselves.

Procedure

1. Answer the following questions to determine who requires access to the CICSplex SM resources:

What groups of users use CICSplex SM?

Your enterprise probably already has several user groups that are defined to RACF. The groups that typically require access to CICSplex SM include systems programming, operations, the help desk, applications programming, and performance monitoring. These groups are used as column

headings in the security matrix. You can supply their corresponding RACF group IDs. (If necessary, you can ignore, replace, or add groups to the matrix required for your enterprise.)

Which CICSplex SM views do each group need to use?

CICSplex SM manages CICS resources that use views. Views are grouped by function: configuration, topology, workload management, real-time analysis, operations, monitoring, business application services, and CICSplex management. Not all view groups are appropriate for all users. Certain groups of users use only a subset of views. For example, the systems programming group might need to work with all views, while the help desk group might only need to use one or two. The view groups are listed vertically on the left side of the matrix, along with the high-level qualifier of their CICSplex SM resource names.

What type of access does each RACF group need?

After you decide who needs to use what, stop universal access to all of the objects managed by all of the views. You can then selectively permit read, update, or alter access to specific view groups. To complete the matrix, specify READ, UPDATE, or ALTER access for each RACF group that needs access to a group of views.

- Specify READ access to allow a user to inquire on a resource.
- Specify UPDATE access to allow a user to change a value, by using the SET or UPDATE command, or perform an action. The user can also create or remove a definition, such as a BAS resource object.
- Specify ALTER access to allow a user to discard an installed resource from CICS and allow a user to install a BAS resource object.

Tip: For application programmers, if you need to control who is allowed to use the CPSM option on the CICS translator, you can use RACF to control who is allowed to load the DFHSMTAB table at translation time. For a description of RACF program control, see the [z/OS Security Server RACF Security Administrator's Guide](#). DFHSMTAB is the language definition table that defines the CICSplex SM API commands. It is loaded only on demand.

Which CICSplex SM Web User Interface views, menus will each group need access to?

Web User Interface views and menus are usually user-defined but like Web User Interface views are most likely grouped by function. Not all view sets and menus are appropriate for all users. Certain groups of users require access to a subset of views. For example, the systems programming group might require access to all views and to the View Editor, while the help desk group might not need to use the View Editor or those views that manage the definition of CICSplex SM resources.

2. Complete the security matrix when you answer the questions.

<i>Table 19. Security matrix</i>					
RACF group → CICSplex SM view group ↓	System Programming ID()	Operations ID()	Help Desk ID()	Application Programming ID()	Performance ID()
Configuration CONFIG					
Topology TOPOLOGY					
Workload Management WORKLOAD					
Real-Time Analysis ANALYSIS					

<i>Table 19. Security matrix (continued)</i>					
RACF group → CICSplex SM view group ↓	System Programming ID()	Operations ID()	Help Desk ID()	Application Programming ID()	Performance ID()
Operations OPERATE					
Monitor MONITOR					
Business Application Services BAS					
CSD					

Table 20 on page 167 is a sample of a completed security matrix for a production CICSplex:

<i>Table 20. Sample security matrix</i>					
RACF group → CICSplex SM view group ↓	System Programming ID(SYSPGRP)	Operations ID(OPSGRP)	Help Desk ID(HELPGRP)	Application Programming ID(APPLGRP)	Performance ID(PERFGRP)
Configuration CONFIG	UPDATE				
Topology TOPOLOGY	UPDATE	UPDATE	READ		
Workload Management WORKLOAD	UPDATE			READ	
Real-Time Analysis ANALYSIS	UPDATE	UPDATE	READ		READ
Operations OPERATE	ALTER	UPDATE	READ	READ	READ
Monitor MONITOR	UPDATE	READ			READ
Business Application Services BAS	ALTER	ALTER		UPDATE	
CSD	ALTER	ALTER		UPDATE	

3. Ensure that the CPSMOBJ class is active and that generic profiles can be defined:

```
SETROPTS CLASSACT(CPSMOBJ)
SETROPTS GENERIC(CPSMOBJ)
SETROPTS GENCMD(CPSMOBJ)
```

4. Create a RACF profile to protect all of the views and action commands for all CICSplex SM functions:

```
RDEF CPSMOBJ ** UACC(NONE) OWNER(admin_group) NOTIFY(admin_user)
```

CPSMOBJ is the CICSplex SM member class. The double asterisks indicate that all of the CICSplex SM views are included in this RDEF statement.

5. Using the information in the sample matrix, you can permit access to the specific view groups. For example, the systems programming group requires UPDATE access to all of the view groups and ALTER access to the OPERATE, BAS, and CSD views.

To start, allow UPDATE access to all possible profiles:

```
PERMIT ** CLASS(CPSMOBJ) ID(SYSPGRP) ACCESS(UPDATE)
```

The double asterisks indicate that all of the CICSplex SM views are affected by this PERMIT statement.

The following PERMIT statements grant the appropriate access to all of the topology views for the operations and help desk groups:

```
PERMIT TOPOLOGY.** CLASS(CPSMOBJ) ID(OPSGRP) ACCESS(UPDATE)
PERMIT TOPOLOGY.** CLASS(CPSMOBJ) ID(HELPGRP) ACCESS(READ)
```

For the workload management views:

```
PERMIT WORKLOAD.** CLASS(CPSMOBJ) ID(APPLGRP) ACCESS(READ)
```

For the real-time analysis views:

```
PERMIT ANALYSIS.** CLASS(CPSMOBJ) ID(OPSGRP) ACCESS(UPDATE)
PERMIT ANALYSIS.** CLASS(CPSMOBJ) ID(HELPGRP) ACCESS(READ)
PERMIT ANALYSIS.** CLASS(CPSMOBJ) ID(PERFGRP) ACCESS(READ)
```

For the operations views:

```
PERMIT OPERATE.** CLASS(CPSMOBJ) ID(SYSPGRP) ACCESS(ALTER)
PERMIT OPERATE.** CLASS(CPSMOBJ) ID(OPSGRP) ACCESS(UPDATE)
PERMIT OPERATE.** CLASS(CPSMOBJ) ID(HELPGRP) ACCESS(READ)
PERMIT OPERATE.** CLASS(CPSMOBJ) ID(APPLGRP) ACCESS(READ)
PERMIT OPERATE.** CLASS(CPSMOBJ) ID(PERFGRP) ACCESS(READ)
```

For the monitor views:

```
PERMIT MONITOR.** CLASS(CPSMOBJ) ID(APPLGRP) ACCESS(READ)
PERMIT MONITOR.** CLASS(CPSMOBJ) ID(PERFGRP) ACCESS(READ)
```

For the business application services views:

```
PERMIT BAS.** CLASS(CPSMOBJ) ID(SYSPGRP) ACCESS(ALTER)
PERMIT BAS.** CLASS(CPSMOBJ) ID(OPSGRP) ACCESS(ALTER)
PERMIT BAS.** CLASS(CPSMOBJ) ID(APPLGRP) ACCESS(UPDATE)
```

For the CSD views:

```
PERMIT CSD.** CLASS(CPSMOBJ) ID(SYSPGRP) ACCESS(ALTER)
PERMIT CSD.** CLASS(CPSMOBJ) ID(OPSGRP) ACCESS(ALTER)
PERMIT CSD.** CLASS(CPSMOBJ) ID(APPLGRP) ACCESS(UPDATE)
```

Results

For simplicity, these PERMIT statements grant access to broad groups of views by using the double asterisks in the resource names. However, if required, you can use more specific resource names in your PERMIT statements. Refer to [“Specifying CICSplex SM resource names in profiles” on page 178](#) for details.

What to do next

Using your own completed security matrix and the information in the remainder of this section, you can create as many profiles as required for your enterprise. [“Example tasks: security” on page 215](#) provides detailed profile examples.

General requirements for CICSplex SM security

Review your RACF configurations to ensure that your systems meet the minimum requirements.

- The IDs for all users expected to use CICSplex SM must be defined to RACF in each MVS system in which there is a CMAS. For each individual user, the ID must be the same for each MVS system.
- User access authority to CICSplex SM definitions and CICS commands and resources must be defined to RACF in a consistent manner in all MVS systems used by CICSplex SM.

In addition, in the CMAS address space, a security environment is created for the user specified in the **DFLTUSER** system initialization parameter associated with the MAS.

Creating profiles for the CICSplex SM data sets

You should restrict access to CICSplex SM data sets using RACF data set protection.

Procedure

1. Prohibit universal access by specifying UACC(NONE).
2. Ensure that minimum access to the data sets is authorized for the RACF USERID assigned to each of the following:
 - Every CMAS job or started task.
 - Every MAS.
 - All individuals allowed to use CICSplex SM from the CICSplex SM WUI and API (both system administrators and users).

[Table 21 on page 169](#) lists the CICSplex SM data sets and the minimum access that should be granted to each type of user ID.

Table 21. Access by user ID for CICSplex SM data sets

Data set name	CMAS	MAS	System Admin.	Individual User
SYS1.CICSTS54.CPSM.SEYULPA	NONE	READ	UPDATE	NONE
SYS1.CICSTS54.CPSM.SEYULINK	READ	NONE	UPDATE	NONE
CICSTS54.CPSM.SEYUAUTH	READ	READ	UPDATE	READ
CICSTS54.CPSM.SEYULOAD	READ	READ	UPDATE	NONE
CICSTS54.CPSM.SEYUPARM	READ	READ	UPDATE	NONE
CICSTS54.CPSM.SEYUCMOD	NONE	NONE	UPDATE	NONE
CICSTS54.CPSM.SEYUCOB	NONE	NONE	UPDATE	READ
CICSTS54.CPSM.SEYUC370	NONE	NONE	UPDATE	READ
CICSTS54.CPSM.SEYUDEF	READ	READ	UPDATE	READ
CICSTS54.CPSM.SEYUCLIB	NONE	NONE	UPDATE	READ
CICSTS54.CPSM.SEYUMLIB	NONE	NONE	UPDATE	READ
CICSTS54.CPSM.SEYUPLIB	NONE	NONE	UPDATE	READ
CICSTS54.CPSM.SEYUTLIB	NONE	NONE	UPDATE	READ

Table 21. Access by user ID for CICSplex SM data sets (continued)

Data set name	CMAS	MAS	System Admin.	Individual User
CICSTS54.CICS.SDFHINST	NONE	NONE	UPDATE	NONE
CICSTS54.CPSM.SEYUMAC	NONE	NONE	UPDATE	READ
CICSTS54.CPSM.SEYUOS2	NONE	NONE	UPDATE	NONE
CICSTS54.CPSM.SEYUPL1	NONE	NONE	UPDATE	READ
CICSTS54.CPSM.SEYUPROC	NONE	NONE	UPDATE	READ
CICSTS54.CPSM.SEYUSAMP	NONE	NONE	UPDATE	READ
CICSTS54.CPSM.EYUSDEF	NONE	NONE	UPDATE	UPDATE
CICSTS54.CPSM.EYUDREP	UPDATE	NONE	UPDATE	NONE
CICSTS54.CPSM.EYUIPRM	NONE	NONE	UPDATE	NONE

What to do next

If you require more details about RACF data set protection, see the [z/OS Security Server RACF Security Administrator's Guide](#).

Determining the agent user ID for CICSplex SM components

You need to know the user ID that is used by components of CICSplex SM, such as the CMAS, MAS, WUI, and SMSS so that you can set up the right authorization in RACF.

What governs the agent user ID?

The agent user ID depends on the following factors:

- The release of CICS, but irrespective of the release of CICSplex SM
- How the agent was initialized.
- Whether the **PLTPIUSR** system initialization parameter is set (to initialize the agent at the initialization of the CICS region)

The agent user IDs for the CMAS, MAS, or WUI run under the **PLTPIUSR** user ID only when the SIT parameter **SEC=YES** and at least one of the following SIT parameter values are set. Otherwise, the agent user ID continues to run under the CICS region user ID.

- **PLTPI=YES** or **PLTPI=name**
- **MQCONN=YES**
- **DB2CONN=YES**
- **DBCTLCON=YES**

For CMAS and WUI regions, use the **CPSMCONN** SIT parameter instead of the **PLTPI** SIT parameter. Do not specify the **MQCONN=YES**, **DB2CONN=YES**, or **DBCTLCON=YES** SIT parameters in these regions.

For details of SIT parameters, see [System initialization parameter descriptions and summary](#).

Use the tables to determine which ID is used:

- [CMAS agent user ID](#)
- [MAS agent user ID](#)
- [WUI agent user ID](#)

CICSplex SM release	How was the CMAS agent initialized?	PLTPIUSR in system initialization table?	CMAS agent user ID
Any in-service release	At initialization of the CICS region (CPSMCONN only)	Not applicable (no effect)	CICS region user ID
5.5 or earlier	At initialization of the CICS region (PLT entry only)	No	CICS region user ID
5.5 or earlier	At initialization of the CICS region (PLT entry only)	Yes	PLTPIUSR (see details in “What governs the agent user ID?” on page 170)

CICSplex SM release	How was the MAS agent initialized?	PLTPIUSR in system initialization table?	MAS agent user ID
Any in-service release	At initialization of the CICS region (CPSMCONN only)	Not applicable	CICS region user ID
5.4 or later	Using the COLM transaction	Not applicable	CICS region user ID
5.3 or earlier	Using the COLM transaction	Not applicable	Signed-on user ID that initiated COLM
5.5 or earlier	At initialization of the CICS region (PLT entry only)	No	CICS region user ID
5.5 or earlier	At initialization of the CICS region (PLT entry only)	Yes	PLTPIUSR (see details in “What governs the agent user ID?” on page 170)

CICSplex SM release	How was the WUI agent initialized?	PLTPIUSR in system initialization table?	WUI agent user ID
Any in-service release	At initialization of the CICS region (CPSMCONN only)	Not applicable	CICS region user ID
Any in-service release	Using the COVC transaction	Not applicable	Signed-on user ID that initiated COVC
5.5 or earlier	At initialization of the CICS region (PLT entry only)	No	CICS region user ID
5.5 or earlier	At initialization of the CICS region (PLT entry only)	Yes	PLTPIUSR (see details in “What governs the agent user ID?” on page 170)

Defining the CICSplex SM started tasks

When you run a CMAS as a started task, you must associate the appropriate procedure names with a suitably authorized USERID.

About this task

This is usually achieved using the STARTED general resource class or the RACF ICHRIN03 tables. The names of the associated USERIDs need not match the names of the procedures. Each USERID must have the appropriate level of access to all of the data sets referenced in the cataloged procedures.

For additional information about the STARTED class, see the [z/OS Security Server RACF Security Administrator's Guide](#). For more information about ICHRIN03, see the [z/OS Security Server RACF System Programmer's Guide](#).

Note: If the USERID and group name that you assign are not defined to RACF, the started tasks will execute with only the limited authority of an undefined user. In this case, the address space will be able to access protected resources only if the universal access authority (UACC) for the resource is sufficient to allow the requested operation.

Defining the CICSplex SM transactions in a CMAS

If transaction–attach security is active in a CMAS (that is, SEC=YES and XTRAN=YES|*classname* are specified in the system initialization parameters), you must define to RACF the CICSplex SM transactions that run in a CMAS.

Procedure

1. You must define the following CICSplex SM transactions to RACF:

BMLT	LPLT	PRLT	WMWC
LCPP	LPRT	PRPR	WMWD
LCMU	LPSC	PSLT	WMWT
LECI	LPSM	TICT	WSCL
LECR	LRLT	TIRT	WSLW
LECS	LSGT	TIST	XDBM
LEEI	LSRT	TSMH	XDNC
LEER	LWTM	TSPD	XDND
LEMI	MCCM	TSSC	XDNE
LEMS	MCTK	TSSJ	XDNR
LENS	MMEI	WMCC	XDNS
LMIR	MMIS	WMGR	XDSR
LNCI	MMST	WMLA	XLEV
LNCS	PEAD	WMQB	XLNX
LNMI	PELT	WMQM	XLST
LNMS	PMLT	WMQS	XMLT
LPDG	PNLT	WMSC	XQST
LPLK	PPLT		XZLT

A list of these transactions is also contained in the EYU\$CDEF member of SEYUSAMP sample library.

- a) Define security for these transactions as follows:

- If the CMAS is started by a PLT program, and a user ID is specified on a [PLTPIUSR](#) system initialization parameter, ensure that the PLTPIUSR user ID has authority to attach these transactions.

- If the CMAS is started by a PLT program, and no user ID is specified on a PLTPIUSR system initialization parameter, ensure that CICS region user ID has authority to attach these transactions.
 - If the CMAS starts by using the SIT parameter CPSMCONN, and a user ID is specified on a PLTPIUSR system initialization parameter, ensure that the PLTPIUSR user ID has authority to attach these transactions.
 - If the CMAS starts by using the SIT parameter CPSMCONN, and no user ID is specified on a PLTPIUSR system initialization parameter, ensure that CICS region user ID has authority to attach these transactions.
- b) Depending on the security attributes specified for any CMTCMDEF or CMTPMDEF, ensure that any user IDs that might flow from connected CMASs have the authority to attach these transactions.
2. Define the following debugging transactions to RACF if transaction security is active, regardless of the CICS release running as the CMAS:
- CODB
 - COD0
 - COD1
 - COD2
 - COLU
- These transactions are associated with a terminal and are supplied for debugging purposes under the guidance of IBM support personnel. Authority to initiate these transactions must be restricted to only those users who might become involved in working with IBM to resolve CICSplex SM problems.
3. Give users access to the CESD shutdown-assist transaction.
- Users who can attach CICSplex SM transactions or define debugging transactions need access to CESD in case of CMAS failure.
4. Allow only users who might need to shut down a CMAS to access the COSD transaction.
- The COSD transaction allows a terminal user to shut down a CMAS.

Defining the transactions in a managed CICS region

For CICS regions that are capable of running with an external security manager, it might be necessary to define the transactions that run in a CICS region managed by CICSplex SM to the ESM.

About this task

If transaction–attach security is active in a CICS region (that is, SEC=YES and XTRAN=YES|*classname* are specified in the system initialization parameters), you must define the following transactions to RACF in the appropriate class:

COHT
 COIE
 COIR
 COIO
 CONA
 COND
 CONH
 CONL
 CONM
 COWC

The region user ID must be given READ access to these transactions. These transactions are in category 1 of CICS-supplied transactions, and the necessary access can be defined together with all transactions in this category. For more information about category 1 of CICS-supplied transactions, see [“Category 1 transactions” on page 141](#).

If CICSplex SM status probes (STATDEFs) run in a MAS, the region user ID must be given READ access to transaction CORT.

Users who might invoke the debugging transactions should be given READ access to the following transactions:

CODB
 COD0
 COD1
 COD2
 COLU

The security attributes of the CONNECTION/SESSION pair defined for the link to the CMAS define which users are authorized to run these transactions. See [“Overview of intercommunication security”](#) on page 219 for information on intercommunication security.

The COSH transaction allows a terminal user to stop agent code execution. Access to this transaction should be restricted to those users who might need to stop the agent code in this way.

Setting up CICSplex SM Web User Interface security

You can set Web User Interface security requirements for CICS security, Secure Sockets Layer (SSL) support, and access to MVS data sets.

User security access summary

Table 25 on page 174 summarizes the security accesses required by users of the Web User Interface.

<i>Table 25. Security accesses required by users of the Web User Interface</i>				
User Roles	CICS Web Support	Administrator	User	View Editor
Transactions	COVP COVE COVU	COVG COVC	COVA	COVA
CICS surrogate user security		Yes		
View Editor profile				Yes
CICSplex SM and CICS security			As appropriate for individual users	As appropriate for individual users

CICS security in your Web User Interface server region

If your Web User Interface server region is running with CICS security active, you must define the security access required for the CICS Web Support, by the administrator and by the users of the View Editor.

You can use CICS transaction security to limit the users who are allowed to control the Web User Interface server using the COVC transaction.

Security access for the CICS Web Interface

If CICS transaction security is in use, the CICS DFLTUSER must be given access to the COVP, COVU, and COVE transactions.

Security access for the administrator

The user ID that starts the Web User Interface (the terminal user of COVC or PLTPIUSR, if started automatically using PLTPI) must have access to the COVC and COVG transactions. If CICS surrogate user security checking is active in the Web User Interface server region, the user ID that started the Web User Interface (the terminal user of COVC or PLTPIUSR, if started automatically using PLTPI) must have READ access to wui-userid.DFHSTART in the SURROGAT class for all Web User Interface users.

Security access for users of the View Editor

Users of the Web User Interface require access to the COVA transaction and CICSplex SM. Users of the View Editor require access to the COVA transaction, CICSplex SM, and the View Editor profile.

All users who are successfully signed on to the Web User Interface have access to all of the customizable view and menu help pages, if the customizable view and menu help is served by the Web User Interface.

Secure Sockets Layer support

You can provide secure connections by using the Secure Sockets Layer (SSL) support to provide encryption on the connection. For information about SSL support, see [Web User Interface server initialization parameters](#) for information about the **TCPIPSSL** and **TCPIPSSLCERT** Web User Interface server initialization parameters that you must specify for SSL support and for more guidance on SSL, see [Configuring CICS to use SSL](#).

Web User Interface SSL support uses server authentication only. User authentication is by the external security manager (ESM) user ID and password.

Defining the CICSplex SM transactions for a WUI

For Web User Interface (WUI) regions that are capable of running with an external security manager (ESM) such as RACF, it is necessary to define the CICSplex SM transactions that run in the region to the ESM.

Before you begin

This is necessary when transaction attach security is active in the WUI region, where SEC=YES and XTRAN=YES system initialization parameters are specified.

Procedure

1. Create the same definitions as you would for a MAS region.
See [“Defining the transactions in a managed CICS region”](#) on page 173.
2. Define READ access to the COVG and COVC transactions for the following user IDs:
 - The region user ID
 - All user IDs that are specified on the **PLTPIUSR** system initialization parameter for the region
 - All WUI system administrators.
3. Define READ access to the COVE, COVP, and COVU transactions for the WUI default user ID.
4. Define READ access to the COVA transaction for all WUI users.

Example

A list of these transactions is also contained in the CSD group EYU\$WDEF.

Authorizing access to MVS data sets

In addition to standard CICS and CICSplex SM requirements, the CICS region user ID must have the authority to access the data sets associated with the DD names described in the table.

DDnames	Access required
EYUWUI	READ
DFHHTML	READ
EYUCOVI (and clones)	READ

<i>Table 26. Security access required for MVS data sets (continued)</i>	
DDnames	Access required
EYUWREP	UPDATE
EYULOG	UPDATE
EYUCOVE (and clones)	UPDATE

Running your Web User Interface server with security active

If the Web User Interface server is running with the CICS system initialization parameter **SEC** set to YES, you can control who can access the Web User Interface, what resources they can see, what actions they can perform, and the use of the view editor.

If you have already set up CICSplex SM security for use with the CICSplex SM API, users have the same level of access with the Web User Interface as they do with the API.

When you attempt to connect to a Web User Interface server, the CICSplex SM Web User Interface Signon Panel is displayed. The user ID and password entered in this panel are passed to the Web User Interface server, in plain text over the TCP/IP connection, unless you are using SSL support, and then verified by the external security manager. If the external security manager supports mixed case passwords, and this feature is active, an icon is displayed next to the password field when you sign on.

All users who are successfully signed on to the Web User Interface have access to all of the customizable view and menu help pages, if the customizable view and menu help is served by the Web User Interface.

If security is active, messages produced by auditing system programming interface commands contain the user ID used to log on to the WUI. See [SPI commands that can be audited](#).

To control who is allowed to sign onto the Web User Interface server, you can protect the Web User Interface CICS application ID by using RACF APPL checking. See [RACF classes for protecting system resources](#).

Access to managed resources uses standard CICSplex SM security using profiles in the CPSMOBJ class. For example, to see a CICS region view, the Web User Interface user needs READ authority through the CPSMOBJ class profile OPERATE.REGION.context.scope.

Access to CICS resources, and actions on resources in a view, use the simulated CICS security checking of CICSplex SM, which uses the normal CICS RACF resource and command security profiles. For example, to issue the shutdown action against a CICS region, if command security is active in the target CICS region, the Web User Interface user would need UPDATE authority to the SHUTDOWN command in the CCICSCMD class.

Controlling access to Web User Interface resources

You can use your external security manager to control user access to views, menus, editors, and help information and control the import and export of views, menus, maps, user groups, and user objects that use COVC.

The navigation frame is exempt from security checks. To control user access, you need to create the appropriate profiles in the FACILITY class. The following ESM FACILITY profiles are available:

EYUWUI.wui_server_applid.VIEW.viewsetname

- used to protect view sets.

EYUWUI.wui_server_applid.MENU.menuname

- used to protect menus.

EYUWUI.wui_server_applid.MAP.mapname

- used to protect maps.

EYUWUI.wui_server_applid.HELP.helpmembername

- used to protect help pages.

EYUWUI.wui_server_applid.EDITOR

- used to protect the View Editor.

EYUWUI.wui_server_applid.USER

- used to protect the User Editor and user and user group objects.

where `wui_server_applid` is the CICS APPLID of the server.

Users can be given read or update access to WUI resources:

- Read -- to use the views, menus, maps and Help information in the main interface, or to export views, menus, maps, user groups, or user objects that use COVC
- Update -- to access the editors and create, update, or remove items that use them, or to import views, menus, maps, user groups, or user objects that use COVC

To support AUTOIMPORT functions, the user ID that runs the COVG transaction must also be given update access to these FACILITY profiles. This is either the region user ID, or the PLTPIUSR value if a PLTPI table is in use.

If the ESM that you are using, neither grants nor refuses access to a profile (for example, if no RACF profile is defined), all users who are successfully signed on to the Web User Interface have access to the resources. You can make not authorized the default by setting up a generic profile.

Note: This security is designed to protect the views and menus themselves and not the objects they manage, which is covered by normal CICSplex SM security.

When selecting a view set, map or menu to edit or delete within the view editor, only items for which you have update access are listed. However, when selecting an item to copy, all items for which you have read access are shown. This allows you to copy any object for which you have read only access to a private copy in your updateable namespace .

When browsing for views that are accessible, no security exceptions are logged. Users are presented with a list that has been filtered to remove the views that are not accessible. However, when a user attempts an unauthorized action; for example, creating a view in a denied namespace, the EYULOG security exception message EYUVS1100E is issued.

Examples of WUI security profiles

The following examples use the RACF TSO command syntax and assume that the default CICS RACF classes and no security prefixing is in use.

This is not the only way that suitable profiles can be defined. These examples can be adapted to suit the installations requirements and standards.

In the examples, lower case strings should be replaced with the appropriate use ID or resource.

• Example 1

Create Web User Interface user groups:

```
ADDGROUP (WUISERV,WUIADM,WUIUSER,WUIEDIT)
```

• Example 2

Define profiles to protect Web User Interface transactions:

```
RDEFINE GCICSTRN WUISYS UACC(NONE) ADDMEM(COVP,COVU,COVE)
RDEFINE GCICSTRN WUIADMIN UACC(NONE) ADDMEM(COVC,COVC)
RDEFINE TCICSTRN COVA UACC(NONE)
```

• Example 3

Authorize user groups to appropriate profiles:

```
PERMIT WUISYS CLASS(GCICSTRN) ID(WUISERV) ACCESS(READ)
PERMIT WUIADMIN CLASS(GCICSTRN) ID(WUIADM) ACCESS(READ)
PERMIT COVA CLASS(TCICSTRN) ID(WUIUSER,WUIEDIT) ACCESS(READ)
```

- Example 4

Refresh transaction security profiles:

```
SETROPTS RACLIST(TCICSTRN) REFRESH
```

- Example 5

Define View Editor profile and give user group appropriate access:

```
RDEFINE FACILITY EYUWUI.wui_server_applid.EDITOR UACC(NONE)
PERMIT EYUWUI.wui_server_applid.EDITOR CLASS(FACILITY) ID(WUIEDIT) ACCESS(UPDATE)
```

- Example 6

Define view set profile and give user group appropriate access:

```
RDEFINE FACILITY EYUWUI.wui_server_applid.VIEW.viewsetname UACC(NONE)
PERMIT EYUWUI.wui_server_applid.VIEW.viewsetname CLASS(FACILITY) ID(WUIUSER)
ACCESS(READ)
```

- Example 7

Connect users to appropriate Web User Interface groups:

```
CONNECT wui_server_dfltuser GROUP(WUISERV)
CONNECT (wui_server_pltplusr,wui_administrator) GROUP(WUIADM)
CONNECT (wui_administrator,wui_view_designer) GROUP(WUIEDIT)
CONNECT (wui_operator1,wui_operator2...) GROUP(WUIUSER)
```

- Example 8

If CICS surrogate user security is active in the Web User Interface region, definitions similar to the following are required:

```
DEFINE SURROGAT wui_administrator.DFHSTART UACC(NONE)
PERMIT wui_administrator.DFHSTART CLASS(SURROGAT) ID(WUIADM) ACCESS(READ)
DEFINE SURROGAT wui_view_designer.DFHSTART UACC(NONE)
PERMIT wui_view_designer.DFHSTART CLASS(SURROGAT) ID(WUIADM) ACCESS(READ)
DEFINE SURROGAT wui_operator1.DFHSTART UACC(NONE)
PERMIT wui_operator1.DFHSTART CLASS(SURROGAT) ID(WUIADM) ACCESS(READ)
DEFINE SURROGAT wui_operator2.DFHSTART UACC(NONE)
PERMIT wui_operator2.DFHSTART CLASS(SURROGAT) ID(WUIADM) ACCESS(READ)

SETROPTS RACLIST(SURROGAT) REFRESH
```

Running your Web User Interface server with security not active

If the Web User Interface server is running with the CICS system initialization parameter **SEC=NO**, users of the Web User Interface must provide a user ID to identify 'sessions' in the COVC transaction. Users are not required to provide a password.

The user ID does not need to be defined to the external security manager. Access checking of access to views, and CICS resources are based on the **DFLTUSER** for the Web User Interface server CICS region. All Web User Interface users have access to the View Editor and all menus, view sets and help members.

If security is not active, messages produced by auditing system programming interface commands contain the default user ID of either the CMAS or the MAS. See [Changes to the SPI](#).

Specifying CICSplex SM resource names in profiles

You can create RACF profiles for CICSplex SM views for a specific CICS system, a group of CICS systems, or all systems comprising a CICSplex.

About this task

The lists contain the resource names for CICSplex SM views to be used in RACF profiles.

CICSplex SM views are divided into groups that reflect the functions they perform. Within each functional group, the views are divided by their type. Functional groups can be even further qualified with the addition of a context and, for some groups, a scope or platform. You can control access to a specific set of views (and their associated action commands) by identifying the set in a profile, using one of the following resource name formats:

function.type.context
function.type.context.scope

where:

function

is the name of the CICSplex SM function to be affected:

ANALYSIS

Real-time analysis

BAS

Business application services

CLOUD

Platforms and applications

CONFIG

CMAS configuration

CSD

CICS System Definition

MONITOR

Resource monitoring

OPERATE

Operations

TOPOLOGY

CICSplex configuration

WORKLOAD

Workload management

type

is the specific or generic name of an area that qualifies the CICSplex SM function to be affected. The specific names are:

AIMODEL

CICS AIMODEL

APPLICTN

CICS bundle resources and resources only installable by CICS bundles

APPLICATION

Applications deployed in platforms

BRFACIL

Link3270 Bridge Facility

CONNECT

CICS connections

DB2DBCTL

DB2/DBCTL resources and subsystems

DEF

CICSplex SM definitions

DOCTEMP

Document templates

ENQMODEL

CICS global enqueue models

ENTJAVA

CorbaServers and deployed DJARs

EXIT

CICS exits

FEPI

CICS FEPI resources

FILE

CICS files

IPCONN

IPIC connections

JOURNAL

Journal models

PARTNER

CICS partners

PLATFORM

Platforms

PROCTYPE

CICS BTS Process types

PROFILE

CICS profiles

PROGRAM

CICS programs

REGION

CICS region data

RQMODEL

CICS request models

TASK

CICS active tasks

TCPIPS

TCP/IP services

TDQUEUE

CICS transient data queues

TERMINAL

CICS terminals

TRAN

CICS transactions

TSQUEUE

CICS temporary storage queues

UOW

CICS units of work

The type must be valid for the specified function. [Table 27 on page 182](#) lists the valid function.type combinations.

context

Context is the specific or generic name of the CMAS or CICSplex to be affected by the designated function and type. If the function is CONFIG, the context can be a CMAS or a CICSplex. For all other functions, the context must be a CICSplex.

scope

Scope is the specific or generic name of a CICS system in the CICSplex identified as the context. Do not specify scope when the context is a CMAS, the type is DEF (except when handling CSD resources) or when the function is CLOUD.

Note:

1. In this section only, the term scope means CICS systems. It does **not** mean the scope (CICS system groups) you have defined as part of the CICSplex environment, nor does it refer to a BAS logical scope.
2. To include all of the systems comprising a CICS system group when their names do not match a generic system name, you must establish a profile for each system.

Using asterisks in resource names

To reduce the number of profiles you need to define, you can use * (one asterisk) and ** (two consecutive asterisks) to represent one or more entries. Use of one or two asterisks is optional.

Note: Before using asterisks in profile definitions, ensure that generics have been activated for the relevant class:

```
SETROPTS GENERIC(CPSMOBJ,CPSMXMP)
```

The following examples demonstrate how asterisks can be used:

OPERATE.*.EYUPLX01.EYUPLX01

Indicates that all views and action commands associated with any type valid within the OPERATE function are to be recognized when the context and scope are EYUPLX01.

OPERATE.PROGRAM.**

Indicates that all views and action commands associated with the PROGRAM type within the OPERATE function are to be recognized, regardless of the current context and scope.

OPERATE.**

Indicates that all views and action commands associated with any type valid within the OPERATE function are to be recognized, regardless of the current context and scope.

Indicates that *all* views and action commands associated with *any* type valid within *any* function are to be recognized, regardless of the current context and scope.

Valid resource name combinations

You can use these function and type combinations when creating profiles to control access to resource tables using the CICSplex SM API or WUI.

[Table 27 on page 182](#) lists the valid function and type combinations and the resource names associated with each combination. If you are using the WUI, note that the resource name is given at the foot of the views in the corresponding view set.

Table 27. Function and type combinations for resources accessible using CICSplex SM

Function.Type	Resource Table Name and Usage
ANALYSIS.DEF	<p>ACTION Create, display, and maintain action definitions.</p> <p>APACTV Display analysis definitions associated with an analysis point specification.</p> <p>APSPEC Create, display, and maintain analysis point specifications.</p> <p>CMDMPAPS Identify the role of a primary CMAS.</p> <p>CMDMSAPS Identify the role of a secondary CMAS.</p> <p>EVALDEF Create, display, and maintain evaluation definitions.</p> <p>EVENT Display changes in the status of a CICSplex.</p> <p>EVENTDTL Display evaluation definitions associated with an analysis definition that caused an event.</p> <p>LNKSRSCG Describe the link between a CICS system group and an analysis specification.</p> <p>LNKSRSCS Describe the link between a CICS system and an analysis specification.</p> <p>RTAACTV Display analysis and status definitions in CICS systems.</p> <p>RTADEF Create, display, and maintain analysis definitions.</p> <p>RTAGROUP Create, display, and maintain analysis groups.</p> <p>RTAINAPS Display analysis groups in analysis point specifications.</p> <p>RTAINGRP Display analysis and status definitions in analysis groups.</p> <p>RTAINSPC Display analysis groups in analysis specifications.</p> <p>RTASPEC Create, display, and maintain analysis specifications.</p> <p>STATDEF Create, display, and maintain status definitions.</p> <p>STAINGRP Identify the membership relation of a status definition in an RTAGROUP.</p>
BAS.APPLICTN	<p>BUNDEF Install applications that are deployed as bundles.</p>

Table 27. Function and type combinations for resources accessible using CICSplex SM (continued)

Function.Type	Resource Table Name and Usage
BAS.CONNECT	<p>CONNDEF Install ISC/MRO connection definitions.</p> <p>IPCONDEF Install IPIC connection definitions.</p> <p>SESSDEF Install session definitions.</p>
BAS.DB2DBCTL	<p>DB2CDEF Install DB2 connection definitions.</p> <p>DB2EDEF Install DB2 entry definitions.</p> <p>DB2TDEF Install DB2 transaction definitions.</p>

Table 27. Function and type combinations for resources accessible using CICSplex SM (continued)

Function.Type	Resource Table Name and Usage
BAS.DEF	<p>ATOMDEF Create, display, and maintain Atom service definitions.</p> <p>BUNDEF Create, display, and maintain bundle definitions.</p> <p>CONNDEF Create, display, and maintain MRO and ISC over SNA connection definitions.</p> <p>DB2CDEF Create, display, and maintain DB2 connection definitions.</p> <p>DB2EDEF Create, display, and maintain DB2 entry definitions.</p> <p>DB2TDEF Create, display, and maintain DB2 transaction definitions.</p> <p>DOCDEF Create, display, and maintain document template definitions.</p> <p>ENQMDEF Create, display, and maintain enqueue models definitions.</p> <p>FENODEF Create, display, and maintain FEPI node definitions.</p> <p>FEPODEF Create, display, and maintain FEPI pool definitions.</p> <p>FEPRODEF Create, display, and maintain FEPI property set definitions.</p> <p>FETRGDEF Create, display, and maintain FEPI target definitions.</p> <p>FILEDEF Create, display, and maintain file definitions.</p> <p>IPCONDEF Create, display, and maintain IPIC connection definitions.</p> <p>JRNMDEF Create, display, and maintain journal model definitions.</p> <p>JVMSVDEF Create, display, and maintain JVM server definitions.</p> <p>LIBDEF Create, display, and maintain LIBRARY definitions.</p> <p>LSRDEF Create, display, and maintain LSR pool definitions.</p> <p>MAPDEF Create, display, and maintain mapset definitions.</p> <p>MQCONDEF Create, display, and maintain WebSphere MQ connection definitions.</p> <p>MQMONDEF Create, display, and maintain WebSphere MQ monitor definitions.</p> <p>PARTDEF Create, display, and maintain partner definitions.</p> <p>PIPEDEF Create, display, and maintain pipeline definitions.</p> <p>PROCDEF Create, display, and maintain process type definitions.</p>

Table 27. Function and type combinations for resources accessible using CICSplex SM (continued)

Function.Type	Resource Table Name and Usage
BAS.DEF (continued)	<p>PROFDEF Create, display, and maintain profile definitions.</p> <p>PROGDEF Create, display, and maintain program definitions.</p> <p>PRTNDEF Create, display, and maintain partition set definitions.</p> <p>RASGNDEF Create, display, and maintain resource assignments.</p> <p>RASINDSC Display resource assignments in descriptions.</p> <p>RASPROC Display resource assignment process.</p> <p>RDSCPROC Display resource description process.</p> <p>RESEDESC Create, display, maintain, and install resource descriptions.</p> <p>RESGROUP Create, display, maintain, and install resource groups.</p> <p>RESINDSC Display resource groups in descriptions.</p> <p>RESINGRP Display resource definitions in groups.</p> <p>RQMDEF Create, display, and maintain request model definitions.</p> <p>SESSDEF Create, display, and maintain session definitions.</p> <p>SYSRES Display CICS system resources.</p> <p>TCPDEF Create, display, and maintain TCP/IP service definitions.</p> <p>TDQDEF Create, display, and maintain transient data queue definitions.</p> <p>TERMDEF Create, display, and maintain terminal definitions.</p> <p>TRANDEF Create, display, and maintain transaction definitions.</p> <p>TRNCLDEF Create, display, and maintain transaction class definitions.</p> <p>TYPTMDEF Create, display, and maintain typeterm definitions.</p> <p>URIMPDEF Create, display, and maintain URI map definitions.</p> <p>WEBSVDEF Create, display, and maintain web services definitions.</p>

Table 27. Function and type combinations for resources accessible using CICSplex SM (continued)

Function.Type	Resource Table Name and Usage
BAS.DEF (continued)	<p>ATMINGRP Describe the membership of an Atom service definition in a resource group.</p> <p>BUNINGRP Describe the membership of a bundle definition in a resource group.</p> <p>CONINGRP Describe the membership of an MRO or ISC over SNA connection definition in a resource group.</p> <p>DOCINGRP Describe the membership of a document template definition in a resource group.</p> <p>D2CINGRP Describe the membership of a DB2 connection definition in a resource group.</p> <p>D2EINGRP Describe the membership of a DB2 entry definition in a resource group.</p> <p>D2TINGRP Describe the membership of a DB2 transaction definition in a resource group.</p> <p>ENQINGRP Describe the membership of an ENQ/DEQ model definition in a resource group.</p> <p>FILINGRP Describe the membership of a file definition in a resource group.</p> <p>FNOINGRP Describe the membership of a FEPI node definition in a resource group.</p> <p>FPOINGRP Describe the membership of a FEPI pool definition in a resource group.</p> <p>FPRINGRP Describe the membership of a FEPI property set definition in a resource group.</p> <p>FSGINGRP Describe the membership of a file key segment definition in a resource group.</p> <p>FTRINGRP Describe the membership of a FEPI target definition in a resource group.</p> <p>IPCINGRP Describe the membership of an IPIC connection definition in a resource group.</p> <p>JMSINGRP Describe the membership of a JVM server definition in a resource group.</p> <p>JRMINGRP Describe the membership of a journal model definition in a resource group.</p> <p>LIBINGRP Describe the membership of a LIBRARY definition in a resource group.</p> <p>LSRINGRP Describe the membership of an LSR pool definition in a resource group.</p> <p>MAPINGRP Describe the membership of a map set definition in a resource group.</p> <p>MQCINGRP Display WebSphere MQ connection definitions in groups.</p>

Table 27. Function and type combinations for resources accessible using CICSplex SM (continued)

Function.Type	Resource Table Name and Usage	
BAS.DEF (continued)	<p>PARINGRP Describe the membership of a partner definition in a resource group.</p> <p>PGMINGRP Describe the membership of a program definition in a resource group.</p> <p>PIPINGRP Describe the membership of a pipeline definition in a resource group.</p> <p>PRCINGRP Describe the membership of a process type definition in a resource group.</p> <p>PRNINGRP Describe the membership of a partition set definition in a resource group.</p> <p>PROINGRP Describe the membership of a profile definition in a resource group.</p> <p>SESINGRP Describe the membership of a session definition in a resource group.</p> <p>TCLINGRP Describe the membership of a transaction class definition in a resource group.</p> <p>TCPINGRP Describe the membership of a TCPIP Service definition in a resource group.</p> <p>TDQINGRP Describe the membership of a transient data queue definition in a resource group.</p> <p>TRMINGRP Describe the membership of a terminal definition in a resource group.</p> <p>TRNINGRP Describe the membership of a transaction definition in a resource group.</p> <p>TSMINGRP Describe the membership of a temporary storage model definition in a resource group.</p> <p>TYPINGRP Describe the membership of a typeterm definition in a resource group.</p> <p>URIINGRP Describe the membership of a URI map definition in a resource group.</p> <p>WEBINGRP Describe the membership of a web service definition in a resource group.</p>	
	BAS.DOCTEMP	<p>DOCTEMP Install document template definitions.</p>
	BAS.ENQMODEL	<p>ENQMDEF Install enqueue model definitions.</p>
	BAS.ENTJAVA	<p>JVMSVDEF Install JVM server definitions.</p>
	BAS.FILE	<p>FILEDEF Install file definitions.</p>
	BAS.JOURNAL	<p>JRNMDEF Install journal model definitions.</p>

Table 27. Function and type combinations for resources accessible using CICSplex SM (continued)

Function.Type	Resource Table Name and Usage
BAS.PARTNER	PARTDEF Install partner definitions.
BAS.PROCTYPE	PROCDEF Install BTS Process type definitions.
BAS.PROFILE	PROFDEF Install profile definitions.
BAS.PROGRAM	LIBDEF Install LIBRARY definitions. MAPDEF Install map set definitions. PROGDEF Install program definitions. PRTNDEF Install partition set definitions.
BAS.REGION	LSRDEF Install LSR pool definitions. MQCONDEF Install WebSphere MQ connection definitions. MQMONDEF Install WebSphere MQ monitor definitions. TRNCLDEF Install transaction class definitions.
BAS.TCPIPS	ATOMDEF Install Atom service definitions. PIPEDEF Install pipeline definitions. TCPDEF Install TCP/IP service definitions. URIMPDEF Install URI map definitions. WEBSVDEF Install web services definitions.
BAS.TDQUEUE	TDQDEF Install transient data queue definitions.
BAS.TERMINAL	TERMDEF Install terminal definitions. TYPTMDEF Install typeterm definitions.
BAS.TRAN	TRANDEF Install transaction definitions.

Table 27. Function and type combinations for resources accessible using CICSplex SM (continued)

Function.Type	Resource Table Name and Usage
CLOUD.APPLICATION	<p>APPLDEF Install application definitions in platforms.</p> <p>APPLCTN Display and manage applications deployed in platforms.</p>
CLOUD.DEF	<p>APPLDEF Create, display, and maintain application definitions in platforms.</p> <p>PLATDEF Create, display, and maintain platform definitions.</p>
CLOUD.PLATFORM	<p>PLATDEF Install platform definitions.</p> <p>PLATFORM Display and manage platforms.</p> <p>MGMTPART Create, display, and maintain management parts for applications and platforms.</p>
CONFIG.DEF	<p>CICSPLEX Display and manage CMAS in CICSplex.</p> <p>CMAS Display and manage active CMASs.</p> <p>CMASLIST Describe a CMAS and its connection to characteristics.</p> <p>CMASPLEX Display CICSplexes for a CMAS.</p> <p>CMTCMDEF Create, display, and maintain CMAS links.</p> <p>CMTMMLNK Display active CMAS links.</p> <p>CMTPMLNK Display an active CMAS-to-MAS link.</p> <p>CPLEXDEF Create, display, and maintain CICSplex definitions.</p> <p>CPLXCMAS Display CMAS to CICSplex.</p>

Table 27. Function and type combinations for resources accessible using CICSplex SM (continued)

Function.Type	Resource Table Name and Usage
CSD.DEF	<p>ATOMDEF Create, install, display, and maintain Atom service definitions.</p> <p>BUNDEF Create, install, display, and maintain bundle definitions.</p> <p>CONNDEF Create, install, display, and maintain MRO and ISC over SNA connection definitions.</p> <p>CSDGROUP Create, install, display, and maintain CSD resource group definitions.</p> <p>CSDINGRP Describe the membership of a CSD resource group.</p> <p>CSDINLST Describe the membership of a CSD resource group list.</p> <p>CSDLIST Create, install, display, and maintain CSD resource group list definitions.</p> <p>DB2CDEF Create, install, display, and maintain DB2 connection definitions.</p> <p>DB2EDEF Create, install, display, and maintain DB2 entry definitions.</p> <p>DB2TDEF Create, install, display, and maintain DB2 transaction definitions.</p> <p>DOCDEF Create, install, display, and maintain document template definitions.</p> <p>ENQMDEF Create, install, display, and maintain enqueue models definitions.</p> <p>FILEDEF Create, install, display, and maintain file definitions.</p> <p>IPCONDEF Create, install, display, and maintain IPIC connection definitions.</p> <p>JRNMDEF Create, install, display, and maintain journal model definitions.</p> <p>JVMSVDEF Create, install, display, and maintain JVM server definitions.</p> <p>LIBDEF Create, install, display, and maintain LIBRARY definitions.</p> <p>LSRDEF Create, install, display, and maintain LSR pool definitions.</p> <p>MAPDEF Create, install, display, and maintain mapset definitions.</p> <p>MQCONDEF Create, install, display, and maintain WebSphere MQ connection definitions.</p> <p>MQMONDEF Create, install, display, and maintain WebSphere MQ monitor definitions.</p>

Table 27. Function and type combinations for resources accessible using CICSplex SM (continued)

Function.Type	Resource Table Name and Usage	
CSD.DEF (continued)	<p>PARTDEF Create, install, display, and maintain partner definitions.</p> <p>PIPEDEF Create, install, display, and maintain pipeline definitions.</p> <p>PROCDEF Create, install, display, and maintain process type definitions.</p> <p>PROFDEF Create, install, display, and maintain profile definitions.</p> <p>PROGDEF Create, install, display, and maintain program definitions.</p> <p>PRTNDEF Create, install, display, and maintain partition set definitions.</p> <p>SESSDEF Create, display, and maintain session definitions.</p> <p>TCPDEF Create, install, display, and maintain TCP/IP service definitions.</p> <p>TDQDEF Create, install, display, and maintain transient data queue definitions.</p> <p>TERMDEF Create, install, display, and maintain terminal definitions.</p> <p>TRANDEF Create, install, display, and maintain transaction definitions.</p> <p>TRNCLDEF Create, install, display, and maintain transaction class definitions.</p> <p>TSMINGRP Describe the membership of a temporary storage model definition in a resource group.</p> <p>TYPTMDEF Create, install, display, and maintain typeterm definitions.</p> <p>URIMPDEF Create, install, display, and maintain URI map definitions.</p> <p>WEBSVDEF Create, install, display, and maintain web services definitions.</p>	
	MONITOR.CONNECT	<p>MCONNECT ISC and MRO connections</p> <p>MMODENAME LU 6.2 modenames</p>
	MONITOR.DB2DBCTL	<p>MDB2THRD DB2 threads</p>

Table 27. Function and type combinations for resources accessible using CICSplex SM (continued)

Function.Type	Resource Table Name and Usage
MONITOR.DEF	<p>LNKSMSCG Describe the link between a CICS system group and a monitor specification.</p> <p>LNKSMSCS Describe the link between a CICS system and a monitor specification.</p> <p>MONDEF Create, display, and maintain monitor definitions.</p> <p>MONGROUP Create, display, and maintain monitor groups.</p> <p>MONINGRP Create, display, and maintain monitor definitions in monitor groups.</p> <p>MONINSPC Create, display, and maintain monitor groups in monitor specifications.</p> <p>MONSPEC Create, display, and maintain monitor specifications.</p> <p>POLMON Describe a monitor definition in a specific CICS system.</p>
MONITOR.FEPI	<p>MFEPICON FEPI connections</p>
MONITOR.FILE	<p>MCMDT Data tables</p> <p>MLOCFILE Local files</p> <p>MREMFIL Remote files</p>
MONITOR.JOURNAL	<p>MJOURNAL Journals</p> <p>MJRNLNAM Journal names</p>
MONITOR.PROGRAM	<p>MPROGRAM Programs</p>
MONITOR.REGION	<p>MCICSDSA Dynamic storage areas</p> <p>MCICSRGN CICS systems</p> <p>MLSRPBUF LSRPOOL buffer pool</p> <p>MLSRPOOL LSRPOOL</p> <p>MTRANCLS Transaction classes</p>

Table 27. Function and type combinations for resources accessible using CICSplex SM (continued)

Function.Type	Resource Table Name and Usage
MONITOR.TDQUEUE	MINDTDQ Indirect transient data queues
	MNTRATDQ Intrapartition transient data queues
	MREMTDQ Remote transient data queues
	MTDQGBL Global intrapartition transient data queues
	MXTRATDQ Extrapartition transient data queues
MONITOR.TERMINAL	MTERMNL Terminals
MONITOR.TRAN	MLOCTRAN Local transactions
	MREMTRAN Remote transactions
MONITOR.TSQUEUE	MTSQGBL Global temporary storage queues
OPERATE.AIMODEL	AIMODEL Autoinstall models
	CRESAIMD Describe an instance of an autoinstalled terminal model in a CICS system.

Table 27. Function and type combinations for resources accessible using CICSplex SM (continued)

Function.Type	Resource Table Name and Usage	
OPERATE.APPLICTN	<p>BUNDLE A CICS resource object that provides information about bundles.</p> <p>BUNDPART A CICS resource object that provides information about a bundle part.</p> <p>CRESBUND Describes an instance of a bundle in a CICS system.</p> <p>CRESXMLT Describes an instance of an XMLTRANSFORM resource in a CICS system.</p> <p>EPADAPT A CICS resource object that provides information about EP adapters.</p> <p>EPADSET A CICS resource object that provides information about EP adapter sets.</p> <p>EPAINSET A CICS resource object that provides the name of event processing adapters in an event processing adapter set.</p> <p>EVCSDATA A CICS resource object that provides information about application data predicates.</p> <p>EVCSINFO A CICS resource object that provides information about information sources.</p> <p>EVCSOPT A CICS resource object that provides information about application option predicates.</p> <p>EVCSPEC A CICS resource object that provides information about capture specifications.</p> <p>EVNTBIND A CICS resource object that provides information about event bindings.</p> <p>EVNTGBL A CICS resource object that provides information about event processing.</p> <p>OSGIBUND A CICS resource object that provides information about an OSGi bundle.</p> <p>OSGISERV A CICS resource object that provides information about an OSGi service.</p> <p>XMLTRANS XMLTRANSFORM resources.</p>	
	OPERATE.BRFACIL	<p>BRFACIL LINK3270 bridge facility</p>

Table 27. Function and type combinations for resources accessible using CICSplex SM (continued)

Function.Type	Resource Table Name and Usage	
OPERATE.CONNECT	CONNECT MRO and ISC over SNA connections	
	CRESCONN Describe an instance of an MRO or ISC over SNA connection in a CICS system.	
	CRSIPCN Describe an instance of an IPIC connection in a CICS system.	
	CRESMODE Describe an instance of an LU6.2 modename in a CICS system.	
	IPCONN IPIC connections	
	MODENAME LU 6.2 modenames	
	OPERATE.DB2DBCTL	CRESDB2C Describe an instance of a DB2 connection in a CICS system.
CRESDB2E Describe an instance of a DB2 entry in a CICS system.		
CRESDB2P Describe an instance of a DB2 package set in a CICS region.		
CRESDB2T Describe an instance of a DB2 transaction in a CICS system.		
DB2CONN DB2 connection		
DB2ENTRY DB2 entry		
DB2PKGST DB2 package set		
DB2TRN DB2 transaction		
DBCTLSS DBCTL subsystem		
DB2SS DB2 subsystem		
DB2THRD DB2 threads		
DB2TRAN DB2 transactions		
OPERATE.DOCTEMP		CRESDOCT Describe an instance of a document template in a CICS system.
		DOCTEMP Document templates
OPERATE.ENQMODEL		CRESENQM Describe an instance of an ENQ/DEQ model in a CICS system.
	ENQMODEL Enqueue models	

Table 27. Function and type combinations for resources accessible using CICSplex SM (continued)

Function.Type	Resource Table Name and Usage
OPERATE.ENTJAVA	CLCACHE Shared class caches
	CRESJVMS Describe an instance of a JVM server in a CICS region.
	JVM Java™ virtual machines
	JVMPPOOL JVM pools
	JVMPROF JVM profiles
	JVMSERV JVM servers
OPERATE.EXIT	CRESSLUE Describe an instance of a global user exit in a CICS system.
	CRESTRUE Describe an instance of a task-related user exit in a CICS system.
	EXITGLUE Global user exits
	EXITTRUE Task-related user exits
	EXTGLORD Ordered global user exits
OPERATE.FEPI	CRESFECO Describe an instance of a FEPI connection in a CICS system.
	CRESFEND Describe an instance of a FEPI node in a CICS system.
	CRESFEP0 Describe an instance of a FEPI pool in a CICS system.
	CRESFETR Describe an instance of a FEPI target in a CICS system.
	FEPICONN FEPI connections
	FEPINODE FEPI nodes
	FEPIPOOL FEPI pools
	FEPIPROP FEPI property sets
	FEPITRGT FEPI targets

Table 27. Function and type combinations for resources accessible using CICSplex SM (continued)

Function.Type	Resource Table Name and Usage
OPERATE.FILE	CFDTPOOL Coupling facility data tables pools
	CMDT Data tables
	CRESDSNM Describe an instance of a data set in a CICS system.
	CRESDSNM Describe an instance of a data set in a CICS system.
	DSNAME Data sets
	LOCFILE Local files
	REMFIL Remote files
OPERATE.JOURNAL	CRESDSNM Describe an instance of a journal in a CICS system.
	CRESDSNM Describe an instance of a journal name in a CICS system.
	JRNLMODL Journal models
	JRNLMODL System logs and general logs
	STREAMNM MVS log streams
OPERATE.PARTNER	CRESDSNM Describe an instance of a partner table in a CICS system.
	PARTNER CICS partners
OPERATE.PROCTYPE	CRESDSNM Describe an instance of a process type in a CICS system.
	PROCTYP Process types
OPERATE.PROFILE	CRESDSNM Describe an instance of a profile in a CICS system.
	PROFILE CICS profiles

Table 27. Function and type combinations for resources accessible using CICSplex SM (continued)

Function.Type	Resource Table Name and Usage
OPERATE.PROGRAM	<p>CRESPRGM Describe an instance of a program in a CICS system.</p> <p>PROGRAM Programs</p> <p>LIBDSN LIBRARY data set names</p> <p>LIBRARY LIBRARY data sets</p> <p>RPLLIST DFHRPL data sets</p>

Table 27. Function and type combinations for resources accessible using CICSplex SM (continued)

Function.Type	Resource Table Name and Usage
OPERATE.REGION	<p>CICSDSA Dynamic storage areas</p> <p>CICSPAGP CICS page pools</p> <p>CICSRGN CICS systems</p> <p>CICSSTOR All CICS dynamic storage areas</p> <p>CRESSDMP Describe an instance of a system dump code in a CICS system.</p> <p>CRESTDMP Describe an instance of a transaction dump code in a CICS system.</p> <p>DOMSPOOL CICS storage domain subpools</p> <p>DSPGBL Global CICS dispatcher</p> <p>DSPMODE CICS dispatcher TCB mode</p> <p>DSPPOOL CICS Dispatcher TCB pool</p> <p>ENQUEUE CICS enqueues</p> <p>LOADACT CICS Loader activity by dynamic storage area</p> <p>LOADER CICS loader activity</p> <p>LSRPBUF Buffer usage for LSR pools</p> <p>LSRPOOL LSR pools</p> <p>MASHIST MAS history</p> <p>MONITOR CICS monitoring and statistics</p> <p>MQCON WebSphere MQ connection</p> <p>MQCONN WebSphere MQ connection statistics</p> <p>MQINI WebSphere MQ initiation queue</p> <p>MQMON WebSphere MQ monitor</p> <p>MVSESTG MVS storage element</p> <p>MVSTCB MVS TCB</p> <p>MVSTCBGL Global MVS TCB</p> <p>MVSWLM z/OS Workload Manager</p>

Table 27. Function and type combinations for resources accessible using CICSplex SM (continued)

Function.Type	Resource Table Name and Usage
OPERATE.REGION (continued)	<p>RECOVERY CICS recovery manager</p> <p>REQID Timed requests</p> <p>SYSDUMP System dump codes</p> <p>SYSPARM A CICS Resource that describes a system initialization parameter or a system initialization parameter override in an active CICS system being managed by CICSplex SM.</p> <p>TRANCLAS Transaction classes</p> <p>TRANDUMP Transaction dump codes</p>
OPERATE.RQMODEL	<p>CRSRQMD Describe an instance of a request in a CICS system.</p>
OPERATE.TASK	<p>EXCI</p> <p>HTASK Completed task</p> <p>TASK Active tasks</p> <p>TASKESTG Task storage element</p> <p>TASKFILE Task file usage</p> <p>TASKRMI RMI usage by individual task</p> <p>TASKTSQ TSQ usage by individual task</p> <p>TSKSPOLS All task subpools</p> <p>TSKSPool Task storage subpools</p>

Table 27. Function and type combinations for resources accessible using CICSplex SM (continued)

Function.Type	Resource Table Name and Usage	
OPERATE.TCPIPS	ATOMSERV Atom services	
	CRESATOM Describe an instance of an Atom service in a CICS system.	
	CRESTCPS Describe an instance of a TCP/IP service in a CICS system.	
	HOST URI Host	
	IPFACIL IPIC connection sessions	
	PIPELINE Pipelines	
	TCPIPGBL TCP/IP global statistics	
	TCPIPS TCP/IP services	
	URIMAP URI maps	
	URIMPGBL URI map global statistics	
	WEBSERV Web services	
	OPERATE.TDQUEUE	CRESTDQ Describe an instance of a transient data queue in a CICS system.
		EXTRATDQ Extrapartition transient data queues
INDTDQ Indirect transient data queues		
INTRATDQ Intrapartition transient data queues		
REMTDQ Remote transient data queues		
TDQGBL Intrapartition transient data queue usage		
OPERATE.TERMINAL		CRESTERM Describe an instance of a terminal in a CICS system.
	TERMNL Terminals	

Table 27. Function and type combinations for resources accessible using CICSplex SM (continued)

Function.Type	Resource Table Name and Usage
OPERATE.TRAN	CRESTRAN Describe an instance of a transaction in a CICS system.
	LOCTRAN Local transactions
	REMTRAN Remote transactions
	TASKASSC Task association data
OPERATE.TSQUEUE	CRESTSMD Describe an instance of a temporary storage queue in a CICS system.
	TSQUEUE Temporary storage queues
	TSMODEL Temporary storage models
	TSPool Temporary storage pools
	TSQGBL Global temporary storage queues
	TSQSHR Shared temporary storage queues
	TSQNAME Long temporary storage queues
OPERATE.UOW	UOWDSNF Display shunted units of work
	UOWENQ Display enqueues for executing units of work
	UOWLINK Display links for unit of work
	UOW Display executing units of work

Table 27. Function and type combinations for resources accessible using CICSplex SM (continued)

Function.Type	Resource Table Name and Usage
TOPOLOGY.DEF	<p>CSYSGRP Create, display, and maintain CICS system groups.</p> <p>CSYSDEF Create, display, and maintain CICS systems.</p> <p>CSGLCGCG Describe the link of a CICS system group to an outer system group.</p> <p>CSGLCGCS Describe the link of a CICS system to a system group.</p> <p>MAS Display CICS systems in a CICSplex.</p> <p>MASSTAT Display CICS systems in a CICSplex by CMAS.</p> <p>PERIODEF Display period definitions.</p> <p>SYSLINK Display information about the links that exist between CICS systems.</p>

Table 27. Function and type combinations for resources accessible using CICSplex SM (continued)

Function.Type	Resource Table Name and Usage
WORKLOAD.DEF	DTRINGRP Display transactions in transaction groups.
	LNKSWSCG Describe the link between a CICS system group and a workload specification.
	LNKSWSCS Describe the link between a CICS system and a workload specification.
	TRANGRP Create, display, and maintain transaction groups.
	WLMATAFF Display and discard active affinities.
	WLMATGRP Display and discard active transaction groups
	WLMATRAN Display and discard transaction directory.
	WLMAWAOR Display active AORs in a workload.
	WLMAWDEF Display and discard active workload definitions.
	WLMAWORK Display active workloads.
	WLMAWTOR Display active TORs in a workload.
	WLMDEF Create, display, and maintain workload definitions.
	WLMGROUP Create, display, and maintain workload groups.
	WLMINGRP Display workload definitions in groups.
	WLMINSPC Display workload groups in workload specifications.
	WLMSPEC Create, display, and maintain workload specifications.

Security for platforms and applications

You can secure resources for applications that are deployed on platforms by creating RACF security profiles for CICSplex SM to cover platforms and applications in a CICSplex.

Security for platforms and applications is set up in a similar way to security for other CICSplex SM components. You control access to a specific set of views (and their associated action commands) by identifying the set in a security profile. With these security profiles, you can give users authority to install, enable or disable, make available or unavailable, inquire on, or discard platforms and applications, and ensure that unauthorized users cannot create and administer these resources.

When you give a user authority to perform an action on a platform or application, you also give them authority to perform the same action on the dynamically generated resources for the platform or application. For example, a user who has authority to enable an application also has authority to enable the CICS bundles for the application that were installed in CICS regions in all the platforms in the CICSplex. CICS command and resource security checks, and simulated CICS security checking in CICSplex SM, are not carried out when you operate on CICS bundles through an application or platform.

You can secure a platform and its deployed applications by setting up security profiles with the following function and type combinations:

CLOUD.DEF.context

This security profile covers the PLATDEF and APPLDEF resource tables, which contain the definitions for platforms and applications. *context* is the specific or generic name of the CICSplex that is covered by the security profile.

Users with UPDATE access for this security profile can create, update, and remove definitions for platforms and applications in the CICSplex SM data repository. Users with READ access can view those definitions in the CICSplex SM data repository.

CLOUD.PLATFORM.context

This security profile covers the installation of PLATDEF resources and operations on PLATFORM resources. It also allows users to view management parts (MGMTPART resources). *context* is the specific or generic name of the CICSplex that is covered by the security profile.

Users with ALTER access for this security profile can install platforms in the CICSplex and discard them. (To install a platform, users also need READ access for the CLOUD.DEF profile that covers the PLATDEF resource.) Users with UPDATE access can enable and disable platforms. Users with UPDATE access can also add CICS regions to region types in the platform and remove CICS regions from region types in the platform. Users with READ access can view PLATFORM resources and MGMTPART resources. These permissions apply for all platforms that exist in the CICSplex.

CLOUD.APPLICATION.context

This security profile covers the installation of APPLDEF resources and operations on APPLCTN resources. *context* is the specific or generic name of the CICSplex that is covered by the security profile.

Users with ALTER access for this security profile can install applications in the CICSplex and discard them. (To install an application, users also need READ access for the CLOUD.DEF profile that covers the APPLDEF resource.) Users with UPDATE access can enable and disable applications and make them available or unavailable. Users with READ access can view APPLCTN resources. These permissions apply for all applications in all platforms that exist in the CICSplex. If you require different security permissions for certain applications, use a different CICSplex to host the platform where you deploy the application.

Note: These security profiles are only checked in the maintenance point CMAS. Security checks are reported by message EYUCR0009I in the EYULOG of the maintenance point CMAS. To receive message EYUCR0009I for violations you must set the CICSplex SM system parameter (EYUPARM) **SECLOGMSG** to YES. For more information about **SECLOGMSG**, see [CICSplex SM system parameters](#).

Although the CLOUD security profiles cover actions on the dynamically generated resources for the platform or application, users may still carry out a limited set of actions directly on individual resources in the CICSplex and CICS regions where they are installed:

- You can modify the CICSplex SM topology definition (CSYSDEF, or CICS system definition) for a CICS region that is part of a platform. Attribute values that you specified at the region type level are locked and cannot be changed, but other attribute values can be changed.
- You can make available or unavailable, enable or disable, or inquire on, a BUNDLE resource that was dynamically created when you installed a platform or application. You cannot discard an individual CICS bundle directly if it was created when you installed a platform or application.
- You can inquire on a dynamically created resource, such as a PROGRAM resource, that was defined inside a CICS bundle and created when you installed a platform or application. You cannot enable, disable, or discard these resources directly if they were created when you installed a platform or application.

CICS command and resource security checks, and simulated CICS security checking in CICSplex SM, do apply when you perform an action directly on a CICS region that is part of a platform, or on an individual CICS bundle, or a resource defined in a CICS bundle, that was created when you installed a platform or application.

- A `TOPOLOGY.DEF.context` security profile covers actions on the CICSplex SM topology definitions for individual CICS regions that are part of a platform. `context` is the specific or generic name of the CICSplex that is covered by the security profile. Users with UPDATE access can modify the CSYSDEF for a CICS region that is part of a platform, with the exception of attribute values that are locked by the platform itself.
- CICS bundles created when you install a platform or application have a unique generated name beginning with the \$ character. To provide security for actions on individual CICS bundles that were dynamically created in this way, you can set up a security profile specifying the BUNDLE resource type and the resource name \$*. Users with UPDATE access for BUNDLE.\$* can make available or unavailable, or enable or disable, BUNDLE resources created for platforms and applications, and users with READ access can inquire on those BUNDLE resources.

If you apply security measures to individual PROGRAM resources, for applications that are deployed on platforms, secure the programs that are declared as application entry points, but do not secure other programs in the applications. The security settings that you specify for a program that is part of an application deployed on a platform apply to both public and private programs, and do not take into account the version of the application. Programs that are declared as an application entry point must have a unique PROGRAM resource name in your environment. However, if you secure programs that run at a lower level in the application, programs with the same names might be running in different applications, which can lead to unforeseen consequences. In this situation, a user might have permission to access a program that is declared as an application entry point, but not have permission to access a program that runs at a lower level in the application, because the security settings from another instance of the program name are in effect. Consider the security measures that you apply to a program that is declared as an application entry point program, as applying to the whole application.

If you used CICS bundles in earlier CICS releases, check the security permissions that you gave to users for those bundles. Depending on the way in which you set up security for CICS bundles, users with authority to take actions on individual CICS bundles might now be able to act on resources that are dynamically created as part of the installation of a bundle. Ensure that the levels of authority for BUNDLE resources are still appropriate.

Table 28 on page 206 summarizes the security checks that apply to actions performed on a platform, an application, an individual CICS bundle that was dynamically created when you installed a platform or application, or a resource defined in a CICS bundle for a platform or application.

Operation	Platforms, including their CICS bundles	Applications, including their CICS bundles	Dynamically created CICS bundles	Resources defined in dynamically created CICS bundles
Define	CLOUD.DEF profile (UPDATE, or READ to view definitions); also TOPOLOGY.DEF profile (UPDATE to modify individual CICS region CSYSDEF after platform install)	CLOUD.DEF profile (UPDATE, or READ to view definitions)	Cannot manage resource definitions individually	Cannot manage resource definitions individually
Install	CLOUD.PLATFORM profile (ALTER) and CLOUD.DEF profile (READ)	CLOUD.APPLICATION profile (ALTER) and CLOUD.DEF profile (READ)	Cannot install individually	Cannot install individually
Enable or disable	CLOUD.PLATFORM profile (UPDATE)	CLOUD.APPLICATION profile (UPDATE)	CICS command and resource security, and simulated CICS security checking in CICSplex SM; use BUNDLE.\$* profile	Cannot enable or disable individually
Make available or unavailable	Not applicable	CLOUD.APPLICATION profile (UPDATE)	CICS command and resource security, and simulated CICS security checking in CICSplex SM; use BUNDLE.\$* profile	Cannot make available or unavailable individually

Table 28. Security checks for operations on platforms, applications, and generated CICS bundles (continued)

Operation	Platforms, including their CICS bundles	Applications, including their CICS bundles	Dynamically created CICS bundles	Resources defined in dynamically created CICS bundles
Inquire	CLOUD.PLATFORM profile (READ); also allows viewing of management parts	CLOUD.APPLICATION profile (READ)	CICS command and resource security, and simulated CICS security checking in CICSplex SM; use BUNDLE.\$* profile	CICS command and resource security, and simulated CICS security checking in CICSplex SM
Discard	CLOUD.PLATFORM profile (ALTER)	CLOUD.APPLICATION profile (ALTER)	Cannot discard individually	Cannot discard individually

For more information on setting up security for CICSplex SM and creating security profiles, see [Implementing CICSplex SM security](#).

Activating simulated CICS security

When you create RACF profiles using the CICSplex SM resource classes to permit access to the operations and monitoring views, CICSplex SM determines which views a user can access. However, CICSplex SM cannot determine if that user is authorized to access the CICS resources represented within the view.

About this task

You can enhance the security provided by your CICSplex SM profiles by activating *simulated CICS security checking*. Simulated security uses your existing RACF profiles to control access to CICS resources, CICS commands, or both. It is available only for the operations and monitor views. When using this combination of profiles, your CICSplex SM profiles determine which sets of views can be accessed and your CICS resource profiles determine which resources within the view can be accessed. For example, you can create a CICSplex SM profile that allows a user to issue the file view commands and any associated action commands, and then have CICS simulated security determine which files the user is authorized to access.

Note:

1. See [“Activating security for CICSplex SM”](#) on page 209 for important information on how the CICSplex SM and CICS security parameters can affect simulated security.
2. Simulated security involves significantly more processing overhead than using only CICSplex SM profiles and will have a negative impact on performance.
3. CICSplex SM simulated CICS security does not include the simulation of CICS surrogate security. If CICS surrogate security checking is required, see [“Considerations for CICS surrogate security checks”](#) on page 208 for guidance on how to secure your CICS regions correctly.

Procedure

- To activate or deactivate simulated security checking, use the CSYSDEF view (for a single CICS system) or CPLEXDEF view (for multiple systems). You can indicate whether you want CICS resource checking, CICS command checking, or both, to occur. CICS resource checking controls which resources are displayed in a view. CICS command checking controls what commands can be used within the view.
- To activate or deactivate simulated security checking temporarily for an active CICS system, use the MAS view.

Exempting users and resources from security checking

There might be certain individuals who do not require security checking. There might also be certain CICS resources that are sufficiently protected by CICSplex SM profiles and, therefore, do not need to be involved in security checking.

You can exempt these individuals and resources from simulated CICS security checking using the CICSplex SM CPSMXMP resource class. Exemption bypasses only the simulated CICS security checks, not the basic CICSplex SM resource checks.

For example, if a user does not have RACF authority to issue the CICS command CEMT INQ FILE, you can enable that user to achieve the same result by creating a profile in the exemption class that allows the user to issue the equivalent CICSplex SM command **LOCFILE**.

To create exemption profiles:

1. Decide which resource you want to exempt and specify this on the **PERMIT** command. Use the resource name format described in [“Specifying CICSplex SM resource names in profiles”](#) on page 178.
2. Specify the class name CPSMXMP. This RACF class controls exemption from simulated security checking.
3. Specify the type of access that you require.
 - If you do not want to bypass security checking, specify ACCESS(NONE).
 - If you want to bypass security checking of INQUIRE level commands, specify ACCESS(READ).
 - If you want to bypass security checking of INQUIRE, SET, and PERFORM level commands, specify ACCESS(UPDATE).
 - If you want to bypass security checking of all commands, including DISCARD level commands, specify ACCESS(ALTER).
4. Specify the user or the group that you want the exemptions to apply to.

The following example shows how you could define an exemption profile that allows the individuals comprising the group EYUGRP2 to bypass security checking for all views and action commands associated with the TERMINAL type within the MONITOR function, when the context is EYUPLX01 and the scope is EYUMAS1A:

```
PERMIT MONITOR.TERMINAL.EYUPLX01.EYUMAS1A /* Resource name */+
CLASS(CPSMXMP) /* Class name */+
ACCESS(UPDATE) /* Access */+
ID(EYUGRP2) /* User or group */+
/* granted access */
```

Considerations for CICS surrogate security checks

If CICS surrogate security checking is required, you need to work out which user ID against which CICS surrogate security checks will be performed and plan for that in the RACF definitions.

In some situations, CICS issues a surrogate security check on a user requesting an action that is required to be run on behalf of another user. To allow this request to be processed, the user requesting the action must have surrogate access for the other user ID.

However, CICSplex SM simulated CICS security does not include the simulation of CICS surrogate security.

For CICS surrogate security, the checks will be performed against the MAS agent user ID rather than the user issuing the request. To determine the MAS agent user ID, follow the instructions in [Determining the agent user ID of CICSplex SM components](#).

Activating security for CICSplex SM

To activate security in the CMASs and MASs, you must set the CICSplex SM and CICS security-related system initialization parameters.

Procedure

1. Specify the CICSplex SM parameter SEC in the EYUPARM data set or member defined in the JCL used to start the CMAS and MAS.
2. Specify the CICS parameter SEC= in the CICS system initialization parameters used to start the MAS.

Results

Together these parameters determine what security checking is performed. [Table 29 on page 209](#) explains the possible parameter combinations.

Table 29. Parameters controlling security checking

CMAS (CICSplex SM parameter)	MAS (CICS system initialization parameter)	Explanation
SEC(YES)	SEC=YES	Both view selection checking and simulated security checking can occur, depending on the settings in the CICSSYS and CPLEXDEF views. This means that after CICSplex SM determines whether a user can display a particular view, simulated security determines what information can be provided in the view.
SEC(YES)	SEC=NO	View selection occurs; simulated security checking does not occur even if it is requested in the CICSSYS or CPLEXDEF views. This means that after CICSplex SM determines whether a user can display a designated view, no simulated security checking is performed to determine what information is to be provided in that view.
SEC(NO)	SEC=YES	CICSplex SM does not allow the MAS to connect to the CMAS. This prevents a MAS that has requested security from connecting to a CMAS that cannot provide security.

Note: CICSplex SM honors any of the system initialization parameters XCMD, XDB2, XDCT, XFCT, XHFS, XJCT, XPCT, XPPT, and XRES; that is, CICSplex SM includes or excludes the designated commands and resources from security checking. For each MAS, you can specify YES, NO, or CLASS NAME for these system initialization parameters. However, for the CMAS, you *must* specify NO for each of these system initialization parameters.

Refreshing RACF profiles for CICSplex SM

CICSplex SM uses a cached copy of RACF information in order to reduce unnecessary I/O to the RACF database. When you change a RACF definition, you will, in some situations, need to force the CMAS to refresh the cached information.

About this task

This includes refreshing general resource profiles and user profiles in the cache.

Procedure

Refreshing general resource profiles in the cache

A CMAS requests RACF to create a cached copy of its general resource profiles during initialization:

- During CMAS initialization, global copies of the RACF profiles in the CPSMOBJ (including GCPSMOBJ) and CPSMXMP are created.
- During MAS initialization, the MAS determines which CICS security classes are in use, using the information specified in the XCMD, XDB2, XDCT, XFCT, XJCT, XPCT and XPPT system initialization parameters. This information is passed to the CMAS where it is used to create global copies of the relevant RACF profiles.

Perform the following steps to refresh the general resource profiles in the cache.

1. To identify the profiles for which global copies exist, issue the RACF command **SETROPTS LIST**. The "GLOBAL=YES RACLIST ONLY" section of the output shows which general resource classes have been globally copied.
2. Whenever a change is made to one of these classes (for example, with the **RALTER**, **RDEFINE**, **RDELETE** or **PERMIT** commands), you must refresh the cache.

Use the following RACF command:

```
SETR RACLIST(classname) GENERIC(classname) REFRESH
```

In a multi-CMAS environment, this command will refresh the cache only on the MVS images that share the same RACF database.

3. If other CMASes run on other MVS images that do not share the same RACF database, repeat the **SETR** command on the other images.

Refreshing user profiles in the cache

A CMAS stores security information for a userid in the cache when it performs a security check. By default, the information is retained in the cache until the user has remained inactive in the CMAS for the time specified by the **SECTIMEOUT** CICSplex SM parameter and the CMAS has performed a userid timeout check.

Whenever a change is made to a userid (for example, with the **CONNECT**, **REMOVE**, **ALTUSER**, or **DELUSER** commands), the change becomes visible when the CMAS discards security information for the user from the cache.

4. To force a CMAS to discard security information from the cache before timeout processing has occurred, use one of the following actions:
 - For a single CMAS, use the **RESET USERID** action on the CMAS object.
 - For more than one CMAS, use the **RESET USERID** action on the CMASLIST object.

Both actions are available from the WUI and the API.

Perform the action when a user has previously used the CMAS and you do not want to wait for normal timeout processing to occur.

5. To force a CMAS to immediately check for userids that are eligible for timeout, use one of the following actions:
 - For a single CMAS, use the **PURGE** action on the CMAS object.
 - For more than one CMAS, use the **PURGE** action on the CMASLIST object.

Both actions are available from the WUI and the API.

CICSplex SM security checking sequence

A user can issue a single CICSplex SM command that causes data to be gathered about or an action to be performed against one or more CICS systems comprising a CICSplex. These CICS systems can reside in different MVS images.

When a user issues a request, the request is directed to the CMAS that manages the target CICS system or systems. [Figure 5 on page 212](#) and [Figure 6 on page 213](#) are flowcharts showing the procedure followed

by CICSplex SM to evaluate the security requirements of a request from a user. Here is a description of that procedure:

1. CICSplex SM determines whether CICSplex SM rules allow the request to be processed.
 - If not, CICSplex SM terminates the request and issues an error message.
2. CICSplex SM determines whether simulated CICS security checking is to be performed.
 - If not, processing continues at [“9” on page 211](#).
3. CICSplex SM determines whether the user is exempt from simulated CICS security checking.
 - If so, processing continues at [“9” on page 211](#).
4. CICSplex SM determines whether simulated CICS command checking is to be performed.
 - If not, processing continues at [“6” on page 211](#).
5. CICSplex SM determines whether the user is allowed to process the command.
 - If not, CICSplex SM terminates the request and issues an error message.
6. CICSplex SM determines whether the request is an action (not a request for information).
 - If not, processing continues at [“9” on page 211](#).
7. CICSplex SM determines whether simulated CICS resource checking is to be performed.
 - If not, processing continues at [“9” on page 211](#).
8. CICSplex SM determines whether the user is allowed access to information about the resource.
 - If not, CICSplex SM terminates the request and issues an error message.
9. CICSplex SM performs the action or gets the information.
10. CICSplex SM determines whether the request is an action (not a request for information).
 - If so, CICSplex SM returns the results of the action.
11. CICSplex SM determines whether simulated CICS security checking is to be performed.
 - If not, CICSplex SM returns the requested information in the appropriate view.
12. CICSplex SM determines whether the user is exempt from simulated CICS security checking.
 - If so, CICSplex SM returns the requested information in the appropriate view.
13. CICSplex SM determines whether simulated CICS resource checking is to be performed.
 - If not, CICSplex SM returns the requested information in the appropriate view.
14. CICSplex SM determines whether the user is allowed access to information about the resource.
 - If not, CICSplex SM excludes the requested information from the appropriate view.
15. CICSplex SM determines whether information for another resource is requested.
 - If so, processing continues at [“14” on page 211](#).
 - Otherwise, CICSplex SM returns the requested information in the appropriate view.

No further security checking is required.

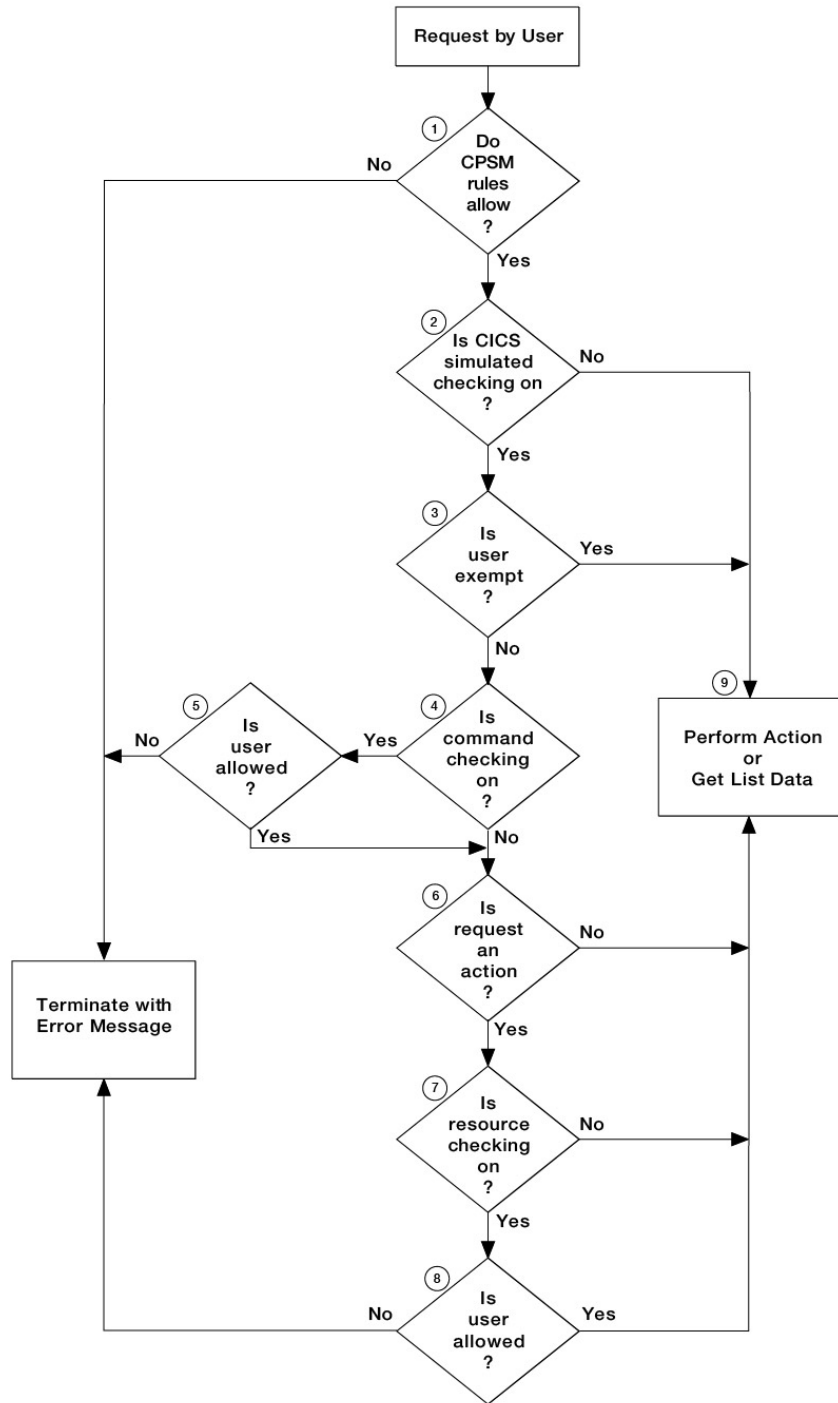

Figure 5. Flowchart of CICSplex SM security checking sequence - part 1

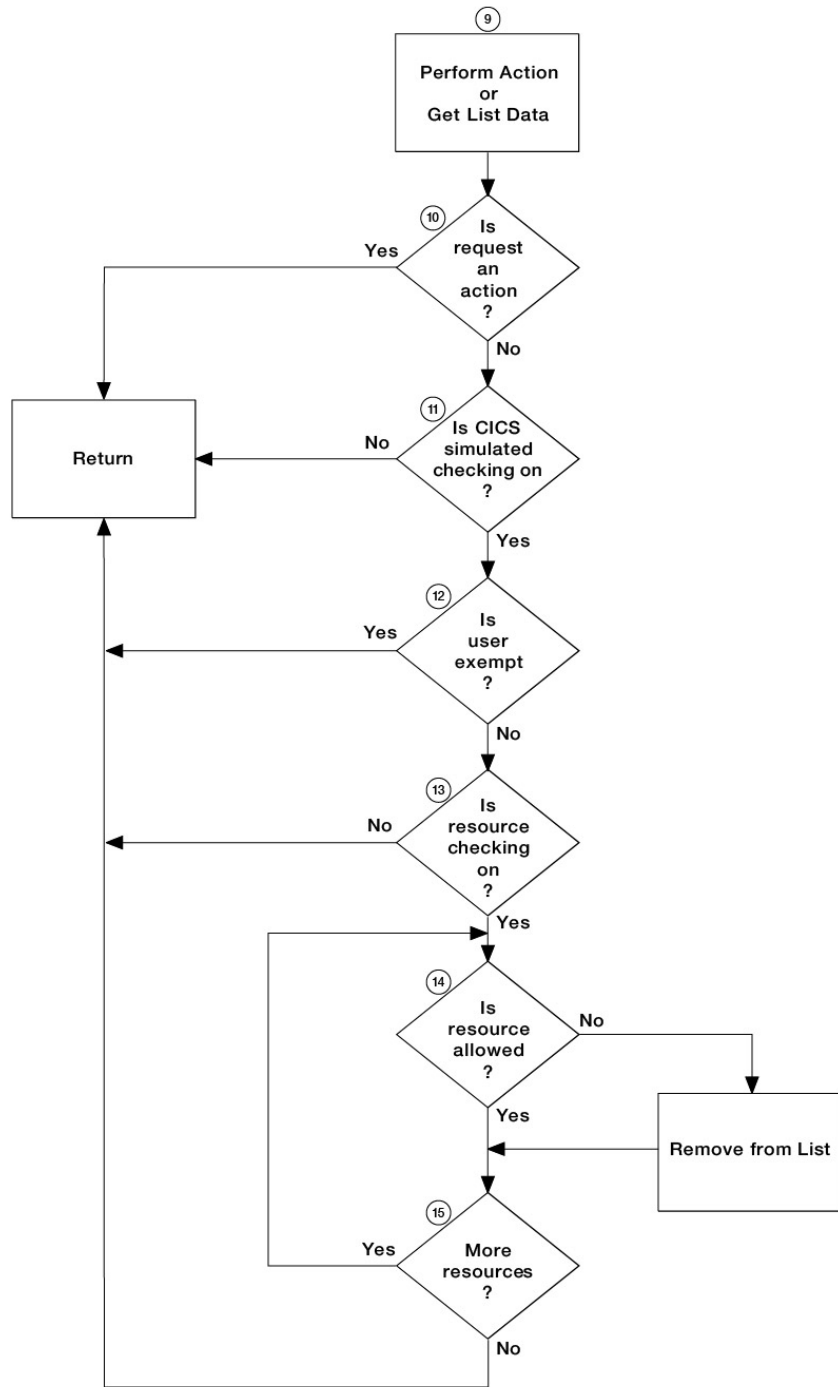

Figure 6. Flowchart of CICSPlex SM security checking sequence - part 2

Invoking a user-supplied external security manager

CICSplex SM provides an interface to an external security manager (ESM), which can be user-supplied or can be Resource Access Control Facility (RACF).

On the return from any user-supplied program, CICSplex SM must always receive control in primary-space translation mode, with the original contents of all access registers restored, and with all general-purpose registers restored (except for those which provide return codes or linkage information). For information about translation modes, see [z/Architecture Principles of Operation](#).

Note: This information is intended primarily for non-RACF users. For information about security processing using RACF, refer to [“Implementing CICSplex SM security” on page 165](#).

An overview of the CICSplex SM ESM interface

CICSplex SM security uses the RACROUTE macro to get the MVS system authorization facility (SAF) interface to route authorization requests to the ESM.

Usually, if RACF is present, the MVS router passes control to it. However, you can modify the action of the MVS router by invoking the router exit. The router exit can be used, for example, to pass control to a user-supplied or vendor-supplied ESM. If you want to use your own security manager, you must supply an MVS router exit routine.

The control points at which CICSplex SM issues a RACROUTE macro to route authorization requests are described in [“CICSplex SM security control points” on page 214](#).

Overview of the MVS router

The system authorization facility (SAF) provides your installation with centralized control over security processing by using a system service called the *MVS router*. The MVS router provides a common system interface for all products providing and requesting resource control.

The resource-managing components and subsystems (such as CICS) call the MVS router as part of certain decision-making functions in their processing, for example access control checking and authorization-related checking. These functions are called *control points*. This single SAF interface encourages the use of common control functions shared across products and across systems.

If RACF is available in the system, the MVS router might pass control to the RACF router, which in turn invokes the appropriate RACF function. The parameter information and the RACF router table, which associates router invocations with RACF functions, determine the appropriate function. However, before calling the RACF router, the MVS router calls an optional installation-supplied security-processing exit, if one has been installed. For more information, see [Passing control to a user-supplied ESM](#).

The system authorization facility and the SAF router are present on all MVS systems, even if RACF is not installed. Although the SAF router is not part of RACF, many system components and programs, such as CICS, invoke RACF through the RACROUTE macro and SAF. Therefore, installations can modify RACF parameter lists and do customized security processing within the SAF router. For information about how to code a SAF router exit, see [z/OS Security Server RACF Messages and Codes](#).

For more information about the MVS router, see [System authorization facility \(SAF\) in z/OS Security Server RACROUTE Macro Reference](#) and [ICHRTX00 - MVS Router Exit in z/OS MVS Installation Exits](#).

CICSplex SM security control points

All RACROUTE macros are issued from a CMAS. Macros required to support simulated CICS security checking are issued from the CMAS to which the target MAS is connected.

The following list summarizes the RACROUTE macros used by CICSplex SM to invoke the ESM, and the control points at which they are issued.

RACROUTE

The "front end" to the macros described, it invokes the MVS router. If RACF is not present on the system, RACROUTE can route to an alternative ESM, via the MVS router exit.

RACROUTE REQUEST=VERIFY

Issued at user signon (with the parameter ENVIR=CREATE), and at user sign-off (with parameter ENVIR=DELETE) to a CMAS. For ISPF end-user interface requests, signon calls are made during window creation in the CMAS that supports the named context. Sign-off calls are made when the window is closed. This macro creates or destroys an access control environment element (ACEE). It is issued at the following CICSplex SM CMAS control points:

- ISPF end-user interface user connection to a CMAS
- API CONNECT thread creation
- Single system image command routing
- ISPF end-user interface user disconnect from a CMAS
- API DISCONNECT thread termination

RACROUTE REQUEST=FASTAUTH

Issued during resource checking, on behalf of a user who is identified by an ACEE. It is the high-performance form of REQUEST=AUTH, using in-storage resource profiles, and is issued at the following CICSplex SM CMAS control points:

- Simulated CICS security checking
- View selection / API security

RACROUTE REQUEST=AUTH

This is a higher path length form of resource checking and is issued during PLEXMGR security checking. It may also be called to perform logging and auditing after a REQUEST=FASTAUTH.

RACROUTE REQUEST=LIST

Issued to create and delete the in-storage profile lists needed by REQUEST=FASTAUTH. (One REQUEST=LIST macro is required for each resource class.) It is issued at the following CICSplex SM CMAS control points:

- When CICSplex SM security is being initialized for a MAS
- When the CMAS or CMASD security action command (SEC) is issued.

For a detailed description of these macros, see [z/OS Security Server RACF Macros and Interfaces](#).

Example tasks: security

The following information provides examples of typical security setup tasks that you can use as a model for your own.

Here are some general points that apply to all of the RACF examples:

- Each RACF command shown in these task examples must be issued once against every RACF database in your CICSplex SM configuration. So, if there are two unconnected RACF databases, one on MVS1 and one on MVS2, each RACF command must be issued twice (once on each system).
- In all of the RACF command examples, strings in lowercase must be replaced by values suitable for your own enterprise. For example, you must replace the string `admin_user1` with the USERID of the administrator responsible for security of the relevant CICSplex SM resources.
- All of the RACF task examples use the enhanced generic naming facility (**) of RACF. If you do not use this convention at your enterprise, see the RACF documentation for information about creating equivalent profiles.
- Operations and administration RACF groups have been used in these examples: we recommend that you create such groups.

The first example describes creating some RACF profiles to protect all CICSplex SM functions and resources. The next step is to permit access selectively to particular users of particular resources.

Example: Protecting all CICSplex SM resources

To create the RACF profile to protect all CICSplex SM resources, do the following:

1. Ensure that the CPSMOBJ class is active and that generic profiles can be defined:

```
SETROPTS CLASSACT(CPSMOBJ) GENERIC(CPSMOBJ)
```

2. Create a RACF profile to protect all views and action commands for all CICSplex SM functions:

```
RDEF CPSMOBJ ** UACC(NONE) OWNER(admin_group) NOTIFY(admin_user)
```

This command defines a profile (**) that RACF treats as matching all CPSMOBJ resource entity names, and which therefore protects all CICSplex SM resources; it also specifies that `admin_user` is to be notified of any violations.

3. The next step is very similar to Step “2” on page 216: we define one RACF profile for each CICSplex in the configuration. Each profile will protect all CICSplex SM functions and resources for that CICSplex. The purpose of doing this is to give you more flexibility in granting access to CICSplex-specific resources. In this example, we have two CICSplexes, and so create two RACF profiles:

```
RDEF CPSMOBJ *.*.PLXPROD1.* UACC(NONE) OWNER(admin_group) +  
  NOTIFY(admin_user)  
RDEF CPSMOBJ *.*.PLXPROD2.* UACC(NONE) OWNER(admin_group) +  
  NOTIFY(admin_user)
```

Note that you cannot replace Step “2” on page 216 with multiple CICSplex-specific profiles: such profiles will not necessarily protect CICSplexes that you create later, nor can they protect CICSplex SM functions whose context is the CMAS rather than the CICSplex. For example, the CONFIG views would be unprotected if you did not also perform Step “2” on page 216.

4. In Step “3” on page 216 we protected all CICSplex SM functions and resources at the CICSplex level. In this step, we're going to define profiles to control access to the CICSplex SM CONFIG and TOPOLOGY definition functions, so that we can selectively permit any "special" users, such as administrators, the access they need. (Anyone who has update access to these two functions can alter the CICSplex configuration, and so access must be limited.)

```
RDEF CPSMOBJ CONFIG.DEF.** UACC(NONE) OWNER(admin_group)  
RDEF CPSMOBJ TOPOLOGY.DEF.** UACC(NONE) OWNER(admin_group)
```

Now that we've controlled access to CICSplex SM functions and resources, we can begin to grant access to particular users or groups of users.

Example: Giving CICSplex SM operators appropriate authorizations

CICSplex SM operators need access, at least, to all of the operations views. In this example, we'll show you how to give CICSplex SM operators update access to all operations views and read access to the monitoring views. This will allow operators to look at monitor data, but not to create or change monitor definitions.

1. Give CICSplex SM operators update access to the OPERATE views:

```
RDEF CPSMOBJ OPERATE.** OWNER(admin_group) UACC(NONE)  
PE OPERATE.** CLASS(CPSMOBJ) ID(ops_group) A(UPDATE)
```

2. Give CICSplex SM operators read access to the MONITOR views:

```
RDEF CPSMOBJ MONITOR.** UACC(NONE) OWNER(admin_group)  
PE MONITOR.** CLASS(CPSMOBJ) ID(ops_group) A(READ)
```

In both steps, you can see that we begin by creating a RACF profile to protect the resource, and then grant access to users in `group ops_group`.

Example: Giving a user read access to all transactions on MVS system A

In this example, we show you how to give user PAYUSR1 read access to all transactions running on CICS systems on MVS system A.

In the example, we have three CICS systems (say, CICSAA01, CICSAA02, and CICSAA03) which all belong to CICSplex PLXPROD1.

1. Define the appropriate RACF profile:

```
RDEF CPSMOBJ OPERATE.TRAN.PLXPROD1.CICSAA0* UACC(NONE) +  
OWNER(admin_group)
```

2. Give user PAYUSR1 read access to all transactions on MVS system A:

```
PE OPERATE.TRAN.PLXPROD1.CICSAA0* CLASS(CPSMOBJ) I(PAYUSR1) A(READ)
```

Chapter 6. Security for intercommunication

These topics tell you how to plan and implement security in an intersystem communication (ISC) environment using LU6.2 or LU6.1, in a multiregion operation (MRO) environment, and in an IP interconnectivity (IPIC) environment.

Overview of intercommunication security

This topic gives an overview of how security works when CICS systems are interconnected or connected to other compatible systems.

Introduction to intercommunication security

In a single CICS system, you use security to make sure that terminal users can access only those parts of the system they need to work with.

For interconnected systems, the same basic principles apply, but now you also include definitions for connections, sessions, and partners. You also need to allow for the fact that users of one CICS system can initiate transactions and access resources in another CICS system.

This topic assumes that you are already familiar with setting up security for a single CICS system.

In particular, you should understand the following concepts:

- User signon. See [“The sign-on process” on page 53](#).
- How the relationship between user security and transaction security determines which transactions a particular user is allowed to invoke. (See [“Verifying CICS users” on page 52](#) and [“Transaction security” on page 66](#).)
- How resource security determines which other resources a user is allowed to access. See [“Resource security” on page 70](#).

An interconnected group of CICS systems differs from a single CICS system in that you may have to define a user profile or group profile more than once. (See [“RACF user profiles” on page 11](#) and [“RACF group profiles” on page 16](#) for information on defining these profiles.) That is, you may have to define these profiles in each CICS system that is using a separate RACF database, and in which a user is likely to want to attach a transaction or access a resource. When planning these profiles, you must consider all cases in which a user could initiate function shipping, transaction routing, asynchronous processing, distributed program link, distributed transaction processing, or external call interface (EXCI). For descriptions of these methods of intercommunication, see [Distributed transaction processing overview](#).

Planning for intercommunication security

Intercommunication security in a CICS system is concerned with incoming requests for access to CICS resources, rather than with requests that are sent to other systems.

The security issue with incoming requests occurs when a particular user at a particular remote system is trying to access resources of your CICS system. Is this access authorized, or should it be rejected?

The following sections describe the points in the processing of an incoming request at which you can apply security checks.

Intercommunication bind-time security

The first requirement is for a session to be established between the two systems. This does not, of course, happen on every request; a session, once established, is usually long-lived. Also, the connection request that establishes the session can, depending on the circumstances, be issued either by the remote system or by your CICS system. However, the establishment of a session presents the first potential security exposure for your system.

Your security concern is to prevent unauthorized remote systems from being connected to your CICS system; that is, to ensure that the remote system is really the system that it claims to be. This level of security is called **bind-time security**. (For ISC over SNA connections, it is also known as **systems network architecture (SNA) session security**.) It can be applied when a request to establish a session is received from, or sent to, a remote system.

Note: We use the term **bind** to refer to all of the following:

- The **SNA BIND** command that is used to establish SNA sessions between systems
- The **CICS connection request** that is used to establish an IPIC connection between systems
- The CICS connection request that is used to establish MRO sessions for CICS interregion communication

You can specify bind-time security for APPC (LU6.2), IPIC, and multiregion operation (MRO) links, but **not** for LU6.1 links. For information on defining bind-time security in your system, see [“Bind-time security with LU6.2” on page 222](#), [“IPIC bind-time security” on page 259](#), or [“Bind-time security with MRO” on page 265](#), depending on the environment you are using.

Intercommunication link security

Each link between systems is given an authority defined by a userid.

It is important to note that users cannot access any transactions or resources over a link that is itself unauthorized to access them. This means that each user's authorization is a subset of the link's authority as a whole.

To limit the remote system's access to your transactions and resources, you use **link security**. Link security is concerned with the single user profile that you assign to the remote system as a whole. Like user security in a single-system environment, link security governs:

Transaction security

This controls the link's authority to attach specific transactions.

Resource security

This controls the link's authority to access specific resources. This applies for transactions, executing on any of the sessions from the remote system, that have RESSEC(YES) specified in their transaction definition.

Command security

This controls the link's authority for the commands that the attached transaction issues. This applies for transactions, executing on any of the sessions from the remote system, that have CMDSEC(YES) specified in their transaction definition.

Surrogate user security

This controls the link's authority to START transactions with a new userid, and to install resources with an associated userid.

For more information, see [“Transaction, resource, command, and surrogate user security for intercommunication” on page 221](#).

User security for intercommunication

In addition to the security profile that you set up for the link, you can further restrict each remote user's access to the transactions, commands, and resources in your system.

For ISC over SNA and MRO links, specify the ATTACHSEC parameter on the CONNECTION definition. For IPIC links, specify the USERAUTH parameter on the IPCONN resource definition.

User security, like link security, distinguishes between transaction, resource, command, and surrogate security. User security can never increase a user's authority above that of the link. For more information, see [“Transaction, resource, command, and surrogate user security for intercommunication” on page 221](#).

For information on defining user security in your system, see [“User security with LU6.2”](#) on page 227, [“IPIC user security”](#) on page 261, or [“User security with MRO”](#) on page 269, depending on the environment you are using.

You cannot specify user security for LU6.1 links. For LU6.1, the user security is taken to be the same as the link security.

Transaction, resource, command, and surrogate user security for intercommunication

The last step in defining security for your system is to make sure that the access parameters match the profiles you have defined for your transactions, resources, commands, and surrogate users for the link and the individual remote users.

For information on defining these levels of security in a single-system environment, see [Transaction security](#), [Security of resource definitions](#), and [CICS command security](#).

Resources and commands are unsecured unless you explicitly request security protection in your transaction definitions.

Summary of intercommunication security levels

Table 30 on page 221 shows bind-time, transaction, resource, and command security, and how CICS enforces these levels of security under the LU6.1, LU6.2, IPIC, and MRO protocols. It also shows how the two levels of authorization (user and link) are involved at the three security levels.

For guidance on choosing between these environments, see [Intercommunication methods](#).

Table 30 on page 221 shows a summary of intercommunication security.

Security level	Security checks	LU type 6.1	LU type 6.2	IPIC	MRO
Bind-time security (when BIND is received)	Should the BIND request be accepted?	No check	Session key from RACF	SSL Client Certificate from partner	DFHAPPL profiles in RACF FACILITY class
Bind-time security (when BIND is sent)	Is the remote system the correct one?	No check	Session key from RACF	SSL Client Certificate to partner	DFHAPPL profiles in RACF FACILITY class
Link security	Does the link have authority to attach the transaction?	Link authority is established just after the session is bound, by signon of the user ID specified in the SECURITYNAME attribute of the CONNECTION definition or the USERID attribute of the SESSIONS definition.		Link authority is established just after the connection is established, by signon of a user ID determined according to the IPCONN LINKAUTH attribute.	Link authority is established just after the session is bound, by signon of the user ID specified in the USERID attribute of the SESSIONS definition.
Transaction security	Does the remote user have authority to access this system?	No check	The authority of the remote user is established at signon time		

Table 30. Summary of intersystem and interregion security (continued)

Security level	Security checks	LU type 6.1	LU type 6.2	IPIC	MRO
Transaction security	Does the remote user have authority to attach the transaction?	Link authority	The authority of the remote user is established at this attach request (or possibly at an earlier attach request from the same user) by sign-on		
Resource, command, and surrogate security	Does the session have the authority to access other resources that the transaction uses?	Link authority is established just after the session is bound, by signon of the user ID specified in the SECURITYNAME attribute of the CONNECTION definition or the USERID attribute of the SESSIONS definition.	Link authority is established just after the connection is established, by signon of a user ID determined according to the IPCONN LINKAUTH attribute.	Link authority is established just after the session is bound, by signon of the user ID specified in the USERID attribute of the SESSIONS definition.	
Resource, command, and surrogate security	Does the remote user have authority to access other resources that the transaction uses?	Link authority	The authority of the remote user is established at this attach request (or possibly at an earlier attach request from the same user) by sign-on		

Note: Remember to define profiles for your resources and users to RACF, as described for single systems in [RACF facilities](#).

Implementing LU6.2 security

This topic tells you how to implement security for LU6.2.

Bind-time security with LU6.2

A security check can be applied when a request to establish an APPC session is received from, or sent to, a remote system; that is, when the session is bound. This is called bind-time security (or, in SNA terms, session security), and is part of the CICS implementation of the LU6.2 architecture.

Its purpose is to prevent an unauthorized system from binding a session to one of your CICS systems.

Bind-time security is optional in the LU6.2 architecture; you should not specify bind-time security if the remote system does not support it. SNA defines how session security is to be applied, and CICS TS conforms to this architecture. If you want to connect to another system, make sure the other system is also compatible with this architecture.

When you define an LU6.2 connection to a remote system, you assume that all inbound bind requests originate in that remote system, and that all outbound bind requests are routed to the same system. However, where there is a possibility that a transmission line might be switched or broken into, guard against unauthorized session binds by specifying session security at both ends of the connection.

For a bind request to succeed, both ends must hold the same session key, which is defined to RACF. When a session is bound, the action CICS takes depends on:

- How you specified the **SEC** and **XAPPC** system initialization parameters
- How you specified the BINDSECURITY attribute of the CONNECTION definition
- Whether you have defined an APPCLU security profile for the link.

If you have specified SEC=YES and XAPPC=YES in your SIT, and BINDSECURITY(YES) in your CSD connection definition, and BINDSECURITY(YES) is also specified for the partner system, a bind security validation will be attempted.

If you have BINDSECURITY(NO), then the SIT specification is immaterial.

Table 31 on page 223 summarizes what happens.

<i>Table 31. APPC bind-time security—relationship to resource definition</i>				
SEC value	XAPPC value	BINDSECURITY value	RACF APPCLU profile	Resulting CICS action
YES	YES	YES	Defined (See note 1)	CICS extracts the APPCLU profile from RACF at bind-time to verify the remote system.
YES	YES	YES	Not defined	CICS is unable to extract the APPCLU profile from RACF and therefore rejects the bind.
YES	YES	NO	Any value	CICS is unable to validate the bind, and rejects it.
YES	NO	Any value	Any value	CICS is unable to validate the bind, and rejects it.
NO	Any value	Any value	Any value	CICS is unable to validate the bind, and rejects it.

Note:

1. If the RACF APPCLU profile is defined, but the session segment is locked or expired, and no value is specified for SESSKEY, the bind request is always rejected.
2. The table shows the response when the partner has specified BINDSECURITY(YES).

Defining profiles in the APPCLU general resource class

If you use bind-time security with LU6.2, you must define profiles in the APPCLU general resource class: the APPCLU resource class is used to verify the identity of APPC partner logical units (LU type 6.2) during z/OS Communications Server session establishment.

To do this, take the following steps:

1. Ask your z/OS Communications Server system programmer for the following information for each session partner:
 - The network ID and the LU identifiers.
2. For each pair of session partners, create two profiles in the APPCLU general resource class.

On one system, enter the following RDEFINE command:

```
RDEFINE APPCLU netid1.luid1.luid2 UACC(NONE)
SESSION(SESSKEY(password))
```

On the other system, enter the following RDEFINE command:

```
RDEFINE APPCLU netid2.luid2.luid1 UACC(NONE)
SESSION(SESSKEY(password))
```

where:

netid1**netid2**

are the network IDs (NETID) of the partners. These IDs are specified on the z/OS Communications Server start option NETID, which is in the ATCSTRxx member of SYS1.VTAMLST.

luid1**luid2**

are the LU names of the partners. In each case, the first LU name specified is the local LU name and the second is the remote LU name.

session-key

is the 16-hexadecimal-digit or 8-character password that matches the session key of the remote system. Enclose hexadecimal digits in quotes; for example, SESSKEY (X '0123456789ABCDEF ').

You should specify the same session key in both systems: if the session keys do not match, the session cannot be established.

Although RACF does not require that you specify a session key, CICS will reject the bind if no session key is specified.

3. Define the attributes of the sessions between the partners of each LU pair. To do this, define a SESSION segment for each APPCLU profile using the SESSION option of the RDEFINE and RALTER commands. You can specify the following information in each SESSION segment:

CONVSEC

Specifies the levels of security checking performed for each conversation between the partners of the LU pair. CICS does not use this information; instead it uses the information specified in the ATTACHSEC operand of the CONNECTION resource. For more information see [CONNECTION resources](#).

INTERVAL

Specifies the maximum number of days the session key is valid before it must be changed.

You should be aware of the impact this may have on the users at the remote end of the link. If either password expires, the link cannot be established. Depending upon the auditing of the profile records, ICH415I messages may or may not be written out. See “[Specifying bind-time security for LU6.2](#)” on page 224. (CICS issues message DFHZC4942 to the CSNE destination when the password has expired.) Ensure that you are aware when a password interval is about to expire so that links do not fail for this reason. CICS does not display messages when the password is about to expire, but it does write records to the SMF log.

LOCK

Marks the profile as locked. If the profile is locked, the session does not bind, and CICS issues message DFHZC4941.

NOLOCK

Marks the profile as unlocked.

For more information about controlling LU6.2 binds, see the [z/OS Security Server RACF Security Administrator's Guide](#).

Specifying bind-time security for LU6.2

You define bind-time security in the CONNECTION resource definition, although you must also choose the appropriate system initialization parameters.

[Figure 7 on page 225](#) shows how to define APPC external session security, for which you need to specify the BINDSECURITY option.

```

CEDA DEFINE CONNECTION(name)
  GROUP(groupname)
  ACCESSMETHOD(VTAM)
  SECURITYNAME(name)
  PROTOCOL(APPC)
  NETNAME(name)
  BINDSECURITY(YES)

```

Figure 7. Bind-time security

For APPC terminals defined as a TERMINAL-TYPETERM pair, the BINDSECURITY operand is on the TERMINAL definition.

Note: VTAM is the z/OS Communications Server (for SNA or IP)

Auditing bind-time security

If security is active (SEC=YES is specified in the system initialization parameters), CICS performs bind security auditing.

The following conditions are considered bind failures, and cause RACF to write an SMF record, and to issue a message:

- Session key does not match partner's.
- Session segment is locked.
- Session segment has expired.
- Session key is null.
- Session segment does not exist.
- Session segment retrieval was unsuccessful.
- Session bind was unsuccessful.

The following conditions are considered bind successes, and cause RACF to write an SMF record, but **not** to issue a message:

- Session was successfully bound.
- Session key will expire in less than six days.

An SMF record is written if either of the following is true:

- The profile's audit option is set (AUDIT(ALL(READ))).
- SETROPTS LOGOPTIONS(ALWAYS(APPCLU)) is set.

Two things happen when an SMF audit record is written:

- Message ICH700051 is sent to the userid specified in the profile's notify option. It is suggested that you specify the TSO userid of a RACF administrator who is responsible for the APPCLU class.
- The security console (any MVS console with a routing code of 9) receives message ICH415I, which contains text similar to message ICH70005I.

These audit records can be extracted from SMF and listed using the following sample RACF Report Writer control statements:

```

//RACFRW EXEC PGM=IKJEFT01
//SORTWKxx DD your sort files
//SYSPRINT DD SYSOUT=*
//SYSTPRR DD SYSOUT=*
//RSMFIN DD DSN=your smf dumped data, DISP=SHR
//SYSTIN DD *

RACFRW TITLE('Bind Security Reports') GENSUM
SELECT PROCESS
EVENT APPCLU
LIST SORT(DATE,TIME)
END

```

The RACF Report Writer is described in the [z/OS Security Server RACF Auditor's Guide](#).

Changing RACF profiles that are in use—caution

Take care when changing RACF profiles for APPC connections that are in use.

CICS recognizes the change in the profile after a SETROPTS RACLIST(APPCLU) REFRESH command is issued. Bind-time security processing occurs when each session in a connection is acquired. Not all the sessions in a connection are acquired and the APPC profile becomes invalid, then an attempt to establish any of the unacquired sessions causes a bind security failure. This can cause transactions that attempt to allocate one of these unused sessions to be suspended indefinitely.

Reasons for invalid profiles

An APPC profile can become invalid for a number of reasons; for example:

- The session key expires
- The session key changes and a SETROPTS REFRESH takes place in one system without the corresponding change and refresh occurring in the other system
- The profile is locked while REFRESH takes place.

Sessions that are already acquired still continue to function normally if bind security fails in another session. If you are using expiring session keys, then the connection can still be used after the expiry date, if any of the sessions on the connection were acquired before the date of expiration, and have remained acquired. Hence, you see the effect of an expiring session key only when the connection (or session) is acquired.

No warning messages are produced stating that the session key is about to expire. However, an SMF record can be written when a key is used that will expire shortly. Therefore, you can use the RACF Report Writer regularly to find out which keys need maintenance. Otherwise, if expiring session keys are used, you must remember when the keys are due to expire. You must also take appropriate action to minimize any disruption that may occur because the connection is unavailable because of an expired session key. For example, you should plan for the changing of the session keys, for security rebuilds (for both CICS systems) and for the possibility of having to reacquire the connection.

You can avoid the problem of APPC profiles becoming invalid while the connection is in use by specifying AUTOCONNECT(YES) or AUTOCONNECT(ALL) on the SESSIONS definition. This causes all sessions to be established (acquired) when the connection is acquired.

Link security with LU6.2

Link security further restricts the resources a user can access, depending on the remote system from which they are accessed. The practical effect of link security is to prevent a remote user from attaching a transaction or accessing a resource for which the link userid has no authority.

When link security is in use, each session is given an authority defined by a *link user ID*. For LU6.2, all sessions in a connection can have the same link userid, or different groups of sessions within the connection can have different link user IDs. You can also specify that some groups of sessions should use link security, and that others should not.

You can never transaction route or function ship to CICS without having at least one security check, but the security checks are minimized if the link user ID matches the local region user ID:

- If the user IDs match, only one security check is made. This will either be against the default user (for ATTACHSEC=LOCAL) or against the user ID that is in the received FMH-5 attach request (ATTACHSEC=non-LOCAL).
- If the user IDs do not match, then for ATTACHSEC=LOCAL, resource checks are done only against the link user ID. For ATTACHSEC=non-LOCAL there are always two resource checks. One is against the link user ID, and the second is against the user ID received from the remote user in the attach request.

If a failure occurs in establishing link security, the link is given the security of the local region's default user. This would happen, for example, if the preset session user ID had been revoked.

User security with LU6.2

User security causes a second check to be made against a user signed onto a terminal, in addition to the link security described in [“Link security with LU6.2” on page 226](#). After reading the following descriptions, consider whether you want the extra level of security checking that user security provides.

You can specify the following levels of user security using the ATTACHSEC parameter of the CONNECTION definition:

- *LOCAL*, which you specify if you do **not** want to make a further check on users by requiring a user identifier or password to be sent. Choose LOCAL if you do not want user security because you consider that the authority of the link is sufficient for your system. See [“Specifying user security in link definitions” on page 228](#) for information on doing so.
- *Non-LOCAL*, which you specify if you *do* want to make a further check on users by requiring a user identifier, or a user identifier and a password, to be sent. Non-LOCAL includes the following types of checking:
 - IDENTIFY
A user identifier must be sent, but no password is requested
 - VERIFY
A password must also always be sent
 - PERSISTENT VERIFICATION
Password is sent on the first attach request for a user
 - MIXIDPE
Either identify or persistent verification

Note: [“Non-LOCAL user security verification” on page 227](#) further describes these types of user checking. See [“Specifying user security in link definitions” on page 228](#) for information on specifying them.

Non-LOCAL user security verification

In a CICS-to-CICS system connection, where you have a terminal-owning region (TOR), an application-owning region (AOR), and a data-owning region (DOR), the terminal operator signs on to the TOR, attaches a transaction in the AOR, and accesses resources in the DOR. If all three systems implement non-local user security, then the same operator is registered as a user in each of them.

The usual procedure is for the operator to sign on to the TOR with a password. CICS assumes that the password is valid for the entire systems complex, and that it does not need to be passed on to the AOR and the DOR for further verification. All that is needed is for the AOR and the DOR to IDENTIFY the user, who is then signed on without a password. Therefore, the password is not sent with the attach request to the AOR. This is considered to be more secure, because the password is not passed on a network.

Specify IDENTIFY when you know that CICS can trust the remote system to verify its users (by some sort of sign-on mechanism) before letting them use the link. Use IDENTIFY if you want user security for CICS-to-CICS communication: CICS does not support password flows on CICS-to-CICS connection.

If the front end does not have a security manager it may not be possible to VERIFY the user by means of a user identifier and password before the attach request reaches the AOR. The AOR must then receive both user identifier and password from the front end so that it can verify the user itself by a sign-on with password.

Specify VERIFY if you have reasons for wanting your own system to verify the remote system's users even if they have already been checked by the remote system itself, or if the remote system does not have a security manager and therefore cannot verify its own users.

If programmable workstations make repeated requests to attach transactions in the AOR, performance suffers because of many verifications. The LU6.2 architecture, which defines these security procedures, allows persistent verification to reduce the software overhead. Using this protocol, the first attach request contains a user identifier and a password, but once the user has signed on, only the user identifier is needed for all the attach requests that follow.

Specify PERSISTENT to reduce the verification overhead if remote users repeatedly send attach requests. However, the remote system must be able to cooperate in the management of persistent verification by keeping a list of users who are currently signed on.

Some remote APPC systems have mixed sign-on requirements that vary from conversation to conversation (for example, CPI communications conversations). In this case, CICS must accept incoming identity or persistent requests.

To decide which of these types of user verification to use, you need to know how far the remote system is capable of managing its own security and, if it cannot, to what extent it must depend on the CICS system you are defining.

- Do you need to know the user identifier? If not, use LOCAL.
- Can the remote system verify its own users? If so, use IDENTIFY. If not, can it send a user identifier and a password with the attach request? If so, use VERIFY.
- Does the remote system support persistent verification by keeping track of its user identifiers and passwords? If so, specify PERSISTENT, unless you are using CICS-to-CICS communications, in which case specify MIXIDPE.

You specify these levels of checking for each connection using the ATTACHSEC operand of the CONNECTION definition, as described in [“Specifying user security in link definitions” on page 228](#).

Specifying user security in link definitions

The level of user security you require for a remote system is specified in the ATTACHSEC operand in the CONNECTION definition, as shown in [Figure 8 on page 228](#).

This topic describes how CICS interprets the parameters of the ATTACHSEC operand of the CONNECTION definition. However, special rules apply for CICS transaction routing, as described in [“Transaction routing security with LU6.2” on page 233](#). [Figure 8 on page 228](#) shows an example of defining ATTACHSEC using CEDA.

```
CEDA DEFINE CONNECTION(name)
  GROUP(groupname)

  ATTACHSEC(LOCAL|IDENTIFY|VERIFY|PERSISTENT|MIXIDPE)
```

Figure 8. Defining sign-on level for user security

Note: For APPC terminals defined as a TERMINAL-TYPETERM pair, the ATTACHSEC operand is on the TERMINAL definition.

The ATTACHSEC operand specifies the sign-on requirements for incoming transaction attach requests. It has no effect on attach requests that are issued by your system to a remote system; these are dealt with in the remote system.

When an APPC session is bound, each side tells the other the level of attach security user verification that will be performed on its incoming requests. There is no negotiation on this.

Meanings of ATTACHSEC operand

The following are the possible operands of ATTACHSEC:

LOCAL

specifies that a user identifier is not to be supplied by the remote system. If one is received, the attach fails. CICS makes the user security profile equivalent to the link security profile. You do not need to specify RACF profiles for the remote users. LOCAL is the default value.

IDENTIFY

specifies that a user identifier is expected on every attach request. All remote users of a system must be identified to RACF.

If an attach request with both a user identifier and a password is received on a link with ATTACHSEC(IDENTIFY), CICS does not reject the attach request. CICS handles the attach request as if the connection was defined with ATTACHSEC(VERIFY).

If a null (X'00') user identifier or an unknown user identifier is received, CICS rejects the attach request.

VERIFY

specifies that, in addition to a user identifier, a user password is required for verification against the local RACF database. All remote users of a system must be identified to RACF.

The rules that apply to the checking of the user identifier for ATTACHSEC(IDENTIFY) also apply for ATTACHSEC(VERIFY). If a valid user identifier is received but the password verification fails, CICS rejects the attach request. If the communicating system is CICS for AIX, ATTACHSEC=IDENTIFY should be used.

Note: Products other than CICS can connect to a CICS Transaction Server for z/OS AOR via an LU6.2 link. They then use the SNA LU6.2 FMH-5 ATTACH mechanism to start a transaction on the CICS AOR. Where this mechanism is being used from an insecure system, the ATTACHSEC=VERIFY option should be used on the connection definition to protect the transaction on the AOR. (See [“SNA profiles and attach-time security”](#) on page 231).

PERSISTENT

specifies that a user identifier and a user password are required with the first attach request for a new user, but all following attach requests for the same user need supply only a user identifier. (All remote users of a system must be identified to RACF.) The first attach signs on the user, even if the attach request is later unsuccessful because the user is not authorized to attach the transaction.

Note: PERSISTENT cannot be used for CICS-to-CICS communication.

MIXIDPE

specifies that the sign-on level for the remote user is determined by parameters sent with the attach request. The possibilities are: PERSISTENT or IDENTIFY.

Remote user sign-on status with LU6.2

With the ATTACHSEC parameters, IDENTIFY, MIXIDPE, PERSISTENT, and VERIFY, the remote user remains signed on after the conversation associated with the first attach request is complete.

CICS then accepts attach requests from the same user without a new sign on until one of the following events occurs:

- The period specified in the [USRDELAY system initialization parameter](#) system initialization parameter elapses after completion of the last transaction associated with the attach request for this user.
- CICS is notified of certain changes in the RACF profile of a signed-on remote user, or a signed-on user who is not directly using a physical terminal or console, through a type 71 RACF Event Notification (ENF). For details, see [“Changing the RACF profile of a remote user”](#) on page 14.
- The CICS region shuts down.

If you alter the RACF profile of a signed-on remote user, for example by revoking the user, CICS continues to use the authorization established at the first attach request until one of the following situations occurs:

- The transaction performs a syncpoint.
- The attach request ends.

- Sign off occurs because RACF notifies CICS of changes to a user profile, and an attached request associated with that signed-on user ID completes, for all operands of ATTACHSEC except LOCAL.
- Sign off occurs because RACF notifies CICS of changes to a user profile, a new attach request is made, and the value in the **USRDELAY** system initialization parameter has not expired. This sign off is followed by a sign on.

Password checking

If you are using ATTACHSEC(PERSISTENT) (or ATTACHSEC(MIXIDPE) being treated as ATTACHSEC(PERSISTENT)), CICS maintains a table for each remote system called the **persistent verification (PV) signed-on-from list**.

This is a list of users whose passwords have been checked and who do not require a further password check as long as the entry remains in the list. Entries remain in the list until:

- The period specified in the system initialization parameter PVDELAY elapses after the user's sign-on entry was last used.

PVDELAY defines how long entries can remain in the PV signed-on-from list for the remote system, which means that their passwords do not need to be revalidated for each attach request. For information on specifying a value for PVDELAY, see [PVDELAY system initialization parameter](#) . See the [Improving the performance of a CICS system](#) for information on tuning.

- The connection with this system is terminated because: CICS is restarted, the connection is lost, or CICS receives an invalid attach request from the user.

When persistent verification is in operation for a remote user, and that user is removed from the PV signed-on-from list, CICS informs the remote system by issuing a sign-off request for the user to remove the entry from the PV signed-on-to list in the remote system.

If you specify ATTACHSEC(VERIFY), the remote user's password is checked for *every attach request*. This is to ensure that the user has authority to access this system, to verify that this password is correct, and to establish security authorities for the user.

Information about remote users

Information about the user can be transmitted with the attach request from the remote system.

This means that you can protect your resources not only on the basis of which remote system is making the request, but also on the basis of which user at the remote system is making the request.

This topic describes some of the concepts associated with remote-user security, and how CICS sends and receives user information.

You have to define your users to RACF. If a remote user is not defined to RACF , any attach requests from that remote user are rejected.

CICS remote-user security for LU6.2 links implements the LU6.2 architecture. The LU6.2 architecture allows user identifiers, user passwords, and user profiles to be transmitted with requests to attach a transaction.

User profiles can be transmitted instead of, or in addition to, user identifiers. The profile name, if supplied, is treated as the groupid.

If the user has been added to the front-end system with a group ID explicitly specified; for example in EXEC CICS SIGNON or by filling in the GROUPID parameter on the CESN panel, this will be propagated by CICS in outbound attach FMHs for LU6.2 links where ATTACHSEC(IDENTIFY) has been specified in the CONNECTION definition. If the group ID has been allowed to default at the time the user was originally added to the front-end system, the profile field will not be included in the outbound FMH5. If the group ID is passed to the back-end system, the group ID will be used as part of ADD_USER processing on the back-end. That is, the user ID must be defined as a member of the group passed in the ESM on the back-end for the ADD_USER to be successful.

It is advisable to use the PLTPIUSR system initialization parameter if there is a possibility that a task started by PLTPI processing will access remote resources. This avoids problems in the remote region

where the user ID is not in the same group as the user in the local region. This is because the PLTPI user in the local region is not added with an explicit groupid, and as a result the groupid is not propagated to the remote region.

CICS sends userids on ATTACHSEC(IDENTIFY) conversations. [Table 32 on page 231](#) shows how CICS decides which userid to send.

<i>Table 32. Attach-time user identifiers—LU6.2</i>	
Characteristics of the local task	User identifier sent by CICS to the remote system
Task with associated terminal—user identifier	Terminal user identifier
Task with associated terminal—no user signed on and no USERID specified in the terminal definition	Default user identifier for the local system
Task with no associated terminal or USERID started by interval control START command (if using function shipping or distributed transaction processing (DTP))	User identifier for the task that issued the START command
Task started with USERID option	User identifier specified on the START command
CICS internal system task	CICS region userid
Task with no associated terminal started by transient data trigger	User identifier specified on the transient data destination definition that defines the queue
Task with associated terminal started by transient data trigger	Terminal user identifier
Task started from PLTPI	PLTPIUSR

Signing on the remote user has two purposes:

- To ensure that the remote user is allowed to access the CICS system
- If the sign-on is successful, to establish the authority for the remote user

CICS signs off the remote user under the circumstances described in [“Remote user sign-on status with LU6.2” on page 229](#).

SNA profiles and attach-time security

Implementation of the LU6.2 attach-time security in CICSTS54.CICS conforms strictly to the architecture.

In particular, note the following:

- The introduction of SNA profile support and the conformance to SNA attach-time security processing might cause upgrade problems.
- Profile support means that badly coded profiles sent in an attach FMH-5 cause certain attach requests to be rejected.
- The checks to prevent problems in the access security subfields of an FMH-5 are:
 - Check for unrecognized subfield
 - Check for invalid length subfield
 - Check for multiple subfields of the same type
- The full 10-character userid and password are accepted. Any trailing blanks ((X'40')) are removed before being passed to the security manager, which either rejects the attach request, or converts the userid and password into 8-character form before proceeding.

- If an attach request does not contain security parameters in the FMH-5, it is rejected, unless USEDFTUSER(YES) has been specified on the CONNECTION resource definition. In that case, the security capabilities of the default user apply.
- Valid SNA profiles received are treated as the ESM groupid with which the userid in the FMH-5 will be associated after the userid in the FMH-5 is signed on.
- When an SNA profile is received and the connection had ATTACHSEC=PERSISTENT, it is validated to conform to the architecture. It is not used to further qualify users in the signed-on-from list. This also applies to persistent signed-on flows received on a connection that has ATTACHSEC=MIXIDPE specified.

Transaction, resource, and command security with LU6.2

As in a single-system environment, users must be authorized to:

- Attach a transaction (**transaction security**)
- Access all the resources that the transaction is programmed to use. These levels are called **resource security**, **surrogate user security**, and **command security**

Transaction security

As in a single-system environment, the security requirements of a transaction are specified when the transaction is defined, as described in [Transaction security](#).

In an LU6.2 environment, two basic security requirements must be met before a transaction can be initiated:

- The link must have sufficient authority to initiate the transaction.
- If anything other than ATTACHSEC(LOCAL) has been specified, user security is in force. The user who is making the request must therefore have sufficient authority to access the system and to initiate the transaction.

Note: Transaction security also applies to the mirror transactions. See [“Function shipping security with LU6.2”](#) on page 234.

CICS routing transaction, CRTE

You can use the CICS routing transaction, CRTE, with IPIC, LU6.2, or MRO links to run transactions that are on a connected remote system, instead of defining these transactions as remote in the local system.

CRTE is particularly useful for infrequently used transactions, or for transactions such as CEMT that are on all systems.

Ensure that the terminal through which CRTE is started is defined on the remote system or is defined as shippable in the local system. The terminal operator needs RACF authority if the remote system is protected.

Security checking in the AOR for transactions that run under CRTE does not depend on what is specified on ATTACHSEC (for MRO and LU6.2 links) or USERAUTH (for IPIC links), nor does it depend on the user ID signed on in the TOR. Instead, security checking depends on whether the user signs on when using CRTE:

- If the user does *not* sign on, the surrogate terminal created is associated with the AOR default user. When a transaction is run, the security checks are carried out against this default user. A check is also made against the link user ID to see whether the routing application itself has authority to access the resource.
- If the user *does* sign on, using the CESN transaction while running CRTE, the surrogate points to the user ID of the signed-on user. For transactions attempting to access resources, security checking is made against the user ID of the signed-on user in the surrogate and the link user ID.

Resource and command security

Resource and command security in an intercommunication environment are handled in much the same way as in a single-system environment.

Resource and command security checking are performed only if the installed TRANSACTION definition specifies that they are required; for example, on the CEDA DEFINE TRANSACTION command, as shown in Figure 9 on page 233.

```
CEDA DEFINE TRANSACTION
.
  RESSEC (YES)
  CMDSEC (YES)
.
```

Figure 9. Specifying resource and command security for transactions

If a TRANSACTION definition specifies resource security checking, using RESSEC(YES), both the link and the user must also have sufficient authority for the resources that the attached transaction accesses.

If a TRANSACTION definition specifies command security checking, using CMDSEC(YES), both the link and the user must also have sufficient authority for the system programming commands shown in [Table 11 on page 119](#) that the attached transaction issues.

For further guidance on specifying resource and command security, see [Security of resource definitions and CICS command security](#).

NOTAUTH exceptional condition

If a transaction tries to access a resource, but fails the resource security checks, the NOTAUTH condition occurs.

When the transaction is the CICS mirror transaction, the NOTAUTH condition is returned to the requesting transaction, where it can be handled in the usual way.

Transaction routing security with LU6.2

In transaction routing, the authority of a user to access a transaction can be tested in both the TOR and the AOR.

In the TOR, a test is made to ensure that the user has authority to access the transaction defined as remote, just as if it were a local transaction. This test determines whether the user is allowed to run the relay program.

The terminal through which the transaction is invoked must be defined on the remote system (or defined as "shippable" in the local system), and the terminal operator needs RACF authority if the remote system is protected. The way in which the terminal on the remote system is defined affects the way in which user security is applied:

- If the definition of the remote terminal does not specify the USERID parameter:
 - For links defined with ATTACHSEC(IDENTIFY), the transaction security and resource security of the user are established when the remote user is signed on. The userid under which the user is signed on, whether explicitly or implicitly (in the DFLTUSER system initialization parameter), has this security capability assigned in the remote system.
 - For links defined with ATTACHSEC(LOCAL), transaction security, command security, and resource security are limited by the authority of the link.

In both cases, tests against the link security are made as described in [“Link security with LU6.2” on page 226](#).

Note: During transaction routing, the 3-character operator identifier from the TOR is transferred to the surrogate terminal entry in the AOR. If the surrogate terminal was shipped in, this identifier is not used for security purposes, but it may be referred to in messages.

When transaction routing PSB requests, the following conditions must both be satisfied:

- ATTACHSEC on the connection definition must not be LOCAL (that is, it can be IDENTIFY, PERSISTENT, MIXIDPE, or VERIFY).
- PSBCHK=YES must be specified as a system initialization parameter in the remote system.

Preset-security terminals and transaction routing

A terminal has preset-security if a value is specified on the USERID parameter of the TERMINAL definition. When considering the security aspects of transaction routing from a preset-security terminal, you must remember that preset-security is an attribute of the terminal rather than of the user who initiated the transaction routing request.

During transaction routing, a surrogate terminal is created in the AOR to represent the terminal at which the transaction routing request was issued. Whether the surrogate terminal has preset security or not depends upon a number of factors:

- If a remote terminal definition exists in the AOR for the terminal at the TOR, and specifies the USERID parameter, the surrogate terminal is preset with this userid. If the USERID parameter is not specified in the remote terminal definition, the surrogate terminal does not have preset security.
- If a remote terminal definition does not exist in the AOR, the preset security characteristics of the surrogate terminal are determined from the terminal definition shipped from the TOR. If the shipped terminal definition has preset security, the surrogate also has preset security, unless the connection to the AOR is defined with ATTACHSEC=LOCAL, in which case any preset security information shipped to the AOR is ignored.

CICS routing transaction, CRTE

You can use the CICS routing transaction, CRTE, with IPIC, LU6.2, or MRO links to run transactions that are on a connected remote system, instead of defining these transactions as remote in the local system.

CRTE is particularly useful for infrequently used transactions, or for transactions such as CEMT that are on all systems.

Ensure that the terminal through which CRTE is started is defined on the remote system or is defined as shippable in the local system. The terminal operator needs RACF authority if the remote system is protected.

Security checking in the AOR for transactions that run under CRTE does not depend on what is specified on ATTACHSEC (for MRO and LU6.2 links) or USERAUTH (for IPIC links), nor does it depend on the user ID signed on in the TOR. Instead, security checking depends on whether the user signs on when using CRTE:

- If the user does *not* sign on, the surrogate terminal created is associated with the AOR default user. When a transaction is run, the security checks are carried out against this default user. A check is also made against the link user ID to see whether the routing application itself has authority to access the resource.
- If the user *does* sign on, using the CESN transaction while running CRTE, the surrogate points to the user ID of the signed-on user. For transactions attempting to access resources, security checking is made against the user ID of the signed-on user in the surrogate and the link user ID.

Function shipping security with LU6.2

When CICS receives a function-shipped request, the transaction that is invoked is the **mirror transaction**.

The CICS-supplied definitions of the mirror transactions all specify resource, but not command, security checking. This means that you are prevented from accessing the remote resources if either the link or your userid profile on the other system does not have the necessary authority.

If the CICS-supplied definitions of the mirror transactions are not what your security strategy needs, you can change them by copying the definitions in group DFHISC into your own group, changing them and then reinstalling them. For more information, see [“Category 2 transactions” on page 145](#).

If you include a remote resource in your resource definitions, you can arrange for security checking to be done locally, just as if the resource were a local one. Also, the system that owns the resource can be made to apply an independent check, if it is able to receive the user identifier. You can therefore choose to apply security restrictions on both sides, on either side, or not at all.

Note: Be aware that if you specify the SYSID option on a function-shipped request, security checking is done in the remote system but is **bypassed in the local system**. [Figure 10 on page 235](#) summarizes what happens.

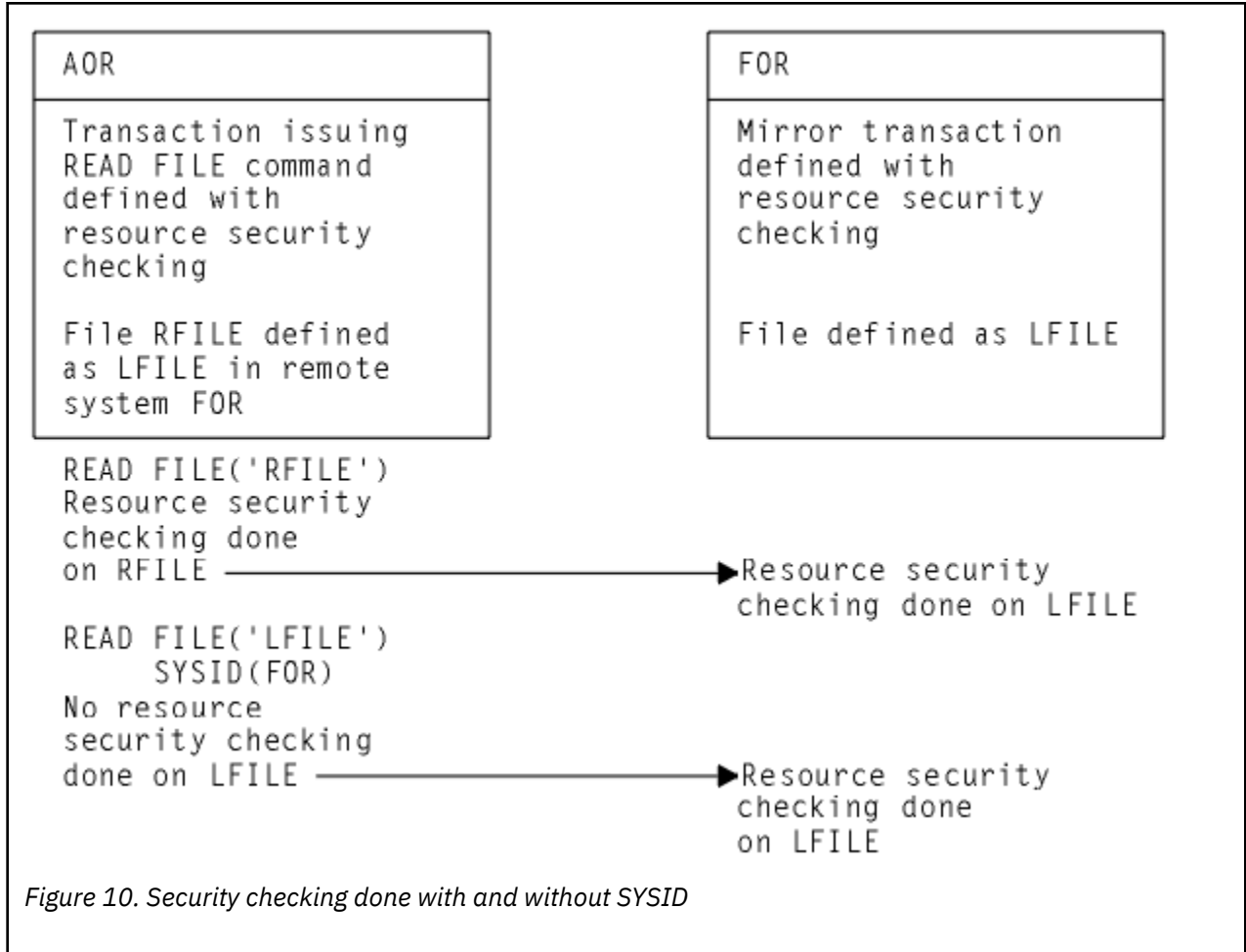

Distributed program link security with LU6.2

The CICS distributed program link (DPL) facility enables a CICS program (the client program) to call another CICS program (the server program) in a remote CICS region. DPL is used when the SYSID option on the LINK API command, or the REMOTESYSTEM option of the PROGRAM resource definition, specifies a remote CICS region.

When the SYSID option on the LINK command specifies a remote CICS system, the client region does not perform any resource security checking, but leaves the resource check to be performed in the server region.

The server program in the remote region is executed by a mirror transaction, in a similar way to other function-shipped CICS requests. However, the transaction name associated with the mirror depends on how the LINK command is invoked in the client region. You must be aware of the transaction name because normal attach security applies to the mirror transaction:

- If the TRANSID option is specified on the DPL command, the specified transaction name is used for the mirror.

- If the TRANSID option is omitted from the DPL command, but the TRANSID option is used in the program resource definition in the client region, the name for the mirror is taken from the program's TRANSID specification.

Otherwise, a default name for the mirror transaction is used, and this depends on the origin and LU6.2 sync level of the conversation:

- If synclevel 1 is being used, the default transaction name for the mirror is **CVMI**. This transaction name is used:
 - If the SYNCONRETURN option is specified on the DPL command in the client region
 - If the LU6.2 CONNECTION definition specifies SINGLESESS(YES)
 - If the connection is by means of an LU6.2 terminal; that is, a terminal whose resource definition uses a TYPETERM with a specification of DEVICE(APPC)
- If sync level 2 is being used, the default transaction name is **CSMI**. This transaction name is used when none of the other previous conditions is met.

Authorize your users to access the transaction name that the mirror runs under. The userids to be authorized depend on whether LOCAL or non-LOCAL attach security is being used, and are described in “[Security checking done in AOR with LU6.2](#)” on page 236. If the mirror transaction is defined with RESSEC(YES) in the server region, these userids must also be authorized to access the server program that is being linked to by the mirror. If the server program accesses any CICS resources, the same userids must be authorized to access them. If the server program invokes any system programming commands, and the mirror transaction is defined with CMDSEC(YES) in the server region, the same userids must be authorized to access the commands.

If the mirror transaction cannot be attached because of security reasons, the NOTAUTH condition is not raised, but the TERMERR condition is returned to the issuing application in the client region. If the mirror transaction is successfully attached, but it is not authorized to link to the distributed program in the server region, the NOTAUTH condition is raised. The NOTAUTH condition is also raised if the server program fails to access any CICS resources for security reasons.

The server program is restricted to a DPL-subset of the CICS API commands when running in a server region. The commands that are not supported include some that return security-related information. For programming information about which commands are restricted, see [CICS command summary](#). For further information about DPL, refer to [CICS distributed program link](#).

Security checking done in AOR with LU6.2

Security checking is different depending on how SECURITYNAME is specified in the AOR and TOR.

The link userid referred to in [Table 33 on page 237](#) and [Table 34 on page 237](#) is the one specified in the SECURITYNAME on the CONNECTION resource definition, or the USERID on the SESSION resource definition.

If a USERID is specified on the SESSIONS definition, and a link check is done, the userid used is the one on the SESSIONS definition.

If no userid is specified in SECURITYNAME, then the default userid of the AOR is used instead. However, if the SECURITYNAME userid is the same as the region userid for the AOR, then the link is deemed to have the same security as the AOR, and **link security is omitted altogether**. The effect of omitted link security depends on whether LOCAL or non-LOCAL attach security is specified for the link:

- For LOCAL attach security, the security specified in the USERID on the SESSIONS definition is used. If this too is omitted, then the default userid for the AOR is used.
- For non-LOCAL attach security, the security specified in the USERID on the sessions definition is **not** used. Only the userid received from the TOR is used to determine security.

Note: Neither the region userid for the TOR, nor the SECURITYNAME in the TOR's CONNECTION definition for the AOR, is relevant to security checking in the AOR.

[Table 33 on page 237](#) shows how checking is done when ATTACHSEC(LOCAL) is specified.

Table 33. LU6.2 and ATTACHSEC(LOCAL)

Region userid for AOR	SECURITYNAME in connection definition	USERID in SESSION definition	Checking in AOR
USERIDA	Not specified	Not specified	Check against AOR DFLTUSER
USERIDA	Not specified	USERIDA	Check against AOR DFLTUSER
USERIDA	Not specified	USERIDB	Check against USERIDB
USERIDA	USERIDA	Not specified	Check against AOR DFLTUSER
USERIDA	USERIDB	Not specified	Check against USERIDB
USERIDA	USERIDA	USERIDA	Check against AOR DFLTUSER
USERIDA	USERIDA	USERIDB	Check against USERIDB
USERIDA	USERIDB	USERIDA	Check against DFLTUSER
USERIDA	USERIDB	USERIDB	Check against USERIDB
USERIDA	USERIDB	USERIDC	Check against USERIDC

Table 34 on page 237 shows how checking is done when the ATTACHSEC parameter IDENTIFY (or PERSISTENT, or MIXIDPE) has been specified.

Table 34. LU6.2 and ATTACHSEC(IDENTIFY), ATTACHSEC(PERSISTENT), and ATTACHSEC(MIXIDPE)

Region userid for AOR	SECURITYNAME in connection definition	USERID in SESSION definition	Checking in AOR
USERIDA	Not specified	Not specified	Transmitted userid and AOR DFLTUSER
USERIDA	Not specified	USERIDA	Transmitted userid only
USERIDA	Not specified	USERIDB	Transmitted userid and USERIDB
USERIDA	USERIDA	Not specified	Transmitted userid only
USERIDA	USERIDA	USERIDA	Transmitted userid only
USERIDA	USERIDA	USERIDB	Transmitted userid and USERIDB
USERIDA	USERIDB	Not specified	Transmitted userid and USERIDB
USERIDA	USERIDB	USERIDC	Transmitted userid and USERIDC

Implementing LU6.1 security

This topic tells you how to implement link security for LU6.1.

For LU6.1 links, CICS cannot check the identity of the requesting system, and the bind request is never rejected on security grounds. You are advised to use the intersystem security offered by LU6.2 links whenever possible. Note that no bind-time or user security can be applied to LU6.1 links.

Link security with LU6.1

Link security restricts the resources that a user can access, depending on the remote system from which they are accessed.

The practical effect of link security is to prevent a remote user from attaching a transaction or accessing a resource for which the link userid has no authority.

Each link between systems is given an access authority defined by a link userid. A link userid for LU6.1 is a userid defined on your sessions definition for this connection. If not defined there, the link userid is taken to be the SECURITYNAME userid specified on the connection definition. If there is no SECURITYNAME, the link userid is the local region's default userid.

You cannot function ship to CICS without having a security check. However, the security check is minimized if the link userid matches the local region's userid:

- If the userids match, the resource check is made against the local region's default user.
- If the userids do not match, the resource check is carried out against the link userid.

If a failure occurs in establishing link security, the link is given the security of the local region's default user. This would happen if, for example, the preset session userid had been revoked.

Specifying link security for LU6.1 connections

About this task

You specify link security on the CONNECTION or SESSIONS resource definitions. If you require more information about either of these resources, see [CONNECTION resources](#) and [SESSIONS resources](#).

Procedure

- To specify that all sessions of a connection should have the same link userid, specify the SECURITYNAME attribute of the CONNECTION resource definition. If you do not specify a value for this attribute, CICS uses the default user ID.
- To specify different link userids for individual groups of sessions within a connection, specify the USERID attribute of the SESSIONS resource definition. For each group of sessions, the value specified overrides the SECURITYNAME attribute of the CONNECTION definition.

Specifying ATTACHSEC with LU6.1

With LU6.1 links, information about the remote user is not available for security purposes. In this case, the authority of the user is taken to be that of the link itself, and you must rely on link security alone to protect your resources.

With LU6.1, you can specify only ATTACHSEC(LOCAL) in the CONNECTION resource definition. [Figure 11](#) on page 238 shows an example of doing this using CEDA.

```
CEDA DEFINE CONNECTION(name)
  GROUP(groupname)
  .
  ATTACHSEC(LOCAL)
```

Figure 11. Defining sign-on level for user security with LU6.1

LOCAL is the default value. It specifies that a user identifier is not required from the remote system, and, if one is received, it is ignored. Here, CICS makes the user security profile equivalent to the link security profile. You do not need to specify RACF profiles for the remote users.

Transaction, resource, and command security with LU6.1

As in a single-system environment, links must be authorized to:

- Attach a transaction
- Access all the resources that the transaction is programmed to use.

This results in security levels called **transaction security**, **resource security**, and **command security**.

Transaction security

As in a single-system environment, the security requirements of a transaction are specified when the transaction is defined, as described in [Transaction security](#).

In an LU6.1 environment, a transaction can be initiated only if the link has sufficient authority.

Resource and command security

Resource and command security in an intercommunication environment are handled in much the same way as in a single-system environment.

CICS performs resource and command security checking only if the installed TRANSACTION definition specifies that they are required; for example, on the CEDA DEFINE TRANSACTION command, as shown in Figure 12 on page 239.

```
CEDA DEFINE TRANSACTION
.
  RESSEC(YES)
  CMDSEC(YES)
.
```

Figure 12. Specifying resource and command security for transactions

If a transaction definition specifies resource security checking, using RESSEC(YES), the link must have sufficient authority for the resources that the attached transaction accesses.

If a transaction definition specifies command security checking, using CMDSEC(YES), the link must have sufficient authority for the commands (COLLECT, DISCARD, INQUIRE, PERFORM, and SET) that the attached transaction issues.

For further guidance on specifying resource and command security, see [Security of resource definitions](#) and [Security of resource definitions](#).

NOTAUTH exceptional condition

If a transaction tries to access a resource, but fails the resource security checks, the NOTAUTH condition is raised.

When the transaction is the CICS mirror transaction, the NOTAUTH condition is returned to the requesting transaction, where it can be handled in the usual way.

Function shipping security with LU6.1

When CICS receives a function-shipped request, the transaction that is invoked is the **mirror transaction**.

The CICS-supplied definitions of the mirror transactions all specify resource security checking, but not command security checking. This means that you are prevented from accessing the remote resources if the link does not have the necessary authority.

Note that **transaction routing** across LU6.1 links is not supported.

If the CICS-supplied definitions of the mirror transactions are not what your security strategy needs, you can change them by copying the definitions in group DFHISC into your own group, changing them, and then reinstalling them. For more information, see [“Category 2 transactions”](#) on page 145.

If you include a remote resource in your resource definitions, you can arrange for security checking to be done locally, just as if the resource were a local one. Also, the system that owns the resource can be made to apply an independent check, if it is able to receive the user identifier. You can therefore choose to apply security restrictions on both sides, on either side, or not at all.

Note: Be aware that if you specify the SYSID option on a function-shipped request, security checking is done in the remote system but is **bypassed in the local system**. [Figure 13 on page 240](#) summarizes what happens.

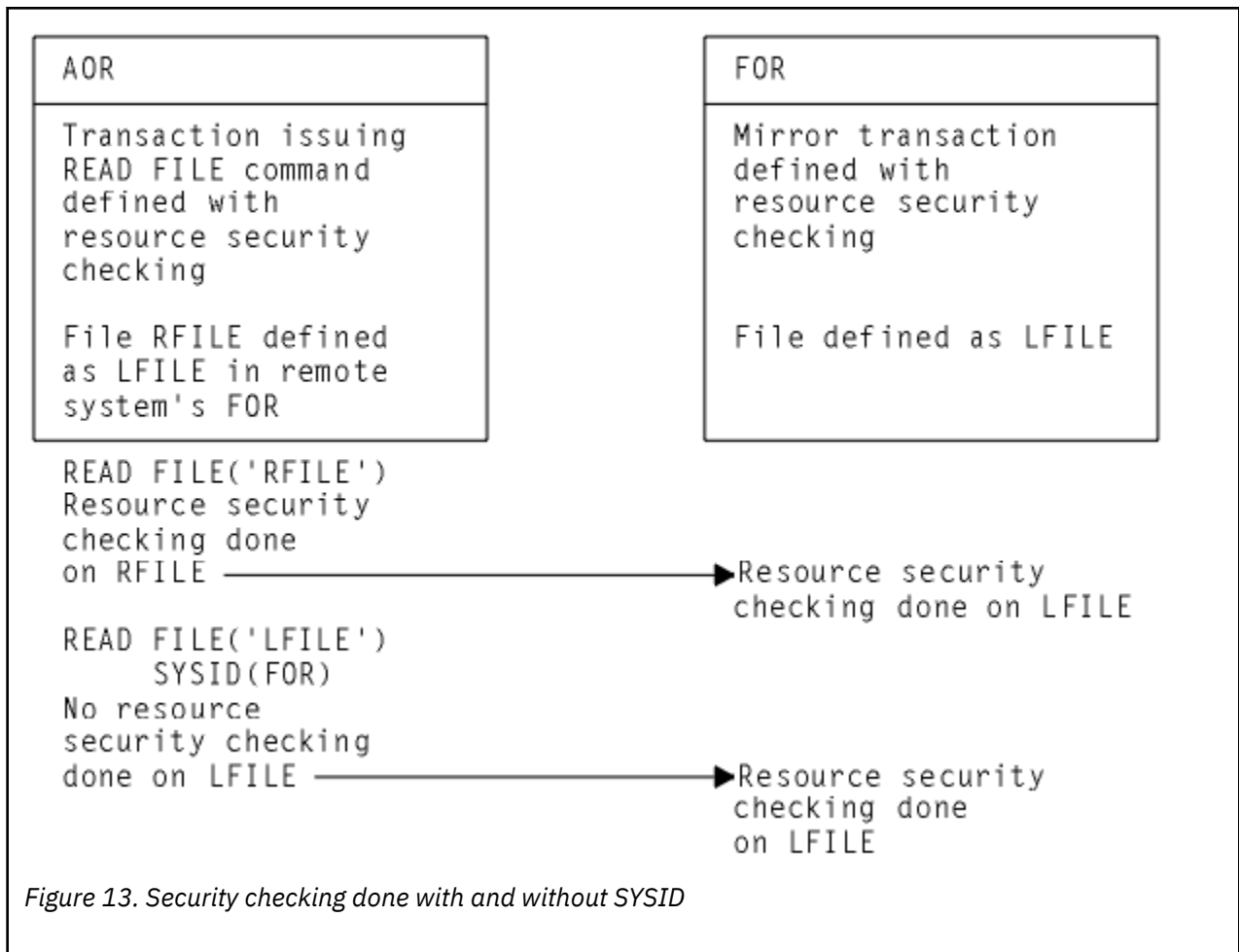

Security checking done in AOR with LU6.1

This section summarizes how security checking is done in the AOR according to how SECURITYNAME is specified in the AOR and TOR, in an LU6.1 environment.

The link userid referred to in [Table 35 on page 241](#) is the one specified in the SECURITYNAME on the CONNECTION definition, or the USERID on the SESSIONS definition.

If a USERID is specified on the SESSIONS definition, and a link check is done, the userid used is the one on the SESSIONS definition.

[Table 35 on page 241](#) shows how checking is done when ATTACHSEC(LOCAL) is specified.

Neither the region userid for the TOR, nor the SECURITYNAME in the TOR's CONNECTION definition for the AOR, is relevant to security checking in the AOR.

Table 35. Security checking done in AOR

Region userid for AOR	SECURITYNAME in CONNECTION definition	USERID in SESSION definition	Checking in AOR
USERIDA	Not specified	Not specified	Check against AOR DFLTUSER
USERIDA	Not specified	USERIDA	Check against AOR DFLTUSER
USERIDA	Not specified	USERIDB	Check against USERIDB
USERIDA	USERIDA	Not specified	Check against AOR DFLTUSER
USERIDA	USERIDB	Not specified	Check against USERIDB
USERIDA	USERIDA	USERIDA	Check against AOR DFLTUSER
USERIDA	USERIDA	USERIDB	Check against USERIDB
USERIDA	USERIDB	USERIDA	Check against AOR DFLTUSER
USERIDA	USERIDB	USERIDB	Check against USERIDB
USERIDA	USERIDB	USERIDC	Check against USERIDC

APPC password expiration management

This topic contains information on advanced program-to-program communications (APPC) password expiration management (PEM).

Introduction to APPC password expiration management

APPC password expiration management (PEM) with CICS provides receive support for an APPC architected sign-on transaction.

You might find it useful to copy and modify an example program. For your guidance, a sample program is shipped in library CICSTS54.CICS.SDFHSAMP. The program is DFH\$SNPW, the PEM sample program for Windows NT.

For examples of PEM requester and CICS PEM server user data produced by a program, see [“Examples of PEM client and CICS PEM server user data”](#) on page 255.

Note: In the information about APPC PEM, *sign-on* is used in the sense defined in the APPC architecture, which is different from the meaning used elsewhere in this information.

What APPC PEM does

APPC PEM with CICS provides receive support for an APPC architected sign-on transaction that verifies user ID, password pairs, and processes requests for a password change by:

- Identifying a user and authenticating that user's identification
- Notifying specific users during the authentication process that their passwords have expired
- Letting users change their passwords when (or before) the passwords expire
- Telling users how long their current passwords will remain valid
- Providing information about unauthorized attempts to access the system using a particular user identifier

Benefits of APPC PEM

APPC PEM has the following benefits:

- It enables users to update passwords on APPC links.

This can be particularly useful in the case of expired passwords. On APPC links that do **not** support APPC PEM, when users' passwords expire on remote systems, they are unable to update them from their own systems. The only alternative on a non-APPC PEM system is to log on directly to the remote system using a non-APPC link, such as an LU2 3270-emulation session, to update the password.

- It provides APPC users with additional information regarding their sign-on status; for example, the date and time at which they last signed on.
- It informs users whether their userid is revoked, or the password has expired, when they provide the correct password or PasTicket.

What you require to use APPC PEM

To use APPC PEM, you need:

A PEM client

The PEM client can be any APPC logical unit (LU) or node that is capable of initiating a conversation with the architected sign-on transaction. However, the benefits of using APPC PEM are increased when using an LU or node that does not have its own ESM; for example, a programmable workstation. APPC PEM enables users of such LUs or nodes to manage their password values within the ESM used by CICS. The PEM client is linked to a *PEM server*.

A PEM server

The PEM server can be any APPC LU that supports APPC PEM. This information describes the PEM server provided by CICS Transaction Server for z/OS, Version 5 Release 4. It is referred to in the rest of this book as the CICS PEM server.

An external security manager

An external security manager, such as RACF, or an equivalent ESM, must be available to the PEM server.

The PEM client (requester) and the PEM server are linked by an APPC session. This configuration is shown in [Figure 14 on page 242](#).

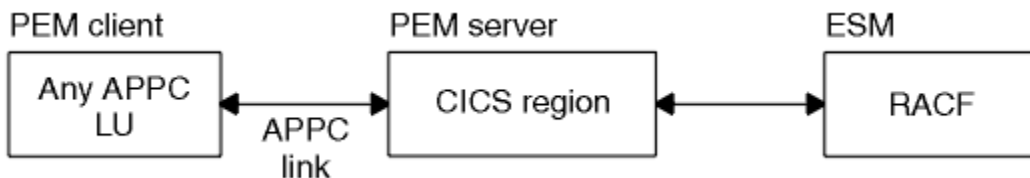

Figure 14. APPC PEM configuration

External security interface

Password expiration management has been enhanced to include the External Security Interface (ESI).

The ESI is not part of CICS Transaction server for z/OS, but it allows a non-CICS application to invoke services provided by advanced APPC PEM. ESI provides additional functions which make it easier for a non-CICS application to change and verify a password.

The 2 functions provided by ESI are:

- **CICS_VerifyPassWord** which allows a client application to verify that a password matches the password recorded by RACF, or an equivalent external security manager, for a specified user ID.
- **CICS_ChangePassWord** which allows a client application to change the password recorded by RACF for a specified user ID.

These functions allow a non-CICS application program to act as a PEM requestor without the application programmer having to manage an APPC conversation which implies knowledge of the formats for PEM requests and replies, and of the interface to the local SNA server.

For more information about the ESI password management functions, see the *Client/Server Application Programming* manual.

Roles of PEM client and CICS PEM server

CICS Transaction Server for z/OS, Version 5 Release 4 does not send passwords on APPC conversations. This means that it can **attach**, but not **initiate** the sign-on transaction, and must always act as the PEM server. Therefore, in your configuration always include an LU that is capable of initiating the sign-on transaction to act as the PEM client.

The PEM client collects sign-on information and sends it to the CICS PEM server via a sign-on transaction program, which is an SNA service transaction program.

Note that PEM signon is not to be confused with a CICS signon. In CICS, PEM signon allows the APPC LU to verify and manage user IDs and passwords. Following verification or updating, the user ID or password is intended to be included in the ASIS part of the FMH5 attach header. When this FMH5 is sent into CICS through the APPC link, provided ATTACHSEC is non-local, the user ID will be signed on to CICS. Therefore, a PEM signon does not result in the ESM last—connect, last-access information being updated.

The CICS PEM server then processes the sign-on request, updates the user's password (if necessary), and returns a reply to the PEM client containing responses and other data, such as a password expiry and information about unauthorized attempts to sign on. The PEM client then processes the data, as appropriate.

Note: When you successfully verify your password with CICS Transaction Server for z/OS, Version 2 Release 1, you are not signed on in the target CICS system.

If your CICS connection specifies persistent verification, a successful password verification will cause you to be added to the LUIT table. If no other attaches are received, you will receive a CLS3 transaction flow after the PVDELAY interval.

An example of signing on with APPC PEM

This example shows the sequence of events when a user signs on to a PEM client with an expired password.

The sequence is illustrated in [Figure 15 on page 244](#).

1. The user attempts to sign on to the PEM client, and supplies a password.
2. The PEM client sends the user ID and password to the CICS PEM server.
3. The CICS PEM server passes the user ID and password to the external security manager.
4. The external security manager checks the password.
5. Because the password has expired, the sign on attempt fails. The external security manager informs the CICS PEM server, which, in turn, informs the PEM client.
6. The PEM client informs the user that the password has expired, and requests a new one.
7. The user enters a new password.
8. The PEM client sends the user ID, the old password, and the new password to the CICS PEM server.
9. The CICS PEM server passes the user ID, the old password, and the new password to the external security manager.
10. The external security manager checks the old and new password. Because a new password is provided, the sign on attempt is successful. The external security manager informs the CICS PEM server, which, in turn, informs the PEM client.
11. The PEM client informs the user that the sign on request has been successful.

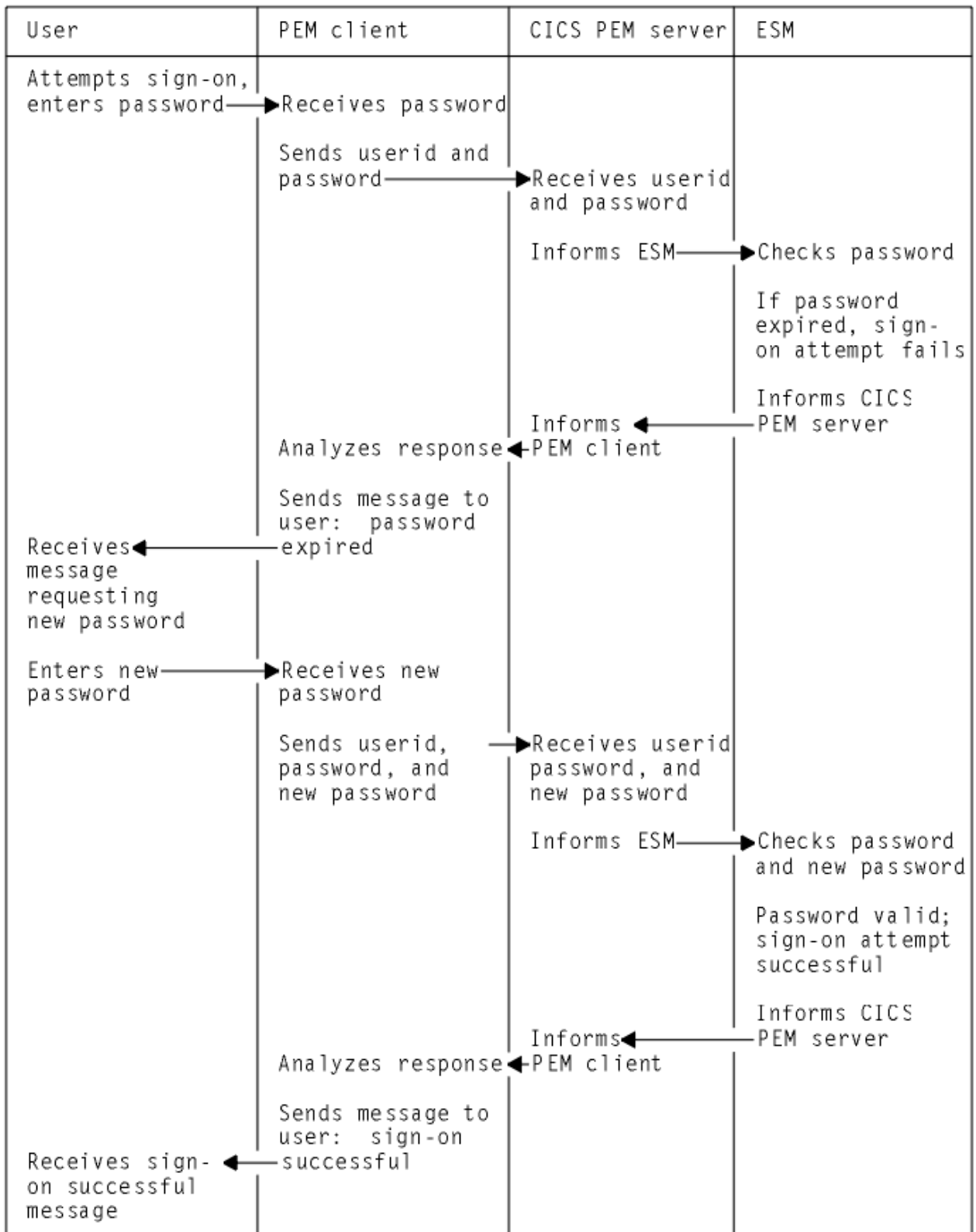

Figure 15. Example of signing on with APPC PEM

Overview of APPC PEM processing

CICS provides the PEM server, the receive side of APPC PEM as a CICS transaction that is started when an ATTACH for the sign-on transaction program is received from the PEM client.

CICS retrieves the sign-on data associated with the request, calls the ESM to perform a sign-on, and retrieves sign-on details for the userid. If the sign-on data includes a new password value, CICS includes this value when it calls the ESM to request a sign-on.

If PV is being used, and sign-on completes correctly, the user is added to the PV "signed-on-*from* list" in CICS, and the PV "signed-on-*to* list" in the PEM client. The "signed-on-"lists keep track of verified user IDs.

The CICS PEM server builds a reply and returns it to the PEM client, after which the CICS PEM server transaction terminates normally.

PEM client processing

The PEM client sign-on transaction program:

1. Obtains sign-on information, for example by:
 - Displaying a message to the user requesting sign-on information; that is, userid, password, and, if required, new password; or
 - Accessing sign on information from a user who has already been authenticated locally.
2. Sends the sign-on information to the CICS PEM server via an APPC conversation.
3. Receives replies from the CICS PEM server on the same APPC conversation.
4. If PV is being used (either ATTACHSEC=PERSISTENT or ATTACHSEC=MIXIDPE is specified on the CONNECTION definition), and sign-on is successful, adds the user's name to the PV signed-on-to list.
5. Processes the reply information from the CICS PEM server; for example, by:
 - Displaying the information to the user
 - Processing the data and saving it in a file to which only the user has access.

CICS PEM server processing

The CICS PEM server performs the following processing:

1. Accepts the userid and password, with optional new password, from the sign-on PEM client.
2. Tries to validate the user with its ESM.

If the userid and password are valid and the password has not expired, the CICS PEM server extracts the following information from its ESM:

 - Date and time of the last successful sign-on
 - Data and time the password will expire (calculated by data extracted from the ESM by the CICS PEM server itself)
 - Number of unsuccessful sign-on attempts since the last successful sign-on.
3. Returns a response to the PEM client, indicating whether the sign-on was succeeded or failed, and the reason for any failure:

```
Status           = (X'00') OK
Date-Time         = Current date and time
Last-Date-Time   = Date and time of previous successful sign-on
Expiry-Date-Time = Date and time password will expire
Revoke-Count     = Number of unsuccessful sign-on attempts made with
                  this userid since the previous successful sign-on
```

For detailed information about the response, see [“PEM client input and output data” on page 251](#).

Note: The ESM increments the revoke count whenever it processes an invalid sign-on attempt. The sign-on request may originate from a non-CICS system (for example, a TSO user).

If sign-on is unsuccessful, CICS returns to the PEM client a sign-on completion status value and, if appropriate, a formatting error value. See “[PEM client input and output data](#)” on page 251 for more information.

- If PV is being used (either ATTACHSEC=PERSISTENT or ATTACHSEC=MIXIDPE is specified on the CONNECTION definition), and sign-on is successful, adds the user's name to the PV signed-on-from list.

Expected flows between PEM client and CICS PEM server

Figure 16 on page 246 through Figure 19 on page 249 show expected flows for successful and unsuccessful sign-on attempts with and without PV.

Note: CICS support for the PEM client sign-on transaction assumes that the request for sign-on (or sign-on and change password) is for a single user. Batching of sign-on requests for different userids within a single sign-on transaction is not supported. If multiple sign on requests are passed in the input data, the CICS PEM server processes only the first one.

Successful sign-on—non-PV connection

Figure 16 on page 246 shows the expected flows between the PEM client and CICS PEM server during a successful sign-on when PV is not being used.

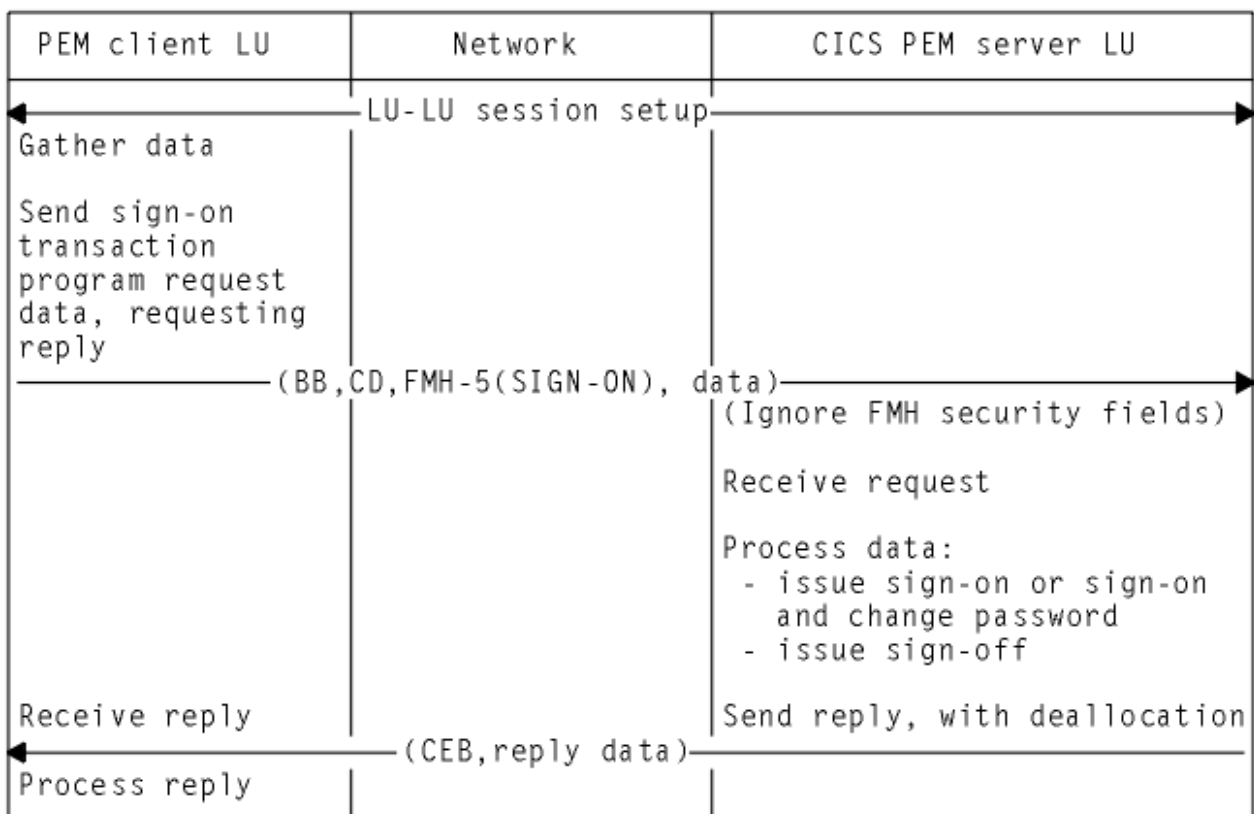

Figure 16. Expected flows for a successful sign-on with a non-PV connection

Note: All security fields in the FMH-5 (userid, password and UP, AV, PV1 and PV2 bits) are ignored by the CICS PEM server when it attaches the sign-on transaction.

Unsuccessful sign-on—non-PV connection

Figure 17 on page 247 shows the expected flows for an unsuccessful sign-on between a PEM client and CICS PEM server when PV is not being used.

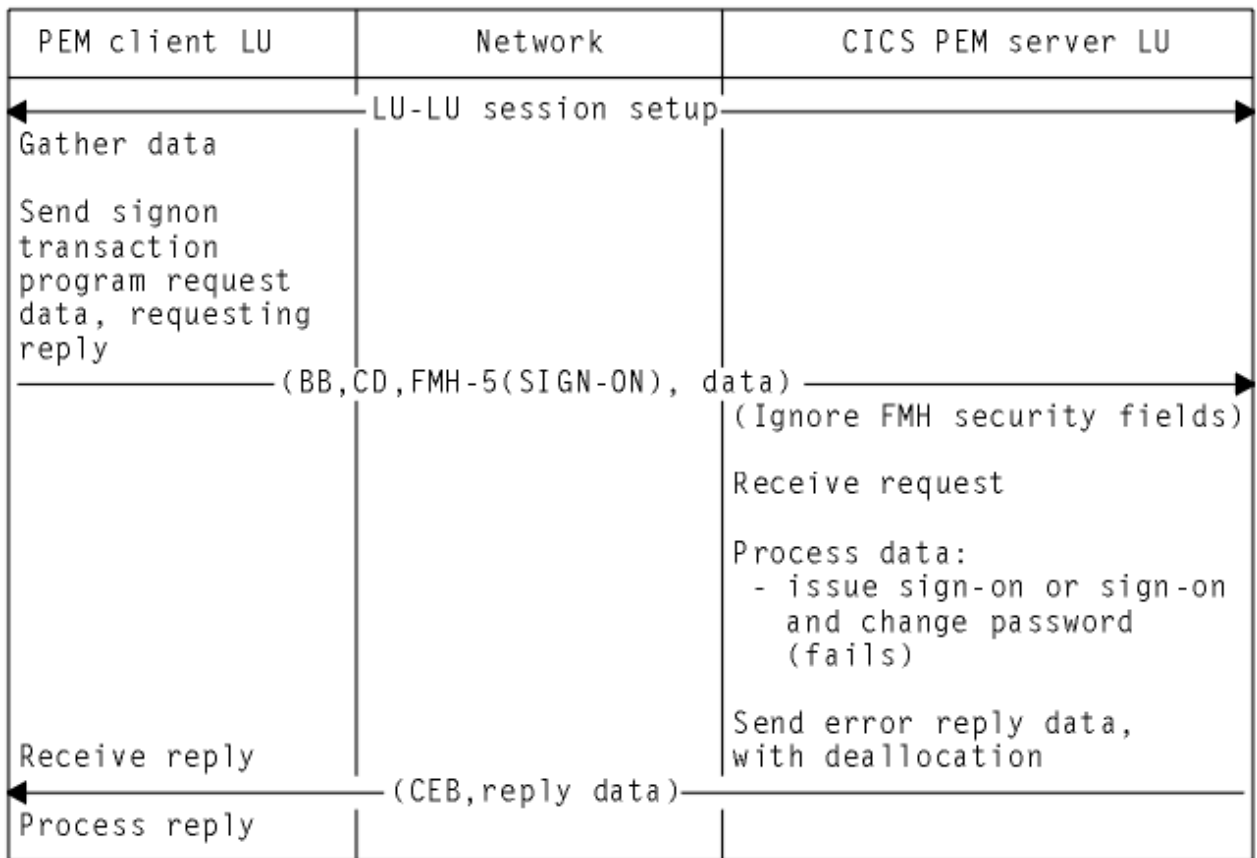

Figure 17. Unsuccessful sign-on—non-PV connection

Note: The CICS PEM server schedules sign-off against the PEM client if a sign-on request for a userid fails.

Successful sign-on—PV connection

Figure 18 on page 248 shows the expected flows between the PEM client and CICS PEM server during a successful sign-on on a PV connection.

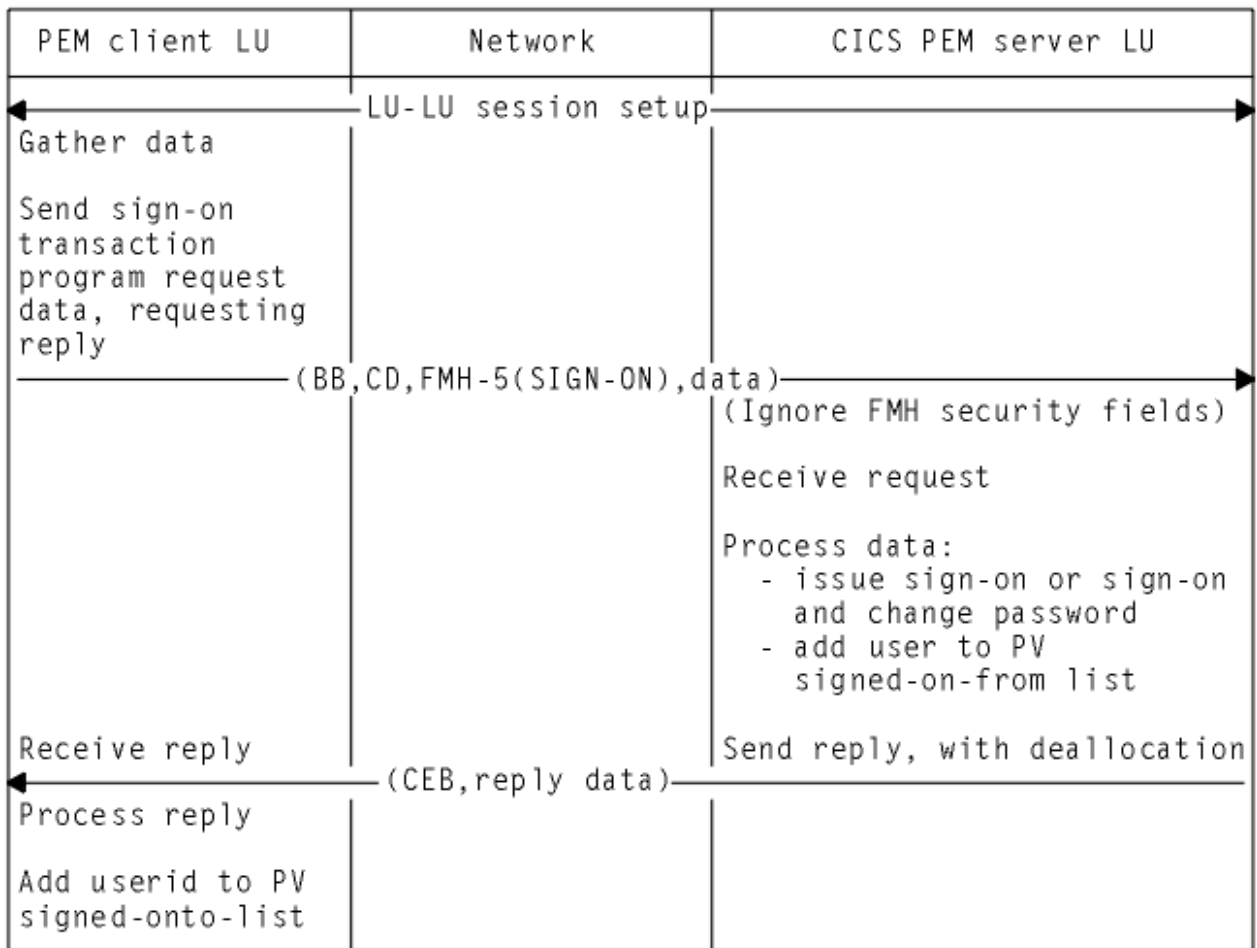

Figure 18. Successful sign-on—PV connection

Note:

1. All security fields in the FMH-5 (userid, password and UP, AV, PV1 and PV2 bits) are ignored by the CICS PEM server when it attaches the sign-on transaction.
2. The CICS PEM server adds the userid to its PV signed-on-from list only if the sign-on and change password request is successful and either ATTACHSEC=MIXIDPE or ATTACHSEC=PERSISTENT is specified in the CONNECTION definition.
3. The PEM client must add the userid to its PV signed on-to list only if a successful sign-on reply is received from the CICS PEM server. The userid has been added to the PV signed on from list in the CICS PEM server, so all subsequent attach requests from this userid can flow as signed on.

Unsuccessful sign-on—PV connection

Figure 19 on page 249 shows the expected flows between a PEM client and CICS PEM server during an unsuccessful sign-on on a PV connection.

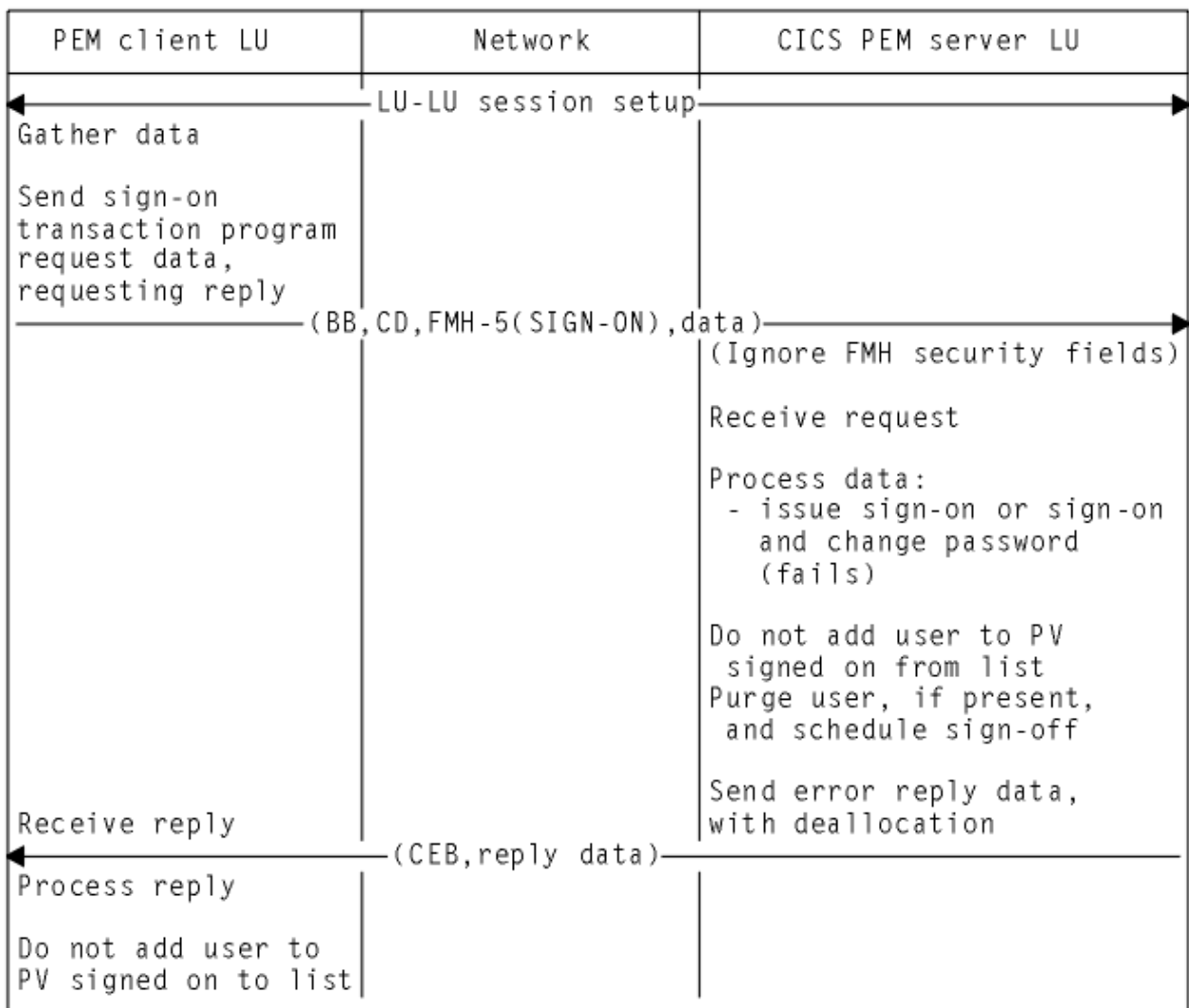

Figure 19. Unsuccessful sign-on—PV connection

Note: CICS schedules sign-off against the PEM client if a sign-on request for a userid fails, and that user is in the PV signed on from list. In this case, CICS sends the sign-off transaction program output data to the PEM client, where it is processed and the userid removed from the PV signed on to list.

Setting up the PEM client

When setting up your PEM client, note the following:

- Use the basic (also known as **unmapped**) conversation type. In addition to sending the data you want the partner to receive, you must add control bytes (in Assembler language or C) to convert the data into an SNA-defined format called a **generalized data stream** (GDS).
- The SNA service transaction program name for the sign-on transaction program is **X'06F3F0F1'**, which is also the transaction id (XTRANID) that must be used for the CICS transaction CLS4. You specify XTRANID in the CICS TRANSACTION definition.
- Run the CICS PEM server sign-on transaction as a **sync level 0** transaction. If it is initiated with a sync level other than 0, it sends an ISSUE ABEND and frees the conversation.
- Translate the userid and password into EBCDIC; if they are not in this form, the ESM cannot recognize them and issues an error. See one of the the example programs which is described in [“Introduction to APPC password expiration management” on page 241](#), for an example of converting userids and passwords to EBCDIC.

If the ESM is RACF, the userid and password must also be in uppercase characters.

- On the ATTACH request for the sign-on transaction program specify SECURITY(NONE). CICS ignores any ATTACH security fields passed in the ATTACH function management header, FMH-5, for this transaction.
- CICS does not support the receipt of the PROFILE option in the sign-on transaction program. If data identifier (ID) X'00' is provided, CICS returns status value X'06' (incorrect data format) with formatting error X'0002' (precluded structure present). For information about status values and formatting error values, see [“PEM client input and output data” on page 251](#).
- The new password ID, X'06', is permitted and required only with the X'FF01' request data ID. If the new password is provided with a data ID other than X'FF01', CICS returns status value X'06' (incorrect data format) with formatting error X'0002' (precluded structure present). For information about status values and formatting error values, see [“PEM client input and output data” on page 251](#).
- CICS only supports userids and passwords up to 8 characters long. If the userid or password length (after stripping blanks and nulls) exceeds 8, CICS returns status value X'06' (incorrect data format) with formatting error X'000F' (data value out of range). For information about status values and formatting error values, see [“PEM client input and output data” on page 251](#).
- Program initialization parameter (PIP) data is optional on the ALLOCATE for the sign-on transaction, and is ignored if sent.
- If the sign-on transaction receives a GDS ISSUE SIGNAL command, it is ignored.
- If the CICS PEM server receives a GDS ISSUE ERROR command, it replies with ERROR and frees the conversation.
- If the CICS PEM server receives a GDS FREE command, it frees the conversation. (It does not provide diagnostic information about the type of conversation error.)
- The CICS PEM server transaction does not support the receipt of data exceeding the maximum buffer size. If the concatenation bit in the initial LL is set, the command is ignored; concatenated data is also ignored.

Format of user data

As part of the general rules for APPC basic conversations, the user data must be in LL-ID-data format (where LL and ID are each two bytes long), and must follow the attach FMH-5 header.

The CICS DFHCLS4 program requires the user input data stream to fit into the format shown in [Figure 20 on page 250](#); if it does not, CICS rejects the data.

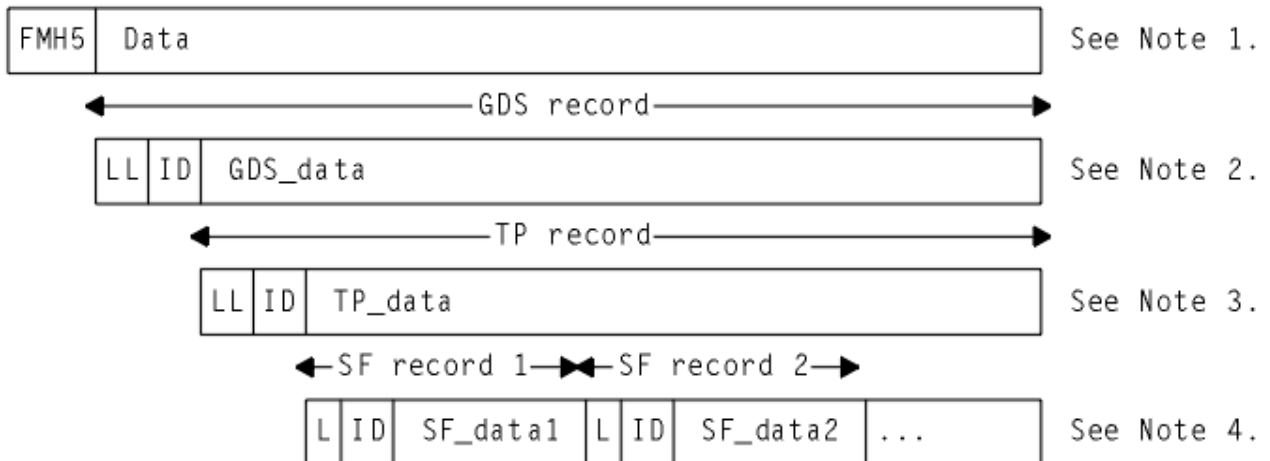

Figure 20. Format of user data

PEM client input and output data

To perform the CICS PEM server functions, the CICS PEM server takes input data from, and sends output data to, the PEM client sign-on transaction program.

The CICS PEM server functions are described in [“CICS PEM server processing”](#) on page 245.

- The PEM client sends data to the CICS PEM server, as described in [“Sign-on input data sent by PEM client”](#) on page 251.
- The CICS PEM server sends data to the PEM client, as described in [“sign-on output data returned by CICS PEM server”](#) on page 252 and its subtopics.

Ensure the data conforms to the standards described in [“Setting up the PEM client”](#) on page 249, and that its format is as described in [“Format of user data”](#) on page 250. See [“Sign-on with new password”](#) on page 255 for an example of sign-on output data in GDS flows.

Basic conversation information and data are contained in the attach FMH, as described in [“Format of user data”](#) on page 250. The sign-on request attaches a transaction X'06F3F0F1', which is the SNA service transaction program name for the sign-on transaction program.

Sign-on input data sent by PEM client

The CICS PEM server needs input data from the PEM client sign-on transaction program.

See [“Sign-on with new password”](#) on page 255 for an example of sign-on input data in GDS flows.

Length (bytes)	Value	Meaning
2	X'nnnn'	Length of entire GDS data, including this 2-byte length value.
2	X'1221'	Data ID for sign-on data.
2	X'nnnn'	Length of this second (nested) data structure (length, data ID, and data), including this 2-byte length value.
2	X'FF00' or X'FF01'	Data ID for sign-on or sign-on and change password request data, respectively. (New password subfield is not permitted for X'FF00'.)
1	X'nn'	Length of subfield for userid, including this 1-byte length value.
1	X'01'	Data ID of subfield for userid.
X'nn'-2	C'xxxxxxxx'	Userid.
1	X'mm'	Length of subfield for password, including this 1-byte length value.
1	X'02'	Data ID of subfield for password.
X'mm'-2	C'xxxxxxxx'	Password.
1	X'pp'	Length of subfield for new password, including this 1-byte length value.
1	X'06'	Data ID of subfield for new password.
X'pp'-2	C'xxxxxxxx'	New password.

sign-on output data returned by CICS PEM server

The CICS PEM server returns sign-on output data to the PEM client.

Table 37 on page 252 lists this data. See “Response to correct sign-on data” on page 256 and “Response to incorrect data format” on page 258 for examples of sign-on output data in GDS flows.

<i>Table 37. sign-on output data returned to PEM client</i>			
Length (bytes)	Value	Required or optional	Meaning
2	X'nnnn'	Required	Length of entire GDS data, including this 2-byte length value.
2	X'1221'	Required	Data ID of subfield for sign-on data.
2	X'nnnn'	Required	Length of this second (nested) data structure (length, data ID, and data), including this 2-byte length value.
2	X'FF02'	Required	Data ID for sign-on reply data.
1	X'03'	Required	Length of subfield for sign-on completion status, including this 1-byte length value.
1	X'00'	Required	Data ID of subfield for sign-on completion status.
1	X'00' through X'06'	Required	Sign-on completion status. See Table 39 on page 254 .
1	X'04'	Optional	Length of subfield for sign-on request formatting error, including this 1-byte length value.
1	X'01'	Optional	Data ID of subfield for sign-on request formatting error.
2	X'0000' through X'0003', X'0005' through X'0007', X'000F'	Optional	sign-on request formatting error. See Table 40 on page 254 .
1	X'0A'	Optional	Length of subfield for date and time of current successful sign-on, including this 1-byte length value.
1	X'02'	Optional	Data ID of subfield for date and time of current successful sign-on.
8	See Table 38 on page 253 for format	Optional	Date and time of current successful sign-on. The date and time returned are extracted by the ESM from the user profile.
1	X'0A'	Optional	Length of subfield for date and time of last successful sign-on, including this 1-byte length value.
1	X'03'	Optional	Data ID of subfield for date and time of last successful sign-on.

Length (bytes)	Value	Required or optional	Meaning
8	See Table 38 on page 253 for format	Optional	Date and time of last successful sign-on. The date and time returned are extracted by the ESM from the user profile.
1	X'0A'	Optional	Length of subfield for date and time password will expire, including this 1-byte length value.
1	X'04'	Optional	Data ID of subfield for date and time password will expire.
8	See Table 38 on page 253 for format.	Optional	Date and time password will expire. (The date and time returned are calculated from data obtained from the ESM.)
1	X'04'	Optional	Length of subfield for revoke count, including this 1-byte length value.
1	X'05'	Optional	Data ID of subfield for revoke count.
2	X'nnnn'	Optional	Revoke count.

Format of date and time subfields

This topic lists the format of the date and time subfields that the CICS PEM server can return to the PEM client.

Table 38 on page 253 lists the format of the date and time subfields that the CICS PEM server can return to the PEM client, as referred to in Table 37 on page 252. See “Response to correct sign-on data” on page 256 for an example of date and time subfields in a GDS flow.

Position	Meaning
00	Two-byte year value; for example, 1994=X'07CB'.
02	One-byte month value; January=X'01', December=X'0C'.
03	One-byte day value; first day=X'01', thirty-first day=X'1F'.
04	One-byte hour value; midnight=X'00', 23rd hour=X'17'.
05	One-byte minute value; on the hour=X'00', 59th minute=X'3B'.
06	One-byte second value; on the minute=X'00', 59th second=X'3B'.
07	One-byte 100ths of a second value; on the second=X'00', maximum=X'63'.

Note: The maximum time value for a given day is 23 hours, 59 minutes, and 59.99 seconds (decimal). Midnight is 0 hours, 0 minutes, and 0 seconds on the following day.

Sign-on completion status values returned to PEM client

This topic describes the sign-on completion status values that the CICS PEM server can return to the PEM client in the status completion subfield in the sign-on reply data.

Table 39 on page 254 describes the sign-on completion status values (referred to in Table 37 on page 252) that the CICS PEM server can return to the PEM client in the status completion subfield in the

sign-on reply data. See [“Response to correct sign-on data”](#) on page 256 for an example of sign-on completion status values in a GDS flow.

Status value	Meaning
X'00'	All of the following conditions apply: <ul style="list-style-type: none"> • Userid valid • Password valid • Password not expired or new valid password specified When this status value is returned, the new password is set if specified, and PV processing (if used) is complete.
X'01'	Userid not known to the receiver.
X'02'	Userid valid, password incorrect.
X'03'	Userid valid, password correct but expired. New password must be set.
X'04'	Userid valid, password correct, new password not acceptable to receiving security system.
X'05'	Security function failure. Function not performed.
X'06'	Incorrect data format. Specific error is contained in the sign-on request formatting error subfield described in Table 40 on page 254 .

Note: The CICS PEM server never returns either of the following sign-on status values to the PEM client:

- X'07'—general security error
- X'08'—password change completed, but sign-on failed.

Sign-on request formatting errors returned to PEM client

This topic lists the sign-on request formatting error values that the CICS PEM server can return to the PEM client.

[Table 40 on page 254](#) lists the sign-on request formatting error values (referred to in [Table 37 on page 252](#)) that the CICS PEM server can return to the PEM client. Each is a 2-byte binary value. See [“Response to incorrect data format”](#) on page 258 for an example of sign-on request formatting errors in a GDS flow.

Error value	Description
X'0000'	Undefined error not described below.
X'0001'	Required structure absent.
X'0002'	Precluded structure present.
X'0003'	Several occurrences of a nonrepeatable structure.
X'0005'	Unrecognized structure present where precluded.
X'0006'	Length outside specified range. This value assumes that the length arithmetic balances and that the sender intended to send the structure at that length.
X'0007'	Length exception. Length arithmetic is out of balance.
X'000F'	Data value out of range.

Application design

Design your applications to run the sign-on transaction before any other transaction.

This keeps that any password check and any password changing separate from the application's own functions. In multitasking systems, it is possible for more than one sign-on transaction to start on parallel sessions. It is important that the code dealing with application-level ALLOCATE requests, serializes the sign-on process to completion, thus ensuring both flow as signed-on.

To record the date and time of a previous successful sign-on, the CICS PEM server sign-on program extracts password data from the ESM **before** it performs sign-on. If your system uses shared userids, and two users attempt to sign on at the same time, or if a user is multitasking, the time values returned to the PEM client for the current sign-on may not be the same as the timestamp recorded on the ESM database. Remember this if you are writing an application that is to run on multiple systems, and depends on the sign-on time returned to the PEM client. (This situation should not apply on a single system, provided the sign-on process is serialized as suggested.)

If PV is being used, and the interval specified in PVDELAY is exceeded, and the userid is removed from the PV sign on from list, applications must allow for the sign-on process to be serialized again.

Examples of PEM client and CICS PEM server user data

Data is passed between the PEM client and the CICS PEM server by using GDS variables.

You can use the following examples to help you check the data being sent by your PEM client. These examples are produced by the sample PEM client program shown in the library CICSTS54.CICS.SDFHSAMP, which is described in [“Introduction to APPC password expiration management” on page 241](#). This program uses the following values:

partner_LU_alias

hostcics

LU_alias

ps2lua

mode_name

lu62ss

When you write your own PEM client program, use the values defined in your communications manager configuration.

Sign-on with new password

The following is an example of a successful sign-on using a new password.

```
PEM hostcics ps2lua lu62ss sec2r01 drtnnom hursley
```

A userid, password, and new password are correctly entered.

The PEM client sends the following hexadecimal user data to the CICS PEM server:

```
0231221001FFF010901E2C5C3F2D9F0F10902C4D9E3D5D6D40906C8E4D9E2D3C5E8
```

This contains the following values, as described in [Table 36 on page 251](#):

0023

Length of entire GDS variable, including this 2-byte length value

1221

Data ID for sign-on

001F

Length of this second (nested) data structure (length, data ID, and data), including this 2-byte length value

FF01

Data ID for sign-on and change password request data

09

Length of subfield for userid, including this 1-byte length value

01

ID of subfield for userid

E2C5C3F2D9F0F1

Userid (SEC2R01) in EBCDIC

09

Length of subfield for password, including this 1-byte length value

02

ID of subfield for password

C4D9E3D5D5D6D4

Password (DRTNNOM) in EBCDIC

09

Length of subfield for new password, including this 1-byte length value

06

ID of subfield for new password

C8E4D9E2D3C5E8

New password (HURSLEY) in EBCDIC

Response to correct sign-on data

Figure 21 on page 256 shows an example of the response to the correct sign-on data being entered.

```

PEM_OK
GDS`LLID
00 2d 12 21
Sign-on Reply LLID
00 29 ff 02
Sign-on Completion Status Subfield
03 00 00
Date & Time of Current Successful Sign-on Subfield
0a 02 07 ca 01 14 0d 24 31 62
Date & Time of Last Successful Sign-on Subfield
0a 03 07 ca 01 11 16 1b 23 3e
Date & Time Password Will Expire Subfield
0a 04 07 ca 02 03 00 00 00 00
Revoke Count Subfield
04 05 00 00

```

Figure 21. Response to correct sign-on data

The first three lines of hexadecimal user data returned to the PEM client show the following *required* values, as described in [Table 37 on page 252](#).

002d

Total length of the GDS variable, including this 2-byte length value

1221

Data ID for sign-on data

0029

Length of this second (nested) data structure (length, data ID, and data), including this 2-byte length value

FF02

Data ID for sign-on reply data

03

Length of subfield for sign-on completion status, including this 1-byte length value

00

Data ID for sign-on completion status

00

Sign-on completion status. 00 indicates that the userid and password were valid, and the password had not expired. (See [Table 39 on page 254](#) for a list of sign-on completion status values.)

In [Figure 21 on page 256](#), the last four lines of hexadecimal user data returned to the PEM client show the following optional values, as described in [Table 37 on page 252](#). (Note that the formatting error subfields shown in [Table 37 on page 252](#) are not included, indicating that there are no errors.)

0A

Length of subfield for date and time of current successful sign-on including this 1-byte length value

02

Data ID for date and time of current successful sign-on

Date and time of current successful sign-on, as described in [Table 38 on page 253](#):

07CA

Year (1994)

01

Month (January)

14

Day (20)

0D

Hour (13)

24

Minutes (36)

31

Seconds (49)

62

Hundredths of a second (98)

0A

Length of subfield for date and time of previous successful sign-on,

03

Data ID for date and time of previous successful sign-on

Date and time of previous successful sign-on, as described in [Table 38 on page 253](#):

07CA

Year (1994)

01

Month (January)

11

Day (17)

16

Hour (22)

1B

Minutes (27)

23

Seconds (35)

3E

Hundredths of a second (62)

0a

Length of subfield for date and time password will expire (including this 1-byte length value)

04

Length of subfield for data ID for date and time password will expire

Date and time password will expire, as described in [Table 38 on page 253](#):

07ca

Year (1994)

02

Month (February)

03

Day (14)

00

Hour (00)

00

Minutes (00)

00

Seconds 00)

00

Hundredths of a second (00)

04

Length of subfield for revoke count, including this 1-byte length value

05

Data ID of subfield for revoke count

0000

Revoke count. (0000 means that there have been no unsuccessful sign-on attempts since the last successful sign-on with this userid.)

Response to incorrect data format

Figure 22 on page 258 shows an example response to incorrect data being entered.

```
PEM_OK
GDS_LLID
00 0F 12 21
Sign-on Reply LLID
00 0B FF 02
Sign-on Completion Status Subfield
03 00 06
Sign-on Request Formatting Error Subfield
04 01 00 0F
```

Figure 22. Response to incorrect data format

The first three lines of hexadecimal user data returned to the PEM client show the following required values, as described in [Table 37 on page 252](#):

000F

Length of entire GDS data, including this 2-byte length value

1221

Data ID for sign-on data

000B

Length of this second (nested) data structure (length, data ID, and data), including this 2-byte length value

FF02

Data ID for sign-on reply data

03

Length of subfield for sign-on completion status, including this 1-byte length value

00

Data ID of subfield for sign-on completion status

06

Sign-on completion status 06 indicating incorrect data format (see [Table 39 on page 254](#) for a list of signon completion status values.)

The last line of hexadecimal user data returned to the PEM client shows the following **optional** values, which are returned only if there is an error. (The optional values are described in [Table 37 on page 252](#).)

04

Length of subfield for sign-on request formatting error, including this 1-byte length value

01

Data ID of subfield for sign-on request formatting error

000F

Sign-on request formatting error, indicating "data value out of range" (see [Table 40 on page 254](#) for a description of other possible formatting errors).

Implementing IPIC security

These topics tell you how to implement security for IPIC connections.

IPIC bind-time security

A security check can be applied when a request to establish a connection is received from, or sent to, a remote system. This is called *bind-time security*. Its purpose is to prevent an unauthorized system from connecting to CICS.

When CICS uses IPIC to communicate with another CICS region, each CICS system must have an IPCONN resource and a TCPIPSERVICE resource defined.

Each CICS system uses the IPCONN to transmit data to the partner system TCPIPSERVICE, which acts as a receiver. The CICS region that starts the communication is the client, the remote system is the server.

For IPIC, bind security is supported by the exchange of Secure Sockets Layer (SSL) client certificates. To allow two CICS regions to connect successfully, and to prevent an unauthorized system from connecting:

- The [SEC system initialization parameter](#) must be "YES" on both regions.
- The [IPCONN](#) definitions on both the local and remote regions must specify:
 - SSL(YES).
 - CIPHERS(*value*). The CIPHERS attribute can be specified in either of two ways:
 - A string of up to 56 hexadecimal digits that is interpreted as a list of up to 28 2-digit cipher suite codes.
 - The name of the SSL cipher suite specification file, which is a z/OS UNIX file in the /security/ciphers subdirectory of the directory that is specified by the **USSCONFIG** system initialization parameter. For more information, see [Cipher suites and cipher suite specification files](#).

When you use CEDA to define the resource, CICS automatically initializes the attribute with a default list of acceptable codes, depending on the level of encryption that is specified by the [ENCRYPTION system initialization parameter](#) system initialization parameter.

- Optionally, CERTIFICATE(*X.509_certificate_label*). The named certificate is used as the client certificate, during the SSL handshake when the IPCONN is acquired. If CERTIFICATE is not specified, the default certificate defined in the key ring for the CICS region user ID is used.

The IPCONN defines the *outbound* side of the connection: these settings tell CICS to initiate an SSL handshake. During the SSL handshake, CICS will ask the partner region for the certificate specified on

the TCPIP SERVICE. If the remote region TCPIP SERVICE specifies SSL(CLIEN TAUTH), the remote system requests the certificate of the originating system as part of the handshake.

- The TCPIP SERVICE resources definitions on both the local and remote regions specify:
 - PROTOCOL(IPIC).
 - SSL(CLIEN TAUTH) or SSL(YES).
 - CIPHERS(*value*).
 - Optionally, CERTIFICATE(*X.509_certificate_label*). The named certificate is used as the server certificate. If CERTIFICATE is not specified, the default certificate defined in the key ring for the CICS region user ID is used.

The TCPIP SERVICE definitions define the *inbound* side of the connection: these settings tell CICS that it must receive a valid SSL client certificate before allowing the client to acquire the IPCONN. These settings also specify that CICS will send the TCPIP SERVICE CERTIFICATE, or the default, when not specified, as a server certificate to the client.

If the TCPIP SERVICE is specified with SSL(YES), the server does not ask for, nor receive, a client certificate during the handshake.

If the TCPIP SERVICES in both CICS regions are specified with SSL(YES), both CICS regions are authenticated.

If the TCPIP SERVICES in both CICS regions are specified with SSL(CLIEN TAUTH), both CICS regions are authenticated twice.

For most circumstances, an adequate level of security is achieved by specifying TCPIP SERVICE with SSL(YES) in both regions, or SSL(NO) in one region and SSL(CLIEN TAUTH) in the other.

Note: If LINKAUTH is specified CERTUSER, the IPCONN must refer to a TCPIP SERVICE that is defined with SSL(CLIEN TAUTH).

When the TCPIP SERVICE is specified SSL(NO) on both regions, bind-time security is not possible

If the remote client is trusted by the CICS server, bind time security is not required, however, any user ID and password passed for transaction attach must be valid in the server region's external security manager.

IPIC link security

Link security restricts the resources a user can access, depending on the remote system from which they are accessed. The practical effect of link security is to prevent a remote user from attaching a transaction or accessing a resource for which the link user ID has no authority.

When link security is in use, all requests are given an authority defined by the *link user ID*. For IPCONN s, all requests for a connection have the same link user ID.

Specifying IPIC link security

To specify the link user ID of an IPCONN, use the LINKAUTH option to specify how the user ID for link security is established in a CICS system with security initialized (SEC=YES). You can specify the following:

CERTUSER

TCP/IP communication with the partner system must be configured for SSL and a certificate must be received from the partner system during SSL handshake.

The IPCONN resource must refer to a TCPIP SERVICE resource that is defined with SSL(CLIEN TAUTH).

The received certificate must be defined to the external security manager so that it is associated with a user ID, which is used to establish link security.

SECUSER

Specifies that the user ID specified in the SECURITYNAME attribute is used to establish link security.

The default value is LINKAUTH(SECUSER)

In a CICS system with security initialized (SEC=YES), the link user ID is used to establish the authority of the remote system. The link user ID must be a valid RACF user ID on this region. Access to protected resources on this region is based on the RACF user profile and its group membership.

At least one security check is always performed when a transaction is attached by a remote user, but the security checks are minimized if the specified link user ID matches the local region user ID:

If the user IDs match, only one security check is made. This is either against the default user (for USERAUTH=LOCAL or DEFAULTUSER) or against the user ID that is in the received inbound attach request (USERAUTH=IDENTIFY or VERIFY).

If the user IDs do not match, then for USERAUTH=LOCAL, resource checks are done only against the link user ID. For USERAUTH=IDENTIFY or VERIFY there are always two resource checks. The first against the link user ID, and the second is against the user ID received from the remote user in the attach request. For USERAUTH=DEFAULTUSER there are always two resource checks. The first against the link userid, and the second is against the default user.

See also [“IPIC user security” on page 261](#).

If a failure occurs in establishing link security, the link is given the security of the local region's default user. This can happen, for example, when the link user ID has been revoked.

IPIC user security

User security causes a second check of the received security context that flows from the requestor and under which the transaction operates. The received security context usually contains the user ID of the user running the client.

The security context might identify one of the following types of user:

- A user signed onto a terminal in a TOR
- A user ID of the transaction issuing the DPL request
- A client user of an ECI request

For IPIC connections, the USERAUTH attribute on the IPCONN resource definition specifies the sign-on requirements for incoming requests. It has no effect on requests that are issued by your system to a remote system; these are dealt with by the remote system. The equivalent attribute for MRO and SNA connections is the ATTACHSEC attribute. For more information about the ATTACHSEC attribute and specifying user security with other intercommunications methods, see [“Specifying user security in link definitions” on page 228](#).

For IPIC connections, you can specify the following types of user authentication:

LOCAL

CICS does not accept a user ID or password from clients. All requests run under the link user ID or the default user ID if there is no link user ID.

IDENTIFY

Incoming attach requests must specify a user ID. Enter IDENTIFY when the connecting system is trusted to pre-authenticate users, for example, if it is another CICS or CICS TG system.

SSL client authentication must be in use or the connecting system must be in the same sysplex.

VERIFY

Incoming attach requests must specify a user ID and password. Specify VERIFY when connecting systems are unidentified and cannot be trusted.

DEFAULTUSER

CICS does not accept a user ID and password from the partner system. All requests run under the default user ID.

For outbound requests, the level of user security is specified by the USERAUTH attribute of the IPCONN definition installed in the partner system. CICS sends a user ID when USERAUTH(IDENTIFY) is specified, but not when USERID(LOCAL) is specified. Because CICS does not send passwords to remote systems, USERAUTH(VERIFY) is not supported for communication between CICS TS for z/OS systems.

Note: CICS uses password verification to verify a user ID during the processes described here. CICS enforces a full verification request once a day for each user ID that is used to log on to the CICS region. The full verification request using the RACROUTE REQUEST=VERIFY macro makes RACF record the date and time of last access for the user ID, and write user statistics.

Establishing a trust relationship when using USERAUTH(IDENTIFY)

Defining an IPCONN resource with USERAUTH(IDENTIFY) means that you are prepared to accept unauthenticated, or asserted, user identifiers on the connection; that is, you are trusting the partner system to transmit only user IDs that have already been authenticated in the partner system. CICS identifies two types of partner, with differing degrees of trust:

The partner is outside the local sysplex

If the partner is outside the local sysplex, CICS does not directly trust the partner to assert unauthenticated user IDs unless it identifies itself with a trusted digital certificate. Connections from such partners are therefore only accepted using a secure socket layer connection with client authentication. This type of connection is specified by the attribute SSL(CLIENTAUTH) on the TCPIP SERVICE definition.

If you do not require encryption over the connection, you can suppress the normal encryption that SSL provides by specifying only non-encrypting cipher suites on the attribute CIPHERS(0102) of the TCPIP SERVICE definition.

The partner is in the local sysplex

If the partner is in the local sysplex, CICS trusts the partner to assert unauthenticated user IDs without requiring a digital certificate. Connections from these partners are permitted without requiring an SSL connection.

Configure the TCP/IP network so that there is no proxy between CICS and the partner system. If there is a proxy, CICS might not be able to correctly detect if a partner is in the same sysplex. It is strongly recommended that you configure the netaccess security zones to control which other systems within the same sysplex are allowed to communicate with CICS.

For further information on network access control, see the [z/OS Communications Server: IP Configuration Guide](#). For further information on the **NETACCESS** configuration parameter, see the [z/OS Communications Server: IP Configuration Reference](#).

Remote user sign-on status with IPIC

If the IPCONN resource specifies USERAUTH(IDENTIFY), the remote user remains signed on after the conversation associated with the first attach request is complete.

CICS then accepts attach requests from the same user without a new sign-on until one of the following events occurs:

- The period specified in the system initialization parameter, [USRDELAY system initialization parameter](#), elapses after completion of the last transaction associated with the attach request for this user.
- RACF notifies CICS with a RACF Event Notification (ENF) that the profile has been changed. For more information, see [“Changing the RACF profile of a remote user” on page 14](#).

If you alter the RACF profile of a signed-on remote user, for example by revoking the user, CICS continues to use the authorization established at the first attach request until one of the following situations occurs:

- The transaction performs a syncpoint.
- The attach request ends.
- Sign off occurs because RACF notifies CICS of changes to a user profile, and an attached request associated with that signed-on user ID completes, for all operands of ATTACHSEC except LOCAL.
- Sign off occurs because RACF notifies CICS of changes to a user profile, a new attach request is made, and the value in the **USRDELAY** system initialization parameter has not expired. This sign off is followed by a sign on.

IPIC transaction, resource, and command security

As in a single-system environment, users must be authorized to:

- Attach a transaction (**transaction security**)
- Access all the resources that the transaction is programmed to use. These levels are called **resource security**, **surrogate user security**, and **command security**

Transaction security

As in a single-system environment, the security requirements of a transaction are specified when the transaction is defined, as described in [“Transaction security” on page 66](#).

In an IPIC environment, two basic security requirements must be met before a transaction can be initiated:

- The link user ID must have sufficient authority to initiate the transaction (see [“IPIC link security” on page 260](#)).
- If anything other than USERAUTH(LOCAL) has been specified, user security is in force. The user who is making the request must therefore have sufficient authority to access the system and to initiate the transaction.

Resource and command security

Resource and command security in an intercommunication environment are handled in much the same way as in a single-system environment.

Resource and command security checking are performed only if the installed TRANSACTION definition specifies that they are required; for example, on the CEDA DEFINE TRANSACTION command, as shown in [Figure 23 on page 263](#).

```
CEDA DEFINE TRANSACTION
.
RESSEC(YES)
CMDSEC(YES)
.
```

Figure 23. Specifying resource and command security for transactions

If a TRANSACTION definition specifies resource security checking, using RESSEC(YES), both the link and the user must have sufficient authority for the resources that the attached transaction accesses.

If a TRANSACTION definition specifies command security checking, using CMDSEC(YES), both the link and the user must have sufficient authority for any of the system programming commands shown in [Table 11 on page 119](#) that the attached transaction issues.

For further guidance on specifying resource and command security, see [“Resource security” on page 70](#) and [“CICS command security” on page 118](#).

CICS routing transaction, CRTE

You can use the CICS routing transaction, CRTE, with IPIC, LU6.2, or MRO links to run transactions that are on a connected remote system, instead of defining these transactions as remote in the local system.

CRTE is particularly useful for infrequently used transactions, or for transactions such as CEMT that are on all systems.

Ensure that the terminal through which CRTE is started is defined on the remote system or is defined as shippable in the local system. The terminal operator needs RACF authority if the remote system is protected.

Security checking in the AOR for transactions that run under CRTE does not depend on what is specified on ATTACHSEC (for MRO and LU6.2 links) or USERAUTH (for IPIC links), nor does it depend on the user ID signed on in the TOR. Instead, security checking depends on whether the user signs on when using CRTE:

- If the user does *not* sign on, the surrogate terminal created is associated with the AOR default user. When a transaction is run, the security checks are carried out against this default user. A check is also made against the link user ID to see whether the routing application itself has authority to access the resource.
- If the user *does* sign on, using the CESN transaction while running CRTE, the surrogate points to the user ID of the signed-on user. For transactions attempting to access resources, security checking is made against the user ID of the signed-on user in the surrogate and the link user ID.

Security checking done in AOR with IPIC

This depends on how LINKAUTH, SECURITYNAME and USERAUTH are specified in the AOR.

The link user ID shown in the tables Table 41 on page 264, Table 42 on page 264, and Table 43 on page 265 is determined from the values of LINKAUTH and SECURITYNAME on the IPCONN definition. If LINKAUTH(SECUSER) is specified, the link user ID is determined from the SECURITYNAME attribute. If LINKAUTH(CERTUSER) is specified, the link user ID is determined from the external security manager such as RACF which associates a user ID with the certificate passed by the TOR during SSL handshake. LINKAUTH(SECUSER) is the default. The default value for SECURITYNAME is the default user ID.

If the link user ID is the same as the region user ID for the AOR, then the link is deemed to have the same security as the AOR, and link security is omitted altogether. The effect of omitted link security depends on the value specified with the USERAUTH attribute for the IPCONN in the AOR:

- If USERAUTH(LOCAL) is specified, security checking is done using the link user ID only.
- If USERAUTH(DEFAULTUSER) is specified, only the default user ID for the AOR is used.
- If USERAUTH(IDENTIFY) or USERAUTH(VERIFY) is specified, the link user ID is not used. Only the user ID received from the TOR is used to determine security.

USERAUTH(LOCAL) is the default.

Neither the region user ID for the TOR, nor the link user ID associated with the TOR's IPCONN definition for the AOR, is relevant to security checking in the AOR.

The following table shows how checking is done when USERAUTH(LOCAL) is specified.

Region user ID for AOR	Link user ID	Checking in AOR
USERIDA	Not specified	Check against AOR DFLTUSER
USERIDA	USERIDA	Check against AOR DFLTUSER
USERIDA	USERIDB	Check against USERIDB

The following table shows how checking is done when USERAUTH(DEFAULTUSER) is specified.

Region user ID for AOR	Link user ID	Checking in AOR
USERIDA	Not specified	Check against AOR DFLTUSER
USERIDA	USERIDA	Check against AOR DFLTUSER

<i>Table 42. USERAUTH(DEFAULTUSER) (continued)</i>		
Region user ID for AOR	Link user ID	Checking in AOR
USERIDA	USERIDB	Check against USERIDB and AOR DFLTUSER

The following table shows how checking is done when USERAUTH(IDENTIFY) or USERAUTH(VERIFY) is specified.

<i>Table 43. USERAUTH(IDENTIFY) and USERAUTH(VERIFY)</i>		
Region user ID for AOR	Link user ID	Checking in AOR
USERIDA	Not specified	Transmitted user ID and AOR DFLTUSER
USERIDA	USERIDA	Transmitted user ID only
USERIDA	USERIDB	Transmitted user ID and USERIDB

Implementing MRO security

This topic tells you how to implement CICS multiregion operation (MRO) security.

Security implications of choice of MRO access method

Either MVS cross-memory services or the CICS Type 3 SVC can be used for interregion communication (function shipping, transaction routing, distributed transaction processing, and asynchronous processing).

If you use cross-memory services, you lose the total separation between systems that is normally provided by separate address spaces.

The risk of accidental interference between two CICS address spaces connected by a cross-memory link is small. However, an application program in either system could access the other system's storage (subject to key-controlled protection) by using a sequence of cross-memory instructions.

If this situation would create a security exposure in your installation, use the CICS type 3 SVC for interregion communication, rather than MVS cross-memory services.

For information about how to specify the access method for MRO, see the [Multiregion operation](#).

Bind-time security with MRO

The CICS interregion communication (IRC) facility supports MRO through the use of DFHAPPL.applid profiles in the FACILITY class.

There are two phases to bind security checking in DFHIRP, and these occur at:

- Logon time
- Connect time

These security checks, via RACROUTE calls to the SAF interface, are always performed, regardless of whether the or not MRO partner regions are running with external security active for CICS resource security checking (that is, for both SEC=YES and SEC=NO). In order for an MRO connection to be established between two regions, both the logon and connect security checks in both systems must be completed successfully.

Logon security checking with MRO

Logon security checking is performed whenever a CICS region logs on to the CICS-supplied interregion communication (IRC) program, DFHIRP.

CICS interregion communication uses the external security manager to check that CICS regions logging on to IRC are the regions they claim to be.

Each region that uses the IRC access method must be authorized to RACF in a DFHAPPL.*applid* profile in the RACF FACILITY class. This requires the definition of a DFHAPPL.*applid* profile for each region that logs on to DFHIRP, and that each CICS region userid has UPDATE access to its own DFHAPPL.*applid* profile.

When a batch job connects to a CICS region using IRC, the CICS region logs on to IRC, and requires UPDATE access to its own DFHAPPL *applid* profile as described in this document.

See [Figure 24 on page 267](#) for an illustration of logon checking.

Connect security

To perform MRO connect security checking, DFHIRP checks that each CICS region in the connection has read access to its partner's DFHAPPL.*applid* profile.

When CICS Transaction Server for z/OS, Version 5 Release 4 DFHIRP is installed, all regions using earlier CICS releases in the MVS image use the DFHAPPL.*applid* form of MRO connect security. In addition, the SECURITYNAME parameter on the CONNECTION definition is not used for MRO and is ignored.

To authorize the MRO partner regions for bind security purposes, you must define the appropriate DFHAPPL profiles in the RACF FACILITY class. This means that each CICS region in an MRO interregion communication link must be given access to its partner's DFHAPPL.*applid* profile with READ access authority. For example, for the CICS TOR running under userid CICSRTOR (with APPLID CICSATOR), that connects to the AOR running under userid CICSRAOR (with APPLID CICSAAOR), the RACF commands to authorize the connections are shown in [Figure 24 on page 267](#).

You cannot specify to CICS whether or not you want connect security checking for MRO connections—CICS always issues the RACROUTE calls.

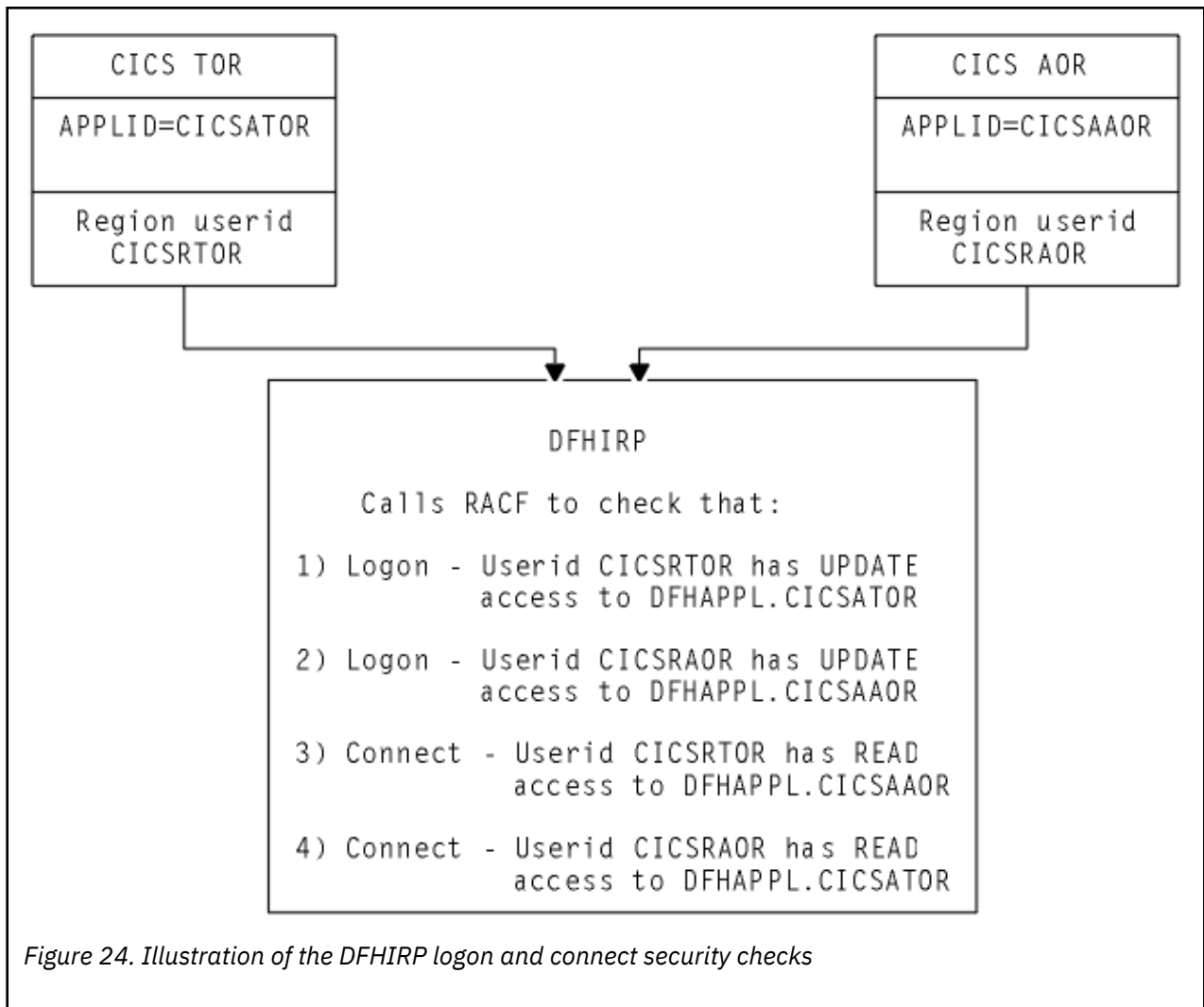

The TOR and AOR shown in [Figure 24 on page 267](#), running under region userids CICSRTOR and CICSRAOR respectively, with APPLIDs CICSATOR and CICSAAOR, require the following RACF definitions to authorize their logon to DFHIRP:

- For the MRO logon and connect process:

```
RDEFINE FACILITY (DFHAPPL.CICSATOR) UACC(NONE)
RDEFINE FACILITY (DFHAPPL.CICSAAOR) UACC(NONE)

PERMIT DFHAPPL.CICSATOR CLASS(FACILITY) ID(CICSRTOR) ACCESS(UPDATE)
PERMIT DFHAPPL.CICSAAOR CLASS(FACILITY) ID(CICSRAOR) ACCESS(UPDATE)
```

- For connection:

```
PERMIT DFHAPPL.CICSAAOR CLASS(FACILITY) ID(CICSRTOR) ACCESS(READ)
PERMIT DFHAPPL.CICSATOR CLASS(FACILITY) ID(CICSRAOR) ACCESS(READ)
```

Responses from the system authorization facility (SAF)

If the security profile for a specified resource is not retrieved, SAF neither grants nor refuses the access request. In this situation:

IRC rejects the logon or connect request if:

- A security manager was installed, but is either temporarily inactive or inoperative for the duration of the MVS image. This is a fail-safe action, on the grounds that, if the security manager was active, it might retrieve a profile that does not permit access.

IRC allows the logon or connect request if:

- There is no security manager installed, or
- There is an active security manager, but the FACILITY class is inactive, or there is no profile in the FACILITY class. The logon is allowed in this case because there is no evidence that you want to control access to the CICS APPLID.

Any CICS region without a specific DFHAPPL.applid profile, or applicable generic profile, permits all logon and connect requests. No messages are issued to indicate this. To avoid any potential security exposures, you can use generic profiles to protect all, or specific groups of, regions before, or in parallel with, security measures for specific regions. For example, specifying

```
RDEFINE FACILITY (DFHAPPL.* ) UACC(NONE)
```

ensures that any region without a more specific profile is prevented from binding.

Link security with MRO

Link security restricts the resources that a user can access, depending on the remote system from which they are accessed. The practical effect of link security is to prevent a remote user from attaching a transaction or accessing a resource for which the link userid has no authority.

Each link between systems is given an access authority defined by a link userid. A link userid for MRO is a userid defined on your SESSIONS definition for this connection. Note that for MRO, unlike LU6.2, you can have only one SESSIONS definition per connection, and there can be only one link userid per connection. If there is no preset session userid, the link userid is taken to be the region userid of the TOR region. The SECURITYNAME field on the connection definition is ignored for MRO.

You can never transaction route or function ship to CICS without having at least one security check, but the security checks done are minimized if the link userid matches the local region's userid.

- If the userids match, you will always only have one security check. This will be made either against the local region's default user (for ATTACHSEC=LOCAL) or against the userid in the received FMH-5 attach request (ATTACHSEC=IDENTIFY).
- If the userids do not match, then for ATTACHSEC=LOCAL, resource checks are done only against the link userid. For ATTACHSEC=IDENTIFY you will always have two resource checks. One check is against the link userid, and the other is against the userid received from the remote user in the attach request.

If a failure occurs in establishing link security, the link is given the same security authorization as defined for the local region's default user. This would happen, for example, if the preset session userid had been revoked.

Associate the SESSIONS definition with a RACF user profile that has access to any protected resource to which the inbound transaction needs access. See [RACF facilities](#) for guidance on defining profiles.

If the sign-on fails, a sign-on failure message is sent to the CSCS security destination, and the link is given the security of the DFLTUSER in the receiving system; that is, it is able to access only those resources to which the default user has access.

Obtaining the CICS region userid

For the purposes of MRO logon and connect security checks, DFHIRP needs to know the CICS region userid under which the CICS job or task is running. DFHIRP obtains the CICS region's userid by issuing a RACROUTE REQUEST=EXTRACT macro.

If you are not using RACF as your external security manager, you must use the MVS security router exit, ICHRTX00, to customize the response from the RACROUTE REQUEST=EXTRACT macro.

CICS determines whether a security manager is present or not by examining the SAF response codes.

Specifying link security for MRO connections

About this task

For MRO connections, all sessions have the same link userid. If you require more information about the SESSIONS resources, see [SESSIONS resources](#).

Procedure

- Specify the link userid in the USERID attribute of the SESSIONS resource definition. The SECURITYNAME field on the CONNECTION resource definition is ignored for MRO connections.

User security with MRO

User security causes CICS to make a second check against a user signed on to a terminal, in addition to the link security check described in [“Link security with MRO” on page 268](#). You should consider whether you want the extra level of security checking that user security provides.

You can specify either LOCAL, in which case the user is not checked, or IDENTIFY, in which case a userid is required, but no password is sent.

You specify the sign-on support for each connection using the ATTACHSEC operand of CONNECTION definition, as described in [“User security in link definitions” on page 269](#).

User security in link definitions

The level of user security you require for a remote system is specified in the ATTACHSEC attribute of the CONNECTION resource definition.

CICS interprets the parameters of the ATTACHSEC attribute as described here. However, special rules apply for CICS transaction routing using CRTE, as described in [“Transaction routing security with MRO” on page 272](#).

The ATTACHSEC attribute specifies the sign-on requirements for incoming requests. It has no effect on requests that are issued by your system to a remote system; these are dealt with by the remote system.

The following values of the ATTACHSEC attribute are valid with MRO:

LOCAL

specifies that a user identifier is not required from the remote system, and if one is received, it is ignored. Here, CICS makes the user security profile equivalent to the link security profile. You do not need to specify RACF profiles for the remote users. (LOCAL is the default value.)

Specify ATTACHSEC(LOCAL) if you think that the link security profile alone provides sufficient security for your system.

IDENTIFY

specifies that a user identifier is expected on every attach request. All remote users of a system must be identified to RACF.

Specify ATTACHSEC(IDENTIFY) when you know that CICS can trust the remote system to verify its users, when, for example, the remote system is another CICS.

The following rules apply to IDENTIFY:

- If a password is included in an attach request with a user identifier on a link with ATTACHSEC(IDENTIFY), CICS rejects the attach request and unbinds the session.
- If a null user identifier or an unknown user identifier is received, CICS rejects the attach request.
- If no user identifier is received, the attach is rejected unless USEDFLTUSER(YES) is specified on the connection. In this case CICS applies the security capabilities of the default user, as specified in the DFLTUSER system initialization parameter. For more information, see [The CICS default user ID](#).

Note: In the case of distributed transaction processing (DTP) transactions, you must issue a BUILD ATTACH request before the MRO SEND or CONVERSE command to include the userid of the terminal user in an attach request.

Remote user sign-on status with MRO

With the ATTACHSEC(IDENTIFY) parameter, the remote user remains signed on after the conversation associated with the first attach request is complete.

CICS then accepts attach requests from the same user without a new sign on until one of the following events occurs:

- The period specified in the **USRDELAY** system initialization parameter system initialization parameter elapses after completion of the last transaction associated with the attach request for this user.
- CICS is notified of certain changes in the RACF profile of a signed-on remote user, or a signed-on user who is not directly using a physical terminal or console, through a type 71 RACF Event Notification (ENF). For details, see [“Changing the RACF profile of a remote user” on page 14](#).
- The CICS region shuts down.

If you alter the RACF profile of a signed-on remote user, for example by revoking the user, CICS continues to use the authorization established at the first attach request until one of the following situations occurs:

- The transaction performs a syncpoint.
- The attach request ends.
- Sign off occurs because RACF notifies CICS of changes to a user profile, and an attached request associated with that signed-on user ID completes, for all operands of ATTACHSEC except LOCAL.
- Sign off occurs because RACF notifies CICS of changes to a user profile, a new attach request is made, and the value in the **USRDELAY** system initialization parameter has not expired. This sign off is followed by a sign on.

Information about remote users

With MRO links, information about the user can be transmitted with the attach request from the remote system.

This means that you can protect your resources not only on the basis of which remote system is making the request, but also on the basis of which actual user at the remote system is making the request.

This section describes some of the concepts associated with remote-user security, and how CICS sends and receives user information.

You will have to define your users to RACF. If a remote user is not defined to RACF, any attach requests from that remote user are rejected.

CICS sends userids on ATTACHSEC(IDENTIFY) conversations. [Table 44 on page 270](#) shows how CICS decides which userid to send.

<i>Table 44. MRO attach-time user identifiers</i>	
Characteristics of the local task	User identifier sent by the TOR to the AOR
Task with associated terminal—user identifier	Terminal user identifier
Task with associated terminal—no user signed on and no USERID specified in the terminal definition	Default user identifier from the TOR
Task with no associated terminal or USERID, started by interval control START command (if using function shipping or DTP)	User identifier for the task that issued the START command
Task started with USERID option	User identifier specified on the START command
CICS internal system task	CICS region userid

<i>Table 44. MRO attach-time user identifiers (continued)</i>	
Characteristics of the local task	User identifier sent by the TOR to the AOR
Task with no associated terminal, started by transient data trigger	User identifier specified on the transient data destination definition that defines the queue
Task with associated terminal, started by transient data trigger	Terminal user identifier
Task started from PLTPI	User identifier specified by the PLTPIUSR system initialization parameter

Transaction, resource, and command security with MRO

As in a single-system environment, users must be authorized to:

- Attach a transaction.
- Access all the resources that the transaction is programmed to use. This results in security levels called transaction security, resource security, and command security.

Transaction security

As in a single-system environment, the security requirements of a transaction are specified when the transaction is defined, as described in [Transaction security](#).

In an MRO environment, two basic security requirements must be met before a transaction can be initiated:

- The link must have sufficient authority to initiate the transaction.
- The "user" who is making the request must have sufficient authority to access the system and to initiate the transaction.

Resource and command security

Resource and command security in an intercommunication environment are handled in much the same way as in a single-system environment.

When resource and command security checking are performed

Resource and command security checking are performed only if the installed transaction definition specifies that they are required; for example, on the CEDA DEFINE TRANSACTION command, as shown in [Figure 25 on page 271](#).

```

CEDA DEFINE TRANSACTION
.
RESSEC(YES)
CMDSEC(YES)
.

```

Figure 25. Specifying resource and command security for transactions

If a transaction specifies resource security checking, using RESSEC(YES), both the link and the user must also have sufficient authority for the resources that the attached transaction accesses.

If a transaction specifies command security checking, using CMDSEC(YES), both the link and the user must also have sufficient authority for the commands (shown in [Table 11 on page 119](#)) that the attached transaction issues.

For further guidance on specifying resource and command security, see [“Resource security” on page 70](#) and [“CICS command security” on page 118](#).

NOTAUTH exceptional condition

If a transaction tries to access a resource, but fails the resource security checks, the NOTAUTH condition is raised.

When the transaction is the CICS mirror transaction, the NOTAUTH condition is returned to the requesting transaction, where it can be handled in the usual way.

Transaction routing security with MRO

In transaction routing, the authority of a user to access a transaction can be tested in both the TOR and the AOR.

In the TOR, a normal test is made to ensure that the user has authority to access the transaction defined as remote, just as if it were a local transaction. This test determines whether the user is allowed to run the relay program.

In the AOR, the transaction has as its principal facility a remote terminal (the "surrogate" terminal) that represents the "real" terminal in the TOR. The way in which the remote terminal is defined (see [Defining remote resources for transaction routing](#)) affects the way in which user security is applied.

- If the definition of the remote terminal does not specify the USERID parameter:
 - For links with ATTACHSEC(IDENTIFY), the transaction security and resource security of the user are established when the remote user is signed on. The userid under which the user is signed on, whether explicitly or implicitly (in the DFLTUSER system initialization parameter), has this security capability assigned in the remote system.
 - For links with ATTACHSEC(LOCAL), transaction security, command security, and resource security are limited by the authority of the link.

In both cases, tests against the link security are made as described in [“Link security with MRO” on page 268](#).

Note: During transaction routing, the 3-character operator identifier from the TOR is transferred to the surrogate terminal entry in the AOR. This identifier is not used for security purposes, but it may be referred to in messages and audit trails.

When transaction routing a PSB request, the following conditions must both be satisfied:

- ATTACHSEC on the connection definition must not be LOCAL (that is, it can be IDENTIFY, PERSISTENT, MIXIDPE, or VERIFY).
- PSBCHK=YES must be specified as a system initialization parameter in the remote system.

CICS routing transaction, CRTE

You can use the CICS routing transaction, CRTE, with IPIC, LU6.2, or MRO links to run transactions that are on a connected remote system, instead of defining these transactions as remote in the local system.

CRTE is particularly useful for infrequently used transactions, or for transactions such as CEMT that are on all systems.

Ensure that the terminal through which CRTE is started is defined on the remote system or is defined as shippable in the local system. The terminal operator needs RACF authority if the remote system is protected.

Security checking in the AOR for transactions that run under CRTE does not depend on what is specified on ATTACHSEC (for MRO and LU6.2 links) or USERAUTH (for IPIC links), nor does it depend on the user ID signed on in the TOR. Instead, security checking depends on whether the user signs on when using CRTE:

- If the user does *not* sign on, the surrogate terminal created is associated with the AOR default user. When a transaction is run, the security checks are carried out against this default user. A check is also made against the link user ID to see whether the routing application itself has authority to access the resource.

- If the user *does* sign on, using the CESN transaction while running CRTE, the surrogate points to the user ID of the signed-on user. For transactions attempting to access resources, security checking is made against the user ID of the signed-on user in the surrogate and the link user ID.

Function shipping security with MRO

When CICS receives a function-shipped request, the transaction that is invoked is the **mirror transaction**.

The CICS-supplied definitions of the mirror transactions all specify resource security checking, but not command security checking. This means that you are prevented from accessing the remote resources if either the link or your user profile on the other system does not have the necessary authority.

If the CICS-supplied definitions of the mirror transactions are not what your security strategy needs, you can change them by copying the definitions in group DFHISC into your own group, changing them, and then reinstalling them. For more information, see “Category 2 transactions” on page 145.

If you include a remote resource in your resource definitions, you can arrange for security checking to be done locally, just as if the resource were a local one. Also, the system that owns the resource can be made to apply an independent check, if it is able to receive the user identifier. You can therefore choose to apply security restrictions on both sides, on either side, or not at all.

Note: If you specify the SYSID option on a function-shipped request, security checking is done in the remote system but is **bypassed in the local system**. Figure 26 on page 273 summarizes what happens.

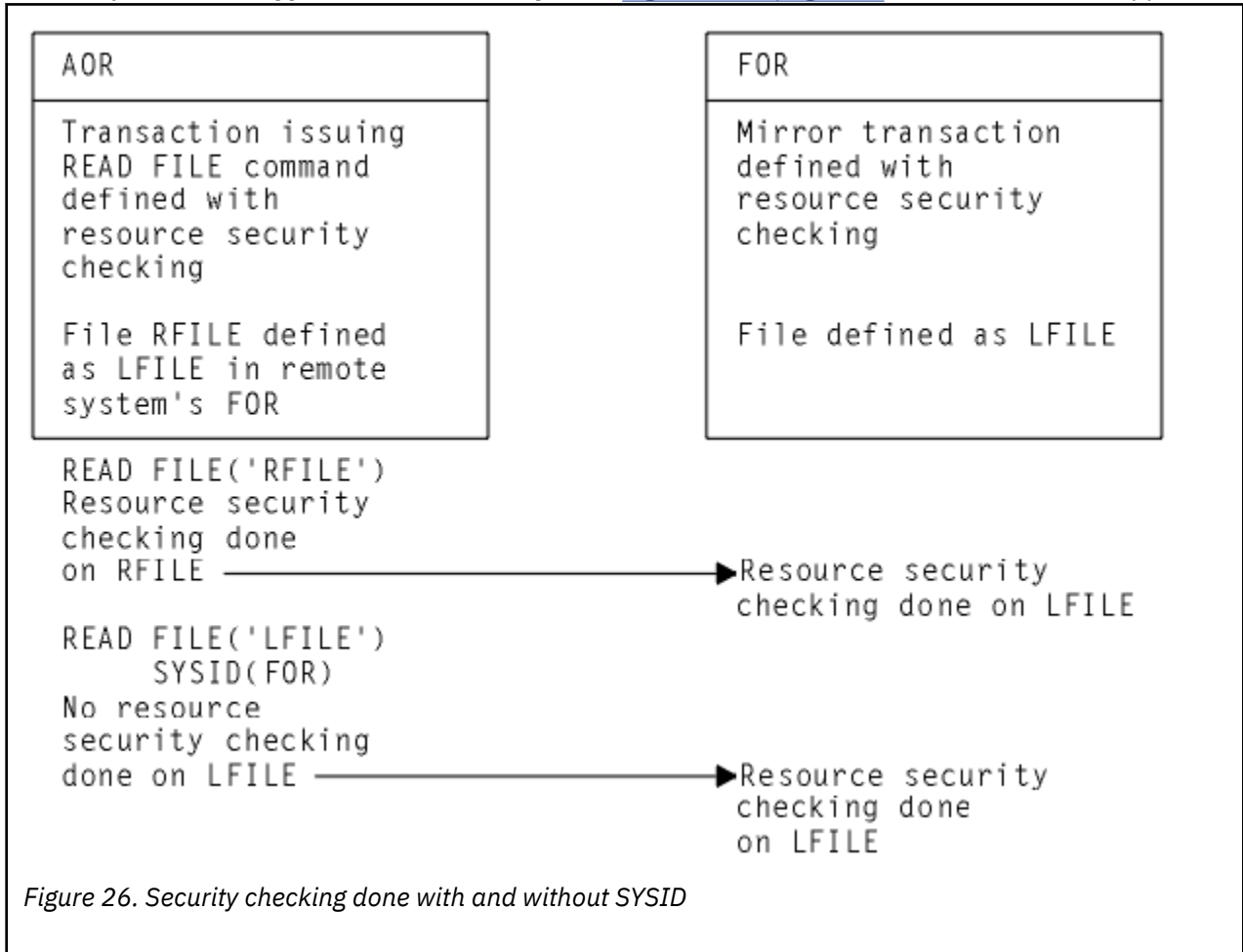

For programming information on specifying the SYSID option, see [READ](#).

Distributed program link security with MRO

The CICS distributed program link (DPL) facility enables a program (the client program) to call a CICS program (the server program) in a remote CICS region. The client program may be a CICS program or a non-CICS program.

A CICS client program uses DPL by specifying the SYSID option on the **EXEC CICS LINK PROGRAM** command, or omitting the SYSID option if the REMOTESYSTEM option of the PROGRAM resource already specifies a remote CICS region. When the SYSID option on the **EXEC CICS LINK** command specifies a remote CICS system, the client region does not perform any resource security checking, but leaves the resource check to be performed in the server region.

A non-CICS client program uses calls to DFHXCIS to open a line to the CICS system, and then to link to a CICS program. This is called the external CICS interface (EXCI). One of the parameters of the link call is the transaction identifier under which the server program is to run. Define this transaction to CICS as running program DFHMIRS and as using profile DFHCICSA. Another parameter of the link call is the client's user ID, which is validated if the MRO connection has been defined with ATTACHSEC(IDENTIFY).

To use the user ID parameter in the DFHXCIC call, the client program must have surrogate-user authority to the specified user ID. For more information, see [“Surrogate user checking for EXCI calls”](#) on page 116.

The client program receives a USER_ERROR error if the external CICS interface command fails the security check. However, this error can have other causes; each reason code value for a USER_ERROR response indicates whether the command can be reissued directly, or whether the pipe being used has to be closed and reopened first.

The server program is executed by a mirror transaction, in a similar way to other function-shipped CICS requests. However, the transaction name associated with the mirror depends on how the program link is invoked in the client region. You must be aware of the transaction name because normal attach security applies to the mirror transaction:

- If a transaction identifier is specified on the link request, the specified transaction name is used for the mirror.
- If the transaction is omitted from the link request, but the TRANSID option is used in the program resource definition in the client region, the name for the mirror is taken from the program's TRANSID specification.
- Otherwise, the default name of CSMI is used for the mirror transaction.

Authorize users to access the transaction name that the mirror runs under. The user IDs to be authorized depend on whether LOCAL or IDENTIFY attach security is being used, and are described in [“Security checking done in AOR with MRO”](#) on page 274. If you define the mirror transaction with RESSEC(YES) in the server region, authorize these user IDs to access the server program that is being linked to by the mirror. If the server program accesses any CICS resources, authorize the same user IDs to access them. If the server program invokes any SP-type commands, and the mirror transaction is defined with CMDSEC(YES) in the server region, authorize the same user IDs to access the commands.

If the mirror transaction cannot be attached because of security reasons, the NOTAUTH condition is not raised, but the TERMERR condition is returned to the issuing application in the client region. If the mirror transaction is successfully attached, but it is not authorized to link to the distributed program in the server region, the NOTAUTH condition is raised. The NOTAUTH condition is also raised if the server program fails to access any CICS resources for security reasons.

The server program is restricted to a DPL subset of the CICS API commands when running in a server region. The commands that are not supported include some that return security-related information. For programming information about which commands are restricted, see [Exception conditions for LINK command](#). For further information about DPL, refer to [Overview of DPL](#).

Security checking done in AOR with MRO

This section summarizes how security checking is done in the AOR.

The userid of the front-end CICS region is assigned as the default. However, if a USERID is specified on the SESSIONS definition, and a link check is done, the userid used is the one on the SESSIONS definition.

The region userid referred to in [Table 45 on page 275](#) through [Table 46 on page 275](#) is the USERID on the SESSIONS definition. The userid referred to in this case is the one under which the job is running. This userid is the one normally returned by the security manager domain.

With ATTACHSEC(LOCAL) specified

[Table 45 on page 275](#) shows how checking is done in the AOR when ATTACHSEC(LOCAL) has been specified.

<i>Table 45. Security checking done in AOR—ATTACHSEC(LOCAL) specified</i>			
Region userid for AOR	UserId in Session Definition in AOR	Region userid for TOR	Checking in AOR
USERIDA	Not specified	USERIDA	Check against AOR DFLTUSER
USERIDA	USERIDA	Anything	Check against AOR DFLTUSER
USERIDA	Not specified	USERIDB	Check against USERIDB
USERIDA	USERIDB	Anything	Check against USERIDB

With ATTACHSEC(IDENTIFY) specified

[Table 46 on page 275](#) shows how checking is done in the AOR when ATTACHSEC(IDENTIFY) has been specified.

<i>Table 46. Security checking done in AOR—ATTACHSEC(IDENTIFY) specified</i>			
Region userid for AOR	UserId in session definition in AOR	Region userid for TOR	Checking in AOR
USERIDA	Not specified	USERIDA	FMH-5 ATTACH check only
USERIDA	USERIDA	Anything	FMH-5 ATTACH check only
USERIDA	Not specified	USERIDB	FMH-5 ATTACH check and USERIDB
USERIDA	USERIDB	Anything	FMH-5 ATTACH check and USERIDB

Security for data tables

This topic describes how to provide security for CICS shared data tables and coupling facility data tables.

Security for CICS shared data tables

To provide security for a shared data table when **cross-memory services** are used, ensure that:

- The file-owning region (FOR) that is acting as the shared data table server cannot be impersonated. See [“SDT server authorization security check” on page 276](#) for details of how you ensure this.
- An application-owning region (AOR) cannot gain access to data that it is not meant to access. You can prevent this by checking at CONNECT time that the AOR is allowed access to the FOR and, if file security is in force, that the AOR is allowed access to the requested file.

These security checks are performed through the system authorization facility (SAF), to invoke RACF or an equivalent security manager.

Note: A region is still able to use data tables locally even if it does not have authority to act as a shared data table server.

The CICS shared data tables (SDT) facility reproduces the main characteristics of function-shipping security that operate at the region level, but note the following differences:

- SDT does not provide any mechanism for the FOR to perform security checks at the transaction level (there is no equivalent of ATTACHSEC(IDENTIFY) or ATTACHSEC(VERIFY)). Therefore, if you consider that the transaction-level checks performed by the AOR are inadequate for some files, ensure that those files are not associated with data tables in the FOR.
- SDT does not support any equivalent of preset security on SESSIONS, because no sessions are used.
- SDT does not pass any installation parameter list (INSTLN) information to the security user exits.

Security checking for data tables

You should consider the implications of the security checks before sharing a file that is associated with a data table.

SDT security makes use of existing CICS file security definitions, but it also relies on treating SDT server APPLIDs as protected resources. An SDT server's APPLID is represented by a DFHAPPL.*applid* profile in the RACF FACILITY resource class.

SDT server authorization security check

When a region attempts to be an SDT server, it calls RACF to check whether its user ID has the required access authority to its APPLID.

If the call fails, the region cannot initialize the required SDT support to be a server. This minimizes the risk that an AOR might accept **counterfeit data records** from an FOR that is not properly authorized to act as an SDT server. This check is never bypassed, even when SEC=NO is specified at system initialization.

To act as a server for a protected APPLID, an SDT FOR's userid must have UPDATE (or higher) access to its DFHAPPL.*applid* profile in the FACILITY class. In the following example definitions, the APPLID of the FOR is CICS HF01, and its user ID is CICS SDT1:

```
RDEFINE FACILITY (DFHAPPL.CICSHF01) UACC(NONE)
PERMIT DFHAPPL.CICSHF01 CLASS(FACILITY) ID(CICSSDT1) ACCESS(UPDATE)
```

The first example authorizes one FOR to act as a server with APPLID CICS HF01, running under user ID CICS SDT1. The following example shows how to authorize a group of FORs, with user IDs defined as members of group SDTGRP1, to act as SDT servers using a generic profile in the FACILITY class:

```
RDEFINE FACILITY (DFHAPPL.CICSTST*) UACC(READ)
PERMIT DFHAPPL.CICSTST* CLASS(FACILITY) ID(SDTGRP1) ACCESS(UPDATE)
```

If SAF neither grants nor refuses an access request

If a security profile for a specified resource is not retrieved, SAF neither grants nor refuses the access request.

In this situation:

- The request fails if a security manager is installed but is either temporarily inactive or inoperative for the duration of this MVS IPL. This decision is made on the grounds that had the security manager been active it might have retrieved a profile that refuses access.
- The request succeeds if:
 - There is no security manager at all.

- There is an active security manager but the FACILITY class is undefined or inactive.
- There is no profile covering the APPLID in question.

The request is allowed in these cases because there is no evidence that you want to control access to the particular FOR APPLID.

CONNECT security checks for AORs

The security checks performed at CONNECT time provide two levels of security, bind security and file security.

- **Bind security** allows an FOR that runs without CICS file security to be able to restrict shared access to selected AORs. (Running without file security minimizes runtime overheads and the number of security definitions.)
- **File security** can be activated in the FOR if you want SDT to implement those checks that apply to the AOR as a whole.

Note that SDT provides no way of implementing those security checks that an FOR makes at the transaction level when ATTACHSEC(IDENTIFY) or ATTACHSEC(VERIFY) is used with function shipping.

Bind security

To be allowed shared access to any of an FOR's data tables, an AOR's user ID needs READ (or higher) access to the FOR's DFHAPPL.applid in the FACILITY class.

This check is never bypassed, even when SEC=NO is specified at system initialization. In the following example definitions, three CICS AORs (user IDs are CICSAOR1, CICSAOR2, and CICSAOR3) all require SDT access to the FOR represented by the DFHAPPL.CICSHF01 profile:

```
PERMIT DFHAPPL.CICSHF01 CLASS(FACILITY) ID(CICSAOR1 CICSAOR2 CICSAOR3)
ACCESS(UPDATE)
```

Cases when SAF neither grants nor refuses access are resolved in the same way as for server LOGON (see [“If SAF neither grants nor refuses an access request”](#) on page 276). If the result is a refusal, CICS does not permit shared access by the AOR to the FOR's APPLID.

Note that controlling SDT server authorization security and bind security by using different (but hierarchical) levels of access to the same resource has the following consequences:

- Any region with the same user ID as a server can always bind to that server.
- It is impossible to control which user IDs can bind to a given APPLID without also controlling which user IDs can log on as servers for that APPLID.

SDT bind-time security uses different definitions from those employed by IPIC, ISC, and (if using preset sessions) MRO. Therefore, unless you make them consistent, SDT access might be granted when function shipping attempts are rejected, or vice versa. Both MRO and SDT use the same class and so, with ISC only, SDT CONNECT security might react to changes in security definitions either earlier or later than function shipping.

If file security is not in force in the FOR (that is, if SEC=NO or XFCT=NO was specified at system initialization), an AOR that is allowed to bind to an FOR is also allowed to access all that FOR's shared data tables.

If file security is in force, an AOR that is allowed to bind is still allowed free access if the user IDs of the AOR and FOR are the same (undefined user IDs are not considered to be the same).

File security

After the bind-security check, and when file security is in force in the FOR, the FOR checks whether the AOR is authorized to “sign on” to the FOR.

This security check is optional, and applies only when the user ID of the AOR is different from that of the FOR. It is the equivalent of ATTACHSEC(LOCAL) in an MRO environment (see [“User security with MRO”](#) on page 269). The AOR also requires READ authorization to the file it is trying to access in the FOR.

To implement file security checking by the FOR:

- Initialize the FOR with system initialization parameter SEC=YES
- Authorize the AOR with READ access to the FOR's APPLID profile in the APPL general resource class
- Specify the appropriate value on the XFCT system initialization parameter
- Authorize the AOR's region user ID with READ access to the required files in the file resource profiles named on the XFCT system initialization parameter.

For example, define the APPL profile for an FOR with APPLID CICSHF01, and the PERMIT command to enable the AORs with user IDs CICSAOR1 and CICSAOR2 to sign on to CICSHF01, as follows:

```
RDEFINE APPL CICSHF01 UACC(NONE) NOTIFY(sys_admin_userid)
PERMIT CICSHF01 CLASS(APPL) ID(CICSAOR1 CICSAOR2) ACCESS(READ)
```

For information about authorizing access to files, see [“Security for files” on page 79](#).

Cases when SAF neither grants nor refuses the request are resolved in the same way as for server LOGON (see [“If SAF neither grants nor refuses an access request” on page 276](#)).

If the user ID is allowed to sign on to the FOR's application, the CONNECT request succeeds unless the AOR's user ID is not allowed to read the specified file. Otherwise, the CONNECT request is treated in the same way as when the AOR's user ID is undefined.

When file security is in force in an FOR, and the user ID of the AOR is *undefined*, a CONNECT request fails unless the FOR's default user ID (specified by the DFLTUSER system initialization parameter) is allowed to read the specified file.

Function shipping detects that an AOR's access to a file has been revoked when a rebuild of the file control resource class is completed in the FOR. However, if a valid connection exists, SDT continues to allow access until something causes the connection to be broken. See [Refreshing resource profiles in main storage](#).

Caution: If you use ISC instead of MRO for function shipping, ensure that the value of the SECURITYNAME parameter in the FOR is the same as the user ID of the AOR. If you use IPIC instead of MRO for function shipping, ensure that the value of the IPCONN SECURITYNAME parameter or, if applicable, the AOR's certificate's user ID in the FOR is the same as the user ID of the AOR. Otherwise, the SDT CONNECT, and function shipping security checks are inconsistent.

Security for coupling facility data tables

CICS and MVS use RACF facilities to provide security for coupling facility data tables in the following areas:

1. Authorizing server access to a coupling facility list structure
2. Authorizing the server
3. Authorizing a CICS region's access to a coupling facility data table pool
4. Authorizing a CICS region to a CFDT
5. File resource security checking.

With the exception of items 4 and 5, which are optional, the other security checks are made automatically and are never bypassed. For items 2 and 3 in this list, in cases when the system authorization facility (SAF) neither grants nor refuses access are resolved in the same way as the LOGON security check for CICS shared data table support (see [“SDT server authorization security check” on page 276](#) for details).

An optional security check, which is controlled by server startup parameters, is provided for controlling access to specific tables within a coupling facility data table pool. This is described further in [“Authorizing a CICS region to a coupling facility data table” on page 279](#).

Authorizing server access to a list structure

Each coupling facility data table server requires access to the coupling facility list structure that contains its pool of coupling facility data tables.

To permit access, the server region user ID requires ALTER access to a FACILITY class general resource profile called IXLSTR.*structure_name*.

- The server region user ID is the userid under which the job or started task is running.
- Structure names for coupling facility data tables take the form DFHCFLS_*poolname*.

For example, if coupling facility data tables are defined in a pool called PRODCFT1, the list structure for this pool is named DFHCFLS_PRODCT1 in the CFRM policy. To access this list structure, the server user ID for pool PRODCFT1 requires ALTER access to the IXLSTR profile, defined as follows:

```
RDEFINE FACILITY IXLSTR.DFHCFLS_PRODCT1 UACC(NONE)
PERMIT IXLSTR.DFHCFLS_PRODCT1 CLASS(FACILITY) ID(server_userid) ACCESS(ALTER)
```

Authorizing the server

When a coupling facility data table (CFDT) server starts up for a given coupling facility data table pool, CICS authorized cross-memory (AXM) services call RACF to establish that the server is authorized to act as a server for that pool.

To authorize a CFDT server to act as a server for its specified pool, give the server region user ID CONTROL access to a FACILITY class general resource profile called DFHCF.*poolname*.

For example, if the pool is PRODCFT1, define the profile and the required PERMIT statement as follows:

```
RDEFINE FACILITY DFHCF.PRODCFT1 UACC(NONE)
PERMIT DFHCF.PRODCFT1 CLASS(FACILITY) ID(server_userid) ACCESS(CONTROL)
```

Authorizing a CICS region to a CFDT pool

Each CICS region requires authorization to connect to a coupling facility data tablepool. To authorize a CICS region to connect to a server and its pool, give the CICS region UPDATE access to the server's FACILITY class profile for the pool.

For example, if the pool is PRODCFT1, define the required PERMIT statement as follows:

```
PERMIT DFHCF.PRODCFT1 CLASS(FACILITY) ID(CICS_region_userid) ACCESS(UPDATE)
```

Authorizing a CICS region to a coupling facility data table

In addition to controlling the access of a CICS region to a coupling facility data table (CFDT) pool, you can optionally control access to each CFDT in the pool.

This security check, if active, is performed by the server each time a CICS region connects to a coupling facility data table for the first time. For more information about CFDT server security parameters, see [Security parameters](#).

The resource security check is done as if for a CICS file owned by the coupling facility data table server region, using a profile defined in the general resource class specified on the SECURITYCLASS server initialization parameter. The default for this is the FCICSFCT class. For the profile name, use the table name as defined in the file resource definition.

You can optionally prefix the profile name using the server region user ID as the prefix by specifying SECURITYPREFIX=YES as a server initialization parameter. You can customize the prefix for this security check using the server initialization parameter SECURITYPREFIXID.

The following example shows the security parameters for a pool called PRODCFT1:

```
POOLNAME=PRODCFT1
SECURITY=YES
```

```
SECURITYCLASS=FCICSFCT  
SECURITYPREFIX=NO
```

For example, if the pool is PRODCFT1, define the profile and the required PERMIT statement as follows:

```
RDEFINE FCICSFCT PRODCFT1 UACC(NONE)  
PERMIT PRODCFT1 CLASS(FCICSFCT) ID(region_userid) ACCESS(UPDATE)
```

The coupling facility data table server performs the table security check by issuing a cross-memory mode FASTAUTH check, which requires the use of global in-storage security profiles. Access fails if a return code other than zero is received by the server in response to the FASTAUTH check. If the external security manager does not support cross-memory mode FASTAUTH or global in-storage profiles, coupling facility data table security checks are not possible and an error message is issued at server initialization time if table security checking is specified. For information about all server initialization parameters that can be specified, see [Coupling facility data table server parameters](#).

File resource security checking

Normal CICS resource security for files is supported for coupling facility data tables. CICS performs the usual file resource security checks against signed-on users of transactions that access coupling facility data tables, using profiles defined in the general resource class named on the XFCT system initialization parameter.

See [“Security for files” on page 79](#) for details of CICS file security.

Chapter 7. Security for TCP/IP clients

This part discusses how you can secure your applications when CICS participates in a client-server configuration, using TCP/IP communication protocols.

About security for TCP/IP clients

TCP/IP connections between clients and servers — especially when they use the internet — are vulnerable to attack by malicious parties.

An attacker might attempt to:

- Read confidential information flowing between client and server.

You can protect your system by encrypting data that flows between the client and server.

- Falsify information flowing between client and server.

You can protect your system by encrypting data that flows between the client and server, and by detecting data that has been tampered with.

- Impersonate a legitimate user of a client system.

You can protect your system by authenticating users.

CICS supports several schemes for authenticating users. See [“Identification and authentication” on page 284](#) for more information.

CICS can use the Secure Sockets Layer (SSL) security protocol or the Transport Layer Security (TLS) protocol to support secure TCP/IP connections. See [“Support for security protocols” on page 288](#) for more information.

Message protection

Message protection is a term that describes the techniques used to ensure that a confidential message cannot be observed in transit, and cannot be illicitly changed.

The two aspects of message protection are:

Confidentiality

Protecting the message content from being intercepted

Integrity

Protecting a message from illicit modification

Confidentiality is achieved by encrypting the message (or parts of it) using a public key encryption scheme, so that only the intended recipient of the message can read it.

Integrity is achieved by digitally signing the message, so that the intended recipient can be confident that the message has not been changed illicitly.

Public key encryption

Public key encryption is a cryptographic system that uses two keys - a *public key* that is potentially known to everyone and a related *private key* that is known only to one party in an exchange of information.

The private and public keys used for public key encryption are related to each other in such a way that:

- It is not feasible to deduce the value of the private key from the public key, nor the public key from the private key.

While the private key must be stored securely, and not made known to anyone but its owner, the public key can be made freely available to any user, with no risk of compromising the security of the private key.

- Information encrypted using the public key can be decrypted only with the private key.

Information can be encrypted by any user, and sent securely to the holder of the private key: data encrypted with the public key is readable by only the holder of the private key.

- Information encrypted using the private key can be decrypted only with the public key.

Only the holder of the private key can encrypt information that can be decrypted with the public key. Any party can use the public key to read the encrypted information; however, data that can be decrypted with the public key is guaranteed to originate with the holder of the private key.

Knowledge of a public key does not guarantee the identity of the owner of the corresponding private key, and so encryption of information with a public key cannot, on its own, prevent encrypted information falling into the wrong hands. Before a public key can be safely used to encrypt or decrypt information, the identity of the holder of the private key must be assured. This assurance is provided by a *digital certificate* which binds the public key to the identity of the private key's owner.

Related concepts

Digital signatures

A digital signature is information that is attached to data to assure the recipients of the data that it has not been altered and has originated from the signer of the message. Digital signatures perform an equivalent function to a handwritten signature on a paper document.

Digital certificates

A digital certificate is a digitally signed data structure that binds a public key to the identity of the private key's owner. The use of digital certificates ensures that the user of a public key can be confident of the ownership of the corresponding private key.

Digital signatures

A digital signature is information that is attached to data to assure the recipients of the data that it has not been altered and has originated from the signer of the message. Digital signatures perform an equivalent function to a handwritten signature on a paper document.

A digital signature consists of a *message digest* encrypted with the message sender's private key. The message digest, which is much shorter than the original message, is created from the message using a process known as *hashing*. It is not possible to reconstruct the original message from the message digest. The message, when combined with the signature, is a *signed message*.

The receiver of a signed message attempts to decrypt the signature using the sender's public key, thus changing it back into a message digest. Success indicates that the message was signed by the sender, because only the sender has the private key. The receiver then hashes the document data into a message digest, and compares it with the message digest obtained by decrypting the signature. If both digests are the same, the receiver can be sure that the signed message has not been changed.

A digital signature does not provide confidentiality. In other words, data that is not encrypted data can bear a digital signature.

Knowledge of a public key does not guarantee the identity of the owner of the corresponding private key, and so encryption of information with a public key cannot, on its own, prevent encrypted information falling into the wrong hands. Before a public key can be safely used to encrypt or decrypt information, the identity of the holder of the private key must be assured. This assurance is provided by a *digital certificate* which binds the public key to the identity of the private key's owner.

Related concepts

Public key encryption

Public key encryption is a cryptographic system that uses two keys - a *public key* that is potentially known to everyone and a related *private key* that is known only to one party in an exchange of information.

Digital certificates

A digital certificate is a digitally signed data structure that binds a public key to the identity of the private key's owner. The use of digital certificates ensures that the user of a public key can be confident of the ownership of the corresponding private key.

Digital certificates

A digital certificate is a digitally signed data structure that binds a public key to the identity of the private key's owner. The use of digital certificates ensures that the user of a public key can be confident of the ownership of the corresponding private key.

Digital certificates are issued by a trusted body, known as a Certificate Authority (CA), that is typically independent of the message sender and receiver (although if there is a trust relationship between the sender and the receiver, the certificate can be issued by one or the other). The certificate is encrypted with the CA's private key, and can be decrypted using the CA's public key, which is freely available to anyone who needs to read the certificate.

Following decryption, a valid certificate assures the reader that the certificate was indeed issued by the CA, and that the certificate has not been tampered with or forged.

A digital certificate contains information that identifies the certificate owner, and the certificate owner's public key, and is digitally signed by the CA. The receiver of a message containing a certificate uses the CA's public key to decrypt the certificate, verifies that it was issued by the CA and then obtains the sender's public key and identification information held within the certificate.

Related concepts

Public key encryption

Public key encryption is a cryptographic system that uses two keys - a *public key* that is potentially known to everyone and a related *private key* that is known only to one party in an exchange of information.

Digital signatures

A digital signature is information that is attached to data to assure the recipients of the data that it has not been altered and has originated from the signer of the message. Digital signatures perform an equivalent function to a handwritten signature on a paper document.

X.509 Certificates

ITU-T recommendation X.509 defines a widely used format for digital certificates.

An X.509 certificate contains

- Two *distinguished names*, which uniquely identify the Certificate Authority (CA), that issued the certificate and the *subject* (the individual or organization to whom the certificate was issued). The distinguished names contain several optional components:
 - Common name
 - Organizational unit
 - Organization
 - Locality
 - State or Province
 - Country
- A digital signature. The signature is created by the certificate authority using the public-key encryption technique:
 1. A secure hashing algorithm is used to create a digest of the certificate's contents.
 2. The digest is encrypted with the certificate authority's private key.
 3. The signature is decrypted with the CA's public key.
 4. A new digest of the certificate's contents is made, and compared with the decrypted signature. Any discrepancy indicates that the certificate may have been altered. The digital signature thus assures the receiver that no changes have been made to the certificate since it was issued.
- The subject's domain name. The receiver compares this with the actual sender of the certificate.

- The subject's public key.

Identification and authentication

Identification is the process by which the identity of a user is established, and *authentication* is the process by which a service confirms the claim of a user to use a specific identity by the use of credentials (usually a password or a certificate).

Identification

Identification is the process by which the identity of a user is established.

In CICS, identification can be accomplished in several ways:

- The client can supply a user ID directly. Typically this is done as part of the authentication process.

You can identify users in this way when you use basic authentication with the ECI and HTTP application protocols.

- The client can supply information other than a user ID (for example, an SSL client certificate) during the authentication process. The information is mapped to a user ID in the security manager.

You can identify users in this way when you use SSL client certificate authentication with the HTTP application protocol.

- The user ID can be supplied in a user-replaceable program which is invoked for each inbound request.

In the HTTP application protocol, the analyzer program can supply a user ID.

- The user ID can be supplied in a URIMAP definition for an inbound request. You can identify users in this way when you use URIMAP definitions to handle requests on the HTTP application protocol.

If you do not use one of these methods to supply a user ID, the default user ID is used.

Identifying HTTP users

Identification is the process by which the identity of a user is established. This is how a user's identity is established for the HTTP application protocol.

About this task

For the HTTP application protocol, you can identify the user in the following ways:

- A user ID can be obtained from the web client using HTTP basic authentication.
- If the web browser sends a client certificate, you can use a user ID that is associated with the certificate.

You can associate a certificate with a RACF user ID in two ways:

- You can use RACF commands to associate a certificate with a user ID.
- CICS can automatically issue the RACF commands to associate a certificate with a user ID (which is obtained from the Web client using HTTP basic authentication).

[“Associating a RACF user ID with a certificate” on page 299](#) tells you how to do this.

For application-generated responses only, it is also possible for CICS to supply a user ID on behalf of the web client:

- In an analyzer program that is used in the processing path for the request.
- In the USERID attribute of the URIMAP definition for a request.
- As the CICS default user ID.

If you use a URIMAP definition or analyzer program to set a user ID that has not been supplied by a client, or allow the CICS default user ID to be used, there is no authentication of the client's identity. Only do this when communicating with your own client system, which has already authenticated its users, and communicates with the server in a secure environment.

When the HTTP response is to be provided by an application (an application-generated response), the order of precedence of user IDs is:

1. A user ID that you set using an analyzer program. This user ID can override a user ID obtained from the Web client or supplied by a URIMAP definition.
2. A user ID that you obtained from the Web client using basic authentication, or a user ID associated with a client certificate sent by the Web client. If authentication is required for the connection but the client does not provide an authenticated user ID, the request is rejected.
3. A user ID that you specified in the URIMAP definition for the request.
4. The CICS default user ID, if no other can be determined.

When the HTTP response is to be provided by a URIMAP definition that specifies a CICS document template or z/OS UNIX file (a static response), the user ID used for the Web client is a user ID that you obtained from the Web client using basic authentication, or a user ID associated with a client certificate sent by the Web client. For static responses, it is not possible to supply a user ID on behalf of the Web client, nor to override an authenticated user ID obtained from a Web client.

For static responses, CICS only makes use of a supplied user ID if you specify resource security checking for the transaction. No default user ID is required for static responses. If the Web client does not supply a user ID, no resource security checking is carried out, even if resource security is active for the transaction.

Note: CICS uses password verification to verify a user ID during the processes described here. CICS enforces a full verification request once a day for each user ID that is used to log on to the CICS region. The full verification request using the RACROUTE REQUEST=VERIFY macro makes RACF record the date and time of last access for the user ID, and write user statistics.

The method used to identify the user is determined by the AUTHENTICATE and SSL attributes of the TCPIP SERVICE definition:

<i>Table 47. How the user of an HTTP client is identified</i>		
AUTHENTICATE	SSL	How the user is identified
NO	NO or YES	The client does not supply a user ID. It can be supplied by an analyzer program or URIMAP definition, or allowed to default to the CICS default user ID, if applicable.
NO	CLIENTAUTH, or ATTLISAWARE	If the client sends a certificate that is associated with a user ID, then that user ID applies, unless it is overridden by an analyzer program. If the client sends a certificate that is not associated with a user ID, a user ID can be supplied by an analyzer program or URIMAP definition, or allowed to default to the CICS default user ID, if applicable.
BASIC	all values	If the client sends a certificate that is associated with a user ID, then that user ID applies, unless it is overridden by an analyzer program. If the client sends a certificate that is not associated with a user ID, then the user ID is obtained from the client, using HTTP basic authentication, and the user ID is registered to the certificate. If the client does not send a certificate, then the user ID is obtained from the client, using HTTP basic authentication and can be overridden by an analyzer program.

Table 47. How the user of an HTTP client is identified (continued)

AUTHENTICATE	SSL	How the user is identified
CERTIFICATE	CLIENTAUTH, or ATTLISAWARE	<p>If the client sends a certificate that is associated with a user ID, then that user ID applies, unless it is overridden by an analyzer program.</p> <p>If the client sends a certificate that is not associated with a user ID, or does not send a certificate, then the connection is rejected.</p>
AUTOREGISTER	CLIENTAUTH, or ATTLISAWARE	<p>If the client sends a certificate that is associated with a user ID, then that user ID applies, unless it is overridden by an analyzer program.</p> <p>If the client sends a certificate that is not associated with a user ID, then the user ID is obtained from the client, using HTTP basic authentication, and the user ID is registered to the certificate.</p> <p>If the client does not send a certificate, then the connection is rejected.</p>
AUTOMATIC	NO or YES	<p>A user ID is obtained from the client, using HTTP basic authentication. This can be overridden by an analyzer program.</p>
AUTOMATIC	CLIENTAUTH, or ATTLISAWARE	<p>If the client sends a certificate that is associated with a user ID, then that user ID applies, unless it is overridden by an analyzer program.</p> <p>If the client sends a certificate that is not associated with a user ID, then the user ID is obtained from the client, using HTTP basic authentication, and the user ID is registered to the certificate.</p> <p>If the client does not send a certificate, then the user ID is obtained from the client, using HTTP basic authentication.</p>

Note:

1. This table does not list combinations of values for the AUTHENTICATE and SSL attributes that are invalid, and that cannot be specified in the TCPIP SERVICE definition.
2. If HTTP basic authentication is used, CICS verifies the password. If the password is invalid, the connection is rejected.

Identifying ECI users

For the ECI protocol you can use basic authentication to identify the user.

Specify ATTACHSEC(VERIFY) in the TCPIP SERVICE definition for the ECI client. Specify ATTACHSEC(LOCAL) if you do not want to identify the user.

Identifying IPIC users

Identification is the process by which the identity of a user is established. This is how a user's identity is established for the IPIC protocol.

For the IPIC protocol you can use basic authentication to identify the user. Specify USERAUTH(VERIFY) or USERAUTH(IDENTIFY) in IPCONN resource definitions. Specify USERAUTH(LOCAL) if you do not want to identify the user.

Authentication

In many systems, the user's authenticity is verified by checking a password supplied by the user.

In a system in which there is no possibility of a password being intercepted, this level of authentication may be sufficient; however, in an insecure network, it is possible that passwords can be intercepted, and used to impersonate legitimate users of the system.

In an environment where your applications may be accessed by users across the internet, and by users who are outside the control of your organization, a more secure method of authentication is required.

On the other hand, there are situations where a limited level of authentication is sufficient. If you have a client system that authenticates its users, and communicates with a server in a secure environment, you may not need to authenticate users at the server, but rely entirely on the client's authentication mechanisms.

CICS supports the following authentication schemes:

Basic authentication

The client's identity is authenticated by a password. This level of authentication is appropriate in an environment where passwords cannot be intercepted and used to impersonate a user.

You can use basic authentication with the HTTP, ECI and IPIC application protocols.

SSL client certificate authentication

The client's identity is authenticated with a client certificate issued by a trusted third party (or Certificate Authority). This level of authentication is appropriate in an environment where information flowing in the network could be intercepted, and used to impersonate a user.

You can use SSL client certificate authentication with the HTTP and IPIC application protocols.

CICS uses password verification to verify a user ID during the processes described here.

CICS enforces a full verification request at the first time each day that a user ID is used to log on to the CICS region or is verified through a **VERIFY PASSWORD** or **VERIFY PHRASE** command. The full verification request records the date and time of last access for the user ID, and writes user statistics. A full verification is also made if an incorrect password or password phrase is entered, and in the next successful request. In other cases, the command request uses a fastpath method to verify the password or password phrase. For details of the SAF interfaces used, see [CICS security control points](#).

Authenticating HTTP users

You can use HTTP basic authentication or SSL client certificate authentication to authenticate HTTP users.

About this task

The authentication scheme is specified by the AUTHENTICATE and SSL attributes of the TCPIPSERVICE definition:

Authentication scheme	AUTHENTICATE	SSL	Notes
HTTP with no authentication	NO	NO, YES, CLIENTAUTH, or ATTLAWARE	
HTTP with basic authentication	BASIC	NO, YES, CLIENTAUTH, or ATTLAWARE	
HTTP with basic authentication	AUTOMATIC	NO, YES, CLIENTAUTH, or ATTLAWARE	If SSL(CLIENTAUTH ATTLAWARE) is specified, and the client sends a certificate, then SSL client certificate authentication is used.

Authentication scheme	AUTHENTICATE	SSL	Notes
HTTP with SSL client certificate authentication	CERTIFICATE or AUTOREGISTER	CLIENTAUTH or ATTLSAWARE	If the client does not send a certificate, the connection is not established.
HTTP with SSL client certificate authentication	AUTOMATIC	CLIENTAUTH or ATTLSAWARE	If the client does not send a certificate, then basic authentication is used.

Authenticating ECI users

For the ECI protocol you can use basic authentication to authenticate the user.

Specify ATTACHSEC(VERIFY) in the TCPIP SERVICE definition for the ECI client. Specify ATTACHSEC(LOCAL) if you do not want to authenticate the user.

Authenticating IPIC users

You can use basic authentication or SSL client certificate authentication to authenticate IPIC users.

For IPIC connections, you can use basic user authentication. Specify USERAUTH(VERIFY) in the IPCONN resource definition. Specify USERAUTH(LOCAL) if you do not want to authenticate the user.

Support for security protocols

CICS supports the Secure Sockets Layer and Transport Layer Security protocols.

Specifically, CICS supports TLS 1.0, TLS 1.1, and TLS 1.2. For more details of these protocols, see the relevant RFC:

TLS 1.0: RFC 2246

TLS 1.1: RFC 4346

TLS 1.2: RFC 5246

Note: The term SSL is used to refer to both the Secure Sockets Layer and Transport Layer Security protocols in the documentation, except where a specific point about either protocol is required.

The main features of these security protocols are:

Privacy

The data to be exchanged between the client and the server is encrypted. See [“SSL encryption” on page 288](#) for more information.

Integrity

Data which is transmitted using the SSL protocols is protected against tampering by a **message authentication code** (MAC). The MAC is computed from the data contents using a secure hashing algorithm and transmitted with the data. It is computed again by the receiver, and compared with the value transmitted by the sender. A mismatch between the two values of the MAC indicates that the data may have been tampered with.

Authentication

SSL uses digital certificates to authenticate servers to clients and, optionally, clients to servers. See [“SSL authentication” on page 289](#) for more information.

SSL encryption

The SSL protocol operates between the application layer and the TCP/IP layer. This allows it to encrypt the data stream itself, which can then be transmitted securely, using any of the application layer protocols.

Many different algorithms can be used for encrypting data, and for computing the message authentication code. Some algorithms provide high levels of security but require a large amount of computation for

encryption and decryption. Other algorithms are less secure but provide rapid encryption and decryption. The length of the key that is used for encryption affects the level of security; the longer the key, the more secure the data. SSL defines cipher suites to specify cryptographic algorithms that are used during an SSL connection.

SSL Encryption techniques

SSL uses two encryption techniques:

- Public key cryptography standard (PKCS), which encrypts and decrypts certificates during the SSL handshake. Encryption keys are created in pairs, a public key and its associated private key. Data encrypted with a given public key can be decrypted only with the associated private key; this means that data is readable by only the intended recipient. Data encrypted with a given private key can be decrypted only with the associated public key; this means that authentication data is assured to originate from the owner of the private key.
- A mutually agreed symmetric encryption technique, such as DES (data encryption standard), or triple DES, is used in the data transfer following the handshake.

PKCS, as used by SSL, works briefly as follows:

1. When a certificate is created, an algorithm based on two random numbers is used to create a private key and public key for the certificate owner. The private and public keys which result are related to each other such that:
 - **It is not feasible to deduce the value of the private key from the public key, nor the public key from the private key**

The private key is stored securely, and is not made known to anyone but its owner. The public key can be made freely available to any user, with no risk of compromising the security of the private key.
 - **Information encrypted using the public key can be decrypted only with the private key**

Information can be encrypted by any user, and sent securely to the holder of the private key. A third party cannot use the public key to read the information.
 - **Information encrypted using the private key can be decrypted only with the public key**

Only the holder of the private key can encrypt information that can be decrypted with the public key. A third party cannot pose as the sender of the information.

SSL authentication

To make an environment secure, you must be sure that any communication is with *trusted* sites whose identity you can be sure of. SSL uses certificates for authentication; these are digitally signed documents which bind the public key to the identity of the private key owner.

Authentication happens at connection time, and is independent of the application or the application protocol. Authentication involves making sure that sites with which you communicate are who they claim to be. With SSL, authentication is performed by an exchange of certificates, which are blocks of data in a format described in ITU-T standard X.509. The X.509 certificates are issued, and digitally signed by an external authority known as a certificate authority.

A certificate contains

- Two **distinguished names**, which uniquely identify the **issuer** (the certificate authority that issued the certificate) and the **subject** (the individual or organization to whom the certificate was issued). The distinguished names contain several optional components:
 - Common name
 - Organizational unit
 - Organization
 - Locality
 - State or Province

- Country
- A digital signature. The signature is created by the certificate authority using the public-key encryption technique:
 1. A secure hashing algorithm is used to create a digest of the certificate's contents.
 2. The digest is encrypted with the certificate authority's private key.

The digital signature assures the receiver that no changes have been made to the certificate since it was issued:

1. The signature is decrypted with the certificate authority's public key.
 2. A new digest of the certificate's contents is made, and compared with the decrypted signature. Any discrepancy indicates that the certificate may have been altered.
- The subject's domain name. The receiver compares this with the actual sender of the certificate.
 - The subject's public key.

Certificates are used to authenticate clients to servers, and servers to clients; the mechanism used is essentially the same in both cases. However, the server certificate is mandatory — that is, the server must send its certificate to the client — but the client certificate is optional: some clients may not support client certificates; other may not have certificates installed. Servers can decide whether to require client authentication for a connection.

Certificate authorities

In order that one system can be assured that a certificate received from another system is genuine, a trusted third party that can vouch for the certificate is needed.

Certificate authorities are independent bodies who act as the trusted third parties, by issuing certificates for use by others. Before issuing a certificate, a certificate authority will examine the credentials of the person or organization that has requested the certificate. When the certificate has been issued, information about it is held on a publicly accessible repository. Users can consult the repository to check the status and validity of any certificates received.

Certificate authorities issue several levels of security certificates for different purposes. For example:

- Secure e-mail
- Client authentication
- Server authentication

CICS can check every certificate it receives from a client for a revoked status by using certificate revocation lists. A certificate revocation list details all the revoked certificates for a particular certificate authority. These lists are freely available to download from the Internet. If the certificate has a revoked status, CICS closes the SSL connection immediately. To find out how to set up certificate revocation lists, see [“Using certificate revocation lists \(CRLs\)”](#) on page 308.

Cipher suites and cipher suite specification files

Many different algorithms can be used for encrypting data, and for computing the message authentication code. To allow users to select the level of security that suits their needs, and to enable communication with others who might have different needs, SSL defines *cipher suites*, or sets of ciphers. You can specify a list of cipher suites to be used during an SSL connection in the SSL cipher suite specification file.

Cipher suites

When an SSL connection is established, during the SSL handshake, the client and server exchange information about which TLS protocols and cipher suites they have in common. They then communicate using the protocol and common cipher suite that offers the highest level of security. If they do not have a protocol or cipher suite in common, then secure communication is not possible and CICS closes the connection.

The cipher suites that are available depend on the value of the system initialization parameters **MINTLSLEVEL** and **NISTSP800131A**, and on what ciphers are supported by z/OS® System SSL. In addition, you can restrict the ciphers that are used by editing the list of cipher suites in the CIPHERS attribute on the appropriate resource definition, or by editing the SSL cipher suite specification file for the resource definition.

You can check which cipher suites are being selected for SSL inbound connections from each CICS region. The performance data field SOCIPHER (320) in the DFH SOCK group shows the code for the cipher suite that was used for each SSL inbound connection. Use this information to identify any cipher suites that are offered by the CICS region but are not being selected for SSL connections. You can also identify any less efficient or less secure cipher suites that are being selected for SSL connections. Then you can decide whether to eliminate such cipher suites.

To specify the level of encryption required:

For inbound HTTP

Use the CIPHERS attribute of the TCPIP SERVICE resource definition.

For outbound HTTP and web service requests

Use the CIPHERS attribute of the URIMAP resource definition.

For inbound IPIC

Use the CIPHERS attribute of the TCPIP SERVICE resource definition.

For outbound IPIC

Use the CIPHERS attribute of the IPCONN resource definition.

For inbound CICSplex SM Web User Interface requests

Use the **TCPIPSSLCIPHERS** Web User Interface server initialization parameter. This value has the same syntax as the CIPHERS attribute of the TCPIP SERVICE resource, but it is limited to a maximum of 22 cipher codes.

The cipher suites that are supported by z/OS and CICS for each supported security protocol are described in [Cipher Suite Definitions in z/OS Cryptographic Services System SSL Programming](#).

SSL cipher suite specification files

The SSL cipher suite specification file is an XML file that contains a list of cipher suites that can be used in an SSL connection. It uses the EBCDIC 037 encoding.

The name of the file can be up to 28 characters in length including the extension, which must be .xml. The specified value is case-sensitive. It must be a valid name for a UNIX file and can contain only the following characters: A-Z a-z 0-9 # - . @ _

The SSL cipher suite specification file must be in the *ussconfig/security/ciphers* directory, where *ussconfig* is the value of the SIT parameter **USSCONFIG**.

The CICS region must have permission to access z/OS UNIX, and it must have read and execute access to the directory that contains the file, and read access to the file itself.

Sample files are provided in the *usshome/security/ciphers* directory, where *usshome* is the value of the SIT parameter **USSHOME**. A schema file is also supplied, in the *usshome/schemas/security* directory. The file name is *ciphersfile.xsd*.

Structure of the SSL cipher suite specification file

Each cipher suite is specified as a **number** attribute of a **cipher** element. The cipher number is a four-character code. If you use a two-character code, pad it with leading zeros.

The sample files also contain a comment for each cipher, which contains a text string that describes the cipher suite. However, CICS does not validate this element nor take any action on it.

The following example shows the structure of the cipher file:

```
<?xml version="1.0"?>
<cipher_list xmlns="http://www.ibm.com/software/http/cics/ciphers">
```

```

<cipher number="000A">
  <!-- SSL_RSA_WITH_3DES_EDE_CBC_SHA -->
</cipher>
<cipher number="000D">
  <!-- SSL_DH_DSS_WITH_3DES_EDE_CBC_SHA -->
</cipher>
...
</cipher_list>

```

The SSL handshake

The *SSL handshake* is an exchange of information that takes place between the client and the server when a connection is established. It is during the handshake that client and server negotiate the encryption algorithms that they will use, and authenticate one another.

The main features of the SSL handshake are:

- The client and server exchange information about the SSL version number and the cipher suites that they both support.
- The server sends its certificate and other information to the client. Some of the information is encrypted with the server's private key. If the client can successfully decrypt the information with the server's public key, it is assured of the server's identity.
- If client authentication is required, the client sends its certificate and other information to the server. Some of the information is encrypted with the client's private key. If the server can successfully decrypt the information with the client's public key, it is assured of the client's identity.
- The client and server exchange random information which each generates and which is used to establish session keys: these are symmetric keys which are used to encrypt and decrypt information during the SSL session. The keys are also used to verify the integrity of the data.

The SSL cache

The SSL cache is used to store session IDs for SSL sessions between clients and CICS. Reusing these session IDs allows CICS to perform partial handshakes with clients that it has previously authenticated. The SSL cache can be local to a CICS region or shared between CICS regions on a sysplex. This is configured by the system initialization parameter **SSLCACHE**. For optimal performance, it is important that you select the correct option.

Local caching, SSLCACHE=CICS

In a local CICS region, by default, the SSL cache is stored in the enclave for the S8 TCBS. It is managed by z/OS System SSL as part of the SSL environment, which exists within this enclave.

When you issue the **PERFORM SSL REBUILD** command for the CICS region, a new cache is created. The new cache is populated by new SSL sessions that are established in the CICS region. The old cache is removed when the last connection using it is dropped.

If you use the **SSLCACHE=CICS** option and use port sharing to enable HTTP connection requests to the same host and port to resolve to different CICS regions, a full SSL handshake is required every time a connection request from a client resolves to a different region, and the benefits of the caching are lost.

Sysplex caching, SSLCACHE=SYSPLEX

Sharing SSL session IDs across different CICS regions on a sysplex is particularly useful when HTTP requests are being routed across a set of CICS regions by using TCP/IP connection workload balancing techniques, such as TCP/IP port sharing or Sysplex Distributor. You should use sysplex caching if you have multiple CICS socket-owning regions that accept SSL connections at the same IP address. If appropriate for your CICS systems, using sysplex caching can significantly reduce the number of full SSL handshakes.

To enable sysplex caching, activate the z/OS System SSL started task GSKSRVR and specify the system initialization parameter **SSLCACHE=SYSPLEX** for the CICS regions. For details of the SSL started task GSKSRVR and its configuration, see [The SSL started task GSKSRVR](#).

The SSLDELAY system initialization parameter should be set to the same value as the GSKSRVR cache timeout. If the CICS SSLDELAY value is smaller the GSKSRVR can return a session ID that is considered to be still valid, but it can be treated as expired by the local CICS region that is handling the current handshake. For details of the SSLDELAY system initialization parameter, see [SSLDELAY system initialization parameter](#).

To use the sysplex session cache, each system in the sysplex must be using the same external security manager, and a user ID on one system in the sysplex must represent the same user on all other systems in the sysplex.

The **PERFORM SSL REBUILD** command does not affect the sysplex cache.

The SSL pool

CICS uses the open transaction environment (OTE) to manage SSL connections and requests to LDAP using the DFHDDAPX XPI interface.

To improve the number and performance of SSL connections in CICS, each SSL connection uses an S8 TCB from the SSL pool. All CICS processing for an SSL connection occurs on the S8 TCB. The web server HTTP attach task (CWXX by default) will stay on the S8 TCB until all the data have been sent or received. If the messages being sent or received are very large, the task could hit the runaway limit and be terminated. To avoid the task being abended, you might need to increase the transaction **RUNAWAY** value for the web server HTTP attach transaction (CWXX by default), the web server alias transactions, and any transactions that issue the web client API commands SEND, RECEIVE, and CONVERSE.

The S8 TCBs are contained in an SSL pool, which is managed by the CICS dispatcher. The S8 TCBs are allocated from the new SSL pool, but are only locked to a transaction for the period that it needs to perform SSL or LDAP functions. After the SSL or LDAP request is complete, the TCB is released back into the SSL pool to be reused. The **MAXSSLTCBS** system initialization parameter specifies the maximum number of S8 open TCBs in the SSL pool. The default value is 8, but you can specify up to 1024.

You can monitor the performance of the SSL pool and the S8 TCBs using the dispatcher reports from DFH0STAT and DFHSTUP. The statistics include information on how often the maximum number of S8 TCBs are reached, the delay before a TCB is allocated and the actual number of TCBs in the SSL pool.

Configuring CICS to use SSL

CICS can use the Secure Sockets Layer (SSL) or the Transport Layer Security (TLS) security protocols to support secure TCP/IP connections. To authenticate servers to clients, create certificates and key rings in RACF and ensure that the CICS region and resources are correctly configured to support security.

Before you begin

Before you begin to configure CICS, decide which type of certificates to use in SSL handshakes.

About this task

You can use RACF to create certificates, but you must configure your clients to ensure that they can recognize the RACF server certificate. If you cannot configure your clients in this way, for example when clients are external to your organization, use a certificate signed by an external certificate authority.

Procedure

1. Set the correct authorizations in RACF to create a key ring, create a signing certificate (certificate authority certificate), and to add certificates to the key ring.
2. Optional: If you decide to use a certificate from a certificate authority, create a certificate request using RACF and send it to the certificate authority.

You might have to wait a number of days to receive a signing certificate from the certificate authority. If your chosen certificate authority does not have its certificate built in to RACF, you might have to import it.

3. Create a key ring.

You must create a key ring in the RACF database. The key ring contains:

- Your public and private keys
 - Your server certificates
 - Signing certificates for the server certificates
 - If the client certificate is not associated with a valid RACF userid, the signing certificates for any client certificates owned by clients with which you expect CICS to communicate using client authentication should be added to the keyring.
4. Create the certificates and add them to the key ring.
 5. Ensure that the CICS region has access to the z/OS system SSL library SIEALNKE.
You can use STEPLIB or JOBLIB statements, or use the system link library.
 6. Define the CICS system initialization parameters that are related to security.
In particular, specify the name of the key ring that you created in the **KEYRING** system initialization parameter.
 7. Define TCPIP SERVICE resources.
You can also specify the level of security for an SSL connection by using the **CIPHERS** attribute. You can specify this attribute either with a string that is interpreted as a list of cipher suite codes or with the name of a cipher suite specification file.

Example

CICS supplies a sample REXX program, DFH\$RING, that contains all of the RACF commands to create a key ring, create a signing certificate, create additional certificates, and add them to the key ring. DFH\$RING contains sample values which are suitable for building a test key ring only. You must edit all the values if you want to create a key ring that is suitable for a production environment.

Setting up profiles in RACF

To build a RACF key ring in the RACF database that is suitable for use in a CICS region, you must grant access to the appropriate profiles in the FACILITY class.

About this task

You must grant this access only to users who administer CICS systems and not to general CICS users. The following profiles are available:

CONTROL

- IRR.DIGTCERT.GENCERT (to allow certificates to be signed by a CERTAUTH certificate)
- IRR.DIGTCERT.ADD on first execution (to allow a CERTAUTH certificate to be generated)
- IRR.DIGTCERT.CONNECT to connect CERTAUTH certificates for other users

UPDATE

- IRR.DIGTCERT.CONNECT (to connect CERTAUTH certificates to your keyring).
- IRR.DIGTCERT.* (to manage certificates for other users).

READ

IRR.DIGTCERT.* (to manage certificates for your own user ID).

IRR.DIGTCERT.* contains the wildcard asterisk, and is intended as a generic profile. To allow generic profiles to be created in the FACILITY class:

Procedure

1. Issue the command **SETROPTS GENERIC(FACILITY)**.
2. Issue the following command:

```
RDEFINE FACILITY(IRR.DIGTCERT.*)
RDEFINE FACILITY(IRR.DIGTCERT.ADD)
RDEFINE FACILITY(IRR.DIGTCERT.CONNECT)
RDEFINE FACILITY(IRR.DIGTCERT.GENCERT)
```

- Depending upon whether the FACILITY class is RACLISTed or not, issue one of the following commands:

```
SETOPTS RACLIST(FACILITY) REFRESH
SETOPTS GENERIC(FACILITY) REFRESH
```

- To permit a user ID or group *ringuser* to use the commands contained in DFH\$RING issue the following commands:

```
PERMIT IRR.DIGTCERT.* CLASS(FACILITY) ID(ringuser) ACCESS(READ)
PERMIT IRR.DIGTCERT.CONNECT CLASS(FACILITY) ID(ringuser) ACCESS(UPDATE) (for self)
PERMIT IRR.DIGTCERT.CONNECT CLASS(FACILITY) ID(ringuser) ACCESS(CONTROL) (for another user)
PERMIT IRR.DIGTCERT.GENCERT CLASS(FACILITY) ID(ringuser) ACCESS(CONTROL)
```

DFH\$RING is the sample that is provided with CICS to help you set up a suitable key ring.

- You must give the first user of DFH\$RING, *certauser*, authority to create a certificate authority certificate:

```
PERMIT IRR.DIGTCERT.ADD CLASS(FACILITY) ID(certauser) ACCESS(CONTROL)
```

This certificate is then used to sign all the other certificates created by DFH\$RING.

Results

If you have READ access to the IRR.DIGTCERT.ADD profile in the FACILITY class, you can add certificate information for your own user ID. If you have UPDATE access to the IRR.DIGTCERT.ADD profile in the FACILITY class, you can add certificate information for other user IDs. If you have RACF SPECIAL authority, you can execute RACDCERT ADD for any user ID.

Requesting a certificate from a certificate authority

You can use RACF to request a signing certificate (certificate authority certificate) from a certificate authority such as Verisign. Use an external certificate to authenticate your server to clients that cannot recognize RACF certificates.

Before you begin

You must have authorization to use the **RACDCERT** command. This command installs and maintains digital certificates, key rings, and digital certificate mappings in RACF.

About this task

RACF supplies certificates for various certificate authorities, so you do not have to define them yourself. These certificates are listed in [Supplied digital certificates in z/OS Security Server RACF Security Administrator's Guide](#).

Procedure

- Create a self-signed certificate in RACF as a placeholder:

```
RACDCERT ID(foruser) GENCERT,
SUBJECTSDN(CN('username')
            T ('username''s certificate')
            OU('department')
            O ('organization')
            L ('city')
            SP('state')
            C ('country'))
NOTBEFORE (DATE(start) TIME(00:00:00))
NOTAFTER (DATE(finish) TIME(23:59:59))
```

```
WITHLABEL(self-signed-certlabel)  
SIZE      (1024)
```

2. Generate a certificate request, based on the placeholder certificate, to send to your external certificate authority. Use the **RACDCERT GENREQ** command:

```
RACDCERT ID(cics-region-userid) GENREQ(LABEL('label'))  
        DSN('request.dataset')
```

where *label* is the placeholder self-signed certificate.

RACF saves the certificate request in the data set specified in the **DSN** parameter.

3. Send the certificate request to the certificate authority, using a method that the certificate authority accepts.
4. When you receive the certificate, save it in a new data set.
5. Optional: If you are using a certificate authority that is not one of the default certificate authorities, for which certificates are already stored in the key database, you must import the certificate authority's certificate into your RACF database.
6. Replace the self-signed certificate with your new CA-signed certificate:

```
RACDCERT ID(cics-region-userid) ADD('response.dataset') TRUST
```

What to do next

Create the key ring in the RACF database and add your CA-signed certificate.

Building a key ring manually

In CICS, the required server certificate and related information about certificate authorities are held in a *key ring* in the RACF database. The key ring contains your system's private and public key pair, together with your server certificate and the certificates for all the certificate authorities that might have signed the certificates you receive from your clients.

Before you begin

Before you can use SSL with CICS, you must create a key ring that contains a private and public key pair and a server certificate. To create a key ring you must have UPDATE authority to the IRR.DIGTCERT.ADDRING resource in the FACILITY class. If you want to share certificates in a key ring between CICS regions, the CICS regions must have the same user ID and the user ID must own the key ring.

About this task

The **RACDCERT** command installs and maintains public key infrastructure (PKI) private keys and certificates in RACF. You can either manually issue the **RACDCERT** command to create a new key ring or you can use the DFH\$RING sample program, see [Building a key ring with certificates using DFH\\$RING](#).

To create a key ring manually, follow these steps:

Procedure

Issue the following **RACDCERT** command:

```
RACDCERT ID(cics-region-userid) ADDRING(ringname)
```

The key ring must be associated with the [CICS region user ID](#).

Results

RACF creates the key ring in the RACF database. If there is a key ring of the same name already in the RACF database, it is replaced with the new key ring.

What to do next

Create a signing certificate (certificate authority certificate) and add it to the key ring.

Building a key ring with certificates using DFH\$RING

DFH\$RING is a sample REXX program that builds a key ring, creates a signing certificate (certificate authority certificate), creates additional certificates, and adds the certificates to the key ring.

Before you begin

You must have the required authorization to run the RACF commands. Your user ID must have CONTROL access to create the signing certificate the first time you run the program. If you run the program again, you require only UPDATE access.

About this task

DFH\$RING is in library CICSTS54.CICS.SDFHSAMP. Edit the values in DFH\$RING to create a suitable key ring and certificates:

Procedure

1. Enter values for the *firstname*, *lastname*, and *hostname* variables.
The *firstname* and *lastname* values are concatenated together to form the name of the key ring. Enter the host name of your Web server for the *hostname* variable.
2. Optional: Enter a value for the *FORUSER* variable if you are building a key ring for a different user ID, such as a CICS region user ID.
3. If you have a signing certificate (certificate authority certificate), enter the label in the *certifier* variable.
4. If you do not have a signing certificate, replace the variables for the **RADCERT CERTAUTH GENCERT** command with suitable values and RACF can create it for you:

```
"RADCERT CERTAUTH GENCERT",
" SUBJECTSDN(CN('CICS Sample Certification Authority' ) ",
              "OU('department' ) ",
              "O ('organization' ) ",
              "L ('city' ) ",
              "SP('state' ) ",
              "C ('country' ) ),",
" NOTBEFORE (DATE("start") TIME(00:00:00) )",
" NOTAFTER  (DATE("finish") TIME(23:59:59) )",
" WITHLABEL("certifier" )",
" SIZE      (1024 )"
```

These values define appropriate fields in the distinguished names of the generated certificates. The country code for the *country* variable must be an ISO 3166-1 code. For a list of valid codes, see [International Organization for Standardization Country Codes - ISO 3166](#). *start* and *finish* determine the validity of the certificate. *certifier* is the label of the self-signed Certificate Authority certificate that is used to sign the other certificates. The **SIZE** parameter specifies the size, in bits, of the private key that is associated with the certificate. The larger the size, the more secure the key. The most common size is 1024.

DFH\$RING creates the signing certificate only if it does not already exist.

5. Edit the variables for the **RADCERT GENCERT** RACF commands to create appropriate certificates to add to your key ring.
DFH\$RING has four examples that you can edit, add to, or remove. Ensure that the *certifier* variable on the **SIGNWITH** parameter matches the label of your signing certificate.
6. Edit the labels for the **RADCERT CONNECT** RACF commands to match your certificates. Ensure that the signing certificate is added to the key ring first, because it signs all the other certificates.
7. Run DFH\$RING to create the key ring and certificates as follows:

```
EXEC 'CICSTS54.CICS.SDFHSAMP(DFH$RING)' 'firstname lastname webservername [ FORUSER(userid) ] '
```

where *userid* is the CICS region user ID.

Results

The DFH\$RING program creates a key ring with name *firstname.lastname* which is owned by the *userid* user ID. Any existing key ring with that name is replaced. If you omit the **FORUSER** parameter, the key ring is owned by the user ID that you used to run the program. DFH\$RING creates a signing certificate if required and adds it to the key ring, followed by the other certificates.

Example

If you run DFH\$RING with the default values, DFH\$RING creates certificates with the following labels:

lastname-Web-Server

This certificate can be used in the CERTIFICATE attribute of TCPIP SERVICES with PROTOCOL(HTTP). The distinguished name within the certificate has a common name of *webservername*, which must be the same as the host name associated with the connection. Web browsers usually check that the common name in the certificate matches the host name of the server from which it is received.

lastname-IP-CONNECTION

This certificate can be used for IP interconnectivity (IPIC). It can be used in CERTIFICATE attributes of resource definitions that are required for a CICS region to use IPIC. This sample certificate is for a CICS region to use as a client certificate and as a server certificate during an SSL handshake that occurs when an IPCONN is acquired. It can be used in the CERTIFICATE attribute of an IPCONN definition for a client certificate and the CERTIFICATE attribute of a TCPIP SERVICE definition with PROTOCOL(IPIC) for a server certificate.

lastname-2048-Certificate

This certificate can be used for CICS systems that require high-strength certificates. It can be used in CERTIFICATE attributes of TCPIP SERVICE, IPCONN, and URIMAP definitions, and EXEC CICS WEB OPEN commands.

lastname-Default-Certificate

This certificate is marked as the default certificate for the key ring and is the one that is used for all TCPIP SERVICE resources that do not specify a CERTIFICATE attribute. This certificate also contains a common name of *webservername*.

Verisign Class 1 Primary CA

Verisign Class 2 Primary CA

IBM World Registry CA

These certificates are required to validate client certificates that you might receive that have been signed by these Certificate Authorities. If you intend to accept client certificates signed by other Certificate Authorities, or certificates that you have created yourself, you will have to add their certificates to the key ring manually, using the **RACDCERT CONNECT** command. When you add a certificate to the key ring in this way, you must specify USAGE(PERSONAL).

What to do next

You can create and add further certificates to the key ring.

Creating new RACF certificates

Use the **RACDCERT** command to create and add new certificates to a key ring.

About this task

The certificates in the key ring must be associated with the CICS region user ID. The key ring must be owned by the CICS region user ID that is making use of it.

Note: Multiple certificates with the same Distinguished Name on the same **KEYRING** are not supported.

Procedure

1. Create a certificate, specifying the CICS region user ID. Enter the **RACDCERT GENCERT** command as follows:
Provide values for the variables. The country code for the *country* variable must be an ISO 3166-1 code. For a list of valid codes, see [International Organization for Standardization Country Codes - ISO 3166](#). The value of *certifier* is the label of the signing certificate in the key ring.

```
RACDCERT ID(foruser) GENCERT
  SUBJECTSDN(CN('username')
             T ('username's certificate')
             OU('department')
             O ('organization')
             L ('city')
             SP('state')
             C ('country'))
  NOTBEFORE (DATE(start) TIME(00:00:00))
  NOTAFTER  (DATE(finish) TIME(23:59:59))
  SIGNWITH (CERTAUTH LABEL('certifier'))
  WITHLABEL ('certlabel')
  SIZE      (1024)
```

2. Add the certificate to the key ring using the RACDCERT CONNECT command.
 - a) If you want to share the certificate across multiple CICS regions, add it to the key ring specified in the **KEYRING** system initialization parameter for that CICS region and specify USAGE(PERSONAL).
Any CICS region that has the same region user ID and is using the same key ring can access the certificate.

```
RACDCERT ID(foruser) CONNECT( RING(ringname) LABEL('label') USAGE('PERSONAL'))
```

- b) If you want to add a certificate to the key ring as the default certificate, add it to the key ring specified in the **KEYRING** system initialization parameter for that CICS region and specify DEFAULT.

```
RACDCERT ID(foruser) CONNECT( RING(ringname) LABEL('label') DEFAULT)
```

When a client or server requests a certificate from CICS, the default certificate is used unless you have specified otherwise. For inbound HTTP requests, specify the certificate in the TCPIPSERVICE resource.

3. After running any of the RACDCERT commands that update certificates or key rings, if the DIGTCERT and DIGTRING classes are RACLISTed, you must issue the following command:

```
SETROPTS RACLIST(DIGTCERT DIGTRING) REFRESH
```

4. After you make any updates or additions to the certificates in the key ring, issue the **PERFORM SSL REBUILD** command for the CICS region.
The command rebuilds the SSL environment for the CICS region and refreshes the cache of certificates with the new information from the key ring.

Associating a RACF user ID with a certificate

The client certificate can only be used to determine the user ID for the CICS transaction if the certificate is associated with a RACF user ID.

You can associate a certificate with a RACF user ID in two ways:

- Users can register their certificates online through their web browser program. You enable clients to register their certificates themselves by specifying AUTHENTICATE(AUTOREGISTER) on the TCPIPSERVICE definition. Users connecting to CICS through such a TCPIPSERVICE must have a client certificate. If that certificate is already registered to a user ID, then that user ID is used; if not, the client is prompted for a user ID and password with HTTP basic authentication. If the client then enters a valid user ID and password, that user ID is registered to the certificate, and the client will not be prompted for a password again. The rules are summarized in [“Identifying HTTP users” on page 284](#).

Once a certificate has been registered in this way, it can be used for all inbound TCP/IP connections.

- You can use the RACDCERT command. If you do not want to allow your clients to register their own certificates, you must register them with the RACDCERT command. Before executing RACDCERT, you must download the certificate that you want to process into an MVS sequential file with RECFM=VB that is accessible from TSO. The syntax of RACDCERT is:

```
RACDCERT ADD('datasetname') TRUST [ ID(userid) ]
```

where *datasetname* is the name of the data set containing the client certificate, and *userid* is the user ID that is to be associated with the certificate. If the optional ID(userid) parameter is omitted, the certificate is associated with the user issuing the RACDCERT command.

You can add certificate information for your own user ID if you have READ access to the IRR.DIGTCERT.ADD profile in the FACILITY class. You can add certificate information for other user IDs if you have UPDATE access to the IRR.DIGTCERT.ADD profile in the FACILITY class or if you have RACF SPECIAL authority.

For further information on the RACDCERT command, including the format of data allowed in the downloaded certificate data set, see [z/OS Security Server RACF Command Language Reference](#).

Using an existing certificate that is not owned by the CICS region user ID

You can share a single certificate between CICS systems by using the appropriate RACF facilities.

About this task

For any CICS resource that has the CERTIFICATE attribute and for Web Services Security, by default the certificate that is used must be owned by the CICS region user ID. If CICS needs to use a certificate that it does not own, for example a single certificate that is shared by multiple CICS systems where each system has a different region user ID, you can use the RACF Facility Class RDATA LIB to allow multiple CICS systems to share a single certificate.

Procedure

1. Connect the certificate to its key ring with the PERSONAL usage option.
2. If the certificate is a USER certificate, grant to the CICS region user ID that you want to use the certificate UPDATE authority for the *ring_owner.ring_name.LST* resource in the RDATA LIB class.
3. Activate the RDATA LIB class by using the **RACLIST** command.

Results

CICS can use the certificate that is owned by the other user ID. For more information, see [z/OS Security Server RACF Callable Services](#).

Configuring a RACF site certificate for use with CICS TS

If you want to enable SSL in your CICS Transaction Server for z/OS regions, but you do not want to define separate SSL Certificates for each region, you can use a *site certificate*.

Procedure

Build a keyring by following the instructions in [“Building a key ring manually” on page 296](#) or [“Building a key ring with certificates using DFH\\$RING” on page 297](#).

The key ring must be completely configured, that is, it must contain not only the certificate pointed to by your TCPIPSERVICE RDO definition, but also every certificate that was used to sign that certificate. These signing certificates must be in the KEYRING with USAGE=CERTAUTH.

The following figure shows an example of a completely configured key ring as listed by the RACF command: RACDCERT ID(*ring_owner*) LISTRING(*ring_name*)

```
Ring: ring_name
```

Certificate Label Name	Cert Owner	USAGE	DEFAULT
Verisign Class 1 Primary CA	CERTAUTH	CERTAUTH	NO
IBM World Registry CA	CERTAUTH	CERTAUTH	NO
CICS-Sample-Certification	CERTAUTH	CERTAUTH	NO
Verisign Class 2 Primary CA	CERTAUTH	CERTAUTH	NO
SITECERT	SITE	PERSONAL	YES

The certificate that you want to use as a site certificate (SITECERT) must be owned by SITE and have a usage of PERSONAL. This certificate is the one used by any TCPIP SERVICE definition that needs SSL encryption.

The key ring must be owned by the CICS region user ID. If multiple CICS regions use the same region user ID, they can share the same key ring. If they run under different region user IDs, then you must build separate key rings. However, you can use the same site certificate in each ring.

The site certificate must have a private key or the TCPIP SERVICE will either fail to install or will fail when an attempt is made to use it.

The CICS region user ID must have CONTROL access or greater to the profile IRR.DIGTCERT.GENCERT in the FACILITY class.

For more information, see the sections about RACF Callable Services Authorization and RACF Callable Services Usage Notes in [z/OS Security Server RACF Callable Services](#).

Making a certificate untrusted

If a certificate has been registered in the RACF database, but you do not want it to be used by clients, you can mark it as UNTRUSTED using the RACDCERT command.

Procedure

1. Enter the command `RACDCERT ID(userid) LIST` to find the label associated with the certificate.
2. Enter the command `RACDCERT ID (userid) ALTER(LABEL(label)) NOTRUST` to mark the certificate as untrusted.
3. If you amended the certificate while a running CICS region was using a key ring containing the certificate, issue the `PERFORM SSL REBUILD` command for the CICS region.

The command rebuilds the SSL environment for the CICS region and refreshes the cache of certificates with the new information from the key ring.

Note: The **PERFORM SSL REBUILD** command does not apply to SSL/TLS environments where CICS is using a TCPIP SERVICE that is defined with `SSL(ATTLISAWARE)`, mandating AT-TLS secured client connections. If you want to refresh such SSL environments and cache, follow the instructions in [Introduction to Application Transparent Transport Layer Security \(AT-TLS\)](#).

Results

Clients are prevented from establishing CLIENTAUTH connections with this certificate.

System initialization parameters for SSL

Descriptions of system initialization parameters that relate to SSL.

The following system initialization parameters relate to SSL:

CRLPROFILE system initialization parameter

Specifies the name of the profile that authorizes CICS to access certificate revocation lists that are stored in an LDAP server. For more information about certificate revocation lists and setting up this profile, see [“Configuring an LDAP server for CRLs” on page 308](#).

KEYRING system initialization parameter

Specifies the name of a key ring in the RACF database that contains keys and certificates used by CICS. It must be owned by the *CICS region user ID*. You can create an initial key ring with the `DFH$RING` exec in `CICSTS54.CICS.SDFHSAMP`.

MAXSSLTCBS system initialization parameter

Specifies the maximum number of S8 TCBS that are available to CICS to process secure sockets layer connections and requests to LDAP using the DFHDDAPX XPI interface. This value is a number in the range 0 through 999, and has a default value of 8. The S8 TCBS are created and managed in the SSL pool. An S8 TCB is used by a task only for the duration of the SSL or LDAP processing.

MINTLSLEVEL system initialization parameter

Specifies the minimum TLS protocol that CICS uses for secure TCP/IP connections.

SSLCACHE system initialization parameter

Specifies whether CICS should use a local cache of SSL sessions for the CICS region, or share the cache across multiple CICS regions by using the coupling facility. Caching across a sysplex can only take place when the regions accept SSL connections at the same IP address. The cache contains session IDs that enable CICS to perform partial handshakes with clients that it has previously authenticated. A local cache is replaced when you issue the PERFORM SSL REBUILD command for the CICS region, but a sysplex cache is unaffected.

SSLDELAY system initialization parameter

Specifies the length of time in seconds for which CICS retains session IDs for secure socket connections in a local CICS region. Session IDs are tokens that represent a secure connection between a client and an SSL server. While the session ID is retained by CICS within the SSLDELAY period, CICS can continue to communicate with the client without the significant overhead of an SSL handshake. The value is a number of seconds in the range 0 through 86400. The default value is 600.

TCPIPSERVICE attributes for SSL

Descriptions of the attributes of the TCPIPSERVICE resource that relate to SSL.

About this task

The following attributes of the [TCPIPSERVICE](#) resource relate to SSL:

AUTHENTICATE

Specifies the authentication and identification scheme to be used for inbound TCP/IP connections for the HTTP protocol. The HTTP protocol supports the following authentication scheme:

NO

The client is not required to send authentication or identification information.

BASIC

HTTP basic authentication is used to obtain a user ID and password from the client.

CERTIFICATE

SSL client certificate authentication is used to authenticate and identify the client.

AUTOREGISTER

SSL client certificate authentication is used to authenticate the client. If the client sends a valid certificate that is not registered to the security manager, then CICS will register the certificate.

AUTOMATIC

If the client sends a certificate, SSL client certificate authentication is used to authenticate the client. If the client sends a valid certificate that is not registered to the security manager, then CICS will register the certificate. If the client does not send a certificate, then HTTP Basic authentication is used to obtain a user ID and password from the client.

CERTIFICATE

Specifies the label of the server certificate used during the SSL handshake. If this attribute is omitted, the default certificate defined in the key ring for the CICS region user ID is used.

CIPHERS

The CIPHERS attribute can be specified in either of two ways:

- **Recommended:** The name of the SSL cipher suite specification file, which is a z/OS UNIX file in the `security/ciphers` subdirectory of the directory that is specified by the **USSCONFIG** system initialization parameter. For example, if **USSCONFIG** is set to `/var/cicsts/dfhconfig`

and **CIPHERS** is set to `strongciphers.xml`, the fully qualified file name is `/var/cicsts/dfhconfig/security/ciphers/strongciphers.xml`. For more information, see [Creating an SSL cipher suite specification file](#).

- A string of up to 56 hexadecimal digits that is interpreted as a list of up to 28 2-digit cipher suite codes.

When you use the CEDA transaction to define the resource, CICS automatically initializes the attribute with a default list of acceptable codes. For CICS to initialize the attribute, the KEYRING system initialization parameter must be specified in the CICS region where you are running CEDA. If KEYRING is not set, CICS does not initialize the attribute. The default list of 2-digit ciphers is 3538392F3233.

You can reorder the cipher codes or remove them from the initial list. However, you cannot add cipher codes that are not in the default list for the specified encryption level. To reset the value to the default list of codes, delete all of the cipher suite codes. The field is automatically repopulated with the default list.

When you use DFHCSDUP to define the resource, the CIPHERS attribute is not populated with a default value. If the resource is used to establish a secure connection and the CIPHERS attribute is empty, CICS uses the default list of 2-digit ciphers. An INQUIRE on the resource that is created in this manner, returns an empty string for the CIPHERS value.

Any unsupported ciphers are removed at run time. A list of the removed ciphers is reported in messages DFHSO0145 and DFHSO0146.

For more information, see [Cipher suites and cipher suite specification files](#).

PORTNUMBER

Specifies the number of the port on which CICS is to listen for incoming client requests. The well known port for SSL services supported by CICS is 443, for HTTP with SSL.

SSL

Specifies whether the TCP/IP service is to use SSL for encryption and authentication:

NO

SSL is not to be used.

YES

An SSL session is to be used; CICS will send a server certificate to the client.

CLIENTAUTH

An SSL session is to be used; CICS will send a server certificate to the client, and the client must send a client certificate to CICS.

ATTLISAWARE

CICS queries the client connection to determine whether AT-TLS is active. CICS retrieves a client certificate from TCP/IP if one was provided by the partner.

Note: If you specify SSL(ATTLISAWARE), you must also specify PROTOCL(HTTP).

Creating an SSL cipher suite specification file

You can create an SSL cipher suite specification file to specify a list of cipher suites to be used by SSL. If SSL is used for TCP/IP connections, you can specify the name of cipher suite specification file in the **CIPHERS** attribute for resources that define TCP/IP connections.

Procedure

1. Create an SSL cipher suite specification file either by editing a sample specification file or by creating your own one:
 - To modify a sample SSL cipher suite specification file, copy one of the sample files located in the `ussHOME/security/ciphers` directory to the `ussconfig/security/ciphers` directory, where

usshome

is the value of the SIT parameter **USSHOME**.

ussconfig

is the value of the SIT parameter **USSCONFIG**.

Note: The SSL cipher suite specification file must be in the *ussconfig/security/ciphers* directory.

- To create your own SSL cipher suite specification file, create an XML file in the *ussconfig/security/ciphers* directory and name the file according to the following rules:
 - The file name is up to 28 characters in length, including the `.xml` extension.
 - The file name must be a valid name for a UNIX file and contain only characters A-Z a-z 0-9 # - . @ _ . It is case-sensitive.
- 2. Specify your list of cipher suites in the specification file as indicated in [Cipher suites and cipher suite specification files](#).

If you edit the sample file, you can remove unwanted cipher suites that do not meet your security requirements, or that are not supported by your hardware. You can also add cipher suites, but only those cipher suites that are supported by z/OS.
- 3. For the file to be effective in an SSL connection, ensure that the CICS region has permission to access z/OS UNIX, and that the region has read and execute access to the directory that contains the specification file, and read access to the file itself.

Results

You have created a cipher suite specification file. An SSL cipher suite file can be used by multiple resources. The first time when a resource that uses a specification file is installed, the file is read from zFS and parsed. Any errors are flagged during this parse. If the file is valid, the resource is installed and the cipher information is stored in a new control block that is associated with the file. When subsequent resources that use the same cipher file are installed, cached information in the control block is used.

What to do next

If you want to update the list of cipher suites in a cipher suite specification file, you can edit the file directly, but you must restart CICS for the updated list to take effect. The file is reread for any type of start, whether the **START** system initialization parameter is set to INITIAL, COLD, or AUTO.

To update the list of cipher suites for a resource without restarting CICS, you must use a new specification file:

1. Create a new cipher suite specification file. Ensure that the file name has not been loaded by this CICS system.
2. Update the existing resource definition to refer to the new file. For example, issue a **CREATE TCPIPSERVICE** command with `CIPHERS(newciphers.xml)` specified.
3. Reinstall the resource definition.

Customizing encryption negotiations

You can select the cipher suites that are used in the encryption negotiation process for SSL connections, to set a minimum level and a maximum level of encryption.

About this task

The CIPHERS attribute in the resource definitions TCPIPSERVICE, IPCONN, and URIMAP specifies the cipher suites that can be used for each encryption level. The default value of the attribute is the list of 2-digit codes for the cipher suites that are used in encryption negotiations. You have the option of customizing this list of cipher suites to include your order of preference for the encryption levels at which

CICS negotiates with clients. You can also choose to remove cipher suites from the list. This option is useful if you want to ensure that only a very high level of encryption is used.

You can customize the list either by editing the list of codes directly or by setting the CIPHERS attribute to the name of an SSL cipher suite specification file, in which you have specified the cipher suites to be used. The SSL cipher suite specification file is a z/OS UNIX file in the `security/ciphers` subdirectory of the directory that is specified by the **USSCONFIG** system initialization parameter. For more information, see [Creating an SSL cipher suite specification file](#)

You can check which cipher suites are being selected for SSL inbound connections from each CICS region. The performance data field SOCIPHER (320) in the DFH SOCK group shows the code for the cipher suite that was used for each SSL inbound connection. Use this information to identify any cipher suites that are offered by the CICS region but are not being selected for SSL connections. You can also identify any less efficient or less secure cipher suites that are being selected for SSL connections. Then you can decide whether to eliminate such cipher suites.

For a list of cipher suites that are supported by CICS and z/OS, see [Cipher suites and cipher suite specification files](#).

Procedure

1. Select the resource definition that you want to change.

The CIPHERS attribute displays the default value. For CICS to display the default value, the **KEYRING** system initialization parameter must be specified in the CICS region where you are working with the resource definition.

2. Edit the attribute value to remove and reorder the cipher suites or to specify the name of the SSL cipher suite specification file.

For example, you could specify `352F0A` or `strongciphers.xml`

3. Save the resource definition.

Example

Specifying `352F0A` means that CICS does not negotiate below 128-bit encryption for SSL connections that use this resource. Each of the 2-digit codes in the attribute, for example 35, 2F, and 0A, refers to cipher suites that have at least 128-bit encryption. CICS starts by trying to negotiate using the AES cipher suites 35 and 2F, because these cipher codes are first in the list. If the client does not have this level of encryption, CICS closes the connection.

Specifying `strongciphers.xml` means that CICS uses the ciphers listed in the cipher file located at `ussconfig/security/ciphers/strongciphers.xml`, where `ussconfig` is the value of the SIT parameter **USSCONFIG**.

Making your CICS TS system conformant to NIST SP800-131A

To make your system SP800-131A conformant, update various SIT parameters and resource attributes to use suitable cipher suites and certificates.

About this task

Conformance to the National Institute of Standards and Technology (NIST) SP800-131A security standard strengthens security by requiring the use of stronger cryptographic keys and more robust algorithms.

For full details of the NIST standards, see the [NIST Computer Security Resource Center \(nist.gov\)](#).

Procedure

To make your system conformant to NIST SP800-131A, complete the following steps:

1. Set the **NISTSP800131A** system initialization parameter to `NISTSP800131A=CHECK`.

2. Set the **MINTLSLEVEL** system initialization parameter to TLS12.
3. Set the **KEYRING** system initialization parameter to the name of a key ring that is populated with NIST SP800-131A conformant certificates.
4. Set the **USSCONFIG** system initialization parameter to the name and path of the root directory for CICS Transaction Server configuration files on z/OS UNIX.
This directory must have a `/security/ciphers/` subdirectory that contains at least one SSL cipher suite specification file. For more information, see [“Cipher suites and cipher suite specification files” on page 290](#).
5. Update any TCPIP SERVICE, IPCONN, or URIMAP definitions, setting the **CIPHERS** attribute to the name of an SSL cipher suite specification file that contains SP800-131A conformant cipher suites.
The sample file `fipsciphers.xml` is suitable.
6. Update any TCPIP SERVICE, IPCONN, or URIMAP definitions, setting the **CERTIFICATE** attribute to the name of an SP800-131A conformant certificate label.
Also, any outbound HTTP application that uses SSL must also use an SP800-131A conformant certificate on any **EXEC CICS WEB OPEN** command. If you use the key ring default certificate with any of these resources definitions or the **WEB OPEN** command, ensure that the key ring default certificate is SP800-131A conformant.
7. If you use the CICSplex SM Web User Interface (WUI) to connect to CICS, set the **TCPIPSSLCIPHERS** WUI server initialization parameter to the name of an SSL cipher suite specification file that contains SP800-131A conformant cipher suites.
The sample file `fipsciphers.xml` is suitable.
8. If you use the CICSplex SM WUI to connect to CICS, set the **TCPIPSSLCERT** WUI server initialization parameter to the name of an SP800-131A conformant certificate label.
If you use the key ring default certificate, ensure that it is SP800-131A conformant.

What to do next

Any clients that connect to CICS must be SP800-131A-conformant and must support TLS 1.2. To be conformant, they must be capable of using SP800-131A conformant cipher suites and, if they use certificates, SP800-131A conformant certificates.

Any partner CICS system must use `MINTLSLEVEL=TLS12` or `ENCRYPTION=ALL` to talk to an `MINTLSLEVEL=TLS12` system and it must be configured to use cipher suites and certificates that are SP800-131A conformant.

Note: If you set `NISTSP800131A=CHECK`, CICS takes the following actions:

- When a JVM server is started, CICS sets the Java properties to make Java NIST SP800-131A conformant.
- If you use SAML and sign outbound messages, CICS issues message DFHXS1300 to warn you to check that the certificates used are conformant.
- If you use WS-Security, CICS issues message DFHXS1301 because CICS support of WS-Security is not conformant with NIST SP800-131A.
- When a TCPIP SERVICE defined with `SSL(ATTLSAWARE)` is opened, CICS issues message DFHSO0148 to warn you that the AT-TLS policy used to secure this TCPIP SERVICE must be conformant with **NIST SP800-131A**. See [AT-TLS policy configuration in z/OS Communications Server: IP Configuration Guide](#).

Configuring LDAP for CICS use

You can use LDAP for storing CRLs (certificate revocation lists) or Basic Authentication credentials. When certificate revocation lists or credentials are stored in the LDAP server, you must authorize CICS to access them.

About this task

Certificate revocation lists and passwords are stored in the LDAP server with an access class of *critical* and can only be accessed by a user who has provided authentication credentials at LDAP bind time. These credentials are a user's distinguished name and an associated password. You can save these details in a specialized profile in the LDAPBIND RACF class. To set up the profile, follow these steps:

Procedure

1. The password that is used in the profile must be encrypted before it is stored in the RACF database. To encrypt the password, you must store a password encryption key in the KEYSMSTR RACF class by issuing one of the following RACF commands:

- ```
RDEFINE KEYSMSTR LDAP.BINDPW.KEY OWNER(userid)
SSIGNON(KEYENCRYPTED(keyvalue))
```

Use this command when the password encryption key is stored by the integrated cryptographic service facility (ICSF).

- ```
RDEFINE KEYSMSTR LDAP.BINDPW.KEY OWNER(userid)
SSIGNON(KEYMASKED(keymask))
```

Use this command when ICSF is not active.

2. Create the profile using the following RACF command:

```
RDEFINE LDAPBIND profile-name
PROXY(LDAPHOST(ldap-url)
      BINDDN('ldap-distinguished-name')
      BINDPW(password))
UACC(NONE)
```

where:

profile-name

is the name of the RACF profile whose PROXY segment contains the following LDAP bind parameters.

ldap-url

is a fully qualified URL of the LDAP server to be accessed; for example, LDAP://EXAMPLE.COM:3389.

ldap-distinguished-name

is the distinguished name of an LDAP user authorized to inquire on certificate revocation list attributes from the server; for example, CN=LDAPADMIN.

password

is the password that authenticates the LDAP user. The password is case-sensitive.

3. Authorize each CICS region user ID to access appropriate bind credentials in the LDAPBIND class by issuing one or more commands of the following form:

```
PERMIT profile-name CLASS(LDAPBIND)
ACCESS(READ)
ID(region-userid)
```

4. Specify the profile name in the system initialization parameter **CRLPROFILE** for each applicable CICS region.

Results

When you start a CICS region with the profile name specified in the **CRLPROFILE** system initialization parameter, the bind information for the LDAP server is cached in the SSL environment for the CICS region, which is managed by z/OS System SSL. When you issue the PERFORM SSL REBUILD command for the CICS region, the bind information for the LDAP server is refreshed from the external security manager.

What to do next

If the **CRLPROFILE** parameter is specified for a CICS region but is invalid, or if the specified profile contains invalid data, or if the LDAP server identified by the profile is unavailable when the CICS region starts, the CICS region disables its own access to the LDAP server. Messages DFHSO0128 and DFHSO0129 report this problem.

To restore access, you must fix the error and restart the CICS region. The PERFORM SSL REBUILD command cannot restore access to the LDAP server if the CICS region has disabled it. The refresh only takes place for an LDAP server that was available to the CICS region at the time when the command was issued.

Using certificate revocation lists (CRLs)

You can configure CICS to use certificate revocation lists (CRLs) to check the validity of client certificates being used in SSL negotiations.

Before you begin

To use certificate revocation lists, you must install and configure an LDAP server. See [z/OS Cryptographic Services PKI Services Guide and Reference](#). You also need to authorize CICS to access the LDAP server, as described in [Configuring LDAP for CICS use](#).

About this task

A certificate revocation list details the revoked certificates from a certificate authority. Certificate authorities keep these lists in CRL repositories that are available on the World Wide Web and can be downloaded and stored in an LDAP server. To populate the LDAP server and update certificate revocation lists, use the CICS-supplied transaction CCRL.

Configuring an LDAP server for CRLs

To use certificate revocation lists (CRLs), you must have an LDAP server running. You will also need to perform some configuration steps before you download the CRLs.

Before you begin

If you need to install and configure an LDAP server, see [z/OS Cryptographic Services PKI Services Guide and Reference](#).

About this task

Procedure

1. Ensure that the LDAP server is running. The default started task name is LDAPSRV.
2. In the file system in `etc/ldap`, edit the configuration file `slapd.conf` as follows:
 - a) Create an administrator distinguished name and password, by providing values for `adminDN` and `adminPW`.

The CICS-supplied CCRL transaction requires this information to update the LDAP server with the certificate revocation lists.
 - b) Create a suffix entry for every certificate authority that you want to download CRLs from using CCRL. For each suffix, use the syntax "`O=certificate authority`".

The suffix is comprised of the Certificate Authority's distinguished name that contains the organization or "O=" keyword, together with any other keywords to the right of this. If the suffix contains any of the special characters <, +; > \ " you must escape them by using **two** backslash characters. If you are using the z/OS LDAP server and the suffix contains any characters that are not in the required 1047 code page, the characters should be escaped by encoding them as the 3-digit octal number of their Unicode representation, preceded by an ampersand.

Example

For example you could specify the following suffixes in the file slapd.conf:

```
suffix "O=CompanyName"  
suffix "O=CompanyName plc"  
suffix "O=CompanyName,L=CompanyLocation,ST=CompanyArea,C=CompanyCountry"  
suffix "O=CompanyName\\, Inc."  
suffix "O=CompanyName\\, Inc.,C=CompanyCountry"
```

What to do next

When you have configured the LDAP server to include all of your certificate authorities, run the CCRL transaction. For details, see [“Running the CCRL transaction” on page 309](#).

Running the CCRL transaction

The CICS-supplied transaction CCRL allows you to download and store certificate revocation lists (CRLs) that can be used in the SSL handshake to determine if client certificates are valid.

Before you begin

You need to configure an LDAP server to specify which certificate authorities you want to use and to create an administrator id and password. See [“Configuring an LDAP server for CRLs” on page 308](#) for detailed instructions.

About this task

Certificate revocation lists are available from certificate authorities such as Verisign. They are kept in CRL repositories that are available on the World Wide Web and can be downloaded and stored in an LDAP server. To populate the LDAP server and update certificate revocation lists, use the CICS-supplied transaction CCRL. You can run the CCRL transaction from a terminal or using a **START** command. Use the **START** command to schedule regular updates.

Procedure

1. Specify the name of the LDAP server in the system initialization parameter **CRLPROFILE**.
2. Run the CCRL transaction
 - from a terminal. See [“Running CCRL from a terminal” on page 309](#).
 - using a command. See [“Running CCRL from a START command” on page 310](#).

Running CCRL from a terminal

You can run the CICS-supplied transaction CCRL using a terminal to download certificate revocation lists (CRLs).

Before you begin

Read [“Running the CCRL transaction” on page 309](#) to find out about the prerequisites before running this transaction from a terminal.

Procedure

1. From a terminal, enter the command `CEOT TRANIDONLY` so that you can enter the list of URLs in mixed case.
2. Enter `CCRL url-list`, where *url-list* is the URL that specifies the location of the certificate revocation list file that you want to download. You can specify more than one URL by leaving a space between each URL in the list.
For example, you could specify: `CCRL http://crl.verisign.com/ATTCClass1Individual.crl http://crl.verisign.com/ATTCClass2Individual.crl`
3. You are prompted to enter the administrator distinguished name and password for the LDAP server. This allows CICS to update the LDAP server with the CRLs that it downloads.
The administrator name and password are specified in the file `slapd.conf`. For more information about configuring this file, see [“Configuring an LDAP server for CRLs” on page 308](#)

Results

CICS downloads the CRLs from the URLs that you have specified and store them in the LDAP server. You will receive confirmation that all of the lists were downloaded. If CICS experiences a problem, for example the URL is not valid, you will receive an error message.

What to do next

To set up regular updates, you can use a START command. See [“Running CCRL from a START command” on page 310](#).

Running CCRL from a START command

You can schedule the CCRL transaction to run at regular intervals using a START command.

Before you begin

Read [“Running the CCRL transaction” on page 309](#) to find out about the prerequisites before running this transaction from a terminal.

Procedure

- To use a START command, enter `EXEC CICS START TRANSID(CCRL) FROM (admin://adminDN:adminPW url-list) LENGTH (url-list-length) [INTERVAL(hhmmss) | TIME(hhmmss)]` where *url-list* is a space-delimited list of URLs from where certificate revocation lists can be downloaded, *url-list-length* is the length of the URL list (including `admin://`), and *hhmmss* is the interval or expiration time at which the CCRL transaction is to be scheduled.
For example, you could specify:

```
EXEC CICS START TRANSID(CCRL)
FROM('admin://cn=ldapadmin:cics31ldap
http://crl.verisign.com/ATTCClass1Individual.crl
http://crl.verisign.com/ATTCClass2Individual.crl')
LENGTH(124) INTERVAL(960000)
```

This example schedules the CCRL transaction to run in 96 hours.

Chapter 8. Security for data sources

Security for DB2

In the CICS DB2 environment, there are four main stages at which you can implement security checking.

The four stages are:

- When a CICS user signs on to a CICS region. CICS sign-on authenticates users by checking that they supply a valid user ID and password..
- When a CICS user tries to use or modify a CICS resource that is related to DB2. This could be a DB2CONN, DB2ENTRY or DB2TRAN resource definition; or a CICS transaction that accesses DB2 to obtain data; or a CICS transaction that issues commands to the CICS DB2 attachment facility or to DB2 itself. At this stage, you can use CICS security mechanisms, which are managed by RACF or an equivalent external security manager, to control the CICS user's access to the resource.
- When the CICS region connects to DB2, and when a transaction acquires a thread into DB2. Both the CICS region and the transaction must provide authorization IDs to DB2, and these authorization IDs are validated by RACF or an equivalent external security manager.
- When a CICS user tries to use a CICS transaction to execute or modify a DB2 resource. This could be a plan, or a DB2 command, or a resource that is needed to execute dynamic SQL. At this stage, you can use DB2's security checking, which is managed either by DB2 itself, or by RACF or an equivalent external security manager, to control the CICS user's access to the resource.

You can also use RACF, or an equivalent external security manager, to protect the components that make up CICS and DB2 from unauthorized access. You can apply this protection to DB2 databases, logs, bootstrap data sets (BSDSs), and libraries outside the scope of DB2, and to CICS data sets and libraries. You can use VSAM password protection as a partial replacement for the protection provided by RACF. For more information, see [CICS system resource security](#).

Note: RACF is referred to here as the external security manager used by CICS. Except for the explicit RACF examples, the general discussion applies equally to any functionally equivalent non-IBM external security manager.

[Figure 27 on page 312](#) shows the security mechanisms involved in a CICS DB2 environment.

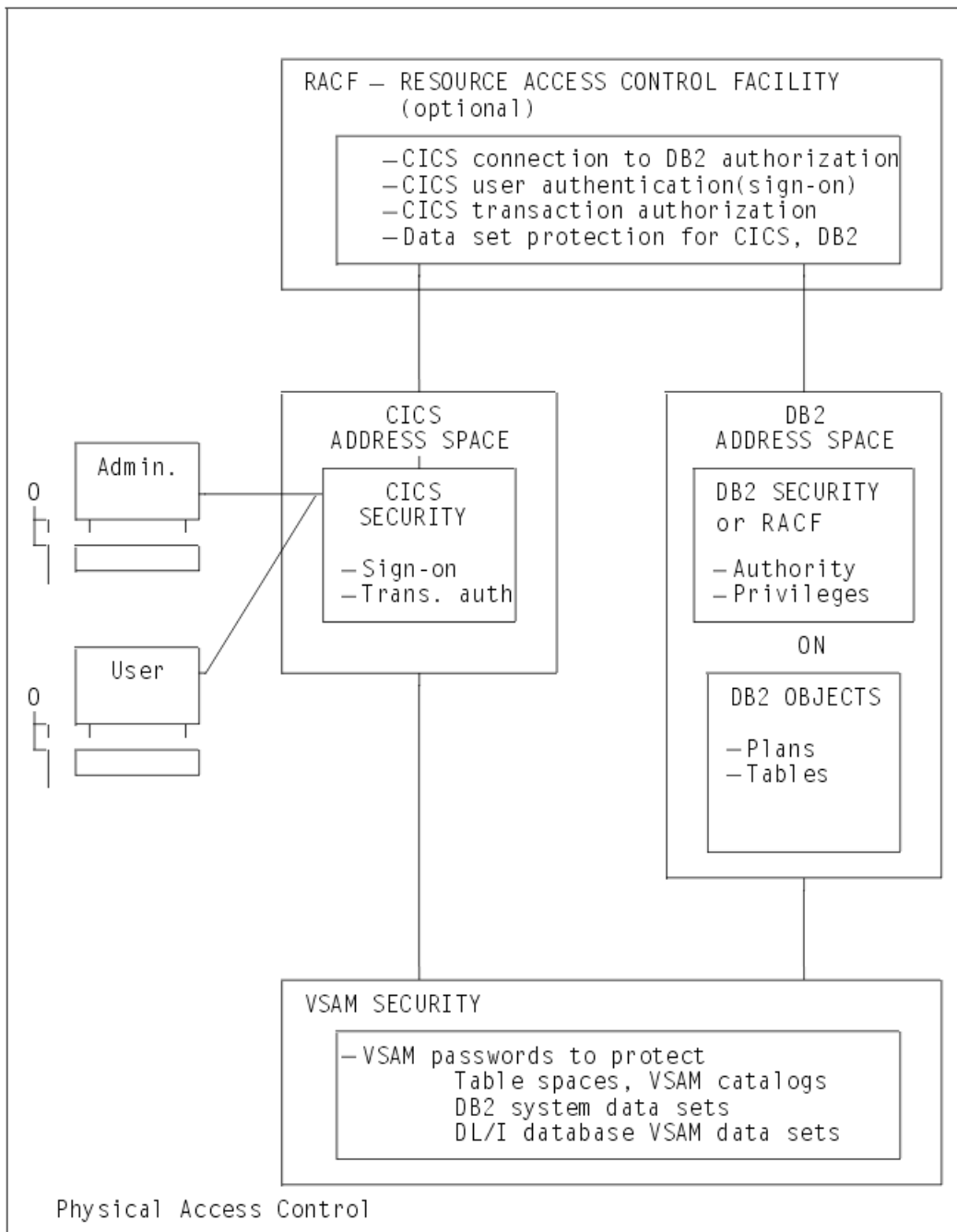

Figure 27. Overview of the CICS DB2 security mechanisms

Controlling access to DB2-related resources in CICS

You can control access to DB2 resources in your CICS region, and initiate security checking for the resources, by enabling an external security manager and the appropriate CICS security mechanism.

About this task

CICS users might want to perform the following activities involving DB2:

- Inquire on, modify, create or discard DB2CONN, DB2ENTRY, and DB2TRAN resource definitions.
- Use a transaction that accesses DB2 to obtain data, or issue CICS DB2 attachment facility commands or DB2 commands using the DSNB transaction.

Use RACF, or an equivalent external security manager to perform security checks in your CICS region. When a user tries to access protected resources, CICS calls the external security manager to perform security checking. RACF makes security checks using the CICS user's ID, which is authenticated when the user signs on to CICS. If a user does not sign on to CICS, they are given the default user ID, unless a user ID has been permanently associated with a terminal using preset security.

Enabling the appropriate security mechanism for your CICS region: transaction-attach security, resource security, command security, or surrogate security.

For more information about CICS security, see [Securing overview](#).

Controlling users' access to DB2CONN, DB2TRAN, and DB2ENTRY resource definitions

You can control users' access to DB2CONN, DB2TRAN, and DB2ENTRY resource definitions by enabling different CICS security mechanisms.

About this task

The following security mechanisms can be used to control user access to DB2 resource definitions.

- Control users' ability to access particular resources by using the CICS **resource security** mechanism. Resource security is implemented at the transaction level. For example, you could prevent some users from modifying a particular DB2ENTRY definition. [“Using resource security to control access to DB2ENTRY and DB2TRAN resource definitions” on page 313](#) tells you how to use this security mechanism.
- Control users' ability to issue particular SPI commands against DB2-related resources by using the CICS **command security** mechanism. Command security is also implemented at the transaction level. For example, you could permit only certain users to issue CREATE and DISCARD commands against DB2ENTRY resource definitions. [“Using command security to control the issuing of SPI commands against DB2CONN, DB2ENTRY, and DB2TRAN resource definitions” on page 315](#) tells you how to use this security mechanism.
- Control users' ability to modify the authorization IDs that CICS provides to DB2, by using the CICS **surrogate security and AUTHTYPE security** mechanisms. The authorization IDs are used for DB2's own security checking, and they are set by the AUTHID, COMAUTHID, AUTHTYPE and COMAUTHTYPE attributes on DB2-related resource definitions, and by the SIGNID attribute on the DB2CONN definition for the CICS region. CICS checks that the user who wants to modify the authorization ID, is permitted to act on behalf of the existing authorization ID that is specified in the resource definition. [“Using surrogate security and AUTHTYPE security to control access to the authorization IDs that CICS provides to DB2” on page 316](#) tells you how to use these security mechanisms.

Using resource security to control access to DB2ENTRY and DB2TRAN resource definitions

The CICS resource security mechanism controls users' access to named CICS resources. For example, you can use it to protect certain resources, such as a particular DB2ENTRY definition, from being modified by particular users.

About this task

CICS command security can prevent users from performing certain actions on types of resources, such as "all DB2ENTRY definitions", but it cannot protect individual items within the resource type.

Because your CICS region only has one DB2CONN definition, you do not need to use resource security to protect it; you can control access to the DB2CONN definition using command security. Also, DB2TRAN definitions, for the purpose of resource security, are treated as extensions of the DB2ENTRY definition to which they refer, and are not defined for resource security in their own right. If you give a user permission to access a DB2ENTRY definition, you also give them permission to access the DB2TRAN definitions that refer to it. (In the case where a transaction changes the name of the DB2ENTRY with which a DB2TRAN

definition is associated, a double security check is performed, to verify the user's authority to modify both the old DB2ENTRY to which the definition referred, and the new DB2ENTRY to which it will refer.) For resource security, you therefore only need to define your DB2ENTRY definitions to RACF.

When resource security is enabled for a transaction, the external security manager checks that the user ID associated with the transaction is authorized to modify the resource that is involved. [Security of resource definitions](#) has more information about this process.

To protect your DB2-related resources using resource security, complete these steps:

Procedure

1. To enable RACF, or an equivalent external security manager, and make resource security available for a CICS region, specify SEC=YES as a system initialization parameter for the CICS region.
2. In RACF, create general resource classes to contain your DB2-related resources. You need a member class and a grouping class.

Unlike the RACF default resource class names for CICS, there are no IBM-supplied default class names for DB2ENTRYs. Create your own installation-defined class names by adding new class descriptors to the installation-defined part (module ICHRRCDE) of the RACF class descriptor table (CDT). For an example of how to do this, see the IBM-supplied sample job, RRCDE, supplied in member DFH\$RACF of CICSTS54.CICS.SDFHSAMP. This gives an example of a member class called XCICSDB2, and a grouping class called ZCICSDB2. This example uses the same naming convention as the default resource class names for CICS. Do not use existing CICS class names for DB2-related resource definitions; instead, create new class names using a similar naming convention.

3. Define profiles for your DB2ENTRY definitions in the resource classes that you have created.

For example, to add a number of DB2ENTRY names to the XCICSDB2 resource class, use the RDEFINE command as follows:

```
RDEFINE XCICSDB2 (db2ent1, db2ent2, db2ent3., db2entn) UACC(NONE)
              NOTIFY(sys_admin_userid)
```

Protecting DB2ENTRY resource definitions also protects access to associated DB2TRAN definitions, because a DB2TRAN is considered to be an extension to the DB2ENTRY to which it refers. You do not need to protect your DB2CONN definition using resource security.

4. To activate resource security for your DB2-related resources, specify XDB2=*name* as a system initialization parameter for the CICS region, where *name* is the general resource class name that you defined for your DB2-related resources.
5. Specify RESSEC=YES in the resource definition for any transactions involving DB2-related resources for which you want to enable resource security. Now, when a user tries to use one of these transactions to access one of the DB2-related resources that you have protected, RACF checks that the user ID is authorized to access that resource.
6. Give permission to your CICS users, or groups of users, to perform appropriate actions on each DB2-related resource that you have protected.

Remember that if a user has permission to perform actions on a DB2ENTRY definition, they are automatically authorized to perform the same actions on DB2TRAN definitions associated with it. The access that users need to perform certain actions is as follows:

INQUIRE command

Requires READ authority

SET command

Requires UPDATE authority

CREATE command

Requires ALTER authority

DISCARD command

Requires ALTER authority

For example, you can use the PERMIT command to authorize a group of users to modify a protected DB2ENTRY, db2ent1 in class XCICSDB2, with UPDATE authority, as follows:

```
PERMIT db2ent1 CLASS(XCICSDB2) ID(group1) ACCESS(UPDATE)
```

Results

Using command security to control the issuing of SPI commands against DB2CONN, DB2ENTRY, and DB2TRAN resource definitions

Use CICS command security mechanisms to protect DB2CONN, DB2ENTRY, and DB2TRAN resource definitions.

About this task

The CICS command security mechanism controls users' ability to issue particular SPI commands against types of DB2-related resource. For example, you can use it to control which users are allowed to issue CREATE and DISCARD commands against DB2ENTRY resource definitions. Unlike resource security, CICS command security cannot protect individual named resources; it is designed to protect types of resource. You can use command security to protect DB2CONN, DB2ENTRY, and DB2TRAN resource definitions.

When command security is enabled for a transaction, the external security manager checks that the user ID associated with the transaction is authorized to use that command to modify the type of resource that is involved. [CICS command security](#) has more information about this process.

If you have both resource security and command security enabled for a particular transaction, RACF performs two security checks against the user ID. For example, if a transaction involves the user issuing a DISCARD command against DB2ENTRY definition db2ent1, RACF checks:

1. That the user ID is authorized to issue the DISCARD command (ALTER authority) against the DB2ENTRY resource type.
2. That the user ID is authorized to access the DB2ENTRY definition db2ent1 with ALTER authority.

To protect your DB2-related resources using command security, complete these steps:

Procedure

1. To enable RACF, or an equivalent external security manager, for a CICS region, specify SEC=YES as a system initialization parameter for the region.
2. Add the DB2 resource names DB2CONN, DB2ENTRY, and DB2TRAN as resource identifiers in one of the IBM-supplied RACF resource classes for CICS commands, CCICSCMD or VCICSCMD.

Alternatively, you can use a user-defined general resource class for your CICS commands. [CICS resources subject to command security checking](#) tells you more about this.

For example, you can use the REDEFINE command to define a profile named CMDSAMP in the default class VCICSCMD, and use the ADDMEM operand to specify that the DB2 resource types are to be protected by this profile, as follows:

```
RDEFINE VCICSCMD CMDSAMP UACC(NONE)
          NOTIFY(sys_admin_userid)
          ADDMEM(DB2CONN, DB2ENTRY, DB2TRAN)
```

3. To make command security available for a CICS region:
 - a) If you have used the IBM-supplied RACF resource classes CCICSCMD or VCICSCMD for CICS command profiles, specify XCMD=YES as a system initialization parameter for the region. Specifying YES means that CCICSCMD and VCICSCMD are used to build RACF's in-storage profiles.
 - b) If you have used a user-defined general resource class for CICS commands, specify XCMD=*user_class* as a system initialization parameter for the region, where *user_class* is the name of the user-defined general resource class.

4. Specify CMDSEC=YES in the resource definition for any transactions involving DB2-related resources for which you want to enable command security. Now, when a user tries to use one of these transactions to issue a command to modify one of the DB2-related resources that you have protected, RACF checks that the user ID is authorized to issue that command against that type of resource.
5. Give permission to your CICS users, or groups of users, to issue appropriate commands against each type of DB2-related resource. For command security, you need to give separate permissions relating to the DB2TRAN resource type, as well as to the DB2ENTRY resource type. You can also protect the DB2CONN resource type (that is, the CICS region's DB2CONN definition).

The access that users need to issue certain commands is as follows:

INQUIRE command

Requires READ authority

SET command

Requires UPDATE authority

CREATE command

Requires ALTER authority

DISCARD command

Requires ALTER authority

For example, if you have defined the DB2 resource types in the CMDSAMP profile as in the example in Step 2, you can use the PERMIT command to authorize a group of users to issue EXEC CICS INQUIRE commands against the DB2 resource types as follows:

```
PERMIT CMDSAMP CLASS(VICSCMD) ID(operator_group) ACCESS(READ)
```

Within a transaction, you can query whether a user ID has access to DB2 resource types by using the **EXEC CICS QUERY SECURITY RESTYPE(SPCOMMAND)** command, with the RESID parameter specifying DB2CONN, DB2ENTRY, or DB2TRAN.

Using surrogate security and AUTHTYPE security to control access to the authorization IDs that CICS provides to DB2

The CICS surrogate security and AUTHTYPE security mechanisms control users' ability to modify the authorization IDs that CICS provides to DB2.

About this task

Use surrogate security and AUTHTYPE security to ensure that only certain users are permitted to change the authorization IDs, which are used for DB2's own security checking. Surrogate security and AUTHTYPE security are set for the whole CICS region, and any transactions that involve changes to the authorization IDs are subject to them.

[“Providing authorization IDs to DB2 for the CICS region and for CICS transactions” on page 319](#) explains how to select and change these authorization IDs. To summarize, the authorization IDs that CICS provides to DB2 are set by the AUTHID, COMAUTHID, AUTHTYPE and COMAUTHTYPE attributes on DB2-related resource definitions, and by the SIGNID attribute on the DB2CONN definition for the CICS region. To change the authorization IDs, you first need authority to modify the DB2CONN and DB2ENTRY definitions, which might be protected by command security or resource security. Surrogate security provides an extra layer of protection, because it involves CICS acting on DB2's behalf to check that the user modifying the authorization ID, is permitted to act as a surrogate for the existing authorization ID that is specified in the resource definition.

True surrogate security provides security checking when a user attempts to change the SIGNID, AUTHID or COMAUTHID attributes on a DB2CONN or DB2ENTRY definition, all of which specify an authorization ID that is used when a process signs on to DB2. CICS uses the surrogate user facility of RACF to perform this checking. A surrogate user is one who has the authority to do work on behalf of another user, without knowing that other user's password. When a user attempts to change one of the SIGNID, AUTHID

or COMAUTHID attributes, CICS calls RACF to check that the user is authorized as a surrogate of the authorization ID that is presently specified on the SIGNID, AUTHID or COMAUTHID attribute.

For the AUTHTYPE and COMAUTHTYPE attributes, which give a type of authorization ID to be used rather than specifying an exact authorization ID, CICS cannot use true surrogate security. Instead, it uses a mechanism called AUTHTYPE security. When a user attempts to change one of the AUTHTYPE or COMAUTHTYPE attributes, CICS calls RACF to check that the user is authorized through a profile that you have defined for the resource definition in the RACF FACILITY general resource class. Although AUTHTYPE security is not true surrogate security, it is enabled by the same system initialization parameter, and you will probably want to use it in addition to surrogate security, so the instructions in this topic tell you how to set up both types of security.

Note that when DB2CONN and DB2ENTRY resource definitions are installed as part of a cold or initial start of CICS, if surrogate security and AUTHTYPE security are enabled, RACF makes surrogate security and AUTHTYPE security checks for the CICS region user ID. If you install DB2CONN and DB2ENTRY resource definitions in this way, ensure that the CICS region user ID is defined as a surrogate user for any authorization IDs specified in the resource definitions, and also that it is authorized through the correct profiles in the RACF FACILITY general resource class.

To implement surrogate security and AUTHTYPE security to protect the authorization IDs that CICS provides to DB2, complete the following steps:

Procedure

1. To enable RACF, or an equivalent external security manager, for a CICS region, specify SEC=YES as a system initialization parameter for the region.
2. To activate surrogate security and AUTHTYPE security for a CICS region, specify XUSER=YES as a system initialization parameter for the region. This system initialization parameter enables both the security mechanisms. When the security mechanisms are enabled, CICS calls RACF to perform security checks whenever a transaction involves EXEC CICS SET, CREATE, and INSTALL commands that operate on the SIGNID, AUTHID, COMAUTHID, AUTHTYPE and COMAUTHTYPE attributes of DB2CONN and DB2ENTRY resource definitions. For the SIGNID, AUTHID and COMAUTHID attributes, RACF performs the surrogate security check, and for the AUTHTYPE or COMAUTHTYPE attributes, RACF performs the AUTHTYPE security check.
3. For the purpose of surrogate security, you need to define appropriate CICS users, or groups of users, as surrogates of any authorization IDs that are specified on the SIGNID, AUTHID or COMAUTHID attributes of your DB2CONN and DB2ENTRY definitions. To define a user ID as a surrogate of an authorization ID:
 - a) Create a profile for the authorization ID in the RACF SURROGAT class, with a name of the form *authid.DFHINSTL*, with the authorization ID defined as the owner.
For example, if you have specified DB2AUTH1 as an authorization ID on a SIGNID, AUTHID or COMAUTHID attribute, use the following command to create a profile:

```
RDEFINE SURROGAT DB2AUTH1.DFHINSTL UACC(NONE) OWNER(DB2AUTH1)
```

- b) Permit appropriate CICS users to act as a surrogate for the authorization ID, by giving them READ authority to the profile you have created.
For example, to permit a user with the ID CICSUSR1 to act as a surrogate for the authorization ID DB2AUTH1, and therefore to install or modify any SIGNID, AUTHID or COMAUTHID attributes that specify DB2AUTH1 as the existing authorization ID, use the following command:

```
PERMIT DB2AUTH1.DFHINSTL CLASS(SURROGAT) ID(CICSUSR1) ACCESS(READ)
```

Repeat this process for all the authorization IDs that you have specified on SIGNID, AUTHID or COMAUTHID attributes.

- c) If you might need to install DB2CONN and DB2ENTRY resource definitions containing SIGNID, AUTHID or COMAUTHID attributes as part of a cold or initial start of CICS, permit the CICS region user ID to act as a surrogate for any authorization IDs specified by those attributes.

The defaults for DB2CONN and DB2ENTRY resource definitions do not involve the AUTHID and COMAUTHID attributes. The default SIGNID for an installed DB2CONN definition is the applid of the CICS region.

4. For the purpose of AUTHTYPE security, you need to create a profile for each of your DB2CONN or DB2ENTRY resource definitions in the RACF FACILITY general resource class, and give appropriate CICS users, or groups of users, READ authority to the profiles. (This process imitates the true surrogate security mechanism, but does not involve the use of a specific authorization ID; instead, it protects each resource definition.) To do this:

a) Create a profile for the DB2CONN or DB2ENTRY resource definition in the RACF FACILITY general resource class, with a name of the form DFHDB2.AUTHTYPE.*authname*, where *authname* is the name of the DB2CONN or DB2ENTRY resource definition.

For example, to define a profile for a DB2CONN resource definition named DB2CONN1, use the following command:

```
RDEFINE FACILITY DFHDB2.AUTHTYPE.DB2CONN1 UACC(NONE)
```

b) Give appropriate CICS users READ authority to the profile you have created.

For example, to permit a user with the ID CICSUSR2 to install or modify the AUTHTYPE or COMAUTHTYPE attributes on a DB2CONN resource definition named DB2CONN1, use the following command:

```
PERMIT DFHDB2.AUTHTYPE.DB2CONN1 CLASS(FACILITY) ID(CICSUSR2) ACCESS(READ)
```

Repeat this process for each of your DB2CONN and DB2ENTRY resource definitions. Also, if you might need to install DB2CONN and DB2ENTRY resource definitions containing AUTHTYPE or COMAUTHTYPE attributes as part of a cold or initial start of CICS, give READ authority to the CICS region user ID on the profiles for those resource definitions.

Results

Controlling users' access to DB2-related CICS transactions

Use the CICS transaction-attach security mechanism to control users' access to: CICS transactions that access DB2 to obtain data, the DSNB transaction, and to any other transactions that issue CICS DB2 attachment facility commands and DB2 commands.

About this task

When transaction-attach security is enabled, RACF, or an equivalent external security manager, checks that the CICS user is authorized to run the transaction that they have requested.

To protect DB2-related transactions using transaction-attach security, follow the instructions in [Transaction security](#). The process is the same for all CICS transactions; there are no special considerations for DB2-related transactions as far as the transaction-attach security mechanism is concerned. The instructions tell you how to:

- Set up appropriate system initialization parameters for the CICS region to activate transaction-attach security (see [CICS parameters controlling transaction-attach security](#)).
- Define transaction profiles to RACF for the transactions that you want to protect (see [RACF profiles](#)).

If you have defined transactions other than DSNB to issue CICS DB2 attachment facility commands and DB2 commands (for example, if you have created a separate transaction to run each command), remember to define these transactions to RACF as well.

You can now control which CICS users can use transactions that access DB2. Add the appropriate users or groups of users to the access list for the transaction profiles, with READ authority. [RACF profiles](#) has some recommendations about this.

For transactions that issue CICS DB2 attachment facility commands and DB2 commands, bear in mind that:

- CICS DB2 attachment facility commands operate on the connection between CICS and DB2, and they run entirely within CICS. DB2 commands operate in DB2 itself, and they are routed to DB2. You can distinguish DB2 commands from CICS DB2 attachment facility commands by the hyphen (-) character, which is entered with DB2 commands.
- If you have access to the DSNB transaction, CICS allows you to issue all of the CICS DB2 attachment facility commands and DB2 commands.
- If you have defined separate transactions to run individual CICS DB2 attachment facility commands and DB2 commands, you can give different CICS users authorization to subsets of these transaction codes, and therefore to subsets of the commands. For example, you could give some users authority to issue CICS DB2 attachment facility commands, but not DB2 commands. [CICS-supplied transactions for CICS DB2](#) has the names of the separate transaction definitions that CICS supplies for the CICS DB2 attachment facility commands and the DB2 commands.

CICS DB2 attachment facility commands do not flow to DB2, so they are not subject to any further security checking. They are only protected by CICS transaction-attach security. However, DB2 commands, and CICS transactions that access DB2 to obtain data, are subject to further stages of security checking by DB2's own security mechanisms, as follows:

- When a transaction signs on to DB2, it must provide valid authorization IDs to DB2. The authorization IDs are checked by RACF or an equivalent external security manager.
- Because the transaction is issuing a DB2 command or accessing DB2 data, the authorization IDs that it has provided must have permission to perform these actions within DB2. In DB2, you can use GRANT statements to give the authorization IDs permission to perform actions.

In addition, the CICS region itself must be authorized to connect to the DB2 subsystem.

[“Providing authorization IDs to DB2 for the CICS region and for CICS transactions”](#) on page 319 tells you how to authorize the CICS region to connect to the DB2 subsystem, and how to provide valid authorization IDs for transactions.

[“Authorizing users to access resources in DB2”](#) on page 326 tells you how to grant permissions to the authorization IDs that the transactions have provided to DB2.

Providing authorization IDs to DB2 for the CICS region and for CICS transactions

CICS has two types of process that must provide DB2 with authorization IDs: the overall connection between a CICS region and DB2, and CICS transactions that acquire a thread into DB2.

About this task

For the purposes of security, DB2 uses the term “process” to represent all forms of access to data, either by users interacting directly with DB2, or by users interacting with DB2 by way of other programs, including CICS. A process that connects to or signs on to DB2 must provide one or more DB2 short identifiers, called authorization IDs, that can be used for security checking in the DB2 address space. Every process must provide a primary authorization ID, and it can optionally provide one or more secondary authorization IDs. DB2 privileges and authority can be granted to either primary or secondary authorization IDs. For example, users can create a table using their secondary authorization ID. The table is then owned by that secondary authorization ID. Any other user that provides DB2 with the same secondary authorization ID has associated privileges over the table. To take privileges away from a user, the administrator can disconnect the user from that authorization ID.

CICS has two types of process that need to provide DB2 with authorization IDs:

- The overall connection between a CICS region and DB2, which is created by the CICS DB2 attachment facility. This process has to go through DB2's connection processing to provide DB2 with authorization IDs.
- CICS transactions that acquire a thread into DB2. These could be, for example, a transaction that is retrieving data from a DB2 database, or the DSNB transaction that is issuing a DB2 command. For each CICS transaction, the actual process that DB2 sees is the thread TCB, which CICS uses to control a

transaction's thread into DB2. These processes have to go through DB2's sign-on processing to provide DB2 with authorization IDs.

During connection processing and sign-on processing, DB2 sets the primary and secondary authorization IDs for the process to use in the DB2 address space. By default, DB2 uses the authorization IDs that the process has provided. However, both connection processing and sign-on processing involve exit routines, and these exit routines allow you to influence the setting of the primary and secondary authorization IDs. DB2 has a default connection exit routine and a default sign-on exit routine. You can replace these with your own exit routines, and a sample connection exit routine and sign-on exit routine are supplied with DB2 to assist you with this.

Providing authorization IDs to DB2 for a CICS region

CICS provides a primary authorization ID and one or more secondary authorization IDs to DB2.

About this task

When the CICS DB2 attachment facility creates the overall connection between a CICS region and DB2, the process goes through DB2's connection processing. The CICS region can provide:

- A primary authorization ID. The primary authorization ID becomes the CICS region's primary ID in DB2. For the connection between a CICS region and DB2, you cannot choose the primary authorization ID that is initially passed to DB2's connection processing; it is the user ID for the CICS region. However, it is possible to change the primary ID that DB2 sets during connection processing, by writing your own connection exit routine. If RACF, or an equivalent external security manager, is active, the user ID for the CICS region must be defined to it. [“Providing a primary authorization ID for a CICS region” on page 320](#) tells you about the possible primary authorization IDs for a CICS region.
- One or more secondary authorization IDs. You can use the name of a RACF group, or list of groups, as secondary authorization IDs for the CICS region. If you do this, you need to replace the default DB2 connection exit routine DSN3@ATH, which only passes primary authorization IDs to DB2. The sample DB2 connection exit routine DSN3SATH passes the names of RACF groups to DB2 as secondary authorization IDs. Alternatively, you can write your own connection exit routine that sets secondary IDs for the CICS region. [“Providing secondary authorization IDs for a CICS region” on page 321](#) tells you how to set up secondary authorization IDs for a CICS region.

Providing a primary authorization ID for a CICS region

The primary authorization ID that is passed to DB2 depends whether CICS is running as a started task, a started job, or a job.

About this task

The connection type that CICS requests from DB2 is single address space subsystem (SASS). For the connection between a CICS region and DB2, you cannot choose the primary authorization ID that is initially passed to DB2's connection processing. The ID that is passed to DB2 as the primary authorization ID for the CICS region is one of the following:

- The user ID taken from the RACF started procedures table, ICHRIN03, if CICS is running as a started task.
- The user parameter of the STDATA segment in a STARTED general resource class profile, if CICS is running as a started job.
- The user ID specified on the USER parameter of the JOB card, if CICS is running as a job.

The user ID that a CICS region might use must be defined to RACF, or your equivalent external security manager, if the external security manager is active. Define the user ID to RACF as a USER profile. It is not sufficient to define it as a RESOURCE profile.

Once you have defined the CICS region's user ID to RACF, permit it to access DB2, as follows:

1. Define a profile for the DB2 subsystem with the single address space subsystem (SASS) type of connection, in the RACF class DSNR. For example, the following RACF command creates a profile for SASS connections to DB2 subsystem DB2A in class DSNR:

```
RDEFINE DSNR (DB2A.SASS) OWNER(DB2OWNER)
```

2. Permit the user ID for the CICS region to access the DB2 subsystem. For example, the following RACF command permits a CICS region with a user ID of CICSHA11 to connect to DB2 subsystem DB2A:

```
PERMIT DB2A.SASS CLASS(DSNR) ID(CICSHA11) ACCESS(READ)
```

DB2's connection exit routine takes the primary authorization ID (the user ID) provided by the CICS region, and sets it as the primary ID for the CICS region in DB2. The default DB2 connection exit routine DSN3@ATH, and the sample DB2 connection exit routine DSN3SATH, both behave in this way. It is possible to change the primary ID that DB2 sets, by writing your own connection exit routine. For more information about the sample connection exit routine and about writing exit routines, see [Securing Db2 in Db2 for z/OS product documentation](#). However, you might find it more straightforward to provide secondary authorization IDs for the CICS region, and grant permissions to the CICS region based on these, rather than on the primary authorization ID.

Providing secondary authorization IDs for a CICS region

When a CICS region connects to DB2, it can provide one or more secondary authorization IDs to DB2, in addition to the primary authorization ID. You can use the name of the RACF group, or list of groups, to which the CICS region is connected, as secondary authorization IDs. This enables you to grant DB2 privileges and authority to RACF groups, and then connect multiple CICS regions to the same groups, instead of granting DB2 privileges to all the possible primary authorization IDs for each CICS region.

About this task

To provide the name of the RACF group, or list of groups, to which a CICS region is connected, to DB2 as secondary authorization IDs, complete the following steps:

1. Specify SEC=YES as a system initialization parameter for the CICS region, to ensure that CICS uses RACF.
2. Connect the CICS region to the appropriate RACF group or list of groups. See [RACF group profiles](#).
3. Replace the default DB2 connection exit routine DSN3@ATH. This exit routine is driven during connection processing. The default connection exit routine does not support secondary authorization IDs, so you need to replace it with the sample connection exit routine DSN3SATH, which is provided with DB2, or with your own routine. DSN3SATH is shipped in source form in the DB2 SDSNSAMP library, and you can use it as a basis for your own routine. DSN3SATH passes the names of the RACF groups to which the CICS region is connected, to DB2 as secondary authorization IDs. If the RACF list of groups option is active, DSN3SATH obtains all the group names to which the CICS region is connected, and uses these as secondary authorization IDs. If the RACF list of groups option is not active, DSN3SATH uses the name of the CICS region's current connected group as the only secondary authorization ID.

When the CICS region connects to DB2, the sample connection exit routine sets the CICS region's primary authorization ID (the region's user ID) as the primary ID, and sets the names of the RACF groups to which the CICS region is connected, as secondary IDs.

As an alternative to providing the names of RACF groups as secondary authorization IDs to DB2, you can write your own connection exit routine that sets secondary IDs for the CICS region. For information about writing connection exit routines, see [Securing Db2 in Db2 for z/OS product documentation](#).

Providing authorization IDs to DB2 for CICS transactions

So that CICS can pass authorization IDs to DB2, CICS must be using RACF; SEC=YES must be specified in the SIT. This is because CICS needs to pass a RACF access control environment element (ACEE) to DB2.

About this task

When a CICS transaction's thread TCB signs on to DB2 and goes through DB2's sign-on processing, it can provide:

- A primary authorization ID. For CICS transactions, you can choose the primary authorization ID. It can be the user ID or operator ID of the CICS user, or a terminal ID, or a transaction ID; or it can be an ID that you have specified. The ID that is used as the primary authorization ID is determined by attributes in the DB2ENTRY definition (for entry threads), or in the DB2CONN definition (for pool threads and command threads). [“Providing a primary authorization ID for CICS transactions” on page 323](#) tells you how to choose the primary authorization ID for a CICS transaction.
- One or more secondary authorization IDs. You can use the name of a RACF group, or list of groups, as secondary authorization IDs. This has the advantage that you can grant DB2 privileges and authority to RACF groups, rather than to each individual CICS user. To use secondary authorization IDs, use the AUTHTYPE attribute in the DB2ENTRY definition (for entry threads), or the AUTHTYPE or COMAUTHTYPE attributes in the DB2CONN definition (for pool threads or command threads), to specify the GROUP option. You also need to replace the default DB2 sign-on exit routine DSN3@SGN, because the default routine does not pass secondary authorization IDs to DB2. When you specify the GROUP option, the primary authorization ID is automatically defined as the user ID of the CICS user associated with the transaction. [“Providing secondary authorization IDs for CICS transactions” on page 325](#) tells you how to set up and use secondary authorization IDs.

A key consideration for choosing the authorization IDs that CICS transactions provide to DB2 is the security mechanism that you have chosen for security checking in the DB2 address space. This security checking covers access to DB2 commands, plans, and dynamic SQL. You can choose to have this security checking carried out by:

- DB2's own internal security.
- RACF, or an equivalent external security manager.
- Partly DB2, and partly RACF.

If you are using RACF for some or all of the security checking in your DB2 address space, CICS transactions that sign on to DB2 **must** provide an authorization ID by one of the following methods:

- Specify AUTHTYPE(USERID) or COMAUTHTYPE(USERID) in the appropriate definition for the thread (DB2ENTRY or DB2CONN), to provide the user ID of the CICS user associated with the transaction to DB2 as the primary authorization ID.
- Specify AUTHTYPE(GROUP) or COMAUTHTYPE(GROUP) in the appropriate definition for the thread (DB2ENTRY or DB2CONN), to provide the user ID of the CICS user associated with the transaction to DB2 as the primary authorization ID, and the name of a RACF group or list of groups as the secondary authorization IDs.
- Specify AUTHTYPE(SIGN) in the appropriate definition for the thread (DB2ENTRY or DB2CONN), and specify the CICS region user ID in the SIGNID attribute of the DB2CONN, to provide the CICS region ID to DB2 as the primary authorization ID.

Note that if the RACF access control environment element (ACEE) in the CICS region is changed in a way that affects the CICS DB2 attachment facility, DB2 is not aware of the change until a sign-on occurs. You can use the CEMT or EXEC CICS SET DB2CONN SECURITY(REBUILD) command to cause the CICS DB2 attachment facility to issue a DB2 sign-on the next time a thread is reused, or when a thread is built on an already signed-on TCB. This ensures that DB2 is made aware of the security change.

Providing a primary authorization ID for CICS transactions

When a CICS transaction's thread TCB signs on to DB2, it must provide a primary authorization ID to DB2. The ID that a transaction uses as its primary authorization ID is determined by an attribute in the resource definition for the thread that the transaction uses to access DB2.

About this task

This means that all transactions that use the same type of thread (either the same type of entry thread, or pool threads, or command threads) must use the same type of primary authorization ID. In each CICS region, you need to set a primary authorization ID for:

- Each type of entry thread, using your DB2ENTRY definitions.
- The pool threads, using your DB2CONN definition.
- The command threads (used for the DSNB transaction), using your DB2CONN definition.

Before you start to set primary authorization IDs, ensure that you have authority to do so. As well as having authority to change your DB2CONN or DB2ENTRY definitions, if surrogate user checking is in force for the CICS region (that is, the system initialization parameter XUSER is set to YES), you need to obtain special authority to perform operations involving DB2 authorization IDs. These operations are modifying the AUTHID, COMAUTHID, AUTHTYPE, or COMAUTHTYPE attributes on a DB2ENTRY or DB2CONN definition, and modifying the SIGNID attribute on a DB2CONN definition. [“Using surrogate security and AUTHTYPE security to control access to the authorization IDs that CICS provides to DB2” on page 316](#) tells you how to grant users authority to perform these operations.

There are two methods of setting the primary authorization ID for a particular type of thread:

1. Use the AUTHID attribute in the DB2ENTRY definition (for entry threads), or the AUTHID or COMAUTHID attribute in the DB2CONN definition (for pool threads or command threads), to specify a primary authorization ID. For example, you could define AUTHID=test2. In this case, the CICS DB2 attachment facility passes the characters TEST2 to DB2 as the primary authorization ID.

Using AUTHID or COMAUTHID does not permit the use of secondary authorization IDs, and also is not compatible with the use of RACF, or an equivalent external security manager, for security checking in the DB2 address space.
2. Use the AUTHTYPE attribute in the DB2ENTRY definition (for entry threads), or the AUTHTYPE or COMAUTHTYPE attribute in the DB2CONN definition (for pool threads or command threads), to instruct CICS to use an existing ID that is relevant to the transaction as the primary authorization ID. This ID can be a CICS user ID, operator ID, terminal ID, or transaction ID; or it can be an ID that you have specified in the DB2CONN definition for the CICS region.

Using AUTHTYPE or COMAUTHTYPE is compatible with the use of RACF (or an equivalent external security manager) for security checking in the DB2 address space, if you use the USERID or GROUP options, and with the use of secondary authorization IDs, if you use the GROUP option.

The two methods of determining the primary authorization ID are mutually exclusive; you cannot specify both AUTHID and AUTHTYPE, or COMAUTHID and COMAUTHTYPE, in the same resource definition.

Remember that all IDs that you select as primary authorization IDs must be defined to RACF, or your equivalent external security manager, if the security manager is active for the DB2 subsystem. For RACF, the primary authorization IDs must be defined as RACF USER profiles, not just as RESOURCE profiles (for example, as a terminal or transaction).

Follow the instructions in [DB2CONN resources](#) and [DB2ENTRY resources](#) to set up or modify DB2CONN and DB2ENTRY definitions. If you are using the AUTHTYPE or COMAUTHTYPE attributes to determine the primary authorization ID for a type of thread, use [Table 48 on page 324](#) to identify the options that provide the required authorization ID and support the facilities you want. The key points to consider are:

- If you want to provide secondary authorization IDs to DB2 as well as a primary authorization ID, you need to select the GROUP option. When you specify the GROUP option, your primary authorization ID is automatically defined as your CICS user ID, but you can base your security checking on the secondary authorization IDs instead.

- If you are using RACF for security checking in the DB2 address space, you need to select either the GROUP option, or the USERID option. Only these options can pass the RACF access control environment element (ACEE) to DB2, which is required when RACF is used for security checking.
- Think about the performance and maintenance implications of your choice of authorization ID. [Selecting authorization IDs for performance and maintenance](#) outlines these. With the USERID, OPID, TERM, TX or GROUP options, sign-on processing occurs more frequently, and maintenance also takes more time, because you need to grant permissions to a greater number of authorization IDs. With the SIGN option, or using the AUTHID attribute instead of the AUTHTYPE attribute, sign-on processing is decreased, and maintenance is less complicated. However, using standard authorization IDs makes DB2's security checking less granular.
- Think about the accounting implications of your choice of authorization ID. The authorization ID is used in each DB2 accounting record. From an accounting viewpoint, the most detailed information is obtained if using USERID, OPID, GROUP or TERM. However, depending on the ACCOUNTREC specification, it may not be possible to account at the individual user level in any case. For more information about accounting in a CICS DB2 environment, see [Accounting and monitoring in a CICS DB2 environment in Monitoring](#).

Table 48 on page 324 shows the primary authorization IDs that the CICS DB2 attachment facility passes to DB2 when you select each option for the AUTHTYPE or COMAUTHTYPE attributes.

<i>Table 48. Options available on the AUTHTYPE and COMAUTHTYPE attributes</i>			
Option	Primary authorization ID passed to DB2	Supports RACF checking for DB2?	Supports secondary auth IDs?
USERID	User ID associated with the CICS transaction, as defined to RACF and used in CICS sign-on	Yes	No
OPID	User's CICS operator ID, defined in the CICS segment of the RACF user profile	No	No
SIGN	An ID you specified in the SIGNID attribute of the DB2CONN definition for the CICS region. Defaults to the applid of the CICS region	Yes, when the SIGNID attribute of the DB2CONN resource matches the CICS region userid.	No
TERM	Terminal ID of the terminal associated with the transaction	No	No
TX	Transaction ID	No	No
GROUP	User's CICS RACF user ID used in CICS sign-on	Yes	Yes

If you are not planning to provide secondary authorization IDs for your CICS transactions, you do not need to replace the default DB2 sign-on exit routine DSN3@SGN. The default sign-on exit routine handles primary authorization IDs. However, the DB2 subsystem to which you are connecting might use a different sign-on exit routine for some other reason. If the DB2 subsystem uses the sample sign-on exit routine DSN3SSGN, you might need to make a change to DSN3SSGN, if **all** of the following conditions are true:

- You have chosen an AUTHID or AUTHTYPE option other than GROUP.
- RACF list of groups processing is active.
- You have transactions whose primary authorization ID is not defined to RACF.

If this is the case, see [Securing Db2 in Db2 for z/OS product documentation](#) for the change you need to make to the sample sign-on exit routine.

Providing secondary authorization IDs for CICS transactions

When a thread TCB that belongs to a CICS transaction signs on to DB2, it can provide one or more secondary authorization IDs to DB2, in addition to the primary authorization ID.

About this task

You can provide DB2 with the name of a CICS user's RACF group, or list of groups, as secondary authorization IDs. This has the advantage that you can grant DB2 privileges and authority to RACF groups, rather than to each individual CICS user. CICS users can then be connected to, or removed from, RACF groups as required. [RACF group profiles](#) explains how users can be placed into RACF groups.

You can only provide secondary authorization IDs to DB2 for CICS transactions if you specify the GROUP option for the AUTHTYPE attribute in the DB2ENTRY definition (for entry threads), or the AUTHTYPE or COMAUTHTYPE attributes in the DB2CONN definition (for pool threads or command threads). If you specify any other option for AUTHTYPE or COMAUTHTYPE, the secondary authorization ID is set to blanks. When you specify the GROUP option, you cannot choose the primary authorization ID for the thread type; it is automatically defined as the user ID of the CICS user associated with the transaction. You should base your security checking on the secondary authorization IDs instead.

To provide the names of a user's RACF groups to DB2 as secondary authorization IDs, complete the following steps:

1. Specify SEC=YES as a system initialization parameter for the CICS region, to ensure that CICS uses RACF. If your CICS transaction profile names are defined with a prefix, also specify the system initialization parameter SECPRFX=YES or SECPRFX=*prefix*.
2. If the CICS region is using MRO:
 - a. Ensure that each connected CICS region is also using RACF security (SEC=YES).
 - b. Specify ATTACHSEC=IDENTIFY on the CONNECTION definition for the TOR, to ensure that sign-on information is propagated from the TOR to the AORs.
3. Replace the default DB2 sign-on exit routine DSN3@SGN. This sign-on exit routine is driven during sign-on processing. The default sign-on exit routine does not support secondary authorization IDs, so you need to replace it with the sample sign-on exit routine DSN3SSGN, which is provided with DB2, or with your own routine. DSN3SSGN is shipped in source form in the DB2 SDSNSAMP library, and you can use it as a basis for your own routine. For information about sign-on exits and about writing exit routines, see [Securing Db2 in Db2 for z/OS product documentation](#). If the RACF list of groups option is not active, DSN3SSGN passes the name of the current connected group as the secondary authorization ID. If the RACF list of groups is active, DSN3SSGN obtains the names of all the groups to which the user is connected, and passes them to DB2 as secondary authorization IDs.
4. Use the AUTHTYPE attribute in the DB2ENTRY definition (for entry threads), or the AUTHTYPE or COMAUTHTYPE attribute in the DB2CONN definition (for pool threads or command threads), to specify the GROUP option as the authorization type for each type of thread for which you want to provide secondary authorization IDs. If surrogate user checking is in force for the CICS region (that is, the system initialization parameter XUSER is set to YES), you need to obtain special authority to perform operations involving DB2 authorization IDs. [“Using surrogate security and AUTHTYPE security to control access to the authorization IDs that CICS provides to DB2” on page 316](#) tells you how to do this.

If you have successfully completed all the steps listed above, when a CICS transaction's thread TCB signs on to DB2 with the types of thread that you have defined with the GROUP option, the CICS user's user ID will be passed to DB2 as the primary authorization ID, and the user's RACF group or list of groups will be passed to DB2 as secondary authorization IDs. If you have not successfully completed all the steps, the CICS DB2 attachment facility will issue an authorization failed message.

As an alternative to providing the names of RACF groups as secondary authorization IDs to DB2, you can write your own sign-on exit routine that sets secondary IDs for CICS transactions. See [Securing Db2 in Db2 for z/OS product documentation](#).

Authorizing users to access resources in DB2

Once the user has accessed the DB2 address space from a CICS transaction they might need permission to issue DB2 commands or execute a plan.

About this task

Access to the DB2 resources that a CICS user needs to issue DB2 commands or execute a plan is subject to security checking by DB2's security mechanisms. You can choose to have this security checking carried out by:

- DB2's own internal security.
- RACF, or an equivalent external security manager.
- Partly DB2, and partly RACF.

For more information about setting up RACF to perform security checking in the Db2[®] address space, see [Securing Db2 in Db2 for z/OS product documentation](#).

If you are using RACF for some or all of the security checking in your DB2 address space, remember that CICS transactions that sign on to DB2 must provide an authorization ID. For more information, see [“Providing authorization IDs to DB2 for CICS transactions” on page 322](#). CICS must also be using RACF (SEC=YES must be specified in the SIT). This is because when RACF is used for security checking in the DB2 address space, CICS needs to pass a RACF access control environment element (ACEE) to DB2. CICS can only produce an ACEE if it has RACF active, and only threads defined with the GROUP, SIGN or USERID option can pass the ACEE to DB2.

When the ACEE is passed to DB2, it is used by the DB2 exit DSNX@XAC, which determines whether RACF, or an equivalent non-IBM external security manager, or DB2 internal security is used for security checking. DSNX@XAC is driven when a transaction whose thread has signed on to DB2, issues API requests. You can modify DSNX@XAC. For more information, see [Securing Db2 in Db2 for z/OS product documentation](#).

DB2, or the external security manager, performs security checking using the authorization IDs that the CICS transaction provided to DB2 when the thread that it was using signed on to DB2. The authorization IDs could be related to the individual CICS user (for example, the CICS user's user ID and the RACF groups to which the user is connected), or they could be related to the transaction (for example, the terminal ID or transaction ID), or they could be related to the whole CICS region. For more information, see [“Providing authorization IDs to DB2 for the CICS region and for CICS transactions” on page 319](#).

DB2, or the external security manager, checks that you have given the authorization IDs permission to perform the relevant actions in DB2. You can give the authorization IDs this permission by using GRANT statements in DB2. For information about how to grant, and revoke, Db2 permissions for authorization IDs, see [Securing Db2 in Db2 for z/OS product documentation](#).

Controlling users' access to DB2 commands

For CICS users, the first security checking related to DB2 commands is performed in the CICS address space, when the user tries to access a CICS transaction that issues DB2 commands. This could be DSNC, or a user-defined transaction that invokes DFHD2CM1 and runs an individual DB2 command.

About this task

[“Controlling users' access to DB2-related CICS transactions” on page 318](#) describes how to control users' access to transactions that issues DB2 commands in the CICS address space.

When a user issues a DB2 command through a CICS transaction, they are also subject to DB2's own security checking, which verifies that they are authorized to DB2 to issue the command. This security checking uses the authorization IDs (primary or secondary) that the transaction has passed from CICS. [“Providing authorization IDs to DB2 for the CICS region and for CICS transactions” on page 319](#) tells you how to choose these authorization IDs and provide them to DB2. For transactions that use DFHD2CM1 to issue DB2 commands, the authorization IDs are set by the COMAUTHID or COMAUTHTYPE attribute of the

CICS region's DB2CONN definition. For other applications that issue DB2 commands, the authorization IDs are set by the AUTHID or AUTHTYPE attribute for the CICS region's resource definition for the type of thread used by the transaction (pool thread or entry thread). These attributes control the authorization ID, or type of authorization ID, that is passed to DB2 by a transaction that is using that type of thread.

DB2 commands are therefore subject to two security checks, one in the CICS address space and one in the DB2 address space. Figure 28 on page 327 illustrates the process.

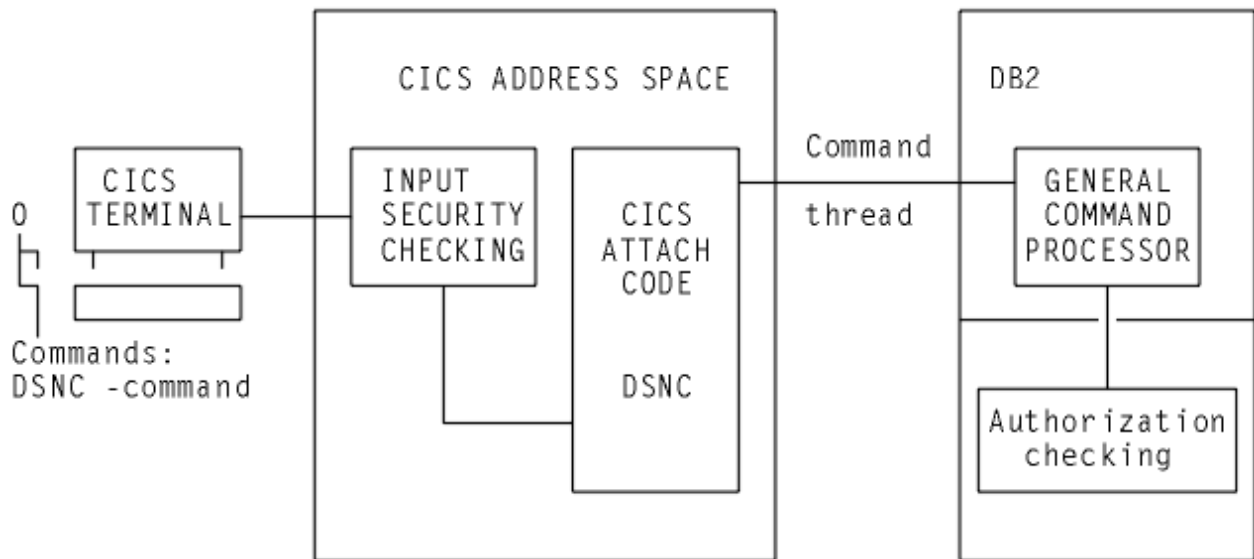

Figure 28. Security mechanisms for DB2 commands

In most cases, only a limited number of users are permitted to execute DB2 commands. A convenient solution can be to specify COMAUTHTYPE(USERID) on the DB2CONN definition, which resolves to the 8-byte CICS user ID as the authorization ID in DB2. Using this method, you can give different DB2 privileges explicitly to CICS user IDs. For example, you can use GRANT DISPLAY to give specific CICS user IDs permission to use only the -DIS command.

To authorize a user to issue a DB2 command, use a GRANT command to grant DB2 command privileges to the authorization ID that the transaction has passed from CICS. For information about how to grant, and revoke, Db2 permissions for authorization IDs, see [Securing Db2 in Db2 for z/OS product documentation](#).

Controlling users' access to plans

A number of checks take place before a user can access plans in DB2. These checks start in the CICS address space before the request is passed to DB2 for further checks.

About this task

For DB2 commands, the first security check for users' access to plans takes place in the CICS address space, when CICS verifies that the user is permitted to access the transaction that will execute the plan. The second security check takes place in the DB2 address space, when DB2 verifies that the authorization ID provided by the transaction, is authorized to execute the plan. [Figure 29 on page 328](#) illustrates this process.

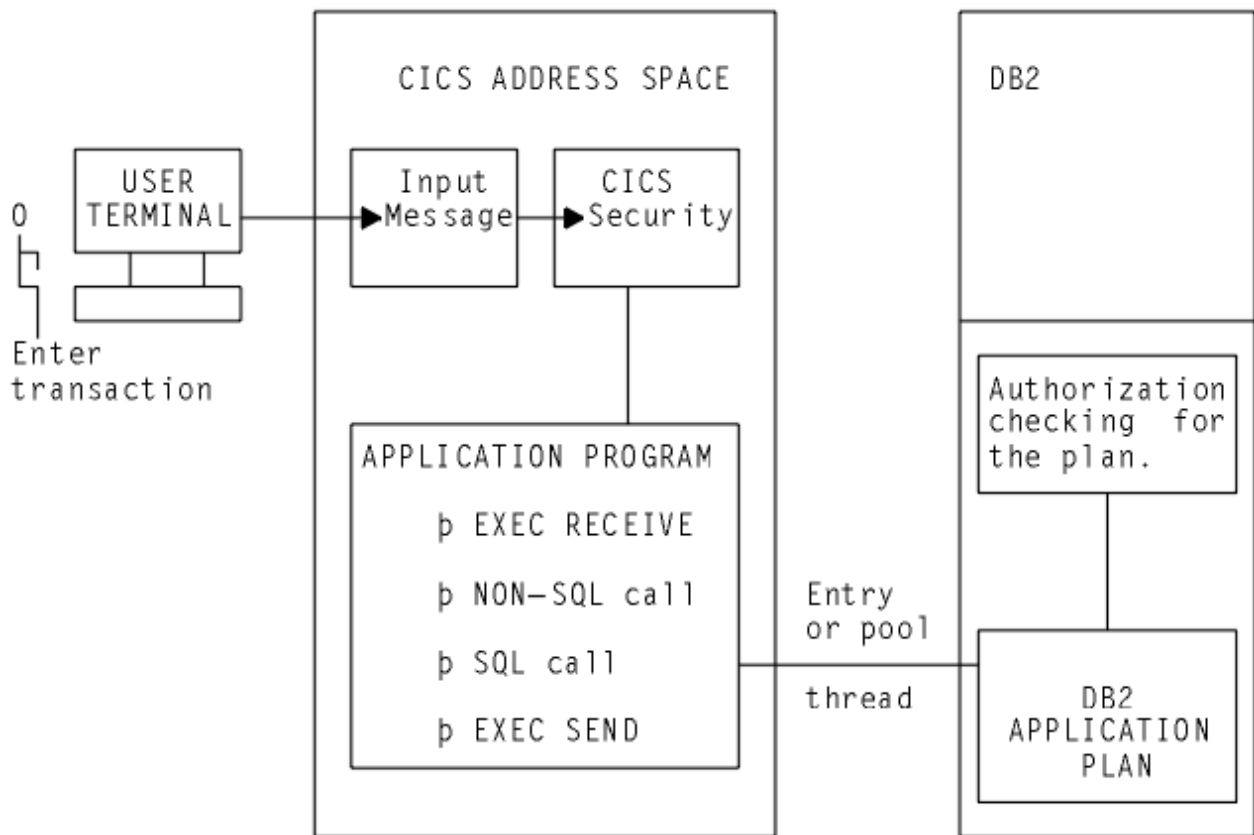

Figure 29. Security mechanisms for executing a plan

To authorize a user to execute a plan, use a GRANT command to grant DB2 command privileges to the authorization ID that the transaction has passed from CICS. For information about how to grant, and revoke, DB2 permissions for authorization IDs, see [Securing Db2 in Db2 for z/OS product documentation](#).

If a plan includes dynamic SQL

When using static SQL, the binder of the plan must have the privileges needed to access the data, and the authorization ID passed from CICS to DB2 need only have the privileges to execute the plan.

About this task

However, if a plan includes the use of dynamic SQL, the authorization ID passed from CICS to DB2 must possess the privileges required to access all the DB2 resources involved, both the plan and the data. For example, if you specify AUTHTYPE(USERID), the CICS user ID must be granted DB2 privileges to the DB2 resources involved in the dynamic SQL. If this user ID is also a TSO user ID, it has access to the DB2 resources directly from SPUFI, QMF, and other utilities.

If you do not want to spend too much time granting DB2 privileges, where a transaction executes a plan that involves the use of dynamic SQL, consider using one of the following methods of supplying an authorization ID to DB2:

- Use the SIGN option on the AUTHTYPE attribute of the DB2ENTRY definition for the thread used by the transaction. This results in the transaction having the primary authorization ID that you specified in the SIGNID attribute of the DB2CONN definition for the CICS region. (This method is not suitable where RACF is used for security checking in the DB2 address space.)
- Use the AUTHID attribute of the DB2ENTRY definition for the thread used by the transaction, to specify a standard authorization ID. Use the same authorization ID for all the transactions that need to access dynamic SQL. (This method is not suitable where RACF is used for security checking in the DB2 address space.)

- Create a RACF group, and connect your CICS users to this RACF group. Use the GROUP attribute of the DB2ENTRY definition for the thread used by the transaction, so that the RACF group is one of the secondary IDs that is passed to DB2.

In each case, you can then grant DB2 privileges for DB2 resources involved in all dynamic SQL to a single ID, either the standard authorization ID from the DB2CONN definition or the AUTHID attribute, or the name of the RACF group. [“Providing authorization IDs to DB2 for the CICS region and for CICS transactions” on page 319](#) tells you how to provide authorization IDs by all these methods.

DB2 multilevel security and row-level security

DB2 Version 8 introduced support for multilevel security. CICS does not provide specific support for multilevel security, but you can use CICS in a multilevel-secure environment provided that you take care with the configuration.

For more information about multilevel security, see:

- [Securing Db2 in Db2 for z/OS product documentation](#)
- [z/OS Planning for Multilevel Security and the Common Criteria](#)
- [IBM Redbooks: Securing DB2 and Implementing MLS on z/OS](#)

When multilevel security is implemented at row level (row-level security) for data in DB2 Version 8 or later, the RACF SECLABEL class is activated, and a set of security labels is defined for users and for the DB2 table rows. The RACF options SETR MLS and MLACTIVE are not required to be active. You can use DB2 row-level security without impact on the rest of the MVS system.

CICS is able to access DB2 rows secured in this way. For CICS, you need to ensure that the RACF user profile for a CICS user that needs access to the DB2 rows is defined in RACF to include a default SECLABEL. For details, see the [z/OS Security Server RACF Security Administrator's Guide](#).

When a CICS user signs on to a CICS region with SEC=YES specified in the SIT, RACF associates the default SECLABEL with the RACF access control environment element (ACEE) for the user. The DB2ENTRY definition (or DB2CONN definition if the pool is being used) needs to specify AUTHTYPE=USERID or AUTHTYPE=GROUP, which ensures the ACEE is passed on to DB2 for further security checking. An individual CICS user can therefore only have one associated SECLABEL.

For non-terminal tasks or programs, such as PLT programs, if the PLTPIUSR system initialization parameter is not specified and the PLTPISEC=NONE system initialization parameter is specified, PLT programs are run under the CICS region userid. In this case, you need to define the CICS region userid with a default SECLABEL. If you need to define different SECLABELS for a transaction, you would need to run each transaction in a separate CICS region which has a different CICS region userid and associated SECLABEL.

Security for DBCTL

When you use CICS with DBCTL, several security facilities are available.

You can use one or more of the following optional security facilities:

- [“PSB authorization checking by CICS” on page 330](#)
- Resource access security checking by DBCTL
- DBCTL password security checking

For details about resource access security checking by DBCTL and DBCTL password security checking, see [System administration in IMS product documentation](#).

Of the resources you can protect by using IMS security, you only need to be concerned about only with PSBs, databases, and commands.

PSB authorization checking by CICS

At PSB scheduling time, CICS invokes security checking to determine whether the terminal user is authorized to access the PSB. The actual check is carried out by an external security manager, which can be RACF or your own security program.

Although PSB scheduling requests are sent to DBCTL for processing, CICS does PSB authorization checking. For programming information about writing your own security program, see [Invoking an external security manager](#).

Security for data sets: encryption

You can encrypt any data sets that you use with CICS for which z/OS data set encryption is supported. This includes user data sets that are accessed through CICS File Control APIs, queued sequential access method (QSAM) data sets used for CICS extrapartition transient data, basic sequential access method (BSAM) data sets used with CICS, and CICS system data sets that are appropriate candidates for encryption.

You can use data set encryption with any in-service release of CICS TS for z/OS. z/OS data set encryption is supported in z/OS 2.2 with the PTFs for APAR OA50569 applied and later releases.

Encrypted data sets must be storage management subsystem (SMS)-managed and extended format. To create an encrypted data set, you assign a key label to a data set when that new data set is allocated. The key label must point to an AES-256 bit encryption key in the integrated cryptographic service facility (ICSF) cryptographic key data set (CKDS) that will be used to encrypt or decrypt the data. The key label is not sensitive information, but the encryption key that it identifies is.

Encryption support for CICS user data sets

For user data sets defined to CICS, encryption support includes key-sequenced data sets (KSDS), entry-sequenced data sets (ESDS), relative record data sets (RRDS), and variable relative record data sets (VRRDS), accessed through base VSAM and VSAM Record Level Sharing (RLS). Encryption is also supported for the backing VSAM key-sequenced data sets that are used for shared data tables or coupling facility data tables.

Encryption support for CICS system data sets

You can encrypt any CICS system data sets for which encryption is supported, but some system data sets are good candidates for encryption, whereas others are not.

- Data sets with the *potential* to contain sensitive data are candidates for encryption. You must assess which of your data sets might contain sensitive data and whether to encrypt them.
- Data sets that do not, and are unlikely to, contain sensitive data are not candidates for encryption.

The following table lists the CICS system data sets for which encryption is possible, and whether they are candidates for encryption. If you want to use an "encrypt everything" approach, all the data set types that are listed in this table can be encrypted.

CICS system data set	Candidate for encryption?	Special considerations
Temporary storage data set (DFHTEMP)	Yes, could contain sensitive data.	DFHTEMP supports extended format, but does not support extended addressing.
Intrapartition Transient Data (DFHINTRA)	Yes, could contain sensitive data.	DFHINTRA supports extended format, but does not support extended addressing.

Table 49. Which system data sets are candidates for encryption? (continued)

CICS system data set	Candidate for encryption?	Special considerations
Extrapartition Transient Data	Yes, could contain sensitive data.	Encryption is not supported for partitioned data sets (PDS).
Auxiliary Trace data sets (DFHAUXT and DFHBUXT)	Yes, can potentially include sensitive data in the diagnostics. Alternatively, use the <u>CONFDATA</u> system initialization parameter, which might provide sufficient protection.	If trace data is encrypted and you need to send it to IBM for diagnostics, use CICS trace formatting or another method to ensure that you send decrypted data.
CICS dump data sets (DFHDMPA and DFHDMPB)	Yes, can potentially include sensitive data in the diagnostics. Alternatively, use the <u>CONFDATA</u> system initialization parameter, which might provide sufficient protection.	If dump data is encrypted and you need to send it to IBM for diagnostics, use CICS dump formatting or another method to ensure that you send decrypted data. CICS dump data sets support extended format, but do not support extended addressing.
Doctemplate resources	Yes, can potentially contain sensitive data.	Provided that the data set used is of a type for which encryption is supported.
URIMAP resources used for static delivery	Yes, can potentially contain sensitive data.	Provided that the data set used is of a type for which encryption is supported.
BTS repository data sets and BTS local request queue (LRQ) data set	No, contain only control data.	None.
Global and Local catalog data sets (DFHGCD and DFHLCD)	No, contain only configuration data.	Consider only if you believe that CICS configuration data is sensitive information.
CICS system definition data set (DFHCSD)	No, contains only information about resource configuration.	Consider only if you believe that your resource definitions include any sensitive information.
CMAC messages data set (DFHCMACD)	No, contains only message details.	Consider only if you added your own messages that you believe contain sensitive data.
zFS files used for bundle definitions and web services	No, contain only configuration information.	Consider only if you believe that your bundle definitions include any sensitive information.

Related information

Chapter 9. Security for external interfaces

Security for EXCI

CICS applies security checks in a number of ways against requests received from an MVS client program.

Using MRO logon and bind-time security

DFHIRP, the CICS interregion communication program, performs two security checks against users that want to either log on to IRP (specific connections only), or connect to a CICS region (also referred to as bind-time security).

About this task

Generic EXCI connections: The discussion about logon security checking in this section applies only to EXCI connections that are defined as SPECIFIC. The MRO logon security check is not performed for generic connections.

The MVS client program is treated just the same as another CICS region as far as MRO logon and connect (bind-time) security checking is concerned. This means that when the client program logs on to the interregion communication program, IRP performs logon and bind-time security checks against the user ID under which the client program is running. In the remainder of this information, this user ID is called the user ID of the batch region.

To enable your client program to log on to IRP successfully, and to connect to the target server region, first ensure that you define the user ID of the batch region in a user profile to RACF. After you define the user ID of the batch region to RACF, you can then give the batch region the appropriate logon and bind-time authorizations.

Procedure

- Logon authorization

Authorize the user ID of the batch region to the DFHAPPL.*user_name* RACF FACILITY class profile, with UPDATE authority. The *user_name* part of the profile name is the user name defined on the INITIALIZE_USER command.

Failure to authorize the user ID of the batch region to the DFHAPPL profile of the specific user ID logging on to IRP causes Allocate_Pipe processing to fail with RESPONSE(SYSTEM_ERROR) REASON(IRC_LOGON_FAILURE). The subreason field-1 for a logon security check failure returns decimal 204.

See [“Defining DFHAPPL FACILITY class profiles for an EXCI region” on page 334](#) for information about FACILITY class profiles for an EXCI client program.

- Bind-time authorization

Authorize the user ID of the batch region to the DFHAPPL.*applid* RACF FACILITY class profile of the target CICS server region, with READ authority.

Failure to authorize the user ID of the batch region to the DFHAPPL.*applid* profile of the CICS server region causes Open_Pipe processing to fail with RESPONSE(SYSTEM_ERROR) REASON(IRC_CONNECT_FAILURE). The subreason field-1 for a bind-time security check failure returns decimal 176.

See [Bind security](#) for information about the MRO logon and bind-time security checks, and for examples of how to define the RACF DFHAPPL profiles.

Defining DFHAPPL FACILITY class profiles for an EXCI region

Define the *user_name* part of the DFHAPPL profile name as follows:

- For the EXCI CALL interface, the *user_name* must be the name you specify on the *user_name* parameter of the INITIALIZE_USER command.

Define FACILITY class profiles, with appropriate authorizations, for each user name specified in a client program if the program has INITIALIZE_USER commands for more than one user name.

For example, if the *user_name* defined on an INITIALIZE_USER command is DCEUSER1, define the DFHAPPL profile in the FACILITY class as follows:

```
RDEFINE FACILITY (DFHAPPL.DCEUSER1) UACC(NONE)
```

If the batch region's user ID is CLIENTA, authorize the batch region to log on to IRP as follows:

```
PERMIT DFHAPPL.DCEUSER1 CLASS(FACILITY) ID(CLIENTA)  
ACCESS(UPDATE)
```

- For the EXEC CICS LINK command, the *user_name* is preset by the external CICS interface as DFHXCEIP. This does not require authorization for IRP logon, because the EXEC CICS LINK interface uses a generic connection to which the logon security check does not apply.

Link security

The target CICS server region performs link security checking against requests from the client program.

These security checks cover transaction attach security (when attaching the mirror transaction), and resource and command security checking within the server application program. The link user ID that CICS uses for these security checks is the batch region's user ID.

To ensure these link security checks do not cause security failures, you must ensure that the link user ID is authorized to the following resource profiles, as appropriate:

- The profile for the mirror transaction, either CSMI for the default, or the mirror transaction specified on the *transid* parameter. This is required for transaction attach security checking.
- The profiles for all the resources accessed by the CICS server application program—files, queues (transient data and temporary storage), programs, and so on. This is required for resource security checking.
- The CICS command profiles for the SPI commands issued by the CICS server application program—INQUIRE, SET, DISCARD and so on. This is required for command security checking.

See [Bind security](#) for information about MRO link security checking.

User security

The target CICS server region performs user security checking against the user ID passed on a DPL_Request call. User security checking is performed only when connections specify ATTACHSEC(IDENTIFY).

User security is performed in addition to any link security.

For user security, in addition to any authorizations you make for link security, you must also authorize the user ID specified on the DPL_Request call.

Note that there is no provision for specifying a user ID on the EXEC CICS LINK command. In this case, the external CICS interface passes the batch region's user ID. User security checking is therefore performed against the batch region's user ID if the connection definition specifies ATTACHSEC(IDENTIFY).

Note: If your connection resource definitions for the external CICS interface specify ATTACHSEC(IDENTIFY), your server programs will fail with an ATCY abend if you run them in an environment that does not have RACF, or an equivalent external security manager (ESM), installed and active.

If you want to run external CICS interface server programs without any security active, you must specify ATTACHSEC(LOCAL).

Surrogate user checking

A surrogate user check is performed to verify that the batch region's user ID is authorized to issue DPL calls for another user (that is, is authorized as a surrogate of the user ID specified on the DPL_Request call).

EXCI client jobs are subject to surrogate user checking. You must authorize the batch region's user ID as a surrogate of the user ID specified on all DPL_Request calls. This means the batch region's user ID must have READ access to a profile named *execution-userid.DFHEXCI* in the SURROGAT general resource class (where *execution-userid* is the user ID specified on the DPL call). For example, the following commands define a surrogate profile for a DPL user ID, and grant READ access to the EXCI batch region:

```
RDEFINE SURROGAT execution_userid.DFHEXCI UACC(NONE)
PERMIT execution_userid.DFHEXCI CLASS(SURROGAT) ID(batch_region_userid) ACCESS(READ)
```

If no user ID is specified on the DPL_Request call, no surrogate user check is performed because the user ID on the DPL_Request call defaults to the batch region's user ID. For this bypass of surrogate user checking to be successful, ensure that you have correctly omitted the user ID on the DPL_Request call. See the example of EXCI CALLs with null parameters in [The EXCI CALL interface](#) for the correct way to specify a null pointer when omitting an EXCI call parameter.

If the batch region's user ID and the CICS region user ID are different, link security checking is enforced. With link security, a non-authenticated user ID passed on a DPL_Request call cannot acquire more authority than that allowed by the link security check. It can acquire only the same, or less, authority than that allowed by the link security check.

For more information about CICS security, see [Securing overview](#).

Security for ONC RPC

Important: This information contains Product-sensitive Programming Interface and Associated Guidance Information.

Security is an important concern in the provision of ONC RPC support in the CICS environment, because CICS ONC RPC provides an Open Systems communications interface into CICS.

ONC RPC has its own security methods (called authentication in RPC) with dedicated fields in the ONC RPC call and reply message headers. There are three types of RPC authentication:

- **UNIX authentication**, which is used to transmit the client's UNIX user ID, group ID, and other identification information.
- **Data Encryption Standard (DES) authentication**, which is not available at ONC RPC Version 3.9, and so cannot be used with CICS ONC RPC.
- **Null authentication**, which offers no security checking.

This section describes how CICS ONC RPC interacts with the security facilities of ONC RPC and CICS.

Security in ONC RPC

ONC RPC has its own security methods (called authentication in RPC) with dedicated fields in the ONC RPC call and reply message headers.

There are three types of RPC authentication:

- **UNIX authentication**, which is used to transmit the client's UNIX user ID, group ID, and other identification information.
- **Data Encryption Standard (DES) authentication**, which is not available at ONC RPC Version 3.9, and so cannot be used with CICS ONC RPC.

- **Null authentication**, which offers no security checking.

Security in CICS and its effect on CICS ONC RPC operations

During the operation of CICS ONC RPC, various CICS commands are used to make security checks with an external security manager (ESM).

The checks will always give positive results if SEC=NO is specified as a system initialization parameter. The checks will always give negative results if SEC=YES was specified, but the ESM abended while CICS was operating. The following discussion of the use made of CICS security commands assumes that SEC=YES is specified, and that the ESM is active.

- When a transaction whose user ID is *userid1* issues EXEC CICS START USERID(*userid2*), a surrogate-user check is made with the ESM to see that *userid1* is authorized to use *userid2*. The check is made only if XUSER=YES is specified as a system initialization parameter.

This command is issued when the connection manager starts the server controller, and each time the server controller starts an alias transaction. In the first case, the user ID used is the one supplied to the connection manager as CRPM Userid on panel DFHRP02. In the second case, the user ID used is the one output from **Decode**.

- EXEC CICS VERIFY PASSWORD is issued by the alias before it links to the CICS program that services the client request. A check is made with the ESM that the user ID and password are an acceptable combination.
- EXEC CICS QUERY SECURITY is used by the alias to check that the user ID under which it is executing is authorized to use the CICS program. The check is made only if XPPT=YES is specified as a system initialization parameter.
- During the operation of the CICS program, security checks are made each time the program tries to access a protected resource. The check is made only if RESSEC(YES) is specified in the definition of the alias transaction, and the system initialization parameter controlling security checking for the resource type is set to YES.
- During the operation of the CICS program, security checks are made each time the program tries to use a command from the CICS SPI (system programming interface). The check is made only if CMDSEC(YES) is specified in the definition of the alias transaction, and if XCMD=YES is specified as a system initialization parameter.

Figure 30 on page 336 shows how CICS security interacts with the operation of CICS ONC RPC.

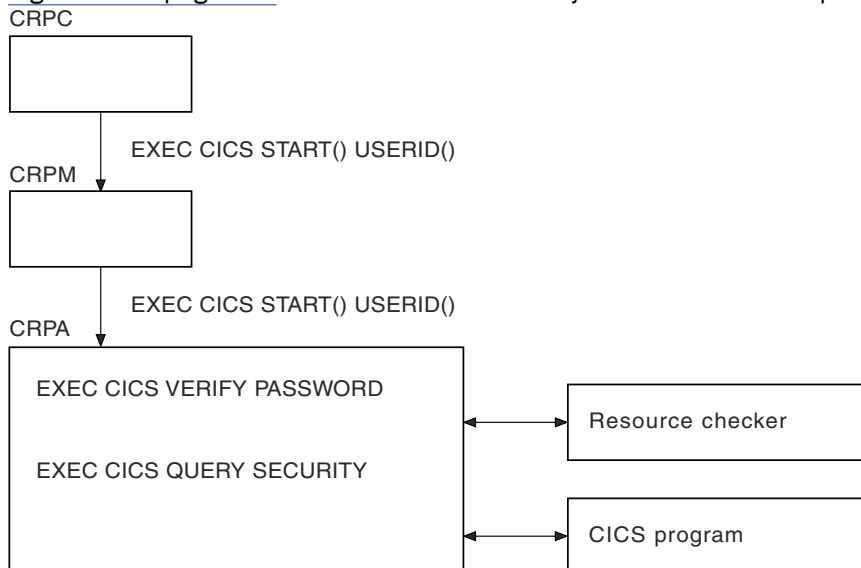

Figure 30. How CICS security interacts with CICS ONC RPC operations

The figure shows that the alias will link to the user-supplied resource checker program if one is configured, but the use of the resource checker program is not recommended. You should use the CICS security facilities, and make the appropriate definitions in the ESM.

RACF Secured Sign-on for ONC RPC clients

RACF Secured Sign-on support allows RPC clients to gain security access to CICS facilities by sending a PassTicket. This avoids the security hazard of a password being transmitted across the network in clear text.

For further information, see *z/OS Security Server RACF System Programmer's Guide*. This includes details of the algorithm that the RPC client must use to generate the PassTicket. This algorithm includes the DES algorithm.

PassTicket generation for ONC RPC clients

The algorithm that generates the PassTicket for an ONC RPC client is a function of the following items:

- The CICS user ID of the client.
- The CICS application ID of the CICS region running CICS ONC RPC.
- A secured sign-on application key, known to both sides.
- A time and date stamp.

To generate the PassTicket, the RPC client must:

- Know its CICS user ID, the server CICS application ID, and the application key.
- Synchronize its clock to within ten minutes of the server.
- Have access to the encryption algorithm on its machine. Only the DES algorithm may be used.

Writing the resource checker

Your resource checker program must be called DFHRPRSC. There can be only one resource checker in a CICS region.

The resource checker allows you to check the credentials of inbound client requests.

The resource checker can check the client address, passed as an input parameter, against a list of known clients for the host on which the request has been received. The password passed to the resource checker is blank.

Reference information for the resource checker

The resource checker is optionally invoked by the alias before it attempts to link to the CICS program that is to service the client request. It must say whether the client request is allowed to proceed.

The reference information for the resource checker is presented as follows:

- A summary table of parameters, showing which are for input only, and which for output only.
 - **Input** is for parameters that your resource checker may consult, but not change.
 - **Output** is for parameters that your resource checker must not consult, but may change.
- A description of the processing that the resource checker is expected to do.
- A list of parameters in alphabetical order, with a description of how CICS ONC RPC sets up the inputs, and what use it makes of the outputs.
- A list of the responses and reason codes that the resource checker can return, with a description of the action that CICS ONC RPC takes for each response and reason code.

The descriptions give the names of the program elements as they appear in C. In COBOL the names are all in uppercase, and the underscores are replaced by hyphens.

Summary of parameters

The format of the communication area containing the resource checker parameters is in the C header file DFHRPRDH, and the COBOL copybook DFHRPRDO. You will also need values defined in the C header file DFHRPUCH, or in the COBOL copybook DFHRPUCO.

Input	Output
res_check_alias_transid res_check_cics_password_ptr res_check_cics_userid res_check_client_ip_address res_check_eyecatcher res_check_host_ip_address res_check_server_program_name	res_check_reason res_check_response

Parameters

res_check_alias_transid

(Input only)

The 4-character name of the alias transaction that has linked to the resource checker.

res_check_cics_password_ptr

(Input only)

A pointer to the 8-character password passed from the requesting client or supplied by **Decode**. The value of this field is blank, and it is provided for compatibility with earlier versions of CICS ONC RPC.

res_check_cics_userid

(Input only)

The 8-character CICS user ID under which the alias is running.

res_check_client_ip_address

(Input only)

The fullword internet address of the client.

res_check_eyecatcher

(Input only)

A string of length 8. (Its value is defined in the header file DFHRPUCH and the copybook DFHRPUCO).

res_check_host_ip_address

(Input only)

The fullword internet address of the z/OS Communications Server host with which the server controller is in communication.

res_check_reason

(Output only)

The reason to be returned to the alias.

res_check_response

(Output only)

The response to be returned to the alias.

res_check_server_program_name

(Input only)

The 8-character name of the CICS program that is to be invoked to perform the server function requested by the client.

Response and reason codes

You must return one of the following values in the **res_check_response** field.

URP_OK

The alias will continue to process the client request.

URP_EXCEPTION

The alias writes an exception trace entry (trace point 9F0E), and issues a message that depends on the reason code:

- URP_AUTH_BADCRED—message DFHRP0130
An **svcerr_auth** call with a why-value of AUTH_BADCRED is used to send a reply to the client.
- URP_AUTH_TOOWEAK—message DFHRP0184
An **svcerr_auth** call with a why-value of AUTH_TOOWEAK is used to send a reply to the client.
- Any other value—message DFHRP0185
An **svcerr_systemerr** call is used to send a reply to the client.

URP_INVALID

The alias writes an exception trace entry (trace point 9F0E), and issues a message (DFHRP0186).

An **svcerr_systemerr** call is used to send a reply to the client.

URP_DISASTER

The alias writes an exception trace entry (trace point 9F0E), and issues a message (DFHRP0187).

An **svcerr_systemerr** call is used to send a reply to the client.

If you return any other value in **res_check_response**, the alias writes an exception trace entry (trace point 9F0E), and issues a message (DFHRP0188). An **svcerr_systemerr** call is used to send a reply to the client.

You can supply a 32-bit reason code in conjunction with the response value to provide further information in error cases. CICS ONC RPC does not take any action on the reason code returned by the resource checker, except as indicated previously under URP_EXCEPTION. The reason code is output in any trace or messages that result from the resource checker, and you may use it as a debugging aid.

See [Numeric values of response and reason codes](#) for the numeric values of the response and CICS-defined reason codes in trace output.

Chapter 10. Security for Java applications

You can secure Java applications to ensure that only authorized users can deploy and install applications, and access those applications from the web or through CICS. You can also use a Java security manager to protect the Java application from performing potentially unsafe actions.

You can add security at different points in the Java application lifecycle:

- Implement security checking for defining and installing Java application resources. Java applications are packaged in CICS bundles, so you must ensure that users who are allowed to install applications in the JVM server can install this type of resource.
- Implement security checking for application users to ensure that only authorized users can access an application.
- Implement security checking for CICS Java tasks that are started using the `CICSExecutorService`. All such CICS tasks run under the `CJSA` transaction and the default user ID.
- Implement security restrictions on the Java API by using a Java security manager.

Java applications can run in an OSGi framework or a Liberty server. Liberty is designed to host web applications and includes an OSGi framework. The security configuration for a Liberty server is different, because Liberty has its own security model.

To configure security for OSGi applications, use CICS resource security to authorize which users can manage the lifecycle of the `JVMSEVER` and the Java applications. Use CICS transaction security to determine who can access the application.

Configuring security for OSGi applications

Use CICS resource security to authorize which users can manage the lifecycle of the `JVMSEVER` and the Java applications. Use CICS transaction security to determine who can access the application.

Procedure

- Authorize application developers and system administrators to create, view, update, and remove `JVMSEVER` and `BUNDLE` resources as appropriate. The `JVMSEVER` resource controls the availability of the JVM server. The `BUNDLE` resource is a unit of deployment for the Java application and controls the availability of the application.
- Authorize users to run the application by ensuring the relevant user ID is allowed to attach the transaction under which the application will run.

Results

You have successfully configured security for Java applications that run in an OSGi framework.

Configuring security for a Liberty JVM server

You can use the CICS Liberty security feature to authenticate users and authorize access to web applications through Java Platform, Enterprise Edition roles (Java EE roles), providing integration with CICS transaction and resource security. You can also use CICS resource security to authorize the appropriate users to manage the lifecycle of both the `JVMSEVER` resource and Java web applications that are deployed in a CICS `BUNDLE` resource. In this topic, authentication verifies the identity of a given user, typically by requiring the user to enter a username and password. Authorization grants access control permissions based on the identity of the authenticated user.

Before you begin

1. Ensure that the CICS region is configured to use SAF security and is defined with SEC=YES as a system initialization parameter.
2. Authorize application developers and system administrators to create, view, update, and remove JVMSERVER and BUNDLE resources to deploy web applications into a Liberty JVM server.

The JVMSERVER resource controls the availability of the JVM server, and the BUNDLE resource is a unit of deployment for the Java applications and controls the availability of the applications. The default behavior of the CICS TS security feature, `cicsts:security-1.0`, is to use the SAF registry. If you use an LDAP registry, a SAF registry is not created, for more information, see [Configuring security for a Liberty JVM server by using distributed identity mapping](#). The basic user registry (which is also used by `quickStartSecurity`) is only suitable for simple security testing. Be aware that if you configure and run with basic user registry and you need to switch to `cicsts:security-1.0`, you need to delete the session tokens.

About this task

This task explains how to configure security for a Liberty JVM server and integrate Liberty security with CICS security. For information about how to configure security for Link to Liberty, see [Linking to a Java EE application from a CICS program](#).

The default transaction ID for running web requests is CJSA. However, you can configure CICS to run web requests under a different transaction ID by using a URIMAP of type JVMSERVER. Typically, you might specify a URIMAP to match the generic context root (URI) of a web application to scope the transaction ID to the set of servlets that make up the application. Or you might choose to run each individual servlet under a different transaction with a more precise URI.

The default user ID for running web requests is the CICS default user ID. If a URIMAP is available and contains a static user ID, it is used in preference to the default user ID. If the web request contains a user ID in its security header, it takes precedence over all other mechanisms.

Tasks that emanate from Liberty that are not classified as web requests run under the CJSU transaction by default. Although there is no URIMAP style mechanism for these types of tasks, you can override the default transaction ID by using the JVM profile property of `com.ibm.cics.jvmserver.unclassified.tranid` and the default user ID by using the JVM profile property `com.ibm.cics.jvmserver.unclassified.userid`.

Note: The user ID requires permission to attach the specified transaction. For more information, see [Transaction security](#).

Procedure

1. Configure the Liberty angel process to provide authentication and authorization services to the Liberty JVM server, see [The Liberty server angel process](#).

Tip: If you have a named angel process, you need to configure your Liberty JVM server to connect to it by adding the following line to your JVM profile.

```
-Dcom.ibm.ws.zos.core.angelName=<named_angel>
```

2. Optional: Enforce the requirement to connect to the Liberty angel process when the Liberty JVM server is being enabled by adding the following line to your JVM profile:

```
-Dcom.ibm.ws.zos.core.angelRequired=true
```

This option prevents the Liberty JVM server from starting if the angel process is unavailable.

With CICS TS V5.4 with APAR PI92676 or later, this option instructs CICS to call the Liberty angel check API to verify whether an angel process is available for Liberty JVM server startup.

If the angel process is unavailable, CICS reacts as follows:

- If the Liberty JVM server is being enabled through the CEMT transaction, a message is issued, and the Liberty JVM server is disabled.
- If the Liberty JVM server is being enabled by the **SET JVMSERVER** SPI command or by using the CMCI through the CICS Explorer, a message is issued, and the Liberty JVM server is disabled.
- If the Liberty JVM server is being enabled by the CICS CREATE SPI, by BAS, or from GRPLIST, a message is issued, and CICS will wait 30 seconds before retrying the Liberty angel check API call. If the angel process is unavailable on the fifth attempt, a WTOR message is issued, giving the operator the option to continue waiting or to disable the JVMSERVER resource.

3. Add the `cicsts:security-1.0` feature to the **featureManager** list in the `server.xml`,

```
<featureManager>
...
  <feature>cicsts:security-1.0</feature>
</featureManager>
...
```

4. Add the System Authorization Facility (SAF) registry to `server.xml` by using the following example:

```
<safRegistry id="saf" enableFailover="false"/>
```

5. Save the changes to `server.xml`.

6. Optional: Alternatively, if you are autoconfiguring the Liberty JVM server and the **SEC** system initialization parameter is set to YES in the CICS region, the Liberty JVM server is dynamically configured to support Liberty JVM security when the JVM server is restarted. For more information, see [Configuring a Liberty JVM server](#).

If the **SEC** system initialization parameter is set to NO, you can still use Liberty security for authentication or SSL support. If CICS security is turned off, and you want to use a Liberty security, you must configure the `server.xml` file manually:

- a. Add the `appSecurity-2.0` feature to the **featureManager** list.
- b. Add a user registry to authenticate users. Liberty security supports SAF, LDAP, and basic user registries. For more information, see [Configuring a user registry in Liberty](#).
- c. Add security-role definitions to authorize access to application resources, see [“Authorizing users to run applications in a Liberty JVM server”](#) on page 348.

Results

The web container is automatically configured to use the z/OS® Security feature of Liberty. A SAF registry is used for authentication, and Java EE roles are respected for authorization. Authorization constraints and security roles govern who can access the application. These are usually defined in the deployment descriptor (`web.xml`) of the application, but might also be defined as security annotations in the source-code. Typically, users and groups are mapped to roles by the applications `<application-bnd>` element in `server.xml`. Alternatively, if the `<safAuthorization>` element is configured in `server.xml`, the mappings are held in SAF (as EJBROLES in RACF).

What to do next

Note: You can also delegate authentication to another identity by configuring the RunAs specification for Liberty, see [Configuring RunAs authentication in Liberty](#).

- Configure Liberty application security authentication rules, see [“Authenticating users in a Liberty JVM server”](#) on page 346.
- Define authorization rules for web applications, see [“Authorizing users to run applications in a Liberty JVM server”](#) on page 348 and [“Authorization using SAF role mapping”](#) on page 352.
- Modify the Liberty authentication cache.

For more information about using Secure Sockets Layer (SSL), see [“Configuring SSL \(TLS\) for a Liberty JVM server using a Java keystore”](#) on page 357.

The Liberty angel process

When you include the `cicsts:security-1.0` feature, the CICS Liberty JVM server uses the angel process to call z/OS authorized services such as System Authorization Facility (SAF).

Optionally, you can name an angel process. If an angel process is not given a name, it becomes the default angel process. You can only have one default angel process. If you try to create another, it will fail to start. All the Liberty servers that are running on a z/OS image can share a single angel process. This is regardless of the level of code that the servers are running or whether they are running in a CICS JVM server. For further information on named angel processes, see [Named angel](#).

Important: Install the latest version of the angel process, regardless of which product it is bundled with. The latest version might be bundled with other IBM software, and might supersede the version that is bundled with CICS.

Running the angel process started task

1. Locate the JCL procedure for the **started** task in the USSHOME directory, for example: `/usr/lpp/cicsts54/wlp/templates/zos/procs/bbgzangl.jcl`
2. Modify and copy the JCL procedure to a JES procedure library. You can set **ROOT** to the value of USSHOME/wlp, for example: `ROOT=/usr/lpp/cicsts54/wlp`
3. Start the angel process. In the following examples, `[.identifier]` indicates an optional identifier that can be up to 8 characters.
 - a. To start the angel process without naming it, use the following command:

```
START BBGZANGL[.identifier]
```

- b. To start the angel process as a named angel process, code the NAME parameter on the operator START command. For example:

```
START BBGZANGL[.identifier],NAME=<named_angel>
```

The angel process name is 1 - 54 characters inclusive, and must use only the following characters: A-Z 0-9 ! # \$ + - / : < > = ? @ [] ^ _ ` { } | ~

Note: A Liberty server can use its own named angel process. One benefit of this isolation is that the angel process can be serviced without affecting any other Liberty server instances on the LPAR. The angel process must be running before the Liberty JVM server starts.

4. Start the Liberty JVM server. By default, the server connects to the unnamed angel process if one is available. To connect to a specific angel process, set the `com.ibm.ws.zos.core.angelName` property in the JVM server profile, for example:

```
-Dcom.ibm.ws.zos.core.angelName=named_angel
```

5. You can specify that CICS checks for the presence of a running angel process before enabling, by setting the `com.ibm.ws.zos.core.angelRequired` property in the JVM server profile to true. For example:

```
-Dcom.ibm.ws.zos.core.angelRequired=true
```

The server fails if the angel process is not available during startup. Use of this property allows a quicker and cleaner failure.

Interacting with the angel process started task

In the following examples, `[.identifier]` indicates an optional identifier that can be up to eight characters.

- Display the Liberty JVM servers that are connected to the angel process:

```
MODIFY BBGZANGL[.identifier],DISPLAY,SERVERS,PID
```

A list of job names and process identifiers (PID) are displayed:

```
15.48.45 STC82204 CWWKB0067I ANGEL DISPLAY OF ACTIVE SERVERS
15.48.45 STC82204 CWWKB0080I ACTIVE SERVER ASID 5c JOBNAME IYK3ZNA1 PID 83953428
15.48.45 STC82204 CWWKB0080I ACTIVE SERVER ASID 5c JOBNAME IYK3ZNA1 PID 33621002
```

Each Liberty JVM server runs under a unique PID, and is returned by the CICS command **INQUIRE JVMSEVER**.

- Stop the angel process.

```
STOP BBGZANGL[.identifier]
```

Note: The Liberty JVM server must be stopped before restarting or applying maintenance to the angel process.

SAF profiles used by the angel process

This section describes the SAF profiles to which access is required for CICS processing. For information on the full set of SAF profiles defined by Liberty, refer to [Enabling z/OS authorized services on Liberty for z/OS](#).

- The Liberty JVM server runs under the authority of the CICS region user ID. This user ID must be able to connect to the angel process to use authorized services. The user ID that the angel process runs under needs access to the SAF `STARTED` profile, for example:

```
RDEFINE STARTED BBGZANGL.* UACC(NONE) STDATA(USER(WLPUSER))
SETROPTS RACLIST(STARTED) REFRESH
```

- For the Liberty JVM server to connect to an angel process, create a profile for the angel (**BBG.ANGEL**, or **BBG.ANGEL.<namedAngelName>** if you are using a named angel process) in the **SERVER** class. Give the CICS region user ID (*cics_region_user*) authority to access it, for example, in RACF:

```
RDEFINE SERVER BBG.ANGEL UACC(NONE)
PERMIT BBG.ANGEL CLASS(SERVER) ACCESS(READ) ID(cics_region_user)
```

- For a Liberty server to use the z/OS authorized services, create a **SERVER** profile for the authorized module **BBGZSAFM** and give the CICS region user ID (*cics_region_user*) to the profile:

```
RDEFINE SERVER BBG.AUTHMOD.BBGZSAFM UACC(NONE)
PERMIT BBG.AUTHMOD.BBGZSAFM CLASS(SERVER) ACCESS(READ) ID(cics_region_user)
```

- Give the Liberty JVM server, under the authority of the CICS region user ID (*cics_region_user*), access to the SAF user registry and SAF authorization services (**SAFCRED**) in the **SERVER** class. For example, in RACF:

```
RDEFINE SERVER BBG.AUTHMOD.BBGZSAFM.SAFCRED UACC(NONE)
PERMIT BBG.AUTHMOD.BBGZSAFM.SAFCRED CLASS(SERVER) ACCESS(READ) ID(cics_region_user)
```

- Create a **SERVER** profile for the **IFAUSAGE** services (**PRODMGR**) and allow the CICS region user ID access to it. This allows the Liberty JVM server to register and unregister from **IFAUSAGE** when the CICS JVM server is enabled and disabled:

```
RDEFINE SERVER BBG.AUTHMOD.BBGZSAFM.PRODMGR UACC(NONE)
PERMIT BBG.AUTHMOD.BBGZSAFM.PRODMGR CLASS(SERVER) ACCESS(READ) ID(cics_region_user)
```

- Refresh the **SERVER** resource:

```
SETROPTS RACLIST(SERVER) REFRESH
```

The following table summarizes the SAF security profiles used by a Liberty server running in a CICS JVM server.

Table 50. SAF profile table for CICS Liberty security

Class	Profile	CICS region user ID 1	Unauthenticated user ID 2	Authenticated user ID 3
Required for angel process registration at Liberty server startup				
SERVER	BBG.ANGEL	READ		
SERVER	BBG.ANGEL.<namedAngelName>	READ		
SERVER	BBG.AUTHMOD.BBGZSAFM	READ		
SERVER	BBG.AUTHMOD.BBGZSAFM.SAFCREAD	READ		
SERVER	BBG.AUTHMOD.BBGZSAFM.PRODMGR	READ		
Required for authentication or authorization				
SERVER	BBG.SECPFX.BBGZDFLT 4	READ		
APPL	BBGZDFLT 4		READ	READ
EJBROLE	BBGZDFLT.<resource>.<role> 5			READ

1. User ID that is associated with the CICS job or started task.
2. User ID used for unauthenticated requests in Liberty. The value is controlled using the `unauthenticatedUser` attribute of the `<safCredentials>` element. This defaults to `WSGUEST`.
3. User ID authenticated by the Liberty server.
4. `BBGZDFLT` is the default value for the security profile prefix which is set using the `profilePrefix` attribute of the `<safCredentials>` element, for example: `<safCredentials profilePrefix="BBGZDFLT"/>`.
5. `EJBROLE` profiles are required if the `<safAuthorization>` element is configured. The default pattern for the profile is controlled by the `SAF` role mapper element which defaults to `<safRoleMapper profilePattern="%profilePrefix%.%resource%.%role%"/>`.

For more information, see [Liberty: Process types on z/OS](#).

Authenticating users in a Liberty JVM server

Although you can configure CICS security for all web applications that run in a Liberty JVM server, the web application will only authenticate users if it includes a security constraint. The security constraint is defined by an application developer in the deployment descriptor (`web.xml`) of the Dynamic Web Project or OSGi Application Project. The security constraint defines what is to be protected (URL) and by which roles.

A `<login-config>` element defines the way a user gains access to web container and the method used for authentication. The supported methods are either HTTP basic authentication, form based authentication or SSL client authentication. For further details on how to define application security for CICS see [SSL security for Explorer connections in the CICS Explorer product documentation](#). Here is an example of those elements in `web.xml`:

```
<!-- Secure the application -->
<security-constraint>
  <display-name>com.ibm.cics.server.examples.wlp.tsq.web_SecurityConstraint</display-name>
  <web-resource-name>com.ibm.cics.server.examples.wlp.tsq.web</web-resource-name>
  <description>Protection area for com.ibm.cics.server.examples.wlp.tsq.web</description>
  <url-pattern>/*</url-pattern>
</web-resource-collection>
<auth-constraint>
```

```

    <description>Only SuperUser can access this application</description>
    <role-name>SuperUser</role-name>
  </auth-constraint>
  <user-data-constraint>
    <!-- Force the use of SSL -->
    <transport-guarantee>CONFIDENTIAL</transport-guarantee>
  </user-data-constraint>
</security-constraint>

<!-- Declare the roles referenced in this deployment descriptor -->
<security-role>
  <description>The SuperUser role</description>
  <role-name>SuperUser</role-name>
</security-role>

<!-- Determine the authentication method -->
<login-config>
  <auth-method>BASIC</auth-method>
</login-config>

```

Note: If you use `RequestDispatcher.forward()` methods to forward requests from one servlet to another, the security check occurs only on the first servlet that is requested from the client.

Tasks that are authenticated in CICS using Liberty security can use the user ID derived from any of the Liberty application security mechanisms to authorize transaction and resource security checks in CICS. The CICS user ID is determined according to the following criteria:

1. Liberty application security authentication.

Integration with the SAF user registry is part of the CICS Liberty security feature, unless distributed identity mapping is used. Any of the application security mechanisms supported by Liberty are supported in CICS, this includes HTTP basic authentication, form login, SSL client certificate authentication, identity assertion using a custom login module, JACC, JASPIC, or a Trust Association Interceptor (TAI). All SAF user IDs authenticated by Liberty must be granted read access to the Liberty JVM server APPL class profile. The name of this is determined by the `profilePrefix` setting in the `safCredentials` element in the Liberty server configuration file `server.xml`.

```
<safCredentials profilePrefix="BBGZDFLT" />
```

The APPL class is also used by CICS terminal users to control access to specific CICS regions and your Liberty JVM server can use the same profile as the CICS APPLID depending upon your security requirements. If you do not specify this element, then the default `profilePrefix` of `BBGZDFLT` is used.

You must define the APPLID and users must have access to the it. To configure and activate the `BBGZDFLT` profile in the APPL class:

```
RDEFINE APPL BBGZDFLT UACC(NONE)
SETROPTS CLASSACT(APPL)
```

The users must be given read access to the `BBGZDFLT` profile in the APPL class in order to authenticate. To allow user `AUSER` to authenticate against the `BBGZDFLT` APPL class profile:

```
PERMIT BBGZDFLT CLASS(APPL) ACCESS(READ) ID(AUSER)
```

The Liberty SAF unauthenticated user id must be given read access to the APPL class profile. The SAF unauthenticated user id can be specified in the `safCredentials` element in the Liberty server configuration file `server.xml`.

```
<safCredentials unauthenticatedUser="WSGUEST" />
```

If you do not specify the element, then the default `unauthenticatedUser` is `WSGUEST`. To allow the SAF unauthenticated user id `WSGUEST` read access to the `BBGZDFLT` profile in the APPL class:

```
PERMIT BBGZDFLT CLASS(APPL) ACCESS(READ) ID(WSGUEST)
```

If you use `WSGUEST`, then you should follow the steps to configure the SAF user registry as described in [Setting up the System Authorization Facility \(SAF\) unauthenticated user](#).

The WLP z/OS System Security Access Domain (WZSSAD) refers to the permissions granted to the Liberty server. These permissions control which System Authorization Facility (SAF) application domains and resource profiles the server is permitted to query when authenticating and authorizing users. The CICS region user ID must be granted permission within the WZSSAD domain to make authentication calls. To grant permission to authenticate, the CICS region ID must be granted READ access to the BBG.SECPFX.<APPL> profile in the SERVER class:

```
RDEFINE SERVER BBG.SECPFX.BBGZDFLT UACC(NONE)
PERMIT BBG.SECPFX.BBGZDFLT CLASS(SERVER) ACCESS(READ) ID(cics_region_user)
```

For more details refer to [Liberty: Accessing z/OS security resources using WZSSAD](#).

2. If an unauthenticated subject is supplied from Liberty, then the USERID defined in the URIMAP will be used.
3. If no USERID is defined in the URIMAP the request will run under the CICS default user ID.

Note:

Due to the way that security processing for Liberty transactions is deferred during CICS transaction attach processing, the user ID used in the CICS Monitoring Facility (CMF) records, the z/OS Workload Manager (WLM) classification, and the task association data and the UEPUSID global user exits field for the XAPADMGR exit, will be determined as follows; the user ID in the HTTP security header, or if there isn't one, the user ID taken from matching URIMAP. If neither exist, the CICS default user ID will be used.

Be aware that Liberty caches authenticated user IDs and, unlike CICS, does not check for an expired user ID within the cache period. You can configure the cache timeout by using the standard Liberty configuration process. Please see [Configuring the authentication cache in Liberty](#).

Authorizing users to run applications in a Liberty JVM server

You can use Java EE application security roles to authorize access to Java EE applications. Additionally, in a Liberty JVM server you can further restrict access to transactions (run as part of the application) by using CICS transaction and resource security.

About this task

Your application is secured by providing an authorization constraint, the <auth_constraint> element, in the deployment descriptor (web.xml). If present, this ensures that access to your application is achieved only by a user that is a member of an authorized role. User or group membership to a Java EE role is determined in one of two ways:

- Use an <application-bnd> element in the <application> element of your server.xml to describe the user/group to role mappings directly in XML.
- Use <safAuthorization> in your server.xml to allow users/groups role membership to be mapped by SAF (typically using EJBROLES).

For more information, see [Authorization using SAF role mapping](#).

Using CICS security allows you to re-use existing security procedures but requires that individual web applications are accessed from different URIMAPs. Using role-based security allows you to use existing standard Java EE security definitions from another Java EE application server. For more information, see [“Authenticating users in a Liberty JVM server”](#) on page 346.

If you want to use CICS transaction and resource authorization exclusively, or prefer to use finer-grained annotation-based role checking in code, you can defer the authorization decision to those components by using the special subject ALL_AUTHENTICATED_USERS role, as shown in the following example. If you deploy a Liberty application in a CICS bundle, CICS automatically configures this for you.

Note: Access checks are performed for the declarative security annotations and CICS transaction and resource security only after the configured constraints (web.xml) are verified

```
<application id="com.ibm.cics.server.examples.wlp.tsq.app"
name="com.ibm.cics.server.examples.wlp.tsq.app" type="eba"
```

```

location="${server.output.dir}/installedApps/com.ibm.cics.server.examples.wlp.tsq.app.eba">
<application-bnd>
  <security-role name="cicsAllAuthenticated">
    <special-subject type="ALL_AUTHENTICATED_USERS"/>
  </security-role>
</application-bnd>
</application>

```

Using this special subject, and giving the `cicsAllAuthenticated` role access to all URLs in your web applications deployment descriptor (`web.xml`), allows access to the web application using any authenticated user ID and authorization to the transaction must be controlled using CICS transaction security. If you deploy your application directly to the dropins directory, it is not configured to use CICS security as dropins does not support security.

If you are using `safAuthorization` then the `<application-bnd>` no longer acts as the source of user ID to role mapping. Instead, EJBROLEs in SAF determine which SAF users are in which roles (EJBROLEs). With `safAuthorization` the `<application-bnd>` is ignored. To achieve the same effect and allow all authenticated users to be authorized to run your application, the `<auth-constraint>` in `web.xml` must use the special role `**`, for example:

```

<auth-constraint>
  <description>special role for all authenticated users</description>
  <role-name>**</role-name>
</auth-constraint>

```

- The special role name `**` is a shorthand for any authenticated user independent of role.
- The special role name `*` is a shorthand for all role names defined in the deployment descriptor.

When the special role name `**` appears in an authorization constraint, it indicates that any authenticated user, independent of role, is authorized to perform the constrained requests. Special roles do not need an additional `<security-role>` declaration in `web.xml`.

To use CICS transaction or resource security you should follow the following steps:

Procedure

1. Define a URIMAP of type JVMSERVER for each web application. Typically, you might specify a URIMAP to match the generic context root (URI) of a web application to scope the transaction ID to the set of servlets that make up the application. Or you may choose to run each individual servlet under a different transaction with a more precise URI.
2. Authorize all users of the web application to use the transaction specified in the URIMAP using CICS transaction or resource security profiles.

Authorization using OAuth 2.0

OAuth 2.0 is an open standard for delegated authorization. With the OAuth authorization framework, a user can grant a third-party application access to information that is stored with another HTTP service without sharing their access permissions or the full extent of their data.

WebSphere Liberty supports OAuth 2.0, and can be used as an OAuth service provider endpoint and an OAuth protected resource enforcement endpoint. Liberty supports persistent OAuth 2.0 services. See [Configuring persistent OAuth 2.0 services](#) for more information. Clients can be defined locally with the `localStorage` and `client` elements. This guide will use local clients to enable OAuth 2.0 authorization.

Before you begin

SAF security is a common use-case in CICS, and this procedure uses SAF in the examples.

Ensure that the CICS region is configured to use SAF security and is defined with `SEC=YES` as a system initialization parameter.

Optionally, you can grant an administrator user access to the SAF EJBROLE `BBGZDFLT.com.ibm.ws.security.oauth20.clientManager`. The security role `clientManager`

controls access to the management interfaces, allowing local clients to be queried, and persistent local clients to be created. The administrator user controls OAuth 2.0 local clients.

Configure the Liberty angel process to provide authentication and authorization services to the Liberty JVM server; for more information see [The Liberty server angel process](#).

For background information on OAuth, see [oauth-2.0](#).

About this task

The following procedure covers how to:

- Create an OAuth 2.0 service provided in a Liberty JVM server
- Create a locally configured client
- Use this local client to grant an OAuth 2.0 token to a relying party application, also known as a third-party web application
- Use this token to access protected resources in an application

Restriction: Db2 JDBC type 2 connectivity is not supported for persistent OAuth 2.0 services.

Procedure

1. Configure an OAuth 2.0 service provider.

- a) Add the `oauth-2.0` and the `cicsts:security-1.0` features to the `featureManager` element in `server.xml`.

```
<featureManager>
  ...
  <feature>oauth-2.0</feature>
  <feature>cicsts:security-1.0</feature>
</featureManager>
...
```

- b) Configure an OAuth 2.0 provider in `server.xml`.

```
<oauthProvider id="myProvider">
</oauthProvider>
```

2. Configure a local client for the relying party application. Local clients define the details of the relying party application, including the name, secret password and redirect URI of the application.

- a) Define a meaningful local client name and create a secret password which is used by the server for authorization. The local client application listens on a URI, and the server supplies authorization codes.
- b) Configure an OAuth 2.0 local client in the `oauthProvider` element of `server.xml`, supplying the local client ID, secret password and the redirect URI.

```
<oauthProvider id="myProvider">
  <localStore>
    <client id="myClient" redirect="https://client.example.ibm.com/webApp/redirect"
    secret="mySecret" />
  </localStore>
</oauthProvider>
```

Important:

Although it is not shown in this example, it is important to encode passwords and limit access to `server.xml` configuration. Passwords can be encoded using the Liberty `securityUtility`, found in `USS_HOME/wlp/bin/securityUtility`. For more information, see [Liberty: securityUtility command](#).

Note: More than one local client can be configured in the `localStore` element.

3. When the relying party application requires access to protected resources on the server, the user must authorize access to these resources first.

- a) The relying party application requires the user to authenticate with the server, and select the type of access for the relying party application by linking or redirecting the user to the authorization endpoint:

```
https://hostname:port/oauth2/endpoint/provider_name/authorize
```

or

```
https://hostname:port/oauth2/declarativeEndpoint/provider_name/authorize
```

Additional parameters are required in the query parameters of the URL. For the local client that was configured in step two, the following GET request is required:

```
https://zos.example.ibm.com/oauth2/endpoint/myProvider/authorize?
response_type=code&client_id=myClient&client_secret=mySecret&redirect_uri=https://
client.example.ibm.com/webApp/redirect
```

When the user has selected the access for the relying party application, they are redirected back to the relying party application using the redirect URI:

```
https://client.example.ibm.com/webApp/redirect?code=access_code
```

The relying party application must store this access code to request an OAuth token.

Note: For local clients, the user must exist in a user register in the Liberty JVM server. See [Authenticating users in a Liberty JVM server](#) for more information on authenticating users in Liberty JVM servers.

- b) The relying party application requests an OAuth 2.0 token by sending a POST request to the server:

```
https://hostname:port/oauth2/endpoint/provider_name/token
```

The relying party application sends the authorization code received from the authorization endpoint, the local client ID, and secret password in the POST data:

```
POST https://zos.example.ibm.com/oauth2/endpoint/myProvider/token HTTP/1.1
Content-Type: application/www-form-urlencoded

grant_type=authorization_code&code=code&client_id=myClient&client_secret=mySecret&redirect
_url=https://client.example.ibm.com/webApp/redirect
```

This returns a JSON document containing the token.

4. Use the token to access protected resources.

- a) Add the token to the Authorization header on the HTTP request.

Authorization: Bearer <token>

Results

Users are able to authorize third-party applications to access their protected resources in a Liberty JVM server through OAuth 2.0 authorizations flows. The Liberty JVM server can configure the provider of these tokens and create locally configured clients.

There are several methods of granting tokens, for more information, see [OAuth 2.0 service invocation](#).

Configuring persistent OAuth 2.0 services

WebSphere Liberty supports persisting OAuth 2.0 local clients and tokens to a database. With persistent OAuth 2.0, an authorized local client can continue to access OAuth 2.0 services after a restart.

Before you begin

SAF security is a common use-case in CICS, and this procedure uses SAF in the examples.

- Gain the necessary access to create tables and read/write to these tables in a database and configure it in the Liberty server.xml.
- Grant access to the SAF EJBROLE BBGZDFLT.com.ibm.ws.security.oauth20.clientManager to an administrator user to control OAuth 2.0 local clients.
- Create an OAuth 2.0 provider in the Liberty server.xml. For more information, see [Authorization using OAuth 2.0](#).

About this task

The following steps create a persistent OAuth 2.0 local client. This local client is used to grant OAuth 2.0 tokens.

Restriction: Db2 JDBC type 2 connectivity is not supported for persistent OAuth 2.0 services.

Procedure

1. Create the necessary tables using [IBM Db2 for persistent OAuth services](#) as a guide.
2. Create a persistent local client by sending a POST request to the URL:

```
https://hostname:port/oauth2/endpoint/provider_name/registration
```

Use the JSON document which is described in the first table in [Configuring an OpenID Connect Provider to accept client registration requests](#); for example:

```
{
  "client_id": "client_id",
  "client_secret": "client_secret",
  "grant_types": [ "authorization_code", "refresh_token" ],
  "redirect_uris": [ "https://client.example.ibm.com/webApp/redirect" ]
}
```

Results

A persistent OAuth 2.0 local client is created. When this local client is used to produce tokens, the tokens are persisted to the database. If the server restarts, the persistent local client and tokens remain valid.

Authorization using SAF role mapping

Mapping Java EE roles to users and groups can be achieved in different ways. In distributed systems, a basic registry or LDAP registry would typically be used in conjunction with an application specific <application-bnd> element, to map users from those registries into *roles*. The deployment descriptor of the application determines which roles can access which parts of the application.

About this task

On z/OS, there is an additional registry type, the System Authorization Facility (SAF) registry. A Liberty JVM server implicitly uses this type for authentication when the cicsts:security-1.0 feature is installed unless configured to use LDAP. You can choose to make use of SAF authorization. When using SAF authorization, user to role mappings are used to map roles to EJBROLE resource profiles using the SAF role mapper. The server queries SAF to determine if the user has the required READ access to the EJBROLE resource profile.

In a Liberty JVM server, if you want to use Java EE roles without SAF authorization, you cannot use CICS bundles to install your applications. This is because a CICS bundle installed application automatically creates an <application-bnd> element and uses the ALL_AUTHENTICATED_USERS special-subject, which prevents you from defining the element yourself. Instead, you must create an <application> element in server.xml directly and configure the <application-bnd> with the roles and users you require.

If, however, you choose to use Java EE roles and SAF authorization, you can continue to use CICS bundles to lifecycle your web applications. The <application-bnd> is ignored by Liberty in favor of using

the role mappings determined by the SAF registry. Role mappings are determined by virtue of a user belonging to an EJB role.

Tip: Special subjects ALL_AUTHENTICATED_USERS and EVERYONE can not be used when SAF authorization is enabled.

Tip: It is advisable to create or update your EJB roles before starting the CICS region. Liberty issues a RACROUTE REQUEST=LIST with GOBAL=NO in order to support a minimum version of z/OS. The address space will not see updates until it is restarted (or started).

Procedure

1. Add the `<safAuthorization id="saf"/>` element to your `server.xml`. If you are using the `cicsts:distributedIdentity-1.0` feature, this is defined for you.
2. Create the EJB roles you require, with reference to the prefix scheme described.
3. Add users to those EJB roles.

By default, if SAF authorization is used the application will use the pattern `<profile_prefix>.<resource>.<role>` to determine if a user is in a role. The `profile_prefix` defaults to `BBGZDFLT` but can be modified using the `<safCredential>` element. For more information, see [Liberty: Accessing z/OS security resources using WZSSAD](#).

The role mapping preferences can be modified using the `<safRoleMapper>` element in the `server.xml` that defaults to

```
<safRoleMapper profilePattern="myprofile.%resource%.%role%" toUpperCase="true"/>
```

Users can then be authorized to a particular EJB role using the following RACF commands, where `WEBUSER` is the authenticated user ID.

```
RDEFINE EJBROLE BBGZDFLT.MYAPP.ROLE UACC(NONE)
PERMIT BBGZDFLT.MYAPP.ROLE CLASS(EJBROLE) ACCESS(READ) ID(WEBUSER)
```

4. Optional: If you are deploying the CICS servlet examples and want to use the Java EE role security with SAF authorization, create a SAF EJBROLE for each servlet that you have deployed. For example, if you use the default `APPL` class of `BBGZDFLT`, define the following EJBROLE security definitions:

```
RDEFINE EJBROLE BBGZDFLT.com.ibm.cics.server.examples.wlp.hello.war.cicsAllAuthenticated UACC(NONE)
RDEFINE EJBROLE BBGZDFLT.com.ibm.cics.server.examples.wlp.tsq.app.cicsAllAuthenticated UACC(NONE)
RDEFINE EJBROLE BBGZDFLT.com.ibm.cics.server.examples.wlp.jdbc.app.cicsAllAuthenticated UACC(NONE)
SETROPTS RACLIST(EJBROLE) REFRESH
```

Give read access to the defined roles for each web user ID that requires authorization:

```
PERMIT BBGZDFLT.com.ibm.cics.server.examples.wlp.hello.war.cicsAllAuthenticated
CLASS(EJBROLE) ID(user) ACCESS(READ)
PERMIT BBGZDFLT.com.ibm.cics.server.examples.wlp.tsq.app.cicsAllAuthenticated
CLASS(EJBROLE) ID(user) ACCESS(READ)
PERMIT BBGZDFLT.com.ibm.cics.server.examples.wlp.jdbc.app.cicsAllAuthenticated
CLASS(EJBROLE) ID(user) ACCESS(READ)
SETROPTS RACLIST(EJBROLE) REFRESH
```

Results

You can authorize access to web applications using CICS Security, Java EE role security, or both by defining the roles and the users in the roles.

Configuring security for a Liberty JVM server by using an LDAP registry

Liberty uses a user registry to authenticate a user and retrieve information about users and groups to perform security-related operations, including authentication and authorization. Default CICS Liberty security uses the SAF registry. However, many transactions that run on CICS are initiated by users

who authenticate their identities on distributed application servers, so CICS also supports the use of a Lightweight Directory Access Protocol (LDAP) registry in Liberty. To use LDAP, it is necessary to manually configure the `server.xml`.

Before you begin

- Ensure that the CICS region is configured to use SAF security and is defined with `SEC=YES` as a system initialization parameter.
- Authorize application developers and system administrators to create, view, update, and remove `JVMSEVER` and `BUNDLE` resources to deploy web applications into a Liberty JVM server. The `JVMSEVER` resource controls the availability of the JVM server, and the `BUNDLE` resource is a unit of deployment for the Java applications and controls the availability of the applications.

About this task

This task explains how to configure LDAP security for a Liberty JVM server, and integrate Liberty security with CICS security. Distributed identity mapping can be used to associate a SAF user ID with a distributed identity. You can use the CICS distributed identity mapping feature to set up distributed identity mapping. A user can then log on to a CICS web application with their distributed identity, as authenticated by an LDAP server. Filters that are defined in the z/OS security product (RACMAP) determine the mapping of this identity to a SAF user ID. This SAF user ID can then be used to authorize access to web applications through JEE application role security, providing integration with CICS transaction and resource security. You can map a SAF user ID to one or more distributed identities.

The default transaction ID for running any web request is `CJSA`. You can configure CICS to run web requests under a different transaction ID by using a `URIMAP` of type `JVMSEVER`. You can specify a `URIMAP` to match the generic context root (URI) of a web application to scope the transaction ID to the set of servlets that make up the application. Or you can choose to run each individual servlet under a different transaction with a more precise URI.

There are three scenarios for this task:

- [Scenario 1 – Distributed identity mapping with SAF authorization](#)
- [Scenario 2 – Distributed identity mapping without SAF authorization](#)
- [Scenario 3 – LDAP for authentication and authorization](#)

Procedure

1. Distributed identity mapping with SAF authorization

You can use the CICS distributed identity mapping feature, `cicsts:distributedIdentity-1.0` to enable LDAP distributed identities to be mapped to SAF user IDs. When used with the CICS security feature `cicsts:security-1.0`, Liberty LDAP security is used for authentication and JEE application role security from EJB role mappings are respected for authorization. CICS transactions run under the mapped SAF user ID providing integration with CICS transaction and resource security.

- a. Configure the WebSphere Liberty angel process to provide authentication and authorization services to the Liberty JVM server, for more information see [The Liberty server angel process](#).
- b. Add the `cicsts:security-1.0` and the `cicsts:distributedIdentity-1.0` feature to the `featureManager` list in the `server.xml`.

```
<featureManager>
  ...
  <feature>cicsts:security-1.0</feature>
  <feature>cicsts:distributedIdentity-1.0</feature>
</featureManager>
...
```

- c. Configure Liberty to use LDAP authentication by defining the LDAP server in the `server.xml`, for example:

```
<ldapRegistry id="ldap"
             host="host.domain.com" port="389"
             ldapType="IBM Tivoli Directory Server"
             baseDN="ou=users,dc=domain,dc=com"
             ignoreCase="true">
</ldapRegistry>
```

Full details on configuring LDAP user registries with Liberty are available in [Configuring LDAP user registries in Liberty](#).

- d. Remove the `safRegistry` element, if present. Save the changes to the `server.xml`.
- e. Make the necessary RACF definitions, including setting up the RACMAPs to map distributed identities to SAF user IDs as which are described in [Configuring LDAP user registries in Liberty](#) and providing access for these user IDs to the appropriate EJBROLES as described in [“Authorization using SAF role mapping” on page 352](#). CICS configures SAF authorization and the `mapDistributedIdentities` attributes in the `safCredentials` configuration element for you.

When the `cicsts:distributedIdentity-1.0` feature is used with the `cicsts:security-1.0` feature, Liberty LDAP security is used for authentication, and JEE application role security from EJB role mappings are respected for authorization. CICS transactions run under the RACMAP mapped user ID providing integration with CICS transaction and resource security.

[What to do next](#)

[Back to top](#)

2. Distributed identity mapping without SAF authorization

It is possible to allow CICS transactions to run under a RACMAP mapped user ID while respecting the roles configured in the application's `<application-bnd>` element. This might be useful when migrating work from distributed Liberty to CICS Liberty. Be aware that CICS bundles cannot be used to install applications as SAF authorization is not being used. See [“Authorization using SAF role mapping” on page 352](#) for more details.

- a. Configure the WebSphere Liberty angel process to provide authentication and authorization services to the Liberty JVM server, for more information, see [The Liberty server angel process](#).
- b. Add the `cicsts:security-1.0` and the `ldapRegistry-3.0` feature to the `featureManager` list in the `server.xml`.

```
<featureManager>
...
  <feature>cicsts:security-1.0</feature>
  <feature>ldapRegistry-3.0</feature>
</featureManager>
...
```

- c. Configure Liberty to use LDAP authentication by defining the LDAP server in the `server.xml`, for example:

```
<ldapRegistry id="ldap"
             host="host.domain.com" port="389"
             ldapType="IBM Tivoli Directory Server"
             baseDN="ou=users,dc=domain,dc=com"
             ignoreCase="true">
</ldapRegistry>
```

Full details on configuring LDAP user registries with the Liberty are available in [Configuring LDAP user registries in Liberty](#).

- d. Configure Liberty to use distributed identity filters to map the distributed identities to SAF user IDs by setting the `mapDistributedIdentities` attribute in the `safCredentials` configuration element to `true` in the `server.xml`.
- e. Remove the `safRegistry` element, if present. Save the changes to the `server.xml`.

- f. Make the necessary RACF definitions, including setting up the RACMAPs to map distributed identities to SAF user IDs as which are described in [Configuring LDAP user registries in Liberty](#).
- g. If JEE application role security is required for authorization then refer to the topic [“Authorization using SAF role mapping” on page 352](#). Be aware that CICS bundles cannot be used to install applications when SAF is not used for JEE role authorization.

Applications use Liberty LDAP security for authentication, and JEE application role security in an `<application-bnd>` element are respected for authorization of the distributed identity. In CICS, transactions run under the RACMAP mapped user ID, providing integration with CICS transaction and resource security.

[What to do next](#)

[Back to top](#)

3. LDAP for authentication and authorization

LDAP security can be used in a CICS Liberty JVM server for both authentication and authorization using JEE application role security. URIMAP definitions can then be used to set the user ID under which transaction run. This scenario might be useful if migrating a distributed application into a CICS Liberty JVM server, without requiring any significant security resource changes.

- a. Add the `cicsts:security-1.0` and the `ldapRegistry-3.0` feature to the `featureManager` list in the `server.xml`.

```
<featureManager>
...
  <feature>cicsts:security-1.0</feature>
  <feature>ldapRegistry-3.0</feature>
</featureManager>
...
```

- b. Configure Liberty to use LDAP authentication by defining the LDAP server in the `server.xml`, for example:

```
<ldapRegistry id="ldap"
  host="host.domain.com" port="389"
  ldapType="IBM Tivoli Directory Server"
  baseDN="ou=users,dc=domain,dc=com"
  ignoreCase="true">
</ldapRegistry>
```

Full details on configuring LDAP user registries with Liberty are available in [Configuring LDAP user registries in Liberty](#).

- c. Remove the `safRegistry` element, if present. Save the changes to the `server.xml`.
- d. To configure JEE application role security for authorization refer to the topic [“Authorization using SAF role mapping” on page 352](#). Be aware that CICS bundles cannot be used to install applications when SAF is not used for JEE role authorization.

Applications use Liberty LDAP security for authentication, and JEE application role security in an `<application-bnd>` element are respected for authorization. In CICS transactions run under the URIMAP or CICS DFLTUSER user ID as appropriate.

[What to do next](#)

[Back to top](#)

What to do next

This applies to all three scenarios:

- Modify the Liberty authentication cache.
- Set up URIMAP definitions to map web application URIs to transaction IDs.

This applies to scenarios 1 and 2:

- Set up CICS transaction security definitions to authorize access to URIs based on the mapped user ID.

[Back to top](#)

Configuring SSL (TLS) for a Liberty JVM server using a Java keystore

You can configure a Liberty JVM server to use SSL for data encryption, and optionally authenticate with the server by using a client certificate. Certificates can be stored in a Java keystore or in a SAF key ring such as RACF.

About this task

Enabling SSL in a Liberty JVM server requires adding the **ssl-1.0** Liberty feature, a keystore, and an HTTPS port. CICS automatically creates and updates the `server.xml` file. Autoconfiguring always results in the creation of a Java keystore.

It is important to understand that any web request to a Liberty JVM server uses the JVM support for TCP/IP sockets and SSL processing, not CICS sockets domain.

Procedure

- To use autoconfigure to configure SSL, complete the following steps:
 - a) Ensure autoconfigure is enabled in the JVM profile by using the JVM system property **-Dcom.ibm.cics.jvmserver.wlp.autoconfigure=true**.
 - b) Set the SSL port by setting the JVM system property **-Dcom.ibm.cics.jvmserver.wlp.server.https.port** in the JVM profile.
 - c) Restart the JVM server to add the necessary configuration elements to `server.xml`.

Results

SSL for a Liberty JVM server is successfully configured.

Configuring SSL (TLS) for a Liberty JVM server using RACF

You can configure a Liberty JVM server to use SSL for data encryption, and optionally authenticate with the server by using a client certificate. Certificates can be stored in a Java keystore or in a SAF key ring such as RACF.

About this task

Enabling SSL in a Liberty JVM server requires adding the **ssl-1.0** Liberty feature, a keystore, and an HTTPS port. Configuring `server.xml` manually. You edit the `server.xml` file to add the required elements and values. You must follow the manual procedure if you want to use a RACF key ring.

It is important to understand that any web request to a Liberty JVM server uses the JVM support for TCP/IP sockets and SSL processing, not CICS sockets domain.

Procedure

- To manually configure SSL, you need to create a signing certificate. Use this signing certificate to create a server certificate. Then, export the signing certificate to the client web browser where it is used to authenticate the server certificate.
 - a) Create a certificate authority (CA) certificate (signing certificate). An example, using RACF commands, follows:

```
RACDCERT GENCERT
CERTAUTH
SUBJECTSDN(CN('CICS Sample Certification Authority'))
```

```
O('IBM')
OU('CICS'))
SIZE(2048)
WITHLABEL('CICS-Sample-Certification')
```

The SIZE of the certificate should be a minimum of 2048 bits. For more information, see the [RACF RACDCERT GENCERT \(Generate certificate\) command](#).

- b) Create a server certificate that uses the signing certificate from step 2, where <userid> is the CICS region user ID. The hostname is the host name of the server that the Liberty server HTTPS port is configured to use.

```
RACDCERT ID(<userid>)
GENCERT
SUBJECTSDN(CN('<hostname>')
O('IBM')
OU('CICS'))
SIZE(2048)
SIGNWITH (CERTAUTH LABEL('CICS-Sample-Certification'))
WITHLABEL('<userid>-Liberty-Server')
```

The SIZE of the certificate should be a minimum of 2048 bits. For more information, see the [RACF RACDCERT GENCERT \(Generate certificate\) command](#).

- c) Connect the signing certificate and server certificate to a RACF key ring.
You can use RACF with the following command, and replace the value of <keyring> with the name of the key ring you want to use. Replace the value of <userid> with the CICS region user ID.

```
RACDCERT ID(<userid>) CONNECT(RING(<keyring>)
LABEL('CICS-Sample-Certification')
CERTAUTH)

RACDCERT ID(<userid>) CONNECT(RING(<keyring>)
LABEL('<userid>-Liberty-Server'))
```

Export the signing certificate to a CER file:

```
RACDCERT CERTAUTH EXPORT(LABEL('CICS-Sample-Certification'))
DSN('<userid>.CERT.LIBCERT')
FORMAT(CERTDER)
PASSWORD('password')
```

FTP the exported certificate in binary to your workstation, and import it into your browser as a certificate authority certificate.

- d) Edit the server.xml file and add the SSL feature, and the keystore. Set the HTTPS port (value is 9443 in the following example) and restart your CICS region. The SAF key ring must be specified in the URL form safkeyring://<userid>/<keyring>. The <userid> value must be set to the CICS region user ID and the <keyring> value must be set to the name of the key ring. The password field is not used for accessing the SAF key ring and must be set to password.

```
<featureManager>
...
  <feature>ssl-1.0</feature>
</featureManager>
...
<httpEndpoint host="*" httpPort="9080" httpsPort="9443"
  id="defaultHttpEndpoint"/>
...
<keyStore filebased="false" id="racfKeyStore"
  location="safkeyring://<userid>/<keyring>"
  password="password"
  readOnly="true"
  type="JCERACFKS"/>
<ssl id="defaultSSLConfig" keyStoreRef="racfKeyStore"
  sslProtocol="SSL_TLS"
  serverKeyAlias="<userid>-Liberty-Server" />
```

Results

SSL for a Liberty JVM server is successfully configured.

Setting up SSL (TLS) client certificate authentication in a Liberty JVM server

SSL client certificate authentication allows the client and server to provide certificates to the opposite party for mutual verification. It is often used in situations where an extra level of authentication is required because of security concerns.

Before you begin

You must complete the task [Configuring SSL \(TLS\) for a Liberty JVM server using RACF](#). If you do not already have your CICS Liberty security set up, you must complete [Configuring security for a Liberty JVM server](#) before proceeding.

About this task

The following setup information assumes that you are using RACF keystores to store your certificates for SSL client certificate authentication.

Procedure

1. Create a personal certificate using a signing certificate and associate the personal certificate with a RACF user ID.

Then, export the personal certificate to a data set in CER format and then FTP in binary to your work station. Import the personal certificate to the web browser as a personal certificate. When the certificate is imported into the web browser, it can supply an SSL client certificate and connect to the HTTPS port in the Liberty server. Use the following RACF command, where `<clientuserid>` is the RACF user ID and `<hostname>` is the host name of the client computer.

```
RACDCERT ID(<clientuserid>)
GENCERT
SUBJECTSDN(CN('<hostname>')
O('IBM')
OU('CICS'))
SIZE(2048)
SIGNWITH (CERTAUTH LABEL('CICS-Sample-Certification'))
WITHLABEL('<clientuserid>-certificate')
```

Export the personal certificate as you have done earlier in this step.

```
RACDCERT ID(<clientuserid>)
EXPORT(LABEL('<clientuserid>-certificate'))
DSN('USERID.CERT.CLICERT')
FORMAT(PKCS12DER)
PASSWORD('password')
```

Update the `server.xml` SSL element to support SSL client certificate authentication:

```
<ssl id="defaultSSLConfig" keyStoreRef="racfKeyStore"
sslProtocol="SSL_TLS"
serverKeyAlias="<userid>-Liberty-Server"
clientAuthenticationSupported="true"/>
```

Additionally, if you want to ensure all clients must supply a valid SSL client certificate, add the **clientAuthentication** attribute to the SSL element as follows:

```
<ssl id="defaultSSLConfig" keyStoreRef="racfKeyStore"
sslProtocol="SSL_TLS"
serverKeyAlias="<userid>-Liberty-Server"
clientAuthenticationSupported="true"
clientAuthentication="true"/>
```

2. You can authenticate a web request in CICS under the identity of the client user ID in step 2. Then, deploy the web application with a `login-config` element for CLIENT-CERT in the `web.xml`. The `web.xml` file can be found inside the source files for the web application that you are deploying.

```
<login-config>
  <auth-method>CLIENT-CERT</auth-method>
</login-config>
```

Instead, if you want to allow failover to HTTP basic authentication if SSL client certificate authentication is not configured, add the `webAppSecurity` element to `server.xml`.

```
<webAppSecurity allowFailOverToBasicAuth="true" />
```

3. Finally, set up CICS transaction security to authorize access to the CICS transaction based on the authenticated client user ID.
For further information, see [“Authorizing users to run applications in a Liberty JVM server” on page 348](#).

Using the syncToOSThread function

You can use the `syncToOSThread` function of Liberty in a CICS Liberty JVM server. `syncToOSThread` enables a Java subject, authenticated by Liberty, to be synchronized with the operating system (OS) thread identity. Without `syncToOSThread`, the operating system thread identity defaults to be the CICS region user ID, this is the identity used to authorize access to resources outside of CICS control such as zFS files. With `syncToOSThread` in effect, the user's subject is used to access these operating system resources.

About this task

Enabling `syncToOSThread` requires the Liberty `appSecurity-1.0` and `zosSecurity-1.0` features. These features are included with the `cicsts:security-1.0` feature. You must also define the `syncToOSThread` configuration element in the Liberty `server.xml` and add a special `<env-entry/>` to the application's deployment descriptor (`web.xml`). In addition, the SAF registry must be used for authentication, the angel process must be up and running, and the server must be connected to the angel process. For more information about the angel process, see [Liberty: Process types on z/OS](#).

Procedure

1. Configure the `syncToOSThread` configuration element in the Liberty `server.xml` and add the required `<env-entry/>` to each web application's deployment descriptor by following steps 1 and 2 in [Enabling syncToOSThread for applications](#)
2. Grant the Liberty server permission to perform `syncToOSThread` operations by configuring SAF with either of the following profiles:

- Grant the CICS region user ID CONTROL access to the `BBG.SYNC.<profilePrefix>` profile in the FACILITY class, where `<profilePrefix>` is specified on the `<safCredentials />` element. This allows the Liberty server to synchronize any Java subject with the OS thread identity:

```
PERMIT BBG.SYNC.<profilePrefix> ID(<serverUserId>) ACCESS(CONTROL) CLASS(FACILITY)
```

- Grant the CICS region user ID READ access to the `BBG.SYNC.<profilePrefix>` profile in the FACILITY class. Additionally, grant the CICS region user ID READ access to one or more `BBG.SYNC.<AuthUserId/>` profiles in the SURROGATE class, one for each authenticated user ID to be synchronized with the OS identity:

```
PERMIT BBG.SYNC.<profilePrefix> ID(<serverUserId>) ACCESS(READ) CLASS(FACILITY)
PERMIT BBG.SYNC.<AuthUserId> ID(<serverUserId>) ACCESS(READ) CLASS(SURROGAT)
```

Restriction: A servlet configured as the welcome page in `web.xml`, does not support the `syncToOSThread` function.

Enabling a Java security manager

By default, Java applications have no security restrictions placed on activities requested of the Java API. To use Java security to protect a Java application from performing potentially unsafe actions, you can enable a security manager for the JVM in which the application runs.

About this task

The security manager enforces a security policy, which is a set of permissions (system access privileges) that are assigned to code sources. A default policy file is supplied with the Java platform. However, to enable Java applications to run successfully in CICS when Java security is active, you must specify an additional policy file that gives CICS the permissions it requires to run the application.

You must specify this additional policy file for each kind of JVM that has a security manager enabled. CICS provides some examples that you can use to create your own policies.

Notes: Enabling a Java security manager is not supported in a Liberty JVM server.

- The OSGi security agent example creates an OSGi middleware bundle called `com.ibm.cics.server.examples.security` in your project that contains a security profile. This profile applies to all OSGi bundles in the framework in which it is installed.
- The `example.permissions` file contains permissions that are specific to running applications in a JVM server, including a check to ensure that applications do not use the `System.exit()` method.
- CICS must have read and execute access to the directory in zFS where you deploy the OSGi bundle.

For applications that run in the OSGi framework of a JVM server:

Procedure

1. Create a plug-in project in the IBM CICS SDK for Java and select the supplied OSGi security agent example.
2. In the project, select the `example.permissions` file to edit the permissions for your security policy.
 - a) Validate that the CICS zFS and Db2 installation directories are correctly specified.
 - b) Add other permissions as necessary.
3. Deploy the OSGi bundle to a suitable directory in zFS such as `/u/bundles`.
4. Edit the JVM profile for the JVM server to add the OSGi bundle to the `OSGI_BUNDLES` option before any other bundles:

```
OSGI_BUNDLES=/u/bundles/com.ibm.cics.server.examples.security_1.0.0.jar
```
5. Add the following Java property to the JVM profile to enable security.

```
-Djava.security.policy=all.policy
```
6. Add the following Java environment variable to the JVM profile to enable security in the OSGi framework:

```
org.osgi.framework.security=osgi
```
7. To allow the OSGi framework to start with Java 2 security, add the following policy:

```
grant { permission java.security.AllPermission; };
```
8. Save your changes and enable the `JVMSERVER` resource to install the middleware bundle in the JVM server.
9. Optional: Activate Java 2 security.
 - a) To activate a Java 2 security policy mechanism, add it to the appropriate JVM profile. You must also edit your Java 2 security policy to grant appropriate permissions.
 - b) To use JDBC or SQLJ from a Java application with a Java 2 security policy mechanism active, use the IBM Data Server Driver for JDBC and SQLJ.
 - c) To activate a Java 2 security policy mechanism, edit the JVM profile.

- d) Edit the Java 2 security policy to grant permissions to the JDBC driver, by adding the lines that are shown in Example 1. In place of `db2xxx`, specify a directory below which all your Db2 libraries are located. The permissions are applied to all the directories and files below this level. This enables you to use JDBC and SQLJ.
- e) Edit the Java 2 security policy to grant read permissions, by adding the lines that are shown in Example 2. If you do not add read permission, running a Java program produces `AccessControlExceptions` and unpredictable results. You can use JDBC and SQLJ with a Java 2 security policy.

Example 1:

```
grant codeBase "file:/usr/lpp/db2xxx/-" {  
    permission java.security.AllPermission;  
};
```

Example 2:

```
grant {  
    // allows anyone to read properties  
    permission java.util.PropertyPermission "*", "read";  
};
```

Results

When the Java application is called, the JVM determines the code source for the class and consults the security policy before granting the class the appropriate permissions.

Chapter 11. Security for CICS web support

When CICS is connected to the Internet, apply security measures to prevent unauthorized access to CICS applications and data and also to prevent third parties obtaining private information.

Consider security throughout the development process for your CICS web support architecture, as part of the design of your CICS web support applications and utility programs, and when creating resource definitions for the relevant CICS facilities. The subtopics summarize the measures that you can use to enhance the security of your CICS web support implementation.

CICS as an HTTP server: authentication and identification

For CICS as an HTTP server, you specify authentication schemes by the AUTHENTICATE attribute of the TCPIP SERVICE definition. Identification is obtained in connection with the authentication process, or it can be supplied by CICS if authentication is not needed.

Obtaining authentication and identification from web clients is a key step in protecting your CICS system from access by unauthorized users.

Use TCPIP SERVICE resource definitions to specify the security measures that are applied for CICS as an HTTP server. For each port that you use for CICS web support, the TCPIP SERVICE resource definition specifies these attributes:

- Whether or not SSL is used for the port
- The authentication scheme that is used for the port
- The realm for basic authentication

Authentication

Two authentication schemes are supported by CICS for use with the HTTP protocol:

- **Basic authentication** is part of HTTP that enables a client to authenticate and identify itself to a server by providing a user ID and password or password phrase. This information is encoded using base-64 encoding, which is simple to decode. Therefore, using basic authentication as the sole means of authentication is appropriate only when the password cannot be intercepted. In most environments, use basic authentication with SSL, so that SSL encryption protects the user ID and password information.
- **SSL client certificate authentication** is a more secure method of authenticating a client, using a client certificate that is issued by a trusted third party (or Certificate Authority), and sent using SSL encryption. Refer to [SSL authentication](#). A client certificate does not contain a user ID that can be used for identification in CICS. To achieve identification, you can associate the client certificate with a user ID in RACF or an equivalent security manager, either before the certificate is used, or automatically (using basic authentication) when the client makes its request. The RACF user ID becomes the client user ID each time the certificate is used, as described in [Associating a RACF user ID with a certificate](#).

[Creating TCPIP SERVICE resource definitions for CICS web support](#) tells you how to set up a TCPIP SERVICE definition for CICS web support that specifies one of these authentication schemes.

When you use basic authentication or client certificate authentication, CICS handles the process of requesting authentication from the user, decoding the authentication information if necessary, checking the supplied authentication against the security manager database, and rejecting the request if the authentication is not acceptable. An analyzer program or user-written application program is called only after the authentication is verified and accepted.

All the user IDs used by web clients must have a user profile in RACF or your equivalent external security manager. Refer to [RACF profiles](#).

Note: CICS uses password verification to verify a user ID during the processes described here. CICS enforces a full verification request once a day for each user ID that is used to log on to the CICS region. The full verification request using the RACROUTE REQUEST=VERIFY macro makes RACF record the date and time of last access for the user ID, and write user statistics.

For basic authentication, if the password or password phrase supplied by the user has expired, CICS prompts the user for a new password or password phrase and helps the user to resubmit the request. The CICS-supplied utility program DFHWBPW is used. You can customize the text on the web pages that CICS displays to the user during this process, as described in [“Password expiry management for HTTP basic authentication”](#) on page 365.

For client certificate authentication, CICS verifies the supplied certificate by checking it against the security manager database, and, optionally, against any certificate revocation list that you have set up. A user-written application can examine information obtained by this process, if this information is useful for determining how to process the request. Use the EXTRACT CERTIFICATE command to retrieve these items:

- Components of the issuer's or the subject's distinguished name. [SSL authentication](#) explains distinguished names.
- The RACF user ID associated with the certificate.

Identification

Identification takes place when you obtain a user ID for the web client. The ID is obtained from the web client:

- During basic authentication
- By the association of a user ID with a client certificate

For application-generated responses only, CICS can supply a user ID on behalf of the web client:

- In an analyzer program that is used in the processing path for the application-generated response. (This ID can override a user ID obtained for the web client.)
- In the URIMAP definition for the request. (This ID cannot override a user ID obtained for the web client.)
- As the CICS default user ID, if no other can be determined.

Note that, if you supply a user ID on behalf of the web client, the identity of the client is not authenticated. Supply a user ID only when communicating with your own client system, which has already authenticated its users and communicates with the server in a secure environment. [Identifying HTTP users](#) explains in more detail how the user ID is determined, depending on the settings for the TCPIP SERVICE definition.

When the client has been identified, the client user ID can be authorized for access to CICS resources like any other user ID, using RACF or an equivalent external security manager. You can choose to apply resource-level security to any or all of the individual resources that the web client is accessing in CICS, such as web pages stored as CICS document templates, or z/OS UNIX files, or CICS commands used by the application that provides the response. [“CICS system and resource security for CICS web support”](#) on page 367 explains how to secure these resources and how to remove resource level security if you do not want it.

CICS as an HTTP client: authentication and identification

When you make an HTTP client request through CICS, a server or proxy might require you to perform basic authentication, proxy authentication, or SSL client certificate authentication.

You can perform basic authentication using the AUTHENTICATE option of your WEB SEND or WEB CONVERSE command. Your user application carries out proxy authentication. You supply a client certificate using a URIMAP definition.

Your client application might be asked to authenticate itself in the following ways:

- **Basic authentication** allows you to provide a user name and password for access to specific information. When you make a request to a server, the server might send you a response with a

401 status code, and a WWW-Authenticate header. The header names the realm for which basic authentication is required. To receive the information you requested, provide the user name and password, and CICS resends the request with an Authorization header, specifying your user name and password, to allow you access to the realm. CICS can also send an Authorization header directly to a server that is expecting it, thus eliminating the need for a 401 response. CICS converts the user name and password to ASCII and applies base-64 encoding, as required by the basic authentication protocol. So you can supply your credentials in normal characters through the WEB SEND or WEB CONVERSE command, or through the XWBAUTH user exit. See [Providing credentials for basic authentication and HTTP basic authentication](#).

- **Proxy authentication** is initiated by a proxy server. For proxy authentication, the status code for the response is 407, the challenge header from the proxy server is Proxy-Authenticate, and the response header is Proxy-Authorization. CICS does not support this protocol.
- **SSL client certificate authentication** uses a client certificate, which is issued by a trusted third party (or Certificate Authority). A server might require you to provide this authentication when you are making an HTTPS request. [Configuring CICS to use SSL](#) tells you how to obtain a certificate and store it in a key ring in the RACF database or equivalent external security manager. If a server does request a client certificate, CICS supplies the certificate label, which is specified in the URIMAP definition that was used on the WEB OPEN command for the connection. Alternatively, you can directly specify the certificate label as an option in the WEB OPEN command. If you use a URIMAP definition but do not specify a certificate label, the default certificate defined in the key ring for the CICS region user ID is used.

Some servers might ask you to provide other types of authentication or identification. If you cannot provide acceptable authentication or identification to a server, your request is rejected. For basic authentication or proxy authentication, the status code used when a server rejects your request is the same as the status code for the challenge (401 for a server or 407 for a proxy). If you respond to a challenge but then receive a further response with one of these status codes, the authorization information that you used is not valid.

Password expiry management for HTTP basic authentication

When basic authentication is used for an HTTP connection, CICS web support checks the user ID and password in the external security manager. If the password has expired, the CICS-supplied utility program DFHWBPW is used to prompt the user to select a new password. You can customize or replace the pages presented to the user by DFHWBPW.

DFHWBPW is used only for password expiry management when the TCPIP SERVICE definition that applies to the request is defined with the BASIC, AUTOREGISTER, or AUTOMATIC option for the AUTHENTICATE attribute. Although DFHWBPW has a structure similar to a converter program, it is not part of the normal CICS web support processing path, so you do not need to add code to it for any other purpose. When the user has selected a new password, DFHWBPW restarts the request submission by redirecting the client to the URL for the original request, so that the complete processing path for the request occurs as normal.

DFHWBPW presents two web pages to the user:

1. Password prompt page. This page contains two elements:
 - a. A message about password validity. The initial message displayed to the user states that the password has expired. A user ID can have both a standard password and a password phrase. Passwords between 9 and 100 characters in length are password phrases; passwords of 8 characters or less are standard passwords. Standard passwords and password phrases operate independently of each other. If a standard password has expired, it must be replaced with a new standard password. Similarly, if a password phrase has expired, it must be replaced with a new password phrase. If the user's attempt to change the password fails (for example, the two supplied copies of the new password do not match), further messages are displayed to explain the problem.
 - b. An HTML form for the user to change the password.
2. Confirmation and request refresh page. This page confirms that the expired password has been successfully replaced, and provides a refresh tag and URL link so that the request can be remade automatically or manually.

DFHWBPW builds these web pages using three CICS document templates: DFHWBPW1, DFHWBPW2, and DFHWBPW3. The CICS-supplied definitions for these templates define them as loadable programs; that is, they are of type PROGRAM(DFHWBPW1) and so on. The definitions are in the CICS-supplied resource definition group DFHWEB. You can change these definitions by copying them to another group and using the resource definition ALTER command to change them so that the templates are derived from a different source. Alternatively, you can leave the resource definitions unchanged, and modify the programs that are loaded instead. The three programs DFHWBPW1, DFHWBPW2, and DFHWBPW3 are assembler language data-only modules, and their source is shipped to you in corresponding members of the CICS sample library, SDFHSAMP. You can modify these samples and reassemble and link-edit them into one of your normal CICS program libraries that are concatenated into the DFHRPL data definition statement.

Note: To avoid unnecessary output, ensure that you specify the **NOPROLOG** and **NOEPILOG** parameters when assembling DFHWBPW1, DFHWBPW2 and DFHWBPW3.

The content and function of each of the DFHWBPW templates is as follows:

DFHWBPW1

Part of the password prompt page. Provides the HTML page heading for the page, and sets symbols for the possible password validity messages (using the server-side include technique for setting symbols). The messages provide the following information:

message.1

Password has expired.

message.2

The entered user ID is invalid.

message.3

The two copies of the proposed new password do not match.

message.4

The previous password entered (the one that has just expired) is not correct.

message.5

The proposed new password is not permitted by the external security manager, because of password quality rules.

message.6

The user ID is now revoked.

The DFHWBPW program selects the appropriate symbol to insert into the document for the password prompt page. You can customize DFHWBPW1 to change the page heading and title, or alter the body tag to change the page colors or background. You can also change the content of the message symbols.

DFHWBPW2

Part of the password prompt page. Builds an HTML form where the user can input a user ID, the old (expired) password (or password phrase), and two identical copies of a proposed new password. You can customize DFHWBPW2 to change the text used to prompt the user, or otherwise change the layout of the page. However, you must not modify the contents of the `form` tag, or any of the `input` tags. If you do, DFHWBPW might not work as intended.

DFHWBPW3

Confirmation and request refresh page. The text notifies the user that the expired password was successfully replaced, and explains that the user will shortly be prompted by the client to enter the password again. You can customize the text and layout of the page.

DFHWBPW3 restarts the request process. It contains a meta `http-equiv="Refresh"` tag that causes an automatic redirection after ten seconds to the page that the user had originally requested when the expired password was detected. You can change the time limit on this tag or remove it if you do not want users to be redirected automatically. However, the modified page must always contain a link forward to the originally requested page. The URL for that page is in the symbol `&dfhwbpw_target_url;`. Restarting the request process means that, if the web client has cached

the old password, it can be replaced with the new password immediately, and also means that the CICS web support processing path is unaffected.

CICS system and resource security for CICS web support

When CICS is an HTTP server, the CICS system must be protected from access by unauthorized users. If a system is not properly protected, users might be able to access confidential data or obstruct the system to cause denial of service to other users.

To police access to CICS web support in general, you request identification from each user that makes an HTTP client request and then authenticate the identity stated by the user. You use the TCPIP SERVICE definitions for inbound ports to specify these requirements. Refer to [“CICS as an HTTP server: authentication and identification”](#) on page 363.

All the user IDs used by web clients must have a user profile in RACF or your equivalent external security manager. Refer to [RACF profiles](#).

When you have obtained an authenticated user ID for a web client, you can use this ID to implement resource-level security for the resources in the CICS region that you are using to provide the response. The procedure varies for each type of response:

- Application-generated responses
- Static responses, using a URIMAP definition that provides a CICS document template as the response
- Static responses, using a URIMAP definition that provides a z/OS UNIX Systems Services file as the response

For application-generated responses, CICS system defaults specify that no resource security checking is carried out, but transaction security checking is carried out (specifically, transaction-attach security for the alias transaction). Assuming that transaction security is active in your CICS region, you must therefore take some actions relating specifically to security for application-generated responses, even if you do not plan to use web client authenticated user IDs for security checking.

For static responses, transaction-attach security does not apply to web client user IDs. However, CICS system defaults specify that resource-level security checking is carried out if a user ID is available for web clients. If you are obtaining authenticated user IDs from web clients, you must therefore either set up resource permissions for these user IDs or take action to disable resource-level security checking.

Whether or not you choose to implement resource-level security using web client user IDs for every response provided by CICS web support, you must provide the following protection:

- Implement measures to protect inbound ports against unauthorized or malicious access.
- Protect CICS system components from modification by unauthorized users, and ensure that authorized users have the correct access to them.

Security for inbound ports

A TCPIP SERVICE resource definition defines each port used for CICS web support. The TCPIP SERVICE definition specifies security options for the port, including whether SSL is used and the level of authentication that is requested from clients. Ports must be guarded against unauthorized or malicious access.

[Creating TCPIP SERVICE resource definitions for CICS web support](#) explains how to create definitions for ports.

To help keep ports secure:

- Specify the MAXDATALEN attribute on every TCPIP SERVICE definition. This option limits the maximum amount of data that CICS accepts for a single request, and it helps to defend CICS against denial of service attacks involving the transmission of large amounts of data.
- Use Secure Sockets Layer (SSL) wherever you want to ensure that your interaction with the web client remains confidential and cannot be intercepted by a third party. The use of SSL is particularly important

when confidential data is being transmitted or when authorization such as a user ID and password are being passed to the server. Refer to [“SSL with CICS web support” on page 372](#).

If you do experience unusual activity on one or more of your CICS web support ports, use CICS system commands to shut down CICS web support at different levels (a single request, a virtual host, a port, or the whole of CICS web support), without shutting down the CICS system. Refer to [Rejecting HTTP requests in Administering](#).

URIMAP resource definitions name either HTTP or HTTPS as the scheme for the request. A URIMAP specifying HTTP accepts web client requests made using either HTTP or the more secure HTTPS. A URIMAP specifying HTTPS accepts only web client requests that are made using HTTPS.

When a URIMAP definition with HTTPS matches a request from a web client, CICS checks that the inbound port used by the request is using SSL. If SSL is not specified for the port, the request is rejected with a 403 (Forbidden) status code. When the URIMAP definition applies to all inbound ports, this check ensures that a web client cannot use an unsecured port to access a secured resource. No check is carried out for a URIMAP definition that specifies HTTP, so web clients can use either unsecured or secured (SSL) ports to access these resources.

Security for CICS system components

As with any other CICS resource, you must protect CICS system components used in CICS web support from modification by unauthorized users. You must also ensure that authorized users, particularly the CICS region, have the required authority to use these components.

A number of components, such as application programs and resource definitions, are used to control CICS web support. Refer to [Components of CICS web support](#). If you do not secure these components against unauthorized access, the security of your CICS web support architecture might be compromised. For example, a user with access to the TCPIPSERVICE definition for a port might remove the requirement for a web client to use SSL or to provide identification. [Implementing RACF protection in a single CICS region](#) explains how to secure CICS transactions, resources, and commands against unauthorized use.

For some CICS system components, you might have to set up additional authorities to allow access to authorized users:

- For [URIMAP](#) resources, additional authority might be required to set a user ID for the web client. If surrogate user checking is enabled in the CICS region (with XUSER=YES specified as a system initialization parameter), CICS checks that the user ID used to install the URIMAP definition is authorized as a surrogate of the user ID specified for the USERID attribute.
- You can use document templates to produce the body of a response from CICS as an HTTP server, or the body of a request from CICS as an HTTP client. You define them by [DOCTEMPLATE](#) resource definitions. If the document templates are stored in partitioned data sets, the CICS region user ID must have READ authority for the data set.
- You can use z/OS UNIX Systems Services files to produce the body of a static response from CICS as an HTTP server. You can specify them under their own names or define them by [DOCTEMPLATE](#) resource definitions. When a z/OS UNIX file is used, the CICS region must have permissions to access z/OS UNIX, and it must have permission to access the z/OS UNIX directory containing the file, and the file itself. Refer to [Giving CICS regions access to z/OS UNIX directories and files](#).

Resource and transaction security for application-generated responses

If you have obtained an authenticated user ID for a web client, which has a profile in your security manager, this user ID is applied to the alias transaction that is used for the application-generated response.

About this task

You either give appropriate permissions to the web client user IDs or you supply your own standard user ID as an override. Whether or not you decide to use web client user IDs for resource security checking, you must ensure that the user ID for the alias transaction has the appropriate permissions.

You define alias transactions by TRANSACTION resource definitions. The alias transaction for each application-generated response is specified by the URIMAP definition for the request or by an analyzer program. The default is the CICS-supplied alias transaction CWBA, which applies when either web-aware applications or COMMAREA applications are used to provide the response.

The user ID under which the alias transaction runs must have authority to perform these tasks:

- Attach the alias transaction, if transaction-attach security is specified for the CICS region. Transaction-attach security is controlled by the system initialization parameter XTRAN. The default is YES (transaction-attach security is active).
- Access any CICS resources used by the alias transaction, if resource security is specified for the alias transaction. Resource security is controlled by the RESSEC attribute in the TRANSACTION resource definition for the alias transaction. The default is NO (no resource security), and NO is also the supplied setting for CWBA.
- Access any CICS system programming commands used by the alias transaction, if command security is specified for the alias transaction. These system programming commands are used in the user-written application program that produces the response. Command security is controlled by the CMDSEC attribute in the TRANSACTION resource definition for the alias transaction. The default is NO (no command security), and NO is also the supplied setting for CWBA.

When a web client makes a request to CICS web support, and the response is provided by an application, CICS selects a user ID for the alias transaction in the following order of priority:

1. A user ID that you set using an analyzer program. This user ID can override a user ID obtained from the Web client or supplied by a URIMAP definition.
2. A user ID that you obtained from the Web client using basic authentication, or a user ID associated with a client certificate sent by the Web client. If authentication is required for the connection but the client does not provide an authenticated user ID, the request is rejected.
3. A user ID that you specified in the URIMAP definition for the request.
4. The CICS default user ID, if no other can be determined.

Depending on your CICS web support architecture, you might be using one or several of these types of user ID, for different requests. If you obtain an authenticated user ID for a web client, it is used for the alias transaction unless you take action to override it.

Take the following security actions for application-generated responses:

Procedure

1. If you are obtaining authenticated user IDs for web clients, but you do *not* want to use these for security checking for your application-generated responses, you use an analyzer program to override web client user IDs with a standard user ID for the relevant alias transactions. (You can use the CICS default user ID.) Place the analyzer program in the processing paths for the requests where you want to supply this override.

See [Analyzer programs in Developing system programs](#). Make sure that this user ID has a user profile defined in your security manager.

When you have set up a standard user ID, you can give the required permissions, as described in the remaining steps of this procedure, to the standard user ID.

2. If you are not obtaining authenticated user IDs for web clients, select suitable user IDs to be standard user IDs for your alias transactions. Unless you just want to use the CICS default user ID, specify your chosen user IDs in the URIMAP definitions for the requests, or set up an analyzer program to specify them.

Make sure that the standard user IDs have user profiles defined in your security manager.

3. Assuming that transaction-attach security is specified for the CICS region, ensure that all the possible user IDs for your alias transactions have authority to attach the transaction.

All user IDs might include web client user IDs, if you are obtaining them and are not overriding them, or a standard user ID that you have specified in a URIMAP definition or analyzer program, or just the CICS default user ID. See [Transaction security](#).

4. Optional: Apply resource-level security checking for the resources used by an alias transaction:

a) Identify all the CICS resources used by the alias transaction, and determine which of them are subject to resource security checking in your CICS region.

Here are some resources that might be used by an application program for CICS web support and the system initialization parameters that control resource security checking for them:

- CICS document templates (XDOC system initialization parameter)
- Other application programs invoked by the main application program to perform business logic (XPPT system initialization parameter)
- Temporary storage queues used to share application state across an HTTP request sequence (XTST system initialization parameter)
- Files managed by CICS file control (XFCT system initialization parameter)

Resource security checking for zFS files (XHFS system initialization parameter) does not apply when zFS files are used by an application program, because the files can be manipulated by an application program only when they are defined as CICS document templates, and CICS document template security controls access to them in this situation.

If you are using an analyzer program, it is the main program for the alias transaction, and so is not subject to resource security checking (only to the transaction-attach security checking). However, note that the user-written web application program itself, and any converter program that you use, is subject to separate resource security checking. Similarly, if you are using a converter program but no analyzer program, the converter program is the main program for the alias transaction, but the application programs called by the converter program are subject to separate resource security checking.

b) Give all the user IDs that are permitted to attach the alias transaction permission to use the secured resources used by the alias transaction.

c) Specify RESSEC(YES) in the TRANSACTION resource definition for the transaction.

5. Optional: To apply command security checking for any CICS system programming commands used by an alias transaction:

a) Confirm that command security is active in the CICS region. Command security is activated by the XCMD system initialization parameter.

b) Identify the CICS system programming commands used by the application program or programs, analyzer program (if used), and converter program (if used), that are associated with the transaction.

[CICS resources subject to command security checking](#) has a checklist of commands.

c) Give all the user IDs that are permitted to attach the alias transaction permission to use the commands used by the alias transaction.

d) Specify CMDSEC(YES) in the TRANSACTION resource definition for the alias transaction.

What to do next

For any security checking to take place in a CICS region, set the SEC=YES system initialization parameter.

Resource-level security for static responses using document templates

If you have implemented basic authentication or client certificate authentication, and you also want to control users' access to specific web pages, you can use web client authenticated user IDs to control access to individual CICS document templates that you are using to provide static responses.

About this task

For static responses delivered by CICS web support using a CICS document template specified in a URIMAP definition, resource security checking is enabled by default.

The **XRES** system initialization parameter controls resource security for CICS document templates. The default for this parameter is YES, meaning that resource security is active. If you do not want to use resource security checking for CICS document templates used for any purpose in your CICS region, you can deactivate it by setting this system initialization parameter to NO.

The transaction for all static responses is the default web listener transaction CWXN, or any alternative transaction that you have specified in place of CWXN using the TRANSACTION attribute on your TCPIPSERVICE definitions. For CICS document templates, you can also control resource security checking by the RESSEC attribute in the TRANSACTION resource definition. For CWXN, as supplied by CICS, RESSEC(YES) is specified, meaning that resource security is active. If you do not want to use resource security checking for static responses, the best way to deactivate it is to replace CWXN in your TCPIPSERVICE definitions with an alternative transaction that specifies the program DFHWBXN and has RESSEC(NO). This setting deactivates resource security checking for CICS document templates for static responses only. Note that the RESSEC attribute cannot control security checking for z/OS UNIX files specified by the HFSFILE attribute.

You can retrieve document templates from a variety of sources, including partitioned data sets, CICS programs, CICS files, z/OS UNIX System Services files, temporary storage queues, transient data queues, and exit programs. When resource security checking is carried out for a document template, CICS does not perform any additional security checking on the resource that supplies the document template, even if resource security is specified for that type of resource in the CICS region.

To set up resource-level security for static responses using CICS document templates:

Procedure

1. Identify the authenticated user IDs used by web clients. These IDs must be the basis of your resource security checking. (You cannot supply an override using an analyzer program, as you can with application-generated responses.)

Authenticated user IDs already have a user profile defined in your security manager.

2. Identify all the CICS document templates that you are using to provide static responses.
3. Implement security for CICS document templates in your CICS region, following the instructions in [Security using the XRES resource security parameter](#).

You must define a profile to your security manager for each CICS document template that you are using to provide a static response, and give permissions to access appropriate CICS document templates to each authenticated user ID.

4. Ensure that RESSEC(YES) is specified in the TRANSACTION resource definition of CWXN or in the alternative transaction that you have specified in place of CWXN.

RESSEC(YES) is specified in CWXN as supplied by CICS, but, for TRANSACTION resource definitions in general, the default is RESSEC(NO).

This step activates resource security checking for your static responses, so ensure that, whenever a web client supplies a user ID, you have set up the appropriate permissions.

What to do next

For any security checking to take place in a CICS region, set the SEC system initialization parameter to YES.

SSL with CICS web support

You can use the Secure Sockets Layer (SSL) with HTTP to enable encryption, message authentication, and client and server authentication using certificates. When you have configured CICS to use SSL, its facilities are available for both CICS as an HTTP server, and CICS as an HTTP client.

Support for security protocols explains the facilities that SSL provides and [Configuring CICS to use SSL](#) tells you how to make SSL work with CICS.

When CICS is an HTTP server, you can use SSL to protect an interaction with a web client. You specify appropriate security options on the TCPIP SERVICE definition for the port on which CICS receives the client requests.

As well as specifying the use of SSL, you can require basic authentication or require a client certificate. To give more assistance to web clients, you can allow a client to provide a client certificate, and then register itself to the security manager to supply identification for the CICS environment. You can also allow a client to use self-registration or basic authentication as needed to supply identification. CICS handles all these activities, so, if you are providing an application-generated response, your application does not have to handle this registration. Refer to [Creating TCPIP SERVICE resource definitions for CICS web support](#).

When CICS is an HTTP client, a server might require the use of SSL for some connections. If that is the case, you need to perform some or all of these actions:

- Use HTTPS as the scheme for the connection.
- Supply a list of cipher suites that you want to use for the connection. You can specify them in the URIMAP definition that you use on the WEB OPEN command for the connection.
- Supply a client certificate. Client certificates are not a requirement for all SSL transactions, but a server might require one for particular transactions. If a server does request a client certificate, you can specify the label of a suitable certificate in the URIMAP definition that you use on the WEB OPEN command for the connection, or on the WEB OPEN command itself. The client certificate must be stored in your security manager key ring. If you use a URIMAP definition but do not specify a certificate label, the default certificate defined in the key ring for the CICS region user ID is used.

Introduction to Application Transparent Transport Layer Security (AT-TLS)

Application Transparent Transport Layer Security (AT-TLS) can be used to create secure socket sessions on behalf of CICS. Instead of implementing Transport Layer Security (TLS) in CICS, AT-TLS provides encryption and decryption of data based on policy statements that are coded in the Policy Agent. When AT-TLS is used to secure socket sessions, CICS SSL/TLS start parameters such as KEYRING and MINTLSLEVEL/ENCRYPTION are no longer required as the implementation of TLS is provided by AT-TLS policy statements and all encryption and decryption is done outside of the CICS address space.

AT-TLS MODES

When AT-TLS is active for a CICS socket connection, CICS sends and receives cleartext (unencrypted data), while AT-TLS encrypts and decrypts data at the TCP transport layer. For more information about AT-TLS and AT-TLS policy setup, see [AT-TLS policy configuration in z/OS Communications Server: IP Configuration Guide](#) and [Policy Agent and policy applications in z/OS Communications Server: IP Configuration Reference](#).

Most address spaces (such as CICS) do not need to be aware of the security negotiations and encryption that is done by TCP/IP on its behalf. However, some address spaces need to be aware of AT-TLS or have control over the security functions that are being performed by TCP/IP. For example, if the address space is a server that requires client authentication, it might want to access the client certificate and the user ID associated with the client certificate. CICS issues an AT-TLS query on a new client connection when a TCPIP SERVICE is defined with **SSL(ATTLISAWARE)**.

Address spaces such as CICS that are taking advantage of AT-TLS can be separated into three different types (AT-TLS Basic mode, AT-TLS Aware mode, and AT-TLS Controlling mode) as described in [Table 51](#)

on page 373. The type is based on whether awareness of the service is needed and, if so, the amount of control that the address space is given over the security functions.

AT-TLS Basic mode is where the address space (such as CICS) does not issue any AT-TLS calls to query a socket for its AT-TLS status.

AT-TLS Aware mode is where the address space issues an AT-TLS calls to query a socket for its AT-TLS status. The address space can access items such as the client certificate, and also the certificate User ID.

AT-TLS Controlling mode is where the address space issues AT-TLS calls to control the secure session on a socket.

<i>Table 51. Detailed description of AT-TLS modes and their CICS support</i>			
Mode Type	AT-TLS calls issued.	ApplicationControlled setting in AT-TLS policy	Supported by CICS TS for z/OS
AT-TLS Basic	Address space does not issue any AT-TLS calls	Off	All CICS releases
AT-TLS Aware	Address space issues query requests	Off	From CICS TS V5.3 For CICS as an HTTP server only
AT-TLS Controlling	Address space issues query and control requests	On	No CICS releases

AT-TLS Basic

In the basic mode, the address space is unaware that AT-TLS is encrypting or decrypting data. The AT-TLS Basic mode is the only mode that can be used in earlier releases of CICS, from V5.2.

With basic mode, the address space (such as CICS) is oblivious to the fact that TCP/IP is performing a TLS handshake and encryption/decryption of message flows on the socket.

With the basic mode of AT-TLS, a CICS TCPIP SERVICE would be defined with **SSL(NO)** as CICS is not encrypting or decrypting the data, which flows on the socket. One drawback of this is that CICS cannot access client certificates as it is unaware of a certificate that is associated with the socket. Also, when CICS uses HTTP redirection with this mode of operation, there are failures because CICS assumes that the client connection is HTTP rather than HTTPS. A problem that might arise (for example) is when you are using **AUTHENTICATE(BASIC)** on an HTTP TCPIP SERVICE, and CICS discovers that the user's password expired. A dialog is triggered with the user to request a new password. At the end of this dialog, there is an error because the resubmission of the original HTTP request specifies HTTP as the scheme instead of HTTPS.

AT-TLS Aware

The only support of AT-TLS aware mode is for CICS as an HTTP server.

CICS supports the AT-TLS Aware mode with the additional option of **SSL(ATTLSAWARE)** on the TCPIP SERVICE definition. **SSL(ATTLSAWARE)** is only allowed if the TCPIP SERVICE also specifies **PROTOCOL(HTTP)**.

When a TCPIP SERVICE is defined with **SSL(ATTLSAWARE)**, CICS issues an AT-TLS query to obtain information such as AT-TLS security status, negotiated CIPHER suite, partner certificate, and derived RACF user ID.

When an HTTP TCPIP SERVICE is defined with **SSL(ATTLSAWARE)**, CICS can access client certificates and their associated RACF USERIDs. The result is all the certificate-related TCPIP SERVICE AUTHENTICATE options (CERTIFICATE | AUTOREGISTER | AUTOMATIC) are supported by **SSL(ATTLSAWARE)**.

When a TCPIP SERVICE is defined with **SSL(ATTLISAWARE)** CICS will detect that the client is using an HTTPS connection. This means that redirection failures which can occur when using AT-TLS in basic mode (such as the expired password dialog) are fixed by using **SSL(ATTLISAWARE)**.

AT-TLS Controlling

CICS does not support AT-TLS Controlling mode.

For more information on AT-TLS modes (types), see [Application Transparent Transport Layer Security data protection in z/OS Communications Server: IP Configuration Guide](#).

CICS AT-TLS query

All new client connections for the **SSL(ATTLISAWARE)** TCPIP SERVICE are queried to extract their AT-TLS attributes. When a client establishes a new connection to a CICS TCPIP SERVICE defined with **SSL(ATTLISAWARE)**, it will trigger the query and CICS accepts the new client connection.

- Connection status (AT-TLS secured/not secured).
- Client Authentication type (NONE | PASSTHRU | FULL | REQUIRED | SAFCHECK).
- Client certificate. If present, the client certificate is saved in the CICS certificate repository. Attributes of the certificate can be retrieved later on by applications that issue **EXEC CICS EXTRACT CERTIFICATE**.
- Client certificate USERID can be used with the AUTHENTICATE option of the TCPIP SERVICE to establish the security context for the new web task. For example, **AUTHENTICATE(CERTIFICATE)** requires a CERTIFICATE USERID to be present to allow a web request to be processed.
- Negotiated CIPHER number. This number is registered in a performance monitoring record in the existing field **SO CIPHER**.

Configurations for AT-TLS and CICS TCPIPService

There are certain combinations of AT-TLS policy and CICS TCPIPService, which are valid. The table here shows these valid combinations and expected results in CICS. It also shows combinations that are invalid.

<i>Table 52. Combinations for AT-TLS and CICS TCPIPService</i>			
AT-TLS policy for the port	CICS TCPIP SERVICE	Valid combination	Expected result in CICS
HandShakeRole=Server	SSL(NO ATTLISAWARE)	Yes	The connection is successfully established. No client certificate is available.
HandShakeRole=Server or HandShakeRole=ServerWithClientAuth	SSL(YES ClientAuth)	No	CICS issues DFHWB0732 and rejects the connection.
HandShakeRole=ServerWithClientAuth with ClientAuthType=(REQUIRED SAFCHECK)	SSL(ATTLISAWARE)	Yes	The connection is successfully established. Client certificate is available.

<i>Table 52. Combinations for AT-TLS and CICS TCPIPService (continued)</i>			
AT-TLS policy for the port	CICS TCPIPService	Valid combination	Expected result in CICS
HandShakeRole=ServerWithClientAuth with ClientAuthType=(FULL)	SSL(ATTLASWARE)	Yes	The connection is successfully established. Client certificate is available if client sends it to the server.
HandShakeRole=ServerWithClientAuth with any of ClientAuthType	SSL(NO)	Yes	The connection is successfully established. No client certificate is available.
NO AT-TLS policy for the port, or the client is exempted from using an AT-TLS policy.	SSL(ATTLASWARE)	No	CICS rejects the connection with an HTTP 403 error. CICS issues DFHSO0147 for the first connection and DFHWB0365 for every non-secure connection.
HandShakeRole=ServerWithClientAuth and ClientAuthType=PASSTHRU	SSL(ATTLASWARE)	No	CICS rejects the connection because this configuration bypasses client certificate validation. CICS issues DFHSO0149 and TCPIPService is closed.
NO AT-TLS policy configured.	SSL(YES ClientAuth)	Yes	CICS processes SSL-connection as documented.

Note: For TCPIPService, configuring AT-TLS HandShakeRole=Client is incorrect.

When you are using a TCPIPService that specifies **SSL(ATTLASWARE)**, CICS expects all connections to be cryptographically secured by AT-TLS. If a client connection arrives which is not secured, it is rejected with an HTTP 403 error. CICS also logs the error with message **DFHWB0365**.

CICS does not support AT-TLS policies that use ClientAuthType=PassThru. This configuration bypasses client certificate validation, which is not acceptable to CICS. If CICS detects that this type of client authentication is being used when you are receiving a client connection, it closes the connection with the client then closes the TCPIPService. Message DFHSO0149 is written to the console when this error is detected.

How to refresh the SSL environment and cache when AT-TLS is in use

When you are using a TCPIPService that specifies **SSL(ATTLASWARE)**, the **PERFORM SSL REBUILD** command does not apply.

To refresh the SSL environment and the certificate CICS is using, follow these steps:

1. Place the new certificate into the key ring defined in your AT-TLS policy.

2. Refresh the key ring within the security manager.
3. Change or add an **EnvironmentUserInstance** value in the policy rule for this CICS traffic.
4. Issue either of the following modify commands:

```
F PAGENT , REFRESH
or
F PAGENT , UPDATE
```

If you omit step 3 or do not make other changes to the AT-TLS configuration, then the UPDATE option has no effect. UPDATE only refreshes the environment if the AT-TLS configuration has changed. If a certificate in the keyring is the only change that is made, then the REFRESH option can be used.

It is worth noting that a recycle of the CICS region will pick up an AT-TLS certificate change.

AT-TLS diagnostics

There are a number of tools for diagnosing AT-TLS problems.

For diagnosing AT-TLS problems, see [Diagnosing Application Transparent Transport Layer Security \(AT-TLS\) in z/OS Communications Server: IP Diagnosis Guide](#).

AT-TLS messages contain return codes that are useful in diagnosing problems. Return codes below 5000 come from system SSL. For more information on return codes, see [SSL function return codes in z/OS Cryptographic Services System SSL Programming](#).

Socket Domain Trace Points for AT-TLS

The socket domain trace points listed, are relevant to AT-TLS. For more information, see, [Socket domain trace points](#).

- SO 0CAC (level-1)
- SO 0CAB (EXC)
- SO 0CA9 (level-2)
- SO 0CAA (level-2)

Diagnostic Messages

The messages DFHSO0147 and DFHSO0149 are relevant to AT-TLS and detailed here, [DFHSO messages](#). Also, message DFHWB0365 is detailed here, [DFHWB messages](#).

CICS provides some diagnostic messages when you encounter errors that are discovered by CICS:

DFHWB0365

date time applid tranid A client connects to a TCIPSERVICE defined with SSL(ATTLISAWARE) but the connection is not secured by AT-TLS. Host IP address: *hostaddr*. Client IP address: *clientaddr*. TCIPSERVICE: *tcpipservice*.

DFHSO0147 W

applid A non-secure client connection is received for ATTLISAWARE TCIPSERVICE *tcpipservice*. Client IP address: *clientaddr*. TTLS_IOCTL value *X'ttlsiocl'*.

DFHSO0149 W

applid A client connection that uses **CLIENTAUTHTYPE(PASSTHRU)** is detected for ATTLISAWARE TCIPSERVICE *tcpipservice*. TTLS_IOCTL value *X'ttlsiocl'*. The TCIPSERVICE is closed.

Here are two examples of errors on AT-TLS connections:

1. The following diagnostics are seen when a client connects to an AT-TLS secured port, which is configured by using *HandShakeRole ServerWithClientAuth* and *ClientAuthType Required*. This

configuration requires the client to provide a certificate. In this case, the client fails to provide a certificate. Here is the information that is shown in the AT-TLS message log:

```
EZD1287I TTLS Error RC: 403 Initial Handshake 034
LOCAL: ::FFFF:9.20.5.0..25931
REMOTE: ::FFFF:9.174.17.124..50077
JOBNAME: SSYCZCCM RULE: CICS
USERID: HORN GRPID: 0000000D ENVID: 00000013 CONNID: 00395D99
```

The return code of 403 is a system SSL error, and corresponds to error GSK_ERR_NO_CERTIFICATE, which means no certificate received from partner. Nothing is seen in the CICS log. CICS never receives this connection as it is being rejected by AT-TLS.

2. The following diagnostics appear when a client connection is made to a TCPIP SERVICE defined with **SSL(ATTLSAWARE)** where the TCPIP SERVICE port is NOT secured by AT-TLS. This time the client is connecting to a port, which is not policed by AT-TLS and means that there are no AT-TLS diagnostics. However, CICS detects that the client connection is not secured by AT-TLS so it issues the following messages:

- DFHS00147 W IY2CZCCM 041 A non-secure client connection is received for ATTLSAWARE TCPIP SERVICE ATTLS2. Client IP address: 9.174.17.124. TTLS_IOCTL value X'0100000102010000'
- DFHWB0365 06/23/2015 10:14:22 IY2CZCCM CWXN A client connects to a TCPIP SERVICE defined with SSL(ATTLSAWARE) but the connection is not secured by AT-TLS. Host IP address: 9.20.5.0. Client IP address: 9.174.17.124. TCPIP SERVICE: ATTLS2.

The first message is only issued once for any TCPIP SERVICE. The second message is issued every time a client connects and CICS finds that the connection is NOT secured by AT-TLS.

Migration from CICS SSL to AT-TLS

You can move an existing CICS Transport Layer Security (TLS) (SSL) implementation for an inbound socket connection to Application Transparent Transport Layer Security (AT-TLS).

When CICS is used to establish a TLS (SSL) environment to perform a TLS handshake for an inbound socket connection, the attributes that are used for the handshake are extracted from two sources: region level SIT parameters and TCPIP SERVICE resource attributes.

The following two tables show the CICS SIT parameters and TCPIP SERVICE resource attributes that are used for a TLS handshake and their AT-TLS level equivalents.

SIT Parameter	AT-TLS equivalents
MINTLSLEVEL	TLSv1 TLSv1.1 TLSv1.2
ENCRYPTION (deprecated: use MINTLSLEVEL)	TLSV1 TLSV1.1 TLSV1.2
KEYRING	TTLSKeyRingParms
CRLPROFILE	TTLSGskLdapParms
SSLDELAY	GSK_V3_SESSION_TIMEOUT
MAXSSLTCBS	Cannot be configured in AT-TLS; TCB numbers grow dynamically.
SSLCACHE=SYSPLEX	GSK_SYSPLEX_SIDCACHE ON

Table 53. SIT parameters and AT-TLS equivalents (continued)	
SIT Parameter	AT-TLS equivalents
NISTSP800131A=CHECK	FIPS140 ON

Table 54. TCPIP SERVICE resource attributes and AT-TLS equivalents	
TCPIP SERVICE resource attribute	AT-TLS equivalents
SSL=YES	HandShakeRole Server
SSL=CLIENTAUTH	HandShakeRole ServerWithClientAuth with ClientAuthType FULL ClientAuthType REQUIRED and ClientAuthType SAFCHECK are also supported.
CERTIFICATE	CertificateLabel
CIPHERS	TTLSCipherParms

The following examples show how to move an existing CICS TLS implementation to AT-TLS, then remove the CICS TLS implementation.

Example 1: AT-TLS policy rules for TLS/SSL server authentication

An example configuration to use CICS to secure inbound HTTP connections might use simple server authentication on the TCPIP SERVICE resource (SSL (YES)). This configuration does not support client certificates. The following examples show the CICS configuration statements that are needed to establish the CICS-TLS environment for simple server authentication.

CICS startup parameters:

```
MINTLSLEVEL=TLS10 (or its deprecated equivalent ENCRYPTION=STRONG)
KEYRING=CICSKeyRing (includes the certificate named CICS-2048-certificate)
SSLDELAY=600
MAXSSLTCBS=8
SSLCACHE=CICS
NISTSP800131A=NOCHECK
```

SSL-related TCPIP SERVICE resource attributes:

```
TCpipservice : HTTPSSL
GRoup       : JULESWEB
DEscription ==> CICS WEB TCPIP SERVICE WITH SSL SUPPORT
Portnumber  ==> 25008
STatus      ==> Open
PROtocol    ==> Http
SSL         ==> Yes
CErtificate ==> CICS-2048-certificate
CIphers     ==> 35363738392F303132330A1613100D15120F0C
AUthenticate ==> Basic
```

To use AT-TLS to secure your inbound HTTP connections instead of CICS, you might use the following AT-TLS policy, then update the TCPIP SERVICE resource definition to SSL (NO) or SSL (ATTLISAWARE).

Note: The following example AT-TLS policy uses the TLSV1.2 option, which is supported in z/OS 2.1 and later. Using the TLSV1.2 option helps to achieve optimum performance; also, it is a prerequisite if you need to conform to NIST SP800-131A.

Full details of the NIST standards are available at the [NIST Computer Security Resource Center \(nist.gov\)](http://nist.gov).

AT-TLS configuration that replicates the CICS environment for the TCPIP SERVICE named HTTPSSL:

```
TTLSPolicy SIMPLECICS
{
```

```

LocalPortRange 25008
Direction Inbound
Priority 256
TTLSGroupActionRef CICSGroupAct1
TTLSEnvironmentActionRef CICSEnvironmentAct1
}
TTLSGroupAction CICSGroupAct1
{
TTLSEnabled On
FIPS140 off
}
TTLSEnvironmentAction CICSEnvironmentAct1
{
HandShakeRole Server
TTLSKeyRingParmsRef CICSKeyRingParms1
TTLSCipherParmsRef CICS cipherParms1
TTLSEnvironmentAdvancedParmsRef CICSEnvAdvParms1
TTLSGskAdvancedParmsRef CICSGskAdvParms1
}
TTLSKeyRingParms CICSKeyRingParms1
{
Keyring CICSKeyRing
}
TTLSCipherParms CICS cipherParms1
{
V3CipherSuites TLS_RSA_WITH_AES_256_CBC_SHA
V3CipherSuites TLS_DH_DSS_WITH_AES_256_CBC_SHA
V3CipherSuites TLS_DH_RSA_WITH_AES_256_CBC_SHA
V3CipherSuites TLS_DHE_DSS_WITH_AES_256_CBC_SHA
V3CipherSuites TLS_DHE_RSA_WITH_AES_256_CBC_SHA
V3CipherSuites TLS_RSA_WITH_AES_128_CBC_SHA
V3CipherSuites TLS_DH_DSS_WITH_AES_128_CBC_SHA
V3CipherSuites TLS_DH_RSA_WITH_AES_128_CBC_SHA
V3CipherSuites TLS_DHE_DSS_WITH_AES_128_CBC_SHA
V3CipherSuites TLS_DHE_RSA_WITH_AES_128_CBC_SHA
V3CipherSuites TLS_RSA_WITH_3DES_EDE_CBC_SHA
V3CipherSuites TLS_DHE_RSA_WITH_3DES_EDE_CBC_SHA
V3CipherSuites TLS_DHE_DSS_WITH_3DES_EDE_CBC_SHA
V3CipherSuites TLS_DH_RSA_WITH_3DES_EDE_CBC_SHA
V3CipherSuites TLS_DH_DSS_WITH_3DES_EDE_CBC_SHA
V3CipherSuites TLS_DHE_RSA_WITH_DES_CBC_SHA
V3CipherSuites TLS_DHE_DSS_WITH_DES_CBC_SHA
V3CipherSuites TLS_DH_RSA_WITH_DES_CBC_SHA
V3CipherSuites TLS_DH_DSS_WITH_DES_CBC_SHA
}
TTLSEnvironmentAdvancedParms CICSEnvAdvParms1
{
SSLv3 Off
TLsv1 On
TLsv1.1 On
TLsv1.2 On
CertificateLabel CICS-2048-certificate
}
TTLSGskAdvancedParms CICSGskAdvParms1
{
GSK_SYSPLEX_SIDCACHE off
GSK_V3_SESSION_TIMEOUT 600
}
}

```

Before you activate this AT-TLS policy, alter the CICS TCPIP SERVICE resource as follows:

```

TCpipService : HTTPSSL
GRoup : JULESWEB
DEscription ==> CICS WEB TCPIP SERVICE WITH AT-TLS SSL SUPPORT
PORTnumber ==> 25008
STatus ==> Open
PROtocol ==> Http
SSL ==> NO|ATTLsAwARE
CErtificate ==>
CIphers ==>
AUthenticate ==> Basic

```

If SSL is set to NO, CICS does not check whether AT-TLS is securing inbound client connections.

If SSL is set to ATTLsAwARE, CICS checks whether AT-TLS is securing inbound client connections. If a client connection is not secured by AT-TLS, it is rejected with an HTTP 403 error and message DFHWB0365 is written to the CICS log.

Also, if SSL is set to ATTLASWARE, CICS checks for the presence of a client certificate. The previous example AT-TLS configuration does not support the use of client certificates. Therefore, ensure that the TCPIP SERVICE definition does not specify an AUTHENTICATE option that requires client certificates. The previous example TCPIP SERVICE resource specifies AUTHENTICATE (BASIC), which does not require a client certificate.

When the AT-TLS policy is active and the TCPIP SERVICE resource is redefined to remove the SSL attributes, you can also remove all the related SSL SIT parameters. However, first ensure that nothing else in the CICS region depends on these parameters.

If your CICS-SSL system is started with **NISTSP800131A=CHECK**, CICS sets **MINTLSLEVEL=TLS12** and also sets FIPS140 on. To reflect these settings in the example AT-TLS POLICY configuration, modify it as follows:

```
TTLSTLSGroupAction CICSGroupAct1
{
  TTLSEnabled On
  FIPS140 on
}

TTLSEnvironmentAdvancedParms CICSEnvAdvParms1
{
  SSLv3 Off
  TLSV1 off
  TLSV1.1 Off
  TLSV1.2 On
  CertificateLabel CICS-2048-certificate
}
```

Example 2: AT-TLS policy rules for TLS/SSL client authentication

An example configuration to use CICS to secure inbound HTTP connections might use client authentication on the TCPIP SERVICE resource (SSL (CLIENTAUTH)). This configuration supports client certificates. The following examples show the CICS configuration statements that are needed to establish the CICS-TLS environment for client authentication.

CICS startup parameters:

```
MINTLSLEVEL=TLS10 (or its deprecated equivalent ENCRYPTION=STRONG)
KEYRING=CICSKeyRing (includes the certificate named CICS-2048-certificate)
SSLDelay=600
MAXSSLTCBS=8
SSLCACHE=CICS
NISTSP800131A=NOCHECK
```

SSL-related TCPIP SERVICE resource attributes:

```
TcpipService : CLAUTH
GRoup : JULESWEB
DEscription ==> CICS Web TCPIP SERVICE with SSL CLIENTAUTH support
PORtNumber ==> 25009
STatus ==> Open
PROtocol ==> Http
SSL ==> Clientauth
CErtificate ==> CICS-2048-certificate
CIphers ==> 35363738392F303132330A1613100D15120F0C
AUthenticate ==> Certificate
```

To use AT-TLS to secure your inbound HTTP connections instead of CICS, you might use the following AT-TLS policy, then update the TCPIP SERVICE resource definition to use SSL (ATTLASWARE).

Note: The following example AT-TLS policy uses the TLSV1.2 option, which is supported in z/OS 2.1 and later. Using the TLSV1.2 option helps to achieve optimum performance; also, it is a prerequisite if you need to conform to NIST SP800-131A.

Full details of the NIST standards are available at the [NIST Computer Security Resource Center \(nist.gov\)](http://nist.gov).

AT-TLS client authentication configuration that replicates the CICS environment for the TCPIP SERVICE named CLAUTH:

```

TTLSRule CLIENTAUTHCICS
{
LocalPortRange 25009
Direction Inbound
Priority 256
TTLSGroupActionRef CICSGroupAct2
TTLSEnvironmentActionRef CICSEnvironmentAct2
}
TTLSGroupAction CICSGroupAct2
{
}
TTLSEnabled On
FIPS140 off
}
TTLSEnvironmentAction CICSEnvironmentAct2
{
HandShakeRole ServerWithClientAuth
TTLSKeyRingParmsRef CICSKeyRingParms2
TTLSCipherParmsRef CICS cipherParms2
TTLSEnvironmentAdvancedParmsRef CICSEnvAdvParms2
TTLSGskAdvancedParmsRef CICSGskAdvParms2
}
TTLSKeyRingParms CICSKeyRingParms2
{
}
Keyring CICSKeyRing
}
TTLSCipherParms CICS cipherParms2
{
}
V3CipherSuites TLS_RSA_WITH_AES_256_CBC_SHA
V3CipherSuites TLS_DH_DSS_WITH_AES_256_CBC_SHA
V3CipherSuites TLS_DH_RSA_WITH_AES_256_CBC_SHA
V3CipherSuites TLS_DHE_DSS_WITH_AES_256_CBC_SHA
V3CipherSuites TLS_DHE_RSA_WITH_AES_256_CBC_SHA
V3CipherSuites TLS_RSA_WITH_AES_128_CBC_SHA
V3CipherSuites TLS_DH_DSS_WITH_AES_128_CBC_SHA
V3CipherSuites TLS_DH_RSA_WITH_AES_128_CBC_SHA
V3CipherSuites TLS_DHE_DSS_WITH_AES_128_CBC_SHA
V3CipherSuites TLS_DHE_RSA_WITH_AES_128_CBC_SHA
V3CipherSuites TLS_RSA_WITH_3DES_EDE_CBC_SHA
V3CipherSuites TLS_DHE_RSA_WITH_3DES_EDE_CBC_SHA
V3CipherSuites TLS_DHE_DSS_WITH_3DES_EDE_CBC_SHA
V3CipherSuites TLS_DH_RSA_WITH_3DES_EDE_CBC_SHA
V3CipherSuites TLS_DH_DSS_WITH_3DES_EDE_CBC_SHA
V3CipherSuites TLS_DHE_RSA_WITH_DES_CBC_SHA
V3CipherSuites TLS_DHE_DSS_WITH_DES_CBC_SHA
V3CipherSuites TLS_DH_RSA_WITH_DES_CBC_SHA
V3CipherSuites TLS_DH_DSS_WITH_DES_CBC_SHA
}
TTLSEnvironmentAdvancedParms CICSEnvAdvParms2
{
}
SSLv3 Off
TL SV1 On
TL SV1.1 On
TL SV1.2 On
CertificateLabel CICS-2048-certificate
ClientAuthType Full
}
TTLSGskAdvancedParms CICSGskAdvParms2
{
}
GSK_SYSPLEX_SIDCACHE off
GSK_V3_SESSION_TIMEOUT 600
}

```

Before you activate this example AT-TLS policy, alter the CICS TCPIP SERVICE resource definition as follows:

```

Tcpiptest : CLAUTH
GRoup : JULESWEB
DEscription ==> CICS Web TCPIP SERVICE with SSL CLIENTAUTH support
PORTnumber ==> 25009
STATUS ==> Open
PROtocol ==> Http
SSL ==> ATTL SAWARE
CERTIFICATE ==>
CIPHERS ==>
AUTHENTICATE ==> Certificate

```

In this example, SSL must be set to ATTL SAWARE so that CICS retrieves a client certificate from AT-TLS, because AUTHENTICATE is set to CERTIFICATE (a client certificate is required). If a client connection is

not secured by AT-TLS, it is rejected with an HTTP 403 error and message DFHWB0365 is written to the CICS log.

With **SSL(ATTLSAWARE)**, CICS checks for a client certificate. If this check maps to a RACF USERID, CICS runs the web user transaction under this USERID.

The previous example AT-TLS policy is defined with `ClientAuthType Full`. This `ClientAuthType` replicates the SSL environment and handshake behavior that occurs when CICS uses SSL. However CICS also supports `ClientAuthType Required` and `ClientAuthType SAFCheck`.

CICS does not support the use of `ClientAuthType PassThru`. If a TCPIP SERVICE port is configured by using `ClientAuthType PassThru` and the TCPIP SERVICE resource is defined with SSL (ATTLSAWARE), when the first client connection arrives, CICS detects the unsupported configuration. CICS then closes the TCPIP SERVICE and issues message DFHSO0149.

When the AT-TLS policy is active and the TCPIP SERVICE resource is redefined to remove the SSL attributes, you can also remove all the related SSL SIT parameters. However, first ensure that nothing else in the CICS region depends on these parameters.

If your CICS-SSL system is started with **NISTSP800131A=CHECK**, CICS sets **MINTLSLEVEL=TLS12** and it also sets FIPS140 on. To reflect these settings in the example AT-TLS POLICY configuration, modify it as follows:

```
TTLSTGroupAction CICSGroupAct2
{
  TTLSSEnabled On
  FIPS140 on
}

TTLSEnvironmentAdvancedParms CICSEnvAdvParms2
{
  SSLv3 Off
  TLSV1 Off
  TLSV1.1 Off
  TLSV1.2 On
  CertificateLabel CICS-2048-certificate
  ClientAuthType Full
}
```

Security for Atom feeds

CICS web support provides a suitable security protocol and authentication method to control web client access to Atom collections and if required, to Atom feeds. You can use CICS resource and command security to protect the resources that you use to deliver the Atom feed or collection.

RFC 5023 recommends that you use authentication to protect Atom collections. When you make Atom feed data available as an editable collection, a web client can insert new entries, modify existing entries, or delete entries. You must therefore ensure that you verify the identity of web clients and permit only trusted clients to have access to the collection, especially if you have included business data in your collection. Ordinary Atom feeds, which web clients cannot edit, are typically made available to any subscribers without security restrictions, although you might need to restrict access to Atom feeds if they include confidential business data or are intended only for certain users.

RFCs 4287 and 5023 discuss the use of digital signatures and encryption for Atom documents. CICS does not provide support for digital signatures and encryption of Atom documents, but, in compliance with RFC 4287, CICS does not reject an Atom document that contains a signature.

CICS web support has the following security functions that you can use to protect Atom feeds or collections from unauthorized access or updates:

SSL or TLS security protocol

RFC 5023 recommends the use of the Transport Layer Security (TLS) 1.0 as a minimum level of security protocol for collections. For a list of security protocols supported by CICS, see [Support for security protocols](#).

HTTP basic authentication

RFC 5023 recommends the use of HTTP basic authentication as a minimum level of authentication for collections.

Client certificate authentication

Client certificate authentication is a more secure method of authenticating a client, using a client certificate which is issued by a trusted third party (or Certificate Authority), and sent using SSL encryption. [SSL authentication](#) explains how this works.

When you set up these functions in CICS web support, you can apply them to an Atom feed or collection using attributes of the TCPIP SERVICE definition for the port where CICS receives web client requests for the Atom feed or collection. For information on setting up SSL support for CICS web support, see [Configuring CICS to use SSL](#).

Chapter 12. Support for securing web services

CICS Transaction Server for z/OS provides support for a number of related technologies that you can use to secure SOAP and JSON messages.

Some of these technologies are available as part of the HTTP protocol, and are equally applicable to both SOAP and JSON. Some use the Web Services Security (WSS): SOAP Message Security 1.0 specification, and are only available for SOAP. For information on the shared TCP/IP and HTTP security options, see [Security for TCP/IP clients](#) and [Security for CICS web support](#).

For information about using SAML assertions, see [Configuring CICS for SAML](#).

SOAP web services security

Web Services Security (WSS): SOAP Message Security 1.0 describes the use of *security tokens* and *digital signatures* to protect and authenticate SOAP messages. For more information, see the [Web Services Security: SOAP Message Security 1.0](#) specification. [Web Services Security: SOAP Message Security 1.0](#)

Web Services Security protects the *privacy* and *integrity* of SOAP messages by, respectively, protecting messages from unauthorized disclosure and preventing unauthorized and undetected modification. WSS provides this protection by digitally signing and encrypting XML elements in the message. The elements that can be protected are the body or any elements in the body or the header. You can give different levels of protection to different elements in the SOAP message.

The Web Services Trust Language (WS-Trust) specification enhances Web Services Security further by providing a framework for requesting and issuing security tokens, and managing trust relationships between web service requesters and providers. This extension to the authentication of SOAP messages enables web services to validate and exchange security tokens of different types by using a trusted third party. This third party is called a *Security Token Service* (STS). For more information about the Web Services Trust Language, see the [Web Services Trust Language](#) specification.

CICS Transaction Server for z/OS provides support for these specifications by using a CICS-supplied security handler in the pipeline:

- For outbound messages, CICS provides support for digital signing and encryption of the entire SOAP body. CICS can also exchange a username token for a security token of a different type with an STS.
- For inbound messages, CICS supports messages in which the body, or elements of the body and header, are encrypted or digitally signed. CICS can also exchange and validate security tokens with an STS.

CICS also provides a separate Trust client interface so that you can interact with an STS without using the CICS security handler.

Note: Web Services Security is potentially not conformant with SP800-131A. Web Services Security is configured by adding a handler into the pipeline and CICS has no control over the processing in a customer-written handler. If you use digital signatures, you can specify only the algorithms `dsa-sha1` and `rsa-sha1`. These algorithms are not SP800-131A-conformant. The two-key tripleDES encryption algorithm, which can be used to encrypt a SOAP body, is also non-conformant.

Prerequisites for Web Services Security

To implement Web Services Security, you must apply these updates to your CICS region: install the IBM XML Toolkit for z/OS v1.10 and add 3 libraries to the DFHRPL concatenation.

About this task

Complete the following steps before you implement Web Services Security:

Procedure

1. Install the free IBM XML Toolkit for z/OS v1.10.

You can download it from the following site: https://www.ibm.com/support/knowledgecenter/SSLTBW_2.3.0/com.ibm.zos.v2r3.gxla100/xmlssfunctions.htm. You must install version 1.10. Later versions do not work with Web Services Security support in CICS.

2. Add the following libraries to the DFHRPL concatenation:

- *hlq*.SIXMLOD1, where *hlq* is the high-level qualifier of the XML Toolkit.
- *hlq*.SCEERUN, where *hlq* is the high-level qualifier of the Language Environment®.
- *hlq*.SDFHWSLD, where *hlq* is the high-level qualifier of the CICS installation; for example CICSTS54.

The first two libraries contain DLLs that are required at run time by the security handler. IXM4C57 is provided by the XML Toolkit and is found in *hlq*.SIXMLOD1; C128N is provided by the Language Environment run time and is found in *hlq*.SCEERUN.

The *hlq*.SDFHWSLD library enables CICS to find the DFHWSSE1 and DFHWSXXX Web Services Security modules.

3. You might need to increase the value of the **EDSALIM** system initialization parameter.

The three DLLs that are loaded require approximately 15 MB of EDSA storage.

Results

If you do not have the libraries specified, you see the following message:

```
CEE3501S The module module_name was not found.
```

The *module_name* varies depending on which library is missing.

Planning to secure SOAP web services

You can decide the best way to secure your web services. CICS supports a number of options, including a configurable security message handler and a separate Trust client interface.

About this task

CICS implements Web Services Security (WS-Security or WSS) at a pipeline level, rather than for each web service. Answer the following questions to decide how best to implement security.

Procedure

1. Is the performance of your pipeline processing important?

The use of WSS to secure your web services incurs a significant performance impact.

The main advantage of implementing WSS is that, by encrypting part of a SOAP message, you can send the message through a chain of intermediate nodes, all of which might have legitimate reasons to look at the SOAP header to make routing or processing decisions, but are not allowed to view the content of the message. By encrypting only those sections that need to be confidential, you derive the following benefits:

- You do not incur the overhead of encrypting and decrypting at every node in a chain of intermediate processes.
- You can route a confidential message over a public network of untrusted nodes, where only the ultimate recipient of the data can understand it.

As an alternative to using WSS, you can use SSL to encrypt the whole data stream.

2. If you want to use WSS, what level of security do you want?

The options range from basic authentication, where the message header includes a user name and a password, through to combining digital signatures and encryption in the message. The options that the CICS security handler supports are described in [“Options for securing SOAP messages” on page 387](#).

3. Does the CICS-supplied security handler meet your requirements?

If you want to perform more advanced security processing, you must write your own custom security handler. This handler must perform the necessary authentication of messages, either directly with RACF or using a Security Token Service, and handle the processing of digital certificates and encrypted elements. See “[Writing a custom security handler](#)” on page 400 for details.

4. Does your pipeline include an MTOM handler?

If you are planning to enable both the MTOM handler and the security handler in your pipeline configuration file, any MIME Multipart or Related messages are processed in compatibility mode, because the security handler cannot parse the XOP elements in the body of the message. This processing can have a further effect on the performance of the pipeline processing.

Options for securing SOAP messages

CICS supports both the signing and encryption of SOAP messages, so you can select the level of security that is most appropriate for the data that you are sending or receiving in the SOAP message. Signing and encryption of SOAP messages are not supported for provider mode Axis2 web service Java applications or for provider web services that attach to the pipeline using Axis2 MessageContext.

You can choose from these options:

Trusted authentication

In service provider pipelines, CICS can accept a username token in the SOAP message header as trusted. This type of security token typically contains a user name and password, but in this case the password is not required. CICS trusts the provided user name and places it in container DFHWS-USERID, and the message is processed in the pipeline.

In service requester pipelines, CICS can send a username token without the password in the SOAP message header to the service provider.

Basic authentication

In service provider mode, CICS can accept a username token in the SOAP message header for authentication on inbound SOAP messages. This type of security token contains a user name and password. CICS verifies the username token using an external security manager, such as RACF. If successful, the user name is placed in container DFHWS-USERID and the SOAP message is processed in the pipeline. If CICS cannot verify the username token, a SOAP fault message is returned to the service requester.

Username tokens that contain passwords are not supported in service requester mode or on outbound SOAP messages.

HTTP basic authentication

In service provider mode, CICS can accept basic authentication information over an HTTP protocol. The service requester uses a URIMAP definition to specify that credentials (user identification information) can be captured by the global user exit, XWBAUTH. XWBAUTH passes this information to CICS on request and CICS sends the information in an HTTP authorization header to the service provider.

Advanced authentication

In service provider and requester pipelines, you can verify or exchange security tokens with a Security Token Service (STS) for authentication purposes. This authentication enables CICS to accept and send messages that have security tokens in the message header that are not normally supported; for example, Kerberos tokens or SAML assertions.

For an inbound message, you can select to verify or exchange a security token. If the request is to exchange the security token, CICS must receive a username token back from the STS. For an outbound message, you can exchange a username token only for a security token.

Signing with X.509 certificates

In service provider and service requester mode, you can provide an X.509 certificate in the SOAP message header to sign the body of the SOAP message for authentication. This type of security token is known as a *binary security token*. To accept binary security tokens from inbound SOAP messages,

the public key associated with the certificate must be imported into an external security manager, such as RACF, and associated with the key ring that is specified in the **KEYRING** system initialization parameter. For outbound SOAP messages, you generate and publish the public key to the intended recipients. The Integrated Cryptographic Service Facility (ICSF) is used to generate public keys.

When you specify the label associated with an X.509 digital certificate, do not use the following characters:

```
< > : ! =
```

You can also include a second X.509 certificate in the header and sign it using the first certificate. With this second certificate, you can run the work in CICS under the user ID associated with the second X.509 certificate. The certificate that you are using to sign the SOAP message must be associated with a trusted user ID, and have surrogate authority to assert that work runs under a different identity, the *asserted identity*, without the trusted user ID having the password associated with that identity.

Encrypting

In service provider and service requester mode, you can encrypt the SOAP message body using a symmetric algorithm such as Triple DES or AES. A symmetric algorithm is where the same key is used to encrypt and decrypt the data. This key is known as a *symmetric key*. It is then included in the message and encrypted using a combination of the public key of the intended recipient and the asymmetric key encryption algorithm RSA 1.5. This encryption provides you with increased security, because the asymmetric algorithm is complex and it is difficult to decrypt the symmetric key. However, you obtain better performance because the majority of the SOAP message is encrypted with the symmetric algorithm, which is faster to decrypt.

For inbound SOAP messages, you can encrypt an element in the SOAP body and then encrypt the SOAP body as a whole. This sort of encryption might be particularly appropriate for an element that contains sensitive data. If CICS receives a SOAP message with two levels of encryption, CICS decrypts both levels automatically. This sort of encryption is not supported for outbound SOAP messages.

CICS does not support inbound SOAP messages that have an encrypted element in the message header only and no encrypted elements in the SOAP body.

Signing and encrypting

In service provider and service requester mode, you can choose to both sign and encrypt a SOAP message. CICS always signs the SOAP message body first and then encrypts it. The advantage of this method is that it gives you both message confidentiality and integrity.

ICRX-based identity propagation

In service provider mode, you can use an unauthenticated ICRX (Extended Identity Context Reference) identity token in the same circumstances that you would use an unauthenticated WS-Security user ID token. An ICRX identity token is a z/OS identifier that maps to a user ID. CICS resolves the ICRX identity token to a user ID and places a copy in the DFHWS-ICRX container. CICS also populates the DFHWS-USERID container. For more information about an ICRX identity token, see [Identity propagation and distributed security](#).

Authentication using a Security Token Service

CICS can interoperate with a Security Token Service (STS), such as Tivoli Federated Identity Manager, to provide more advanced authentication of web services.

An STS is a web service that acts as a trusted third party to broker trust relationships between a web service requester and a web service provider. In a similar manner to a certificate authority in an SSL handshake, the STS guarantees that the requester and provider can "trust" the credentials that are provided in the message. This trust is represented through the exchange of security tokens. An STS can issue, exchange, and validate these security tokens, and establish trust relationships, allowing web services from different trust domains to communicate successfully. For more details, see the [Web Services Trust Language](#) specification.

CICS acts as a Trust client and can send two types of web service request to an STS. The first type of request is to validate the security token in the WS-Security message header; the second type of request

is to exchange the security token for a different type. These requests enable CICS to send and receive messages that contain different security tokens from a wide variety of trust domains, such as SAML assertions and Kerberos tokens.

You can either configure the CICS security handler to define how CICS interacts with an STS or write your own message handler to use a separately provided Trust client interface. Whichever method you select, use SSL to secure the connection between CICS and the STS.

How the security handler calls the STS

The CICS security handler uses the information in the pipeline configuration file to send a web service request to the Security Token Service (STS). The type of request that is sent depends on the action that you want the STS to perform.

In a service provider pipeline

In a service provider pipeline, the security handler supports two types of actions, depending on the way you configure the security handler:

- Send a request to the STS to validate the first instance of a security token, or the first security token of a specific type, in the WS-Security header of the inbound message.
- Send a request to the STS to exchange the first instance of a security token, or the first security token of a specific type, in the WS-Security header of the inbound message, for a security token that CICS can understand.

The security handler dynamically creates a pipeline to send the web service request to the STS. This pipeline exists until a response is received from the STS, after which it is deleted. If the request is successful, the STS returns an identity token or the status of the validity of the token. The security handler places the RACF ID that is derived from the token in the DFHWS-USERID container.

If the STS encounters an error, it returns a SOAP fault to the security handler. The security handler then passes a fault back to the web service requester.

In a service requester pipeline

In a service requester pipeline, the security handler can request only to exchange a token with the STS. The pipeline configuration file defines what type of token the STS issues to the security handler.

If the request is successful, the RACF ID is placed in the DFHWS-USERID container and the token is included in the outbound message header. If the STS encounters an error, it returns a SOAP fault to the security handler. The security handler then passes the fault back through the pipeline to the web service requester application.

The security handler can request only one type of action from the STS for the pipeline. It can also exchange only one type of token for an outbound request message, and is limited to handling the first token in the WS-Security message header, either the first instance or the first instance of a specific type. These options cover the most common scenarios for using an STS, but might not offer you the processing that you require for handling inbound and outbound messages.

If you want to provide more specific processing to handle many tokens in the inbound message headers or exchange multiple types of tokens for outbound messages, use the Trust client interface. Using this interface, you can create a custom message handler to send your own web service request to the STS.

The Trust client interface

The Trust client interface enables you to interact with a Security Token Service (STS) directly, rather than using the security handler. In this way, you have the flexibility to provide more advanced processing of tokens than the processing offered by the security handler.

The Trust client interface is an enhancement to the CICS-supplied program DFHPART. This program is usually used to start a pipeline when a web service requester application has not been deployed using the CICS web services assistant. But it can also act as the Trust client interface to the STS.

You can invoke the Trust client interface by linking to DFHPART from a message handler or header processing program, passing a channel called DFHWSTC-V1 and a set of security containers. Using these

containers, you have the flexibility to request either a validate or issue action from the STS, select which token type to exchange, and pass the appropriate token from the message header. DFHPIRT dynamically creates a pipeline, composes a web service request from the security containers, and sends it to the STS.

DFHPIRT waits for the response from the STS and passes this back in the DFHWS-RESTOKEN container to the message handler. If the STS encounters an error, it returns a SOAP fault. DFHPIRT puts the fault in the DFHWS-STSFault container and returns to the linking program in the pipeline.

You can use the Trust client interface without enabling the security handler in your service provider and service requester pipelines, or you can use the Trust client interface in addition to the security handler.

Signing of SOAP messages

For inbound messages, CICS supports digital signatures on elements in the SOAP body and on SOAP header blocks. For outbound messages, CICS signs all elements in the SOAP body.

A SOAP message is an XML document, consisting of an <Envelope> element, which contains an optional <Header> element and a mandatory <Body> element.

The WSS: SOAP Message Security specification permits the contents of the <Header> and the <Body> to be signed at the element level. That is, in a given message, individual elements can be signed or not, or can be signed with different signatures or using different algorithms. For example, in a SOAP message used in an online purchasing application, it is appropriate to sign elements that confirm receipt of an order, because these elements might have legal status. However, to avoid the overhead of signing the entire message, other information might safely remain unsigned.

For inbound messages, the security message handler can verify the digital signature on individual elements in the SOAP <Header> and the <Body>:

- Signed elements it encounters in the <Header>.
- Signed elements in the SOAP <Body>. If the handler is configured to expect a signed body, CICS rejects any SOAP message in which the body is not signed and issues a SOAP fault.

For outbound messages, the security message handler can sign the SOAP <Body> only; it does not sign the <Header>. The algorithm and key used to sign the body are specified in the handler configuration information.

Signature algorithms

CICS supports the signature algorithms required by the XML Signature specification. Each algorithm is identified by a universal resource identifier (URI).

Algorithm	URI
Digital Signature Algorithm with Secure Hash Algorithm 1 (DSA with SHA1) Supported on inbound SOAP messages only.	http://www.w3.org/2000/09/xmldsig#dsa-sha1
Rivest-Shamir-Adleman algorithm with Secure Hash Algorithm 1 (RSA with SHA1)	http://www.w3.org/2000/09/xmldsig#rsa-sha1

Example of a signed SOAP message

This example shows a SOAP message that has been signed by CICS.

```
<?xml version="1.0" encoding="UTF8"?>
<SOAP-ENV:Envelope xmlns:SOAP-ENV="http://schemas.xmlsoap.org/soap/envelope/">
<SOAP-ENV:Header>
  <wsse:Security xmlns:ds="http://www.w3.org/2000/09/xmldsig#">
```



```

xmlns:wss="http://docs.oasis-open.org/wss/2004/01/oasis-200401-wss-wssecurity-secext-1.0.xsd"
xmlns:wsu="http://docs.oasis-open.org/wss/2004/01/oasis-200401-wss-wssecurity-utility-1.0.xsd"
xmlns:xenc="http://www.w3.org/2001/04/xmenc#" SOAP-ENV:mustUnderstand="1">
<wss:BinarySecurityToken 1
  EncodingType="http://docs.oasis-open.org/wss/2004/01/oasis-200401-wss-soap-message-
security-1.0#Base64Binary"
  ValueType="http://docs.oasis-open.org/wss/2004/01/oasis-200401-wss-x509-token-profile-1.0#X509"
  wsu:Id="x509cert00">MIIChDCCAe2gAwIBAgIBADANBgkqhkiG9w0BAQUFADAwMQswCQYDVQQGEwJHcmVudDQwMDEwLWUeioePsR
SUJNMRRmEYDQDEwPpPm+UEu7mzfHRQGe7H0EnFqZpikNqZK5FF6fvY1v2JgTDPwr0SYXmhzwegUDT
MDELMAGGA1UEBhMCR0IxODAKBgNVBAoTA0lCTTETMBEGA1UEAxMKV21sbCBZYXRlczCBnzANBgkq
hkiG9w0BAQEFAAOBjQAwGyKCGYEArsRj/n+3RN75+jaxu0MBWShVZCB0egv8qu2UwLWEioePsR
6Ku4SuHbBwJtWNRi0xBTAAS91Ea70yhVdppx0nJB0CiErG7S0HudP7a8JXPfzA+BqV63JqRgJyxN6
msfTAvEMR07LIXmZate62nwcFrvCKNPFIJ5mkaJ9v1p7jkCAwEAa0BrTCBqja/Bg1ghkgBhvHC
AQ0EMhMwR2VuZXJhdGVkIGJ5IHRoZSB0ZWN1cm10eSB0ZlZ2ZXIgdz9yIHovT1MgKFJBQ0YpMDGg
ZQVRFU0BVSY5JQk0u0Q9ggdJQk0u0Q9NhgT XV1cuSUJNLkNPTyECRR1BjAo
</wss:BinarySecurityToken>
<ds:Signature xmlns:ds="http://www.w3.org/2000/09/xmldsig#">
<ds:SignedInfo xmlns:SOAP-ENV="http://schemas.xmlsoap.org/soap/envelope/"
  xmlns:ds="http://www.w3.org/2000/09/xmldsig#"
  xmlns:wsu="http://docs.oasis-open.org/wss/2004/01/oasis-200401-wss-wssecurity-utility-1.0.xsd"
  xmlns:xenc="http://www.w3.org/2001/04/xmenc#">
<ds:CanonicalizationMethod Algorithm="http://www.w3.org/2001/10/xml-exc-c14n#">
<c14n:InclusiveNamespaces xmlns:c14n="http://www.w3.org/2001/10/xml-exc-c14n#" PrefixList="ds wsu xenc SOAP-ENV "/>
</ds:CanonicalizationMethod>
<ds:SignatureMethod Algorithm="http://www.w3.org/2000/09/xmldsig#rsa-sha1"/>
<ds:Reference URI="#TheBody">
<ds:Transforms>
<ds:Transform Algorithm="http://www.w3.org/2001/10/xml-exc-c14n#">
<c14n:InclusiveNamespaces xmlns:c14n="http://www.w3.org/2001/10/xml-exc-c14n#" PrefixList="wsu SOAP-ENV "/>
</ds:Transform>
</ds:Transforms>
<ds:DigestMethod Algorithm="http://www.w3.org/2000/09/xmldsig#sha1"/> 2
<ds:DigestValue>Q0RZEA+gpaf1uShspHxhrrjaF1XE=</ds:DigestValue> 3
</ds:Reference>
</ds:SignedInfo>
<ds:SignatureValue>drDH0XESiyN6YJm27mfK1ZMG4Q4IsZqQ9N9V6kEnw2lk7aM3if77XNFnyKS4deg1bC3ga11kkaFJ 4
p4jL0mYRqqycDPpPm+UEu7mzfHRQGe7H0EnFqZpikNqZK5FF6fvY1v2JgTDPwr0SYXmhzwegUDT
1TVj0vuUgYXrFya03pw=</ds:SignatureValue>
<ds:KeyInfo>
<wss:SecurityTokenReference>
<wss:Reference URI="#x509cert00"
  ValueType="http://docs.oasis-open.org/wss/2004/01/oasis-200401-wss-x509-token-profile-1.0#X509" /
> 5
</wss:SecurityTokenReference>
</ds:KeyInfo>
</ds:Signature>
</wss:Security>
</SOAP-ENV:Header>
<SOAP-ENV:Body xmlns:wsu="http://docs.oasis-open.org/wss/2004/01/oasis-200401-wss-wssecurity-utility-1.0.xsd"
wsu:Id="TheBody">
<getVersion xmlns="http://msgsec.wssecfv1.ws.ibm.com"/>
</SOAP-ENV:Body>
</SOAP-ENV:Envelope>

```

1. The binary security token contains the base64 binary encoding of the X.509 certificate. This encoding includes the public key that the intended recipient of the SOAP message uses to verify the signature.
2. The algorithm that is used during the hashing process to produce the message digest.
3. The value of the message digest.
4. The digest value is then encrypted with the user's private key and included here as the signature value.
5. References the binary security token that contains the public key that is used to verify the signature.

CICS support for encrypted SOAP messages

For inbound messages, CICS can decrypt any encrypted elements in the SOAP body, and encrypted SOAP header blocks where the body is also encrypted. For outbound messages, CICS encrypts the entire SOAP body.

A SOAP message is an XML document, consisting of an <Envelope> element, which contains an optional <Header> element, and a mandatory <Body> element.

The WSS: SOAP Message Security specification allows some of the contents of the <Header> element and all of the contents of the <Body> element to be encrypted at the element level. That is, in a given message, individual elements can have different levels of encryption, or can be encrypted using different algorithms. For example, in a SOAP message used in an online purchasing application, it is appropriate to encrypt an individual's credit card details to ensure that they remain confidential. However, to avoid the overhead of encrypting the entire message, some information might safely be encrypted using a less secure (but faster) algorithm and other information might safely remain unencrypted.

For inbound messages, the CICS-supplied security message handler can decrypt individual elements in the SOAP <Body>, and can decrypt elements in the SOAP <Header> if the SOAP body is also encrypted. The security message handler always decrypts these elements:

- Elements it encounters in the <Header> element in the order in which the elements are found.
- Elements in the SOAP <Body> element. If you want to reject a SOAP message that does not have an encrypted <Body>, configure the handler to expect an encrypted body using the <expect_encrypted_body> element.

For outbound messages, the security message handler supports encryption of the contents of the SOAP <Body> only; it does not encrypt any elements in the <Header> element. When the security message handler encrypts the <Body> element, all elements in the body are encrypted with the same algorithm and using the same key. The algorithm, and information about the key, are specified in the configuration information about the handler.

Encryption algorithms

CICS supports the encryption algorithms required by the XML Encryption specification. Each algorithm is identified by a universal resource identifier (URI).

Algorithm	URI
Triple Data Encryption Standard algorithm (Triple DES)	http://www.w3.org/2001/04/xmlenc#tripleDES-cbc
Advanced Encryption Standard (AES) algorithm with a key length of 128 bits	http://www.w3.org/2001/04/xmlenc#aes128-cbc
Advanced Encryption Standard (AES) algorithm with a key length of 192 bits	http://www.w3.org/2001/04/xmlenc#aes192-cbc
Advanced Encryption Standard (AES) algorithm with a key length of 256 bits	http://www.w3.org/2001/04/xmlenc#aes256-cbc

Example of an encrypted SOAP message

This example of a SOAP message has been encrypted by CICS.

```
<?xml version="1.0" encoding="UTF8"?>
<SOAP-ENV:Envelope xmlns:SOAP-ENV="http://schemas.xmlsoap.org/soap/envelope/">
  <SOAP-ENV:Header>
    <wsse:Security xmlns:ds="http://www.w3.org/2000/09/xmldsig#"
      xmlns:wsse="http://docs.oasis-open.org/wss/2004/01/oasis-200401-wss-wssecurity-secext-1.0.xsd"
      xmlns:wssu="http://docs.oasis-open.org/wss/2004/01/oasis-200401-wss-wssecurity-utility-1.0.xsd"
      xmlns:xenc="http://www.w3.org/2001/04/xmlenc#" SOAP-ENV:mustUnderstand="1">
      <wsse:BinarySecurityToken
        EncodingType="http://docs.oasis-open.org/wss/2004/01/oasis-200401-wss-soap-message-
security-1.0#Base64Binary" 1
        ValueType="http://docs.oasis-open.org/wss/2004/01/oasis-200401-wss-x509-token-profile-1.0#X509"
        wsu:Id="x509cert00">MIICChDCAe2gAwIBAgIBADANBgkqhkiG9w0BAQUFADAwMQswCQYDVQGEWJH0jEMMAoGA1UEChMD
SUJNMRMwEQYDVQDEwpaXAwSIFlhdGZvMB4XDTA2MDEzMTAwMDAwMFoXDTA3MDEzMTIzNTk1OjVw
MDELMakGA1UEBhMCR0IxDDAKBgNVBAoTA01CTTETMBEGA1UEAxMKV21sbCBZYXRlc2CBnzANBgkq
hkiG9w0BAQEFAAOBjQAwYkCgYEArsRj/n+3RN75+jaxuOMBWShvZCB0egv8qu2UwLWEiogePsR
6Ku4SuHbBwJtWnR0xTAAS91Ea70yhVdppx0nJB0CiERg7S0HUdP7a8JXPfzA+BqV63JqRgJyxN6
msfTAvEMR07LIXmZAte62nwcFrvCKNPFIJ5mkaJ9v1p7jkAwEAAa0BzTCBqjA/BglghkgBhvhC
AQ0EMhMwR2VuZXJhdGVkIGJ5IHRoZSBSTZWN1cm10eSBTZXI2Z2XIgZm9yIHovT1MgKFJBQ0YpMDGg
A1UdEQQxMC+BEVdZQVRFU0BVSy5JQk0uQ09NggdJQk0uQ09NhgTXV1cuSUJNLkNPTTYcECRR1BjAO
BgnVHQ8BAf8EBAMCAfywHQYDVR00BBYEFMiPX6VZKP5+mSOY1TLNQGvVJzu+MAOGCSqGSIB3DQEB
BQUAA4GBAHdrS409Jhoe67pHL2gs7x4SpV/NOuJnn/w25sjjop3RLgJ2bKtK6RiEevhCDIm6tnYW
NyjBL1VdN7u5M6kTfd+HutR/HnIrQ3qPkXZK4ipgC0RWDJ+8APLyScxtFL+J0LN9E06yjiHL68mq
uZbTH2LvzFMy4PqEbmVKbmA87a1F
      </wsse:BinarySecurityToken>
      <xenc:EncryptedKey xmlns:xenc="http://www.w3.org/2001/04/xmlenc#">
      <xenc:EncryptionMethod Algorithm="http://www.w3.org/2001/04/xmlenc#rsa-1_5"/> 2
      <ds:KeyInfo xmlns:ds="http://www.w3.org/2000/09/xmldsig#">
        <wsse:SecurityTokenReference>
          <wsse:Reference URI="#x509cert00"
            ValueType="http://docs.oasis-open.org/wss/2004/01/oasis-200401-wss-x509-token-profile-1.0#X509"/>

```

```

3 </wsse:SecurityTokenReference>
</ds:KeyInfo>
<xenc:CipherData>
  <xenc:CipherValue>M6bDQ0tJrvX0pEjAEIcF6bq6MP3ySmB4TQ0a/B5U1Qj1vWjD56V+GRJbF7ZCES5ojwCJHRVKW1ZB5 4
    Mb+aUzSWlsoHzHQixc1JchgwCiyIn+E2TbG3R9m0zHD3XQsKTyVa0T1R7VPoMBd1ZLNDIomxjZn2
    p7JfxywXk0bcSLhdZnc=</xenc:CipherValue>
</xenc:CipherData>
<xenc:ReferenceList>
  <xenc:DataReference URI="#Enc1"/>
</xenc:ReferenceList>
</xenc:EncryptedKey>
</wsse:Security>
</SOAP-ENV:Header>
<SOAP-ENV:Body>
  <xenc:EncryptedData xmlns:xenc="http://www.w3.org/2001/04/xmlenc#" Id="Enc1" Type="http://www.w3.org/2001/04/
xmlenc#Content">
  <xenc:EncryptionMethod Algorithm="http://www.w3.org/2001/04/xmlenc#tripleDES-cbc"/> 5
  <xenc:CipherData>
    <xenc:CipherValue>kgvqKnmCgIU7r11vkFXF0g4SodEd3dxAJ0/mVN6ef211B1MZe1g70yJEHf4ZXwlCdt0FebId1nK 6
      rksql1Mpw6So7ID8zav+KPQUKGm4+E=</xenc:CipherValue>
  </xenc:CipherData>
</xenc:EncryptedData>
</SOAP-ENV:Body>
</SOAP-ENV:Envelope>

```

1. The binary security token contains the base64 binary encoding of the X.509 certificate. This encoding includes the public key that was used to encrypt the symmetric key.
2. States the algorithm that was used to encrypt the symmetric key.
3. References the binary security token that contains the public key used to encrypt the symmetric key.
4. The encrypted symmetric key that was used to encrypt the message.
5. The encryption algorithm that was used to encrypt the message.
6. The encrypted message.

Configuring RACF for Web Services Security

You must configure an external security manager, such as RACF, to create public-private key pairs and X.509 certificates for signing and encrypting outbound SOAP messages and to authenticate and decrypt signed and encrypted inbound SOAP messages.

Before you begin

Before you perform this task, you must have RACF set up to work with CICS. Specify the **DFLTUSER**, **KEYRING**, and **SEC=YES** system initialization parameters in the CICS region that contains your web services pipelines.

Note: Multiple certificates with the same Distinguished Name on the same **KEYRING** are not supported.

Procedure

1. To authenticate inbound SOAP messages that are signed:
 - a) Import the X.509 certificate into RACF as an ICSF key.
 - b) Attach the certificate to the key ring specified in the **KEYRING** system initialization parameter, using the **RACDCERT** command:

```

RACDCERT ID(userid1)
CONNECT(ID(userid2) LABEL('label-name') RING(ring-name)

```

where:

- *userid1* is the default user ID of the key ring or has authority to attach certificates to the key ring for other user IDs.
- *userid2* is the user ID that you want to associate with the certificate.
- *label-name* is the name of the certificate.
- *ring-name* is the name of the key ring that is specified in the **KEYRING** system initialization parameter.

- c) Optional: If you want to use asserted identities, ensure that the user ID associated with the certificate has surrogate authority to allow work to run under other user IDs.

Also, make sure that any additional certificates included in the SOAP message header are also imported into RACF.

The SOAP message can contain a binary security token in the header that either includes the certificate or contains a reference to the certificate. This reference can be the KEYNAME (the certificate label in RACF), a combination of the ISSUER and SERIAL number, or the SubjectKeyIdentifier. CICS can recognize the SubjectKeyIdentifier only if it has been specified as an attribute in the definition of the certificate in RACF.

2. To sign outbound SOAP messages:

- a) Create an X.509 certificate and a public-private key pair using the following **RACDCERT** command:

```
RACDCERT ID(userid2) GENCERT
SUBJECTSDN(CN('common-name')
           T('title')
           OU('organizational-unit')
           O('organization')
           L('locality')
           SP('state-or-province')
           C('country'))
WITHLABEL('label-name')
```

where *userid2* is the user ID that you want to associate with the certificate.

When you specify the certificate *label-name* value, do not use the following characters:

```
< > : ! =
```

- b) Attach the certificate to the key ring specified in the **KEYRING** system initialization parameter.

Use the **RACDCERT** command.

- c) Export the certificate and publish it to the intended recipient of the SOAP message.

You can edit the pipeline configuration file so that CICS automatically includes the X.509 certificate in the binary security token of the SOAP message header for the intended recipient to validate the signature.

3. To decrypt inbound SOAP messages that are encrypted, the SOAP message must include the public key that is part of a key pair, where the private key is defined in CICS.

- a) Generate a public-private key pair and certificate in RACF for encryption.

The key pair and certificate must be generated using ICSF.

- b) Attach the certificate to the key ring specified in the **KEYRING** system initialization parameter. Use the **RACDCERT** command.

- c) Export the certificate and publish it to the generator of the SOAP messages that you want to decrypt.

The generator of the SOAP message can then import the certificate that contains the public key and use it to encrypt the SOAP message. The SOAP message can contain a binary security token in the header that either includes the public key or contains a reference to it. This reference can be the KEYNAME, a combination of the ISSUER and SERIAL number, or the SubjectKeyIdentifier. CICS can recognize the SubjectKeyIdentifier only if it has been specified as an attribute in the definition of the public key in RACF.

4. To encrypt outbound SOAP messages:

- a) Import the certificate that contains the public key that you want to use for encryption into RACF as an ICSF key.

The intended recipient must have the private key associated with the public key to decrypt the SOAP message.

- b) Attach the certificate that contains the public key to the key ring specified in the **KEYRING** system initialization parameter. Use the **RACDCERT** command.

CICS uses the public key in the certificate to encrypt the SOAP body and sends the certificate containing the public key as a binary security token in the SOAP message header. The public key is defined in the pipeline configuration file.

What to do next

This configuration for signing and encrypting outbound messages requires that the certificate used is owned by the CICS region user ID. The certificate must be owned by the CICS region userid because RACF allows only the certificate owner to extract the private key, which is used for the signing or encryption process.

If CICS needs to sign or encrypt a message using a certificate that it does not own, you can share a single certificate between CICS systems by following the instructions in [Using an existing certificate that is not owned by the CICS region user ID](#).

Configuring provider mode web services for identity propagation

Identity propagation with a web service request relies on trust-based configurations; for example, using a client-certified SSL connection from WebSphere DataPower. In this task, you configure a PIPELINE resource to expect an ICRX identity token in the WS-Security header, sent from a trusted client.

Before you begin

You must configure your RACF RACMAP settings before you configure your web service connections, otherwise you receive the RACF ICH408I message for every unmapped request that is sent to RACF. For more information about configuring the RACF **RACMAP** command, see [Configuring RACF for identity propagation](#).

You must configure a *trust* relationship between the WebSphere DataPower appliance and CICS, for example, using SSL client certification between WebSphere DataPower and CICS. The digital certificate that WebSphere DataPower uses to identify itself must be associated with a user ID, and that user ID must be granted surrogate authority to assert identities. For more information about surrogate authority, see [Surrogate user security](#).

About this task

This task explains how to use CICS with a WebSphere DataPower appliance to provide a web service configuration that can propagate distributed identities in a secure and robust way. The circle in the diagram indicates that this task explains the CICS-specific configuration.

Figure 31. Configuring CICS to expect an ICRX identity token from WebSphere DataPower.

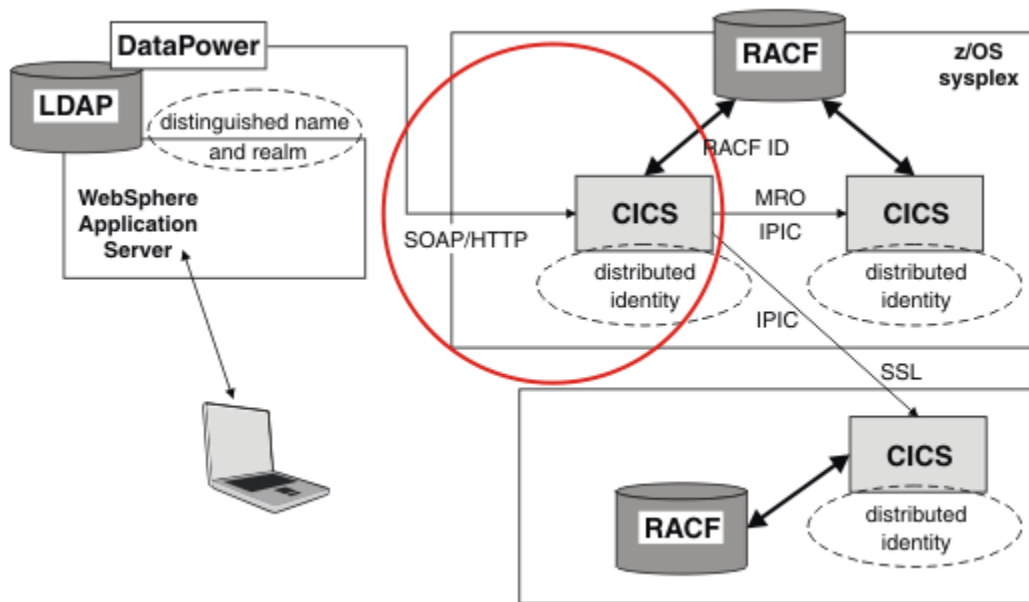

WebSphere DataPower acts as an intermediary between CICS and other applications. Remote web service requester applications connect to the WebSphere DataPower appliance using the SOAP protocol. WebSphere DataPower authenticates the credentials supplied by the remote client and mapping the credentials to a z/OS ICRX identity token, which identifies the distributed identity of a user. The SOAP message is then forwarded to CICS over the trusted SSL connection with an ICRX identity token in a WS-Security header. For more information about ICRX identity tokens, see [z/OS Security Server RACF Data Areas](#).

CICS receives the SOAP message from WebSphere DataPower. The PIPELINE configuration file specifies *blind* trust, because the only possible client is the WebSphere DataPower appliance, and WebSphere DataPower is communicating with CICS over a secure SSL connection. Therefore, you do not need to specify additional authentication in the PIPELINE configuration file. The WS-Security handler program locates the first ICRX found in the WS-Security header and uses the ICRX to identify the user.

Procedure

1. Create a PIPELINE resource, or edit an existing PIPELINE resource to specify the basic-ICRX mode, which allows the PIPELINE to receive an ICRX.

The most typical combination is the blind trust with the basic-ICRX mode. For more information about the PIPELINE resource element, see [The <authentication> element](#).

Here is an example PIPELINE configuration file, showing blind trust with the basic-ICRX mode:

```
<?xml version="1.0" encoding="EBCDIC-CP-US"?>
<provider_pipeline xmlns="http://www.ibm.com/software/htp/cics/pipeline">
  <service>
    <service_handler_list>
      <wsse_handler>
        <dfhwsse_configuration version="1">
          <authentication trust="blind" mode="basic-ICRX"/>
        </dfhwsse_configuration>
      </wsse_handler>
    </service_handler_list>
    <terminal_handler>
      <cics_soap_1.2_handler/>
    </terminal_handler>
  </service>
  <apphandler>DFHPITP</apphandler>
</provider_pipeline>
```

Here is an example SOAP message with an ICRX identity, using blind trust:

```
<?xml version="1.0" encoding="UTF-8"?>
<SOAP-ENV:Envelope
  xmlns:SOAP-ENV="http://schemas.xmlsoap.org/soap/envelope/">
  <SOAP-ENV:Header>
    <wsse:Security
      xmlns:wsse="http://docs.oasis-open.org/wss/2004/01/oasis-200401-wss-wssecurity-
secext-1.0.xsd"
      SOAP-ENV:mustUnderstand="1">

      <wsse:BinarySecurityToken EncodingType="http://docs.oasis-open.org/wss/2004/01/
oasis-200401-wss
-soap-message-security-1.0#Base64Binary"
      wsu:Id="ICRX"
      xmlns:wsu="http://docs.oasis-open.org/wss/2004/01/oasis-200401-wsswssecurity-
utility-1.0.xsd"
      ValueType="http://www.IBM.com/xmlns/prod/zos/saf#ICRXV1">

        ICRX IS HERE

      </wsse:BinarySecurityToken>

    </wsse:Security>
  </SOAP-ENV:Header>
  <SOAP-ENV:Body>

    APPLICATION SPECIFIC XML IS HERE

  </SOAP-ENV:Body>
</SOAP-ENV:Envelope>
```

2. Ensure that WebSphere DataPower is configured to be able to send ICRX information. See [Sample network topologies for using identity propagation](#).

Results

Web service requests from WebSphere DataPower with an ICRX identity token in the WS-Security header, connected over a client-certified SSL connection, can now flow.

Configuring the pipeline for Web Services Security

To configure a pipeline to support Web Services Security (WSS), you must add a security handler to your pipeline configuration files. You can use the security handler supplied with CICS, as described, or create your own.

Before you begin

Before you define the CICS-supplied security handler, you must identify or create the pipeline configuration files to which you add configuration information for WSS.

Procedure

1. Add a `<wsse_handler>` element to your pipeline.

The handler must be included in the `<service_handler_list>` element in a service provider or requester pipeline.

Code the following elements:

```
<wsse_handler>
  <dfhwsse_configuration version="1">

  </dfhwsse_configuration>
</wsse_handler>
```

The `<dfhwsse_configuration>` element is a container for the other elements in the configuration.

2. Optional: Code an `<authentication>` element.

- In a service requester pipeline, the <authentication> element specifies the type of authentication that must be used in the security header of outbound SOAP messages.
- In a service provider pipeline, the element specifies whether CICS uses the security tokens in an inbound SOAP message to determine the user ID under which work is processed.
- a) Code the **trust** attribute to specify whether asserted identity is used and the nature of the trust relationship between service provider and requester.
For details of the **trust** attribute, see [The <authentication> element](#).
- b) Optional: If you specified **trust=none**, code the **mode** attribute to specify how credentials found in the message are processed.
For details of the **mode** attribute, see [The <authentication> element](#).
- c) In the <authentication> element, code these elements:
 - i) An optional, empty <suppress/> element.

If this element is specified in a service provider pipeline, the handler does not attempt to use any security tokens in the message to determine under which user ID the work runs.

If this element is specified in a service requester pipeline, the handler does not attempt to add to the outbound SOAP message any of the security tokens that are required for authentication.
 - ii) In a requester pipeline, an optional <algorithm> element that specifies the URI of the algorithm that is used to sign the body of the SOAP message. You must specify this element if the combination of trust and mode attribute values indicate that the messages are signed. You can specify only the RSA with SHA1 algorithm in this element. The URI is `http://www.w3.org/2000/09/xmlsig#rsa-sha1`.
 - iii) An optional <certificate_label> element that specifies the label that is associated with an X.509 digital certificate installed in RACF. If you specify this element in a service requester pipeline and the <suppress> element is not specified, the certificate is added to the security header in the SOAP message. If you do not specify a <certificate_label> element, CICS uses the default certificate in the RACF key ring.

This element is ignored in a service provider pipeline.

3. Optional: Code an <sts_authentication> element as an alternative to the <authentication> element.

You must not code both in your pipeline configuration file. This element specifies that a Security Token Service (STS) is used for authentication and determines the type of request that is sent.

- a) Optional: In service provider mode only, code the **action** attribute to specify whether the STS verifies or exchanges a security token.
For details of the **action** attribute, see [The <sts_authentication> element](#).
- b) Within the <sts_authentication> element, code these elements:
 - i) An <auth_token_type> element. This element is required when you specify a <sts_authentication> element in a service requester pipeline and is optional in a service provider pipeline. For more information, see [The <auth_token_type> element](#).
 - In a service requester pipeline, the <auth_token_type> element indicates the type of token that STS issues when CICS sends it the user ID contained in the DFHWS-USERID container. The token that CICS receives from the STS is placed in the header of the outbound message.
 - In a service provider pipeline, the <auth_token_type> element is used to determine the identity token that CICS takes from the message header and sends to the STS to exchange or validate. CICS uses the first identity token of the specified type in the message header. If you do not specify this element, CICS uses the first identity token that it finds in the message header. CICS does not consider the following as identity tokens:
 - wsu:Timestamp
 - xenc:ReferenceList

- xenc:EncryptedKey
- ds:Signature

ii) In a service provider pipeline only, an optional, empty <suppress/> element. If this element is specified, the handler does not attempt to use any security tokens in the message to determine the user ID that the work runs under. The <suppress/> element includes the identity token that is returned by the STS.

4. Optional: Code an <sts_endpoint> element.

Use this element only if you have also specified an <sts_authentication> element. In the <sts_endpoint> element, code the following elements:

- An <endpoint> element. This element contains a URI that points to the location of the Security Token Service (STS) on the network. It is recommended that you use SSL or TLS to keep the connection to the STS secure, rather than using HTTP.

To use SAML support, set the endpoint to `cics://PROGRAM/DFHSAML`.

You can also specify a WebSphere MQ endpoint, by using the JMS format of URI.

- An optional <jvmserver> element. This element identifies the JVM server that is configured to run the SAML token service. If this element is not included, the default sample resource JVM server DFHXSTS is assumed. This element is valid only if you are using SAML: if you use it in other situations, an error occurs.

5. Optional: If you require inbound SOAP messages to be digitally signed, code an empty <expect_signed_body/> element.

The <expect_signed_body/> element indicates that the <body> of the inbound message must be signed. If the body of an inbound message is not correctly signed, CICS rejects the message with a security fault.

6. Optional: If you want to reject inbound SOAP messages that are digitally signed, code an empty <reject_signature/> element.

7. Optional: If you require inbound SOAP messages to be encrypted, code an empty <expect_encrypted_body/> element.

The <expect_encrypted_body/> element indicates that the <body> of the inbound message must be encrypted. If the body of an inbound message is not correctly encrypted, CICS rejects the message with a security fault.

8. If you want to reject inbound SOAP messages that are partially or fully encrypted, code an empty <reject_encryption/> element.

9. Optional: If you require outbound SOAP messages to be signed, code a <sign_body> element.

- a) In the <sign_body> element, code an <algorithm> element.
- b) Following the <algorithm> element, code a <certificate_label> element.

Here is an example of a completed <sign_body> element:

```
<sign_body>
  <algorithm>http://www.w3.org/2000/09/xmldsig#rsa-sha1</algorithm>
  <certificate_label>SIGCERT01</certificate_label>
</sign_body>
```

10. Optional: If you require outbound SOAP messages to be encrypted, code an <encrypt_body> element.

- a) In the <encrypt_body> element, code an <algorithm> element.
- b) Following the <algorithm> element, code a <certificate_label> element.

Here is an example of a completed <encrypt_body> element:

```
<encrypt_body>
  <algorithm>http://www.w3.org/2001/04/xmlenc#tripledes-cbc</algorithm>
  <certificate_label>ENCCERT02</certificate_label>
</encrypt_body>
```

Example

The following example shows a completed security handler in which most of the optional elements are present:

```
<wsse_handler>
  <dfhwsse_configuration version="1">
    <authentication trust="signature" mode="basic">
      <suppress/>
      <certificate_label>AUTHCERT03</certificate_label>
    </authentication>
    <expect_signed_body/>
    <expect_encrypted_body/>
    <sign_body>
      <algorithm>http://www.w3.org/2000/09/xmldsig#rsa-sha1</algorithm>
      <certificate_label>SIGCERT01</certificate_label>
    </sign_body>
    <encrypt_body>
      <algorithm>http://www.w3.org/2001/04/xmlenc#tripledes-cbc</algorithm>
      <certificate_label>ENCCERT02</certificate_label>
    </encrypt_body>
  </dfhwsse_configuration>
</wsse_handler>
```

Writing a custom security handler

If you want to use your own security procedures and processing, you can write a custom message handler to process secure SOAP messages in the pipeline.

Before you begin

You need to decide the level of security that your security handler must support, and ensure that an appropriate SOAP fault is returned when a message includes security that is not supported.

About this task

The message handler must also be able to cope with security on inbound and outbound messages.

Procedure

1. Retrieve the DFHREQUEST or DFHRESPONSE container using an **EXEC CICS GET CONTAINER** command.
2. Parse the XML to find the security token that is in the WS-Security message header.
The header starts with the `<wsse:Security>` element. The security token might be a user name and password, a digital certificate, or an encryption key. A message can have many tokens in the security header, so your handler needs to identify the correct one to process.
3. Perform the appropriate processing, depending on the security that is implemented in the message.
 - a) If you want to perform basic authentication of a Kerberos token, issue an **EXEC CICS VERIFY TOKEN** command.
This command checks that the supplied Kerberos token is valid.
If the command is successful, update the DFHWS-USERID container with an **EXEC CICS PUT CONTAINER**. Otherwise, issue an **EXEC CICS SOAPFAULT CREATE** command.
 - b) If you want to perform basic authentication of a password or password phrase, issue an **EXEC CICS VERIFY PHRASE** command.
This command checks the user name and password in the security header of the message.
If the command is successful, update the DFHWS-USERID container with an **EXEC CICS PUT CONTAINER**. Otherwise, issue an **EXEC CICS SOAPFAULT CREATE** command.
 - c) If you want to perform advanced authentication, either by exchanging or validating a range of tokens with a Security Token Service, use the Trust client interface.
See [“Invoking the Trust client from a message handler” on page 401](#) for details.
 - d) Validate the credentials of the digital certificate if the message is signed.

- e) If parts of the message are encrypted, decrypt the message using the information in the security header.

The [How CICS complies with Web Services Security specifications](#) specification provides information about how to do this.

Results

Define your security handler program in CICS and update the pipeline configuration file, ensuring that it is correctly placed in the XML. In a service requester pipeline configuration file, the security handler must be configured to run at the end of the pipeline. In a service provider pipeline configuration file, the security handler must be configured to run at the beginning of the pipeline.

What to do next

For general information about how to write a custom message handler, see [IBM Redbooks: Application Development for IBM CICS Web Services](#).

Invoking the Trust client from a message handler

CICS provides an interface so that you can write your own message handler to invoke a Security Token Service (STS). With this interface you can perform more advanced processing than the CICS-supplied security handler.

Before you begin

About this task

You can use the Trust client instead of the security handler or in addition to it. To use the Trust client interface:

Procedure

1. Extract the correct token from the security message header of the inbound or outbound message.
2. Link to program DFHPIRT, passing the channel DFHWSTC-V1 and the following required containers:
 - DFHWS-STSURURI, containing the location of the STS on the network.
 - DFHWS-STSACTION, containing the URI of the type of request that the STS must perform. The two supported actions are `issue` and `validate`.
 - DFHWS-IDTOKEN, containing the token that must either be verified or exchanged by the STS.
 - DFHWS-TOKENTYPE, containing the type of token that the STS must send back in the response.
 - DFHWS-SERVICEURI, containing the URI of the web service operation that is being invoked.

You can optionally include the DFHWS-XMLNS container to provide the namespaces of the SOAP message that contains the security token. This container is described in more detail in [The header processing program interface](#).

3. DFHPIRT returns with the response from the STS.

A successful response is stored in the DFHWS-RESTOKEN container.

If the STS encounters a problem with the request, it returns a SOAP fault. DFHPIRT puts the SOAP fault in the DFHWS-STSFault container. If the STS provides a reason for issuing the SOAP fault, the reason is put in the DFHWS-STSRReason container.

If an abend occurs, a DFHERROR container is returned that contains details of the processing error.

Your message handler must handle these responses and perform suitable processing in the event of an error. For example, the message handler might return a suitable SOAP fault to the web service requester.

4. Process the response as appropriate.

In provider mode, your pipeline processing must ensure that a user name that CICS can understand is placed in the DFHWS-USERID container by the time the message reaches the application handler. In requester mode, your message handler must add the correct token to the outbound message security header.

What to do next

When you have written your message handler, deploy the program in CICS and update the appropriate pipeline configuration files. In service requester pipelines, define your message handler to occur at the end of the pipeline processing but before the CICS-supplied security handler. In service provider pipelines, define your message handler at the beginning of the pipeline but after the CICS-supplied security handler.

Security for z/OS Connect

z/OS Connect is a WebSphere Liberty application, and has the same configuration and considerations as other WebSphere Liberty applications. In addition, z/OS Connect for CICS 1.0 and z/OS Connect Enterprise Edition have some extra security requirements.

z/OS Connect for CICS 1.0 and z/OS Connect Enterprise Edition have a RESTful management interface to allow dynamic service discovery. This interface is hosted at the same host name and port number as the individual JSON Services. The use of Transport Layer Security (TLS) to protect this interface, and the individual JSON Services, is encouraged.

By default, all client connections to z/OS Connect for CICS 1.0 and z/OS Connect Enterprise Edition must use the HTTPS protocol. The default behavior is to require a client-certified TLS connection to CICS. If this default is retained, client certificates must be associated with a SAF user ID. The application runs by using this certificate-derived identity.

Both z/OS Connect for CICS 1.0 and z/OS Connect Enterprise Edition can be configured to support the HTTP basic authentication protocol. This protocol allows a client to connect by using TLS in combination with a SAF user ID and password. To enable support for HTTP basic authentication, add the following line to the Liberty server configuration file (`server.xml`): `<webAppSecurity allowFailOverToBasicAuth="true"/>`

Users of z/OS Connect for CICS 1.0 and z/OS Connect Enterprise Edition must be a member of the `zos.connect.access.roles.zosConnectAccess` EJBROLE. For more information, see [Authorization using SAF role mapping](#)

See [Configuring authorization for applications in Liberty](#) for Liberty information, [Configuring security for z/OS Connect for z/OS Connect](#) information, and [Securing z/OS Connect EE resources in z/OS Connect Enterprise Edition](#) product documentation for z/OS Connect EE information.

For further information, see [Authorization using SAF role mapping](#), and [Configuring security for a Liberty JVM server](#).

Configuring permissions for z/OS Connect Services and APIs

The CICS security model requires some additional actions in the way that you configure permissions for Services and APIs with z/OS Connect for CICS 1.0 and z/OS Connect Enterprise Edition.

About this task

When z/OS Connect is used to inject work into CICS, the following two identities are associated with the work at different stages of the processing:

- An initial, temporary identity is allocated during the process of attaching the work.
- An authenticated identity is then used to run the remainder of the work.

You can configure these identities in several ways, depending on your preferences and system environment.

Procedure

1. Optional: Create an alternative initial user ID for z/OS Connect.

By default, the initial identity is the default CICS user ID, but you might choose to assign a different user ID to avoid giving the default CICS user ID permission to run transaction CPIH, or its equivalent.

- a) Authorize the alternative initial user ID to run transaction CPIH and any other transactions that are initiated through z/OS Connect.

The initial user ID requires permission to run the target transaction for the Service or API.

2. Assign a default initial user ID. You can choose either or both of the following methods:

- Set a user ID override value in the JVM profile for the JVMSERVER resource that hosts z/OS Connect.

The following is an example override, where ZOSCUSER is the default initial user ID:
`-Dcom.ibm.cics.jvmserver.http.userid=ZOSCUSER`

Note: If you set a default initial user ID in the JVM profile, you do not need to provide a USERID value for each URIMAP. However, If you provide both a USERID for a URIMAP and an override value in the JVM profile, the USERID specified for a given URIMAP takes precedence.

- Set the USERID field for a given URIMAP resource that targets z/OS Connect.

When an HTTP request is received by z/OS Connect, CICS matches it against the URIMAP resources that are installed. If the URIMAP that is found specifies the USERID attribute, that user ID is used as the initial user ID, instead of the default initial user ID for the JVM server.

Here is an example configuration for a URIMAP resource named ZOSCDEFT, where JVMSERVER is the USAGE value, a generic value is set for the PATH attribute, CPIH is the target transaction, and ZOSCUSER is the default initial user ID:

```
NAME: ZOSCDEFT
USAGE: JVMSERVER
SCHEME: HTTP
PORT: NO
HOST: *
PATH: /zosConnect/*
TRANSACTION: CPIH
USERID: ZOSCUSER
```

Note: URIMAP resources that are installed by using the PIPELINE SCAN mechanism are unlikely to be configured with a default user ID. In this scenario, you might consider specifying a user ID override value on the JVMSERVER.

Note: It is possible to store an initial user ID in a WSBind file: the user of DFHLS2JS or DFHJS2LS might provide a value for the **USERID** input parameter. If the **USERID** parameter is used, any URIMAPs that are produced during a PIPELINE SCAN include the requested initial user ID.

Results

You have now configured your environment so that CICS recognizes the URIs for your Services and APIs, and associates an initial user ID for use when the target transaction is attached.

Chapter 13. Security in BTS

Security considerations for CICS business transaction services are the authority to access BTS resources, the user IDs under which a process and its constituent activities run, the authority to attach the process and its constituent activities and the authority to use BTS system programming commands.

CICS security is described in detail in [Securing overview](#). Users of external security managers (ESMs) other than the Resource Access Control Facility (RACF) must read this information with the documentation for their own ESM.

Resource security in BTS

You can protect BTS resources such as processes, activities, and containers in the same way as resources accessed by CICS file control commands. That is, resource-level security for a process, its activities, and their containers is based on the CICS file definition that specifies the repository data set to which records for processes of this type are written.

Users who run programs that define or acquire processes or activities of a particular process-type need UPDATE access to the corresponding CICS file.

Note: When a task issues an ACQUIRE command, CICS allows the appropriate record to be read from the BTS repository, even if the userid associated with the request has only READ access. However, when the task issues a sync point the record is written back to the data set and, if the userid does not have UPDATE access, the task abends.

Users who inquire on or browse processes or activities of a particular process-type need at least READ access to the corresponding CICS file.

Process and activity user IDs

You can use either the RUN or LINK command to activate a process or activity. The command that you use affects the user ID under which the process or activity runs.

User IDs for activities activated by RUN commands

When a process or activity is activated by a RUN command, it might run using a different user ID than the transaction that issues the RUN.

The application programmer can specify under whose authority a process or activity is to run, when it is activated by a RUN command, by coding the user ID option of the DEFINE PROCESS or DEFINE ACTIVITY command. If the user ID option is omitted, its value defaults to the userid of the transaction that issues the DEFINE command.

The user ID obtained from the DEFINE command is referred to as the **defined process userid** or the **defined activity userid**. In the remainder of this section, we use the term “defined user ID” to mean either a defined process user ID or a defined activity user ID.

If the user ID option of DEFINE PROCESS or ACTIVITY is specified, CICS performs (at define time) a surrogate security check to verify that the userid of the transaction that issued the DEFINE command is authorized to use the defined user ID. The RACF profile used for surrogate checking of a BTS process or activity is `userid.DFHSTART` in the SURROGAT class.

The following example RACF commands authorize a user as a surrogate user of a defined process userid and of a defined activity userid:

```
RDEFINE SURROGAT defined_process_userid.DFHSTART UACC(NONE)
    OWNER(defined_process_userid)

PERMIT defined_process_userid.DFHSTART CLASS(SURROGAT)
    ID(define_process_command_userid) ACCESS(READ)

RDEFINE SURROGAT defined_activity_userid.DFHSTART UACC(NONE)
```

```
OWNER(defined_activity_userid)
PERMIT defined_activity_userid.DFHSTART CLASS(SURROGAT)
ID(define_activity_command_userid) ACCESS(READ)
```

User IDs for activities activated by LINK commands

When a process or activity is activated by a LINK command, it runs under the userid of the transaction that issues the LINK.

Resource-level security checking *in* a process or activity is based on the user ID under whose authority the process or activity runs - that is, the defined userid or the userid of the transaction that issues the LINK command. This user ID must have UPDATE access to the CICS file that corresponds to the process-type.

Attach-time security for processes and activities

You can use Attach-time security to check if a transaction has authority to attach (activate) a process or activity. Attach-time security applies only when a process or activity is activated by a RUN command, not when it is activated by a LINK.

If attach-time security is required for a process, the defined userid - that is, the userid obtained from the DEFINE PROCESS command, must be given UPDATE access to the CICS file that corresponds to the BTS data set on which details of the process and its constituent activities are stored.

Command security in BTS

You can use CICS command-level security to protect your BTS system programming commands: **EXEC CICS CREATE PROCESSTYPE**, **DISCARD PROCESSTYPE**, **INQUIRE PROCESSTYPE**, and **SET PROCESSTYPE**.

Chapter 14. Security for the CICS-WebSphere MQ adapter

The CICS-WebSphere MQ adapter provides information to WebSphere MQ specifically for use in WebSphere MQ security.

Information provided is as follows:

- Whether CICS resource-level security is active for this transaction. For more information, see [“Resource security”](#) on page 70.
- User IDs.
 - For terminal tasks where a user has not signed on, the user ID is the CICS user ID associated with the terminal and is one of the following:
 - The default CICS user ID as specified on the CICS **DFLTUSER** system initialization parameter.
 - A preset security user ID specified on the terminal definition.
 - For nonterminal tasks, the adapter acquires the user ID with a call to the user domain.

Implementing security for CICS-MQ adapter transactions

If you want a user to administer the CICS-MQ adapter, you must grant the user authorization to the appropriate CICS transactions.

If required, you can restrict access to specific functions of the adapter. For example, if you want to allow users to display the current status of the adapter, but nothing else, give them access to CKQC, CKBM, CKRT, and CKDP only.

Define these transactions to CICS with RESSEC(NO) and CMDSEC(NO). For more details, see [Security of resource definitions](#) and [CICS command security](#).

Transaction	Function
CKAM	Alert monitor
CKBM	Controls the adapter functions
CKCN	Connect
CKDL	Line mode display
CKDP	Full screen display
CKQC	Controls the adapter functions
CKRS	Statistics
CKRT	Controls the adapter functions
CKSD	Disconnect
CKSQ	CKTI START/STOP
CKTI	Trigger monitor

As well as administrators, user IDs connecting to WebSphere MQ, the user ID set in the **PLTPIUSR** system initialization parameter, and the [CICSplex SM MAS agent user ID](#) must also be authorized to run the CKTI and CKAM transactions.

Security for MQCONN and MQMONITOR commands

Use CICS command security to control users' ability to issue SPI commands against MQCONN and MQMONITOR resource definitions. For example, you can use it to control which users are allowed to issue CREATE and DISCARD commands against the MQCONN resource definition for the CICS region.

When command security is enabled for a transaction, the external security manager checks that the user ID associated with the transaction is authorized to use the command on the MQCONN or MQMONITOR resource as appropriate. Resource security is not available for MQCONN and MQMONITOR resources.

CICS command security covers the **EXEC CICS CREATE MQCONN, DISCARD MQCONN, SET MQCONN, INQUIRE MQCONN, CREATE MQMONITOR, DISCARD MQMONITOR, SET MQMONITOR, and INQUIRE MQMONITOR** commands. For an explanation of command security and instructions to set up command security for a CICS region, see [CICS command security](#). For a listing of the level of authority required for each command, see [Resource and command check cross-reference](#).

When command security is active, to use the **EXEC CICS SET MQCONN** command to start or stop the connection to WebSphere MQ, users must have authority to use the **EXEC CICS SET MQCONN** command, authority to issue **EXEC CICS START** commands for the transaction associated with the installed MQMONITOR resources, and also the authority to use the **EXEC CICS EXTRACT EXIT** command. If a user attempts to start or stop the connection when they do not have authority to use the **EXEC CICS EXTRACT EXIT** command, CICS issues messages DFHXS1111 and DFHM0302. If a user does not have authority to issue command **EXEC CICS START** specifying the transaction associated with the MQMONITOR, CICS issues message DFHM0390. User-written MQMONITOR programs must have authority to the **EXEC CICS SET MQMONITOR** command.

CICS-WebSphere MQ adapter user IDs

The user ID associated with the CICS-WebSphere MQ adapter is that of the WebSphere MQ-supplied task initiator transaction, CKTI.

User ID of CKTI started by MQMONITOR

If an instance of CKTI is started by an MQMONITOR, the user ID associated with the CKTI transaction is obtained as follows:

- If security checking is active (that is, the **SEC** system initialization parameter is set to YES), the user ID is obtained from the **MONUSERID** attribute of the MQMONITOR resource.
- If security checking is disabled (that is, **SEC** is set to NO), the user ID is the user ID of the transaction that set the MQMONITOR state to started.

User ID checking for WebSphere MQ resources during PLTPI and PLTSD

If a WebSphere MQ resource is accessed during the CICS PLTPI phase, the user ID passed to WebSphere MQ is that specified in the PLTPIUSR system initialization parameter. If a WebSphere MQ resource is accessed during the CICS PLTSD phase, the user ID passed to WebSphere MQ is the user ID associated with the shutdown transaction.

Connection security for the CICS-WebSphere MQ adapter

WebSphere MQ carries out connection security checking either when an application program tries to connect to a queue manager by issuing an MQCONN or MQCONN request, or when the channel initiator, or CICS-WebSphere MQ adapter issues a connection request.

If you are using queue manager level security, you can turn connection security checking off for a particular queue manager, but, if you do that, any user can connect to that queue manager.

Only the CICS address space user ID is used for the connection security check, not the individual CICS terminal user ID.

You can turn WebSphere MQ connection security checking on or off at either queue manager or queue-sharing group level.

Chapter 15. Security for the CICS-WebSphere MQ bridge

When you start the CICS-WebSphere MQ bridge, you can specify the level of authentication. If requested, the bridge monitor checks the user ID and password extracted from the WebSphere MQ request message before running the CICS program named in the request message.

When you run the CICS-WebSphere MQ bridge monitor transaction (for example, CKBR or your transaction name), you can specify the **AUTH** parameter to select one of the following levels of authentication:

LOCAL

This level is the default. The bridge monitor starts the bridge task with the CICS default user ID. CICS user programs that the bridge task runs have the authority associated with this user ID. The WebSphere MQ request message cannot request higher authority because any user IDs or passwords in the message are ignored. If the bridge task runs a CICS program that tries to access protected resources, the CICS program might fail.

IDENTIFY

If the message descriptor (MQMD) in the request message specifies a user ID, the bridge monitor starts the bridge task with that user ID. CICS user programs that the bridge task runs have the authority associated with that user ID. The user ID is treated as trusted; that is, the bridge monitor does not authenticate the ID by using password or PassTicket information. If the MQMD does not specify a user ID, the bridge monitor starts the bridge task with the CICS default user ID, in the same way as the LOCAL option.

VERIFY_UOW

The bridge monitor uses the password or PassTicket to authenticate the user ID if all the following conditions apply:

- The message descriptor (MQMD) in the request message specifies a user ID.
- The request message includes a WebSphere MQ CICS information header (MQCIH).
- The Authenticator field in the MQCIH contains a password or PassTicket.

If authentication succeeds, the bridge monitor starts the bridge task with that user ID. If authentication fails, the bridge monitor fails the request with a MQCRC_SECURITY_ERROR return code.

If any one of the conditions listed earlier is not met, the bridge monitor starts the bridge task with the CICS default user ID, in the same way as the LOCAL option. Only the first request message in the unit of work is checked; the bridge ignores user ID and password or PassTicket information in subsequent messages that are part of the same unit of work.

VERIFY_ALL

This level is the same as VERIFY_UOW, except that the bridge task also checks that the user ID is the same in every request message in the same unit of work, and reauthenticates the user ID for each request message, using the password or PassTicket that the message contains.

If you require different levels of authentication for different applications, use multiple bridge monitors with different transaction IDs. You can use CICS surrogate security to restrict the combinations of transaction and user ID that a bridge monitor transaction and user ID can start.

Table 55 on page 412 shows the user ID under which the bridge monitor is started. The user ID depends on the method that you use to run the bridge monitor transaction, typically CKBR.

Table 55. CICS-WebSphere MQ bridge monitor security

Bridge monitor start method	At a signed on terminal	User ID for bridge monitor
From a terminal or EXEC CICS LINK in a program	Yes	Signed-on user ID
From a terminal or EXEC CICS LINK in a program	No	CICS default user ID
EXEC CICS START with user ID	–	User ID from START
EXEC CICS START without user ID	–	User ID from START
The CICS-WebSphere MQ trigger monitor CKTI	–	User ID from START
The CICS-WebSphere MQ monitor (MQMONITOR)	–	<ul style="list-style-type: none"> The MONUSERID attribute of the MQMONITOR resource, if security checking is active for the CICS region (that is, the SEC system initialization parameter is set to YES) User ID that started the MQMONITOR resource, if security checking is disabled for the CICS region (that is, SEC is set to NO)

User IDs and passwords in request messages

When you use the IDENTIFY, VERIFY_UOW, or VERIFY_ALL authentication options, the bridge task and the CICS programs that it runs are started with the user ID that is specified in the message descriptor (MQMD) in the request message. With the VERIFY_UOW and VERIFY_ALL options, the bridge monitor also checks the password specified in the WebSphere MQ CICS information header (MQCIH) in the request message.

To use these levels of authentication, the WebSphere MQ applications must provide a user ID in the MQMD, and they must provide an MQCIH including the password. You must define these user IDs to RACF. To control the user IDs used, the WebSphere MQ applications must open the request queue for the bridge monitor using open options that include MQOO_SET_IDENTITY_CONTEXT. The applications must also include a value of MQPMO_SET_IDENTITY_CONTEXT in their put message options.

If the bridge monitor finds a problem with the user ID or the password in a request message, it acts as follows:

- For the IDENTIFY level of authentication, if a message contains a user ID that was revoked, abend AICO might occur. The error reply has return code MQCRC_BRIDGE_ERROR with reason MQFB_CICS_BRIDGE_FAILURE.
- For the VERIFY_UOW or VERIFY_ALL level of authentication, if the user ID or password is invalid, the request fails with return code MQCRC_SECURITY_ERROR.
- If a request message omits either the user ID or the password, the bridge monitor runs the bridge task with the LOCAL level of authentication, even if you started the bridge monitor with one of the other authentication options. In that situation, the CICS programs started by the bridge task run with the user ID under which the bridge monitor was started.

You can use a PassTicket in place of a password to avoid the need to flow passwords in messages.

- The WebSphere MQ application must provide the PassTicket in the MQCIH in the request message.
- To generate a PassTicket, an application ID is required. The default application ID is the CICS APPLID. You can specify an alternative application ID by using the **PASSTKTA** parameter when you start the CICS-WebSphere MQ bridge monitor transaction (for example, CKBR or your transaction name).
- If you use multiple bridge monitors for the same request queue, you must use the **PASSTKTA** parameter to specify the same application ID for each bridge monitor.

PassTicket validation is performed by using WebSphere MQ services, not EXEC CICS VERIFY, because the CICS service does not allow you to specify an APPLID. For more information about PassTickets, see [Generating and using PassTickets for secure sign-on](#) and [Setting up security on z/OS in IBM MQ product documentation](#).

Authority

You must give the following permissions to the user IDs that you use with the CICS-WebSphere MQ bridge. The user IDs include the user ID under which the bridge monitor transaction is started, as listed in [Table 55 on page 412](#), and any user IDs that WebSphere MQ applications specify in request messages.

- The user ID under which the bridge monitor transaction is started must have authority to start the CKBP and CKBC transactions for CICS DPL programs, and any alternative transactions that WebSphere MQ applications specify in the TransactionId field in the MQCIH structure in request messages.
- If WebSphere MQ applications are specifying user IDs in request messages, the user ID under which the bridge monitor transaction is started must be defined to RACF as a surrogate of all the user IDs used in request messages. A surrogate user is one that has the authority to start work on behalf of another user, without knowing the password of the other user. For more information about surrogate user security, see [Surrogate user security](#).
- The user IDs for the bridge monitor and for all bridge tasks need authority to get messages from the request queue.
- The user IDs for a bridge task need authority to put messages to its reply-to queue.
- To ensure that any error replies are received, the user ID under which the bridge monitor transaction is started must have authority to put messages to all reply-to queues.
- The user IDs for bridge tasks must have authority to put messages to the dead-letter queue.
- The user ID under which the bridge monitor transaction is started needs authority to put messages to the dead-letter queue, unless you want the bridge to stop if an error occurs.
- The user IDs for the bridge monitor and for all bridge tasks must have authority to put messages to the backout requeue queue, if one is defined.

Chapter 16. Kerberos support

CICS Transaction Server for z/OS provides support for Kerberos.

CICS supports Kerberos using the external security manager (ESM). The level of support depends on the support provided by the ESM. If your ESM is RACF, support is based on Kerberos Version 5 and Generic Security Services (GSS).

CICS can verify a Kerberos token by configuring a service provider pipeline or by using the API command **VERIFY TOKEN**.

Configuring RACF for Kerberos

You must configure an external security manager, such as RACF, to enable support for Kerberos.

Note: These instructions apply only to the use of local principals.

Before you begin

- You must set up a Kerberos environment for z/OS Security Server RACF by using the z/OS Integrated Security Services Network Authentication Service. For information about RACF, Kerberos and z/OS Integrated Security Services Network Authentication Service, see [RACF and z/OS Integrated Security Services Network Authentication Service](#).
- The configuration `/etc/skrb/krb5.conf` defines the local realm for the LPAR or sysplex.
- The SKRBKDC started task must be running. For more information, see [Setting up a Kerberos Key Distribution Center in z/OS Network File System Guide and Reference](#).

Procedure

1. Enable RACF protection for Kerberos. Activate RACF protection for the KERBLINK class by using the RACF **SETOPTS** command:

```
SETOPTS CLASSACT(KERBLINK)
```

For more information about the **SETOPTS** command, see [z/OS Security Server RACF Command Language Reference](#).

2. To set up a CICS region to use Kerberos, define a service principal name and associate it with a user ID by using the **ALTUSER** command:

```
ALTUSER user_id KERB(KERBNAME(service_principal))
```

If you have specified a Kerberos user ID in the [KERBEROSUSER](#) system initialization parameter, the user ID that you specify in the command is the Kerberos user ID; otherwise, the user ID is the CICS region user ID.

3. Associate a RACF user ID with the client principal by using the **ALTUSER** command:

```
ALTUSER userid PASSWORD(password) NOEXPIRED KERB(KERBNAME(client_principal))
```

Alternatively, you can associate a default user ID with all unassociated principals by using a command as follows:

```
RDEFINE KERBLINK /.../realm APPLDATA('userid')
```

where *userid* is the local user ID to be associated with all unmapped principals for the realm *realm*.

4. In order for this to be activated, a Kerberos key must be created. This is done automatically when the user next changes their password.

Configuring CICS web services for Kerberos

To configure a provider pipeline to implement Kerberos authentication, you must add a security handler to your pipeline configuration file.

Before you begin

You must configure an external security manager, such as RACF, to enable support for Kerberos. For more information, see [Configuring RACF for Kerberos](#).

You must identify or create the pipeline configuration file to add the configuration information for Kerberos.

Procedure

1. Add a `<wsse_handler>` element to your pipeline. The handler must be included in the `<service_handler_list>` element. Code the following elements:

```
<wsse_handler>
  <dfhwsse_configuration version="1">
  </dfhwsse_configuration>
</wsse_handler>
```

The `<dfhwsse_configuration>` element is a container for the other elements in the configuration.

2. Code an `<authentication>` element.
 - a) Code the **trust** attribute to specify `trust="basic"`.
 - b) Code the **mode** attribute to specify `mode="basic-kerberos"`.
 - c) Optional: Code an empty `<suppress/>` element.

If you do not specify this element, the work runs under the user ID associated with the token.

Results

The CICS provider pipeline is configured for Kerberos authentication. Inbound web service requests received by the pipeline must include a valid Kerberos token. If they do not, the request is rejected with the appropriate SOAP fault. Depending on pipeline configuration options, the target application runs under the user ID associated with the token.

Example

The following example shows how you might configure the provider pipeline:

```
<provider_pipeline xmlns="http://www.ibm.com/software/htp/cics/pipeline">
  <service>
    <service_handler_list>
      <wsse_handler>
        <dfhwsse_configuration version="1">
          <authentication trust="basic" mode="basic-kerberos"/>
        </dfhwsse_configuration>
      </wsse_handler>
    </service_handler_list>
    <terminal_handler>
      <cics_soap_1.1_handler/>
    </terminal_handler>
  </service>
  <apphandler>DFHPITP</apphandler>
</provider_pipeline>
```

Developing Kerberos applications

You can write a custom security handler to verify a Kerberos token, or you can write your own application to verify the token.

Before you begin

In the following steps, you can extract the RACF user ID of the Kerberos principal, by using the ISUSERID option of the **EXEC CICS VERIFY TOKEN** command. To do this, you must first define an association between the user ID and the principal. Use the RACF **RACLINK** command to set up the association. For more information, see [Defining User ID Associations in z/OS Security Server RACF Security Administrator's Guide](#).

Procedure

Use one of the following techniques, according to your requirements:

- Write a security handler that uses the **VERIFY TOKEN** command, as described in [Writing a custom security handler](#). If you want to run under the user ID of the Kerberos principal that is associated with the token, use the ISUSERID option of the **VERIFY TOKEN** command.
- Write your own front-end security program. Such a program might extract the Kerberos token from an HTTP header or an IBM MQ message and then issue the **VERIFY TOKEN** command. If you want to run under the user ID of the Kerberos principal that is associated with the token, use the ISUSERID option of the **VERIFY TOKEN** command to obtain the user ID. The new request can then be started with that user ID.

Using a Kerberos security token in a 3270 emulator sign-on

The use of Kerberos provides stronger security because passwords are not required to flow over the network.

The process is described as follows:

1. The Client terminal emulator applies to a Kerberos authentication server to obtain a Kerberos token.
2. The Kerberos token is returned to the Client terminal emulator, and the content is encoded in Base64 format.
3. The token is then forwarded in a message to the CICS server, where a sign-on transaction receives the Base64 encoded Kerberos token and issues the **SIGNON TOKEN** command.
4. The RACF Kerberos registry validates the Kerberos token and returns the associated RACF USERID to CICS. This USERID is associated with the terminal session for subsequent tasks.

Example interaction:

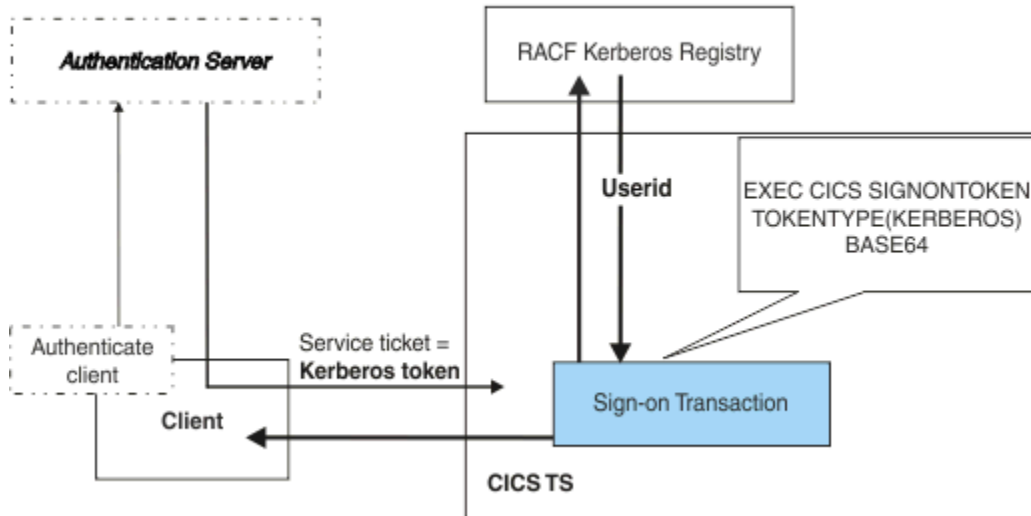

Figure 32. Flow of requests between the Client terminal emulator, the authentication server, and CICS TS

Note: Logon data cannot be used to send the Kerberos token since it is limited to 255 characters.

Chapter 17. Support for Multi-Factor Authentication using RACF

CICS Transaction Server for z/OS provides support for Multi-Factor Authentication (MFA) using RACF.

If you are an RACF user, see [Multi-Factor Authentication for z/OS in z/OS Security Server RACF Security Administrator's Guide](#) for an overview of MFA and the prerequisite for this feature.

If you are using other security products, see the documentation of your ESM for details of support and prerequisites.

The following information shows how to implement MFA in CICS, based on the example of RACF and IBM Multi-Factor Authentication for z/OS.

CICS supports in-band MFA tokens. If you use z/OS Out-of-Band authentication, a one-time-use token can be generated and is supported by CICS.

MFA tokens are supported on the following session-based logon interfaces:

Interface	CICS level requirement
CICS Explorer®	CICS TS V5.4 with APAR PI87691 or later
CESN and CESL	<ul style="list-style-type: none">• CICS TS V4.2 with APAR PI21865• CICS TS V5.1 with APAR PI21866• CICS TS V5.2 with APAR PI21866• CICS TS V5.3 or later
CPSM WUI	
User-written sign-on programs using EXEC CICS SIGNON	

MFA tokens are not supported on stateless requests that cache credentials.

Depending on the length, MFA tokens should be entered in the phase or password fields.

For more information, see [IBM Multi-Factor Authentication for z/OS User's Guide](#).

Chapter 18. Configuring CICS for SAML

To configure CICS to use SAML, first configure the JVM server by customizing and installing the sample JVM server profile, then install the CSD group in the appropriate CICS regions.

Before you begin

You must identify the regions where you want to deploy the CICS Security Token Service (STS). Install the STS in regions without any application code. If you have application code in the region where you will be validating your SAML token, define the STS remotely. You might also choose to define the region remotely if you prefer to separate regions that run Java code from other regions. Another reason for having a separate region for the STS is that you could define that region with its own keyring, which contains only those certificates that are required for signature validation and signing SAML tokens.

About this task

CICS provides a linkable interface called DFHSAML. The interface allows CICS web services pipelines and applications to validate and extract information from SAML assertions. CICS support for SAML requires a JVM server that is installed and configured on your system.

Procedure

1. Create a JVM server profile for the JVM server.

You can copy the appropriate supplied profile, DFHJVMST, from the installation directory to the directory that is specified by the **JVMPROFILEDIR** system initialization parameter.

2. Install CSD group DFHSAML in the chosen configuration:

- a) Install DFHSAML in the region that is chosen to run the STS.
- b) If you want to use SAML remotely, define a remote program definition for DFHSAML pointing to the region that runs the STS.

Note: If you are using your own JVM server definition, copy DFHSAML, customize this group, and install the customized group instead of the DFHSAML group. The new group must point to your own JVM server definition. All programs that call the security token extensions support must create DFHSAML JVMSERVER containers with the name of their JVM server.

Results

CICS is configured for SAML.

What to do next

You can validate your configuration, as described in [“Validating your configuration of CICS for SAML” on page 421](#).

Validating your configuration of CICS for SAML

A sample is provided, which you can use to verify that CICS is configured correctly for SAML. Two programs are provided, which can be compiled and then invoked through a transaction.

Before you begin

You must configure your JVM server, as described in [Chapter 18, “Configuring CICS for SAML,” on page 421](#).

About this task

A sample is provided in CSD group DFH\$SAML, which contains a program definition for sample programs, a transaction, and a template. You can use this sample to validate your configuration. When you compile and deploy the sample application, it provides an example SAML token assertion to be processed by the CICS security token extensions. The application is started by a CICS transaction.

Procedure

1. Optional: If you customized and installed a JVM server with a name other than DFHXSTS, update program DFH0XST2 to reflect the new server name.
2. Compile the programs DFH0XST1 and DFH0XST2, which are in the samples library, SDFHSAMP. For information about compiling COBOL programs, see [Batch compilation for COBOL programs](#).
3. Install the group DFH\$SAML in a region that calls the DFHSAML program.
4. Run transaction XST1.

Results

If the sample transaction XST1 runs successfully, SAML support is configured correctly.

The sample outputs the parsed containers into TSQ DFH0XSTO.

To look at these containers use **CEBR DFH0XSTO**.

If the installation validation is not successful, the DFHSAML-RESPONSE container contains a return code that indicates the reason. For more information about container response codes, see [SAML support containers](#).

If an abend code is returned read the sample for further information.

What to do next

- You can replace the sample SAML token with your own. Create and install a DOCTEMPLATE resource definition that names the file that contains your SAML token. Specify this DOCTEMPLATE 48-byte TEMPLATENAME after the transaction identifier when you run the sample:

```
XST1 templatename
```

If no *templatename* is specified, the default TEMPLATENAME of DFH0XSTI is used.

- If you want to use signature validation, update program DFH0XST2. For more information, see the comments within that program.

Configuring a provider pipeline to use SAML tokens

Configure a provider pipeline that enables the validation and extraction of SAML token assertions and make them available to the CICS application.

Before you begin

If you are adding SAML support to an existing pipeline, identify the pipeline configuration file. If you are creating a new pipeline, create a new pipeline configuration file. CICS provides two sample configuration files, `samlprovider.xml` and `propagatesamlprovider.xml`. The latter contains the **tran_channel** attribute.

Procedure

1. Code an `<sts_authentication>` element in your pipeline configuration file.
This element specifies that a Security Token Service (STS) is used for authentication and determines the type of request that is sent. Do not code an `<authentication>` element.
 - a) Code the **action="validate"** attribute to specify that the STS verifies a security token.

If you do not specify this attribute, CICS assumes that the action is to request an identity token.

- b) Optional: Code the **token_signature="ignored"** attribute to specify that CICS ignores the signature.

If you do not specify this attribute, the default value is `required`, which means that a valid signature must be supplied.

- c) Optional: Code the **extract="no"** attribute to specify that the elements of the SAML token are not put into containers.

If you do not specify this attribute, the default value is `yes`, which means that CICS creates containers with the main elements of the SAML token. For full details of these containers, see [SAML support containers](#).

- d) Optional: Code the **tran_channel="yes"** attribute to specify that the SAML assertions are copied into containers in the DFHTRANSACTION channel to allow propagation of SAML information through a CICS application.

If you do not specify this attribute, the default value is `no`, which means that the assertions are made available in containers in the channel that is passed from the pipeline.

- e) Within the `<sts_authentication>` element, code an `<auth_token_type>` element.

Within the `<auth_token_type>` element, code the following elements:

<namespace>

Set the content of this element to either `urn:oasis:names:tc:SAML:1.0:assertion` or `urn:oasis:names:tc:SAML:2.0:assertion`, depending on the version of SAML you are using.

<element>

Set the content of this element to `Assertion`.

2. Code an `<sts_endpoint>` element.

- a) In the `<sts_endpoint>` element, code an `<endpoint>` element.

This element contains a URI that points to the location of the Security Token Service (STS) on the network.

To use the CICS Security Token Service to process SAML tokens, set the endpoint to `cics://PROGRAM/DFHSAML`.

The CICS Security Token Service is called by the security handler. If **extract="yes"** is configured in the `<sts_authentication>` element, containers prefixed with "DFHSAML" are copied to the pipeline channel and are therefore available to later pipeline handlers and the target application.

- b) Optional: In the `<sts_endpoint>` element, code a `<jvmserver>` element.

This element identifies the server on which to run. If this element is not included, the default sample resource JVM server DFHXSTS is assumed.

Example

```
<?xml version="1.0" encoding="EBCDIC-CP-US"?>
<provider_pipeline xmlns="http://www.ibm.com/software/htp/cics/pipeline">
  <service>
    <service_handler_list>
      <wsse_handler>
        <dfhwsse_configuration version="1">
          <sts_authentication action="validate" token_signature="required"
            extract="yes" tran_channel="yes">
            <auth_token_type>
              <namespace>urn:oasis:names:tc:SAML:2.0:assertion</namespace>
              <element>Assertion</element>
            </auth_token_type>
          </sts_authentication>
          <sts_endpoint>
            <endpoint>cics://PROGRAM/DFHSAML</endpoint>
            <jvmserver>DFHXSTS</jvmserver>
          </sts_endpoint>
        </dfhwsse_configuration>
      </wsse_handler>
    </service_handler_list>
```

```

    <terminal_handler>
      <cics_soap_1.1_handler/>
    </terminal_handler>
  </service>
  <apphandler>DFHPITP</apphandler>
</provider_pipeline>

```

Configuring a requester pipeline to use SAML tokens

Configure a requester pipeline to insert SAML tokens in the SOAP header of outbound messages.

Before you begin

If you are adding SAML support to an existing pipeline, identify the pipeline configuration file. If you are creating a new pipeline, create a new pipeline configuration file. CICS provides two sample configuration files, `samlrequester.xml` and `propagatesamlrequester.xml`. The latter contains the **tran_channel** attribute.

About this task

In this task, you configure a requester pipeline to automatically attach SAML tokens to the outbound SOAP messages. CICS allows only previously validated tokens to be sent out in a SOAP message. The validated token is stored in the DFHSAML-OUTTOKEN container and the token inserted in the SOAP header is taken from this container.

Procedure

1. Code an `<sts_authentication>` element in your pipeline configuration file.

This element specifies that a Security Token Service (STS) is used for authentication and determines the type of request that is sent. Do not code an `<authentication>` element.

- a) Optional: Code the **tran_channel="yes"** attribute to specify that the contents of the DFHTRANSACTION channel's DFHSAML-OUTTOKEN container are used as the SAML token for the request.

If you do not specify this attribute, the default value is no, which means that the SAML token is taken from the DFHSAML-OUTTOKEN container in the channel that is passed to the SOAP pipeline.

- b) Within the `<sts_authentication>` element, code an `<auth_token_type>` element.

Within the `<auth_token_type>` element, code the following elements:

<namespace>

Set the content of this element to either `urn:oasis:names:tc:SAML:1.0:assertion` or `urn:oasis:names:tc:SAML:2.0:assertion`, depending on the version of SAML you are using.

<element>

Set the content of this element to Assertion.

2. Code an `<sts_endpoint>` element.

- a) In the `<sts_endpoint>` element, code an `<endpoint>` element.

Set the value of the endpoint to `cics://PROGRAM/DFHSAML`.

- b) Optional: In the `<sts_endpoint>` element, code a `<jvmserver>` element.

This element identifies the server on which to run. If this element is not included, the default sample resource JVM server DFHXSTS is assumed.

Example

```

<?xml version="1.0" encoding="EBCDIC-CP-US"?>
<requester_pipeline xmlns="http://www.ibm.com/software/hcp/cics/pipeline">
  <service>
    <service_handler_list>
      <cics_soap_1.1_handler/>
      <wsse_handler>

```

```

    <dfhwsse_configuration version="1">
      <sts_authentication tran_channel="yes">
        <auth_token_type>
          <namespace>urn:oasis:names:tc:SAML:2.0:assertion</namespace>
          <element>Assertion</element>
        </auth_token_type>
      </sts_authentication>
      <sts_endpoint>
        <endpoint>cics://PROGRAM/DFHSAML</endpoint>
        <jvmserver>DFHXSTS</jvmserver>
      </sts_endpoint>
    </dfhwsse_configuration>
  </wsse_handler>
</service_handler_list>
</service>
<service_parameter_list/>
</requester_pipeline>

```

Configuring the CICS Security Token Service

To control the behavior of the CICS STS, update your STS configuration file and perhaps your `java.policy` file and system initialization parameters.

About this task

CICS uses a file referred to as the *STS configuration file* to control the behavior of the CICS STS. By default, CICS uses a file called `sts.xml` in the directory that is identified by the **JVMPROFILEDIR** SIT parameter. If that file does not exist, CICS uses the file specified by the JVM property **com.ibm.cics.sts.config** in the JVM server profile. For example: `-Dcom.ibm.cics.sts.config=/var/security/sts/sts-config.xml`. A sample file `sts-config.xml` is provided.

Procedure

1. Update the STS configuration file according to your requirements.
 - a) If you want to update the issuer of the SAML token when you add attributes to the token, specify an *issuer*.
 - i) Code an `<issuer>` element in your STS configuration file.
 - ii) Within the `<issuer>` element, code a `<format>` element.
 - iii) Within the `<issuer>` element, code a `<uri>` element.
 - b) To allow for any time difference in system clocks on different computers, you can specify a tolerance value or *clock skew*.

If you find that SAML tokens are regularly being rejected as expired, or as not yet valid, it might be caused by a discrepancy in clock time between the issuing and receiving systems. Setting a skew time can prevent SAML tokens from appearing to arrive before they are issued, or arriving already expired when they have, in reality, recently been issued. However, if you set too large a value, you might accept tokens that have genuinely expired.

 - i) Code a `<clock_skew>` element in your STS configuration file. The value is set in milliseconds, so to set a time of 90 seconds, code `<clock_skew>90000</clock_skew>`.
 - c) If you intend to re-sign a SAML token, specify the certificate label.
 - i) Code a `<signature>` element in your STS configuration file. Set the `hash_algorithm` attribute to `sha-1` or `sha-2` according to the hash algorithm you want to use.

Note: The hash algorithm `sha-3` is not supported.
 - ii) Optional: Within the `<signature>` element, code a `<certificate>` element.
 - iii) Optional: Within the `<certificate>` element, code a `<label>` element. Set it to the value of the RACF certificate label.
 - d) If you intend to verify signatures or to re-sign SAML tokens, you can specify the keystore type.

- i) Code a <keystore> element in the STS configuration file.
 - ii) Within the <keystore> element, code a <type> element. If you want to use cryptographic hardware to validate signatures, give it the value JCECCARACFKS. Otherwise, use the value JCERACFKS, which is the default value.
2. Optional: If you intend to verify signatures or to re-sign SAML tokens, update the `java.policy` file and set the **KEYRING** SIT parameter.
- a) Update the `java.policy` file to give the CICS user permission to alter the list of Java security providers.

A sample file, `sts-java.policy`, is provided.

- i) To use the sample file, edit it to change `&USSHOME/` to the appropriate value for your installation, and set the JVM property **java.security.policy** in the JVM server profile to specify its path and file name.
- ii) If you use an existing `java.policy` file, update it to include the following rule:

```
// All permissions granted to CICS codesource protection domain
grant codeBase "file:///&USSHOME///-" {
  permission java.security.AllPermission;
};
```

where *USSHOME* is the name and path of the root directory for CICS Transaction Server files on z/OS UNIX.

- b) Set the SIT parameter **KEYRING** to specify the RACF keyring that contains the set of certificates you want to use.

The STS configuration file

The STS configuration file specifies various aspects of the CICS Security Token Service (STS).

CICS uses a file called `sts.xml` in the directory that is identified by the **JVMPROFILEDIR** SIT parameter. If that file does not exist, CICS uses the file that is specified by the JVM property **com.ibm.cics.sts.config** in the JVM server profile. For example: `-Dcom.ibm.cics.sts.config=/var/security/sts/sts-config.xml`. A sample STS configuration file, `sts-config.xml`, is supplied for reference.

The XML schema file, `sts.xsd`, is supplied in the `/usr/lpp/cicsts/cicsts52/schemas/sts` directory.

The STS configuration file contains the following elements:

<keystore>

Defines the RACF keystore type. The possible values are JCERACFKS and JCECCARACFKS. The default value is JCERACFKS.

<issuer>

Defines the STS as an asserting party. This element contains the following elements:

<format>

Contains any string. There is no default value.

<uri>

Contains any string. The default value is `http://cics`.

<signature>

Specifies the hash algorithm and the certificate label. This element has the following attribute:

hash_algorithm

Possible values are `sha-1` and `sha-2`. The default value is `sha-2`.

This element contains the following element:

<certificate>

This element contains the following element:

<label>

The value of the RACF certificate label. The default value is CICSCERT.

<clock_skew>

The clock skew time, in milliseconds. The default value is 180000 ms (3 minutes).

A clock skew allows for any time difference in system clocks on different computers. It is applied to all timing conditions in a SAML token.

The following figure shows an example of an STS configuration file with all elements set:

```
<sts_configuration xmlns="http://www.ibm.com/xmlns/prod/cics/JVMSEVER/stsconfig">
  <keystore>
    <type>JCECCARACFKS</type>
  </keystore>
  <issuer>
    <format>urn:oasis:names:tc:SAML:2.0:nameid-format:entity</format>
    <uri>http://cics</uri>
  </issuer>
  <signature hash_algorithm="sha-1">
    <certificate>
      <label>CICSCERT</label>
    </certificate>
  </signature>
  <clock_skew>90000</clock_skew>
</sts_configuration>
```

Patterns for developing SAML-aware programs

SAML aware programs might conform to common patterns. One such pattern is an initial program that controls access to parts of the application. Another is logging information about the user.

Pattern: reusing a validated token

You might want to validate a SAML token and later in the same transaction call a web service from a requester program and use the same token. A validated SAML token is held in the DFHSAML-OUTTOKEN container. As this container is read-only, it cannot be moved between channels. To avoid having to reissue the validation request, and thus to improve performance, you can use the transaction channel, DFHTRANSACTION.

When you validate a SAML token from an incoming web service, code the **tran_channel="yes"** attribute in the <sts_authentication> element in the configuration file for your provider pipeline. This attribute specifies that the SAML assertions are copied from the output containers into containers in the DFHTRANSACTION channel.

To reuse the validated SAML token in a web service, code the **tran_channel="yes"** attribute in the <sts_authentication> element in the configuration file for the requester pipeline that is used by the web service.

Notices

This information was developed for products and services offered in the United States of America. This material might be available from IBM in other languages. However, you may be required to own a copy of the product or product version in that language in order to access it.

IBM may not offer the products, services, or features discussed in this document in other countries. Consult your local IBM representative for information on the products and services currently available in your area. Any reference to an IBM product, program, or service is not intended to state or imply that only that IBM product, program, or service may be used. Any functionally equivalent product, program, or service that does not infringe any IBM intellectual property rights may be used instead. However, it is the user's responsibility to evaluate and verify the operation of any non-IBM product, program, or service.

IBM may have patents or pending patent applications covering subject matter described in this document. The furnishing of this document does not grant you any license to these patents. You can send license inquiries, in writing, to:

*IBM Director of Licensing
IBM Corporation
North Castle Drive, MD-NC119
Armonk, NY 10504-1785
United States of America*

For license inquiries regarding double-byte character set (DBCS) information, contact the IBM Intellectual Property Department in your country or send inquiries, in writing, to:

*Intellectual Property Licensing
Legal and Intellectual Property Law
IBM Japan Ltd.
19-21, Nihonbashi-Hakozakicho, Chuo-ku
Tokyo 103-8510, Japan*

INTERNATIONAL BUSINESS MACHINES CORPORATION PROVIDES THIS PUBLICATION "AS IS" WITHOUT WARRANTY OF ANY KIND, EITHER EXPRESS OR IMPLIED, INCLUDING, BUT NOT LIMITED TO, THE IMPLIED WARRANTIES OF NON-INFRINGEMENT, MERCHANTABILITY, OR FITNESS FOR A PARTICULAR PURPOSE. Some jurisdictions do not allow disclaimer of express or implied warranties in certain transactions, therefore this statement may not apply to you.

This information could include technical inaccuracies or typographical errors. Changes are periodically made to the information herein; these changes will be incorporated in new editions of the publication. IBM may make improvements and/or changes in the product(s) and/or the program(s) described in this publication at any time without notice.

Any references in this information to non-IBM websites are provided for convenience only and do not in any manner serve as an endorsement of those websites. The materials at those websites are not part of the materials for this IBM product and use of those websites is at your own risk.

IBM may use or distribute any of the information you supply in any way it believes appropriate without incurring any obligation to you.

Licensees of this program who want to have information about it for the purpose of enabling: (i) the exchange of information between independently created programs and other programs (including this one) and (ii) the mutual use of the information which has been exchanged, should contact

*IBM Director of Licensing
IBM Corporation
North Castle Drive, MD-NC119 Armonk,
NY 10504-1785
United States of America*

Such information may be available, subject to appropriate terms and conditions, including in some cases, payment of a fee.

The licensed program described in this document and all licensed material available for it are provided by IBM under terms of the IBM Client Relationship Agreement, IBM International Programming License Agreement, or any equivalent agreement between us.

The performance data discussed herein is presented as derived under specific operating conditions. Actual results may vary.

Information concerning non-IBM products was obtained from the suppliers of those products, their published announcements or other publicly available sources. IBM has not tested those products and cannot confirm the accuracy of performance, compatibility or any other claims related to non-IBM products. Questions on the capabilities of non-IBM products should be addressed to the suppliers of those products.

This information contains examples of data and reports used in daily business operations. To illustrate them as completely as possible, the examples include the names of individuals, companies, brands, and products. All of these names are fictitious and any similarity to actual people or business enterprises is entirely coincidental.

COPYRIGHT LICENSE:

This information contains sample application programs in source language, which illustrate programming techniques on various operating platforms. You may copy, modify, and distribute these sample programs in any form without payment to IBM, for the purposes of developing, using, marketing or distributing application programs conforming to the application programming interface for the operating platform for which the sample programs are written. These examples have not been thoroughly tested under all conditions. IBM, therefore, cannot guarantee or imply reliability, serviceability, or function of these programs. The sample programs are provided "AS IS", without warranty of any kind. IBM shall not be liable for any damages arising out of your use of the sample programs.

Programming interface information

IBM CICS supplies some documentation that can be considered to be Programming Interfaces, and some documentation that cannot be considered to be a Programming Interface.

Programming Interfaces that allow the customer to write programs to obtain the services of CICS Transaction Server for z/OS, Version 5 Release 4 (CICS TS 5.4) are included in the following sections of the online product documentation:

- [Developing applications](#)
- [Developing system programs](#)
- [Securing overview](#)
- [Developing for external interfaces](#)
- [Application development reference](#)
- [Reference: system programming](#)
- [Reference: connectivity](#)

Information that is NOT intended to be used as a Programming Interface of CICS TS 5.4, but that might be misconstrued as Programming Interfaces, is included in the following sections of the online product documentation:

- [Troubleshooting and support](#)
- [Reference: diagnostics](#)

If you access the CICS documentation in manuals in PDF format, Programming Interfaces that allow the customer to write programs to obtain the services of CICS TS 5.4 are included in the following manuals:

- Application Programming Guide and Application Programming Reference
- Business Transaction Services

- Customization Guide
- C++ OO Class Libraries
- Debugging Tools Interfaces Reference
- Distributed Transaction Programming Guide
- External Interfaces Guide
- Front End Programming Interface Guide
- IMS Database Control Guide
- Installation Guide
- Security Guide
- CICS Transactions
- CICSplex System Manager (CICSplex SM) Managing Workloads
- CICSplex SM Managing Resource Usage
- CICSplex SM Application Programming Guide and Application Programming Reference
- Java Applications in CICS

If you access the CICS documentation in manuals in PDF format, information that is NOT intended to be used as a Programming Interface of CICS TS 5.4, but that might be misconstrued as Programming Interfaces, is included in the following manuals:

- Data Areas
- Diagnosis Reference
- Problem Determination Guide
- CICSplex SM Problem Determination Guide

Trademarks

IBM, the IBM logo, and [ibm.com](http://www.ibm.com)[®] are trademarks or registered trademarks of International Business Machines Corp., registered in many jurisdictions worldwide. Other product and service names might be trademarks of IBM or other companies. A current list of IBM trademarks is available on the Web at [Copyright and trademark information at www.ibm.com/legal/copytrade.shtml](http://www.ibm.com/legal/copytrade.shtml).

Adobe, the Adobe logo, PostScript, and the PostScript logo are either registered trademarks or trademarks of Adobe Systems Incorporated in the United States, and/or other countries.

Apache, Apache Axis2, Apache Maven, Apache Ivy, the Apache Software Foundation (ASF) logo, and the ASF feather logo are trademarks of Apache Software Foundation.

Gradle and the Gradlephant logo are registered trademark of Gradle, Inc. and its subsidiaries in the United States and/or other countries.

Intel, Intel logo, Intel Inside, Intel Inside logo, Intel Centrino, Intel Centrino logo, Celeron, Intel Xeon, Intel SpeedStep, Itanium, and Pentium are trademarks or registered trademarks of Intel Corporation or its subsidiaries in the United States and other countries.

Java and all Java-based trademarks and logos are trademarks or registered trademarks of Oracle and/or its affiliates.

The registered trademark Linux[®] is used pursuant to a sublicense from the Linux Foundation, the exclusive licensee of Linus Torvalds, owner of the mark on a worldwide basis.

Microsoft, Windows, Windows NT, and the Windows logo are trademarks of Microsoft Corporation in the United States, other countries, or both.

Red Hat[®], and Hibernate[®] are trademarks or registered trademarks of Red Hat, Inc. or its subsidiaries in the United States and other countries.

Spring Boot is a trademark of Pivotal Software, Inc. in the United States and other countries.

UNIX is a registered trademark of The Open Group in the United States and other countries.

Zowe™, the Zowe logo and the Open Mainframe Project™ are trademarks of The Linux Foundation.

The Stack Exchange name and logos are trademarks of Stack Exchange Inc.

Terms and conditions for product documentation

Permissions for the use of these publications are granted subject to the following terms and conditions.

Applicability

These terms and conditions are in addition to any terms of use for the IBM website.

Personal use

You may reproduce these publications for your personal, noncommercial use provided that all proprietary notices are preserved. You may not distribute, display or make derivative work of these publications, or any portion thereof, without the express consent of IBM.

Commercial use

You may reproduce, distribute and display these publications solely within your enterprise provided that all proprietary notices are preserved. You may not make derivative works of these publications, or reproduce, distribute or display these publications or any portion thereof outside your enterprise, without the express consent of IBM.

Rights

Except as expressly granted in this permission, no other permissions, licenses or rights are granted, either express or implied, to the publications or any information, data, software or other intellectual property contained therein.

IBM reserves the right to withdraw the permissions granted herein whenever, in its discretion, the use of the publications is detrimental to its interest or, as determined by IBM, the above instructions are not being properly followed.

You may not download, export or re-export this information except in full compliance with all applicable laws and regulations, including all United States export laws and regulations.

IBM MAKES NO GUARANTEE ABOUT THE CONTENT OF THESE PUBLICATIONS. THE PUBLICATIONS ARE PROVIDED "AS-IS" AND WITHOUT WARRANTY OF ANY KIND, EITHER EXPRESSED OR IMPLIED, INCLUDING BUT NOT LIMITED TO IMPLIED WARRANTIES OF MERCHANTABILITY, NON-INFRINGEMENT, AND FITNESS FOR A PARTICULAR PURPOSE.

IBM online privacy statement

IBM Software products, including software as a service solutions, (*Software Offerings*) may use cookies or other technologies to collect product usage information, to help improve the end user experience, to tailor interactions with the end user or for other purposes. In many cases no personally identifiable information (PII) is collected by the Software Offerings. Some of our Software Offerings can help enable you to collect PII. If this Software Offering uses cookies to collect PII, specific information about this offering's use of cookies is set forth below:

For the CICSplex SM Web User Interface (main interface):

Depending upon the configurations deployed, this Software Offering may use session and persistent cookies that collect each user's user name and other PII for purposes of session management, authentication, enhanced user usability, or other usage tracking or functional purposes. These cookies cannot be disabled.

For the CICSplex SM Web User Interface (data interface):

Depending upon the configurations deployed, this Software Offering may use session cookies that collect each user's user name and other PII for purposes of session management, authentication, or other usage tracking or functional purposes. These cookies cannot be disabled.

For the CICSplex SM Web User Interface ("hello world" page):

Depending upon the configurations deployed, this Software Offering may use session cookies that do not collect PII. These cookies cannot be disabled.

For CICS Explorer:

Depending upon the configurations deployed, this Software Offering may use session and persistent preferences that collect each user's user name and password, for purposes of session management, authentication, and single sign-on configuration. These preferences cannot be disabled, although storing a user's password on disk in encrypted form can only be enabled by the user's explicit action to check a check box during sign-on.

If the configurations deployed for this Software Offering provide you, as customer, the ability to collect PII from end users via cookies and other technologies, you should seek your own legal advice about any laws applicable to such data collection, including any requirements for notice and consent.

For more information about the use of various technologies, including cookies, for these purposes, see [IBM Privacy Policy](#) and [IBM Online Privacy Statement](#), the section entitled *Cookies, Web Beacons and Other Technologies* and the [IBM Software Products and Software-as-a-Service Privacy Statement](#).

Index

Special Characters

- ESM interface
 - overview [214](#)
 - RACROUTE macros [214](#)
- * [17](#)
- ** (double asterisk)
 - in data set profile names [17](#)
- % [17](#)

A

- access authorization levels [80, 90](#)
- access control
 - HFS files [88](#)
 - z/OS UNIX files [87](#)
- access lists
 - avoiding with UACC(READ) [68](#)
 - conditional, for transaction profiles [69](#)
 - PERMIT command to create [24](#)
- accounting [324](#)
- ACICSPCT general resource class [81, 84](#)
- activating RACF classes [25](#)
- activating security parameters [209](#)
- activating user-defined RACF classes [138](#)
- activities
 - security of [405, 406](#)
- ADDMEM operand [315](#)
- ADDUSER command
 - defining the userid for CICS to RACF [32](#)
- administration
 - security [405](#)
- Advanced Encryption Standard
 - encryption algorithm [290](#)
- algorithm [390, 392](#)
- algorithms
 - encryption [290](#)
- ALLOCATE_PIPE command
 - security check failure [333](#)
- APPC PEM (password expiration management)
 - APPC PEM (password expiration management) [241](#)
 - ATTACH security fields [250](#)
 - benefits [242](#)
 - buffer size [250](#)
 - CICS activity [245](#)
 - data from CICS to PEM client [252](#)
 - EBCDIC for userids and passwords [249](#)
 - information on passwords [241](#)
 - overview of processing [245](#)
 - permitted userid and password length [250](#)
 - processing done by CICS PEM server [245](#)
 - processing required by PEM client [245](#)
 - PROFILE option [250](#)
 - sample configuration [242](#)
 - setting up the PEM client [249](#)
 - sign-on data sent to CICS PEM server [251](#)
 - APPC PEM (password expiration management) (*continued*)
 - sign-on input data sent by PEM client [251](#)
 - sign-on request, formatting errors [254](#)
 - sign-on status [242](#)
 - unsuccessful sign-on with PV [248](#)
 - using with persistent verification (PV) [245](#)
- APPCLU general resource class
 - defining profiles [223](#)
- APPL general resource class
 - controlling access to CICS region [43](#)
- application
 - security [178, 204](#)
- application program security
 - access authorization levels [86](#)
 - defining resource classes [85](#)
 - MCICSPPT general resource class [85](#)
 - NCICSPPT general resource class [85](#)
 - QUERY SECURITY command [5, 130](#)
- applying a security policy [361](#)
- AT-TLS
 - Application Transparent Transport Layer Security [372, 376, 377](#)
 - PROTOCOL(HTTP) [372, 376, 377](#)
 - SSL(ATTLSAWARE) [372, 376, 377](#)
 - SSL(NO) [372, 376, 377](#)
- AT-TLS Basic [372](#)
- AT-TLS Controlling [372](#)
- Atom collection
 - security [382](#)
- Atom feed
 - security [382](#)
- attach-time security [406](#)
- ATTACHSEC attribute [269](#)
- ATTACHSEC operand
 - IDENTIFY parameter [229](#)
 - LOCAL parameter [229](#)
 - MIXIDPE parameter [229](#)
 - PERSISTENT parameter [229](#)
 - VERIFY parameter [229](#)
- ATTLS [376, 377](#)
- ATTLS Aware [376, 377](#)
- ATTLS Basic [376, 377](#)
- ATTLS Controlling [376, 377](#)
- ATTLSAWARE [372](#)
- auditing
 - bind security failure [225](#)
 - requested by CICS on authorization requests [77](#)
 - second request to RACF to write log data [69](#)
 - SMF type 80 log records [69](#)
- AUTHENTICATE(AUTOREGISTER) [377](#)
- AUTHENTICATE(CERTIFICATE) [377](#)
- authentication [363–365](#)
- authentication, RPC [335](#)
- AUTHID
 - surrogate security [116](#)
- authorization failures
 - CICS resources [76](#)

- authorization failures (*continued*)
 - command security [129](#)
 - error messages [69](#)
 - ICH408I, RACF message [69](#)
- authorization IDs, primary [323](#)
- authorization IDs, secondary [325](#)
- authorizing CICS region userid as surrogate user [45](#)
- authorizing CICS users to RACF [64](#)
- authorizing SYS1.PARMLIB libraries
 - data sets [169](#)
- AUTHTYPE security [316](#)
- AUTHTYPE values for security
 - authorization ID [319](#)
 - group ID [319](#)
 - sign ID from DB2CONN [319](#)
 - terminal ID [319](#)
 - transaction ID [319](#)
 - user ID [319](#)
- autoinstall models [61](#)

B

- backup while open (BWO) [39](#)
- basic authentication [353](#), [363–365](#)
- batch access to CSD, restricting [60](#)
- batch call interface [274](#)
- BCICSPCT general resource class [81](#), [84](#)
- bind-time security
 - for IPCONN [259](#)
 - for IPIC connections [259](#)
 - introduction [219](#)
 - MRO links [266](#)
 - overview [219](#)
- BINDSECURITY option [224](#)
- BMS commands [75](#)
- BUILD ATTACH command [270](#)
- building a keyring [296](#)
- BWO (backup while open) [39](#)

C

- CADP transaction [149](#)
- CATA transaction [142](#)
- cataloged procedures
 - authorizing CICS as a started task [31](#)
- CATD transaction [142](#)
- categories of CICS-supplied transactions [140](#)
- CATR transaction [152](#)
- CBAM transaction [149](#)
- CCICSCMD general resource class [128](#), [136](#)
- CCIN transaction [152](#)
- CCRL
 - running from a START command [310](#)
 - running from a terminal [309](#)
- CCRL transaction [149](#)
- CDBC transaction [149](#)
- CDBD transaction [142](#)
- CDBF transaction [142](#)
- CDBI transaction [149](#)
- CDBM transaction [149](#)
- CDBN transaction [152](#)
- CDBO transaction [142](#)
- CDBQ transaction [142](#)

- CDBT transaction [149](#)
- CDFS transaction [149](#)
- CDT (class descriptor table)
 - IBM-supplied default classes [26](#)
 - resource length [136](#)
 - setting up installation-defined classes [26](#), [137](#)
- CDTS transaction [142](#)
- CEBR transaction [149](#)
- CECI transaction [149](#)
- CECS transaction [149](#)
- CEDA LOCK command [60](#)
- CEDA transaction [60](#), [149](#)
- CEDB transaction [149](#)
- CEDC transaction [149](#)
- CEDF [91](#)
- CEDF transaction [91](#), [129](#), [149](#)
- CEDX [91](#)
- CEDX transaction [91](#), [149](#)
- CEGN transaction [152](#)
- CEHP transaction [149](#)
- CEHS transaction [149](#)
- CEKL transaction [152](#)
- CEMN transaction [149](#)
- CEMT transaction [149](#)
- CEMT, main terminal transaction
 - and CRTE [232](#), [234](#), [263](#), [272](#)
 - considerations for command security [129](#)
 - system programming commands [118](#)
- CEOT transaction [149](#)
- CEPD transaction [142](#)
- CEPF transaction [142](#)
- CEPH transaction [149](#)
- CEPM transaction [142](#)
- CEPQ transaction [149](#)
- CEPR transaction [149](#)
- CEPS transaction [149](#)
- CEPT transaction [149](#)
- certificate [283](#), [289](#)
- certificate authorities [290](#)
- certificate authority [283](#), [289](#)
- certificate revocation list [308](#)
- certificates, creating new [298](#)
- CESC transaction [142](#)
- CESD transaction [150](#)
- CESF transaction [152](#)
- CESL transaction [53](#), [152](#)
- CESN transaction [53](#), [152](#)
- CEST transaction [150](#)
- CETR transaction [150](#)
- CEX2 transaction [142](#)
- CFCL transaction [142](#)
- CFCR transaction [142](#)
- CFDT server authorization [279](#)
- CFOR transaction [142](#)
- CFQR transaction [142](#)
- CFQS transaction [142](#)
- CFRM policy [279](#)
- CFTL transaction [142](#)
- CFTS transaction [142](#)
- CGRP transaction [142](#)
- CHCK transaction [142](#)
- CHLP transaction [150](#)
- CICS as an HTTP client
 - security [364](#)

CICS as an HTTP client (*continued*)
 SSL [372](#)

CICS as an HTTP server
 security [363](#), [365](#), [367](#)

CICS business transaction services
 administration
 security [405](#)
 security
 attach-time [406](#)
 command-level [406](#)
 resource-level [405](#)

CICS command security
 VCICSCMD general resource class [315](#)

CICS commands and resources
 creating security profiles with RACF
 controlling access to resources [178](#)

CICS JOB statement, PASSWORD parameter [32](#)

CICS JOB statement, USER parameter [32](#)

CICS load libraries, protecting [30](#)

CICS region
 access to [43](#)
 access to APPL class profiles [44](#)
 remote [44](#)
 userid as security token [46](#)

CICS region userid
 in started jobs [31](#)

CICS resource security
 XCICSDDB2 general resource class [314](#)

CICS resources
 protecting [19](#)

CICS security [312](#)

CICS security, controlling [207](#)

CICS segment [12](#)

CICS SIT parameters
 security-related [209](#)

CICS source libraries, protecting [30](#)

CICS system definition file (CSD), restricting batch access to
[60](#)

CICS system initialization parameters
 SEC [336](#)
 XCMD [336](#)
 XPPT [336](#)
 XUSER [336](#)

CICS user restart program, PLTPI [70](#)

CICS users [2](#)

CICS web support
 security [363](#)

CICS-RACF security interface
 how ESM exit programs access CICS-related information
[161](#)
 installation data parameter list [162](#)
 RACF user exit parameter list [161](#)
 system authorization facility (SAF) [161](#), [214](#)

CICS-supplied RACF dynamic parse validation routines [29](#)

CICS-supplied transactions security [140](#)

CICS-supplied transactions, categories [140](#)

CICS-WebSphere MQ
 adapter
 security
 authorization [407](#)
 for commands [408](#)
 for transactions [407](#)
 PLTPI [408](#)
 PLTSD [408](#)

CICS-WebSphere MQ adapter (*continued*)
 security (*continued*)
 user IDs [408](#)
 user IDs for security [408](#)

CICS-WebSphere MQ
 bridge
 security [411](#)

CICSplex SM
 authorizing
 libraries [169](#)
 procedures [172](#)
 protecting
 with another ESM [214](#)
 with RACF [165](#)
 resource names [178](#)

CICSplex SM definitions, protecting
 adding SAF resource classes [178](#)

CICSplex SM resource classes
 controlling access to [178](#)

CICSplex SM security profiles
 creating [169](#)

CIDP transaction [150](#)

CIEP transaction [152](#)

CIND transaction [150](#)

cipher suite specification file [290](#)

cipher suites
 identifying which are used [304](#)
 restricting with CIPHERS attribute [290](#), [304](#)
 supported by z/OS and CICS [290](#)

CIPHERS attribute
 CORBASERVER resource [290](#), [304](#)
 TCIPSERVICE resource [290](#), [304](#)
 URIMAP resource [290](#), [304](#)

CIS1 transaction [143](#)

CIS4 transaction [143](#)

CISB transaction [143](#)

CISC transaction [143](#)

CISD transaction [143](#)

CISE transaction [143](#)

CISM transaction [143](#)

CISP transaction [143](#)

CISQ transaction [143](#)

CISR transaction [143](#)

CISS transaction [143](#)

CIST transaction [143](#)

CISU transaction [143](#)

CISX transaction [143](#)

CITS transaction [143](#)

CJLR transaction [143](#)

CJSA transaction [150](#)

CJSL transaction [143](#)

CJSP transaction [143](#)

CJSR transaction [143](#)

CJSU transaction [150](#)

CJTR transaction [143](#)

CKAM transaction [150](#)

CKBC transaction [150](#)

CKBM security [407](#)

CKBM transaction [150](#)

CKBP transaction [150](#)

CKBR transaction [150](#)

CKCN security [407](#)

CKCN transaction [150](#)

CKDL security [407](#)

- CKDL transaction [150](#)
- CKDP security [407](#)
- CKDP transaction [150](#)
- CKQC transaction security [407](#)
- CKRS security [407](#)
- CKRS transaction [150](#)
- CKRT security [407](#)
- CKRT transaction [150](#)
- CKSD security [407](#)
- CKSD transaction [150](#)
- CKSQ security [407](#)
- CKSQ transaction [150](#)
- CKTI transaction security [407](#)
- class descriptor table (CDT) [136](#)
- class, resource [10](#)
- class, resource grouping [11](#)
- classification of data and users [25](#)
- CLAUTH (class authority) attribute
 - in CICS-related general resource classes [9](#)
 - in user's profile [9](#)
 - installation-defined classes [26](#), [138](#)
- CLDM transaction [150](#)
- client certificate [363](#), [364](#)
- client program
 - MRO logon and bind-time security [333](#)
- ClientAuthType [372](#), [376](#)
- clock skew
 - changing [425](#)
 - setting [425](#)
- clock_skew [425](#)
- CLOUD.APPLICATION security profile [204](#)
- CLOUD.DEF security profile [204](#)
- CLOUD.PLATFORM security profile [204](#)
- CLQ2 transaction [152](#)
- CLR1 transaction [152](#)
- CLR2 transaction [152](#)
- CLS1 transaction [152](#)
- CLS2 transaction [152](#)
- CLS3 transaction [152](#)
- CLS4 transaction
 - XTRANID X'06F3F0F1' [249](#)
- CMAC transaction [151](#)
- CMDSEC [336](#)
- CMDSEC operand of DEFINE TRANSACTION [263](#)
- CMDSEC system initialization parameter [128](#)
- CMDSEC, command security parameter [128](#)
- CMPX transaction [152](#)
- CMSG transaction [151](#)
- CMTS transaction [143](#)
- COMAUTHID
 - surrogate security [116](#)
- command authorization
 - DB2 [326](#)
- command security
 - authorization failures [129](#)
 - CCICSCMD general resource class [128](#)
 - CEMT considerations [129](#)
 - CICS resources subject to [120](#)
 - for IPIC connections [263](#)
 - for ISC over TCP/IP connections [263](#)
 - QUERY SECURITY command [130](#)
 - specifying [128](#)
- command security (*continued*)
 - VCICSCMD general resource class [128](#)
 - XCMD parameter [48](#), [74](#), [94](#)
 - XUSER parameter [60](#)
- command-level security [406](#)
- command-level security checks
 - CICS-WebSphere MQ adapter [408](#)
- conditional access lists [69](#)
- conditional access processing [57](#)
- configuration files
 - Security Token Service [426](#)
- configuring [421](#)
- configuring RACF [393](#)
- configuring the pipeline [397](#)
- connection authorization [320](#)
- connection exit routine [321](#)
- connection security [408](#)
- CONSOLE general resource class
 - description [58](#)
- coupling facility data table pool [278](#)
- coupling facility data tables security [278](#)
- COVA [174](#)
- COVC [174](#)
- COVE [174](#)
- COVG [174](#)
- COVP [174](#)
- COVR transaction [144](#)
- COVU [174](#)
- CPCT transaction [144](#)
- CPIH transaction [151](#)
- CPII transaction [151](#)
- CPIQ transaction [151](#)
- CPIR transaction [144](#)
- CPIS transaction [144](#)
- CPLT transaction [114](#), [144](#)
- CPMI transaction [151](#)
- CPSMOBJ general resource class [20](#)
- CPSMXMP general resource class [20](#)
- CPSS transaction [152](#)
- CQPI transaction [152](#)
- CQPO transaction [152](#)
- CQRY transaction [152](#)
- CRL (certificate revocation list) [308](#)
- CRLR transaction [144](#)
- CRMD transaction [144](#)
- CRMF transaction [144](#)
- CRPA transaction [151](#)
- CRPC transaction [151](#)
- CRPM transaction [151](#)
- CRSQ transaction [144](#)
- CRSR transaction [152](#)
- CRST transaction [144](#)
- CRSY transaction [144](#)
- CRTE transaction [144](#), [151](#)
- CRTE, routing transaction [232](#), [234](#), [263](#), [272](#)
- CRTX transaction [151](#)
- CSAC transaction [153](#)
- CSCS transient data destination [59](#)
- CSCY transaction [153](#)
- CSD (CICS system definition file), restricting batch access to [60](#)
- CSD definitions, locking [61](#)
- CSFE transaction [151](#)

- CSFR transaction [144](#)
- CSFU transaction [144](#)
- CSGM transaction [151](#)
- CSHA transaction [144](#)
- CSHQ transaction [145](#)
- CSHR transaction [151](#)
- CSKP transaction [145](#)
- CSM1 transaction [151](#)
- CSM2 transaction [151](#)
- CSM3 transaction [151](#)
- CSM5 transaction [151](#)
- CSMI (CICS-supplied mirror transaction)
 - authorizing the link user ID [334](#)
 - security [334](#)
- CSMI transaction [151](#)
- CSNC transaction [145](#)
- CSNE transaction [145](#)
- CSOL transaction [145](#)
- CSPG transaction [153](#)
- CSPK transaction [153](#)
- CSPP transaction [153](#)
- CSPQ transaction [145](#)
- CSPS transaction [153](#)
- CSQC transaction [145](#)
- CSRK transaction [153](#)
- CSRS transaction [153](#)
- CSSF transaction [153](#)
- CSSY transaction [145](#)
- CSTE transaction [145](#)
- CSTP transaction [145](#)
- CSXM transaction [153](#)
- CSZI transaction [145](#)
- CTIN transaction [151](#)
- CTSD transaction [145](#)
- custom security handler [400](#)
- customizing the CICS-RACF interface
 - determining userid of CICS region [153](#)
 - ESMEXITS parameter [47](#)
 - installation data parameter list [162](#)
 - RACF user exit parameter list [161](#)
- CVMI transaction [151](#)
- CW2A transaction [151](#)
- CWBA transaction [151](#)
- CWBG transaction [145](#)
- CWTO transaction [151](#)
- CWWU transaction [151](#)
- CWXN transaction [145](#)
- CWXU transaction [145](#)
- CXCU transaction [145](#)
- CXRE transaction [145](#)
- CXRT transaction [153](#)

D

- Data Encryption Standard
 - encryption algorithm [290](#)
- data for default user [63](#)
- data set
 - encryption [330](#)
- data set profile [10](#)
- data set profiles
 - enhanced generic naming [17](#)
 - SETROPTS EGN command [17](#)
- data set security

- data set security (*continued*)
 - access to CICS data sets [36](#)
 - access to user data sets [39](#)
 - APPLID parameter [37](#)
 - CICS installation requirements [29](#)
 - CICS system [30](#)
 - MVS library lookaside (LLA) facility [38](#)
- data tables
 - bind security [277](#)
 - CONNECT security checks [277](#)
 - coupling facility [278](#)
 - file security [277](#)
 - security checking [276](#)
 - server authorization security check [276](#)
- date subfields, format [253](#)
- DB2 security
 - accounting [324](#)
 - authorization to execute a plan [327](#)
 - establishing authorization IDs [323](#), [325](#)
 - primary authorization ID [320](#)
 - secondary authorization ID [320](#)
 - security mechanisms [313](#)
- DB2ENTRY resource classes [22](#)
- DCICSDCT general resource class
 - defining profiles [77](#)
- default user [114](#)
- default user, CICS
 - defining [34](#)
 - DFLTUSER parameter [47](#)
 - specifying on SIT [47](#)
- DEFINE CONNECTION
 - ATTACHSEC attribute [269](#)
 - ATTACHSEC operand [228](#), [238](#)
 - BINDSECURITY operand [224](#)
 - SECURITYNAME option [224](#)
- DEFINE TRANSACTION
 - CMDSEC operand [263](#)
 - RESSEC operand [233](#), [239](#), [263](#), [271](#)
- defined activity userid [405](#)
- defined process userid [405](#)
- defining profiles
 - APPCLU general resource class [223](#)
- defining to RACF
 - groups [64](#)
 - users [64](#)
 - users, example [65](#)
- definitions, protecting
 - controlling access to resources [178](#)
- delegation of RACF administrative responsibility [9](#)
- DELMEM operand [57](#)
- deploying [421](#)
- DES
 - encryption algorithm [290](#)
- DES (data encryption standard) [289](#)
- DES authentication [335](#)
- developing
 - applications
 - Kerberos [417](#)
- DFH\$RACF [26](#), [51](#)
- DFHAPPL FACILITY class profiles, defining [334](#)
- DFHEXCI surrogate profile [117](#)
- DFHHTML [175](#)
- DFHINSTL surrogate profile [117](#)
- DFHIRP (interregion communication program)

- DFHIRP (interregion communication program) *(continued)*
 - security checks performed by [333](#)
- DFHSNxxxx messages [59](#)
- DFHSTART surrogate profile [117](#)
- DFHWBPW, password expiry management program [363](#), [365](#)
- DFHXCIS [274](#)
- DFHXCOPT, EXCI options table [116](#)
- DFTUSER parameter
 - definition [15](#)
 - obtaining user data [63](#)
- DFTUSER SIT parameter
 - creating a security environment [169](#)
- DFTUSER, system initialization parameter [47](#)
- diagnostic messages [376](#)
- DIGTCERT general resource class [20](#)
- discrete profile [10](#), [11](#)
- Distributed identity mapping [353](#)
- distributed program link (DPL)
 - with LU6.2 [235](#)
 - with MRO [274](#)
- document template security
 - defining resource classes [71](#), [92](#)
 - RCICSRES resource class [71](#), [92](#)
 - WCICSRES grouping class [71](#), [92](#)
 - XRES parameter [71](#), [75](#), [92](#), [95](#), [371](#)
- document templates
 - security [367](#), [368](#)
- domain [376](#)
- DSN3SATH sample [321](#)
- DSN3SSGN sample [325](#)
- DSNC transaction [151](#)
- dynamic parse validation routines [29](#)

E

- EBCDIC, for PEM userids and passwords [249](#)
- ECICSDCT general resource class
 - defining profiles [77](#)
- enabling a security policy [361](#)
- encryption
 - data sets [330](#)
 - public key [288](#)
- encryption algorithms [290](#)
- ENCRYPTION parameter
 - and SP800-131A [305](#)
- enhanced generic naming
 - data set profile names [17](#)
 - SETROPTS EGN command [17](#)
- ESDSs, VSAM, access to [39](#)
- ESM (external security manager)
 - EBCDIC for userids and passwords [249](#)
 - invoking another
 - overview of interface [214](#)
 - RACROUTE macros [214](#)
 - PassTickets [6](#), [7](#)
 - sample configuration [242](#)
 - sign-on data from CICS to PEM client [252](#)
 - user profile [252](#), [253](#)
 - using RACF
 - controlling CICS security [207](#)
 - creating profiles [169](#), [178](#)
- ESMEXITS, system initialization parameter [47](#)
- evaluation sequence, security [210](#)
- example tasks

- example tasks *(continued)*
 - security [215](#)
- examples
 - attach-time security [406](#)
 - RACF commands [405](#), [406](#)
 - surrogate security checking [405](#)
- EXCI security [274](#)
- EXEC CICS commands
 - QUERY SECURITY [5](#)
 - QUERY SECURITY command [130](#)
- EXEC CICS LINK command
 - DFHAPPL profile definition [334](#)
 - security checking [334](#)
- EXEC CICS QUERY SECURITY [336](#)
- EXEC CICS SET TRQUEUE ATIUSERID [116](#)
- EXEC CICS START USERID [336](#)
- EXEC CICS VERIFY PASSWORD [336](#)
- exits
 - ESM, accessing CICS-related information [161](#)
 - RACF user exit parameter list [161](#)
- explicit sign-on [53](#)
- external call interface [274](#)
- external CICS interface (EXCI)
 - CALL interface
 - DFHAPPL profile definition [334](#)
 - security [333](#)
- External CICS interface (EXCI) and surrogate checking [116](#)
- external security manager (ESM)
 - invoking another
 - overview of interface [214](#)
 - RACROUTE macros [214](#)
 - using RACF
 - controlling CICS security [207](#)
 - creating profiles [169](#), [178](#)
- EXTRACT CERTIFICATE command [363](#)
- EYUCOVE [175](#)
- EYUCOVI [175](#)
- EYULOG [175](#)
- EYUWREP [175](#)
- EYUWUI [175](#)

F

- FACILITY class profiles, defining [334](#)
- FACILITY general resource class [21](#)
- FCICSFCT general resource class [79](#)
- FEPIRESOURCE resource name [118](#)
- FIELD general resource class [14](#), [20](#)
- file resource security checking [280](#)
- file security
 - access authorization levels [80](#)
 - data set profiles [17](#)
 - defining resource classes [79](#)
 - FCICSFCT general resource class [79](#)
 - generic data set profiles [17](#)
 - HCICSFCT general resource class [79](#)
 - XFCT parameter [48](#), [74](#), [80](#), [95](#)
- files processed by CICS [79](#)
- FIPS compliance [305](#)
- flows, examples [246](#)
- FMH (function management header)
 - attach [251](#)
 - attach FMH5 and data
 - FMH5 attach header [250](#)

FMH (function management header) (*continued*)
user data following [250](#)
function shipping
mirror transaction [234](#), [239](#), [273](#)
RESSEC operand of DEFINE TRANSACTION [233](#), [239](#),
[271](#)

G

GCICSTRN general resource class [47](#), [66](#), [82](#)
GCPSMOBJ resource group class [20](#)
GDS (generalized data stream)
GDS LL length
variables to pass data
general resource class
APPCLU
defining profiles [223](#)
general resource classes
ACICSPCT [81](#), [84](#)
APPCLU [20](#)
APPL [20](#)
BCICSPCT [81](#), [84](#)
CCICSCMD [128](#)
CONSOLE [20](#)
CPSMOBJ [20](#)
CPSMXMP [20](#)
DIGTCERT [20](#)
FACILITY [21](#), [265](#)
FIELD [14](#), [20](#)
for protecting CICS resources [19](#)
for protecting resources [19](#)
for protecting system resources [20](#)
JCICSJCT [80](#)
JESSPOOL [20](#), [46](#)
KCICSJCT [80](#)
LOGSTRM [21](#)
MCICSPPT [85](#)
NCICSPPT [85](#)
OPERCMDs [21](#), [61](#)
PCICSPSB [90](#)
PROGRAM [21](#)
PROPCNTL [21](#), [44](#)
PTKTDATA [21](#)
QCICSPSB [90](#)
SCICSTST [86](#)
STARTED [21](#)
SUBSYSNM [21](#)
SURROGAT [21](#), [45](#)
TERMINAL [21](#)
UCICSTST [86](#)
user-defined [137](#)
VCICSCMD [128](#)
VTAMAPPL [21](#), [44](#)
general resource profile [10](#)
general resource profiles
refreshing [209](#)
generating and using RACF PassTickets [6](#)
generic connection
note about lack of security checks [333](#)
generic profile [10](#), [11](#)
generic profiles
SETROPTS command [25](#)
SETROPTS GENERIC [10](#), [17](#), [27](#), [56](#)

generic resource names (z/OS Communications
Server)
z/OS Communications Server generic resource [43](#)
generic resource profiles [91](#), [96](#)
global security parameters [209](#)
goodnight transaction [55](#)
GRANT command [326](#)
group identifier [52](#)
group profile [10](#)
group profiles [16](#)
GROUP special command
SEARCH command warning [25](#)
group-SPECIAL attribute [9](#)
grouping class, resource [11](#)
GTERMINAL definition [56](#)
GTERMINL definition [56](#)
GTERMINL resource group class [21](#)

H

handshakerole=serverwithclientauth [377](#)
HCICSFCT general resource class [79](#)
HFS file security
XHFS parameter [74](#), [88](#), [95](#)
HTTP client requests
security [364](#)

I

IBM-supplied classes
example for files [50](#), [51](#)
example for PSBs [50](#), [51](#)
example for transactions [50](#), [51](#)
ICH408I, RACF message [69](#)
ICHERCDE macro [9](#), [137](#)
ICHRFR01 (RACF router table) [138](#)
ICHRFRTB macro [138](#)
ICHRIN03 started procedures table [172](#)
ICHRIN03, RACF started task table [31](#)
ICHRRCDE (installation-defined class descriptor table) [137](#)
ICHRTX00, MVS router exit [153](#)
IDENTIFY parameter, ATTACHSEC operand [229](#)
identifying remote users [229](#), [262](#), [270](#)
in-storage profiles
and XCMD resource class [128](#)
GTERMINL profiles [56](#)
reducing need for [20](#)
refreshing [16](#)
installation-defined classes
example for files [51](#)
example for PSBs [51](#)
example for transactions [51](#)
example for user-defined resource [137](#)
intersystem communication (ISC) security
coding ATTACHSEC [228](#), [269](#)
intrapartition transient data resources [115](#)
invoking the trust client [401](#)
IPCONNs
link security [260](#)
IPIC
bind-time security [259](#)
IPIC connections
command security [263](#)

IPIC connections (*continued*)
 how security is implemented [259](#)
 resource security [263](#)
 transaction security [263](#)
 user security [261](#)
IPIC security
 CRTE [232](#), [234](#), [263](#), [272](#)
 introduction [6](#)
IRR.DIGTCERT.ADD profile [300](#)
ISC over SNA security
 APPC (LU6.2) session security [6](#)
ISC over TCP/IP connections
 command security [263](#)
 resource security [263](#)
 transaction security [263](#)

J

Java security manager [361](#)
java.security.policy [361](#)
JCICSJCT general resource class [80](#)
JES spool protection [46](#)
JESSPOOL general resource class [20](#), [46](#)
job submission, surrogate [45](#)
journal security
 access authorization levels [80](#), [83](#)
 defining resource classes [80](#)
 XJCT parameter [48](#), [74](#), [80](#), [95](#)
journals and log streams
 journal access authorization levels [80](#)

K

KCICSJCT general resource class [80](#)
Kerberos
 configuring web services [416](#)
 developing applications [417](#)
key rings [296](#)
keyring
 building [296](#)
KEYRING [372](#), [376](#)

L

labels, RACF security [25](#)
language segment
 PRIMARY language parameter [16](#)
 system defaults [15](#)
 user profile [15](#)
LDAP [353](#)
LDAP server
 configuring [308](#)
levels, RACF security [25](#)
libraries, CICSplex SM
 protecting with RACF [165](#)
Lightweight Directory Access Protocol [353](#)
link security
 for IPCONNs [260](#)
 introduction [220](#)
load libraries, protecting [30](#)
LOCAL parameter, ATTACHSEC operand [229](#)
LOCK command, CEDA [60](#)
log records

log records (*continued*)
 SMF type 80 [69](#), [77](#)
log streams
 authorizing access to [35](#)
 LOGSTRM general resource class [35](#)
logging security events
 QUERY SECURITY [139](#)
 RACF audit messages in SMF [77](#)
 requested by CICS on authorization requests [77](#)
 sign-on and sign-off activity [58](#)
logon security [333](#)
LOGSTRM general resource class [21](#)
LU6.1 links [237](#)
LU6.1 security [237](#)
LU6.2 (APPC) session security
 introduction [6](#), [222](#)
 XAPPC parameter [48](#), [50](#), [74](#), [94](#), [223](#)
 XDB2 parameter [74](#), [94](#)
LU6.2 security
 CRTE [232](#), [234](#), [263](#), [272](#)

M

MAC (message authentication code) [288](#)
maps
 security considerations [176](#)
marking a certificate untrusted [301](#)
MCICSPPT general resource class [85](#)
MD5
 encryption algorithm [290](#)
members, group
 ADDMEM operand to add [57](#)
 DELMEM operand to remove [57](#)
message authentication code (MAC) [288](#)
Message Digest
 encryption algorithm [290](#)
message handler
 invoking trust client [401](#)
messages
 authorization failures [69](#)
 destination of ICH408I message [69](#)
 DFHSNxxxx [59](#)
 ICH408I, RACF [69](#)
MINTLSLEVEL/ENCRYPTION [372](#), [376](#)
mirror transactions
 availability of [146](#)
 for DPL on LU6.2 [235](#)
 for DPL on MRO [274](#)
 function shipping [234](#), [239](#), [273](#)
mixed case
 password [65](#)
MIXIDPE parameter, ATTACHSEC operand [229](#)
MQCONN
 security [408](#)
MQMONITOR
 security [408](#)
MRO (multiregion operation) security
 CRTE [232](#), [234](#), [263](#), [272](#)
MRO logon and connect [267](#)
multiple volumes [39](#)
multiregion operation (MRO)
 logon and bind time security [333](#)
MVS
 library lookaside (LLA) facility [38](#)

MVS (*continued*)
password and RACF authorization checking [29](#)
program properties table (PPT) [29](#)

N

National Language Support [15, 63](#)
NATLANG and non-terminal transactions [66](#)
NCICSPPT general resource class [85](#)
NETNAME terminal definition [56](#)
NIST conformance [305](#)
non-terminal security
transactions not associated with terminals [5](#)
Null authentication [335](#)

O

OIDCARD (operator identification card) [5](#)
OPCLASS [12](#)
operator, CICS terminal
example of defining to RACF [65](#)
obtaining data for [63](#)
operator, terminal
data at sign on [63](#)
data for default user [63](#)
OPERCMDS general resource class [21](#)
OPIDENT [12](#)
OPPTY [12](#)
OSGi security [361](#)

P

parameter
authorizing access to CICS region [43](#)
protecting CICS data sets [37](#)
parameters
security
activating [209](#)
checking [209](#)
global [209](#)
PassTicket [337](#)
PassTickets, for signon security [6, 7](#)
password
mixed case [65](#)
password expiry management program DFHWBPW [363, 365](#)
password phrase [53](#)
password phrases
mixed case [65](#)
passwords
8 characters [250](#)
in ESM user profile [252, 253](#)
information provided by APPC PEM [241](#)
updating [242](#)
passwords and password phrases [53](#)
Patterns
SAML programs [427](#)
PCICSPSB general resource class [90](#)
PEM requester
conversation type [249](#)
definition [242](#)
format of user data [250](#)
sign-on completion status values returned by CICS [253](#)
PEM server, CICS

PEM server, CICS (*continued*)
data exceeding maximum buffer size [250](#)
EBCDIC for userids and passwords [249](#)
error status returned [246](#)
format of date and time subfields [253](#)
PROFILE option [250](#)
synclevel 0 [249](#)
PERMIT command
WHEN operand [57](#)
PERSISTENT parameter, ATTACHSEC operand [229](#)
persistent sessions
XRFSOFF operand [12](#)
persistent sessions restart
remaining signed on [12](#)
sign-off [12](#)
persistent verification (PV)
ATTACHSEC-PERSISTENT [246](#)
CONNECTION [245](#)
sign-on successful, example flow [246](#)
sign-on unsuccessful, with PV [248](#)
signed on [248](#)
signed-on-from list [245](#)
signed-on-to list [245](#)
successful sign-on flow [247](#)
unsuccessful sign-on [248](#)
when implementing LU6.2 security [228](#)
PIP (program initialization parameter) data [250](#)
pipeline
provider
configuring for SAML tokens [422](#)
requester
configuring for SAML [424](#)
PKCS (public key cryptography standard) [289](#)
platform
security [178, 204](#)
PLT
post-initialization processing [114](#)
PLT programs [70](#)
PLTPI [70](#)
PLTPISEC, system initialization parameter [47](#)
PLTPIUSR system initialization parameter [47, 114](#)
PLTSD [70](#)
POSIT numbers
installation-defined general resource classes [18, 26](#)
post-initialization processing, surrogate security [114](#)
PREFIX attribute definition [86](#)
prefixing
with SECPRFX [46](#)
preset security sessions [61](#)
preset terminal NATLANG [66](#)
preset terminal security
autoinstall models [61](#)
CEDA LOCK command [60](#)
CEDA transaction [60](#)
controlling definition and installation [60](#)
other considerations [61](#)
restricting batch access to CSD [60](#)
starting tasks at terminals [82](#)
SURROGAT transaction [60](#)
terminal routing [234](#)
transactions not associated with a terminal [69](#)
using MVS system console as CICS terminal [61](#)
PRIMARY language parameter [16](#)
problem determination

- problem determination (*continued*)
 - ATTACH security fields [250](#)
 - data exceeds maximum buffer size [250](#)
 - determining userid of CICS region [153](#)
 - error messages for authorization failures [69](#)
 - GDS FREE command received [250](#)
 - ICH408I, RACF message [69](#)
 - new password ID [250](#)
 - password not in EBCDIC [249](#)
 - PIP data optional [250](#)
 - PROFILE option [250](#)
 - reasons for sign-on failure [246](#)
 - response to incorrect data format [258](#)
 - sign-on failure [246](#)
 - sign-on request formatting errors [254](#)
 - synclevel [249](#)
 - transaction ID [249](#)
 - userid and password of more than 8 characters [250](#)
 - userid not in EBCDIC [249](#)
- process
 - security of [405](#), [406](#)
- PRODCFT1 [279](#)
- profile [10](#)
- profile, data set [10](#)
- profile, discrete [10](#), [11](#)
- profile, general resource [10](#)
- profile, generic [10](#), [11](#)
- profile, resource group [10](#)
- profile, user [2](#), [10](#)
- profiles
 - ACICSPCT general resource class [81](#), [84](#)
 - BCICSPCT general resource class [81](#), [84](#)
 - CCICSCMD general resource class [128](#), [136](#)
 - data set [17](#)
 - DCICSDCT general resource class [77](#)
 - defining
 - APPCLU general resource class [223](#)
 - ECICSDCT general resource class [77](#)
 - enhanced generic naming [17](#)
 - FCICSFCT general resource class [79](#)
 - GCICSTRN general resource class [47](#), [66](#), [82](#)
 - generic [25](#)
 - generic data set [17](#)
 - HCICSFCT general resource class [79](#)
 - JCICSJCT general resource class [80](#)
 - JESSPOOL [46](#)
 - KCICSJCT general resource class [80](#)
 - MCICSPPT general resource class [85](#)
 - NCICSPPT general resource class [85](#)
 - PCICSPSB general resource class [90](#)
 - PROPCNTL [44](#)
 - QCICSPSB general resource class [90](#)
 - RALTER command to change [24](#)
 - RCICSRES resource class [71](#), [92](#)
 - RDEFINE command to create [24](#)
 - RDELETE command to delete [24](#)
 - refreshing in main storage [18](#)
 - resource and WARNING option [77](#)
 - resources, defining generic [91](#), [96](#)
 - SCICSTST general resource class [86](#)
 - SETROPTS command [25](#), [56](#)
 - SETROPTS EGN command [17](#)
 - SURROGAT general resource class [45](#), [117](#)
 - TCICSTRN general resource class [47](#), [66](#), [82](#)

- profiles (*continued*)
 - terminal (PoE), defining [56](#)
 - transaction and conditional access lists [69](#)
 - transaction, defining to RACF [68](#)
 - UCICSTST general resource class [86](#)
 - USER parameter on CICS JOB statement [32](#)
 - VCICSCMD general resource class [128](#)
 - VTAMAPPL [44](#)
 - WCICSRES grouping class [71](#), [92](#)
- profiles for transient data queues [78](#)
- profiles, group [10](#)
- PROGRAM general resource class [21](#)
- program initialization parameter (PIP) data [250](#)
- program properties table (PPT), MVS [29](#)
- program security
 - XPPT parameter [48](#), [74](#), [85](#), [95](#)
- propagation of userid, controlling [44](#)
- PROPCNTL general resource class
 - defining profiles [44](#)
- protecting
 - CICS resources [19](#)
 - resources [19](#)
 - system resources [20](#)
- provider pipeline
 - configuring
 - for SAML tokens [422](#)
- proxy authentication [364](#)
- PSB security
 - access authorization levels [90](#)
 - defining resource classes [90](#)
 - PCICSPSB general resource class [90](#)
 - QCICSPSB general resource class [90](#)
 - XPSB parameter [48](#), [75](#), [90](#), [95](#)
- PSBCHK parameter [90](#), [130](#)
- PSBCHK, system initialization parameter [48](#)
- pthreads [293](#)
- PTKTDATA general resource class [21](#)
- public key encryption [288](#), [289](#)
- PVDELAY system initialization parameter [230](#)

Q

- QCICSPSB general resource class [90](#)
- QUERY SECURITY command
 - and resource classes [130](#)
 - and transaction routing [130](#)
 - description [130](#)
 - effect of SEC parameter [130](#)
 - effect of SECPRFX parameter [130](#)
 - how the command works [130](#)
 - logging [139](#)
 - RESCCLASS [136](#)
 - RESTYPE [131](#)
 - RESTYPE, values returned [135](#)
 - SPCOMMAND, RESID values [132](#)
 - specifying user-defined resources [137](#)

R

- RACDCERT command [296](#), [299](#)
- RACF
 - example commands [405](#), [406](#)
 - external security manager [311](#)

- RACF (*continued*)
 - profile [10](#)
- RACF (resource access control facility)
 - activating the CICS classes [18](#)
 - administration [8](#)
 - authorizing CICS users [64](#)
 - CICS default user [15](#)
 - CICS installation requirements [29](#)
 - CICS segment [12](#)
 - class descriptor table, ICHRRCODE [137](#)
 - data set profiles [17](#)
 - defining default CICS userid [34](#)
 - defining port of entry profiles [56](#)
 - defining your own resource class names [26](#)
 - FIELD general resource class [14](#)
 - general resource profiles [18](#)
 - generic data set profiles [17](#)
 - generic resource profiles [91, 96](#)
 - group profile [16](#)
 - group profiles [16](#)
 - language segment [15](#)
 - overriding SETROPTS TERMINAL [57](#)
 - RACF segment [11](#)
 - refreshing resource profiles in main storage [18](#)
 - router table, ICHRFR01 [138](#)
 - security labels [25](#)
 - security levels [25](#)
 - terminal profiles [56](#)
 - undefined terminals [57](#)
 - user profiles [11](#)
 - with multiple MVS images [29](#)
- RACF (Resource Access Control Facility)
 - controlling access to resources [178](#)
 - defining transactions [172, 173](#)
 - exempting items from security checking [208](#)
- RACF class
 - DSNR [321](#)
- RACF commands
 - ADDGROUP, example [17](#)
 - ADDUSER, example for default CICS userid [34](#)
 - CONNECT, example [17](#)
 - DELMEM operand [57](#)
 - example of ALTUSER command [9](#)
 - example of CONNECT command (group-SPECIAL) [10](#)
 - PERMIT [24](#)
 - RALTER [24, 57](#)
 - RDEFINE [24](#)
 - RDELETE [24](#)
 - REMOVE, example [17](#)
 - SEARCH—warning [25](#)
 - SETROPTS [17, 25](#)
- RACF default resource profiles
 - VCICSCMD general resource class [315](#)
- RACF definitions for surrogate user checking [117](#)
- RACF list of groups option [325](#)
- RACF PassTickets [6](#)
- RACF profiles
 - refreshing [209](#)
- RACF Secured Sign-on [337](#)
- RACF SPECIAL authority [300](#)
- RACFVARS profiles [117](#)
- RACLIST [138](#)
- RACROUTE macros, for security [214](#)
- RALTER command [24](#)
- RC2
 - encryption algorithm [290](#)
- RC4
 - encryption algorithm [290](#)
- RCICSRES [26](#)
- RCICSRES resource class [71, 92](#)
- RDELETE command [24](#)
- RDO
 - restricting use of transaction [60](#)
- refreshing RACF profiles [209](#)
- remote operators [227, 269](#)
- remote user sign-off [229, 262, 270](#)
- remote users [227, 269](#)
- requester pipeline
 - configuring
 - for SAML [424](#)
- RESID values for SPCOMMAND [132](#)
- resource access control facility (RACF) [333](#)
- Resource Access Control Facility (RACF)
 - controlling access to resources [178](#)
 - defining transactions [172, 173](#)
 - exempting items from security checking [208](#)
- Resource and command check cross-reference [96](#)
- resource checker (CICS ONC RPC)
 - writing [337](#)
- resource class
 - APPCLU
 - defining profiles [223](#)
- resource classes, CICSplex SM
 - controlling access to [178](#)
- resource definition
 - LU6.2 (APPC) session security [224](#)
 - resource security [233, 239, 271](#)
 - SECURITYNAME option [224](#)
 - transaction security [233, 239, 263, 271](#)
 - user security in link definitions [228, 269](#)
- resource definition online (RDO) [152](#)
- resource definition parameters
 - CMDSEC [128, 129](#)
 - RESSEC [75, 91](#)
- resource group
 - DELMEM operand to remove [57](#)
- resource group classes
 - GCPSMOBJ [20](#)
 - GTERMINL [21](#)
- resource group profile [10](#)
- resource grouping class [11](#)
- resource names, CICSplex SM [178](#)
- resource profiles
 - RALTER command to change [24](#)
 - RDEFINE command to create [24](#)
 - RDELETE command to delete [24](#)
- resource security
 - access authorization levels, files [80](#)
 - access authorization levels, z/OS UNIX files [90](#)
 - ACICSPCT general resource class [81, 84](#)
 - activating the CICS classes [18](#)
 - application programs [85](#)
 - auditing [77](#)
 - authorization failures [76](#)
 - BCICSPCT general resource class [81, 84](#)
 - CCICSCMD general resource class [136](#)
 - CICS SIT parameters [48](#)

resource security (*continued*)

- DCICSDCT general resource class [77](#)
- defining generic profiles [91](#), [96](#)
- defining profiles for TD queues [78](#)
- defining your own resource class names [26](#)
- document templates [71](#), [92](#), [371](#)
- ECICSDCT general resource class [77](#)
- FCICSFCT general resource class [79](#)
- FIELD general resource class [14](#)
- files [79](#)
- for IPIC connections [263](#)
- for ISC over TCP/IP connections [263](#)
- GCICSTRN general resource class [47](#), [66](#), [82](#)
- general checking by CICS and RACF [74](#), [94](#)
- general resource profiles [18](#)
- HCICSFCT general resource class [79](#)
- HFS files [88](#)
- JCICSJCT general resource class [80](#)
- journals and log streams [80](#)
- KCICSJCT general resource class [80](#)
- level of access required [92](#)
- logging RACF audit messages to SMF [77](#)
- MCICSPPT general resource class [85](#)
- NCICSPPT general resource class [85](#)
- PCICSPSB general resource class [90](#)
- profiles and WARNING option [77](#)
- program specification blocks [90](#)
- QCICSPSB general resource class [90](#)
- QUERY SECURITY command [5](#), [130](#)
- QUERY SECURITY RESCLASS [136](#)
- RCICSRES resource class [71](#), [92](#)
- refreshing profiles in main storage [18](#)
- resource definition [233](#), [239](#), [271](#)
- RESSEC system initialization parameter [76](#)
- RESSEC transaction resource security parameter [75](#)
- SCICSTST general resource class [86](#)
- SPCOMMAND, RESID values [132](#)
- TCICSTRN general resource class [47](#), [66](#), [82](#)
- temporary storage [86](#)
- transaction routing [233](#), [272](#)
- transient data queues [77](#)
- UCICSTST general resource class [86](#)
- WCICSRES grouping class [71](#), [92](#)
- XAPPC parameter [74](#), [94](#)
- XCMD parameter [74](#), [94](#)
- XDB2 parameter [74](#), [94](#)
- XDCT parameter [74](#), [95](#)
- XFCT parameter [74](#), [80](#), [95](#)
- XHFS parameter [48](#), [74](#), [87](#), [88](#), [95](#)
- XJCT parameter [74](#), [80](#), [95](#)
- XPCT parameter [74](#), [81](#), [84](#), [95](#)
- XPPT parameter [74](#), [85](#), [95](#)
- XPSB parameter [75](#), [90](#), [95](#)
- XRES parameter [49](#), [71](#), [75](#), [92](#), [95](#), [371](#)
- XTST parameter [75](#), [86](#), [95](#)
- z/OS UNIX files [87](#)
- resource-level security [405](#)
- resource-level security checks
 - CICS-WebSphere MQ adapter [407](#)
- resources
 - protecting [19](#)
- RESSEC [336](#)

- RESSEC operand of DEFINE TRANSACTION [233](#), [239](#), [263](#), [271](#)
- RESSEC resource security parameter [75](#)
- RESSEC, system initialization parameter [48](#)
- Rivest
 - encryption algorithm [290](#)
- routing transaction, CRTE [232](#), [234](#), [263](#), [272](#)
- RRCOTE sample job [314](#)

S

- SAF (system authorization facility)
 - and MVS router [161](#), [214](#)
 - to route requests to RACF [1](#)
- SAML
 - configuring CICS [421](#)
- SAML tokens
 - expired [425](#)
 - modifying [425](#)
 - not yet valid [425](#)
 - re-signing [425](#)
 - signing [425](#)
- SAML-aware programs [427](#)
- Sample CLIST DFH\$CTA1 [141](#)
- sample connection exit routine (DSN3SATH) [321](#)
- sample sign-on exit routine (DSN3SSGN) [325](#)
- SASS (single address space) [320](#)
- SCICSTST general resource class [86](#)
- scoping sign-on definition [53](#)
- SEC system initialization parameter [336](#)
- SEC, system initialization parameter [46](#)
- SECPREFX, system initialization parameter [46](#)
- Secure Hash
 - encryption algorithm [290](#)
- Secured Sign-on [337](#)
- securing transactions and resources [221](#)
- security
 - access to WUI resources [176](#)
 - alias transaction [368](#)
 - application-generated responses [368](#)
 - authentication [363](#), [364](#), [367](#)
 - AUTHTYPE [316](#)
 - basic authentication [363–365](#)
 - CICS system [368](#)
 - CICS-WebSphere MQ
 - adapter
 - transactions [407](#)
 - user IDs [408](#)
 - CICS-WebSphere MQ bridge [411](#)
 - CKTI [408](#)
 - command security [313](#)
 - COVA [174](#)
 - COVC [174](#)
 - COVE [174](#)
 - COVG [174](#)
 - COVP [174](#)
 - COVU [174](#)
 - DB2TRAN resource security [314](#)
 - defining RACF profiles [314](#)
 - DFHHTML [175](#)
 - document templates [367](#), [368](#)
 - EYUCOVE [175](#)
 - EYUCOVI [175](#)
 - EYULOG [175](#)

- security (*continued*)
 - EYUWREP [175](#)
 - EYUWUI [175](#)
 - identification [363](#), [364](#)
 - inbound ports [367](#)
 - Liberty JVM server [353](#)
 - non-terminal [69](#)
 - of activities
 - attach-time [406](#)
 - defined activity userid [405](#)
 - resource-level [405](#)
 - of BTS commands [406](#)
 - of processes
 - attach-time [406](#)
 - defined process userid [405](#)
 - resource-level [405](#)
 - password expiry management [365](#)
 - password phrase expiry management [365](#)
 - port number
 - security [367](#)
 - proxy authentication [364](#)
 - RACF [311](#)
 - RACF class, DSNR [321](#)
 - resource [70](#), [94](#)
 - resource level [367](#)
 - resource security [313](#)
 - SAML [421](#)
 - SASS [320](#)
 - sign-on [6](#), [7](#)
 - SSL [372](#)
 - surrogate user checking [316](#)
 - the CICS/ESM interface [161](#)
 - using PassTickets [6](#), [7](#)
 - z/OS UNIX files [367](#), [368](#)
 - z/OS UNIX System Services [367](#), [368](#)
- security categories [25](#)
- security checking
 - controlling CICS [207](#)
 - ESM interface [214](#)
 - evaluation sequence [210](#)
 - exempting items [208](#)
 - parameters [209](#)
 - with another ESM [214](#)
 - with RACF [165](#)
- security classification of data and users [25](#)
- security for web services [385](#)
- security handler
 - writing your own [400](#)
- security labels [25](#)
- security levels [25](#)
- security manager
 - applying a security policy [361](#)
 - enabling a security policy [361](#)
- security profiles
 - refreshing [209](#)
- security profiles, RACF
 - creating [169](#)
 - views protected by [181](#)
- security rebuild [16](#), [226](#)
- security tasks, example [215](#)
- security token extensions
 - configuring provider pipeline [422](#)
 - configuring requester pipeline [424](#)
- security token of JES spool files [46](#)
- Security Token Service
 - trust client interface [389](#)
- Security Token Service configuration file [426](#)
- security, DBCTL
 - PSB authorization checking by CICS [330](#)
- security, surrogate [316](#)
- SECURITYPREFIXID [279](#)
- segment
 - CICS [12](#)
 - data for terminal user [14](#)
 - LANGUAGE [15](#)
 - RACF [11](#)
- server program
 - security considerations [333](#)
- server.xml [353](#)
- session key [222](#)
- session security [222](#)
- session segment [223](#)
- SETROPTS command
 - CLASSACT option [138](#)
 - generic data set profiles [17](#)
 - GENERIC option [138](#)
 - generic terminal profiles [56](#)
 - generic user profiles [27](#)
 - RACLIST option [138](#)
 - REFRESH option [139](#)
- SETROPTS GENERICOWNER command [10](#)
- SHA
 - encryption algorithm [290](#)
- shared data tables
 - bind security [277](#)
 - CONNECT security checks [277](#)
 - file security [277](#)
 - security checking [276](#)
 - server authorization security check [276](#)
- sign-off
 - after persistent sessions restart [12](#)
 - after XRF takeover [12](#)
 - logging activity [58](#)
 - process [54](#)
- sign-off process [54](#)
- sign-on
 - after persistent sessions restart [12](#)
 - after XRF takeover [12](#)
 - logging activity [58](#)
 - unsuccessful, example flow [246](#)
 - user data for terminal user [63](#)
- sign-on exit routine [325](#)
- sign-on requester transaction
 - input data required by CICS PEM server [251](#)
 - SNA service transaction program name [251](#)
- sign-on security [6](#), [7](#)
- signature verification
 - SAML [425](#)
- signon requester transaction
 - ATTACH security fields [250](#)
 - data exceeds maximum buffer size [250](#)
 - EBCDIC for userids and passwords [249](#)
 - new password ID [250](#)
 - permitted userid and password length [250](#)
 - PIP data optional [250](#)
 - PROFILE option [250](#)
 - synclevel 0 [249](#)
 - X'06F3F0F1', transaction ID [249](#)

- simulated CICS security [207](#)
- single address space (SASS) [320](#)
- SIOCTLCTL ioctl [372](#), [376](#)
- SIT parameters, CICS
 - security-related [209](#)
- skew time
 - changing [425](#)
 - setting [425](#)
- SMF (System Management Facility) [8](#), [58](#)
- SNA LU
 - SNA ACB access [44](#)
- SNA service transaction program name for sign-on transaction program [251](#)
- SNSCOPE sign-on operand [48](#)
- SOAP message
 - encrypting [391](#)
 - signing [390](#)
- source libraries, protecting [30](#)
- SP800-131A [305](#)
- SPCOMMAND, RESID values [132](#)
- specific connection
 - MRO logon security checks [333](#)
- spool files, security token [46](#)
- SPOOLOPEN commands [46](#)
- SQL
 - dynamic [328](#)
 - static [328](#)
- SSL
 - client certificate authentication [363](#), [364](#)
 - for CICS as an HTTP client [372](#)
- SSL connection improvements [293](#)
- SSL pool [293](#)
- SSL(ATLSAWARE) [377](#)
- start transaction
 - started transactions [114](#)
- STARTED general resource class [21](#)
- started jobs
 - defining CICS region userid [31](#)
- started task
 - and RACF userid [11](#)
 - authorizing CICS procedures [31](#)
- started transaction security [81](#), [84](#)
- STS configuration file [426](#)
- sts-config.xml [426](#)
- sts.xml [426](#)
- sts.xsd [426](#)
- SUBSYSNM general resource class [21](#)
- successful signon
 - new password [255](#)
 - PEM client to CICS PEM server [246](#)
 - response to correct sign-on data [256](#)
 - response to incorrect data format [258](#)
 - successful sign-on [246](#)
 - successful sign-on with PV [247](#)
 - unsuccessful sign-on [246](#)
 - unsuccessful sign-on with PV [248](#)
- SURROGAT general resource class [21](#), [45](#), [60](#), [117](#)
- SURROGAT transaction [60](#)
- surrogate authority, querying a user's [139](#)
- surrogate job submission
 - to JES internal reader [45](#)
- surrogate security checking [405](#)
- surrogate terminal [234](#)
- surrogate user
 - surrogate user (*continued*)
 - authorizing CICS region userid as [45](#)
 - surrogate user security
 - checking [113](#)
 - post-initialization processing [114](#)
 - RACF definitions [117](#)
 - RACF definitions examples [117](#)
 - SURROGCHK parameter [116](#)
 - symmetric encryption [289](#)
 - system data set
 - authorizing access to [36](#)
 - generic profiles needed [36](#)
 - levels of access to [36](#)
 - protecting [30](#)
 - system initialization parameters, CICS
 - CMDSEC [47](#), [128](#)
 - DFLTUSER [47](#)
 - ESMEXITS [47](#)
 - PLTPISEC [47](#)
 - PLTPIUSR [47](#)
 - prefixing CICS resource names [46](#)
 - PSBCHK [48](#), [90](#), [130](#)
 - resource security [48](#)
 - RESSEC [48](#)
 - SEC [46](#)
 - SEC with QUERY SECURITY [130](#)
 - SECPRFX [46](#)
 - SECPRFX with QUERY SECURITY [130](#)
 - SNSCOPE [48](#)
 - XAPPC [48](#), [50](#), [74](#), [94](#), [223](#)
 - XCMD [48](#), [74](#), [94](#), [128](#)
 - XDB2 [48](#), [74](#), [94](#)
 - XDCT [48](#), [74](#), [77](#), [95](#)
 - XFCT [48](#), [74](#), [80](#), [95](#)
 - XHFS [48](#), [50](#), [74](#), [87](#), [88](#), [95](#)
 - XJCT [48](#), [74](#), [80](#), [95](#)
 - Xname parameters [130](#)
 - XPCT [48](#), [74](#), [81](#), [84](#), [95](#)
 - XPPT [48](#), [74](#), [85](#), [95](#)
 - XPSB [48](#), [75](#), [90](#), [95](#)
 - XRES [49](#), [71](#), [75](#), [92](#), [95](#), [371](#)
 - XTRAN [68](#)
 - XTST [49](#), [75](#), [86](#), [95](#)
 - XUSER [49](#), [50](#)
- System Management Facility (SMF) [8](#), [58](#)
- system resources
 - protecting [20](#)
- system security
 - CICS installation requirements [29](#)
- system-SPECIAL attribute [9](#)
- systems network architecture (SNA) session security [219](#)

T

- tasks, example
 - security [215](#)
- TCICSTRN general resource class [47](#), [66](#), [82](#)
- TCP/IP connections
 - bind-time security [259](#)
- TCPIPSERVICE [377](#)
- TCPIPSERVICE resource definition
 - security [367](#)
 - SSL
 - URIMAP resource definition [367](#)

- temporary storage
 - access authorization levels [87](#)
 - authorizing access to named counter servers [41](#)
 - authorizing access to the named counter pools [41](#)
 - authorizing access to the TS pools [39](#)
 - authorizing access to TS servers [40](#)
 - defining resource classes [86](#)
 - SCICSTST general resource class [86](#)
 - UCICSTST general resource class [86](#)
- terminal
 - emulators [417](#)
- TERMINAL definition [56](#)
- TERMINAL general resource class [21](#)
- terminal security
 - autoinstall models [61](#)
 - CEDA LOCK command [60](#)
 - controlling access [55](#)
 - example of defining users to RACF [65](#)
 - identifying users [52](#)
 - obtaining CICS-related data for a user [63](#)
 - overriding SETROPTS TERMINAL [57](#)
 - preset [5](#), [59](#)
 - sign-on [53](#)
 - terminal profiles [56](#)
 - terminals in TCT [61](#)
 - undefined terminals [57](#)
 - universal access authority [57](#)
 - user [5](#)
 - using MVS system console as CICS terminal [61](#)
 - XTRAN [49](#)
- terminal user security [5](#)
- terminals defined in TCT [61](#)
- Terminals, defining individual profiles [56](#)
- time subfields, format [253](#)
- TIMEOUT [12](#)
- TLS12 [305](#)
- trace points [376](#)
- transaction attach security
 - CICS parameters controlling [66](#)
 - processing when SEC=YES and XTRAN=YES [68](#)
- transaction initiation [232](#), [239](#), [263](#), [271](#)
- transaction routing and QUERY SECURITY [130](#)
- transaction security
 - access authorization levels [83](#)
 - categories of CICS-supplied transactions [140](#)
 - category 1 transactions [141](#)
 - category 2 transactions [145](#)
 - category 3 transactions [152](#)
 - conditional access lists [69](#)
 - CRTE [232](#), [234](#), [263](#), [272](#)
 - defining profiles to RACF [68](#)
 - for IPIC connections [263](#)
 - for ISC over TCP/IP connections [263](#)
 - resource definition [233](#), [239](#), [263](#), [271](#)
 - started transactions [66](#), [81](#), [84](#)
 - transaction-attach security [66](#)
 - transactions started without terminals [82](#)
 - XJCT parameter [81](#), [84](#)
 - XPCT parameter [48](#), [74](#), [95](#)
 - XPCT-checked transactions [81](#), [84](#)
 - XTRAN system initialization parameter [68](#)
- transactions
 - in a CMAS
 - defining to RACF [172](#)
- transactions (*continued*)
 - in a MAS
 - defining to RACF [173](#)
 - Kerberos [417](#)
- transient data
 - access authorization levels [78](#)
 - CICS-required transient data queue resource definitions [79](#)
 - security considerations [77](#)
- transient data trigger-level transactions [115](#)
- trigger level transactions
 - default security for [35](#), [115](#)
 - specifying security for [70](#), [115](#)
- Triple DES
 - encryption algorithm [290](#)
- trust client
 - interface [389](#)
 - invoking [401](#)
- TSO command
 - refreshing using TSO command [18](#)
 - TSO commands and security processing [139](#)

U

- UACC [68](#)
- UCICSTST general resource class [86](#)
- universal access [68](#)
- UNIX authentication [335](#)
- untrusted certificate, marking [301](#)
- URIMAP definitions
 - surrogate security [116](#)
- URP_DISASTER response
 - to resource checker [339](#)
- URP_EXCEPTION response
 - to resource checker [339](#)
- URP_INVALID response
 - to resource checker [339](#)
- URP_OK response
 - to resource checker [339](#)
- user data
 - attach FMH5 and data
 - format [250](#)
 - GDS LL length
 - SFL1 and SFL2 lengths
 - TP LL length
- user exits
 - ICHRTX00 MVS router exit [153](#)
 - RACF parameter lists [161](#)
- user ID
 - security [367](#), [368](#)
 - security checking with CRTE [232](#), [234](#), [263](#), [272](#)
- user ID security
 - CICS-WebSphere MQ
 - adapter
 - transactions [407](#)
 - CKTI [408](#)
 - USER parameter on CICS JOB statement [32](#)
- user profile [2](#), [10](#), [253](#)
- user profiles
 - in RACF [11](#)
 - refreshing [209](#)
 - with ESM [252](#)
- user security
 - CICS default user [15](#)

- user security (*continued*)
 - for IPIC connections [261](#)
 - transaction routing [233](#), [272](#)
 - user profiles [11](#)
- user-defined classes [137](#)
- userid
 - ADDUSER to add default CICS userid [34](#)
 - controlling propagation of [44](#)
 - default [47](#)
 - defining CICS default user [34](#)
 - defining for CICS [32](#)
 - DFLTUSER parameter [47](#)
 - non-terminal started transaction [82](#)
 - of CICS region as security token [46](#)
 - surrogate job submission [45](#)
- userid of non-terminal started transaction [82](#)
- userid on DB2 AUTHID and COMAUTHID parameters [116](#)
- userid on URIMAP resource definitions [116](#)
- userid passed as parameter on EXCI calls [116](#)
- userids used in CICS [2](#)
- users, CICS [2](#)
- USRDELAY, system initialization parameter [270](#)

V

- validate [421](#)
- validating [421](#)
- VCICSCMD general resource class [128](#), [315](#)
- VERIFY parameter, ATTACHSEC operand [229](#)
- verifying
 - signatures [425](#)
- verifying remote users [230](#)
- views
 - security considerations [176](#)
- views protected by security profiles [181](#)
- VSAM data sets, and BWO [39](#)
- VSAM data sets, and Dynamic Volume Count [39](#)
- VSAM ESDSs, access to [39](#)
- VTAMAPPL general resource class
 - defining profiles [44](#)

W

- WARNING option [77](#)
- WCICSRES [26](#)
- WCICSRES grouping class [71](#), [92](#)
- web application
 - security [353](#)
- web services
 - configuring
 - Kerberos [416](#)
- Web Services Security (WSS) [385](#), [393](#), [397](#)
- WHEN operand of PERMIT
 - WHEN operand [57](#)

X

- XAPPC, system initialization parameter [48](#), [50](#), [74](#), [94](#), [223](#)
- XCICSDB2 general resource class [314](#)
- XCICSDB2 member class [314](#)
- XCMD system initialization parameter [336](#)
- XCMD, system initialization parameter [48](#), [74](#), [94](#), [128](#)
- XDB2, system initialization parameter [48](#), [74](#), [94](#)

- XDCT, system initialization parameter
 - considerations for triggered transactions [79](#)
- XFCT, system initialization parameter [48](#), [74](#), [80](#), [95](#)
- XHFS, system initialization parameter [48](#), [50](#), [74](#), [87](#), [88](#), [95](#)
- XJCT, system initialization parameter [48](#), [74](#), [80](#), [95](#)
- XPCT-checked transaction security [81](#), [84](#)
- XPCT, system initialization parameter [48](#), [74](#), [81](#), [84](#), [95](#)
- XPPT system initialization parameter [336](#)
- XPPT, system initialization parameter [48](#), [74](#), [85](#), [95](#)
- XPSB, system initialization parameter [48](#), [75](#), [90](#), [95](#)
- XRES, system initialization parameter [49](#), [71](#), [75](#), [92](#), [95](#), [371](#)
- XRF (extended recovery facility)
 - FORCE operand [12](#)
 - NOFORCE operand [12](#)
 - remaining signed on after takeover [12](#)
 - sign-off after takeover [12](#)
 - XRFSOFF operand [12](#)
- XTRAN, system initialization parameter [49](#)
- XTST, system initialization parameter [49](#), [75](#), [86](#), [95](#)
- XUSER system initialization parameter [336](#)
- XUSER, system initialization parameter
 - resource security
 - XUSER parameter [75](#), [95](#)
 - system initialization parameters, CICS
 - XUSER [75](#), [95](#)

Z

- z/OS Communications Server
 - generic resource names [43](#)
- z/OS Connect
 - Security [402](#)
- z/OS UNIX file security
 - access authorization levels [90](#)
 - XHFS parameter [87](#)
- z/OS UNIX files
 - security [367](#), [368](#)
- z/OS UNIX Systems
 - Services
 - security [367](#), [368](#)
- ZCICSDB2 grouping class [314](#)

