

IBM IMS Tools Base for z/OS  
1.7

*Autonomics Director User's Guide and  
Reference*



**Note:**

Before using this information and the product it supports, read the information in [“Notices” on page 155.](#)

**Sixth Edition (August 2024)**

This edition applies to Version 1.7 of IBM IMS Tools Base for z/OS (program number 5655-V93) and to all subsequent releases and modifications until otherwise indicated in new editions.

This edition replaces SC27-9853-04.

© **Copyright International Business Machines Corporation 2011, 2024.**

US Government Users Restricted Rights – Use, duplication or disclosure restricted by GSA ADP Schedule Contract with IBM Corp.

---

# Contents

- About this information..... vii**
  
- Chapter 1. Autonomics Director overview..... 1**
  - What's new in Autonomics Director..... 1
  - IBM IMS Tools Base for z/OS overview..... 3
  - Autonomics Director services and environments..... 3
  - Autonomics Director architecture and process flow.....6
  - Service updates and support information..... 7
  - Product documentation and updates..... 7
  - Accessibility features..... 8
  
- Chapter 2. Autonomics Director components..... 9**
  - Autonomics Director server..... 9
  - Autonomics Director scheduler..... 11
  - Autonomics Director monitor list..... 11
  - Autonomics Director user interface..... 12
  - Autonomics Director batch interface..... 12
  
- Chapter 3. Autonomics process..... 13**
  - Autonomics overview.....13
    - Passive autonomics..... 13
    - Active autonomics..... 14
  - Autonomics Director modes..... 15
    - On-demand mode..... 15
    - Automatic mode..... 16
  - Automatic database and CAGRP discovery..... 17
  - Sensor data collection..... 17
  - Policy evaluation..... 20
  - Database grouping..... 20
    - User-defined group-managed database reorganization..... 20
    - Group-managed change accumulation..... 21
  - Job scheduling structure..... 23
  - Sweep and cycle intervals..... 24
  
- Chapter 4. Installation and configuration..... 27**
  - Hardware and software prerequisites..... 27
  - Installing Autonomics Director..... 27
    - Verifying the installation..... 27
  - Configuring Autonomics Director..... 27
  
- Chapter 5. Starting the Autonomics Director client dialog..... 29**
  - Starting the Autonomics Director client interface..... 29
  - Setting up the Autonomics Director Client environment..... 30
  - Updating the client environment ..... 31
  - Establishing system settings..... 31
  
- Chapter 6. Managing the Autonomics Director server..... 33**
  - Stopping the Autonomics Director server..... 33
    - Stopping the server using the ISPF interface..... 33

Stopping the server using commands.....	33
Displaying the Autonomics Director server resources.....	35
Displaying server resources using the ISPF interface.....	36
Displaying server resources using the <b>DISPLAY</b> command.....	36
Refreshing the Autonomics Director server resources.....	39
Refreshing server resources using the ISPF interface.....	39
Refreshing server resources using the <b>REFRESH</b> command.....	39
<b>Chapter 7. Managing the scheduler.....</b>	<b>43</b>
Scheduler terminology.....	43
Defining the base period.....	44
Defining overrides to the base period.....	45
Editing base period definitions.....	48
Viewing the scheduling calendar.....	49
Suspending the Autonomics Director scheduler.....	51
Suspending the scheduler using the ISPF interface.....	52
Suspending the scheduler using the <b>SUSPEND</b> command.....	52
Resuming the Autonomics Director scheduler.....	53
Resuming the scheduler using the ISPF interface.....	53
Resuming the scheduler using the RESUME command.....	54
<b>Chapter 8. Managing the monitor list.....</b>	<b>57</b>
Adding or updating monitor list entries.....	57
Deleting monitor list entries.....	58
Changing monitor list entry ownership.....	59
Reading a resource name from the IMS directory .....	59
<b>Chapter 9. Scheduling and automating.....</b>	<b>61</b>
Scheduling a reorganization or area extension.....	61
Creating a user group.....	61
Deleting a user group.....	63
Adding databases to a user group.....	63
Modifying user group attributes.....	64
Activating or deactivating user groups.....	65
Scheduling on-demand reorganizations and area extensions.....	66
Pausing, continuing, or canceling reorganizations and area extensions.....	66
Viewing reorganization and area extension history of user-defined groups.....	67
Scheduling on-demand sensor data collection and policy evaluations.....	67
Automating monitoring and maintenance tasks.....	68
Viewing recommendations.....	69
Reference: Batch interface.....	70
<b>Chapter 10. Troubleshooting.....</b>	<b>77</b>
Runtime error messages (IAV).....	77
Database evaluation error messages .....	102
Abend codes.....	103
Sensor data extractor API return and reason codes.....	105
Frequently asked questions.....	106
Gathering diagnostic information.....	107
<b>Chapter 11. Reference: Business and usage scenarios.....</b>	<b>109</b>
Scenario: Creating a scheduling calendar that includes exceptions for the major US holidays.....	109
Scenario: Creating and activating a monitoring list.....	110
Scenario: Viewing exceptions by using IMS Administration Foundation.....	111
Scenario: Change accumulation passive autonomics using CAGRPs.....	112

<b>Chapter 12. Reference: Autonomics Director utilities.....</b>	<b>115</b>
Pre-scan Utility (IAVXSCAN).....	115
Policy Services Exception Reporting utility (IAVXTRCO).....	116
Monitor List Registration utility (IAVBUTLO).....	123
Running the Monitor List Registration utility.....	123
Example JCL for the Monitor List Registration utility.....	124
EXEC and DD statements for the Monitor List Registration utility.....	124
Control statements for the Monitor List Registration utility.....	125
Output from the Monitor List Registration utility.....	133
Return codes: Monitor List Registration utility.....	135
<b>Chapter 13. Reference: BPE commands.....</b>	<b>137</b>
BPE command syntax and invocation.....	137
BPE command invocation.....	137
BPE wildcard character support.....	138
Specifying command parameters.....	138
BPE TRACETABLE commands.....	139
DISPLAY TRACETABLE command.....	139
UPDATE TRACETABLE command.....	141
BPE USEREXIT commands.....	143
DISPLAY USEREXIT command.....	144
REFRESH USEREXIT command.....	148
<b>Chapter 14. Reference: How to read syntax diagrams.....</b>	<b>153</b>
<b>Notices.....</b>	<b>155</b>
<b>Index.....</b>	<b>159</b>



## About this information

---

IBM® IMS Tools Base for z/OS® Autonomics Director (also referred to as *Autonomics Director*) automates recurring database monitoring and maintenance tasks for IMS, including both automatic and on-demand scheduling of database sensor data collection and evaluation.

These topics provide instructions for installing, configuring, and using Autonomics Director.

To use these instructions, you must have already installed Autonomics Director by completing the instructions in the *Program Directory for IBM IMS Tools Base for z/OS* (GI10-8819), which is included with the product media and is also available on the IMS Tools Product Documentation page.

These topics are designed to help database administrators, system programmers, application programmers, and system operators perform the following tasks:

- Understand the capabilities of the functions that are associated with Autonomics Director
- Install and operate Autonomics Director
- Customize your Autonomics Director environment
- Diagnose and recover from Autonomics Director problems
- Use Autonomics Director with other IMS products

To use these topics, you should have a working knowledge of:

- The z/OS operating system
- ISPF
- SMP/E
- IMS

Always refer to the IMS Tools Product Documentation web page for complete product documentation resources:

<https://www.ibm.com/support/pages/node/712955>

The IMS Tools Product Documentation web page includes:

- Links to [IBM Documentation](#) for the user guides ("HTML")
- PDF versions of the user guides ("PDF")
- Program Directories for IMS Tools products
- Technical notes from IBM Software Support, referred to as "Tech notes"
- White papers that describe product business scenarios and solutions





---

# Chapter 1. Autonomics Director overview

IBM IMS Tools Base for z/OS Autonomics Director (also referred to as *Autonomics Director*) automates recurring database monitoring and maintenance tasks for IMS, including both automatic and on-demand scheduling of database sensor data collection and evaluation.

Autonomics Director is used by IBM IMS Database Solution Pack for z/OS, IBM IMS Database Utility Solution for z/OS, IBM IMS Fast Path Solution Pack for z/OS, and IBM IMS Recovery Solution Pack for z/OS to help you identify and administer the normal functions that are associated with maintaining the health and performance of IMS.

## Topics:

- [“What's new in Autonomics Director” on page 1](#)
- [“IBM IMS Tools Base for z/OS overview” on page 3](#)
- [“Autonomics Director services and environments” on page 3](#)
- [“Autonomics Director architecture and process flow” on page 6](#)
- [“Service updates and support information” on page 7](#)
- [“Product documentation and updates” on page 7](#)
- [“Accessibility features” on page 8](#)

---

## What's new in Autonomics Director

This topic summarizes the technical changes for this edition.

New and changed information is indicated by a vertical bar (|) to the left of a change. Editorial changes that have no technical significance are not noted.

Revision markers follow these general conventions:

- Only technical changes are marked; style and grammatical changes are not marked.
- If part of an element, such as a paragraph, syntax diagram, list item, task step, or figure is changed, the entire element is marked with revision markers, even though only part of the element might have changed.
- If a topic is changed by more than 50%, the entire topic is marked with revision markers (so it might seem to be a new topic, even though it is not).

Revision markers do not necessarily indicate all the changes made to the information because deleted text and graphics cannot be marked with revision markers.

### SC27-9853-05 - August 2024

Description	Related APARs
Provides an option to deallocate RECON data sets from the Autonomics Director server.	PH62387
The following topics have been updated:	
• <a href="#">“Refreshing server resources using the ISPF interface” on page 39</a>	
• <a href="#">“Refreshing server resources using the REFRESH command” on page 39</a>	

---

## SC27-9853-04 - October 2023

Description	Related APARs
Removed information related to IBM Management Console for IMS and Db2 for z/OS.	N/A

## SC27-9853-03 - May 2023

Description	Related APARs
Autonomics Director uses an internal table called the <i>exception definition table</i> to set appropriate severity in the case of an exception.  To avoid a situation of running the Autonomics Director server without the exception definition table available, the fix for this APAR causes the Autonomics Director server to end abnormally if, for some reason, the exception definition table is not available at the time of an exception.  This APAR adds the following error messages and abend subcodes: <ul style="list-style-type: none"><li>• New messages <a href="#">IAV0035E</a> and <a href="#">IAV0036E</a></li><li>• New abend subcodes X'80' and X'81' for abend code <a href="#">070</a></li></ul>	PH53507

## SC27-9853-02 - March 2023

Description	Related APARs
This enhancement enables automatic collection and evaluation of only Recovery Sensor data. The following topics have been added or updated: <ul style="list-style-type: none"><li>• Messages <a href="#">IAV0707I</a>, <a href="#">IAV0708I</a>, <a href="#">IAV8050E</a>, <a href="#">IAV8051E</a>, and <a href="#">IAV8067E</a></li><li>• <a href="#">“Example JCL for the Monitor List Registration utility” on page 124</a></li><li>• <a href="#">“ATTRIBUTE command” on page 126</a></li><li>• <a href="#">“Journal Messages report” on page 133</a></li><li>• <a href="#">“Monitor List Registration report” on page 134</a></li></ul>	PH52062

## SC27-9853-01 - January 2023

Description	Related APARs
General documentation changes. The following topics have been updated: <ul style="list-style-type: none"><li>• <a href="#">“IAV0705W” on page 85</a></li><li>• <a href="#">“070” on page 104</a></li></ul>	N/A

## SC27-9853-00 - July 2022

Description	Related APARs
Refreshed for IMS Tools Base 1.7. The following topic has been added: <ul style="list-style-type: none"><li>• <a href="#">“Scenario: Viewing exceptions by using IMS Administration Foundation” on page 111</a></li></ul>	N/A

## IBM IMS Tools Base for z/OS overview

---

IBM IMS Tools Base for z/OS (also referred to as IMS Tools Base) streamlines the delivery, implementation, and maintenance of common IMS Tools infrastructure components by consolidating all of these components into a single package.

IMS Tools Base provides a simplified and efficient delivery of common parts that are used by IMS Tools products. The components provide required infrastructure code for all IMS Tools key strategies, which include autonomics, rule-based programming, and GUI support.

Certain components, such as IMS Tools Online System Interface and IMS Tools Generic Exits, are used by some of the IMS Tools products to connect to an IMS system.

Additionally, IMS Tools Base includes components that are useful when they are widely deployed as part of an overall solution.

IMS Tools Base consists of the following components:

- IMS Tools Knowledge Base
- Autonomics Director
- Policy Services
- Distributed Access Infrastructure
- IMS Tools Common Services
  - IMS Tools Generic Exits
  - IMS Tools Online System Interface
- IMS Hardware Data Compression Extended

## Autonomics Director services and environments

---

Autonomics Director can help an IMS DBA (database administrator) identify and administer the normal functions that are associated with maintaining the health, performance, and recoverability of IMS.

### Autonomics services

Autonomics is a process that provides analysis of specific database state by evaluating stored sensor data and providing a response to any conditions that exceed the user-defined threshold values specified for this state.

Autonomics Director supports both passive and active autonomics capabilities:

- Passive autonomics
  - Automates ongoing database monitoring and evaluation.
  - Provides recommendations of actions that might be required.
- Active autonomics
  - Automates ongoing database monitoring and evaluation.
  - Automatically performs the recommended action.

Autonomics services features include:

### Flexible customization

A customization process that is based on automatic discovery of databases and existing database and change accumulation groups in your environment.

### Automatic discovery of databases and CAGRPs in your environment

Autonomics Director provides an automatic database discovery feature that identifies which databases and change accumulation groups (CAGRPs) are present in your IMS environment.

### **Automatic and on-demand collection and evaluation of sensor data**

Sensor data is collected to capture the status of databases for a specific point in time.

Database sensor data, used for reorganization, is captured information that represents the state of a database, and includes information about the organization of the data in the database, system catalog, VSAM catalog, and disk Volume Table of Contents (VTOC).

Sensor data that is collected by Autonomics Director is interchangeable with sensor data that is collected by IBM IMS Database Reorganization Expert for z/OS.

Sensor data, used for recovery preparedness, is collected from the RECON data set and DBRC.

### **Automatic and on-demand analysis of the state of your databases against user-defined threshold criteria**

You can request immediate or deferred data collection and policy evaluations.

### **Scheduling data collection and policy evaluation**

You can define parameters that control how frequently data is collected and how frequently policies are evaluated by Autonomics Director.

You can also restrict these operations so that they do not interfere with your production work.

### **Sysplex support and workload balancing**

Autonomics Director supports a sysplex mode of operations and workload balancing.

By using multiple redundant Autonomics Director servers, it is possible to provide failover support if an Autonomics Director server terminates for any reason.

Autonomics Director server redundancy also provides the ability to automatically distribute IMS Tools autonomic workload throughout your sysplex.

Autonomics Director automatically balances sensor and group-managed reorganization job streams throughout a sysplex to provide optimal use of system resources during the shortest period of time.

## **Managing autonomics through policy domains**

Autonomics Director offers powerful and flexible database monitoring services and supports specific policy-based domain environments.

A domain is a descriptive term used in autonomics and policy management to represent one or more IMS Tools products that share the same set of policies and rules that result in performing the same action type.

Every policy belongs to a policy domain. For example:

- All policies and rules that are used by the Smart Reorg utility of IMS Database Reorganization Expert belong to the REORG policy domain.
- All policies and rules that are used by the IMS Recovery Solution Pack for database backup and recovery preparedness belong to the RECOVERY policy domain.

A policy domain is not specific to a particular IMS Tools product. Rather, the domain is associated with a specific system management function (such as reorganization, backup, recovery, performance).

Currently the REORG and RECOVERY domains are the policy domains that are supported by Autonomics Director.

### **REORG domain environment**

The REORG domain is composed of data elements, rules, exceptions, and policies that are used to provide recommended actions for database maintenance and health operations.

The REORG domain data sensors are provided by the IMS Database Solution Pack, IMS Database Utility Solution, and IMS Fast Path Solution Pack products.

REORG domain features include:

## Reorganizations of IMS databases

Using policies based on user-defined threshold criteria, Autonomics Director provides recommendations for the reorganization of databases, partitions, and areas, and automatically initiates reorganizations.

## Database health evaluations through sensor data content by using Policy Services

You can define policies and rules in Policy Services, which Autonomics Director uses when it evaluates the most recent database sensor data.

The policies are stored in IMS Tools Knowledge Base and are accessed by Autonomics Director indirectly through Policy Services.

## IOVF and SDEP extensions of Fast Path DEDB areas

Based on policies that are defined by the user, Autonomics Director provides recommendations for extending the independent overflow (IOVF) and sequential dependent (SDEP) portions of Fast Path DEDB areas and automatically initiates these processes.

## RECOVERY domain environment

The RECOVERY domain is composed of data elements, rules, exceptions, and policies that are used to provide recommended actions for recovery and backout preparedness. RECOVERY domain autonomics specifically identifies:

- Databases that require an image copy.
- Change accumulation groups that require the change accumulation utility to be run.

The RECOVERY domain data sensor is provided by the IMS Recovery Solution Pack product.

RECOVERY domain features include:

### Recovery exceptions for IMS databases and change accumulation

Using policies based on user-defined threshold criteria, Autonomics Director provides recommendations for efficient backup and recovery preparedness of databases, partitions, areas, and change accumulations.

### RECOVERY domain exceptions

Table 1. Exceptions for the RECOVERY policy domain

Exception class	Exception description	Originating rules
IMAGE_COPY_NEEDS_TO_BE_TAKEN	At least one data set needs an image copy.	<ul style="list-style-type: none"><li>• IBM.HRS_SINCE_LASTIC</li><li>• IBM.IC_NEEDED</li><li>• IBM.IC_RECOMMENDED</li></ul>
NOT_A_MEMBER_OF_ANY_CAGRP	One or more data sets do not belong to any CAGRP.	IBM.NOT_IN_CAGRP
DATABASE_NEEDS_TO_BE_RECOVERED	The database, partition, or area needs recovery.	<ul style="list-style-type: none"><li>• IBM.RECOV_NEEDED</li><li>• IBM.EEQE_COUNT</li></ul>
DATABASE_NEEDS_TO_BE_BACKED_OUT	The database updates need to be backed out.	IBM.BACKOUT_NEEDED
CHANGE_ACCUM_NEEDS_TO_BE_DONE	A new change accumulation is needed for the CAGRP.	IBM.HRS_SINCE_LASTCA

## Autonomics Director architecture and process flow

The Autonomics Director environment is composed of several IMS Tools components.

A typical environment for running Autonomics Director requires the following components:

- Policy Services
- IMS Tools Knowledge Base
- IMS Solution Packs Database Sensor

The following figure illustrates the environment and the process flow for using Autonomics Director.

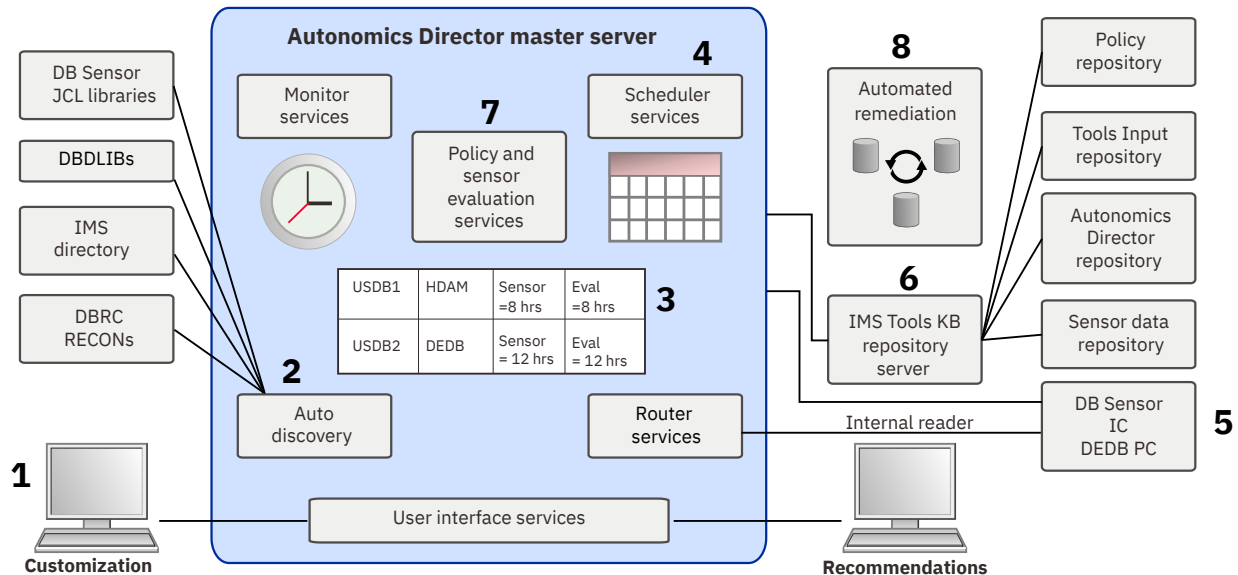

Figure 1. Autonomics Director process flow

The following process flow steps match the numbers in the figure:

1. The user customizes the Autonomics Director environment by using the Autonomics Director ISPF interface and server startup parameters.
2. Autonomics Director collects database and group information from the DBD libraries and the RECON data sets. If the IMS-managed ACBs function is enabled, it collects the information from the IMS directory.
3. The user creates a monitor list of group and database names with attributes that are saved in the Autonomics Director repository and are available for monitoring.
4. The user defines parameters that control how frequently data is collected and policies are evaluated by Autonomics Director.  
The user can also schedule immediate and deferred data collection and policy evaluations.
5. Sensor data is collected to capture the status of databases at a specific point in time.  
The user can also request that Autonomics Director submit a batch job to collect the most up-to-date sensor data.
6. Policies and rules that are defined by Policy Services are stored in the IMS Tools Knowledge Base and are accessed by Autonomics Director. Results from the database evaluations are stored in the Autonomics Director repository and are accessed during inquiries from the client.
7. Autonomics Director uses policies and rules that are defined in Policy Services to evaluate against the most recent database sensor data.

8. Autonomics Director automatically initiates reorganization when the reorganization interval specified for a user group passes and the resources in the user group need reorganization.

Optionally, Autonomics Director also initiates the recommended IOVF extensions or SDEP extensions on the Fast Path DEDB areas in the user group at that time.

9. Autonomics Director automatically detects REORG and RECOVERY domain exceptions and provides messages and online panels to display these exceptions.

## Service updates and support information

---

Service updates and support information for this product, including software fix packs, PTFs, frequently asked questions (FAQs), technical notes, troubleshooting information, and downloads, are available from the web.

To find service updates and support information, see the following website:

[IBM Support: IMS Tools Base for z/OS](#)

## Product documentation and updates

---

IMS Tools information is available at multiple places on the web. You can receive updates to IMS Tools information automatically by registering with the IBM My Notifications service.

### Information on the web

Always refer to the IMS Tools Product Documentation web page for complete product documentation resources:

<https://www.ibm.com/support/pages/node/712955>

The IMS Tools Product Documentation web page includes:

- Links to [IBM Documentation](#) for the user guides ("HTML")
- PDF versions of the user guides ("PDF")
- Program Directories for IMS Tools products
- Technical notes from IBM Software Support, referred to as "Tech notes"
- White papers that describe product business scenarios and solutions

IBM Redbooks® publications that cover IMS Tools are available from the following web page:

<http://www.redbooks.ibm.com>

The IBM Information Management System website shows how IT organizations can maximize their investment in IMS databases while staying ahead of today's top data management challenges:

<https://www.ibm.com/software/data/ims>

### Receiving documentation updates automatically

To automatically receive emails that notify you when new technote documents are released, when existing product documentation is updated, and when new product documentation is available, you can register with the IBM My Notifications service. You can customize the service so that you receive information about only those IBM products that you specify.

To register with the My Notifications service:

1. Go to <http://www.ibm.com/support/mynotifications>
2. Enter your IBM ID and password, or create one by clicking **register now**.
3. When the My Notifications page is displayed, click **Subscribe** to select those products that you want to receive information updates about. The IMS Tools option is located under **Software > Information Management**.

4. Click **Continue** to specify the types of updates that you want to receive.
5. Click **Submit** to save your profile.

## How to send your comments

Your feedback is important in helping us provide the most accurate and highest quality information. If you have any comments about this or any other IMS Tools information, see [How to provide feedback in IBM Documentation](#).

When you provide feedback, include as much information as you can about the content you are commenting on, where we can find it, and what your suggestions for improvement might be.

## Accessibility features

---

Accessibility features help a user who has a physical disability, such as restricted mobility or limited vision, to use a software product successfully.

The major accessibility features in this product enable users to perform the following activities:

- Use assistive technologies such as screen readers and screen magnifier software. Consult the assistive technology documentation for specific information when using it to access z/OS interfaces.
- Customize display attributes such as color, contrast, and font size.
- Operate specific or equivalent features by using only the keyboard. Refer to the following publications for information about accessing ISPF interfaces:
  - *z/OS ISPF User's Guide, Volume 1*
  - *z/OS TSO/E Primer*
  - *z/OS TSO/E User's Guide*

These guides describe how to use the ISPF interface, including the use of keyboard shortcuts or function keys (PF keys), include the default settings for the PF keys, and explain how to modify their functions.



---

## Chapter 2. Autonomics Director components

The following topics describe the major components of the Autonomics Director product.

### Topics:

- [“Autonomics Director server” on page 9](#)
- [“Autonomics Director scheduler” on page 11](#)
- [“Autonomics Director monitor list” on page 11](#)
- [“Autonomics Director user interface” on page 12](#)
- [“Autonomics Director batch interface” on page 12](#)

---

### Autonomics Director server

The Autonomics Director server is responsible for the control and flow of the Autonomics Director environment.

Autonomics Director has two types of servers: a master server, and active and failover servers.

#### Master server

The master server coordinates all functions of the Autonomics Director environment, communicates with the Autonomics Director user interface, and distributes requests for sensor collection and reorganization job streams to the other Autonomics Director servers within the Autonomics Director server group. Within a server group, one of the Autonomics Director servers automatically assumes the role of the master server.

When multiple Autonomics Director servers are present, the master server is dynamically selected from the group. Selection is determined by which Autonomics Director server becomes available first. If the master server terminates for any reason, the next available server assumes the role of master server.

#### Active and failover servers

An active server is one that actively participates in the Autonomics Director environment by processing requests for sensor data collection and for reorganization. Additionally, any active server can be the master server. A failover server is optimized for environments that require high-availability, but do not support the distribution of sensor collection and reorganization workload within the Autonomics Director server group. A failover Autonomics Director server serves as a standby for the master server.

Autonomics Director servers are configured as either active or failover.

The failover server is normally inactive, but assumes the role of the master server when it detects the termination of the master server. Any combination of active and failover servers within an Autonomics Director server group is supported. For example, when an Autonomics Director failover server detects other active Autonomics Director servers within the group, and the master server terminates, the failover server allows the other active servers to take over as the master server.

For more information about configuring Autonomics Director active and failover server modes, see the `MODE=` parameter description in the *IMS Tools Base Configuration Guide*.

The Autonomics Director server environment contains one or more Autonomics Director server address spaces that operate with each other on a single LPAR or sysplex environment.

Autonomics Director requires the use of at least one server, but supports the use of multiple servers for both workload distribution and high availability. For example, if one of the Autonomics Director servers is terminated or an LPAR becomes unavailable, Autonomics Director is still able to function without interruption.

The collection of Autonomics Director servers that work together to support a single Autonomics Director environment is referred to as an *Autonomics Director server group*. When multiple Autonomics Director servers are used within multiple LPARs in a sysplex, Autonomics Director distributes the running of sensor collection and reorganization job streams that it initiates among these LPARs.

The algorithm that Autonomics Director uses for workload distribution is based on either the MVS™ Workload Management (WLM) routing services or on a simple round-robin distribution model, which you implement as a configuration option. Autonomics Director uses recommendations from WLM to determine the best location to submit sensor collection job streams. The round-robin distribution algorithm distributes sensor collection job streams evenly among the LPARs where Autonomics Director servers are located. For more information about configuring WLM for Autonomics Director, see the WLMPRINT= parameter description in the *IMS Tools Base Configuration Guide*.

The following diagram illustrates the master, active, and failover servers in an Autonomics Director environment:

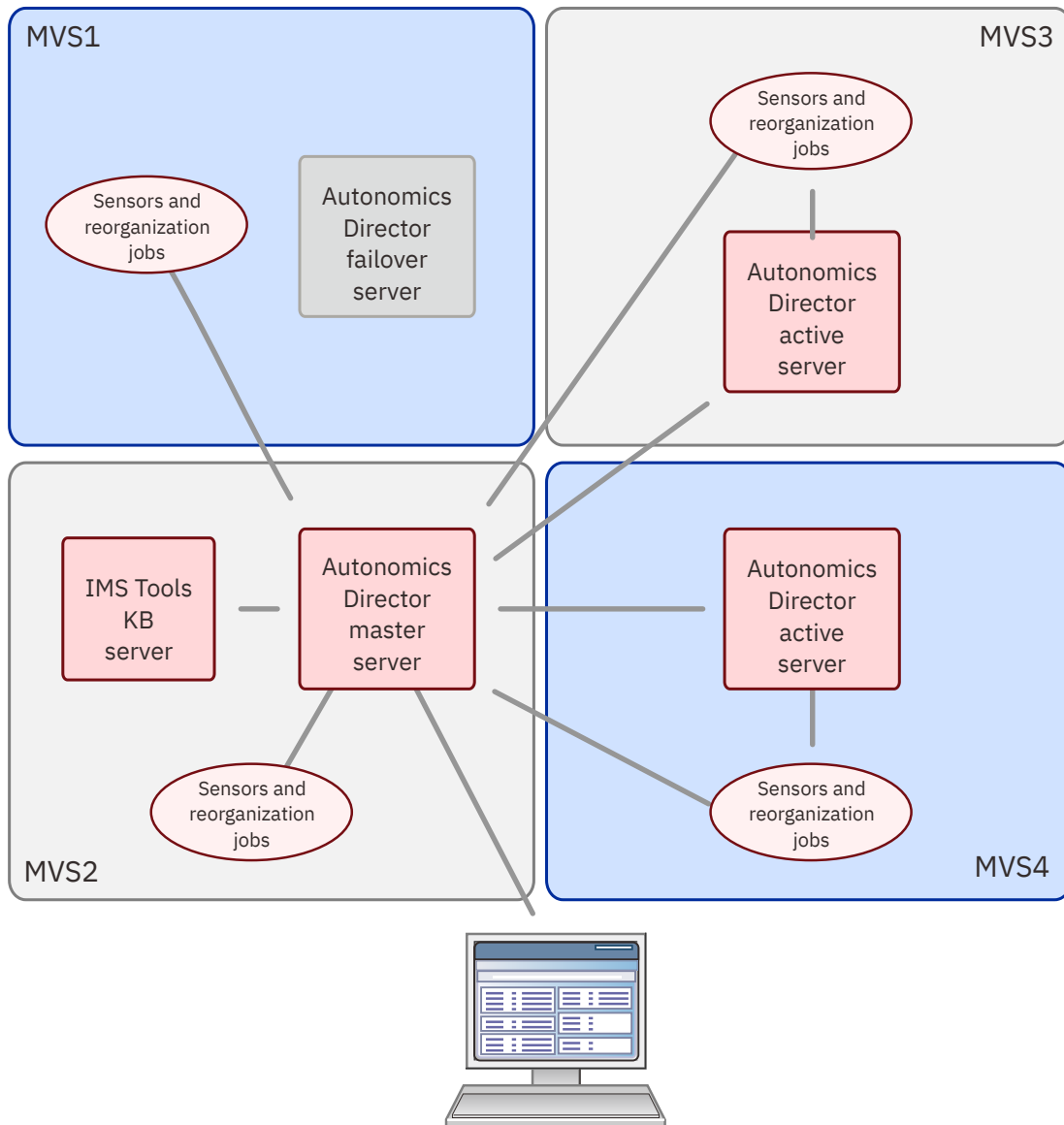

Figure 2. Autonomics Director server environment

## Autonomics Director scheduler

---

You can use the Autonomics Director scheduler to schedule automatic REORG and RECOVERY sensor data collection, policy evaluations, reorganizations, IOVF extensions, and SDEP extensions that are based on user-defined time periods.

Data collections, policy evaluations, and reorganizations can be performed on a database, partition, or area. IOVF and SDEP extensions can be performed on Fast Path DEDB areas.

For sensor data collection and policy evaluations, you can establish a peak period during which sensor data collection and policy evaluations cannot take place, to ensure that Autonomics Director does not administer sensor data collection or evaluation during your peak production workload.

For reorganizations and area extensions, you can establish a maintenance period, during which these processes can take place, and then assign that maintenance period to a specific user group.

Autonomics Director automated scheduling is optional. You can issue on-demand sensor data collections, policy evaluations, reorganizations, and area extensions through AD batch (IAVBATCH) directly or through your existing job scheduler.

You can also use your existing job scheduler to introduce DB sensor, image copy, or pointer checker jobs into your system without involving Autonomics Director.

## Autonomics Director monitor list

---

The Autonomics Director monitor list is a set of database and database partition names that are available for monitoring.

These resources might or might not be registered with DBRC or belong to any DBRC group.

The resources are added to the monitor list through the Autonomics Director automatic discovery feature.

**Restriction:** Autonomics Director automatic discovery can locate only the master DBD.

The TSO user ID that is logged in when resources are added to the Autonomics Director monitor list becomes the owner ID of these resources. Autonomics Director automated jobs are submitted by using the owner ID, so this user ID must have proper RACF® authority.

The monitor list can contain the following types of resources:

### Registered databases

A database can be registered in the RECON as a member of the DBRC groups or without being a member of any DBRC group.

### HALDB database partitions and Fast Path DEDB areas

Many database utilities can operate on a HALDB partition or a Fast Path DEDB area without having to operate on the entire database.

For example, a HALDB partition or a Fast Path DEDB area can be reorganized independently of other partitions or areas.

### Unregistered databases

For consistency, such independent databases are considered to belong to a group called \$NONAME\$.

## Populating the monitor list

To populate the monitor list, you use the Autonomics Director automatic discovery through the Autonomics Director automatic discovery ISPF dialog. You can view a list of resources and DBRC groups in your environment through the automatic discovery ISPF dialog list. From that list, you can select resources and groups, and supply monitoring parameters.

The parameters include sensor data collection frequency, the job control language (JCL) member name for sensor collection (see note), the policy name or type for REORG and RECOVERY, and evaluation frequency. From then on, Autonomics Director automatically collects sensor data, evaluates the sensor data against the defined policy, and sends recommendations.

**Note:** A sensor member name with a maximum of seven characters is recommended. The specified member name is used for REORG sensor collection. Another member with the same name appended with a Y is used for RECOVERY sensor collection.

To add or update multiple entries at once, you can use a batch utility called the Monitor List Registration utility (IAVBUTLO). For details, see [“Monitor List Registration utility \(IAVBUTLO\)”](#) on page 123.

Autonomics Director automatic discovery obtains information about your resources from the DBD libraries that you define to the IMS Tools Knowledge Base (ITKB) RECONID configuration. Similarly, automatic discovery obtains more information about DBRC groups, HALDB partitions, and FP DEDB areas from the DBRC RECON data sets defined to ITKB.

## Autonomics Director user interface

---

You can use the Autonomics Director user interface to access Autonomics Director data from a TSO/ISPF environment.

You can use the Autonomics Director user interface to perform the following functions:

- Display the number of databases with exceptions in all (or a selected) RECON data sets
- Display exceptions in a selected RECON data set
- Display Policy Services evaluation details for a selected exception
- Schedule automatic data collection and policy evaluations
- Initiate automatic discovery of IMS databases
- Select and customize databases and DBRC database groups to be defined to the monitoring list
- Initiate on-demand sensor data collection and policy evaluation for databases
- View recommendations and detailed reports
- Define the scheduling calendar to restrict operations to specific time periods
- Query any defined database in the monitor list by attributes such as database type, evaluation interval, policy name, and so on.
- Define and manage user groups
- Manage and view group reorganization and Fast DEDB area extension activity
- Manage and view change accumulation groups (CAGRP) and CAGRP collections.
- Schedule a reorganization on demand
- Schedule an SDEP or IOVF extension for Fast DEDB areas on demand
- Display and control the server environment using operator commands

You can run the Autonomics Director user interface on the same z/OS system or any z/OS system that is located within the same sysplex as the Autonomics Director server.

## Autonomics Director batch interface

---

Autonomics Director provides the batch client interface (IAVBATCH) to submit a selected subset of client commands.

You can use the batch interface to request on-demand sensor data collection, policy evaluation, and group-managed reorganization.

Client commands submitted through the batch interface can also be used with customer's external job schedules.

---

## Chapter 3. Autonomics process

Autonomics is a process that provides analysis of specific database state by evaluating stored sensor data, and by providing a response to any conditions that exceed the user-defined threshold values specified for this state.

### Topics:

- [“Autonomics overview” on page 13](#)
- [“Autonomics Director modes” on page 15](#)
- [“Automatic database and CAGRP discovery” on page 17](#)
- [“Sensor data collection” on page 17](#)
- [“Policy evaluation” on page 20](#)
- [“Database grouping” on page 20](#)
- [“Job scheduling structure” on page 23](#)
- [“Sweep and cycle intervals” on page 24](#)

---

### Autonomics overview

Autonomics Director has both passive and active autonomics features to help you manage IMS databases.

Passive autonomics features periodically check the state of a database and recommend actions to take.

Active autonomics features check the state of a database and carry out the recommended actions.

Passive autonomics work in both REORG and RECOVERY domains. Active autonomics work in the REORG domain.

Autonomics Director supports both passive and active autonomics for reorganizations on IMS full-function databases, HALDB partitions, and Fast Path DEDB areas. Passive and active autonomics for IOVF and SDEP extensions on Fast Path DEDB areas are also supported.

You can use a combination of passive and active autonomics with different databases to achieve your specific business needs.

The following factors influence whether Autonomics Director schedules evaluations, reorganizations, or area extensions by using both passive and active autonomics features:

- Evaluation interval
- Sensor data maximum age
- Peak period definitions

For active autonomics, the reorganization interval and database maintenance period definitions are also factors.

For active autonomics on Fast Path DEDB areas, the values specified for the SDEP extension and IOVF extension user group attributes are additional factors.

### Passive autonomics

Passive autonomics features in Autonomics Director include recommendations for database reorganizations and SDEP or IOVF extensions to Fast Path DEDB areas. These recommendations can be viewed through the ISPF interface or IMS Administration Foundation for z/OS.

Passive autonomics features can be activated for all or a subset of databases in your environment. You can select Database Recovery Control Facility (DBRC) groups or user-defined groups to monitor the databases in the group. You can apply a set of parameters as defaults to the entire group, and then selectively override those parameters for individual databases in the group.

## Schedules for passive autonomics

Passive autonomics features operate on a schedule that you define for each database through the Autonomics Director ISPF interface. The Autonomics Director scheduler uses your schedule to determine when Autonomics Director runs sensor data collection and initiates policy evaluations.

Sensor data collection is a read-only process, so sensor collection jobs can run concurrently with IMS system access. An exception is running High Performance Image Copy to obtain a non-concurrent image copy. In this case, the update to the database must be stopped.

You can use the Autonomics Director schedule to define peak periods during which Autonomics Director does not schedule sensor data collection. Autonomics Director schedules around the peak period to avoid contention with your IMS system.



**Attention:** Running database sensor collection during heavy production activity can create unwanted contention with your production workload.

The Autonomics Director schedule is flexible. You can both establish and interrupt a baseline schedule. For example, you can specify a peak period of 9:00 AM through 5:00 PM daily without an end date. You can then specify overrides for weekends with peak periods from 9:00 AM through 12:00 PM.

You can also provide more overrides for end-of-month runs, end-of-year runs, holidays, specific dates, and so on. Without customization, the Autonomics Director passive autonomics schedule provides no peak periods and sensor data collection is unrestricted.

## Active autonomics

Active autonomics features in Autonomics Director are implemented for the REORG domain. They periodically collect and evaluate sensor data, make recommendations, and send notifications.

Active autonomics is similar to passive autonomics in that it uses the same facilities for monitoring the state of a database.

When active autonomics features are enabled, Autonomics Director uses recommendations that are made by passive autonomics features to initiate the reorganization and Fast Path DEDB area extension processes.

Autonomics Director active autonomics is implemented through user groups. Management of multiple databases, partitions, or areas is useful when the group contains databases with external logical relationships.

### Example: Automatically initiating the reorganization and DEDB area extension processes

You can use Autonomics Director active autonomics features to automatically initiate the reorganization and area extension processes.

Before you can use active autonomics features, you must configure Autonomics Director:

- Create peak periods for sensor data collection and evaluation. In this example, a peak period is Monday through Friday, 8:00 AM through 5:00 PM.
- Add databases to the monitor list. In this example, the evaluation interval is seven days.
- Create database maintenance periods. In this example, a maintenance period is Saturday, 6:00 PM through 11:00 PM.
- Define a user group and enable the attributes for automatic reorganizations, SDEP area extensions, and IOVF area extensions.

In this example, MYGROUP contains databases DBA, DBB, and DBC, and Fast Path DEDB areas AREA1, AREA2, and AREA3.

You must activate MYGROUP to enable it for group-managed reorganization, SDEP extensions, and IOVF extensions.

As a result of your definitions, Autonomics Director administers the following actions:

1. Sometime on Friday after 5:00 PM, Autonomics Director automatically initiates a sensor data collection and evaluation for each of the databases, partitions, and areas in MYGROUP.
  2. The evaluation determines that AREA1, DBA, and DBB need to be reorganized, but DBC, AREA2, and AREA3 do not.
 

Autonomics Director marks its recommendation for AREA1, DBA, and DBB to **Reorganization Needed**. These recommendations are available in the Autonomics Director monitor list.
  3. The evaluation also determines that AREA2 needs an IOVF extension and AREA3 needs an SDEP extension.
 

Autonomics Director marks its recommendation for AREA2 to **IOVF extension needed** and AREA3 to **SDEP extension needed**. These recommendations are available in the Autonomics Director monitor list.
  4. Sometime at or after 6:00 PM on Saturday, Autonomics Director determines that resources in MYGROUP require reorganization and Fast Path DEDB areas in MYGROUP require extensions.
    - Autonomics Director schedules reorganization jobs for DBA and DBB. These jobs all run in parallel. Because DBC does not require reorganization, if the SCAN job is present, no reorganization job is scheduled for DBC.
    - Autonomics Director submits the Online Space Management utility to process the reorganization of AREA1, IOVF extension of AREA2, and SDEP extension of AREA3.
  5. The reorganization completes for DBA, and Autonomics Director is notified.
 

As part of the reorganization of DBA and DBB, IMS Database Reorganization Expert drives IMS High Performance Image Copy (HPIC) to create an image copy of the reorganized database. Because HPIC contains an integrated database sensor, new sensor data is collected for the database.
  6. The reorganization completes for DBB and Autonomics Director is notified.
 

The same actions occur for DBB as occurred for DBA in step “5” on page 15.
  7. The reorganization of AREA1, IOVF extension of AREA2, and SDEP extension of AREA3 completes. Autonomics Director is notified.
 

As part of the reorganization and extensions (SDEP and IOVF) of the Fast Path DEDB areas, the Online Space Management utility instructs the database sensor to collect new sensor data for the database and notifies Autonomics Director that new sensor data is available for the database. Autonomics Director evaluates the new sensor data.
  8. Autonomics Director recognizes that the reorganization or extension job was submitted and ended normally for each database or Fast Path DEDB area for which either action was recommended and considers the work for the group complete.

## Autonomics Director modes

---

You can use Autonomics Director in either automatic mode or on-demand mode.

### On-demand mode

On-demand mode is used for ad hoc sensor data collection and policy evaluation. You can request immediate or delayed data collection and policy evaluations for both REORG and RECOVERY domains.

In on-demand mode, you request services through the Autonomics Director ISPF interface.

You can also override several of the parameter specifications that were defined for the database during registration.

In on-demand mode, either conditional or unconditional reorganizations and area extensions can be selected.

- On-demand conditional reorganizations and area extensions use the most recently collected sensor data and evaluation to determine whether a reorganization or area extension is necessary for the group.
- On-demand unconditional requests are processed regardless of any sensor data or evaluation.

For unconditional requests, the default values specified for the IOVF and SDEP options determine whether IOVF or SDEP extensions take place.

## Automatic mode

When Autonomics Director runs in automatic mode, sensor data collection and policy evaluation are fully automated. You can define the peak workload schedule and the maintenance schedule.

Autonomics Director schedules REORG and RECOVERY sensor data collection outside of your defined peak production time periods. You can run sensor data collection in parallel with database updates. However, doing so can result in conflicts between the processes that might affect database response time and throughput.

Autonomics Director determines when to collect sensor data and perform database evaluations by using the defined parameters for the monitored database. You specify the frequency of these tasks when you register a database to Autonomics Director.

The evaluation interval that you define determines the number of elapsed days, hours, and minutes between policy and database evaluations.

The sensor age specification determines the maximum acceptable age of the sensor data that can be used for policy evaluation.

Before a database evaluation is scheduled, Autonomics Director examines the age of the most recent sensor data that was collected for the database. If the sensor data is older than the defined maximum age, Autonomics Director schedules a sensor data collection job stream.

Autonomics Director initiates a REORG and RECOVERY policy evaluation periodically based on the evaluation interval specified for the database.

Evaluation is also performed after a sensor data collection is finished if AUTOEVAL=(Y) is specified on the monitored database. Specifying AUTOEVAL=(Y) is the recommended setting. RECOVERY sensor collection always uses AUTOEVAL=(Y).

### Important:

- You can run an evaluation immediately following a sensor data collection run, regardless of the evaluation interval.
- If AUTOEVAL=(Y) is specified on the monitored database, the database is automatically evaluated whenever new sensor data notification is received for that database.

## Job submission and started tasks

Autonomics Director automatically submits jobs for sensor data collection and reorganization using JCL that you create and maintain.

Autonomics Director supports the use of both private JCL libraries for jobs that are submitted to the internal reader and JES Procedure Libraries (PROCLIBs) for initiation of started tasks.

You can choose between job submission or started task initiation that is based on your specification of the JCL source to Autonomics Director.

- If you specify a fully qualified data set and member name, Autonomics Director submits the job to the internal reader.
- If only a member name is specified, Autonomics Director issues an MVS **START** command for that member name to initiate the work as a started task.

When you submit a job to the internal reader, Autonomics Director associates a RACF ID with the submitted job. You can use the following table to determine the RACF ID for the submitted job.



Table 2. Submitted jobs RACF ID table

Submitted job	RACF ID
On-demand sensor data collection or on-demand reorganization	The TSO user's logon ID
On-demand batch services	The batch job submitter's user ID
On-demand group-managed reorganization	The TSO user's ID on the on-demand REORG issuer
On-demand SDEP or IOVF extension for Fast Path DEDB areas	
Automatically scheduled sensor data collection	The ID of the owner of the database resource recognized by Autonomics Director
Automatically scheduled reorganization	The group owner's ID
Automatically scheduled SDEP or IOVF extensions for Fast Path DEDB areas	

The associated RACF ID must have the appropriate access to open and read the JCL library that contains the job to be submitted. The RACF ID must also have the appropriate level of access for the resources that are accessed by the submitted job.

Autonomics Director does not associate a RACF ID with any work that is initiated as a started task, because MVS does not provide this capability.

## Automatic database and CAGRP discovery

Autonomics Director automatically collects database and group information about your IMS environment, including DBDLIB and RECON. If the IMS-managed ACBs function is enabled, it collects the information from the IMS directory.

Auto discovery is the process of identifying which database resources are present in the IMS environment and are potential candidates for autonomics monitoring.

The following DBRC group types are supported:

- DBGRP
- DBDSGRP
- CAGRP
- RECOVGRP

User groups defined for Autonomics Director and databases that do not belong to any group are also supported.

**Important:** Autonomics Director auto-discovery can locate only the master DBD.

## Sensor data collection

Autonomics Director collects and makes recommendations or initiates database reorganizations and area extensions based on *sensor data*.

### Sensor data and Data Sensor components

Sensor data is the information collected by a Data Sensor component when, at an instance in time, it scans one or more IMS database environments and measures the specified conditions (or states) occurring in those environments.

Sensor data can contain information about database space usage, fragmentation, segment geography, database organization, the system catalog, the VSAM catalog, and the disk Volume Table Of Contents (VTOC).

Data Sensors store data in the IMS Tools Knowledge Base sensor data repository. The amount of data that is stored is limited to approximately 1 KB of data per sensor collection.

The stored data can be used by Autonomics Director, Policy Services, and IMS Administration Foundation for database analysis, tuning purposes, and evaluations required by the autonomics process.

Data Sensor also prints the stored data in a report, and stores the report in the Output repository of IMS Tools Knowledge Base.

IMS Tools provides three Data Sensor components:

- Full-Function Database Sensor (stand-alone and integrated)
- Fast Path Database Sensor (stand-alone and integrated)
- Recovery Sensor (stand-alone only)

### **Stand-alone data sensor**

Autonomics Director can initiate sensor data collection either automatically or manually by using a *stand-alone data sensor*. A stand-alone data sensor is a sensor that exists for the sole purpose of gathering information about a database. A stand-alone data sensor must be configured and run as a separate job.

IMS Database Solution Pack and IMS Database Utility Solution provide the Full-function Stand-alone DB Sensor (also referred to as FF Stand-alone DB Sensor) component.

IMS Fast Path Solution Pack provides the Fast Path Stand-alone DB Sensor (also referred to as FP Stand-alone DB Sensor) component.

IMS Recovery Solution Pack provides the Stand-alone Recovery Sensor (also referred to as Recovery Sensor) component, which can collect statistics on image copies, change accumulations, and recoverability of the databases from the content of DBRC RECON data sets.

### **Integrated data sensor**

Sensor data can also be collected by using an *integrated data sensor*. Integrated data sensors are efficient because they collect sensor data as a by-product of main utility processes such as pointer checking and image copy. Integrated data sensors are run and controlled at the product level.

The following IMS Tools products provide an integrated data sensor that can collect sensor data with minor modifications to the standard JCL statements for these products:

- IMS Database Solution Pack: IBM IMS High Performance Pointer Checker for z/OS
- IMS Database Solution Pack: IBM IMS High Performance Image Copy for z/OS
- IMS Database Utility Solution: IBM IMS High Performance Image Copy for z/OS
- IMS Fast Path Solution Pack: IMS High Performance Fast Path Utilities

### **Sensor data collection notification**

After sensor data is collected for a database, the sensor program notifies Autonomics Director of the availability of new sensor data. This notification allows Autonomics Director to then analyze the data and generate recommendations for the database.

You must enable the notifications from both integrated sensors and stand-alone sensors by adding a utility parameter that identifies the target Autonomics Director server to be notified of new sensor data.

**Important:** You must configure the sensor job streams to enable Autonomics Director notifications. For details, see the description of the ADXCFGRP parameter for the product that collects the sensor data.

## Sensor data collection initiated by Autonomics Director

Autonomics Director provides automated sensor data collection. You can choose automatic sensor data collection when you register a database with Autonomics Director by specifying an acceptable sensor data age for autonomic analysis.

Additionally, you specify the name of the data set that contains the sensor data collection job stream to be submitted to the internal reader by Autonomics Director.

**Restriction:** The JCL in the job stream must be for a stand-alone sensor. Autonomics Director does not initiate sensor data collection through integrated database sensors.

During submission of the data collection job stream, Autonomics Director performs some limited editing of the JCL for you. The values within the table can be used for sensor data collection job streams.

If you code the following symbols in the job stream, Autonomics Director makes symbolic substitutions.

*Table 3. Symbolic variables for sensor data collection job streams*

Symbolic variable	Value
\$DBNAME\$	The name of the database that data is being collected for.
\$PANAME\$	The HALDB partition or DEDB area name that data is being collected for.
\$ARNAME\$	The alias for \$PANAME\$.
\$USNAME\$	The user ID of the owner of the DB resource or group resource for scheduled requests. The user ID of the requester for on-demand requests. This variable can also be used for reorganization job streams.

By using substitutions, you can reuse the same JCL or JCL member for multiple databases. Autonomics Director does not validate the JCL content or syntax.

When Autonomics Director opens the data set that contains the user-identified data collection or reorganization and area extension job stream, it uses the TSO, RACF, or SAF user ID that was used during the database registration with Autonomics Director. This ID is also referred to as the owner ID. This user ID must have the correct RACF or SAF authorization to read this data set.

When Autonomics Director opens the internal reader to submit the data collection or reorganization job stream, it uses the same TSO, RACF, or SAF user ID that was used during the database registration with Autonomics Director. This user ID must have the correct RACF or SAF authorization to access the resources that are defined in the job stream.

When a data collection or a reorganization and area extension job stream is submitted to the internal reader, Autonomics Director extracts the job name and JES job number for display on the user interface.

## On-demand sensor data collection

You can use other job schedulers, existing automated and manual processes, or the TSO/ISPF client interface to initiate sensor data collection.

Additionally, any combination of automated and user-initiated sensor data collection is supported.

You can also initiate on-demand reorganizations and area extensions by using the same process.

## Policy evaluation

---

Autonomics Director evaluates the most recent database sensor data against your defined policies and rules, recommends database reorganizations and area extensions as needed, and optionally performs the database reorganizations and area extensions.

Sensor data is information that is captured at a point in time that represents the condition or state of a single database. The data can be used for later analysis and policy evaluation.

Each policy consists of a set of rules that define threshold limits for specific types of database conditions. The policy service mechanism evaluates these threshold values against sensor data that an IMS Tools product collects and stores in the IMS Tools Knowledge Base Sensor Data repository.

You can view current evaluations for a database and view evaluation history by using the Autonomics Director user interface.

Policy Services can send exception messages when an exception is detected. For more information about exception messages, see the *IMS Tools Base Policy Services User's Guide and Reference*.

## Database grouping

---

As a mechanism to more easily manage large database environments, the Autonomics Director user interface allows the creation of groups from a list of database resources that are defined in DBDLIB, DBRC, or other user groups. If the IMS-managed ACBs function is enabled, database groups can be created from the IMS directory.

Autonomics Director contains a generic user grouping facility for database reorganization.. This facility is used by Autonomics Director and other tools to allow grouping of databases and attributes for activities that are related to the entire group.

Autonomics Director manages CAGRPs for change accumulation autonomics through the mechanism of CAGRP collections.

Subsections:

- [“User-defined group-managed database reorganization” on page 20](#)
- [“Group-managed change accumulation” on page 21](#)

## User-defined group-managed database reorganization

User-defined group-managed reorganizations and area extensions enable automatic reorganizations of one or more databases and automatic SDEP or IOVF extensions of Fast Path DEDB areas.

Managing your databases, partitions, and areas at a group level can help minimize the amount of time and manual intervention that is required to maintain and optimize your resources.

User-defined group-managed reorganizations and area extensions work in addition to Autonomics Director user grouping capabilities and enable you to create groups of one or more databases that are defined in their DBDLIBs. If the IMS-managed ACBs function is enabled, database groups can be created from the IMS directory. The ability to initiate and control reorganizations and area extensions by group adds efficiency and enables these activities to be processed in parallel for multiple databases, partitions, and areas.

You can define database groups to be reorganized and Fast Path DEDB areas to be extended as a single unit. The use of group-managed reorganizations and area extensions extends the power of Autonomics Director grouping support into the operational environment.

User-defined group-managed reorganizations and area extensions can help reduce time and resource consumption for database reorganizations and IOVF and SDEP extensions. The facility allows for automatic or on-demand conditional evaluation of all database statuses in the group and, if necessary, schedules an automatic reorganization and area extension as well.

Reorganizations and area extensions are scheduled only if the resources in the group require it. For example, if only an SDEP extension is required, Autonomics Director schedules only an SDEP extension

for the Fast Path DEDB areas in the group. The databases, areas, and partitions in the entire group can be processed together, but only minimal resources are used.

Other features of user-defined group-managed reorganizations and area extensions include:

- Including databases in more than one group.
- Consolidating management of database reorganizations and area extensions: tracking, identifying, and managing.
- Running reorganization and database scan processes for multiple databases, areas, and partitions in parallel.

Running these processes in parallel helps shorten the database maintenance window, ultimately achieving higher availability.

Parallel reorganization can also be distributed to multiple LPARs in a sysplex environment.

- Running SDEP or IOVF extensions for multiple Fast Path DEDB areas in parallel.
- Running parallel post-reorganization database job streams for prefix resolution and prefix update for logically related databases.
- Tracking the status of each submitted job and notifying users when there is a failure occurs within the group jobs.
- Initiating database reorganizations and area extensions by using the Autonomics Director scheduler, on demand through the Autonomics Director interface, or through an external job scheduling system.

## Database maintenance periods

To use user-defined group-managed reorganization and area extension, you must define one or more *database maintenance periods* in your schedule.

A database maintenance period defines a time period when you want Autonomics Director to schedule (or not to schedule) a reorganization or area extension for one or more groups. You assign a defined maintenance period to the group. A database reorganization is scheduled in the assigned maintenance period if it is necessary. You can define as many maintenance periods as necessary to accommodate your business needs.

When you define the maintenance periods, you can specify whether the work runs within or outside the time period. You can also specify a reorganization interval for the group, which determines how frequently database reorganizations and area extensions can be initiated.

## User IDs

When a user-defined group-managed reorganization or area extension job is submitted, the TSO, RACF, or SAF user ID that is used depends on whether the job was scheduled with on-demand or automatic autonomics.

- If the user-defined group-managed reorganization or area extension was scheduled on demand, the TSO user ID on the on-demand REORG issuer is used on all JOB submissions.
- If the user-defined group-managed reorganization or area extension was automatically scheduled by Autonomics Director, the TSO user ID of the group owner is used on all job submissions.

## Group-managed change accumulation

Database management typically includes a requirement to run the change accumulation process at specific time intervals (for example every 12 hours) to support optimal recovery preparation. The ultimate goal of periodic change accumulation is to maintain up-to-date database change information that can serve to help minimize recovery processing time, should an actual recovery ever be required.

RECOVERY domain autonomics manages the change accumulation process through the use of change accumulation groups (CAGRP) and CAGRP collections.

A user-defined change accumulation group (CAGRP) is a grouping of one or more database resources that are selected because they have common management or environment characteristics that are appropriate for the task of change accumulation.

**Note:** CAGRPs are initially defined at the IMS RECON management level.

Carefully created CAGRPs can allow more efficient and organized management of change accumulation in environments containing large numbers of databases and resources. This way, the viewing and management of system resources can be selective and appropriately limited.

## **CAGRP collections**

Autonomics Director manages CAGRPs for change accumulation autonomics through the mechanism of CAGRP collections.

A CAGRP collection is a user-defined grouping of CAGRPs with common management characteristics. The entries (one or more) in a collection are change accumulation group names. These CAGRP entries are referred to as "collection members".

Carefully created CAGRP collections can allow more efficient and organized management of the change accumulation operation in large environments containing multiple databases and resources.

By using a CAGRP collection, you can assign the same attributes for a set of CAGRPs and coordinate the data sensor and policy evaluation runs of the selected collection members. Similarly, the viewing of system resources can be selective and appropriately limited.

The Autonomics Director user interface provides the capabilities to manage CAGRP collections with create, update, delete, and view options. The user interface provides:

- Filters ("Include" and "Exclude") that can define ("Build") a collection from a selection of all CAGRPs in the RECON.
- Filters to assist in the viewing and management of collection members.

CAGRP collection processing conditions:

- All data for the members of a collection is obtained in a single access to the RECON data set.  
This form of data access can significantly reduce the number of accesses to the RECON data set compared to making individual requests for each CAGRP.
- Attributes that are defined for the collection are valid for all collection members (CAGRPs).
- Manual sensor collection and policy evaluation operations can be performed at either the collection and the individual CAGRP member level.
- Automated sensor collection and policy evaluation operations can only be performed at the CAGRP collection level (all CAGRP members in the collection).
- Exception status can be viewed at both the collection and the member (CAGRP) level.
- The maximum exception level (none, warning, severe, critical) found on any member of a collection is propagated to the collection level.

An example process flow for RECOVERY domain change accumulation can be found in [“Scenario: Change accumulation passive autonomics using CAGRPs”](#) on page 112.

### **Example: Maximum exception level propagated to collection level**

The following example explains how the maximum exception level detected in a policy evaluation is propagated to the entire CAGRP collection.

1. The collection XYZCAS is created.
2. To populate the collection with CAGRPs, the INCLUDE filter XYZCA\* is applied.
3. The BUILD operation on the XYZCAS collection assigns the following CAGRP members to the XYZCAS collection:

- XYZCA01
  - XYZCA02
  - XYZCA03
4. A data sensor run, followed by a policy evaluation, is performed at the XYZCAS collection level (on all three members of this collection).
- The current status for all three collection members is updated during the evaluation.
5. The following evaluation results are produced:
- XYZCA01 – " " No exception
  - XYZCA02 – "S" Severe exception
  - XYZCA03 – "C" Critical exception
6. The evaluation status for the collection XYZCAS now shows the "C" critical exception.
- Reason: The maximum exception on any member of the collection is "C".

## Job scheduling structure

---

Autonomics Director provides a user-defined job scheduling structure for active autonomics and group-managed reorganization.

The structure includes four separate phases of scheduling:

- Pre-group-managed reorganization (optional)
- Reorganization and scan (required)
- Post reorganization (optional)
- Post-group-managed reorganization (optional)

Only the reorganization and scan phase is required. The other phases are offered primarily to support the use of logical relationships.

The JCL required for jobs or started tasks is defined by the user and depends on whether there are IMS external logical relationships in your databases.

### Pre-group-managed reorganization

These steps preallocate data sets, deallocate databases from online systems, run pre-reorganization utilities, or perform other functions.

The phase contains a single job and is run serially before any other jobs in the stream.

### Reorganization and scan

Databases are reorganized in the reorganization and scan phase.

During conditional reorganization, only the databases that Autonomics Director determines to require reorganization are reorganized. During unconditional reorganization, which you initiate through the Autonomics Director interface, all databases are reorganized.

Autonomics Director schedules multiple jobs in parallel during this phase. Each job reorganizes a single IMS full function database, DEDB area, or HALDB partition. Each reorganization job contains a single job step that runs a reorganization utility in unconditional mode.

For databases that participate in logical relationships, a scan job can be defined in addition to a reorganization job. The scan job runs instead of the reorganization job for databases that are participating in logical relationships and do not require reorganization. If present, the scan job is scheduled for databases that are not participating in logical relationships and do not require reorganization.

The IPR Database Scan utility produces the necessary prefix information to resolve external logical relationships.

**Important:** HALDB logical relationships are maintained and resolved when partitions are reorganized. DEDBs do not support logical relationships.

### Post-reorganization

The post reorganization phase is initiated after all jobs in the reorganization and scan phase complete successfully.

### Post-group-managed reorganization

The post-group-managed reorganization phase is the final phase of group-managed reorganization.

Post-group-managed reorganization provides an opportunity to conclude the reorganization process.

Functions such as work file deletion, DBRC authorization changes, and a utility execution that issues IMS/START DB commands can be initiated.

Two jobs are defined for the post-group-managed reorganization phase:

- The first job executes when the group-managed reorganization process runs successfully.
- The second job executes when the group-managed reorganization process fails.

Autonomics Director selects which job to run based on the final status of the reorganization, which is either failed or succeeded.

## Sweep and cycle intervals

---

Autonomics Director uses sweep and cycle intervals to determine when to schedule and initiate work.

### Sweep interval

A *sweep interval* is a time interval that defines how frequently Autonomics Director creates requests for work to be completed (for example, sensor data collection and policy evaluation).

A sweep interval occurs when Autonomics Director scans the monitor list to determine what work must be initiated between the current and next sweep interval.

During the monitor list scan, Autonomics Director considers:

- Databases requiring sensor evaluation
- Databases requiring policy evaluation
- User groups that contain databases requiring reorganization
- User groups that contain Fast Path DEDB areas requiring SDEP or IOVF extensions.

The sweep interval is controlled by the Autonomics Director Server SWEEPINT= parameter, which is contained in the Autonomics Director global parameter PROCLIB member. The value specifies the number of minutes in a SWEEP interval. The default value is 15 minutes. You can adjust this parameter as necessary, but can use the default as a starting point.

The longer the sweep interval, the more work Autonomics Director schedules between sweep intervals. Longer sweep intervals also enable Autonomics Director to better plan and stagger the initiation of workload.

### Cycle interval

A *cycle interval* is a time interval that defines when Autonomics Director runs requests for work.

Requests for work that are created in a sweep interval are distributed to be run in multiple cycle intervals. A cycle interval occurs when Autonomics Director checks for scheduled work to initiate. Work that is scheduled during a previous sweep interval can be initiated if it is time to initiate the work and the assigned period restriction allows the work to run.

During the cycle interval, Autonomics Director checks the status of group-managed reorganization and Fast Path DEDB area extension jobs that began but are not yet complete. Autonomics Director can periodically check for jobs that completed abnormally, had a JCL error, or did not notify Autonomics Director of their completion.



The cycle interval is controlled by the Autonomics Director Server CYCLETIM= parameter, contained in the Autonomics Director global parameter PROCLIB member. The value specifies the number of minutes in a cycle interval. The default value is 1 minute. You can adjust this parameter as necessary, but can begin with the default.

The cycle interval is important because if it is too long, Autonomics Director might be late in initiating work, and if it is too short Autonomics Director uses more CPU than is necessary.



---

## Chapter 4. Installation and configuration

These topics provide information about installing and configuring Autonomics Director.

### Topics:

- [“Hardware and software prerequisites” on page 27](#)
- [“Installing Autonomics Director” on page 27](#)
- [“Configuring Autonomics Director” on page 27](#)

---

### Hardware and software prerequisites

For complete information about hardware and software prerequisites, see *Program Directory for IBM IMS Tools Base for z/OS* (GI10-8819), program number 5655-V93.

---

### Installing Autonomics Director

Autonomics Director is installed as a component of IMS Tools Base.

Install Autonomics Director by using the SMP/E **RECEIVE**, **APPLY**, and **ACCEPT** commands.

Complete information about installation requirements, prerequisites, and procedures for Autonomics Director is in *Program Directory for IBM IMS Tools Base for z/OS* (GI10-8819).

After the SMP/E installation completes successfully, the following execution libraries are cataloged on your machine:

- *smqhlq.SHKTSAMP*
- *smqhlq.SHKTPENU*
- *smqhlq.SHKTMENU*
- *smqhlq.SHKTLOAD*
- *smqhlq.SHKTTENU*
- *smqhlq.SHKTCEXE*

### Verifying the installation

You can verify that Autonomics Director is properly installed on your system.

#### Procedure

Start the client CLIST and issue an Autonomics Director **DISPLAY** command.

#### What to do next

After you verify that Autonomics Director is installed successfully, you can configure Autonomics Director by using the using the Autonomics Director ISPF client.

---

### Configuring Autonomics Director

Information about configuring Autonomics Director and other IMS Tools Base components is provided in the following website:

[IMS Tools Base 1.7 Configuration Guide documentation](#)

You can also download a PDF version of this information from the following website:

[IMS Tools Product Documentation](#)



---

## Chapter 5. Starting the Autonomics Director client dialog

After you complete the required configuration procedures, start the Autonomics Director client. From the client, select an Autonomics Director server group.

### Topics:

- [“Starting the Autonomics Director client interface” on page 29](#)
- [“Setting up the Autonomics Director Client environment” on page 30](#)
- [“Updating the client environment ” on page 31](#)
- [“Establishing system settings” on page 31](#)

---

## Starting the Autonomics Director client interface

After you complete the required configuration procedures, you can start Autonomics Director and select an Autonomics Director server.

### Procedure

To start the Autonomics Director client interface:

1. Log on to TSO and specify a minimum REGION (KB) value of 6144.
2. From the ISPF Primary Option Menu panel, select option **6** (Command).

The ISPF Command Shell is displayed.

3. Invoke the Autonomics Director client interface by choosing one of the following methods:

- To access Autonomics Director from the IMS Tools Base main menu with the default XCF group, enter the following command:

```
EX 'hlq.SHKTCEXE(HKTAPPL)' 'HLQ(hlq)'
```

The IMS Tools Base main menu opens. Select option **3 Autonomics Director** and press Enter.

- To access Autonomics Director from the IMS Tools Base main menu with a specific XCF group, enter the following command:

```
EX 'hlq.SHKTCEXE(HKTAPPL)' 'HLQ(hlq) XCFGRPID(xcfgrpид)
MAXGRPS(99)'
```

The IMS Tools Base main menu opens. Select option **3 Autonomics Director** and press Enter.

- To access Autonomics Director directly, enter the following command:

```
EX 'hlq.SHKTCEXE(IAVZPRIM)' 'HLQ(hlq) XCFGRPID(xcfgrpид)
MAXGRPS(99)'
```

The Autonomics Director main menu opens.

For proper syntax, the closing quotation mark must follow the last specified parameters to the command.

The variables and keywords in the previous examples have the following values:

#### **hlq**

Indicates the high-level qualifier of your installation data set.

#### **XCFGRPID(xcfgrpид)**

(Optional) Indicates an XCF group name.

In an Autonomics Director environment, the XCF group names must conform to a specific naming convention.

The XCF group name is built by adding a prefix of IAV to the 3-character XCFGRPID (that matches the three characters of the XCF group name that is specified in the XCFGROUP parameter in the Autonomics Director server common PROCLIB member) and then adding a suffix with a number in the range 00 to the value that is specified in the MAXGRPS parameter (for example, IAVADM00).

For more information, see the *IMS Tools Base Configuration Guide*.

The default value is ADM.

If the XCFGROUP parameter of Autonomics Director is not ADM, the correct XCFGRPID parameter must be specified to successfully connect to the server.

#### **MAXGRPS**

(Optional) Determines the range of XCFGROUP names.

The MAXGRPS value is a number 1 - 99.

The default value is 10.

## Setting up the Autonomics Director Client environment

---

When you start the Autonomics Director client dialog, you must select an XCF group to communicate with the Autonomics Director server and a RECON ID for processing. An Autonomics Director server must be configured and started.

### **Before you begin**

Autonomics Director uses RECON environments. The IMS Tools Knowledge Base repository must be configured with one or more RECON data sets defined.

At least one RECON ID is required. Minimally, the RECON ID must include one DBDLIB data set for use in the automatic discovery of databases and DBRC groups. If the IMS-managed ACBs function is enabled, it must include the IMSCATHLQ value.

For detailed information about configuration of IMS Tools Knowledge Base, see the *IMS Tools Base Configuration Guide*.

### **Procedure**

1. Start the Autonomics Director client interface. See [“Starting the Autonomics Director client interface” on page 29](#) for instructions.
2. Specify the settings for your Autonomics Director client sessions.

**Note:** Your client parameter values are saved in your ISPF profile and remain in effect across your Autonomics Director sessions.

- If you have not previously used the client, the Autonomics Director Settings panel displays.

Respond to the prompts to specify your parameter settings. These parameters are described in [“Establishing system settings” on page 31](#).

- If you have previously used the client, the Autonomics Director Settings panel is bypassed and does not display.

**Note:** These settings may be updated at any time by selecting option **0 Settings** from the Autonomics Director Primary Options Menu panel. See [“Updating the client environment” on page 31](#).

3. Select the XCF group that will be used to communicate with the Autonomics Director server.

Your XCF group name is saved in your ISPF profile and remains in effect across your Autonomics Director sessions.

If an XCF group name has not yet been saved in your profile, a list of XCF groups is displayed using the Autonomics Director XCF Groups panel. The displayed names are determined using the MAXGRPS and XCFGRPID values specified when starting the client dialog. Type S to select your XCF group.

After making your selection, a verification will be performed to ensure that the client and the selected Autonomics Director server are executing at the same software level.

In most cases this prompt will be bypassed if an XCF group name has already been saved in your profile. You will be prompted if:

- The Autonomics Director server corresponding to the saved group name is not active.
- The saved group name does not match the MAXGRPS and XCFGRPID values.

Press F3 (END) on the Autonomics Director XCF Groups panel during client dialog initialization if you want to close the Autonomics Director client session.

4. Select the RECON ID with an S from the list of RECON IDs displayed in the Recon Information panel.

The displayed names are those that are defined to the selected Autonomics Director server.

**Note:** If you press F3 (END) on the Recon Information panel during client dialog initialization, you will be re-prompted for an XCF group name. Once an XCF group is selected, you will again be prompted for a RECON ID known to the selected Autonomics Director server.

## Results

After you make a selection, the Autonomics Director main menu is displayed.

## Updating the client environment

---

Perform any of the following steps to update the settings for your Autonomics Director client sessions.

### Procedure

- Update your client parameter settings by selecting option 0 **Settings** from the Autonomics Director Primary Options Menu panel.
- Update the current XCF group name by overtyping it with a different name in the Autonomics Director Primary Options Menu.

If the name is cleared, entered as a question mark, or does not match the MAXGRPS and XCFGRPID values, the Autonomics Director XCF Groups panel displays to prompt for a new name.

When the XCF group name is changed, you will be prompted for a RECON ID.

**Note:** If you press F3 (END) in the Autonomics Director XCF Groups panel after the Autonomics Director Primary Options Menu is displayed, processing returns to this menu without altering the XCF group name.

- Update the current RECON ID by overtyping it with a different name in the Autonomics Director Primary Options Menu.

If the ID is cleared or entered as a question mark, you will be prompted for a RECON ID.

**Note:** If you press F3 (END) in the Recon Information panel after the Autonomics Director Primary Options Menu is displayed, processing returns to this menu without altering the RECON ID.

## Establishing system settings

---

You can establish Autonomics Director system settings before completing other tasks with the tool.

### About this task

These settings for your Autonomics Director specify time format options, when to run policy evaluations, IMS Tools Knowledge Base high-level qualifier, and data set allocations. These values are saved in your ISPF profile and remain in effect across your Autonomics Director sessions.

## Procedure

To establish system settings in the client:

1. From the Autonomics Director Primary Options Menu panel (**IAVPRIM**), select option **0 Settings**, and press Enter.

The Autonomics Director Settings panel (**IAVPSET**) is displayed.

2. Specify the Autonomics Director settings for the following options:

### **Time format**

Specify which time format to use:

**1**

The time periods are entered and displayed in the 12-hour clock (00:00 AM to 11:59 PM).

**2**

The time periods are entered and displayed in the 24-hour clock (00:00 to 23:59).

### **Evaluate after sensor run**

Specify whether to schedule a policy evaluation run after sensor data collection run.

This sets the default for databases, partitions, or areas added to the monitor list.

You can override this value when you add a database to the monitor list.

### **Primary CYLS**

Specify the primary number of cylinders used for the allocation of a temporary work data set.

This setting is used for certain outputs, for example recommendations or command output.

The default value is 10.

### **Secondary CYLS**

Specify the secondary number of cylinders that are used for the allocation of a temporary work data set.

The default value is 10.

### **UNIT**

Specify the device unit where the temporary work data set is allocated.

The default value is SYSALLDA.

### **Volume serial number**

Specify the volume serial number of the device where the work data set is allocated.

If no volume serial number is specified, the default value is set by the system.



---

## Chapter 6. Managing the Autonomics Director server

You can use commands or the Autonomics Director ISPF interface to manage the Autonomics Director server. The commands are issued by using the z/OS console interface to the Autonomics Director server address space.

### Topics:

- [“Stopping the Autonomics Director server” on page 33](#)
- [“Displaying the Autonomics Director server resources” on page 35](#)
- [“Refreshing the Autonomics Director server resources” on page 39](#)

---

### Stopping the Autonomics Director server

You can stop the Autonomics Director server by using commands or the Autonomics Director ISPF interface.

Subsections:

- [“Stopping the server using the ISPF interface” on page 33](#)
- [“Stopping the server using commands” on page 33](#)

### Stopping the server using the ISPF interface

You can stop the Autonomics Director server by using the ISPF interface.

#### Procedure

To stop Autonomics Director:

1. From the Autonomics Director Primary Options Menu panel (**IAVPRIM**), select option **6 Operations**.  
The Autonomics Director XCF Group Name List panel (**IAVPSRV**) is displayed.
2. Select row action **P** or **PI** and press Enter.

### Stopping the server using commands

Several commands are available to stop the Autonomics Director server: **STOP**, **MODIFY STOP**, and **MODIFY STOPI**.

This section describes the benefits and restrictions for using each of these commands.

Subsections:

- [“Format” on page 33](#)
- [“Usage” on page 34](#)
- [“Syntax” on page 34](#)
- [“Considerations” on page 35](#)
- [“Output” on page 35](#)

#### Format

##### **STOP (P) command**

► P — *server\_jobtask* ◄

## MODIFY STOP command

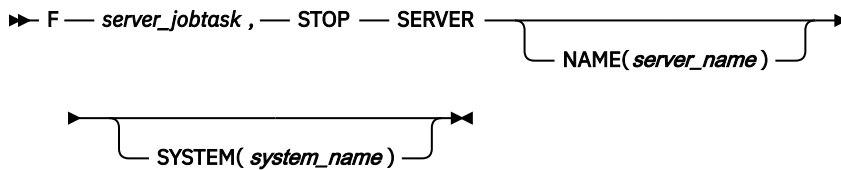

## MODIFY STOPI command

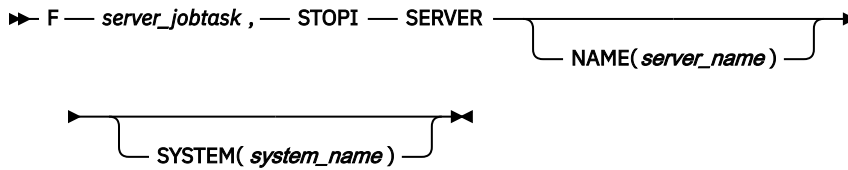

## Usage

The various forms of the **STOP** command are used to stop an Autonomics Director server or servers. Use the appropriate form of the command for your needs.

### STOP (P) command

Requests that the local server stops after all outstanding user requests have completed.

If the server is the master server, any other active or failover server is eligible to take over as the master.

### MODIFY STOP command

Requests that a single server or multiple servers stop after all outstanding user requests have completed.

Use the **MODIFY STOP** command for normal shutdowns.

### MODIFY STOPI command

Requests that a single server or multiple servers stop immediately.

Any outstanding user requests are not processed, and any active user sessions might hang as a result of an outstanding response.

## Syntax

### F

The MVS **MODIFY (F)** command that is used to issue commands on z/OS.

### P

The MVS command **STOP (P)** that is used to stop a server component.

### *server\_jobtask*

The Autonomics Director server job or started task name to which the command is submitted.

### STOP

Requests that the servers stop after all outstanding user requests have completed.

Use the **STOP** command for normal shutdowns.

### STOPI

Requests that the servers stop immediately.

Any outstanding user requests are not processed, and any active user sessions might hang as a result of an outstanding response.

### SERVER

Required positional parameter.

**NAME (server\_name)**

Specifies the name of the server to stop.

The server name is the job or started task name of the server.

It can also be specified as NAME (ALL) or NAME (\*) to indicate all servers.

When this parameter is omitted, the default for *server\_name* is the same value as what is specified for *server\_jobtask*.

**SYSTEM (system\_name)**

The *system\_name* further qualifies the MVS system on which the processing server executes.

The *system\_name* parameter can be specified only when the NAME *server\_name* is also specified.

When this parameter is omitted, no system qualification is used.

**Considerations**

To avoid automatic takeovers, stop subordinate servers (active and failover) before the master server.

- The use of NAME (ALL) or NAME (\*) is limited to commands that are entered through the z/OS console.
- To use NAME (ALL) or NAME (\*), the master server must be available.

The master server coordinates the activities of all servers in the Autonomics Director group.

The master server requests subordinate server termination and monitors the activity of all servers in the Autonomics Director group for approximately 3 minutes of elapsed time.

When all subordinate servers are terminated, the master server itself terminates as well.

If subordinate servers do not terminate within the 3-minute period, the master server cancels the coordinated shutdown and remains active.

**Output**

The following example shows the output from the P *server\_jobtask*, F *server\_jobtask*, STOP, and F *server\_jobtask*, STOPI commands:

```
IAV0900I - SHUTDOWN SCHEDULED - ADSRV
BPE0007I ADAS BEGINNING PHASE 1 OF SHUTDOWN
IAV0003I - TDCM TCB TERMINATION COMPLETE
IAV0003I - TUI TCB TERMINATION COMPLETE
IAV0003I - TCSV TCB TERMINATION COMPLETE
IAV0003I - TIITK TCB TERMINATION COMPLETE
IAV0003I - TTIM TCB TERMINATION COMPLETE
IAV0003I - TSEN TCB TERMINATION COMPLETE
IAV0003I - TSAF TCB TERMINATION COMPLETE
IAV0003I - TPOL TCB TERMINATION COMPLETE
IAV0003I - TDSC TCB TERMINATION COMPLETE
IAV0003I - TSCH TCB TERMINATION COMPLETE
BPE0008I ADAS BEGINNING PHASE 2 OF SHUTDOWN
BPE0009I ADAS SHUTDOWN COMPLETE
IAV0990I - A/S CLEANUP COMPLETE
```

## Displaying the Autonomics Director server resources

You can display the Autonomics Director server resources by using a command or the Autonomics Director ISPF interface.

Subsections:

- [“Displaying server resources using the ISPF interface” on page 36](#)
- [“Displaying server resources using the DISPLAY command” on page 36](#)

## Displaying server resources using the ISPF interface

You can display the Autonomics Director server resources by using the ISPF interface.

### Procedure

To display the server resources:

1. From the Autonomics Director Primary Options Menu panel (**IIVPRIM**), select option **6 Operations**.

The Autonomics Director XCF Group Name List panel (**IIVPSRV**) is displayed.

2. Select row action **D** and press Enter.

The Autonomics Director Display Command Parameters panel (**IIVPDSP**) is shown.

3. Select a display option and press Enter.

### Examples

In the following example, display option **1 REGION** is selected:

```
ISRBROBA USRT001.ECDBT13.IMSAD.CMDOUT1
Command ==>
***** Top of Data *****
IIV0087I - JOBNAME      SYSTEM      MODE      XCF-MEMBER      WGT  PERIOD  TO
IIV0087I - ADSRV       ECDBT13  MASTER    ADSERVER        000  00013  00
***** Bottom of Data *****
```

Figure 3. Example: Region information panel

In the following example, display option **2 PARMS** is selected:

```
ISRBROBA USTR001.ECDBT13.IMSAD.CMDOUT1          Line 0000000000 Col 001 080
Command ==>                                     Scroll ==> CSR
***** Top of Data *****
IIV0087I - PARAMETER   VALUE      TYPE
IIV0087I - CYCLETIM    00001     GLOBAL - ADSRV
IIV0087I - SWEEPINT    00001     GLOBAL - ADSRV
IIV0087I - WLMRINT     00000     GLOBAL - ADSRV
IIV0087I - SENSAGE     00000     GLOBAL - ADSRV
IIV0087I - EVALINT     00000     GLOBAL - ADSRV
IIV0087I - REORGINT    00000     GLOBAL - ADSRV
IIV0087I - XCFGROUP    IIVADM00  GLOBAL - ADSRV
IIV0087I - ITKBGROUP   FPQSRVT4  GLOBAL - ADSRV
IIV0087I - RACFAPPL    NONE      GLOBAL - ADSRV
IIV0087I - JCLLIB      IMSTESTS.RGE410.FPQ1 GLOBAL - ADSRV
IIV0087I - ADREPOS     IIV_AUTODIR GLOBAL - ADSRV
IIV0087I - POLCACHE    008      GLOBAL - ADSRV
IIV0087I - RECOVERY    ENABLE    GLOBAL - ADSRV
IIV0087I - MODE        ACTIVE    LOCAL  - ADSRV
IIV0087I - IIVPARMS    IIVCOMON LOCAL  - ADSRV
IIV0087I - XCFMEMB     ADSERVER  LOCAL  - ADSRV
IIV0087I - RACFAGE     00010    LOCAL  - ADSRV
***** Bottom of Data *****
```

Figure 4. Example: Parameter information panel

## Displaying server resources using the DISPLAY command

You can display Autonomics Director server resources for servers in the Autonomics Director group by issuing the **DISPLAY** command.

Subsections:

- [“Format” on page 37](#)
- [“Usage” on page 37](#)
- [“Syntax” on page 37](#)
- [“Considerations” on page 37](#)

- “Output from the DISPLAY command” on page 38

## Format

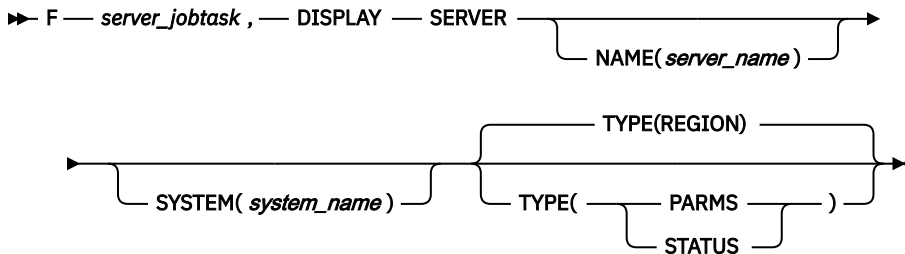

## Usage

Use the **DISPLAY** command to display information about Autonomics Director server regions or initialization parameters.

## Syntax

### F

The MVS **MODIFY (F)** command that is used to issue commands on z/OS.

### *server\_jobtask*

The Autonomics Director server job or started task name to which the command is submitted.

### **DISPLAY**

Requests that server information is displayed.

### **SERVER**

Required positional parameter.

### **NAME (server\_name)**

Specifies the name of the server that processes the **DISPLAY** command.

The server name is the job or started task name of the server. It can also be specified as `NAME (ALL)` or `NAME (*)` to indicate all servers.

The default for *server\_name* is the same value that is specified for *server\_jobtask*.

### **SYSTEM (system\_name)**

The *system\_name* further qualifies the MVS system on which the processing server executes.

The *system\_name* parameter can be specified only when the `NAME server_name` is also specified.

When this parameter is omitted, no system qualification is used.

### **TYPE(REGION | PARMS | STATUS)**

Specifies the type of display:

#### **REGION**

Displays information that is related to all server regions in the Autonomics Director group.

#### **PARMS**

Displays the initialization parameters that are used by the server.

#### **STATUS**

Displays the status of the Autonomics Director server components.

The default is `TYPE(REGION)`.

## Considerations

- You can use the `NAME(ALL)` or `NAME(*)` parameters only with commands that are entered through the z/OS console.

- You can use the NAME(ALL) or NAME(\*) parameter with the TYPE(REGION) parameter produces redundant output for each servers' view of the environment.

**Tip:** Use a specific NAME or omit the NAME parameter when displaying Autonomics Director server regions.

## Output from the DISPLAY command

The following example shows the output from the **DISPLAY SERVER** command:

```
IAV0087I - JOBNAME   SYSTEM      MODE      XCF-MEMBER      WGHT  PERIOD  TOTAL
IAV0087I - ADSRV    ECDBT09   MASTER    ADSERVER@ECDBT09 032   00001  00001
IAV0087I - ADSRV2   ECDBT09   ACTIVE    ADSRV2@ECDBT09  032   00000  00000
```

where:

### JOBNAME

Is the name of the Autonomics Director server.

### SYSTEM

Is the MVS system name where the Autonomics Director server is running.

### MODE

Is the mode of the server.

### XCF-MEMBER

Is the Autonomics Director server XCF member name.

### WGHT

Is the routing weight for this server.

For WLM routing, a higher number indicates that more work is routed to the server.

A value of zero indicates that WLM routing is not used.

### PERIOD

Is the number of work requests that were sent to the server during the period defined for the WLM routing interval (WLMRINT).

The value is reset to zero for each new period or interval.

### TOTAL

Is the total number of work requests that were sent to the server during the life of the local server.

The following example shows the output from the **DISPLAY SERVER TYPE(PARMS)** command:

```
IAV0087I - PARAMETER  VALUE      TYPE
IAV0087I - CYCLETIM  00060     GLOBAL - ADSRV
IAV0087I - SWEEPINT  00060     GLOBAL - ADSRV
IAV0087I - WLMRINT   00001     GLOBAL - ADSRV
IAV0087I - SENSAGE   00000     GLOBAL - ADSRV
IAV0087I - EVALINT   00000     GLOBAL - ADSRV
IAV0087I - REORGINT  00000     GLOBAL - ADSRV
IAV0087I - XCFGROUP  IAVADM00  GLOBAL - ADSRV
IAV0087I - ITKBGROUP FPQSRVT3  GLOBAL - ADSRV
IAV0087I - RACFAPPL  NONE      GLOBAL - ADSRV
IAV0087I - JCLLIB    IMSTESTS .RGE410.FPQ1 GLOBAL - ADSRV
IAV0087I - ADREPOS   IAV_AUTODIR GLOBAL - ADSRV
IAV0087I - POLCACHE  008      GLOBAL - ADSRV
IAV0087I - RECOVERY  ENABLE    GLOBAL - ADSRV
IAV0087I - MODE      ACTIVE    LOCAL  - ADSRV
IAV0087I - IAVPARMS  IAVCOMON LOCAL  - ADSRV
IAV0087I - XCFMEMB   ADSERVER@ECDBT09 LOCAL  - ADSRV
IAV0087I - RACFAGE   00010    LOCAL  - ADSRV
```

where:

### PARAMETER

Is the keyword parameter name.

**VALUE**

Is the value for the parameter.

**TYPE**

Indicates the type, either GLOBAL or LOCAL:

- GLOBAL indicates that a parameter is specified in the PROCLIB member shared by all servers.
- LOCAL indicates that a parameter is specific to a particular server.

## Refreshing the Autonomics Director server resources

---

You can refresh the Autonomics Director server resources by using the **REFRESH** command or the Autonomics Director ISPF interface.

Subsections:

- [“Refreshing server resources using the ISPF interface” on page 39](#)
- [“Refreshing server resources using the REFRESH command” on page 39](#)

### Refreshing server resources using the ISPF interface

You can refresh the Autonomics Director server resources by using the ISPF interface.

#### About this task

When a RECON ID is added or changed in the IMS Tools Knowledge Base repository, the Autonomics Director environment is not automatically updated.

You must update your Autonomics Director server RECON environment by using the refresh RECON option to pick up the changes.

#### Procedure

To refresh the server resources:

1. From the Autonomics Director Primary Options Menu panel (**IAVPRIM**), select option **6 Operations**.

The Autonomics Director XCF Group Name List panel (**IAVPSRV**) is displayed.

2. Select row action **R** and press Enter.

The Autonomics Director Refresh Command Parameters panel (**IAVPRFR**) is shown.

3. Select a server environment component to refresh and press Enter.

Message IAV6001I is issued to indicate a successful refresh.

#### Updating the RECON ID environment

To update the RECON ID environment, select option **4 RECON**. Then, in the Autonomics Director Refresh RECON Command Options panel (**IAVPRFR**), select option **2 RECONID resources**.

Refreshing the RECON ID environment releases the previous environment and builds a new environment. Therefore, after you refresh the RECON ID resources, you must also refresh the MONLIST (monitor list) component to populate the new environment with all previously defined user groups, scheduling periods, and monitor list data.

4. Press F3 to return to the main panel and repeat for each server environment component.

### Refreshing server resources using the REFRESH command

You can refresh server resources for servers in the Autonomics Director group by using the **REFRESH** command.

**Important:** When a RECON ID is added or changed in the IMS Tools Knowledge Base repository, the Autonomics Director environment is not automatically updated. You must update your Autonomics

Director server RECON environment by using the TYPE(RECON) OPTION(REFRESH) parameter to pick up the changes.

Subsections:

- [“Format” on page 40](#)
- [“Usage” on page 40](#)
- [“Syntax” on page 40](#)
- [“Considerations” on page 41](#)
- [“Output from the REFRESH command” on page 41](#)

## Format

► F — *server\_jobtask* , — REFRESH — SERVER ►

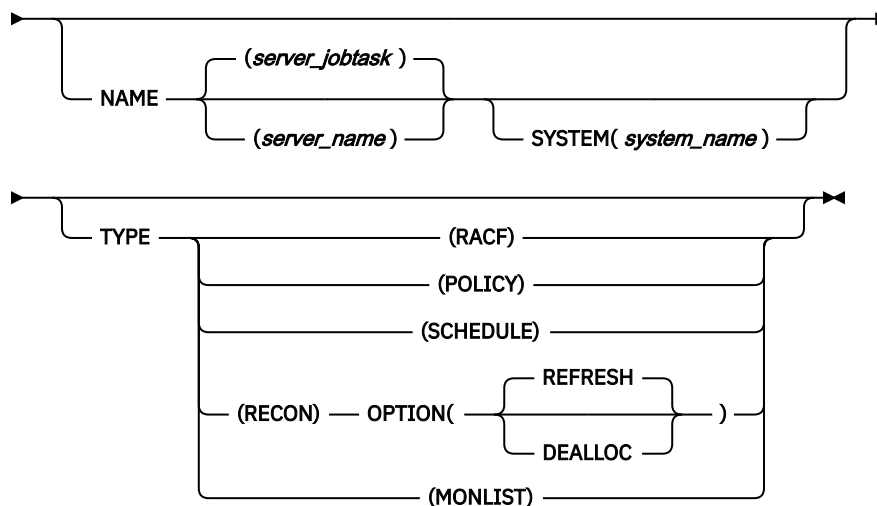

## Usage

Use the **REFRESH** command to refresh various Autonomics Director server environment components without having to stop and restart a server.

## Syntax

**F**

The MVS **MODIFY (F)** command that is used to issue commands on z/OS.

### ***server\_jobtask***

The Autonomics Director server job or started task name to which the command is submitted.

### **REFRESH**

Requests that the servers refresh the component that is specified by the TYPE parameter.

### **SERVER**

Required positional parameter.

### **NAME (*server\_name*)**

Specifies the name of the server to refresh. The server name is the job or started task name of the server.

It can also be specified as NAME (ALL) or NAME (\*) to indicate all servers.

When this parameter is omitted, the default for *server\_name* is the same value that is specified for *server\_jobtask*.

### **SYSTEM (*system\_name*)**

The *system\_name* further qualifies the MVS system on which the processing server executes.



The *system\_name* can be specified only when the NAME *server\_name* parameter is also specified. When this parameter is omitted, no system qualification is used.

## **TYPE**

Specifies the type of display. Valid types are:

### **RACF**

RACF or SAF in-storage profiles and cached RACF user ACEEs are refreshed.

### **POLICY**

Policy services in-storage policies are refreshed.

### **SCHEDULE**

The Autonomics Director scheduler data is refreshed.

### **RECON**

The data from the IMS Tools Knowledge Base RECON ID record is refreshed.

Refresh the monitor list after you refresh the RECON environment. Refreshing the RECON environment releases the previous environment and builds a new environment.

When you refresh the monitor list, the new environment is populated with all previously defined user groups, scheduling periods, and monitor list data.

### **OPTION**

Specifies whether to refresh the data (RECON ID environment) from the RECONID record or deallocate RECON data sets allocated to the AD server.

The OPTION parameter is applicable only when TYPE(RECON) is specified. When this parameter is omitted, OPTION(REFRESH) is used.

### **REFRESH**

The data from the IMS Tools Knowledge Base RECON ID record is refreshed.

Refresh the monitor list after the data is refreshed. Refreshing the data releases the previous RECON ID environment and builds a new environment. When you refresh the monitor list, the new environment is populated with all previously defined user groups, scheduling periods, and monitor list data.

### **DEALLOC**

All RECON data sets that are allocated to the Autonomics Director server are deallocated.

### **MONLIST**

Data from the monitor list is refreshed.

## **Considerations**

You can use the NAME (ALL) or NAME (\*) parameters only with commands that are entered through the z/OS console.

## **Output from the REFRESH command**

The following example shows the output from the F *server\_jobtask*, REFRESH command:

```
IAV6001I - REFRESH SERVER COMMAND EXECUTED
```



---

## Chapter 7. Managing the scheduler

Use the Autonomics Director scheduler to automate ongoing IMS database monitoring and maintenance tasks.

To reduce the impact to system resources, you can restrict the running of these tasks to defined time intervals.

You can schedule the following tasks:

- Reorganization of a user-defined database group
- Sensor data collection services
- Policy evaluation for one or more databases

You can ensure that sensor data collection services and policy evaluations are scheduled around your peak production workload by defining a *peak period* (a period during which no sensor data collection or policy evaluations are scheduled).

Automatic reorganizations for user groups are scheduled according to the *maintenance period* (the time intervals during which reorganizations can take place) that you define and assign to the user group.

Each peak period and maintenance period is composed of a *base period* (the default time intervals in a day) and *overrides* (a time interval that is a deviation to the base period for a specific day or days).

### Topics:

- [“Scheduler terminology” on page 43](#)
- [“Defining the base period” on page 44](#)
- [“Editing base period definitions” on page 48](#)
- [“Viewing the scheduling calendar” on page 49](#)
- [“Suspending the Autonomics Director scheduler” on page 51](#)
- [“Resuming the Autonomics Director scheduler” on page 53](#)

---

## Scheduler terminology

Specific terminology is used throughout the Autonomics Director scheduling process to refer to the different types of time periods, lists, and other elements that are involved with this process.

### Period

A set of scheduling restrictions that consist of one base period and all the overrides specified for that base period.

### Base period

The default time intervals in a day. These intervals remain in effect for all days of all months and years.

You can define overrides to the base period for specific dates and times.

For example, if your base period is defined as the time interval from 8:00 AM - 5:00 PM, but on weekends you want your time interval to be from 1:00 PM - 2:00 PM, you can define this exception as an override.

### Override

A time interval that is a deviation to the base period for a specific day or days.

An override is in effect only for the specific day or days that it is defined for.

### Evaluation interval

The defined time interval that specifies how much time must elapse before a resource is reevaluated.

### Monitor list

A set of database and database partition names with attributes that are saved in the Autonomics Director repository and are available for monitoring.

The monitor list is created from the following types of resources:

- Databases, partitions, and areas registered with DBRC and defined in a DBRC group.
- Databases, partitions, and areas that are not defined in any DBRC group.
- Databases, partitions and areas that are defined in any user-defined group.

### Recommendation list

A list database and database partition names and recommended actions.

These results include recommendations and exceptions from the evaluation runs.

The most recent evaluation run as well as a history of evaluations are included in the recommendation list.

### Evaluation on demand

A request for policy evaluation of a database or partition or area of a database.

The action can be scheduled immediately (even during the peak period) or in the next available period, on a specified date and time.

### Sensor data collection on demand

A request for scheduling of a sensor data collection run.

The action can be scheduled immediately (even during the peak period), in the next available period, or on a specified date and time.

## Defining the base period

---

You can define the default time intervals (base period) for a regular day.

### About this task

This base period can be defined as peak (a period during which no Autonomics Director work is scheduled), or maintenance (a period during which Autonomics Director work is scheduled).

The base period is in effect every day, except on days that have overrides.

You can define overrides to the base period for specific days, dates, and times.

For example, if your base period is defined as the time interval from 8:00 AM – 5:00 PM, but on weekends you want your time interval to be from 1:00 PM – 2:00 PM, you can define this exception as an override.

### Procedure

To define the base period:

1. From the Autonomics Director Primary Options Menu panel (**IAVPRIM**), select option **1 System administration** and press Enter.

The Autonomics Director System Administration Options Menu panel (**IAVPSAM**) is displayed.

2. Select option **1 Manage scheduling calendar**, and press Enter.

The Autonomics Director Scheduler: Period Management panel (**IAVPCLN**) is displayed.

3. Select option **1 Create schedules** and press Enter.

The Autonomics Director Create New Period panel (**IAVPNPR**) is displayed.

4. Specify the period name and press Enter.

- The period name must be unique within the existing period names.
- If you are defining a peak period, specify the period name, which must be PEAK.

- If you are defining a maintenance period, the name can contain a maximum of 16 characters.

The period name NONPEAK is reserved.

The Autonomics Director Scheduler: Define Periods panel (**IAVPCOM**) is displayed.

5. Select option **1 Define the base periods** and press Enter.

The Scheduler: Create Base Operational Periods panel (**IAVPCBP**) is displayed.

6. Enter the start and end times for the peak period.

The start and end times of a period are expressed in hours (*hh*), minutes (*mm*), and AM or PM.

If the time format is set to a 12-hour clock, specify hours as a number in the range 00 - 11.

If the time format is set to a 24-hour clock, specify hours as a number in the range 00 - 23.

Specify minutes as a number in the range 00 - 59.

If you are using the 12-hour clock, the default is AM when the starting hour is earlier than the ending hour; otherwise, the default is PM.

7. Type SAVE and press Enter.

### Example

Suppose you want to define a peak base period of:

- 8:00 AM - 9:00 AM
- 1:00 PM - 2:00 PM
- 4:00 PM - 5:00 PM

Specify the following values so that each day, by default, no Autonomics Director activity will be scheduled between these hours:

```
IAVPCBP Scheduler: Create Base Operational Periods Row 1 to 3 of 3
Command ==> SAVE Scroll ==> PAGE

Period name . . : PEAK

Commands: SAVE - Save the base operational period definitions
Row Actions: I - Insert one or more rows below action line.
             D - Delete a row.

Enter the non-overlapping start and end times for the base periods:

Action      Start      End      Comment
            hh : mm AM/PM  hh : mm AM/PM
            08 : 00 AM  09 : 00 AM
            01 : 00 PM  02 : 00 PM
            04 : 00 PM  05 : 00 PM
```

Figure 5. Example: Scheduler: Create Base Operational Periods panel

## Defining overrides to the base period

You can define overrides to the base period so that on the dates and times you select, the override definitions are used instead of the base period.

### About this task

For example, if you define a base period that is 8:00 AM - 5:00 PM, but on the third Friday of each month you want it to be from 1:00 PM - 4:00 PM, you can define this exception as an override.

### Procedure

To define an override:

1. From the Autonomics Director Primary Options Menu panel (**IAVPRIM**), select option **1 System administration** and press Enter.

The Autonomics Director System Administration Options Menu panel (**IAVPSAM**) is displayed.

2. Select option **1 Manage scheduling calendar**, and press Enter.

The Autonomics Director Scheduler: Period Management panel (**IAVPCLN**) is displayed.

3. Select option **2 Edit schedules** and press Enter.

The Edit Periods Filter panel (**IAVPEOP**) is displayed.

4. Apply a filter to narrow your search for operational definitions or press Enter to indicate no filtering.

The Autonomics Director Maintenance Period Name List panel (**IAVPEPD**) is displayed.

5. Type A in the **Act** column of a period name to define base periods and new overrides for that period and press Enter.

The Autonomics Director Scheduler: Define Periods panel (**IAVPCOM**) is displayed.

6. Select an override option and press **Enter**:

- **1 (Define the base periods)**: Specifies the default time interval for an activity.

For example, you can define your peak base period as 10:00 AM - 11:00 AM because you know that this interval contains the highest usage level for your systems.

- **2 (Specify base period overrides by using days of the week)** : Specifies that overrides are used instead of the base period for the selected days of the week.

- a. Enter a forward slash (/) to select one or more days of the week.

You can also specify all weekdays, all weekends, and monthly overrides by day.

- b. Enter the start and end times for the override.

The start and end times of a period are expressed in hours (*hh*), minutes (*mm*), and AM or PM.

If the time format is set to a 12-hour clock, specify hours as a number in the range 00 - 11.

If the time format is set to a 24-hour clock, specify hours as a number in the range 00 - 23.

Specify minutes as a number in the range 00 - 59.

The default is AM if the starting hour is earlier than the ending hour; otherwise, the default is PM.

- c. Type SAVE and press Enter.

Overrides that are created by using option 2 are saved as WEEK.

- **3 (Specify base period overrides by using generic dates)**: Specifies overrides that are used instead of the base period for the selected days of the month instead.

- a. Enter a forward slash (/) for each of the dates that you want to override.

The calendar shows all of the possible days within a month.

You can also specify the last day or all days in a month.

- b. Enter the start and end times for the override.

The start and end times of a period are expressed in hours (*hh*), minutes (*mm*), and AM or PM.

If the time format is set to a 12-hour clock, specify hours as a number in the range 00 - 11.

If the time format is set to a 24-hour clock, specify hours as a number in the range 00 - 23.

Specify minutes as a number in the range 00 - 59.

The default is AM if the starting hour is earlier than the ending hour; otherwise, the default is PM.

- c. Type SAVE and press Enter.

Overrides that are created by using option 3 are saved as MONTH.

- **4 (Specify base period overrides by using specific dates):** Specifies overrides that are used instead of the base period for the selected dates.
  - a. Enter a forward slash (/) for each date that you want to override.
 

The calendar shows the current month by default.

To change the month and year, specify a month 1 - 12 and year 0 - 99, and press Enter.
  - b. Enter the start and end times for the override.
 

The start and end times of a period are expressed in hours (*hh*), minutes (*mm*), and AM or PM.

If the time format is set to a 12-hour clock, specify hours as a number in the range 00 - 11.

If the time format is set to a 24-hour clock, specify hours as a number in the range 00 - 23.

Specify minutes as a number in the range 00 - 59.

The default is AM if the starting hour is earlier than the ending hour; otherwise the default is PM.

To define the same override intervals for specific dates of another month, place your cursor on the previous (<<) or next (>>) arrows and press Enter.

You can also specify another month or year by specifying the month and year in their input fields.
  - c. After all the dates for various months have been specified, type SAVE and press Enter.
 

Overrides that are created by using option 4 are saved as DATE.

## Examples

### Example 1: Specify base period overrides by using days of the week

In this example, an override is defined for the fourth Thursday of the month from:

- 8:45 AM - 10:25 AM
- 9:15 PM - 11:30 PM

```
IAVPCWO Specify Base Period Overrides by Using Days of the We Row 1 to 2 of 2
Command ==> Scroll ==> PAGE

Period name . . : PEAK

Enter / to to select one or more days

  _ Daily      _ Weekday      / Weekend      _ Sunday      _ Monday
  _ Tuesday    _ Wednesday    / Thursday     _ Friday      _ Saturday

Every month on the:
  _ First      _ Second      _ Third      / Fourth      _ Fifth      _ Last occurrence

Commands:  SAVE - Save the base period overrides.
Row Actions: I - Insert rows below the action line.
             D - Delete a row.
Enter the non-overlapping start and end times for base period overrides.

Action      Start                End                Comment
           hh : mm AM/PM    hh : mm AM/PM
           08 : 45 AM      10 : 25 AM
           09 : 15 PM      11 : 30 PM
```

Figure 6. Example: Specify Base Period Overrides by Using Days of the Week panel

### Example 2: Specify base period overrides by using generic dates

In this example, an override is defined for the 11th, 21st, and 29th of all months from 1:10 PM - 2:10 PM:

```

IAVPBDY cify Base Period Overrides By Using Generic Dates In A Row 1 to 2 of 2
Command ==> Scroll ==> PAGE

Period name : PEAK > 1 2 3 4 5 6 7
Override for selected dates > 8 9 10 / 11 12 13 14
> 15 16 17 18 19 20 / 21
Enter / to select dates > 22 23 24 25 26 27 28
> / 29 30 31
> _ LASTDAY _ ALL

Commands: SAVE - Save the base period overrides.
Row Actions: I - Insert rows below the action line.
D - Delete a row.
Enter the non-overlapping start and end times for base period overrides.

Action Start End Comment
hh : mm AM/PM hh : mm AM/PM
01 : 10 PM 02 : 10 PM
_ : _ _ _ : _ _

```

Figure 7. Example: Specify Base Period Overrides By Using Generic Dates In A Month panel

**Example 3: Specify base period overrides by using specific dates**

In this example, an override is defined for the 4th, 20th, and 25th of June, 2024 from 10:30 PM - 11:59 PM:

```

IAVPBDT Base Period Overrides for Specific Dates in Mont Row 1 to 2 of 2
Command ==> Scroll ==> PAGE

Period name . . . : PEAK << Month 06 Year 24 >>
Override for selected dates > Su Mo Tu We Th Fr Sa
> 2 3 / 4 5 6 7 8
Enter / to select dates > 9 10 11 12 13 14 15
> 16 17 18 19 / 20 21 22
> 23 24 / 25 26 27 28 29
> 30

Commands: SAVE - Save the base period overrides.
Row Actions: I - Insert rows below the action line.
D - Delete a row.
Enter the non-overlapping start and end times for base period overrides.

Action Start End Comment
hh : mm AM/PM hh : mm AM/PM
10 : 30 PM 11 : 59 PM
_ : _ _ _ : _ _

```

Figure 8. Example: Base Period Overrides for Specific Dates in Month panel

## Editing base period definitions

You can edit existing base period definitions.

**Procedure**

To edit base period definitions:

1. From the Autonomics Director Primary Options Menu panel (**IAVPRIM**), select option **1 System administration** and press Enter.

The Autonomics Director System Administration Options Menu panel (**IAVPSAM**) is displayed.

2. Select option **1 Manage scheduling calendar**, and press Enter.

The Autonomics Director Scheduler: Period Management panel (**IAVPCLN**) is displayed.

3. Select option **2 Edit schedules** and press Enter.

The Edit Periods Filter panel (**IAVPEOP**) is displayed.

4. Apply a filter to narrow your search for operational definitions or press Enter to indicate no filtering.



- The Autonomics Director Maintenance Period Name List panel (**IAVPEPD**) is displayed.
5. Type S in the **Act** column of the period name to choose the period you want to edit.  
The Autonomics Director Scheduler: Edit Periods panel (**IAVPTOP**) is displayed.
  6. Type S in the **Action** column to select the period type to edit.  
Depending on the period type, one of the following panels is displayed:
    - Specify Base Period Overrides by Using Days of the Week (**IAVPCWO**) panel
    - Base Period Overrides for Specific Dates in Month (**IAVPBDT**) panel
    - Specify Base Period Overrides By Using Generic Dates In A Month (**IAVPBDY**) panel
  7. Edit the overrides, type SAVE, and press Enter.  
For more information about how to specify the base period overrides, see [“Defining overrides to the base period”](#) on page 45.
  8. Issue a **REFRESH SCHEDULE** server command to force the Autonomics Director server to use the updated definitions.

## Viewing the scheduling calendar

---

You can view the Autonomics Director scheduling calendar for selected days, weeks, or months.

### Procedure

The scheduling intervals are based on your period definitions for the selected dates.

To view the scheduling calendar:

1. From the Autonomics Director Primary Options Menu panel (**IAVPRIM**), select option **1 System administration** and press Enter.  
The Autonomics Director System Administration Options Menu panel (**IAVPSAM**) is displayed.
2. Select option **1 Manage scheduling calendar**, and press Enter.  
The Autonomics Director Scheduler: Period Management panel (**IAVPCLN**) is displayed.
3. Select option **3 View scheduling calendar** and press Enter.  
The View Periods Filter panel (**IAVPVOP**) is displayed.
4. Apply a filter to narrow your search of period names or press Enter to indicate no filtering.  
The Autonomics Director Maintenance Period Name List panel (**IAVPSPD**) is displayed.
5. Select the period for viewing and press Enter.  
By default, the View Scheduling Calendar by Day panel (**IAVPVBD**) is displayed.
6. Select a view option, display mode, and press Enter.

## Examples

### Example 1: Display the base period definitions for 15 June, 2024 by using option 1 (Day)

```

IAVPVBD                      View Scheduling Calendar by Day          Row 1 to 2 of 2
Command ===>                  Scroll ===> PAGE

Period name . . . : PEAK      << Month 06 Day 15 Year 24 >>
Current view . . . : Day      Su Mo Tu We Th Fr Sa
                                >
Change view . . . .          > 2 3 4 5 6 7 8
1: Day 2: Week              > 9 10 11 12 13 14 15
3: Month 4: All days        > 16 17 18 19 20 21 22
                                > 23 24 25 26 27 28 29
Display mode . . . . C      > 30
C: Clock G: Graphical

          Start                End
          hh : mm AM/PM        hh : mm AM/PM
08 : 00 AM          09 : 00 AM
01 : 00 PM          02 : 00 PM
04 : 00 PM          05 : 00 PM
  
```

Figure 9. Example: View Scheduling Calendar by Day panel

### Example 2: Display the period definitions for the week of 16 June, 2024 by using option 2 (Week)

```

IAVPVBW                      View Scheduling Calendar By Week        Row 1 to 3 of 3
Command ===>                  Scroll ===> CSR

Period name . . . : PEAK      << Week of JUN 16 Year 24 >>
Current view . . . : Week     Su Mo Tu We Th Fr Sa
                                >
Change view . . . .          > 2 3 4 5 6 7 8
1: Day 2: Week              > 9 10 11 12 13 14 15
3: Month 4: All days        > 16 17 18 19 20 21 22
                                > 23 24 25 26 27 28 29
Display mode . . . . C      > 30
C: Clock G: Graphical

          06/16  06/17  06/18  06/19  06/20  06/21  06/22
          Sunday Monday Tuesday Wednesday Thursday Friday Saturday
Start 09:00 AM 09:00 AM 09:00 AM 09:00 AM 09:00 AM 09:00 AM 09:00 AM
End   05:00 PM 05:00 PM 05:00 PM 05:00 PM 05:00 PM 05:00 PM 05:00 PM
  
```

Figure 10. Example: View Scheduling Calendar By Week panel

### Example 3: Display the period definitions for June, 2024 by using option 3 (Month)

```

IAVPVBM                      View Scheduling Calendar By Month        Row 1 to 14 of 30
Command ===>                  Scroll ===> CSR

Period name . . . : PEAK      << Month of JUN Year 24 >>
Current view . . . : Month

Change view . . . .          1: Day 2: Week 3: Month 4: All days
Display mode . . . . C      C: Clock G: Graphical

          Saturday, JUN 01          Sunday, JUN 02          Monday, JUN 03
          09:00 AM - 05:00 PM      09:00 AM - 05:00 PM  09:00 AM - 05:00 PM

          Tuesday, JUN 04          Wednesday, JUN 05          Thursday, JUN 06
          09:00 AM - 05:00 PM      09:00 AM - 05:00 PM  09:00 AM - 05:00 PM

          Friday, JUN 07          Saturday, JUN 08          Sunday, JUN 09
          09:00 AM - 05:00 PM      09:00 AM - 05:00 PM  09:00 AM - 05:00 PM

          Monday, JUN 10          Tuesday, JUN 11          Wednesday, JUN 12
          09:00 AM - 05:00 PM      09:00 AM - 05:00 PM  09:00 AM - 05:00 PM

          Thursday, JUN 13          Friday, JUN 14          Saturday, JUN 15
          09:00 AM - 05:00 PM      09:00 AM - 05:00 PM  09:00 AM - 05:00 PM
  
```

Figure 11. Example: View Scheduling Periods By Month panel

**Example 4: Display the base period definitions for 15 June, 2024 by using option 4 (All days)**

```

IAVPVBA                               View All Scheduling Periods           Row 1 to 11 of 188
Command ==>                           Scroll ==> CSR

Period name . . . : PEAK                << Month 06 Day 15 Year 24 >>
Current view . . . : All days

Change view . . . . : 1: Day 2: Week 3: Month 4: All days
Display mode . . . . C                  C: Clock G: Graphical

To see more scheduling calendar days, press Enter.

Date      Start      End
JUN 15, 24 08:00 AM 09:00 AM
            01:00 PM 02:00 PM
            04:00 PM 05:00 PM

JUN 16, 24 08:00 AM 09:00 AM
            01:00 PM 02:00 PM
            04:00 PM 05:00 PM

JUN 17, 24 08:00 AM 09:00 AM
            01:00 PM 02:00 PM
            04:00 PM 05:00 PM
    
```

Figure 12. Example: View All Scheduling Periods panel

**Example 5: Display the base period definitions for 15 June, 2024 by using option 4 (All days) in graphical mode**

```

IAVPXBD                               View Scheduling Calendar by Day       Row 1 to 2 of 2
Command ==>                           Scroll ==> CSR

Period name . . . : PEAK                << Month 06 Day 15 Year 24 >>
Current view . . . : Day
                                     > Su Mo Tu We Th Fr Sa
Change view . . . . -                 >  2  3  4  5  6  7  8
1: Day 2: Week                       >  9 10 11 12 13 14 15
3: Month 4: All days                  > 16 17 18 19 20 21 22
                                     > 23 24 25 26 27 28 29
Display mode . . . . G                 > 30

                                00..01..02..03..04..05..06..07..08..09..10..11.. AM
                                12..01..02..03..04..05..06..07..08..09..10..11.. PM
                                -----//-----
                                ---//-----//-----
    
```

Figure 13. Example: View Scheduling Calendar by Day panel

Each dash (-) character represents a 15-minute interval that contains a maintenance period of less than 7 minutes or no maintenance period at all.

If an interval is part of a maintenance period of more than 7 minutes, it is marked with a forward slash (/) character.

## Suspending the Autonomics Director scheduler

You can suspend the Autonomics Director scheduler by using the Autonomics Director ISPF interface or the **SUSPEND** command.

Subsections:

- [“Suspending the scheduler using the ISPF interface” on page 52](#)
- [“Suspending the scheduler using the SUSPEND command” on page 52](#)

## Suspending the scheduler using the ISPF interface

You can suspend the Autonomics Director scheduler by using the ISPF interface.

### Procedure

To suspend the scheduler:

1. From the Autonomics Director Primary Options Menu panel (**I**AVPRIM), select option **6 Operations**.

The Autonomics Director XCF Group Name List panel (**I**AVPSRV) is displayed.

2. Select row action **S** and press Enter.

The Autonomics Director Suspend Command Parameters panel (**I**AVPSSP) is shown.

3. Select a scheduling component to suspend and press Enter.

Message IAV6001I is issued to indicate a successful suspend.

4. Press F3 to return to the main panel, and repeat steps “1” on page 52 through “3” on page 52 for each scheduling component.

## Suspending the scheduler using the SUSPEND command

You can suspend the Autonomics Director scheduler by using the **SUSPEND** command.

Subsections:

- [“Format” on page 52](#)
- [“Usage” on page 52](#)
- [“Syntax” on page 52](#)
- [“Considerations” on page 53](#)
- [“Output from the SUSPEND command” on page 53](#)

### Format

► F — *server\_jobtask* , — SUSPEND — SERVER —►

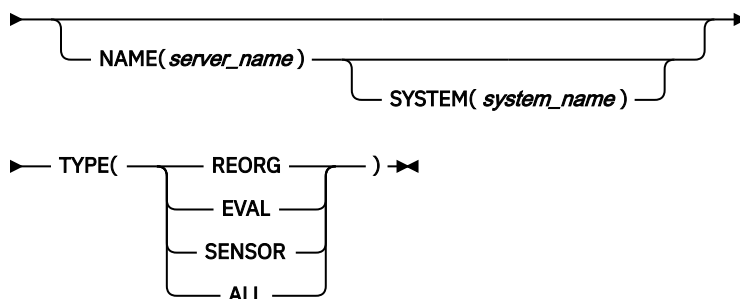

### Usage

Use the **SUSPEND** command to temporarily suspend Autonomics Director scheduling activities for the components listed in the TYPE parameter.

### Syntax

**F**

The MVS **MODIFY (F)** command that is used to issue commands on z/OS.

***server\_jobtask***

The Autonomics Director server job or started task name that the command is submitted to.

## SUSPEND

Requests that the servers suspend the component that is specified by the TYPE parameter.

## SERVER

Required positional parameter.

## NAME (*server\_name*)

Specifies the name of the server to suspend. The server name is the job or started task name of the server. It can also be specified as NAME (ALL) or NAME (\*) to indicate all servers. If this parameter is omitted, the default for *server\_name* is the same value that is specified for *server\_jobtask*.

## SYSTEM (*system\_name*)

The *system\_name* further qualifies the MVS system on which the processing server executes. The *system\_name* can be specified only if the NAME *server\_name* parameter is also specified. If this parameter is omitted, no system qualification is used.

## TYPE

Specifies the scheduler component type. Valid types are:

### REORG

Suspends the initiation of new database reorganizations or continues existing work for active database reorganizations.

### EVAL

Suspends the initiation of new policy and sensor evaluations.

### SENSOR

Suspends the initiation of new sensor data collections.

### ALL

Suspends all database reorganization activity and the initiation of new policy and sensor evaluations, and sensor data collection activities.

## Considerations

You can use the NAME (ALL) or NAME (\*) parameters only with commands that are entered through the z/OS console.

## Output from the SUSPEND command

The following example shows the output from the F *server\_name*, SUSPEND command:

```
IAV6001I - SUSPEND SERVER COMMAND EXECUTED
```

## Resuming the Autonomics Director scheduler

You can resume the Autonomics Director scheduler by using the Autonomics Director ISPF interface or the **RESUME** command.

Subsections:

- [“Resuming the scheduler using the ISPF interface” on page 53](#)
- [“Resuming the scheduler using the RESUME command” on page 54](#)

## Resuming the scheduler using the ISPF interface

You can resume the Autonomics Director scheduler by using the ISPF interface.

### Procedure

To resume the scheduler:

1. From the Autonomics Director Primary Options Menu panel (**IAVPRIM**), select option **6 Operations**.

- The Autonomics Director XCF Group Name List panel (**IIVPSRV**) is displayed.
2. Select row action **U** and press Enter.
- The Autonomics Director Resume Command Parameters panel (**IIVPSRP**) is shown.
3. Select a scheduling component to resume and press Enter. Message IAV6001I is issued to indicate a successful resume.
  4. Press F3 to return to the main panel and repeat for each scheduling component.

## Resuming the scheduler using the RESUME command

You can resume the Autonomics Director scheduler by using the **RESUME** command.

Subsections:

- [“Format” on page 54](#)
- [“Usage” on page 54](#)
- [“Syntax” on page 54](#)
- [“Considerations” on page 55](#)
- [“Output from the RESUME command” on page 55](#)

### Format

► F — *server\_jobtask* , — RESUME — SERVER ►

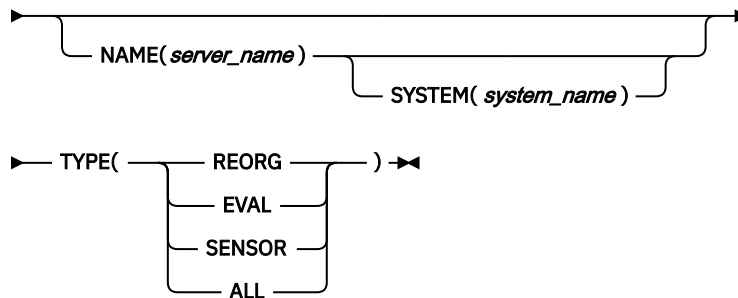

### Usage

Use the **RESUME** command to reinstate temporarily suspended Autonomics Director scheduling activities for the components listed in TYPE.

### Syntax

#### F

The MVS **MODIFY (F)** command that is used to issue commands on z/OS.

#### *server\_jobtask*

The Autonomics Director server job or started task name to which the command is submitted.

#### RESUME

Requests that the servers resume the component that is specified by the TYPE parameter.

#### SERVER

Required positional parameter.

#### NAME (*server\_name*)

Specifies the name of the server to resume. The server name is the job or started task name of the server. It can also be specified as NAME (ALL) or NAME (\*) to indicate all servers. If this parameter is omitted, the default for *server\_name* is the same value that is specified for *server\_jobtask*.

**SYSTEM (*system\_name*)**

The *system\_name* further qualifies the MVS system on which the processing server executes. The *system\_name* can be specified only if the NAME *server\_name* parameter is also specified. If this parameter is omitted, no system qualification is used.

**TYPE**

Specifies the scheduler component type. Valid types are:

**REORG**

Resumes the initiation of new database reorganizations or continues existing work for active database reorganizations.

**EVAL**

Resumes the initiation of new policy and sensor evaluations.

**SENSOR**

Resumes the initiation of new sensor data collections.

**ALL**

Resumes all database reorganization activity and the initiation of new policy and sensor evaluations, and sensor data collection activities.

**Considerations**

You can use the NAME (ALL) or NAME (\*) parameters only with commands that are entered through the z/OS console.

**Output from the RESUME command**

The following example shows the output from the F *server\_name*, RESUME command:

```
IAV6001I - RESUME SERVER COMMAND EXECUTED
```





---

## Chapter 8. Managing the monitor list

The Autonomics Director monitor list is a set of databases, partitions, and areas that are available for monitoring. You can add, update, delete, or change the owner of monitor list entries. The list of available Autonomics Director monitor list entries is populated automatically.

**Restriction:** Autonomics Director automatic discovery can locate only the master DBD.

### Topics:

- [“Adding or updating monitor list entries” on page 57](#)
- [“Deleting monitor list entries” on page 58](#)
- [“Changing monitor list entry ownership” on page 59](#)
- [“Reading a resource name from the IMS directory ” on page 59](#)

---

### Adding or updating monitor list entries

You can add or update monitor list entries from a list of available resources.

#### Before you begin

You must create skeleton JCL for use with DB Sensor. For more information about creating JCL for DB Sensor, see the *IMS Tools Base Configuration Guide*.

#### About this task

A list of available Autonomics Director resources is populated automatically. These entries can be added to or removed from the monitor list, and can also be updated.

**Restriction:** Autonomics Director automatic discovery can locate only the master DBD.

#### Notes:

- HSAM, SHSAM, LOGICAL, GSAM, and MSDB are not supported.
- If an IMS catalog alias is used in an IMS-managed ACBs environment, you can create monitor list entries for the IMS catalog alias DBDs.
- If an IMS catalog alias is used in an installation-managed ACB libraries (ACBLIBs) environment, you can create monitor list entries for the IMS catalog alias DBDs. Only catalog alias DBDs can be registered as monitor list entries although both the default catalog DBDs and catalog alias DBDs are listed in the ISPF user interface.

The following procedure explains how to add or update a single entry in the monitor list. If you want to add or update multiple entries at once, use the batch utility, Monitor List Registration utility (IAVBUTLO). For more information, see [“Monitor List Registration utility \(IAVBUTLO\)” on page 123](#).

#### Procedure

To add or update monitor list entries:

1. From the Autonomics Director Primary Options Menu panel (**IAVPRIM**), select option **1 System administration** and press Enter.

The Autonomics Director System Administration Options Menu panel (**IAVPSAM**) is displayed.

2. Select option **2 Manage monitor list**, and press Enter.

The Autonomics Director Resource Filter panel (**IAVPRSC**) is displayed.

3. Select a resource group type. You can specify a resource name qualifier to narrow your search to a specific DBRC, user group name, or database in the selected group type. A resource name qualifier

consists of the leading characters followed by an asterisk (\*). If you do not specify a resource name for the selected group type, all group names in the group type are retrieved for processing. Press Enter.

4. Type A in the **Action** column for a group and press Enter.

The Add or Update the Group and Database Attributes panel (**IAVPATT**) is displayed.

5. In the **Priority** field, specify the priority level (1 - 9) that is used when the database, database partition, or area is selected for evaluation. A value of 1 indicates the highest priority, which means that this database, partition, or area is evaluated first.
6. For both the REORG and RECOVERY domains, specify how Policy Services determines the name of the policy when the database or database partition or area is evaluated. Press Enter.
7. Optional: Enter the name of the cataloged data set that contains the sensor JCL member in the **Data set name** field. This name is required if the sensor JCL is to be submitted as a job. Leave this field blank if the sensor JCL is to run as a started task.
8. Optional: Enter the name of the member that contains the sensor JCL in the **Member name** field. This name is required if the sensor JCL data set is partitioned or if the sensor JCL is to run as a started task.

**Note:** The member name must be 7 characters or less. The name specified is the JCL member used for REORG sensor collection. The member name appended with the letter Y is the JCL member name used for RECOVERY sensor collection.

## What to do next

Change accumulation group (CAGRP) collections (used for change accumulation autonomies) can be created and managed using option **5 (Manage CA group collections)** from the Autonomics Director Primary Options Menu > System Administration menu.

## Deleting monitor list entries

---

You can delete resources from the monitor list.

### About this task

The list of available Autonomics Director resources is populated automatically. These entries can be added to or deleted from the monitor list.

**Important:** All of the defined parameters and evaluation history for the monitored resource are lost after it is deleted from the monitor list.

A resource that is a member of an active group-managed reorganization group cannot be deleted. You must deactivate the group before removing any monitor list entries.

### Procedure

To delete monitor list entries:

1. From the Autonomics Director Primary Options Menu panel (**IAVPRIM**), select option **1 System administration** and press Enter.

The Autonomics Director System Administration Options Menu panel (**IAVPSAM**) is displayed.

2. Select option **2 Manage monitor list**, and press Enter.

The Autonomics Director Resource Filter panel (**IAVPRSC**) is displayed.

3. Select a resource group type. You can specify a resource name qualifier to narrow your search to a specific DBRC, user group name, or database in the selected group type. A resource name qualifier consists of the leading characters followed by an asterisk (\*). If you do not specify a resource name for the selected group type, all group names in the group type are retrieved for processing. Press Enter.
4. Enter action D for a database. Press Enter.

The Confirm Monitor List Entry Deletion panel (**IAVPMED**) is displayed.

5. Optional: In the **Turn off the monitor list entry delete confirmation** field, specify any character to turn off this confirmation panel.
6. Press Enter to confirm the deletion.

## Changing monitor list entry ownership

---

You can change the owner of monitor list entries to a different TSO user ID.

### About this task

Changing the owner of monitor list entries has implications on the RACF user ID that is used when sensor data collection jobs are submitted.

### Procedure

To change the owner:

1. From the Autonomics Director Primary Options Menu panel (**IAVPRIM**), select option **1 System administration** and press Enter.

The Autonomics Director System Administration Options Menu panel (**IAVPSAM**) is displayed.

2. Select option **4 Acquire monitor list entry ownership**, and press Enter.

The Acquire Monitor List Entry Ownership panel (**IAVPOWN**) is displayed.

3. Enter the TSO user ID of the current owner of the monitor list entries and press Enter.

All entries that are owned by the TSO ID entered are assigned to your TSO ID.

## Reading a resource name from the IMS directory

---

In an IMS-managed ACBs environment, Autonomics Director can retrieve DBD data from the IMS directory.

### About this task

If IMSCATHLQ, the high-level qualifier of the bootstrap data set for the IMS directory, is registered with the ITKB repository, Autonomics Director retrieves DBD data from the IMS directory. If IMSCATHLQ is not registered, it retrieves DBD data from the DBD library.

For DB Sensor jobs, you need to specify additional parameters so that those jobs can run in IMS-managed ACBs environments.

### Notes:

- DBD data registered with the Autonomics Director monitor list is not updated automatically. If the DBDLIB and the IMS directory contain different DBD data, update monitor list entries.
- Logical DBD and GSAM DBD are not supported.
- Staging data sets for the IMS directory are not supported.

### Procedure

To set up Autonomics Director for IMS-managed ACBs environments, follow this procedure:

1. Add the SGLXLOAD library to the Autonomics Director server STEPLIB concatenation.

For details, see the topic "[Configuring an Autonomics Director server](#)" in the *IMS Tools Base Configuration Guide*.

2. Register IMSCATHLQ with the ITKB client.

For details, see the topic "[RECON ID \(locale\) administration](#)" in the *IMS Tools Base Configuration Guide*.

3. Refresh the RECON information in Autonomics Director.

For details, see [“Refreshing the Autonomics Director server resources”](#) on page 39.

4. Update the skeleton JCL for DB Sensor jobs for IMS-managed ACBs environments.
  - For FF Stand-alone DB Sensor, see the topic "GLOBAL command keywords for FF Stand-alone DB Sensor" in the *IMS Solution Packs Data Sensor User's Guide*.
  - For FP Stand-alone DB Sensor, see the topic "GLOBAL command keywords for FP Stand-alone DB Sensor" in the *IMS Solution Packs Data Sensor User's Guide*.

---

## Chapter 9. Scheduling and automating

The following information explains how to manage the primary components of Autonomics Director.

### Topics:

- [“Scheduling a reorganization or area extension” on page 61](#)
- [“Scheduling on-demand sensor data collection and policy evaluations” on page 67](#)
- [“Automating monitoring and maintenance tasks” on page 68](#)
- [“Viewing recommendations” on page 69](#)
- [“Reference: Batch interface” on page 70](#)

---

### Scheduling a reorganization or area extension

You can schedule reorganizations and DEDB area extensions on user groups. To schedule or initiate these activities, you must create a user group, add resources to the group, assign user group attributes, and activate the group.

You can initiate reorganization and area extensions by using the Autonomics Director scheduler, on demand through the Autonomics Director interface, or through an external job scheduling system.

Subsections:

- [“Creating a user group” on page 61](#)
- [“Deleting a user group” on page 63](#)
- [“Adding databases to a user group” on page 63](#)
- [“Modifying user group attributes” on page 64](#)
- [“Activating or deactivating user groups” on page 65](#)
- [“Scheduling on-demand reorganizations and area extensions” on page 66](#)
- [“Pausing, continuing, or canceling reorganizations and area extensions” on page 66](#)
- [“Viewing reorganization and area extension history of user-defined groups” on page 67](#)

### Creating a user group

You can create customized groups of databases from a list of available database resources that are defined in the DBDLIB and DBRC groups. If the IMS-managed ACBs function is enabled, database groups can be created from the IMS directory. These groups are used when initiating or scheduling group-managed reorganizations and DEDB area extensions.

#### About this task

You can include a database in one or more user groups.

#### Procedure

To create a user group:

1. From the Autonomics Director Primary Options Menu panel (**IAVPRIM**), select option **1 System administration** and press Enter.

The Autonomics Director System Administration Options Menu panel (**IAVPSAM**) is displayed.

2. Select option **3 Manage user groups**.

The Autonomics Director Group Administration Options Menu panel (**IAVPGAM**) is displayed.

3. Select option **1 Create user groups** and press Enter.

The Autonomics Director New User Group Name panel (**IAVPNEW**) is displayed.

- Specify the group name and description and press Enter. The group name can contain a maximum of 8 characters and the name must be unique within all group types.

The Autonomics Director Group List panel (**IAVPGRL**) is displayed.

- To add databases, partitions and areas to the group, enter **SELECT** on the command line.

The Autonomics Director Resource Filter panel (**IAVPRSC**) is displayed.

- Select a resource group type. You can specify a resource name qualifier to narrow your search to a specific DBRC, user group name, or database in the selected group type. A resource name qualifier consists of the leading characters followed by an asterisk (\*). If you do not specify a resource name for the selected group type, all group names in the group type are retrieved for processing. Press Enter.
- Type A in the **Action** column for a group, database, partition or area and press Enter.

**Important:** If A is entered in the **Action** column for a group, all databases in the group are added to the confirmation list. If any database on the list has external references, these externally referenced databases are also included in the list. Externally referenced databases can be primary or secondary index databases or databases that are logically related to the selected database. All externally referenced databases are forced to belong to the same group. The result is that when a database is reorganized, the logically related databases are also reorganized or scanned to resolve the relationships.

The primary and secondary indexes databases are rebuilt when the database is reorganized but they can also be reorganized independently as part of the group

- Press Enter to confirm.
- Continue to add more members from the same resource or switch to another input source by pressing F3 (END).
- Optional: Enter the **VIEWX** command to view the relationships among the databases added, as shown in the example.

```
IAVPXRN      Autonomics Director Database External Refere Row 1 to 10 of 10
Command ==>                               Scroll ==> PAGE

Group name . . . . . : DD
Group description . . :

---External references---
DBDName  Ptr/Type Relation DBName  DBORG  ACCESS
RCNDBD1  *                RCNINDBX INDBX  VSAM
<--/DIR  PINDEX   RCNINDBX INDBX  VSAM
-->/DIR  LPARNT   RCNDBD2  HDAM   VSAM

RCNINDBX *                RCNDBD1  HDAM   VSAM
                LCHILD  RCNDBD1  HDAM   VSAM

RCNDBD2  *                RCNDBD1  HDAM   VSAM
                LCHILD  RCNDBD1  HDAM   VSAM
```

RCNDBD1 is a HIDAM database and has a primary index database RCNINDBX that uses direct pointers, or a relative byte address pointer, to access its target segment. RCNDBD1 also has a logical parent pointer to a segment in RCNDBD2. RCNDBD2 has a logical child segment in RCNDBD1. There is no pointer from the LPARNT in RCNDBD2 to the LCHILD in RCNDBD1.

- In the Autonomics Director Group List panel (IAVPGRL), specify the reorganization JCL or the scan JCL. For information about specific fields, press F1 to view the embedded help.
- When you are finished adding databases, partitions, and areas to the group, type SAVE and press Enter.

## Deleting a user group

You can delete user groups from the list of resources.

### About this task

The list of available Autonomics Director resources is populated when you create a user group.

### Procedure

To delete a user group:

1. From the Autonomics Director Primary Options Menu panel (**IAVPRIM**), select option **1 System administration** and press Enter.

The Autonomics Director System Administration Options Menu panel (**IAVPSAM**) is displayed.

2. Select option **3 Manage user groups**.

The Autonomics Director Group Administration Options Menu panel (**IAVPGAM**) is displayed.

3. Select option **2 Edit or view user groups** and press Enter.

The Autonomics Director User Group Selection Criteria panel (**IAVPGSC**) is displayed.

4. Narrow your search of resources to a specific user group name. Press Enter.

If you do not specify a group name, all group names in the group type are retrieved for processing.

5. Select row action **D** and press Enter.

The Autonomics Director Confirm Group Delete panel (IAVPGDL) is displayed.

6. Optional: In the **Turn off the monitor list entry delete confirmation** field, specify any character to turn off this confirmation panel.

7. Press Enter to confirm the deletion.

## Adding databases to a user group

You can add databases to user groups for group managed reorganization.

### About this task

The list of available Autonomics Director resources is populated when you create a user group.

### Procedure

To add a database to a group:

1. From the Autonomics Director Primary Options Menu panel (**IAVPRIM**), select option **1 System administration** and press Enter.

The Autonomics Director System Administration Options Menu panel (**IAVPSAM**) is displayed.

2. Select option **3 Manage user groups**.

The Autonomics Director Group Administration Options Menu panel (**IAVPGAM**) is displayed.

3. Select option **2 Edit or view user groups** and press Enter.

The Autonomics Director User Group Selection Criteria panel (**IAVPGSC**) is displayed.

4. Narrow your search of resources to a specific user group name. Press Enter. If you do not specify a group name, all group names in the group type are retrieved for processing.

5. In the Autonomics Director User Group List panel (IAVPUGL), select row action **S** and press Enter. The Autonomics Director Group List panel (IAVPGRL) is displayed.

6. To add databases, partitions and areas to the group, enter **SELECT** on the command line.

The Autonomics Director Resource Filter panel (**IAVPRSC**) is displayed. In this panel, you can select the input source of database groups, databases, partitions and areas to add to the new group.

7. Select a resource group type. You can specify a resource name qualifier to narrow your search to a specific DBRC, user group name, or database in the selected group type. A resource name qualifier consists of the leading characters followed by an asterisk (\*). If you do not specify a resource name for the selected group type, all group names in the group type are retrieved for processing. Press Enter.

8. Type A in the **Action** column for a group, database, partition, or area and press Enter.

**Important:** If A is entered in the **Action** column for a group, all databases in the group are added to the confirmation list. If any database on the list has external references, these externally referenced databases are also included in the list. Externally referenced databases can be primary or secondary index databases or databases that are logically related to the selected database. All externally referenced databases are forced to belong to the same group. The result is that when a database is reorganized, the logically related databases are also reorganized or scanned to resolve the relationships.

The primary and secondary indexes databases are rebuilt when the database is reorganized.

9. Press Enter to confirm.

10. Continue to add more members from the same resource or switch to another input source by pressing F3 (END).

11. Enter the **VIEWX** command to view the relationships among the databases added as shown in the example.

```

IAVPXRN      Autonomics Director Database External Refere Row 1 to 10 of 10
Command ====>                               Scroll ====> PAGE

Group name . . . . . : DD
Group description . . :

DBDName      ---External references---
RCNDBD1      *
              <--/DIR  PINDEX   RCNINDX  INDEX   VSAM
              -->/DIR  LPARNT   RCNDBD2  HDAM    VSAM

RCNINDX      *
              LCHILD   RCNDBD1  HIDAM   VSAM
              LCHILD   RCNDBD1  HIDAM   VSAM

RCNDBD2      *
              LCHILD   RCNDBD1  HIDAM   VSAM
  
```

RCNDBD1 is a HIDAM database and has a primary index database RCNINDX that uses direct pointers, or a relative byte address pointer, to access its target segment. RCNDBD1 also has a logical parent pointer to a segment in RCNDBD2. RCNDBD2 has a logical child segment in RCNDBD1. There is no pointer from the LPRNT in RCNDBD2 to the LCHILD in RCNDBD1.

12. In the Autonomics Director Group List panel (IAVPGRL), specify the reorganization JCL or the scan JCL. For information about specific fields, press F1 to view the embedded help.

13. Type SAVE and press Enter.

## Modifying user group attributes

To implement group-managed reorganization and DEDB areas extensions at the user group level, you must specify values for various user group attributes.

### Procedure

To modify user group attributes:

1. From the Autonomics Director Primary Options Menu panel (**IAVPRIM**), select option **1 System administration** and press Enter.

The Autonomics Director System Administration Options Menu panel (**IAVPSAM**) is displayed.



2. Select option **3 Manage user groups**.

The Autonomics Director Group Administration Options Menu panel (**IAVPGAM**) is displayed.

3. Select option **3 Assign reorganization and area extend group attributes** and press Enter.

The Autonomics Director User Group Selection Criteria panel (**IAVPGSC**) is displayed.

4. Narrow your search of resources to a specific user group name or leave the group name blank to view all group names in the group type. Press Enter.

The Autonomics Director User Group List panel (**IAVPRAT**) is displayed.

5. Select row action **S** and press Enter.

The Autonomics Director User Group Attributes panel (**IAVPGAT**) is displayed.

6. Specify the attributes and press Enter.

For information about specific attribute fields, press F1 to view the embedded help.

User group attributes for group-managed reorganization include **Notification list name**, **Priority**, **Maximum parallel reorganization jobs**, **Reorganization interval**, and **REORG option**.

User group attributes for SDEP extensions and IOVF extensions of Fast Path DEDB areas include **IMS affinity**, **SDEP extension option**, and **IOVF extension option**.

## Activating or deactivating user groups

You can activate or deactivate user groups for reorganizations and area extensions.

### About this task

The list of available Autonomics Director user groups is populated automatically.

**Important:** User groups must be activated before you initiate a reorganization or area extension. User groups must be deactivated before you make changes to the group, including adding or deleting members or modifying group attributes.

### Procedure

To activate or deactivate user groups:

1. From the Autonomics Director Primary Options Menu panel (**IAVPRIM**), select option **1 System administration** and press Enter.

The Autonomics Director System Administration Options Menu panel (**IAVPSAM**) is displayed.

2. Select option **3 Manage user groups**.

The Autonomics Director Group Administration Options Menu panel (**IAVPGAM**) is displayed.

3. Select option **4 Monitor reorganization and area extend groups**, and press Enter.

The Autonomics Director User Group Selection Criteria panel (**IAVPGSC**) is displayed.

4. Optional: Narrow your search of resources to a specific user group name and press Enter.

If you do not specify a group name, all group names in the group type are retrieved for processing.

The Autonomics Director: Group Monitor List panel (**IAVPGML**) is displayed.

5. To activate the user group, select row action **A** and press Enter.
6. To deactivate the user group, select row action **D** and press Enter. Autonomics Director Confirm Delete Member from Monitor panel (**IAVPDML**) is displayed.
  - a) To complete the group deactivation process including deletion of any member from the monitor list, press ENTER.
  - b) To complete the group deactivation process without deleting any member from the monitor list, press F3 (END).

For information about specific fields, press F1 to view the embedded help.

## Scheduling on-demand reorganizations and area extensions

You can initiate or schedule group-managed reorganizations and DEDB area extensions on the members of a user group.

### Before you begin

Before you can initiate an on-demand reorganization or area extension:

- The database group must contain members.
- The database group must be activated.

### Procedure

To initiate or schedule an on-demand reorganization or area extension:

1. From the Autonomics Director Primary Option Menu panel (**IAVPRIM**), select option **5 Schedule reorganization and area extend on demand**.

The Autonomics Director User Group Selection Criteria panel (**IAVPGSC**) is displayed.

2. Optional: Narrow your search of resources to a specific user group name and press Enter.

If you do not specify a group name all group names in the group type are retrieved for processing.

The Autonomics Director Scheduler: Group List panel (**IAVPSRD**) is displayed.

3. Select row action **X** and press Enter.

The Schedule Group Reorg and Area Extend Run On Demand panel (**IAVPRAD**) is displayed.

- a) Specify the reorganization and area extension condition.
- b) Specify the schedule time option.
- c) Press Enter.

### Results

The Autonomics Director Scheduler: Group List panel (**IAVPSRD**) is displayed with a message in the prompt field that indicates the reorganization is initiated.

## Pausing, continuing, or canceling reorganizations and area extensions

You can pause, continue, or cancel a reorganization or area extension job that is running.

### Procedure

To pause, continue, or cancel a reorganization or area extension:

1. From the Autonomics Director Primary Options Menu panel (**IAVPRIM**), select option **3 Manage group reorganization and area extend activity**.

The Autonomics Director User Group Selection Criteria panel (**IAVPGSC**) is displayed.

2. Optional: Narrow your search of resources to a specific user group name and press Enter.

If you do not specify a group name, all group names in the group type are retrieved for processing.

The Autonomics Director User Group List panel (**IAVPUHL**) is displayed.

3. Select row action **C** for the group you want to pause, continue, or cancel reorganization or area extension and press Enter.

The Autonomics Director Monitor Status Change (**IAVPOPA**) is displayed.

4. Choose the menu option that corresponds to the command you want to run. Press Enter.

If the command is successful, a completion message is shown.

## Viewing reorganization and area extension history of user-defined groups

You can view the reorganization and area extension history of user-defined groups.

### Procedure

To view the history:

1. From the Autonomics Director Primary Option Menu panel (IAVPRIM), select option **3 Manage group reorganization and area extend activity**.

The Autonomics Director User Group Selection Criteria panel (**IAVPGSC**) is displayed.

2. Optional: Narrow your search of resources to a specific user group name and press Enter.

If you do not specify a group name, all group names in the group type are retrieved for processing.

The Autonomics Director User Group List panel (**IAVPUHL**) is displayed.

3. Select row action **S** and press Enter.

The Autonomics Director Reorganization and Area Extend History panel (**IAVPVGL**) is displayed.

4. Select row action **S** and press Enter.

The Autonomics Director Reorganization Job Status panel (**IAVPVJL**) is displayed.

5. Enter S for the pre-GMR job to see job details.

## Scheduling on-demand sensor data collection and policy evaluations

---

You can initiate immediate or delayed sensor data collection and policy evaluations.

### About this task

In addition to automatic sensor data collection and policy evaluations, you can schedule on-demand sensor data collection and policy evaluations immediately, on a specified date, or after a specified date.

On-demand job submissions are accomplished by using the TSO user ID of the requester, so this user ID must have the proper RACF authority. The TSO user ID on the on-demand REORG issuer is used on all JOB submissions.

### Procedure

To schedule collection and evaluations:

1. From the Autonomics Director Primary Options Menu panel, select option **4 Schedule sensor and policy evaluation on demand** and press Enter.

The View Recommendation Lists Resource Type Filter panel (**IAVPSCD**) is displayed.

2. Select a resource group type and press Enter.

The View Recommendation List: Group Type Filter panel (**IAVPFLT**) is displayed.

3. Apply a filter to narrow your search to monitor list members that have specific attributes or press Enter to indicate no filtering.

The Autonomics Director Monitor List Entries panel (**IAVPXML**) is displayed.

4. From the Autonomics Director Monitor List Entries panel, select row action X and press Enter.

The Schedule Sensor or Evaluation Job Run On Demand panel (**IAVPXAD**) is displayed.

- a. Specify Y to schedule an on demand sensor data collection, policy evaluation, or both.

If you do not select policy evaluation, a policy evaluation still runs if you previously added the resource to the monitor list and enabled the **Evaluate after sensor run** option. Similarly, if you do not schedule a sensor data collection, a sensor data collection still runs under the following

conditions: the age of the sensor data exceeds the specified maximum and a policy evaluation is requested. For more information, see [“Adding or updating monitor list entries” on page 57](#).

b. Specify the schedule time option.

With option **2** or **3**, enter the date and time to schedule the runs. Enter the time in the appropriate time format (AM/PM or 24-hour clock). You can enter a question mark (?) in the month field to display the current month.

c. Press Enter.

The Sensor Run Overrides panel (**IAVPSAI**) is displayed.

d. Specify the optional sensor JCL overrides and press Enter.

The Schedule Evaluation Overrides panel (**IAVPSAE**) is displayed.

e. Specify the option from Policy name selection that determines the policy name that is used to perform the evaluation run and press Enter.

If you specify option **3** and the policy name is not known, you can enter a question mark (?) in the policy name field to get a list of available policy names.

The Schedule Sensor/Evaluation Job Information panel (**IAVPSSI**) is displayed.

## Automating monitoring and maintenance tasks

---

You can automate sensor data collections, policy evaluations, and database maintenance tasks (reorganizations and DEDB area extensions) through Autonomics Director. To learn about the Online Space Management utility for IMS Fast Path DEDBs in the active autonomics environment, see the topic "Using the Online Space Management utility in the active autonomics environment" in the *IMS High Performance Fast Path Utilities User's Guide*.

### Before you begin

Complete the following prerequisite tasks:

- Prepare the necessary skeleton JCL for Autonomics Director.
- Configure the Autonomics Director server.
- Create or customize your policies by using the Policy Services interface.

### Procedure

Complete one of the following tasks, depending whether you want to automate database maintenance tasks in addition to sensor data collections and policy evaluations.

- To automate sensor data collections and policy evaluations only:
  - a) Create a peak schedule that defines when Autonomics Director collects sensor data and conducts evaluations.
    - a. Define the default time intervals (base period) for a regular day. For more information, see [“Defining the base period” on page 44](#).

The base period is in effect every day, except on days that have overrides. The base period must be called PEAK.
    - b. Define overrides to the base period. For more information, see [“Defining overrides to the base period” on page 45](#).
  - b) Add your databases and areas to the monitor list to activate them for sensor data collections and evaluations. For more information, see [“Adding or updating monitor list entries” on page 57](#).

The *monitor list* is a set of databases, partitions, and areas that are eligible for monitoring in Autonomics Director. When you add resources to the monitor list, you associate each resource with a maintenance period and specify how often each resource is monitored.

- c) View any recommendations that are issued by the policy evaluation and decide whether to initiate a database maintenance task through Autonomics Director. Recommendations are generated based on the results of policy evaluations. For more information, see [“Viewing recommendations” on page 69](#).
- d) Optional: You can issue on-demand reorganizations and DEDB area extensions through Autonomics Director at your discretion.  
However, before you initiate a reorganization or area extension, complete the following prerequisite tasks:
  - a. Create one or more user groups and add the activated databases to those user groups. For more information, see [“Creating a user group” on page 61](#).
  - b. Add your new user groups to the monitor list. For more information, see [“Activating or deactivating user groups” on page 65](#).

After you complete the prerequisite tasks, see [“Scheduling on-demand reorganizations and area extensions” on page 66](#) for information about issuing on-demand reorganizations and DEDB area extensions.
- To automate sensor data collections, policy evaluations, and database maintenance tasks (reorganizations and DEDB area extensions):
  - a) Create schedules that define when Autonomics Director collects sensor data, conducts evaluations, and administers maintenance tasks (such as reorganizations).
    - a. Define the default time intervals (base period) for a regular day. The base period is in effect every day, except on days that have overrides. For more information, see [“Defining the base period” on page 44](#).  
*A **peak period** defines time intervals during which no sensor data collection or policy evaluations are scheduled. The name of the peak period must be PEAK. A **maintenance period** defines time intervals during which maintenance tasks (such as reorganizations) can take place.*
    - b. Define overrides to the base period. For more information, see [“Defining overrides to the base period” on page 45](#).
  - b) Add your databases and areas to the monitor list to activate them for sensor data collections and evaluations. For more information, see [“Adding or updating monitor list entries” on page 57](#).  
*The **monitor list** is a set of databases, partitions, and areas that are eligible for monitoring in Autonomics Director. When you add resources to the monitor list, you associate each resource with a maintenance period and specify how often each resource is monitored.*
  - c) Create one or more user groups and add your activated databases to those user groups. For more information, see [“Creating a user group” on page 61](#).  
Reorganizations and DEDB area extensions are scheduled at the user group level.
  - d) Activate the resources in the user groups for automatic database maintenance tasks. For more information, see [“Activating or deactivating user groups” on page 65](#).  
This task involves adding your new user groups to the monitor list and enabling the parameters related to the tasks that you would like to automate.  
  
After a user group is activated for one or more automated tasks (reorganizations, SDEP extensions, or IOVF extensions), Autonomics Director schedules those tasks on an as-needed basis, during the specified maintenance period. Autonomics Director determines whether a task is necessary by monitoring the results of policy evaluations.

## Viewing recommendations

---

You can view current recommendations for a database and view evaluation history.

### About this task

Autonomics Director evaluates the most recent database sensor data against your defined policies and rules and recommends when a database reorganization or DEDB area extension is needed.

## Procedure

To view recommendations:

1. From the Autonomics Director Primary Option Menu panel, select option **2 View recommendation lists** and press Enter.

The View Recommendation Lists Resource Type Filter panel (**IAMPSCD**) is displayed.

2. Select a resource group type and press Enter.

The View Recommendation List: Group Type Filter panel (**IAMPFLT**) is displayed.

3. Apply a filter to narrow your search to monitor list members that have specific attributes or press Enter to indicate no filtering.

The Autonomics Director Monitor List Entries panel (**IAMPXML**) is displayed.

4. From the Autonomics Director Monitor List Entries panel (**IAMPXML**), select row action **V** and press Enter.

The Evaluation Run Information panel (**IAMPVRL**) is displayed.

5. Optional: Enter a forward slash (/) to view the evaluation run exceptions and press Enter.

The Database Diagnosis Report is displayed.

For more information on the messages displayed, see the *IMS Tools Base Policy Services User's Guide and Reference*.

## Reference: Batch interface

---

You can use the batch interface to request on-demand sensor data collection, policy evaluations, group-managed reorganizations, IOVF extensions, and SDEP extensions.

Data collections, policy evaluations, and reorganizations can be done on a database, partition, or area basis. IOVF and SDEP extensions can be done on Fast Path DEDB areas.

The batch interface is compatible with external job schedulers.

For each line of a command that continues into the next line, insert a non-blank character (such as a plus sign (+)) in column 72. A non-blank character in column 72 serves as a continuation marker.

Submit the job and ensure that it completes with a return code of RC=0.

Subsections:

- [“EXEC and DD statements” on page 70](#)
- [“Example syntax diagram: Schedule a reorganization” on page 71](#)
- [“Example syntax diagram: Schedule an IOVF or SDEP extension” on page 71](#)
- [“Example syntax diagram: Schedule a sensor collection or policy evaluation” on page 71](#)
- [“SYSIN control statements” on page 72](#)
- [“Example batch job” on page 75](#)

### EXEC and DD statements

#### EXEC statement

```
EXEC PGM=IAVBATCH, PARM='adgroup, recondsn'
```

#### **adgroup**

Required parameter. The name of the Autonomics Director server XCF group.

#### **recondsn**

Optional parameter. The DBRC RECON1 data set name that identifies the IMS Tools KB RECON environment that is associated with batch requests.

If omitted, IAVBATCH uses the RECON1 DFSMDA dynamic allocation member from STEPLIB/ JOBLIB to obtain the RECON1 data set name.

## DD statements

### SYSPRINT

Contains the batch interface report log which shows the input control statements, options, and results from the interface execution.

### SYSIN

Contains the input command control statements.

## Example syntax diagram: Schedule a reorganization

The following diagram shows the syntax of the **EXECUTE** command when scheduling a reorganization:

►► EXECUTE — REORG — GROUPTYPE( — USERGRP — ) — GROUPNAME( *grpname* ) —►

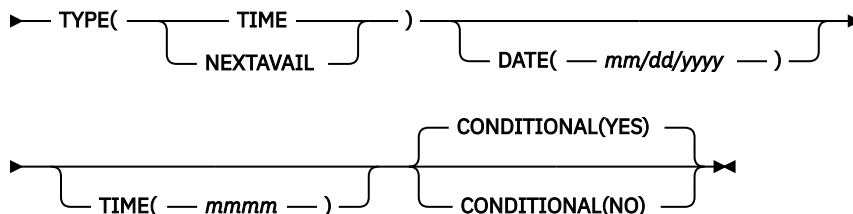

## Example syntax diagram: Schedule an IOVF or SDEP extension

The following diagram shows the syntax of the **EXECUTE** command when scheduling an IOVF extension or SDEP extension on a Fast Path DEDB area:

►► EXECUTE — REORG — GROUPTYPE( — USERGRP — ) — GROUPNAME( *grpname* ) —►

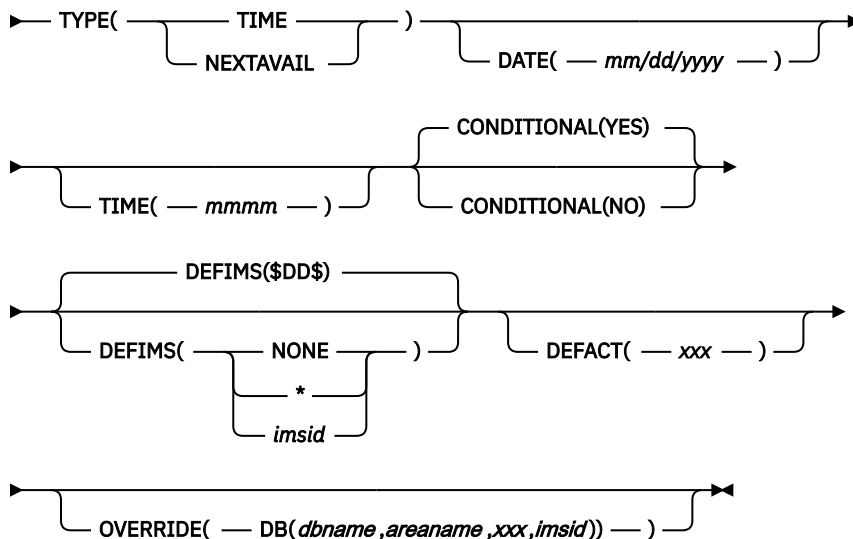

## Example syntax diagram: Schedule a sensor collection or policy evaluation

The following diagram shows the syntax of the **EXECUTE** command when scheduling a sensor data collection or policy evaluation:

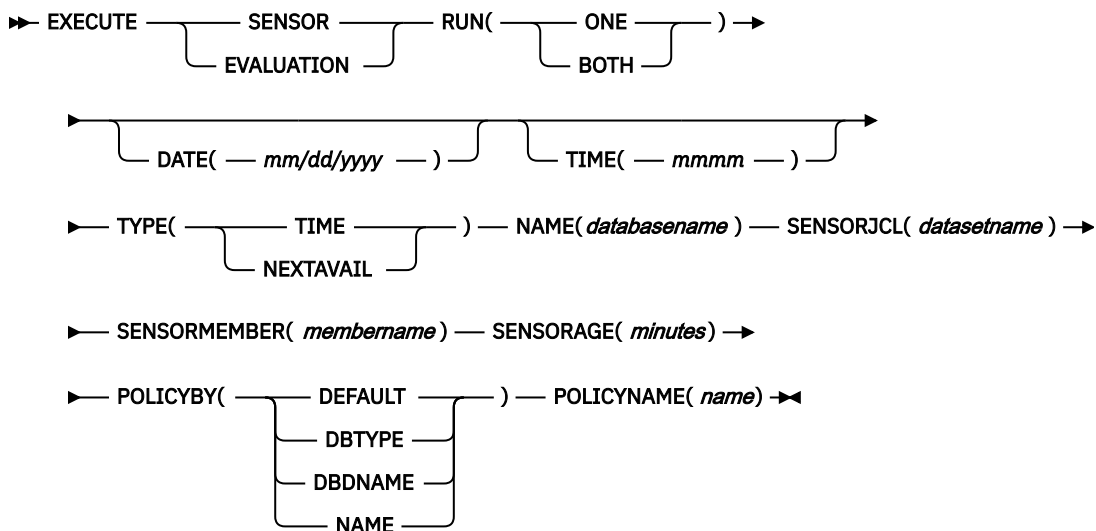

## SYSIN control statements

### EXECUTE

Specifies the command verb.

### REORG

Specifies that group-managed reorganization is started.

### SENSOR

Specifies that sensor data collection is started.

### EVALUATION

Specifies that policy evaluation is started.

### RUN(ONE | BOTH)

Specifies whether sensor data collection, policy evaluation, or both are run.

#### ONE

Run either sensor data collection or policy evaluation.

#### BOTH

Run sensor data collection and policy evaluation.

### TYPE(TIME | NEXTAVAIL)

Specifies whether to run immediately or to defer until next non-peak period.

#### TIME

If TYPE(TIME) is specified but no DATE and TIME keywords, then the reorganization run is scheduled for immediate execution.

If TYPE(TIME) is specified along with DATE and TIME keywords, the reorganization run is scheduled to run at the specified data and time.

The TYPE(TIME) specification does not take into consideration any period definitions. It will be scheduled immediately or at the date and time specified.

#### NEXTAVAIL

If TYPE(NEXTAVAIL) is specified but no DATE and TIME keywords, the reorganization run is scheduled at the first available period that allows it to start.

If TYPE(NEXTAVAIL) is specified along with DATE and TIME keywords, the reorganization run is scheduled at the first available period that allows it to start at or after the specified date and time.

### NAME(databasename)

Specifies the database name.

If the database is a Fast Path DEDB area or a HALDB partition, specify the area or partition name as the second subparameter.



For example, NAME (\$DBNAME\$, \$ARNAME\$).

**SENSORJCL(*datasetname*)**

Specifies the fully qualified data set name that contains the sensor job streams that are being submitted.

**SENSORMEMBER(*membername*)**

Specifies the member name that contains the JCL for the sensor data collection run.

This parameter is optional if the SENSORJCL data set is non-partitioned (sequential organization).

**SENSORAGE(*minutes*)**

Specifies the maximum sensor data age in minutes.

If the sensor data is older than the current time interval, a sensor run is scheduled before an evaluation run.

**POLICYBY(DEFAULT | DBTYPE | DBDNAME | NAME)**

Specifies how Policy Services determines the name of the REORG policy when the database, database partition, or area is evaluated.

**DEFAULT**

The policy name is determined in the same manner as DBTYPE (using the database organization form) when the database, database partition, or area is evaluated.

**DBTYPE**

The policy name is determined by using the database organization form.

**DBDNAME**

The policy name is determined by using the policy name that is associated with the database.

**NAME**

The policy name is determined by using the policy name that is specified in the data set name field.

**POLICYNAME(*name*)**

Specifies the policy name that is used for REORG evaluation.

This parameter is used in conjunction with POLICYBY(NAME). For example, POLICYBY(*name*) POLICYNAME(*name*).

**GROUPTYPE(USERGRP)**

Specifies the group type. For REORG, it is USERGRP.

**GROUPNAME(*grpname*)**

Specifies the name of the group that is being reorganized.

**CONDITIONAL(YES | NO)**

Specifies whether you want a reorganization run to be scheduled only if a reorganization is required.

**YES**

Specifies that the group is scheduled for a reorganization only if any of the members of the group requires reorganization.

The 'Reorg needed' condition is set by an earlier evaluation of the group member.

**NO**

Specifies that the reorganization run is to be scheduled unconditionally.

**DATE(*mm/dd/yyyy*)**

Specifies the date when the job is to be run. If you specify the DATE keyword, specify the TIME keyword, too. If both keywords are omitted, the job runs immediately.

**TIME(*mmmm*)**

Specifies the time when the job is to be run. If you specify the TIME keyword, specify the DATE keyword, too. If both keywords are omitted, the job runs immediately.

**DEFIMS(\$DD\$ | NONE | \* | *imsid*)**

Specifies the IMS affinity. The IMS affinity is the IMS ID of an IMS online system that is used to complete scheduled tasks, including reorganizations or area extensions.

For reorganizations and area extensions of Fast Path DEDB areas, an IMS affinity is required.

### **\$DD\$**

Uses the default *imsid* value that is determined by the rules as described in the [tip](#).

\$DD\$ is the default.

### **NONE**

Specifies that no IMS system is associated with the job. Autonomics Director runs the job regardless of which IMS systems are running. MVS Workload Management determines which system the job should be run on.

### **\***

The job is run on any available MVS system.

The MVS system must have an active IMS participating in the TOSI group.

### ***imsid***

The job is submitted to the MVS on which the specified IMS online system is running. The IMS online system is identified by the IMS affinity ID (*imsid*).

The TOSI XCF group name that is associated with the IMS system must be specified in the RECON definition.

For more information about TOIXCF, the field for the TOSI XCF group name, see the *IMS Tools Base Configuration Guide*.

**Tip:** You can also specify an IMS affinity ID in the following circumstances:

- At the database level when you issue an on-demand reorganization or area extension.
- At the user group level when you issue an on-demand reorganization or area extension.
- For a database when you add databases to a user group.
- For a user group when you define a user group.

The IMS affinity can be changed at the group level or at the database level. If an IMS affinity value is specified at the database level, that value overrides any IMS affinity value that is specified at the user group level.

When no IMS affinity is specified at any level, the Autonomics Director default is used.

### **DEFACT(*xxx*)**

The 3-character value *xxx* specifies whether to run reorganizations, SDEP extensions, and IOVF extensions on the DEDB areas in the user group.

- The first character of *xxx* is for reorganizations.
- The second character is for SDEP extensions.
- The third character is for IOVF extensions.

Each value of *x* is either:

#### **D**

The default action is used.

#### **Y**

The action is submitted.

#### **N**

The action is not submitted.

DEFACT(DDD) is the default value.

For example, if DEFACT(YDN) is specified, the following actions occur:

- The DEDB areas in the user group are reorganized.
- The IOVF portion of the areas is extended if the default value is Y.
- The SDEP portion of the areas is not extended.

**Tip:** You can also specify whether to run reorganizations, SDEP extensions, and IOVF extensions on DEDB areas in the following circumstances:

- When you issue an on-demand reorganization or area extension.
- When you define a user group.
- When you add databases to a user group.

**OVERRIDE(*dbname, areaname, xxx, imsid*)**

Specifies an override for a specific area, with the following values:

***dbname***

The name of the database.

***areaname***

The name of the area.

***xxx***

Specifies whether to run reorganizations, SDEP extensions, and IOVF extensions for the specified DEDB area.

- The first character of *xxx* is for reorganizations.
- The second character is for SDEP extensions.
- The third character is for IOVF extensions.

Each value of *x* is either:

**D**

The default action is used.

**Y**

The action is submitted.

**N**

The action is not submitted.

***imsid***

The IMS ID of the IMS online system.

### Example batch job

In the following example, a plus sign (+) is used in column 72 as a continuation marker.

```
EXECUTE EVALUATION RUN(ONE) TYPE(TIME) NAME(DEVICEDB)      +
SENSORJCL('IMT00LB.ITB14.FPQ12.JCLLIB')                    +
SENSORMEMBER(SENSOR)                                       +
POLICYBY(DBTYPE)
```



---

# Chapter 10. Troubleshooting

Messages, abend codes, and diagnostic information can help you diagnose and correct problems with Autonomics Director

## Topics:

- [“Runtime error messages \(IAV\)” on page 77](#)
- [“Database evaluation error messages ” on page 102](#)
- [“Abend codes” on page 103](#)
- [“Sensor data extractor API return and reason codes” on page 105](#)
- [“Frequently asked questions” on page 106](#)
- [“Gathering diagnostic information” on page 107](#)

---

## Runtime error messages (IAV)

Use the information in these messages to help you diagnose and solve Autonomics Director problems.

### Message format

Autonomics Director messages adhere to the following format:

```
IAVnnnnx
```

#### IAV

Indicates that the message was issued by Autonomics Director.

#### nnnn

Indicates the message identification number.

#### x

Indicates the severity of the message:

#### A

Indicates that operator intervention is required before processing can continue.

#### E

Indicates that an error occurred, which might or might not require operator intervention.

#### I

Indicates that the message is informational only.

#### W

Indicates that the message is a warning to alert you to a possible error condition.

Each message also includes the following information:

#### Explanation

The Explanation section explains what the message text means, why it occurred, and what its variables represent.

#### System action

The System action section explains what the system does in response to the event that triggered this message.

#### User response

The User response section describes whether a response is necessary, what the appropriate response is, and how the response affects the system or program.

---

**IAVD460I      COULD NOT LOCATE DATABASE IN THE DBDLIB**

---

**Explanation**

The Autonomics Director database discovery task did not find the database that is being added to the monitor list in the DBDLIB.

**System action**

Processing continues.

**User response**

Make sure that the DBD entry exists in the DBDLIB for the database that you are adding to the monitor list.

**Explanation**

The Autonomics Director database discovery task did not find the database that is being added to the monitor list in the IMS directory.

**System action**

Processing continues.

**User response**

Make sure that the DBD entry exists in the IMS directory for the database that you are adding to the monitor list.

---

**IAVD461I      THE DATABASE IS NOT STORED IN ITKB**

---

**Explanation**

The Autonomics Director data discovery task did not store the database in the IMS Tools KB INPUT repository.

**System action**

Processing continues.

**User response**

None. This message is informational.

---

**IAVD470E      CANNOT CONNECT TO HKT\_INPUT REPOSITORY**

---

**Explanation**

The Autonomics Director database discovery task did not connect to the HKT\_INPUT repository.

**System action**

Processing continues. Autonomics Director does not store the discovery data for the database in the IMS Tools KB repository.

**User response**

Contact IBM Software Support and provide the Autonomics Director job log.

---

**IAVD462I      COULD NOT LOCATE RECON DATA SETS**

---

**Explanation**

The Autonomics Director database discovery task did not locate the RECON data sets to retrieve database attributes.

**System action**

Processing continues.

**User response**

Verify that the RECON data sets that are specified in the RECON ID record are accessible.

---

**IAVD471E      FAILED TO CREATE ITKB DB RECORD MEMBER**

---

**Explanation**

The Autonomics Director database discovery task did not create a database record member in the HKT\_INPUT repository.

**System action**

Processing continues. Autonomics Director does not store the discovery data for the database in the IMS Tools KB repository.

**User response**

Contact IBM Software Support and provide the Autonomics Director job log.

---

**IAVD464I      COULD NOT LOCATE DATABASE IN THE IMS DIRECTORY.**

---

---

**IAVD472E      COULD NOT LOCATE THE DB MEMBER IN ITKB**

---

## Explanation

The Autonomics Director database discovery task did not locate the database member in the HKT\_INPUT repository.

## System action

Processing continues. Autonomics Director does not store the discovery data for the database in the IMS Tools KB repository.

## User response

Contact IBM Software Support and provide the Autonomics Director job log.

---

**IAVD473E          DELETE ITKB DB MEMBER FAILED**

## Explanation

The Autonomics Director database discovery task did not delete the database member in the HKT\_INPUT repository.

## System action

Processing continues. Autonomics Director does not store the discovery data for the database in the IMS Tools KB repository.

## User response

Contact IBM Software Support and provide the Autonomics Director job log.

---

**IAVD474E          ADD ITKB DB RECORD FAILED**

## Explanation

The Autonomics Director database discovery task did not add the database record to the HKT\_INPUT repository.

## System action

Processing continues. Autonomics Director does not store the discovery data for the database in the IMS Tools KB repository.

## User response

Contact IBM Software Support and provide the Autonomics Director job log.

---

**IAVD475E          WRITE ITKB DB MEMBER FAILED**

## Explanation

The Autonomics Director database discovery task did not write the database member to the HKT\_INPUT repository.

## System action

Processing continues. Autonomics Director does not store the discovery data for the database in the IMS Tools KB repository.

## User response

Contact IBM Software Support and provide the Autonomics Director job log.

---

**IAVD476E          CREATE ITKB DUMMY MEMBER FAILED**

## Explanation

The Autonomics Director database discovery task did not create the dummy member in the HKT\_INPUT repository.

## System action

Processing continues. Autonomics Director does not store the discovery data for the database in the IMS Tools KB repository.

## User response

Contact IBM Software Support and provide the Autonomics Director job log.

---

**IAVD477E          ITKB WRITE DUMMY MEMBER FAILED**

## Explanation

The Autonomics Director database discovery task did not write the dummy member to the HKT\_INPUT repository.

## System action

Processing continues. Autonomics Director does not store the discovery data for the database in the IMS Tools KB repository.

## User response

Contact IBM Software Support and provide the Autonomics Director job log.

---

**IAV0002I          task-id TCB INITIALIZATION COMPLETE**

## Explanation

Initialization for an Autonomics Director task *task-id* has successfully completed.

## System action

Autonomics Director initialization continues.

## User response

None. This message is informational.

---

**IAV0003I**      ***task-id* TCB TERMINATION  
COMPLETE**

## Explanation

Termination for an Autonomics Director task *task-id* has completed.

## System action

Autonomics Director termination continues.

## User response

None. This message is informational.

---

**IAV0004I**      **AD SYSTEM INITIALIZATION  
COMPLETE**

## Explanation

Initialization for Autonomics Director has successfully completed.

## System action

Autonomics Director continues normal operation.

## User response

None. This message is informational.

---

**IAV0005E**      **KEY 7 EXECUTION REQUIRED**

## Explanation

An error has been detected in the Autonomics Director server program execution key. The Autonomics Director servers are required to execute in key 7.

## System action

The Autonomics Director server abnormally terminates with a user abend U0050-X'0A'.

## User response

An MVS Program Properties Table entry must be created for program IAVCI000 with a key 7 specification.

---

**IAV0007E**      **INVALID TYPE= PARAMETER**

## Explanation

An error has been detected in the initialization of the Autonomics Director server address space. The TYPE= subparameter specification on the job step PARM= is invalid.

## System action

The address space abnormally terminates with a user abend U0050-X'1E'.

## User response

Correct the TYPE= specification to reflect the proper address space type.

---

**IAV0010E**      **INVALID CONFIGURATION  
MEMBER SPECIFIED**

## Explanation

An invalid PROCLIB configuration member name was specified on the JCL execute statement.

## System action

Autonomics Director abnormally terminates with a user abend U0070-X'28'.

## User response

Specify a valid PROCLIB member name for the IAVCFG= subparameter on the JCL execute statement.

---

**IAV0015I**      **SERVER *server* IS NOW THE  
MASTER SERVER FOR GROUP  
*group***

## Explanation

The role of master server has been transferred from the original master server to another active or failover server.

## System action

Processing continues.

## User response

None. This message is informational.



---

**IAV0020E**      **INVALID CONFIGURATION  
PARAMETER SPECIFIED -  
parameter**

### Explanation

The PROCLIB configuration parameter indicated in the message was specified incorrectly.

### System action

The Autonomics Director server abnormally terminates with user abend U0070-X'28'.

### User response

Correct the specified parameter value. This parameter is in the Autonomics Director server configuration member.

---

**IAV0022I**      **THE AD SCHEDULING IS  
INITIALIZED**

### Explanation

The Autonomics Director scheduling has completed processing the period definitions for the day and is initialized for work.

### System action

None.

### User response

None. This message is informational.

---

**IAV0023I**      **ERROR TERMINATING AD  
REPOSITORY CONNECTION ON  
xxxxxxx, RC=return, RSN=reason**

### Explanation

An error was encountered while attempting to terminate the connection on node xxxxxxx. RC indicates the return code, and RSN indicates the reason code.

### System action

The Autonomics Director server continues terminating.

### User response

See the IMS Tools KB return and reason codes for more information.

---

**IAV0024I**      **CONNECTED TO THE AD  
REPOSITORY ON xxxxxxxx**

### Explanation

Autonomics Director is connected to the Policy Services Autonomics Director repository on node xxxxxxxx.

### System action

None.

### User response

None. This message is informational.

---

**IAV0025I**      **CAN NOT CONNECT TO  
AD REPOSITORY ON server,  
RC=return, RSN=reason**

### Explanation

Autonomics Director cannot connect to the Autonomics Director repository located on *server*. RC indicates the return code, and RSN indicates the reason code.

### System action

Processing continues.

### User response

Review your IMS Tools KB configuration and retry.

---

**IAV0026I**      **DISCONNECTED FROM THE AD  
REPOSITORY ON server**

### Explanation

Autonomics Director disconnected from the IMS Tools KB Autonomics Director repository located on *server*.

### System action

Processing continues.

### User response

Review your IMS Tools KB configuration and retry.

---

**IAV0027I**      **AD PROCESSING IS STARTED**

### Explanation

Autonomics Director is started and ready to accept users.

### System action

None.

## User response

None. This message is informational.

---

**IAV0028I**      **AD PROCESSING IS SUSPENDED,  
NO CONNECTION TO THE  
REPOSITORY ON xxxxxxxx**

## Explanation

Autonomics Director detects that the connection to the IMS Tools KB server has been lost, which indicates that IMS Tools KB has been stopped. The variable xxxxxxxx indicates the name of the active server.

## System action

Autonomics Director remains active, but rejects all commands and does not perform any scheduled work. Autonomics Director resumes processing when IMS Tools KB comes back online.

## User response

None. This message is informational.

---

**IAV0029I**      **AD PROCESSING IS RESUMED,  
THE CONNECTION IS RESTORED  
TO THE REPOSITORY ON xxxxxxxx**

## Explanation

The Autonomics Director server detected that IMS Tools KB is back online again. The variable xxxxxxxx indicates the name of the active server.

## System action

Autonomics Director processing is resumed.

## User response

None. This message is informational.

---

**IAV0030E**      **INVALID AWE FUNCTION FOR  
SERVER *server***

## Explanation

An asynchronous work element (AWE) with an invalid function identifier was detected by an Autonomics Director server AWE server *server*. This is error is an internal Autonomics Director problem.

## System action

The invalid AWE is ignored and the Autonomics Director server continues.

## User response

Contact IBM Software Support.

---

**IAV0033E**      **INCOMPATIBLE REPOSITORIES  
ARE DETECTED**

## Explanation

Inappropriate repositories are found.

## System action

The Autonomics Director server abnormally terminates with a user abend U0070-X'071'.

## User response

Check if the connected IMS Tools Knowledge Base server and repositories are correct. If they are correct, make sure that the repository conversion process has been properly completed. If not, migrate the repositories from IMS Tools Base 1.6 to 1.7 again.

---

**IAV0034E**      **INSUFFICIENT ACCESS  
AUTHORITY**

## Explanation

An attempt to access an Autonomics Director repository data set failed because the server has insufficient RACF privileges.

## System action

The Autonomics Director server abnormally terminates with a user abend U0070-X'072'.

## User response

Ensure that the access rights to the Autonomics Director repository are correct.

---

**IAV0035E**      **EXCEPTION DEFINITION  
TABLE INITIALIZATION FAILED  
RC=*retcode*, RSN=*rsncode***

## Explanation

An error occurred during initialization of an internal table called the exception definition table. The exception definition table was not created.

## System action

The Autonomics Director server abnormally terminates with a user abend U0070-X'080'.

## User response

Restart the Autonomics Director server. Contact IBM Software Support and have them investigate the root cause by using the dump information.

---

**IAV0036E            EXCEPTION DEFINITION TABLE  
                      ERROR DETECTED**

## Explanation

An error was detected while reading an internal table called the exception definition table during policy evaluation.

## System action

The Autonomics Director server abnormally terminates with a user abend U0070-X'081'.

## User response

Restart the Autonomics Director server. Contact IBM Software Support and have them investigate the root cause by using the dump information.

---

**IAV0040W            ITKB SERVER TERMINATION  
                      DETECTED**

## Explanation

Autonomics Director detected that the IMS Tools Knowledge Base server terminated.

This message is generally followed by [“IAV0026I”](#) on page 81, [“IAV0706W”](#) on page 85, and [“IAV0028I”](#) on page 82.

## System action

None.

## User response

Check the status of the IMS Tools Knowledge Base server.

---

**IAV0041I            ITKB SERVER AVAILABILITY  
                      DETECTED**

## Explanation

An available IMS Tools KB server has been detected.

## System action

Processing continues.

## User response

None. This message is informational.

---

**IAV0086E            ROUTER *router* SERVICE FAILURE  
                      RC=*return*, RSN=*reason***

## Explanation

Autonomics Director routing services encountered an error while working with MVS Workload Management.

## System action

Routing Services are not available at this time. Only local routing can be used.

## User response

If this problem persists contact IBM Software Support.

---

**IAV0087I            *display command output***

## Explanation

This is a generic message that contains output from the Autonomics Director **DISPLAY** command. The message content varies depending on the type of **DISPLAY** command that is used.

## System action

None.

## User response

None. This message is informational.

---

**IAV0088E            DCB SYNAD EXIT TAKEN FOR  
                      DDNAME *name***

## Explanation

While attempting to access the sensor JCL from the user specified data set, an error was encountered.

## System action

The JCL is not accessible and the sensor job was not submitted.

## User response

Search the Autonomics Director server job log for accompanying message IEC141I that explains the cause of the error.

---

**IAV0089E            DCB ABEND EXIT TAKEN  
                      FOR DDNAME *name*, RC=*return*,  
                      RSN=*reason***

## Explanation

While attempting to access sensor JCL from the data set specified by the user, an error was encountered. The RC indicates the return code and the RSN indicates the reason code.

## System action

The JCL is not accessible and the sensor job was not submitted.

## User response

Contact IBM Software Support.

---

**IAV0090E**      **SUBMIT *service* SERVICE FAILURE**  
**RC=*return*, RSN=*reason***

## Explanation

While attempting to submit sensor JCL to the internal reader an error was encountered.

## System action

It is unknown if the sensor JCL was submitted based upon the specific nature of the error.

## User response

Contact IBM Software Support with the information provided in the service, return, and reason values.

---

**IAV0430E**      **XCF *service* SERVICE FAILURE RC=**  
***retcode*, RSN=*rsncode***

## Explanation

A cross-system coupling facility (XCF) request failed. The requested *service* in the message indicates the failing XCF service. RC= indicates the return codes and RSN= indicates the reason codes that are returned by XCF.

## System action

Processing continues unless the error is critical to the caller of XCF services.

## User response

A common cause of XCF errors is a missing Autonomics Director component address space. Another cause might be an improperly specified XCF group or member name for a component address space. For more information about XCF services, see the *z/OS MVS Programming: Sysplex Services*

*Reference.* If the problem persists, Contact IBM Software Support.

---

**IAV0600W**      **SAF *service* SERVICE FAILURE**  
**SAF=*safrc*, RC=*retcode*, RSN=**  
***rsncode***

## Explanation

A System Authorization Facility (SAF) service request failed. The requested *service* in the message indicates the failing SAF/RACF (or equivalent) service. SAF= indicates the SAF return code returned in R15 from the call to SAF. RC= and RSN= indicate the return and reason codes returned by RACF (or equivalent).

## System action

Autonomics Director server processing continues. The authorization request might be denied.

This warning is generally caused by the RACF protection of entering IMS Autonomics Director commands from the Autonomics Director client or submission of sensor jobs.

## User response

Additional information about SAF services can be found in the *z/OS Security Server RACROUTE Macro Reference*.

If the problem persists, contact IBM Software Support.

---

**IAV0700I**      **SERVER START COMPLETED**

## Explanation

The server is now ready to accept client connections.

## System action

None.

## User response

None. This message is informational.

---

**IAV0701I**      **READY FOR DATABASE**  
**EVALUATIONS**

## Explanation

Autonomics Director has successfully connected to the IMS Tools KB repository, Policy Services, and Sensor Data environments.

## System action

Waiting for database evaluation request.

## User response

You can begin performing database evaluations by using Autonomics Director.

---

**IAV0702I      READY FOR RECOVERY  
EVALUATIONS**

---

## Explanation

The Autonomics Director environment has IMS Recovery Solution Pack.

## System action

Processing continues. RECOVERY sensor data is collected and evaluated.

## User response

None. This message is informational.

---

**IAV0703W      RECOVERY EVALUATIONS ARE  
NOT SUPPORTED**

---

## Explanation

The Autonomics Director environment does not have IMS Recovery Solution Pack.

## System action

Processing continues. No RECOVERY sensor data is collected and evaluated.

## User response

Make sure that IMS Recovery Solution Pack is registered in IMS Tools Knowledge Base.

---

**IAV0704I      RECOVERY SENSOR AND  
EVALUATION AUTOMATION IS  
DISABLED**

---

## Explanation

The Autonomics Director environment has IMS Recovery Solution Pack installed. However, Recovery Sensor data collection and evaluation jobs will not be performed automatically because automation of these jobs is disabled.

## System action

Processing continues.

## User response

None. This message is informational.

---

**IAV0705W      UNABLE TO PROCESS DATABASE  
EVALUATIONS-INIT FAILED**

---

## Explanation

Autonomics Director cannot connect to the Policy Services or Sensor Data Extractor environments. Database evaluations cannot be performed.

## System action

The Autonomics Director server abnormally terminates with a user abend U0070-X'2C1'.

## User response

Examine the job log for any error messages prefixed with BSN for a possible cause of the failure.

Also, examine the job log of the IMS Tools Knowledge Base server for any error messages prefixed with FPQ to find out a possible cause of the failure.

If there is no BSN or FPQ message that indicates a possible cause of the failure, the Sensor Data repository might have stopped. Change the BSN\_SENSOR repository to the START state by using the IMS Tools Knowledge Base ISPF interface. For details, see the topic "[Starting and stopping repositories \(ISPF\)](#)" in the *IMS Tools Base IMS Tools Knowledge Base User's Guide and Reference*.

---

**IAV0706W      UNABLE TO PROCESS DATABASE  
EVALUATIONS-ITKB DOWN**

---

## Explanation

Database evaluations cannot be performed because the connection to the IMS Tools KB repository was lost or never established.

## System action

None.

## User response

Verify that the Autonomics Director connection to the IMS Tools KB repository is properly configured and that the IMS Tools KB is up and running.

---

**IAV0707I      READY FOR REORG EVALUATIONS**

---

## Explanation

The Autonomics Director environment is ready to run DB Sensor jobs.

### System action

Processing continues. DB Sensor data is collected and evaluated.

### User response

None. This message is informational.

---

**IAV0708I DB SENSOR AND EVALUATION  
AUTOMATION IS DISABLED**

### Explanation

DB Sensor data collection and evaluation jobs will not be performed automatically because automation of these jobs is disabled.

### System action

Processing continues.

### User response

None. This message is informational.

---

**IAV0720E THE NOTIFICATION SERVICE  
FAILED, SERVICE= *service*, RC=*rc*,  
RSN=*rsn***

### Explanation

An error occurred during Autonomics Director User Notification Service processing. The service name, return code, and reason code are displayed.

### System action

The user notification occurs.

### User response

Verify that the Autonomics Director connection to the IMS Tools KB notification repository is properly configured and that the IMS Tools KB is up and running.

---

**IAV0722E THE NOTIFICATION  
SERVICE FAILED, UNKNOWN  
NOTIFICATION LIST *name***

### Explanation

The Autonomics Director User Notification Service failed to send a notification message because the notification list name was not found in the IMS Tools KB notification list repository.

### System action

The notification message is not sent.

### User response

Correct the notification list name. The incorrect notification list name could be in either the IMS Tools KB notification list repository or the Autonomics Director monitor list.

---

**IAV0900I SHUTDOWN SCHEDULED**

### Explanation

The Autonomics Director server received a scheduled shutdown request.

### System action

The Autonomics Director server has internally queued the request for shutdown. Shutdown processing continues when all outstanding Autonomics Director server requests have been processed.

### User response

None. This message is informational.

---

**IAV0990I A/S CLEANUP COMPLETE**

### Explanation

The Autonomics Director server has completed the final phase of termination processing.

### System action

Autonomics Director server address space termination follows immediately.

### User response

None. This message is informational.

---

**IAV0997E SDUMP FAILED FOR ABEND *abend*,  
*retcode*, *rsncode***

### Explanation

Autonomics Director error recovery attempted to issue an SDUMP macro/service to capture diagnostic information for the ABEND *abend* in the message. The SDUMP macro/service returned a nonzero return code (*retcode*). The SDUMP reason code (*rsncode*) is also contained in the message.

## System action

The SDUMP failure has no impact on any Autonomics Director address space.

## User response

Additional information about SDUMP return codes can be found in the *z/OS MVS Programming: Authorized Assembler Services Reference, Volume 3 (LLACOPY-SDUMPX)*. If the problem persists, contact IBM Software Support.

---

**IAV0998I**      **DAE SUPPRESSED DUMP FOR  
ABEND *abend***

## Explanation

Autonomics Director error recovery attempted to issue an SDUMP macro/service to capture diagnostic information for the ABEND *abend* in the message. The SDUMP was suppressed by MVS dump analysis and elimination (DAE). Autonomics Director recovery routines gather symptom string data related to an *abend* and provide this data to MVS when an SDUMP is requested. If DAE is enabled, MVS suppresses duplicate dumps; for example, dumps that have symptom strings identical to previously captured dumps are suppressed. DAE is controlled through the MVS ADYSETxx PARMLIB member and the MVS **SET DAE** command. For details on specifying DAE options, see the *z/OS MVS Initialization and Tuning Reference*.

## System action

The SDUMP is skipped. An Autonomics Director generated dump is suppressed if its symptom string matches a previous dump, and if the current DAE setting in ADYSETxx is either SUPPRESS OR SUPPRESSALL.

## User response

None. This message is informational.

---

**IAV0999E**      **IMS AD *component subcomponent*  
ABEND *abend***

## Explanation

Autonomics Director error recovery detected an ABEND *abend* in component *component* and subcomponent *subcomponent*.

## System action

Autonomics Director error recovery attempts to generate a system dump to capture diagnostic data.

## User response

Retain the generated system dump and contact IBM Software Support.

---

**IAV1000E**      **ENVIRONMENT REQUESTED BY  
RECON EXTID NOT FOUND.**

## Explanation

The RECON environment that the client requested is not found.

## System action

The Autonomics Director command request fails.

## User response

Ensure that RECON ID is correct. When a RECON ID is added to or changed in the IMS Tools Knowledge Base repository, you must perform the Autonomics Director REFRESH RECON process. See “Refreshing the Autonomics Director server resources” on page 39.

---

**IAV5000E**      **THE OPEN FAILED FOR THE  
SYSPRINT DDNAME**

## Explanation

The Autonomics Director batch client (IAVBATCH) failed to open the DDNAME SYSPRINT.

## System action

IAVBATCH terminates with an error.

## User response

Add or correct the SYSPRINT DD statement.

---

**IAV5001E**      **THE OPEN FAILED FOR THE SYSIN  
or SYSPUNCH DDNAME**

## Explanation

The Autonomics Director batch client (IAVBATCH) failed to open the DDNAME SYSIN. For an execution of the Pre-scan utility (IAVXSCAN), the open failed for DDNAME SYSPUNCH.

## System action

IAVBATCH or the IAVXSCAN utility terminates with an error.

## User response

Add or correct the SYSIN or SYSPUNCH DD statement.

---

**IAV5002E      A SYNTAX ERROR WAS  
FOUND WHILE PARSING INPUT  
PARAMETERS**

### Explanation

The Autonomics Director batch client (IAVBATCH) detected a syntax error on the EXEC statement PARM= parameters.

### System action

IAVBATCH terminates with an error.

### User response

Refer to “Reference: Batch interface” on page 70.

Review the EXEC statement PARM= parameters *adgroup* and *recondsn* and correct the syntax.

---

**IAV5003E      THE LOAD OPERATION FAILED  
FOR THE DFSMDA MEMBER FOR  
RECON1**

### Explanation

The Autonomics Director batch client (IAVBATCH) failed to load the DFSMDA member for RECON1 from the STEPLIB or JOBLIB data set.

### System action

IAVBATCH terminates with an error.

### User response

To fix this issue, complete one of the following actions:

- Add the library that contains the DFSMDA member for RECON1 to the STEPLIB or JOBLIB data set concatenation.
- Supply the data set name for RECON1 on the EXEC statement PARM= parameter.

---

**IAV5004E      AD FAILED TO CONNECT TO  
THE SSI INTERFACE WITH  
SERVICE=xxxxxxxx, RC=xxxxx,  
RSN=xxxx**

### Explanation

The Autonomics Director batch client (IAVBATCH) received an error when it tried to connect to the Autonomics Director subsystem interface.

### System action

IAVBATCH terminates with an error.

### User response

Verify that the Autonomics Director subsystem interface is properly installed on the system where the batch client is running. For information about installing and updating the Autonomics Director subsystem interface, see the *IMS Tools Base Configuration Guide*.

If the problem persists, contact IBM Software Support.

---

**IAV5005E      THE COMMAND INPUT CANNOT  
SPAN MORE THAN 16 INPUT  
STATEMENTS**

### Explanation

A single Autonomics Director batch client (IAVBATCH) input command spanned more than 16 input statements.

### System action

IAVBATCH terminates with an error.

### User response

Reduce the number of continued input statements.

---

**IAV5006E      AN EOF WAS FOUND WHILE  
RETRIEVING THE COMMAND  
CONTINUATION RECORD**

### Explanation

The Autonomics Director batch client (IAVBATCH) expected a continued command input statement but instead reached an EOF (end-of-file) in the SYSIN control statement.

### System action

IAVBATCH terminates with an error.

### User response

Correct the erroneous command input statement.

---

**IAV5007E      THE MASTER AD SERVER CANNOT  
BE LOCATED**

### Explanation

The Autonomics Director batch client (IAVBATCH) tried to locate the Autonomics Director master server but it is not available.

### System action

IAVBATCH terminates with an error.



## User response

To fix this issue, complete one of the following actions:

- If an alternate server is available, resubmit the job.
- If an alternate server is not available, start the Autonomics Director master server and then resubmit the job.

---

**IAV5008E AN INVALID RESPONSE WAS RECEIVED FROM THE AD SERVER - NO REQBLK**

## Explanation

The Autonomics Director batch client (IAVBATCH) received an invalid response from the Autonomics Director server.

## System action

IAVBATCH terminates abnormally.

## User response

Save the output from the batch client job and review the Autonomics Director configuration. For more information about the Autonomics Director server environment, see the *IMS Tools Base Configuration Guide*.

If the problem persists, contact IBM Software Support.

---

**IAV5009E THE MASTER AD SERVER HAS TERMINATED.**

## Explanation

The Autonomics Director batch client (IAVBATCH) detected that the Autonomics Director master server has terminated.

This error can impact commands that are in process by the client and server. The SYSPRINT execution log provides more detail on what was processed before the Autonomics Director master server terminated.

## System action:

IAVBATCH terminates with an error.

## User response

To fix this issue, perform one of the following:

- If an alternate server is available, resubmit the job.
- If an alternate server is not available, start the Autonomics Director master server and resubmit the job.

---

**IAV5010W AN INVALID AWE WAS FOUND - NO GEPL**

## Explanation

The Autonomics Director batch client (IAVBATCH) received an invalid XCF notification about a member of the batch client XCF group.

## System action

IAVBATCH continues running.

## User response

If the problem persists, contact IBM Software Support.

---

**IAV5011E INCOMPATIBLE RELEASE LEVELS FOR THE AD SERVER AND BATCH CLIENT**

## Explanation

The Autonomics Director batch client (IAVBATCH) and Autonomics Director master server are not at the same release level.

## System action

IAVBATCH terminates with an error.

## User response

Ensure that both the Autonomics Director batch client and Autonomics Director master server are at the same release level.

---

**IAV5500E A SYNTAX ERROR WAS FOUND WHILE PARSING INPUT PARAMETERS**

## Explanation

The Autonomics Director notification utility (IAVXNTFY) or Pre-Scan utility (IAVXSCAN) detected a syntax error on the EXEC statement PARM= parameters.

## System action

The IAVXNTFY or IAVXSCAN utility terminates with an error.

## User response

Review the input parameters and correct the syntax.

---

**IAV5503E THE LOAD OPERATION FAILED FOR THE DFSMDA MEMBER FOR RECON1**

## Explanation

The Autonomics Director notification utility (IAVXNTFY) or Pre-Scan utility (IAVXSCAN) failed to load the DFSMDA member for RECON1 from the STEPLIB or JOBLIB data set.

## System action

IAVXNTFY or IAVXSCAN terminates with an error.

## User response

To fix this issue, complete one of the following actions:

- Add the library that contains the DFSMDA member for RECON1 to the STEPLIB or JOBLIB data set concatenation.
- Supply the data set name for RECON1 on the EXEC statement PARM= parameter.

---

**IAV5505E**      **AN INVALID *parmname*  
PARAMETER WAS FOUND  
WHILE PARSING THE INPUT  
PARAMETERS**

## Explanation

The Autonomics Director notification utility (IAVXNTFY) or Pre-Scan utility (IAVXSCAN) was validating the input parameters passed on the EXEC statement PARM= parameters. The *parmname* input parameter was found to be invalid.

## System action

The IAVXNTFY or IAVXSCAN utility terminates with an error.

## User response

Review the input parameter syntax and correct the invalid parameter.

---

**IAV5510E**      **THE AD NOTIFY  
INTERFACE FAILED WITH  
SERVICE=XXXXXXXX, R15=XXXX,  
RC=XXXX, RSN=XXXX**

## Explanation

The Autonomics Director notification utility (IAVXNTFY) or Pre-scan utility (IAVXSCAN) interface received an error when it tried to communicate with the Autonomics Director server.

## System action

The IAVXNTFY or IAVXSCAN utility terminates with an error.

## User response

To fix this issue, complete one of the following actions:

- Verify that the Autonomics Director subsystem interface is properly installed on the system where IAVXNTFY is running.
- Verify that the master Autonomics Director server is started.
- For more information about installing and updating the Autonomics Director subsystem interface, see the *IMS Tools Base Configuration Guide*.

---

**IAV5515E**      **A NEGATIVE ACKNOWLEDGEMENT  
WAS RECEIVED FROM THE AD  
SERVER: *explanatory\_text***

## Explanation

The Autonomics Director notification utility (IAVXNTFY) or the Pre-scan utility (IAVXSCAN) received an error from the Autonomics Director master server. The *explanatory\_text* of the message describes the negative acknowledgment.

## System action

The IAVXNTFY or IAVXSCAN utility terminates with an error.

## User response

Take a corrective action based on the *explanatory\_text*.

A possible cause of this error can be:

- An unknown RECON1 data set name, database group, database, partition, or area is used.
- The job is participating in a group-managed reorganization job stream and is not known by the Autonomics Director server.
- The Autonomics Director server could not find the database in the monitor list.

---

**IAV6000E**      ***cmdverb* SERVER COMMAND  
REJECTED: *reason***

## Explanation

The Autonomics Director server operational command identified by *cmdverb* was rejected by the server for the reason identified by *reason*.

### System action

The Autonomics Director server rejects the command.

### User response

If appropriate, correct and resubmit the command.

---

**IAV6001I** *cmd-name* **SERVER COMMAND EXECUTED**

### Explanation

The Autonomics Director server **MODIFY** command *cmd-name* was successfully executed.

### System action

The Autonomics Director server has taken the command action and the operation continues in the state requested.

### User response

None. This message is informational.

---

**IAV6006E** **INVALID COMMAND** *command*  
**SERVER**

### Explanation

The Autonomics Director operational command entered is invalid.

### System action

The command is ignored.

### User response

Correct and resubmit the command.

---

**IAV7000I** **IMS AD VERSION** *vrn* **SSI INITIALIZATION COMPLETE**

### Explanation

The Autonomics Director User Interface Subsystem initialization routine completed initialization. The *vrn* within the message identifies the version and release of the initialization routine.

### System action

None.

### User response

None. This message is informational.

---

**IAV7002E** **IMS AD SSI ERROR**  
**ACTION=action, RC=rc, RSN=rsn**

### Explanation

The Autonomics Director Subsystem Interface encountered an error.

### System action

Initialization of the Autonomics Director Subsystem Interface fails.

### User response

Contact IBM Software Support.

---

**IAV7004I** **IMS AD SSI PREVIOUSLY ESTABLISHED IS DISABLED**

### Explanation

The Autonomics Director subsystem was reinitialized.

### System action

The instance of the Autonomics Director subsystem that was previously initialized is now disabled. This message is issued for informational purposes only.

### User response

None. This message is informational.

---

**IAV8000E** **INCORRECT EXEC PARAMETER IS SPECIFIED.**

### Explanation

An incorrect EXEC parameter is specified for the Autonomics Director utility interface (IAVBUTLO).

### System action

Processing ends with a return code of 8.

### User response

Correct the EXEC parameter, and rerun the job.

---

**IAV8001I** **THE** *utility\_name* **PROCESS HAS STARTED.**

### Explanation

The Autonomics Director utility named *utility\_name* has started.

## System action

Processing continues.

## User response

None. This message is informational.

---

**IAV8002I**      **THE *utility\_name* PROCESS HAS ENDED NORMALLY.**

## Explanation

The Autonomics Director utility named *utility\_name* has ended normally.

## System action

Processing continues.

## User response

None. This message is informational.

---

**IAV8003W**      **THE *utility\_name* PROCESS HAS ENDED WITH WARNING.**

## Explanation

The Autonomics Director utility named *utility\_name* has ended with warnings.

## System action

Processing ends with a return code of 4.

## User response

Check another message whose suffix is 'W'. If this is not the expected result, correct the error, and rerun the job.

---

**IAV8004E**      **THE *utility\_name* PROCESS HAS ENDED WITH ERROR.**

## Explanation

The Autonomics Director utility named *utility\_name* has ended with errors.

## System action

Processing ends with a return code of 8.

## User response

Check another message whose suffix is 'E'. Correct the error, and rerun the job.

---

**IAV8005E**      **STORAGE OBTAIN FAILED.  
RC=*return\_code*, SIZE=*size*,  
MOD=*module*, ERROR\_ID=*error\_id*.**

## Explanation

The Autonomics Director utility failed to obtain storage. *size* shows the size of the storage that could not be obtained. The hexadecimal value *return\_code* shows the return code that is returned from the STORAGE macro. *module* shows the name of the failed module, and *error\_id* shows the error ID that is associated with the module.

## System action

Processing ends with a return code of 8.

## User response

Increase the REGION size on the JOB statement in the JCL, and rerun the utility.

---

**IAV8006E**      **STORAGE RELEASE FAILED.  
RC=*return\_code*, SIZE=*size*,  
MOD=*module*, ERROR\_ID=*error\_id*.**

## Explanation

The Autonomics Director utility failed to release storage. *size* shows the size of the storage that could not be released. The hexadecimal value *return\_code* shows the return code that is returned from the STORAGE macro. *module* shows the name of the failed module, and *error\_id* shows the error ID that is associated with the module.

## System action

Processing ends with a return code of 8.

## User response

This error might be an internal system error. Contact IBM Software Support.

---

**IAV8007E**      **OPEN FAILED. DDNAME=*ddname*.  
RC=*return\_code*.**

## Explanation

The Autonomics Director utility failed to open the data set that is specified by the *ddname* DD. The hexadecimal value *return\_code* is the return code from the OPEN macro.

## System action

Processing ends with a return code of 8.

## User response

See *z/OS DFSMS Macro Instructions for Data Sets* to determine the meaning of the return code. If the problem persists, contact IBM Software Support.

---

**I**AV8009E      **DYNALLOC SERVICE FAILED FOR FUNC=[ALLOC | UNALLOC], [DDNAME=ddname | DSNAME=dsname], RC=return\_code, RSN=reason\_code.**

## Explanation

The Autonomics Director utility failed to allocate or deallocate the data set for DD name *ddname* or the data set named *dsname*. The hexadecimal value *return\_code* is the return code from SVC99. The hexadecimal value *reason\_code* is the S99ERROR and S99INFO contents.

## System action

Processing ends with a return code of 8.

## User response

Look up the dynamic allocation (SVC99) code in the *z/OS MVS Programming: Authorized Assembler Services Guide*. Correct the problem, and rerun the job.

---

**I**AV8010E      **UTILITY ENDED WITH ERROR. RC=return\_code, RSN=reason\_code.**

## Explanation

The Autonomics Director utility interface ended with an error. Hexadecimal values *return\_code* and *reason\_code* indicate the return and reason codes from the requested function, respectively.

## System action

Processing ends with a return code of 8.

## User response

Review the error messages printed in the Journal Messages report. Correct the problem, and rerun the job.

---

**I**AV8011E      **ERRORS DETECTED WHILE [ANALYZING INPUT PARAMETERS | ADDING MONITOR LIST ENTRIES].**

## Explanation

The Autonomics Director utility encountered errors during its processing.

## System action

Processing ends with a return code of 8.

## User response

Check the message whose suffix is 'E' in the Journal Messages report. Correct the error, and rerun the job.

---

**I**AV8012E      **LOAD FAILED. MODULE=modname, SC=code, RSN=reason\_code.**

## Explanation

The Autonomics Director utility failed to load the module named *modname*. The hexadecimal value *code* is the abend code, and the hexadecimal value *reason\_code* is the reason code associated with the abend.

## System action

Processing ends with a return code of 8.

## User response

Check if the correct load module library is specified in the STEPLIB DD statement.

---

**I**AV8013E      **CONNECTION TO THE ITKB SERVER FAILED. NAME=servername.**

## Explanation

The connection to the IMS Tools Knowledge Base server failed. This message might be issued for the following reasons:

- The server configuration is incomplete.
- The server is not started.
- The server XCF group name that is specified by the ITKBSRVR keyword is incorrect.
- Insufficient access authority to the repository.

## System action

Processing ends with a return code of 8.

## User response

Complete the following steps:

1. Ensure that the server XCF group name specified by the ITKBSRVR keyword is correct.
2. Ensure that the IMS Tools Knowledge Base server is configured and started without any errors. For configuration steps, see the topic "[Configuring IMS Tools Knowledge Base](#)" in the *IMS Tools Base Configuration Guide*.

If the problem persists, contact IBM Software Support.

---

**IAV8014E**      **SPECIFIED RECON ID IS NOT DEFINED IN REPOSITORY. RECON ID=*recon\_id*.**

### Explanation

The Autonomics Director utility failed to retrieve the RECON ID of *recon\_id* from the IMS Tools Knowledge Base Input repository.

### System action

Processing ends with a return code of 8.

### User response

Ensure that the RECONID keyword specifies the correct RECON ID. Also, ensure that the RECON data set name is registered with IMS Tools Knowledge Base.

---

**IAV8015E**      **UNABLE TO OBTAIN RECON ID FROM REPOSITORY. RECON ID=*recon\_id*, RC=*return\_code*, RSN=*reason\_code*.**

### Explanation

The Autonomics Director utility failed to retrieve the RECON ID of *recon\_id* from the IMS Tools Knowledge Base Input repository. Hexadecimal values *return\_code* and *reason\_code* are the return code and the reason code from the RECON ID retrieval module.

### System action

Processing ends with a return code of 8.

### User response

Ensure that the RECONID keyword specifies the correct RECON ID. Also, ensure that the RECON data set name is registered with IMS Tools Knowledge Base. If the problem persists, contact IBM Software Support.

---

**IAV8018E**      **SSI SERVICE FAILED FOR FUNC=*function*, RC=*return\_code*, RSN=*reason\_code*.**

### Explanation

The SSI request issued by the Autonomics Director utility failed. The hexadecimal value *return\_code* and *reason\_code* are the codes returned from the SSI function.

### System action

Processing ends with a return code of 8.

### User response

Correct the error, and rerun the job. If the problem persists, contact IBM Software Support.

---

**IAV8019E**      **ESTAE FAILED. RC=*return\_code*, MOD=*modname*.**

### Explanation

The ESTAE request issued by the Autonomics Director utility failed. The hexadecimal value *return\_code* is the return code of the ESTAE macro. *modname* is the module name that requested the ESTAE macro.

### System action

Processing ends with a return code of 8.

### User response

Correct the error, and rerun the job.

---

**IAV8020E**      **INTERNAL ERROR OCCURRED IN MODULE *modname*, CODE=*code*.**

### Explanation

The Autonomics Director utility encountered an internal error. *modname* is the name of the module that encountered the error. *code* is the information code associated with the error.

### System action

Processing ends with a return code of 8.

### User response

This error might be an internal system error. Contact IBM Software Support.

---

**IAV8023E**      **COMMAND RESPONSE NOT RECEIVED.**

### Explanation

The Autonomics Director utility did not receive any response from the Autonomics Director server.

## System action

Processing ends with a return code of 8.

## User response

Ensure that the Autonomics Director server is configured and started without any errors. If the problem persists, contact IBM Software Support.

---

**IAV8024E            MAXIMUM LENGTH OF RESPONSE  
DATA REACHED.**

## Explanation

The response data from the Autonomics Director server exceeded its maximum allowable length.

## System action

Processing ends with a return code of 8.

## User response

This error might be an internal system error. Contact IBM Software Support.

---

**IAV8030E            AN ERROR WAS DETECTED  
WHILE ANALYZING THE CONTROL  
STATEMENT. RC=return\_code,  
FUNC=function.  
DETAIL OF THE ERROR IS AS  
FOLLOWS:  
BPE0003E message\_text**

## Explanation

The control statement analysis process detected a syntax error in the control statement. Review message BPE0003E, which follows this message and explains the details of the error.

## System action

Processing ends with a return code of 8.

## User response

Correct the control statement, and rerun the job.

---

**IAV8031E            AD FAILED TO CONNECT  
TO THE SSI INTERFACE  
WITH SERVICE=function,  
RC=return\_code,  
RSN=reason\_code.**

## Explanation

The Autonomics Director utility received an error when it tried to connect to the Autonomics Director subsystem interface.

## System action

Processing ends with a return code of 8.

## User response

Verify that the Autonomics Director subsystem interface is properly installed on the system where the batch client is running. For information about installing and updating the Autonomics Director subsystem interface, see the topic "Installing and updating the subsystem interface" in the *IMS Tools Base Configuration Guide*. If the problem persists, contact IBM Software Support.

---

**IAV8032E            THE MASTER AD SERVER CANNOT  
BE LOCATED.**

## Explanation

The Autonomics Director utility tried to locate the Autonomics Director master server but it is not available.

## System action

Processing ends with a return code of 8.

## User response

Complete one of the following actions:

- If an alternate server is available, resubmit the job.
- If an alternate server is not available, start the Autonomics Director master server and then resubmit the job.

---

**IAV8033E            INCOMPATIBLE RELEASE LEVELS  
FOR THE AD SERVER AND BATCH  
CLIENT.**

## Explanation

The Autonomics Director utility and Autonomics Director master server are not at the same release level.

## System action

Processing ends with a return code of 8.

## User response

Ensure that both the Autonomics Director utility and Autonomics Director master server are at the same release level.

---

**IAV8034E AN INVALID RESPONSE WAS RECEIVED FROM THE AD SERVER.**

## Explanation

The Autonomics Director utility received an invalid response from the Autonomics Director server.

## System action

Processing terminates abnormally.

## User response

Save the output from the utility job and review the Autonomics Director configuration. For more information about the Autonomics Director server environment, see the topic "Configuring the server environment" in the *IMS Tools Base Configuration Guide*. If the problem persists, contact IBM Software Support.

---

**IAV8036E UNSUPPORTED RESPONSE TYPE RECEIVED.**

## Explanation

The Autonomics Director utility received an unsupported response from the Autonomics Director server.

## System action

Processing ends with a return code of 8.

## User response

This error might be an internal system error. Contact IBM Software Support.

---

**IAV8037W AN INVALID AWE WAS FOUND.**

## Explanation

The Autonomics Director utility received an invalid XCF notification about a member of the batch client XCF group.

## System action

Processing continues.

## User response

If the problem persists, contact IBM Software Support.

---

**IAV8038E THE MASTER AD SERVER HAS TERMINATED.**

## Explanation

The Autonomics Director utility lost connection to the Autonomics Director master server when it tried to obtain information from the server.

## System action

Processing ends with a return code of 8.

## User response

Complete one of the following actions:

- If an alternate server is available, resubmit the job.
- If an alternate server is not available, start the Autonomics Director master server and then resubmit the job.

---

**IAV8039I CONNECTED TO THE AD SERVER. NAME=*servername*.**

## Explanation

The Autonomics Director utility successfully connected to the Autonomics Director master server named *servername*.

## System action

Processing continues.

## User response

None. This message is informational.

---

**IAV8040I DBD *dbd\_name* HAS BEEN ADDED TO THE MONITOR LIST.**

## Explanation

The Autonomics Director utility added an entry for DBD *dbd\_name* to the monitor list.

## System action

Processing continues.

## User response

None. This message is informational.



---

**IAV8041W**      **DBD *dbd\_name* HAS BEEN  
UPDATED IN THE MONITOR LIST.**

### Explanation

The Autonomics Director utility updated the entry for DBD *dbd\_name* in the monitor list.

### System action

Processing continues, setting an intermediate return code of 4.

### User response

None. This message is informational.

---

**IAV8042W**      **[AREA *area\_name* | PARTITION  
*partition\_name*] OF *dbd\_name*,  
WHICH EXISTS IN THE MONITOR  
LIST, IS NOT FOUND IN THE DBD.**

### Explanation

The indicated partition or DEDB area exists in the monitor list but it is not found in the DBD.

### System action

Processing continues, setting an intermediate return code of 4.

### User response

Ensure that the DBD (*dbd\_name*) contains the indicated partition or DEDB area. If you have removed the partition or DEDB area from the DBD, delete the entry from the monitor list by using the Autonomics Director client dialog. For more information, see [“Deleting monitor list entries”](#) on page 58.

---

**IAV8043E**      **DBD *dbd\_name* DOES NOT EXIST.**

### Explanation

The Autonomics Director utility could not find the indicated DBD member.

### System action

Skips processing for the indicated DBD, sets a return code of 8, and continues processing.

### User response

Ensure that the correct DBD name is specified on the DATABASE statement.

---

**IAV8044E**      **DATABASE ORGANIZATION TYPE  
*dborg* IS NOT SUPPORTED. DBD  
*dbd\_name*.**

### Explanation

The Autonomics Director utility does not support the following types of databases:

- HSAM
- SHSAM
- LOGICAL
- GSAM
- MSDB

### System action

Skips processing for the indicated DBD, sets a return code of 8, and continues processing.

### User response

Remove the DATABASE statement that contains the indicated DBD.

---

**IAV8045E**      **GROUPTYPE OF DBD  
*dbd\_name* IS NOT SUPPORTED.  
GROUPTYPE=*group\_type*,  
GROUPNAME=*group\_name*.**

### Explanation

The entry for the indicated DBD already exists in the monitor list with the indicated group type (*group\_type*). Monitor list entries with group type other than DATABASE cannot be updated with the Monitor List Registration utility.

### System action

Skips processing for the indicated DBD, sets a return code of 8, and continues processing.

### User response

To update database entries that have group type other than DATABASE, use the Autonomics Director client dialog. For more information, see [“Adding or updating monitor list entries”](#) on page 57.

---

**IAV8046E**      **INVALID VALUE SPECIFIED FOR  
*statement*. [DBTYPE=*dbtype*] [,  
POLICYBY=*policyby*].**

### Explanation

The parameter value specified for the indicated statement is not correct.

### System action

Processing ends with a return code of 8.

### User response

Correct the control statement, and rerun the job.

---

**IAV8048E      INVALID PARAMETER FORMAT  
USED FOR [EVALINT |  
SENSOR\_AGE].**

### Explanation

The parameter value specified by the indicated keyword is not in a correct format. The parameter value must be in *ddd:hhh:mm* format.

### System action

Processing ends with a return code of 8.

### User response

See “Control statements for the Monitor List Registration utility” on page 125 and correct the control statement. Then rerun the job.

---

**IAV8049E      SENSOR JCL DATA SET DOES NOT  
EXIST. SENSOR\_JCLDSN=*dsname*.**

### Explanation

The data set that is specified by the SENSOR\_JCLDSN keyword does not exist.

### System action

Processing ends with a return code of 8.

### User response

Ensure that the sensor JCL data set exists and that the correct data set name is specified for the SENSOR\_JCLSDN keyword. Then rerun the job.

---

**IAV8050E      SENSOR JCL MEMBER  
*member\_name* DOES NOT EXIST  
IN THE SENSOR JCL DATA SET.  
SENSOR\_JCLDSN=*dsname*.**

### Explanation

The sensor JCL member (*member\_name*) that is specified by the SENSORID\_FFDB, SENSORID\_HALDB, or SENSORID\_DEDB keyword does not exist in the sensor JCL data set (*dsname*).

### System action

Processing ends with a return code of 8.

### User response

Ensure that the sensor JCL member exists in the sensor JCL data set, and rerun the job.

---

**IAV8051E      SENSOR JCL MEMBER NAME  
MUST BE SUPPLIED WITH THE  
SENSORID\_XXXXX KEYWORD.**

### Explanation

The name of the sensor JCL member that corresponds to the database type must be supplied with the following SENSORID\_XXXXX keywords.

- When adding or updating entries for full-function databases, use the SENSORID\_FFDB keyword
- When adding or updating entries for HALDB partitions, use the SENSORID\_HALDB keyword
- When adding or updating entries for DEDB areas, use the SENSORID\_DEDB keyword

### System action

Processing ends with a return code of 8.

### User response

Supply the name of the sensor JCL member with SENSORID\_XXXXX keywords, and rerun the job.

---

**IAV8052E      THE NUMBER OF [REORG\_POLICY  
| RECOVERY\_POLICY]  
STATEMENTS EXCEEDED THE  
LIMIT. MAX IS 3.**

### Explanation

The number of xxxxxx\_POLICY statements exceeds the maximum limit. The maximum limit for the indicated xxxxxx\_POLICY statement is three.

### System action

Processing ends with a return code of 8.

### User response

Remove unnecessary xxxxxx\_POLICY statements and rerun the job.

---

**IAV8053E      TWO OR MORE STATEMENTS  
CONTAIN THE SAME VALUE FOR  
THE DBTYPE KEYWORD.**

**STATEMENT= [REORG\_POLICY  
| RECOVERY\_POLICY],  
DBTYPE=[ALL | FFDB | HALDB |  
DEDB].**

## Explanation

More than one REORG\_POLICY statement or RECOVERY\_POLICY statement contains the same DBTYPE value.

The same DBTYPE value can be used in different policy statements, for example:

```
REORG_POLICY(DBTYPE(FFDB) POLICYBY(...))  
RECOVERY_POLICY(DBTYPE(FFDB) POLICYBY(...))
```

However, the same DBTYPE value must not be used in multiple REORG\_POLICY statements or in multiple RECOVERY\_POLICY statements:

```
REORG_POLICY(DBTYPE(FFDB) POLICYBY(...))  
REORG_POLICY(DBTYPE(FFDB) POLICYBY(...))
```

## System action

Processing ends with a return code of 8.

## User response

Review the REORG\_POLICY statements or the RECOVERY\_POLICY statements and remove the statements that contain the same DBTYPE value. For more information about the DBTYPE keyword, see [“Control statements for the Monitor List Registration utility” on page 125.](#)

---

**IAV8054E**      **POLICYNAME KEYWORD  
NOT ALLOWED WHEN  
POLICYBY(NAME) IS NOT  
SPECIFIED.  
STATEMENT=[REORG\_POLICY  
| RECOVERY\_POLICY],  
DBTYPE=[ALL | FFDB | HALDB |  
DEDB].**

## Explanation

The POLICYNAME keyword is specified without the POLICYBY(NAME) keyword. The POLICYNAME keyword must be specified together with the POLICYBY(NAME) keyword.

## System action

Processing ends with a return code of 8.

## User response

Remove the POLICYNAME keyword or correct the control statement to include the POLICYBY(NAME) keyword, and rerun the job.

---

**IAV8055E**      **POLICYNAME KEYWORD  
IS REQUIRED WHEN  
POLICYBY(NAME) IS SPECIFIED.  
STATEMENT=[REORG\_POLICY  
| RECOVERY\_POLICY],  
DBTYPE=[ALL | FFDB | HALDB |  
DEDB].**

## Explanation

The POLICYBY(NAME) keyword is specified without the POLICYNAME keyword. The POLICYBY(NAME) keyword must be specified together with the POLICYNAME keyword.

## System action

Processing ends with a return code of 8.

## User response

Correct the control statement to include the POLICYNAME keyword, and rerun the job.

---

**IAV8056E**      **POLICY *policy\_name* IS NOT  
FOUND IN THE INPUT  
REPOSITORY.  
STATEMENT=[REORG\_POLICY  
| RECOVERY\_POLICY],  
DBTYPE=[ALL | FFDB | HALDB |  
DEDB].**

## Explanation

The indicated policy, specified by a REORG\_POLICY statement or RECOVERY\_POLICY statement, is not found in any of the locales of the IMS Tools Knowledge Base Input repository.

## System action

Processing ends with a return code of 8.

## User response

Ensure that the correct policy name is specified on the xxxxx\_POLICY statement. Also, ensure that the specified policy has been imported to the IMS Tools Knowledge Base Input repository. Then rerun the job.

---

**IAV8057E**      **ONLY ONE [REORG\_POLICY |  
RECOVERY\_POLICY] STATEMENT  
IS ALLOWED WHEN DBTYPE=ALL.**

## Explanation

When DBTYPE=ALL is specified, there should be no other policy statements of the same type. DBTYPE=ALL means the policy identified from that POLICY statement is applied to all the databases regardless of their type.

## System action

Processing ends with a return code of 8.

## User response

Either remove the `xxxxx_POLICY` statement with DBTYPE=ALL or remove other `xxxxx_POLICY` statements. For more information about the DBTYPE keyword and policy statements, see “Control statements for the Monitor List Registration utility” on page 125.

---

<b>IAV8058E</b>	<b>THE NUMBER OF DATABASES EXCEEDED THE LIMIT. MAX IS 9999.</b>
-----------------	---

## Explanation

More than 9,999 DATABASE statements are specified.

## System action

Processing ends with a return code of 8.

## User response

Reduce the number of DATABASE statements and rerun the job.

---

<b>IAV8059E</b>	<b>INVALID WILDCARD FORMAT USED FOR DATABASE(DBD(<i>database_name</i>))</b>
-----------------	---

## Explanation

The wildcard value specified for the DATABASE command is not in a correct format.

## System action

Processing ends with a return code of 8.

## User response

See “DATABASE command” on page 132 and correct the control statement; then rerun the job.

---

<b>IAV8060W</b>	<b>DBD <i>dbd_name</i> IS SPECIFIED MULTIPLE TIMES.</b>
-----------------	---

## Explanation

The indicated DBD (*dbd\_name*) is specified on more than one DATABASE statement.

## System action

Processing continues, setting an intermediate return code of 4.

## User response

None. This message is informational.

---

<b>IAV8061E</b>	<b>MONITOR LIST REGISTRATION FAILED. DBD=<i>dbd_name</i> [, AREA=<i>area_name</i>   , PART=<i>partition_name</i>]. RC=<i>return_code</i>.</b>
-----------------	---

## Explanation

The utility failed to add the indicated resource to the monitor list.

## System action

Processing ends with a return code of 8.

## User response

This error might be an internal system error. Contact IBM Software Support.

---

<b>IAV8062E</b>	<b>INTERNAL SORT API ENDED WITH ERROR. RC=<i>return_code</i>, RSN=<i>reason_code</i>.</b>
-----------------	---

## Explanation

The Autonomics Director utility failed to sort internal data. Hexadecimal values *return\_code* and *reason\_code* are the return code and the reason code from the internal sort API.

## System action

Processing ends with a return code of 8.

## User response

This error might be an internal system error. Contact IBM Software Support.

---

<b>IAV8063I</b>	<b>IAVSYSIN CONTROL CARDS FOLLOW:</b>
-----------------	---------------------------------------

## Explanation

This message is followed by one or more lines of text, each line showing individual processing options of the Monitor List Registration utility. This message is for informational purposes only.

## System action

Processing continues.

## User response

None. This message is informational.

---

<b>IAV8064W</b>	<b>DATABASE ORGANIZATION TYPE</b> <i>dborg</i> <b>IS NOT SUPPORTED. DBD</b> <i>dbd_name</i> .
-----------------	---

## Explanation

The Autonomics Director utility does not support the following types of databases:

- HSAM
- SHSAM
- LOGICAL
- GSAM
- MSDB

## System action

Skips processing for the indicated DBD, sets a return code of 4, and continues processing.

## User response

None. This message is informational.

---

<b>IAV8065I</b>	<b>DATABASE ORGANIZATION TYPE</b> <i>dborg</i> <b>IS NOT SUPPORTED. DBD</b> <i>dbd_name</i> .
-----------------	---

## Explanation

The Autonomics Director utility does not support the following types of databases:

- HSAM
- SHSAM

- LOGICAL
- GSAM
- MSDB

## System action

Skips processing for the indicated DBD, sets a return code of 0, and continues processing.

## User response

None. This message is informational.

---

<b>IAV8066E</b>	<b>NO PROCESSED DB IS FOUND</b>
-----------------	---------------------------------

## Explanation

No databases have been added to or updated in the monitor list.

## System action

Processing ends with a return code of 8.

## User response

Ensure that the correct DBD name is specified on the DATABASE statement, and then rerun the job.

---

<b>IAV8067E</b>	<b>MONITOR LIST IS NOT</b> <b>UPDATED WHEN REORG=DISABLE</b> <b>AND RECOVERY=DISABLE ARE</b> <b>SPECIFIED FOR THE AD SERVER.</b>
-----------------	---

## Explanation

The Autonomics Director utility did not update the monitor list because REORG=DISABLE and RECOVERY=DISABLE were specified for the Autonomics Director server parameters.

## System action

Processing ends with a return code of 8.

## User response

Verify REORG and RECOVERY parameters for the Autonomics Director server.

## Database evaluation error messages

---

Use the information in these messages to help you diagnose and solve Autonomics Director database evaluation problems.

### Message format

Each message includes the following information:

#### Explanation

The Explanation section explains what the message text means, why it occurred, and what its variables represent.

#### System action

The System action section explains what the system does in response to the event that triggered this message.

#### User response

The User response section describes whether a response is necessary, the appropriate response, and how the response affects the system or program.

---

**<no msg ID> POLICY Get FAILED in ASLK**

---

### Explanation

An error occurred while retrieving the policy for the evaluation. ASLK indicates the Policy Services API function call.

### System action

The database evaluation fails.

### User response

For the cause of the failure, look up the return code and reason code combination in the *IMS Tools Base Policy Services User's Guide and Reference*.

### Explanation

An error occurred while attempting to initialize Policy Services Action Manager. AMIT indicates the Policy Services API function call.

### System action

The database evaluation fails.

### User response

For the cause of the failure, look up the return code and reason code combination in the *IMS Tools Base Policy Services User's Guide and Reference*.

---

**<no msg ID> EVALUATION FAILED in PAEV**

---

### Explanation

An error occurred while attempting to evaluate the database with the given policy. PAEV indicates the Policy Services API function call.

### System action

The database evaluation fails.

### User response

For the cause of the failure, look up the return code and reason code combination in the *IMS Tools Base Policy Services User's Guide and Reference*.

### Explanation

An error occurred while retrieving the Action Descriptors or Exceptions for the database. AMGA indicates the Policy Services API function call.

### System action

The database evaluation fails.

### User response

For the cause of the failure, look up the return code and reason code combination in the *IMS Tools Base Policy Services User's Guide and Reference*.

---

**<no msg ID> Action Mangr Init.Fail-AMIT**

---

---

**<no msg ID> Get ACTION STATUS Fail-AMUS**

---

## Explanation

An error occurred while retrieving Policy Services status information. AMUS indicates the Policy Services API function call.

## System action

The database evaluation fails.

## User response

For the cause of the failure, look up the return code and reason code combination in the *IMS Tools Base Policy Services User's Guide and Reference*.

---

<no msg ID>      **Get SUMMARY DESC. Fail-AMTM**

## Explanation

An error occurred while retrieving the summary message for the database evaluation. AMTM indicates the Policy Services API function call.

## System action

The database evaluation fails.

## Abend codes

---

This reference section provides detailed information about Autonomics Director abend codes.

For each abend code, the following information is provided where applicable:

### Explanation

The Explanation section explains what the abend code means, why it occurred, and what its variable entry fields are (if any).

### System action

The System action section explains what the system will do next.

### User response

The User response section describes whether a response is necessary, what the appropriate response, and how the response will affect the system or program.

---

## 020

### Explanation

An error occurred in the use of a BPE service. The abend subcode details the nature of the error:

- X'01' - AWE get failed
- X'05' - AWE enqueue failed
- X'0A' - BPETIMER initialization failed
- X'0F' - BPETIMER cancel failed
- X'14' - BPEATTCH failed
- X'19' - BPELTCB failed
- X'1E' - BPELOADC failed
- X'23' - BPEPOST failed

## User response

For the cause of the failure, look up the return code and reason code combination in the *IMS Tools Base Policy Services User's Guide and Reference*.

---

<no msg ID>      **READ OF REORG SENSOR FAILED**

## Explanation

An error occurred while attempting to read the sensor data record for the database.

## System action

The database evaluation fails.

## User response

For the cause of the failure, look up the return code and reason code combination in “Sensor data extractor API return and reason codes” on page 105.

- 
- X'64' - BPETERM failed

- X'69' - BPELAGET failed

- X'6E' - BPELAREL failed

- X'73' - BPESPRNT failed

## System action

The Autonomics Director server address space is abnormally terminated.

## User response

Retain diagnostic information and contact IBM Software Support.

---

## 040

## Explanation

An error occurred while trying to obtain virtual storage. The abend subcode details the nature of the error:

- X'05' - SSBL storage unavailable
- X'0A' - XCF JOIN answer area storage unavailable
- X'0F' - XCF QUERY buffer storage unavailable
- X'14' - XCF QUERY response buffer storage unavailable
- X'19' - XCF group exit work area storage unavailable
- X'1E' - XCF message exit work area storage unavailable
- X'23' - XCF send parameter list buffer unavailable

## System action

The Autonomics Director address space in which the abend occurred is abnormally terminated.

## User response

Retain diagnostic information and contact IBM Software Support.

---

### 050

## Explanation

An error occurred in the use of an MVS service. The abend subcode details the nature of the error:

- X'01' - STOKEN extract failed
- X'0A' - Non Key 7 execution
- X'0F' - RESMGR ADD failed
- X'1E' - Invalid TYPE= subparameter on execute statement

## System action

The Autonomics Director address space in which the abend occurred is abnormally terminated.

## User response

For all other subcodes, retain diagnostic information and contact IBM Software Support.

---

### 070

## Explanation

An error occurred in an internal Autonomics Director service. The abend subcode further determines the nature of the error:

- X'00A' - XCF QUERY for servers failed

- X'00F' - XCF QUERY failed
- X'014' - XCF JOIN failed
- X'019' - XCF UPDATE failed
- X'01E' - XCF LEAVE failed
- X'028' - PROCLIB processing failed
- X'032' - Cell Pool services get failed
- X'03C' - AWE server initialization failed
- X'046' - AWE server termination failed
- X'050' - BPE Get Latch failed in SPOL
- X'051' - BPE Release Latch failed in SPOL
- X'054' - Policy Services FUNC=TERM failed in SPOL
- X'055' - Sensor Data FUNC=TERM failed in SPOL
- X'05A' - Common Services join failed
- X'065' - Internal logic error detected
- X'066' - DSECT validation error in SPOL
- X'06E' - Different PROCLIB member
- X'070' - Server table overflow
- X'071' - Repository version is incompatible
- X'072' - Insufficient authority to access the Autonomics Director repository
- X'080' - Exception definition table initialization failed
- X'081' - Exception definition table error was detected
- X'2C1' - Policy Services initialization failed

## System action

The address space is abnormally terminated.

## User response

- X'00A', X'00F', X'014', and X'01E' - System message IAV0430E will also be issued. Refer to message IAV0430E for further information.
- X'028' - A system message will also be issued indicating the nature of the error.
- X'065' - System message IAV0991E or IAV0992I will also be issued, indicating the nature of the error. Retain diagnostic information and contact IBM Software Support.
- X'06E' - An inconsistent global PROCLIB member is being used across Autonomics Director servers. Correct the inconsistency and restart the server.
- X'071' - Check if the connected IMS Tools Knowledge Base server and repositories are correct. If they are correct, make sure that the repository conversion process has been properly completed. If not, migrate the repositories from IMS Tools Base 1.6 to 1.7 again.



- X'072' - Ensure that the access rights to the Autonomics Director repository are correct.
- X'080' : System message IAV0035E will also be issued. Refer to message IAV0035E for further information.
- X'081' : System message IAV0036E will also be issued. Refer to message IAV0036E for further information.
- X'2C1' - System message IAV0705W will also be issued. Refer to message IAV0705W for further information.

For all other subcodes, retain diagnostic information and contact IBM Software Support.

---

## 080

### Explanation

An error occurred in an SRB service routine. The abend subcode details the nature of the error:

- X'01' - SRB service initialization failure
- X'1E' - SRB service Cell Pool get failure
- X'23' - SRB service BPEAWSRV enqueue failed
- X'28' - XCF message length exceeded maximum support length
- X'2D' - XCF build of GEPL block failed
- X'32' - XCF SRB service BPEAWSRV enqueue failed
- X'37' - XCF build of MEPL block failed

### System action

For subcodes X'01', X'1E', and X'23', the Autonomics Director server address space is abnormally terminated.

For subcode X'28', X'2D', X'32', and X'37', only the XCF message exit fails and an SVC dump for the address space accompanies the abend.

### User response

Retain diagnostic information and contact IBM Software Support.

---

## 100

### Explanation

An error occurred in the Autonomics Director server address space. The abend subcode further determines the nature of the error:

- X'13' - FIND TYPE=RB failed

### System action

The Autonomics Director server address space is abnormally terminated.

### User response

Retain diagnostic information and contact IBM Software Support.

---

## 110

### Explanation

An error occurred in an internal Autonomics Director service. The abend subcode further determines the nature of the error:

- X'14' - XCF JOIN failed
- X'1E' - XCF LEAVE failed
- X'32' - Cell Pool services get failed
- X'41' - XCF send services failed
- X'46' - Internal logic error

### System action

The Autonomics Director address space is terminated.

### User response

Retain diagnostic information and contact IBM Software Support.

## Sensor data extractor API return and reason codes

This topic provides detailed information about the sensor data extractor API return and reason codes.

*Table 4. Sensor data extractor API return and reason codes*

Return code	Reason code	Message text
0	-	SUCCESSFULLY PROCESSED

Table 4. Sensor data extractor API return and reason codes (continued)

Return code	Reason code	Message text
4	8	MEMBER NOT FOUND
8	3	ATTEMPTING TO INITIALIZE AN ALREADY INITIALIZED ENVIRONMENT
12	1	API LEVEL IS INVALID
	2	INVALID FUNCTION
	4	SERVER NAME MISSING
	5	CANNOT CONNECT TO SERVER
	6	MISSING REQUIRED PARAMETER
	7	SERVER ERROR ON BROWSE
	8	STORAGE LENGTH INVALID
	12	CORRUPT ENVIRONMENT
	13	INVALID LIST TYPE
16	10	BAD MEMBER READ
	11	BAD TAG IN RECORD

## Frequently asked questions

This topic answers common Autonomics Director usage questions.

The following frequently asked questions are answered:

- [“After a reconfiguration of the RECON data sets by DBRC, I receive message DSP0388I. What do I do?” on page 106](#)
- [“If the REORG needed indicator is set to "Y", how can the indicator be reset to "N"?” on page 106](#)
- [“How is the evaluation interval used?” on page 107](#)

### **After a reconfiguration of the RECON data sets by DBRC, I receive message DSP0388I. What do I do?**

During RECON reconfiguration (also known as a RECON switch), you may receive IMS message DSP0388I. This message identifies which subsystems have access to the RECON data sets. If Autonomics Director is identified as a subsystem in message DSP0388I, you must perform the Autonomics Director REFRESH RECON process to deallocate the RECON data sets so that the RECON in error can be removed and reallocated.

When a RECON ID is added or changed in the IMS Tools Knowledge Base repository, the Autonomics Director environment is not automatically updated. For information on how to update your Autonomics Director server RECON environment, see [“Refreshing the Autonomics Director server resources” on page 39](#).

### **If the REORG needed indicator is set to "Y", how can the indicator be reset to "N"?**

Each time a policy evaluation is run, the REORG needed indicator is set or reset. Typically, after a reorganization, an image copy or pointer checker, or both, are performed. The integrated sensors in an image copy or pointer checker automatically drive the policy evaluation if you set AUTOEVAL=Y for the Autonomics Director monitored database, partition, or area. You can also use the standalone database sensor to run policy evaluations.

## How is the evaluation interval used?

The evaluation interval (EVALINT) controls the currency of the database reorganization status. It is the time interval requested between database evaluations. The shorter the EVALINT, the more timely your database REORG status is.

You can set the EVALINT for a whole database group or for each monitored database. Some databases may require no automatic evaluation at all and you can set EVALINT=0 for these. No automatic evaluation is scheduled for databases with EVALINT=0. However, it still might be useful to have these databases on the monitor list because they can be used during on-demand database evaluations. Also, evaluation history is kept and can be accessed from the Autonomics Director client for these databases.

## Gathering diagnostic information

---

Before you report a problem with Autonomics Director to IBM Software Support, you need to gather the appropriate diagnostic information.

### Procedure

Provide the following information for all Autonomics Director problems:

- A clear description of the problem and the steps that are required to recreate the problem
- All messages that were issued as a result of the problem
- Product release number and the number of the last program temporary fix (PTF) that was installed
- The version of IMS that you are using and the type and version of the operating system that you are using
- A Load Module APAR Status report. Use the Tools Base Diagnostics Aid (HKTUDIAG) to generate a Load Module APAR Status report. For details, see the *IMS Tools Base IMS Tools Common Services User's Guide and Reference*.

Provide additional information based on the type of problem that you experienced:

#### For online abends, provide the following information

- A screen capture of the panel that you were using when the abend occurred
- The job log from the TSO session that encountered the abend
- The job log from the server
- A description of the task that you were doing before the abend occurred

#### For errors in submitted batch processing, provide the following information

- The complete job log
- SYSPRINT output
- Contents of any data sets that were used during the processing



---

# Chapter 11. Reference: Business and usage scenarios

Use Autonomics Director to address many of your day-to-day business problems.

These scenarios illustrate how you can use Autonomics Director to address typical business problems.

## Topics:

- [“Scenario: Creating a scheduling calendar that includes exceptions for the major US holidays” on page 109](#)
- [“Scenario: Creating and activating a monitoring list” on page 110](#)
- [“Scenario: Viewing exceptions by using IMS Administration Foundation” on page 111](#)
- [“Scenario: Change accumulation passive autonomics using CAGRPs” on page 112](#)

---

## Scenario: Creating a scheduling calendar that includes exceptions for the major US holidays

---

In this scenario, a DBA at an automobile manufacturing plant creates a scheduling calendar that includes exceptions for major US holidays.

### About this task

The heaviest workload on the automobile manufacturing computer systems occurs daily between 8:00 AM and 9:00 PM.

To accommodate this workload, the DBA defined the Autonomics Director base period as Monday - Friday, 8:00 AM - 9:00 PM, which means that Autonomics Director does not run sensor and evaluation jobs during this time.

The automobile manufacturing plant is closed on all major US holidays. Because the plant is closed, the DBA wants Autonomics Director to run all day when necessary during these holidays. To have Autonomics Director run jobs during these times, the DBA must create overrides to the Autonomics Director base period for the selected dates.

The automobile manufacturing plant is closed on the following holidays:

Date	Description
Friday, January 1	New Year's Day
Monday, January 18	Martin Luther King, Jr. Day
Monday, February 15	President's Day
Monday, May 31	Memorial Day
Sunday, July 4	Independence Day
Monday, September 6	Labor Day
Monday, October 11	Columbus Day
Thursday, November 11	Veterans Day
Thursday, November 25	Thanksgiving Day
Saturday, December 25	Christmas Day

### Procedure

To create a scheduling calendar:

1. From the Autonomics Director Primary Options Menu panel (**IAVPRIM**), select option **1 System administration** and press Enter.

The Autonomics Director System Administration Options Menu panel (**IAVPSAM**) is displayed.

2. Select option **1 Manage scheduling calendar**, and press Enter.

The Autonomics Director Scheduler: Period Management panel (**IAVPCLN**) is displayed.

3. Select option **2 Edit schedules** and press Enter.

The Edit Periods Filter panel (**IAVPEOP**) is displayed.

4. Apply a filter to narrow your search of period names or press Enter to indicate no filtering.

The Autonomics Director Maintenance Period Name List panel (**IAVPEPD**) is displayed.

5. Type A in the **Act** column of a period name to define base periods and new overrides for that period and press Enter.

The Autonomics Director Scheduler: Define Periods panel (**IAVPCOM**) is displayed.

6. Select option **4 Specify base period overrides by using specific dates** and press Enter.

The Base Period Overrides for Specific Dates In Month panel (**IAVPBDT**) is displayed. The overrides that you define are used for the selected dates instead of the base period.

- a. Specify 01 for the month and 24 for the year and press Enter.
  - b. Enter a forward slash (/) for 1 and 18, and press Enter.
  - c. Leave the start time and end time blank and press Enter.
  - d. Repeat steps a - c for each US holiday in the year.
  - e. Type SAVE and press Enter.
7. Verify that you entered the correct overrides.
    - a. From the Autonomics Director System Administration Options Menu panel (**IAVPSAM**), select option **1 System administration** and press Enter.
    - b. Select option **1 Manage scheduling calendar** and press Enter.
    - c. Select option **3 View scheduling calendar** and press Enter.
    - d. Apply a filter to narrow your search of period names, or press Enter to indicate no filtering.
    - e. Type S in the **Act** column of a period name to select for viewing and press Enter.
    - f. Enter 01 for the month, 01 for the day, 24 for the year, and press Enter.

The base period for that day is shown in the View Scheduling Calendar by Day (**IAVPVBD**) panel.
    - g. Repeat step 7.f for each override that you defined.

## Scenario: Creating and activating a monitoring list

---

In this scenario, a customer automates their daily monitoring and maintenance tasks for their mission-critical high-volume IMS HDAM database.

### About this task

The customer currently monitors their IMS HDAM database daily by using IMS HP Pointer Checker.

Additionally, once a day the DBA submits an IMS HP Pointer Checker job stream and manually reviews the space management reports to determine if a database reorganization is required.

The following scenario shows how the customer can automate all of these tasks by using Autonomics Director.

### Procedure

To create and activate a monitoring list:

1. From the Autonomics Director Primary Options Menu panel (**IAVPRIM**), select option **1 System administration** and press Enter.

The Autonomics Director System Administration Options Menu panel (**IAVPSAM**) is displayed.

2. Select option **2 Manage monitor list**, and press Enter.

The Autonomics Director Resource Filter panel (**IAVPRSC**) is displayed.

3. Select resource group type **1 DATABASE** and press Enter.

The Autonomics Director Resource List panel (**IAVPXIR**) is displayed.

4. From the list of available databases, select database APS003ZD by typing an A in the **Action** column and press Enter.

The Add or Update the Group and Database Attributes panel (**IAVPATT**) is displayed.

5. Specify the following monitoring options and press Enter:

- Indicate that you want to accept the attributes and add the remaining members to this group.
- Policy evaluations are run once every 24 hours.
- Maximum age of sensor data is 24 hours.
- Policy Services determines the name of the policy when the database, partition, or area is evaluated by using the database organization form.
- Priority of database evaluation is 2.
- The sensor JCL member name is VN09.

The Add or Update the Group and Database Attributes panel (**IAVPATT**) is displayed.

## Results

The Add successful message is displayed on the Resource List panel (**IAVPXIR**).

## What to do next

- Activate Sensor Data collection in the IMS HP Pointer Checker job stream.
- Set up Policy Services to receive automatic recommendations and (optional) text messages when a reorganization is required.

## Scenario: Viewing exceptions by using IMS Administration Foundation

---

If you have installed IBM Unified Management Server for z/OS, you can configure and activate IMS Administration Foundation features.

### About this task

The exception viewing feature of IMS Administration Foundation is activated by IMS Tools Base and one or more of the following products:

- IMS Database Solution Pack
- IMS Database Utility Solution
- IMS Fast Path Solution Pack
- IMS Recovery Solution Pack

The graphical user interface is provided by IBM Unified Experience for z/OS, which runs as an application for Zowe virtual desktop.

The IBM Unified Management Server for z/OS provides a web service infrastructure and a unified user interface that consolidate information from IMS subsystems and Db2® subsystems on a sysplex.

At least one Unified Management Server server instance must be set up on each sysplex and on top of a Zowe infrastructure running on the sysplex.

## Procedure

1. For instructions on activating and configuring IMS Administration Foundation features of IBM Unified Management Server for z/OS, see the topic "Installing IMS Administration Foundation" in the *Unified Management Server User Guide*.
2. To view exceptions by using IMS Administration Foundation features on the graphical user interface provided by IBM Unified Experience for z/OS, see the topic "Using IMS Administration Foundation" in the *Unified Management Server User Guide*.

## Scenario: Change accumulation passive autonomies using CAGRPs

The following process flow provides a general example of how RECOVERY domain change accumulation passive autonomies operates.

### Scenario premise

Database management typically includes a requirement to run the change accumulation process at specific time intervals (for example every 12 hours) to support optimal recovery preparation.

The ultimate goal of periodic change accumulation is to maintain up-to-date database change information that can serve to help minimize recovery processing time, should an actual recovery ever be required.

RECOVERY domain autonomies manages the change accumulation process through the use of change accumulation groups (CAGRP) and CAGRP collections.

Background information on CAGRPs and CAGRP collections can be found in [“Group-managed change accumulation”](#) on page 21.

### Process flow example

1. Configure the Autonomics Director Monitor List and Scheduler appropriately for the CAGRP resources requiring autonomic monitoring.
2. A scheduled (or manually initiated) Recovery Sensor job obtains the last change accumulation run times for all members of a CAGRP collection.

The stand-alone Recovery Sensor program (IROSENSOR) collects statistics on image copies, change accumulations, and recoverability of the databases from the content of DBRC RECON data sets.

- Manual sensor collection and policy evaluation operations can be performed at either the collection and the individual CAGRP member level.
- Automated sensor collection and policy evaluation operations can only be performed at the CAGRP collection level (includes all CAGRP members in the collection).

The sensor data collected belongs to the CAGRP attributes and does not reflect individual database members contained in the group.

For further information on IMS Tools data sensors, refer to the *IMS Solution Packs Data Sensor User's Guide*.

3. Recovery sensor data is stored in the IMS Tools Knowledge Base repository.  
Autonomics Director is alerted that the data has been collected and stored.
4. Autonomics Director initiates an evaluation of the data using Policy Services.

RECOVERY domain autonomies uses policy `IBM.CAGRP._DEFAULT`, which contains the rule `IBM.HRS_SINCE_LASTCA`.

The user-configured `IBM.HRS_SINCE_LASTCA` is a simple rule for evaluating the elapsed hours since the last change accumulation was performed for a RECON change accumulation group.



5. The IBM.HRS\_SINCE\_LASTCA rule triggers an exception if the time threshold established by the rule is exceeded by any member of the CAGRP.

The exception indicates that a change accumulation action is needed. A severity level is associated with the exception. For example:

#### Exceptions

```
-----  
The number of hours since the last CA has reached or exceeded a threshold for  
the change accumulation group CAH103PG.  
Class..... CHANGE_ACCUM_NEEDS_TO_BE_DONE  
Rule..... G:IBM.HRS_SINCE_LASTCA  
Threshold... HIGH  
Level..... CRITICAL  
Action..... CHANGEACCUM
```

6. With an exception detected, a notification is issued to the specific system administrators previously configured when setting up the autonomies process.

In passive autonomies, the action taken for an exception is some form of notification (for example, email, TSO message) to the system administrator.

7. Administrators can also obtain this information by viewing the Autonomics Director ISPF exception panels.

The global exceptions panel shows all REORG DB, RECOVERY DB, RECOVERY CAGRP exceptions for all RECON data sets.

The **Action** column indicates what action can correct the exception.

8. Summary message IRO4970I is also issued:

```
IRO4970I ACTION CHANGEACCUM IS RECOMMENDED FOR cagrp-name IN RECONID=recon-name
```



---

## Chapter 12. Reference: Autonomics Director utilities

The topics in this section provide information about Autonomics Director utilities.

### Topics:

- “Pre-scan Utility (IAVXSCAN)” on page 115
- “Policy Services Exception Reporting utility (IAVXTRC0)” on page 116
- “Monitor List Registration utility (IAVBUTL0)” on page 123

---

### Pre-scan Utility (IAVXSCAN)

The Autonomics Director pre-scan utility (IAVXSCAN) verifies whether a database actually requires a scan before reorganization.

IAVXSCAN should be run after the IMS pre-reorganization utility (DFSURPRO) and before the IMS Database Scan utility (DFSURGS0) to determine whether a scan should be performed.

#### IAVXSCAN process:

1. The IAVXSCAN utility runs after the step that starts the IMS pre-reorganization utility (DFSURPRO).

- IAVXSCAN reads the output from the SYSPUNCH DD created by the preceding run of the IMS pre-reorganization utility DFSURPRO.

SYSPUNCH DD points to the output of DFSURPRO.

- The IAVXSCAN utility verifies that one of the control statements contains a scan statement for a database before that database is scanned.

IAVXSCAN is looking for a record in SYSPUNCH that has a record containing `DBS=dbname`, where `dbname` is the database name Autonomics Director is passing in.

2. When IAVXSCAN determines a database scan is required (a matching scan statement is found):

- Terminates with a condition code `RC=0`.
- The database should be scanned with the IMS Database Scan utility (DFSURGS0) before reorganization:

```
//SCAN EXEC PGM=DFSRR00,PARM='ULU,DFSURGS0',COND=(0,NE)
```

- After the scan runs, Autonomics Director must be notified (IAVXNTFY) that the IMS Database Scan completed successfully:

```
//NOTIFY EXEC PGM=IAVXNTFY,REGION=0M,COND=((0,NE,IAVXSCAN),(0,NE,DFSURGS0))
```

The `COND` keyword refers back to the IMS scan step to test for successful completion.

3. When IAVXSCAN determines that a database scan is not required (no matching scan statement is found):

- Terminates with a condition code of `RC=8`.
- IAVXSCAN informs Autonomics Director that the scan process is complete, and that no scan is required.
- Subsequent scan processing and IAVXNTFY steps are bypassed because of the conditional JCL logic `COND=(0,NE)`.

## Policy Services Exception Reporting utility (IAVXTRC0)

---

Use the Autonomics Director Policy Services exception reporting utility (IAVXTRC0) to produce reports of the Policy Services exception messages that are generated during phase 1 of one or more policy evaluations. The utility retrieves the exceptions from the Autonomics Director repository in IMS Tools Knowledge Base.

### Requirements

To run the IAVXTRC0 utility, you must have standard repository access to both of the following IMS Tools Knowledge Base repositories:

- Autonomics Director repository (IAV\_AUTODIR)
- Input repository (HKT\_INPUT)

Both repositories must belong to the same IMS Tools Knowledge Base XCF group.

### Input and output

The IAVXTRC0 utility requires the following input:

- The IMS Tools Knowledge Base XCF group that contains the Autonomics Director repository and the Input repository.
- The RECON data set name identifier (RECON ID).

The utility can produce the following output:

- Report with the summary exception messages that are generated during phase 1 of one or more policy evaluations.

The summary exception messages are displayed in the order that they were generated.

This report is included in the output data set that is defined by the SUMMARY DD.

- Report with the detailed exception notifications that are generated during phase 1 of one or more policy evaluations.

The detailed exception notifications are displayed in the order that they were generated.

This report is included in the output data set that is defined by the DETAILS DD.

**Important:** The reports that are output by the utility are formatted differently than the email notifications sent by Policy Services. The information in the reports is not identical to the information in the Policy Services email notifications. The exception messages in the reports relate to the RECON ID that you provide in the input, and the reports may include exception messages from policy evaluations that occurred over several months.

### JCL specifications

The IAVXTRC0 utility is run as a standard z/OS job. The following JCL statements are required:

- A JOB statement that you define to meet the specifications of your installation
- An EXEC statement
- DD statements that define inputs and outputs

### EXEC statement

Use the following format for the EXEC statement:

```
//RUN      EXEC  PGM=IAVXTRC0,REGION=0M,  
//      PARM='GROUP=itkb_xcf_group_name,RECONDSN=recon_data_set_id'
```

The following list describes the parameters in the EXEC statement for the IAVXTRC0 utility:

**GROUP=*itkb\_xcf\_group\_name***

IMS Tools Knowledge Base XCF group that contains both the Autonomics Director repository (IAV\_AUTODIR) and the Input repository (HKT\_INPUT).

**RECONDSN=*recon\_data\_set\_id***

Restricts processing to those members associated with the RECON ID.

The data set name that is specified can contain wildcards, such as a percent sign (%) for a single character match and an asterisk (\*) for zero or more multiple character matches.

For example, RECONDSN=MYRECON.DATASET and RECONDSN=MY\*.DATA%%% are both correctly formatted.

This parameter is optional.

If the RECONDSN parameter is not specified, all RECON members are processed

**DD statements****STEPLIB DD**

Points to the PDS(E) load library. The STEPLIB DD statement is required.

```
//STEPLIB DD DSN=pds_load_library,DISP=SHR
```

**SUMMARY DD**

Defines the output data set for the summary messages. The SUMMARY DD statement is required.

The output file attributes are RECFM=FBA and LRECL=133.

The file can be either a data set or a SYSOUT=\* specification.

**DETAILS DD**

Defines the output data set for the detailed messages. The DETAILS DD statement is required.

The output file attributes are RECFM=FBA and LRECL=133.

The file can be either a data set or a SYSOUT=\* specification.

**SYSLOG DD**

Defines the output data set for the repository audit trail of the process for possible debugging. The SYSLOG DD statement is optional.

If the optional DD statement is present, then the file attributes are RECFM=FB and LRECL=80.

The file can be either a data set or a SYSOUT=\* specification.

**Recommendation:** Use a data set for the output because the output can be large.

**Example JCL**

```
//*****
//* FIRST TEST OF AD REPOSITORY ***
//*****
//RUN EXEC PGM=IAVXTRC0,REGION=0M,
// PARM='GROUP=itkb_xcf_group_name,RECONDSN=*'
//STEPLIB DD DISP=SHR,DSN=itkb_high_level_qualifier.SHKTLOAD
//SUMMARY DD SYSOUT=*
//SYSLOG DD SYSOUT=*
//DETAILS DD SYSOUT=*
//SYSABEND DD SYSOUT=*
```

## Return codes

Table 5. Reason and return codes for the IAVXTRCO utility

Return code	Reason code	Severity	Message	Meaning
4	7	I	NO MEMBERS FOUND	No members were found with the requested criteria (for example, the RECON data set). Verify that the RECON data set name is spelled correctly.
8	8	E	MEMBER NOT FOUND	A member was not found. Verify that the member was not modified by another user during the processing of this utility.
12	3	E	INVALID KEYWORD SPECIFIED	The specified keyword is not supported. Verify that the keyword is spelled correctly.
12	4	E	ADR INITIALIZATION FAILED	Attempt to access the Autonomics Director repository failed. Verify that the GROUP parameter is correct and that the repository environment was set up correctly.
12	5	E	BEGIN LIST ACCESS FAILED	Attempt to access the member list environment failed. Verify your connection to the Autonomics Director interface.
12	6	E	GET LIST ACCESS FAILED	Attempt to obtain the member list failed.
12	9	E	POINT RECORD EXCEPTION	Unable to point to a requested record.
12	11	E	RECON ACCESS ERROR	Failed to obtain the RECON data set description from the RECON registry. Verify the validity of the RECON definition.
12	13	E	MEMORY MEMBER DELETE FAILED	After processing the Autonomics Director repository member, the memory that was used could not be removed.
16	1	E	DETAILS FILE OPEN ERROR	Unable to open the print file. Verify that the DETAILS DD statement is included in the JCL.
16	2	E	SUMMARY FILE OPEN ERROR	Unable to open the output file. Verify that the SUMMARY DD statement is included in the JCL.

### Example report: Output from the SUMMARY DD

At the beginning of the report, a table lists the associated RECON data sets. The following messages are a sampling of SUMMARY DD output:

```
GROUP=DAIFPQS2 RECON(DATASET)=*
INDEX EXT. RECON DATASET NAME
```

```
-----
1. NORECON NORECON
2. BSNGLOBL BSNGLOBL
3. QA13 DBGTOOL.QA.Q13A.RECON1
4. ACDEMOFF MODERN1.ACDEMO.FF.RECON1
5. MODERN1 MODERN1.ADC1.RECOND1
6. MODERN12 MODERN1.ADC1.RECONC1
7. ACDEMOFF DBGTOOL.ACDEMO.DAIFPQS2.RECON1
8. BSNSCDRV DBGTOOL.IMSTOOL.YSL.BSNSCDRV.RECON1
-----
```

NUMBER OF RECONS ACCEPTED=+8

```
SUMMARY ANALYSIS: RC=00000004 RSN=00000041 RECON=BSNSCDRV MSGLEN=0
SUMMARY ANALYSIS: RC=0000000C RSN=0000000C RECON=BSNSCDRV MSGLEN=0
SUMMARY ANALYSIS: RC=00000000 RSN=00000000 RECON=BSNSCDRV RTYPE=EVAL MSGLEN=+72
SUM MSG:HFP2910I ACTION "REORG" IS RECOMMENDED FOR DB30AR0 IN RECONID=BSNSCDRV.
SUMMARY ANALYSIS: RC=00000000 RSN=00000000 RECON=BSNSCDRV RTYPE=EVAL MSGLEN=+77
SUM MSG:HFP2910I ACTION "EXTENDIOVF" IS RECOMMENDED FOR DB30AR0 IN RECONID=BSNSCDRV.
SUMMARY ANALYSIS: RC=00000000 RSN=00000000 RECON=BSNSCDRV RTYPE=EVAL MSGLEN=+77
SUM MSG:HFP2910I ACTION "EXTENDSDEP" IS RECOMMENDED FOR DB30AR0 IN RECONID=BSNSCDRV.
EXC MSG:The average number of I/Os per DB record exceeded a threshold in area DB30AR0.
EXC MSG:The maximum number of I/Os per DB record exceeded a threshold in area DB30AR0.
EXC MSG:Free spaces in RAA BASE and IOVF are used inefficiently in area DB30AR0.
EXC MSG:Free spaces in DOVF and IOVF are used inefficiently in area DB30AR0.
EXC MSG:Free spaces in RAA, DOVF, and IOVF are used inefficiently in area DB30AR0.
EXC MSG:The percentage of RAP CIs using overflow exceeded a threshold in area DB30AR0.
EXC MSG:The percentage of free space in IOVF fell below a threshold in area DB30AR0.
EXC MSG:The percentage of free space in SDEP fell below a threshold in area DB30AR0.
EXC MSG:The percentage of UOWs that match the RBASEFS or the RDOVFFS condition exceeded a threshold in area DB30AR0.
SUMMARY ANALYSIS: RC=00000000 RSN=00000000 RECON=BSNSCDRV RTYPE=EVAL MSGLEN=+72
SUM MSG:HFP2910I ACTION "REORG" IS RECOMMENDED FOR DB30AR0 IN RECONID=BSNSCDRV.
EXC MSG:The average number of I/Os per DB record exceeded a threshold in area DB30AR0.
EXC MSG:The maximum number of I/Os per DB record exceeded a threshold in area DB30AR0.
EXC MSG:The percentage of RAP CIs using overflow exceeded a threshold in area DB30AR0.
EXC MSG:The percentage of UOWs that match the RBASEFS or the RDOVFFS condition exceeded a threshold in area DB30AR0.
SUMMARY ANALYSIS: RC=00000000 RSN=00000000 RECON=BSNSCDRV RTYPE=EVAL MSGLEN=+72
SUM MSG:HFP2910I ACTION "REORG" IS RECOMMENDED FOR DB30AR0 IN RECONID=BSNSCDRV.
EXC MSG:The average number of I/Os per DB record exceeded a threshold in area DB30AR0.
EXC MSG:The maximum number of I/Os per DB record exceeded a threshold in area DB30AR0.
EXC MSG:The percentage of RAP CIs using overflow exceeded a threshold in area DB30AR0.
EXC MSG:The percentage of UOWs that match the RBASEFS or the RDOVFFS condition exceeded a threshold in area DB30AR0.
SUMMARY ANALYSIS: RC=00000000 RSN=00000000 RECON=MODERN12 RTYPE=EVAL MSGLEN=+72
SUM MSG:HFP2910I ACTION "REORG" IS RECOMMENDED FOR CCARA001 IN RECONID=MODERN12.
SUMMARY ANALYSIS: RC=00000000 RSN=00000000 RECON=MODERN12 RTYPE=EVAL MSGLEN=+77
SUM MSG:HFP2910I ACTION "EXTENDIOVF" IS RECOMMENDED FOR CCARA001 IN RECONID=MODERN12.
SUMMARY ANALYSIS: RC=00000000 RSN=00000000 RECON=MODERN12 RTYPE=EVAL MSGLEN=+77
SUM MSG:HFP2910I ACTION "EXTENDSDEP" IS RECOMMENDED FOR CCARA001 IN RECONID=MODERN12.
EXC MSG:The average number of I/Os per DB record exceeded a threshold in area CCARA001.
EXC MSG:The maximum number of I/Os per DB record exceeded a threshold in area CCARA001.
EXC MSG:Free spaces in RAA BASE and IOVF are used inefficiently in area CCARA001.
EXC MSG:Free spaces in DOVF and IOVF are used inefficiently in area CCARA001.
EXC MSG:Free spaces in RAA, DOVF, and IOVF are used inefficiently in area CCARA001.
EXC MSG:The percentage of RAP CIs using overflow exceeded a threshold in area CCARA001.
EXC MSG:The percentage of free space in IOVF fell below a threshold in area CCARA001.
EXC MSG:The percentage of free space in SDEP fell below a threshold in area CCARA001.
EXC MSG:The percentage of UOWs that match the RBASEFS or the RDOVFFS condition exceeded a threshold in area CCARA001.
```

## Example report: Output from the DETAILS DD

At the beginning of the report, a table lists the associated RECON data sets. The following information is a sampling of DETAILS DD output:

GROUP=DAIFPQS2 RECON(DATASET)=\*

INDEX	EXT. RECON	DATASET NAME
1.	NORECON	NORECON
2.	BSNGLOBL	BSNGLOBL
3.	QA13	DBGTOOL.QA.Q13A.RECON1
4.	ACDEMOFF	MODERN1.ACDEMO.FF.RECON1
5.	MODERN1	MODERN1.ADC1.RECOND1
6.	MODERN12	MODERN1.ADC1.RECONC1
7.	ACDEMOFF	DBGTOOL.ACDEMO.DAIFPQS2.RECON1
8.	BSNSCDRV	DBGTOOL.IMSTOOL.YSL.BSNSCDRV.RECON1

NUMBER OF RECONS ACCEPTED=+8  
 VER=1 TYPE=S INDEX=000001 RC=00000004 RSN=00000041 RECON=BSNSCDRV RTYPE=EVAL DBUSE=DL1  
 MSGLEN=0  
 INDICTORS: REORG NEEDED=? SEVERITY=? SDEP NEEDED=? IOVF NEEDED=?  
 EXTENSION: TOD2=02/19/2024 12:16:49.822158(CCBD1A5BDF9CEBB3)  
 SENSOR TOD=02/19/2024 12:16:42.460750(CCBD1A54DA64E000)

VER=1 TYPE=S INDEX=000002 RC=0000000C RSN=0000000C RECON=BSNSCDRV RTYPE=EVAL DBUSE=DL1  
 MSGLEN=0  
 INDICTORS: REORG NEEDED=? SEVERITY=? SDEP NEEDED=? IOVF NEEDED=?  
 EXTENSION: TOD2=03/14/2024 06:33:52.039032(CCD9B898F8C788F0)  
 SENSOR TOD=03/14/2024 06:33:46.137334(CCD9B89357EF6000)

VER=2 TYPE=S INDEX=000003 RC=00000000 RSN=00000000 RECON=BSNSCDRV RTYPE=EVAL DBUSE=DL1  
 MSGLEN=+72  
 INDICTORS: REORG NEEDED=Y SEVERITY=C SDEP NEEDED=Y IOVF NEEDED=Y  
 EXTENSION: TOD2=03/18/2024 20:45:39.633031(CCDF7E72D0B873B2)  
 SENSOR TOD=03/18/2024 20:45:38.124513(CCDF7E71606E1000)  
 INDICTORS: REORG NEEDED=Y SEVERITY=C SDEP NEEDED=Y IOVF NEEDED=Y  
 SUM MSG:HFP2910I ACTION "REORG" IS RECOMMENDED FOR DB30AR0 IN RECONID=BSNSCDRV.

VER=2 TYPE=S INDEX=000004 RC=00000000 RSN=00000000 RECON=BSNSCDRV RTYPE=EVAL DBUSE=DL1  
 MSGLEN=+77  
 INDICTORS: REORG NEEDED=Y SEVERITY=C SDEP NEEDED=Y IOVF NEEDED=Y  
 EXTENSION: TOD2=03/18/2024 20:45:39.633031(CCDF7E72D0B873B2)  
 SENSOR TOD=03/18/2024 20:45:38.124513(CCDF7E71606E1000)  
 INDICTORS: REORG NEEDED=Y SEVERITY=C SDEP NEEDED=Y IOVF NEEDED=Y  
 SUM MSG:HFP2910I ACTION "EXTENDIOVF" IS RECOMMENDED FOR DB30AR0 IN RECONID=BSNSCDRV.

VER=2 TYPE=S INDEX=000005 RC=00000000 RSN=00000000 RECON=BSNSCDRV RTYPE=EVAL DBUSE=DL1  
 MSGLEN=+77  
 INDICTORS: REORG NEEDED=Y SEVERITY=C SDEP NEEDED=Y IOVF NEEDED=Y  
 EXTENSION: TOD2=03/18/2024 20:45:39.633031(CCDF7E72D0B873B2)  
 SENSOR TOD=03/18/2024 20:45:38.124513(CCDF7E71606E1000)  
 INDICTORS: REORG NEEDED=Y SEVERITY=C SDEP NEEDED=Y IOVF NEEDED=Y  
 SUM MSG:HFP2910I ACTION "EXTENDSDEP" IS RECOMMENDED FOR DB30AR0 IN RECONID=BSNSCDRV.

VER=2 TYPE=E INDEX=000001 RC=00000000 RSN=00000000 RECON=BSNSCDRV RTYPE=EVAL DBUSE=DL1  
 MSGLEN=+78  
 INDICTORS: REORG NEEDED=Y SEVERITY=C SDEP NEEDED=Y IOVF NEEDED=Y  
 EXTENSION: TOD2=03/18/2024 20:45:39.633031(CCDF7E72D0B873B2)  
 SENSOR TOD=03/18/2024 20:45:38.124513(CCDF7E71606E1000)  
 LEVEL=SEVERE NAME=MESSAGE CLASS=DEDB\_EXCESSIVE\_AVG\_NUM\_RECORD\_IO  
 CODE PAGE=0000047C RULE=G:IBM.DEDB\_DBREC\_IO.10/MED  
 EXC MSG:The average number of I/Os per DB record exceeded a threshold in area DB30AR0.

VER=2 TYPE=E INDEX=000002 RC=00000000 RSN=00000000 RECON=BSNSCDRV RTYPE=EVAL DBUSE=DL1  
 MSGLEN=+78  
 INDICTORS: REORG NEEDED=Y SEVERITY=C SDEP NEEDED=Y IOVF NEEDED=Y  
 EXTENSION: TOD2=03/18/2024 20:45:39.633031(CCDF7E72D0B873B2)  
 SENSOR TOD=03/18/2024 20:45:38.124513(CCDF7E71606E1000)  
 LEVEL=CRITICAL NAME=MESSAGE CLASS=DEDB\_DBRECORD\_WITH\_EXCESSIVE\_IO  
 CODE PAGE=0000047C RULE=G:IBM.DEDB\_DBREC\_IO.20/HIGH  
 EXC MSG:The maximum number of I/Os per DB record exceeded a threshold in area DB30AR0.

VER=2 TYPE=E INDEX=000003 RC=00000000 RSN=00000000 RECON=BSNSCDRV RTYPE=EVAL DBUSE=DL1  
 MSGLEN=+72  
 INDICTORS: REORG NEEDED=Y SEVERITY=C SDEP NEEDED=Y IOVF NEEDED=Y  
 EXTENSION: TOD2=03/18/2024 20:45:39.633031(CCDF7E72D0B873B2)  
 SENSOR TOD=03/18/2024 20:45:38.124513(CCDF7E71606E1000)  
 LEVEL=CRITICAL NAME=MESSAGE CLASS=DEDB\_FREE\_SPACE\_IN\_RAA\_VS\_IOVF  
 CODE PAGE=0000047C RULE=G:IBM.DEDB\_FS.50/HIGH  
 EXC MSG:Free spaces in RAA BASE and IOVF are used inefficiently in area DB30AR0.



The content of the output varies according to the information in the Autonomics Director repository. The following fields might be displayed in the output:

**GROUP**

IMS Tools Knowledge Base XCF group that was specified for the utility.

**RECON(DATASET)**

The RECON ID that was specified for the utility.

DATASET is the RECON data set name filter (wildcards allowed) for the pertinent exception messages.

**EXT. RECON**

External RECON ID.

**DATASET NAME**

Name of the data set associated with the RECON.

**NUMBER OF RECONS ACCEPTED**

Number of RECON data sets that were accessed by the utility.

**VER**

Version of the output.

**1**

Contains a single exception message.

**2**

Contains one or more exception messages.

**TYPE**

Message type.

**E**

Exception message.

**S**

Summary message.

**INDEX**

Number of exceptions or summary messages.

**RC**

Return code from the evaluation in hex format.

**RSN**

Reason code from the evaluation in hex format.

**RECON**

RECON associated with the message.

The RECON must be defined in the RECON registry.

**RTYPE**

Record type.

**SPOL**

Created by Policy Services.

**SENS**

Created from sensor data.

**EVAL**

Created from a policy evaluation.

**????**

Undefined.

**DBUSE**

Type of database.

Examples are DLI and Db2.

**MSGLEN**

Length of the message.

**REORG NEEDED**

Indicates whether a reorganization is recommended.

**N**

Reorganization is not recommended.

**Y**

Reorganization is recommended.

**SEVERITY**

Level of severity.

- W for warning
- C for critical
- S for severe

**SDEP NEEDED**

Indicates whether an SDEP extension of a DEDB area is recommended.

**N**

SDEP extension is not recommended.

**Y**

SDEP extension is recommended.

**IOVF NEEDED**

Indicates whether an IOVF extension of a DEDB area is recommended.

**N**

IOVF extension is not recommended.

**Y**

IOVF extension is recommended.

**TOD2**

Date and time that the evaluation ended.

**SENSOR TOD**

Date and time of the most recent sensor data collection before the evaluation.

**SUM MSG**

Content of the summary message.

**LEVEL**

Exception level of the message from Policy Services.

- WARNING
- CRITICAL
- SEVERE

**NAME**

Name of the action.

**REORG**

A reorganization is recommended.

**EXTENDSDEP**

An SDEP extension of a DEDB area is recommended.

**EXTENDIOVF**

An IOVF extension of a DEDB area is recommended.

**MESSAGE**

A rule exception message is issued.

**CLASS**

Exception class name.

For more information about an exception class name, see the *IMS Tools Base Policy Services User's Guide and Reference*.

**CODE PAGE**

Translation code page for the message.

**RULE**

Policy rule or user set exception level.

For more information about a rule, see the *IMS Tools Base Policy Services User's Guide and Reference*.

**EXC MSG**

The long version of the message.

For more information about an exception message, see the *IMS Tools Base Policy Services User's Guide and Reference*.

## Monitor List Registration utility (IAVBUTLO)

---

The Monitor List Registration utility is a batch utility that adds multiple databases to the monitor list.

IAVSYSIN DD is the input SYSIN DD for this utility. On the IAVSYSIN DD statement, you supply the names of the databases that you want to add to the monitor list together with monitoring attributes. When the utility is run, it adds all the databases found on the IAVSYSIN DD statement with specified monitoring attributes to the monitor list.

If one or more of the specified databases already exist in the monitor list, the utility updates the database entries and ends with return code 4 to alert that the entries were updated.

**Tip:** Use the Monitor List Registration utility to add or update multiple entries in the monitor list at once. If you want to add or update a single entry, you can use the Autonomics Director client dialog. For more information, see [“Adding or updating monitor list entries”](#) on page 57.

### Running the Monitor List Registration utility

The Monitor List Registration utility runs as a standard z/OS batch job. To add or update entries in the monitor list, code the Monitor List Registration utility JCL and run the job.

#### Before you begin

1. Ensure that both the Autonomics Director server and the IMS Tools Knowledge Base server are available. The utility uses these servers to update the monitor list that is stored in the Autonomics Director repository managed by IMS Tools Knowledge Base.
2. You must create skeleton JCL for use with DB Sensor. For more information about creating JCL for DB Sensor, see the *IMS Tools Base Configuration Guide*.

#### Procedure

To add or update monitor list entries:

1. Copy IAVBMLA0 from SHKTSAMP as sample JCL.
2. Write the EXEC and the DD statements.

See [“EXEC and DD statements for the Monitor List Registration utility”](#) on page 124 for information about the format of the EXEC statement and the input and the output DD statements.

3. Specify GLOBAL, ATTRIBUTE, and DATABASE command keywords on the IAVSYSIN DD statement.

See [“Control statements for the Monitor List Registration utility”](#) on page 125 for information about the keywords that can be specified for these commands.

**Tip:** The Monitor List Registration utility supports adding or updating up to 9,999 databases entries in one job. However, the actual number of entries that can be added or updated in one job may be less depending on the system resource availability. If you want to add or update a large number of database entries, consider running multiple Monitor List Registration utility jobs.

#### 4. Submit the job.

Ensure that the job completes with a return code of 0 or 4. Return code 4 indicates that either the job completed with a warning condition or one or more existing entries were updated. You can review detailed registration result in the Monitor List Registration report.

If the utility ends with one of other return codes, review the Journal Messages report and identify the cause of the error.

## Example JCL for the Monitor List Registration utility

To run the Monitor List Registration utility, run the job step that is similar to that shown in the following figure.

```
//S01 EXEC PGM=IAVBUTL0, PARM=' FUNC=ADD_MONITORLIST '  
//STEPLIB DD DISP=SHR, DSN=ITB.SHKTLOAD  
//IAVBJRNL DD SYSOUT=*  
//IAVBRPRT DD SYSOUT=*  
//IAVSYSIN DD *  
GLOBAL(  
ITKBSRVR(FPQSRV01)  
ADXCFCGRP(IAVADM00)  
RECONID(IMSARECN)  
)  
ATTRIBUTE(  
OWNER(ITBUSR)  
PRIORITY(5)  
AUTOEVAL(Y)  
EVALCNT(010)  
EVALINT(001:000:00)  
SENSOR_AGE(001:000:00)  
SENSOR_JCLDSN(IMSTOOLS.ITB17.JCLLIB)  
SENSORID_FFDB(FF)  
SENSORID_HALDB(HALDB)  
SENSORID_DEDB(FP)  
REORG_POLICY(DBTYPE(FFDB) POLICYBY(DBTYPE))  
REORG_POLICY(DBTYPE(HALDB) POLICYBY(DBDNAME))  
REORG_POLICY(DBTYPE(DEDB) POLICYBY(NAME) POLICYNAME(SYS.DBDBTYPE.DEDB))  
RECOVERY_POLICY(DBTYPE(ALL) POLICYBY(DEFAULT))  
)  
DATABASE(DBD(CAGDA01))  
...  
DATABASE(DBD(Z9Y9A02))  
/*
```

Figure 14. JCL for the Monitor List Registration utility

## EXEC and DD statements for the Monitor List Registration utility

You must specify an EXEC statement and DD statements that define the input and output data sets in your JCL.

### EXEC statement

The EXEC statement must be in the following format:

```
EXEC PGM=IAVBUTL0, PARM=' FUNC=ADD_MONITORLIST '
```

### DD statements

Specify DD statements as follows:

### STEPLIB DD

Required DD statement. It specifies the IMS Tools Base product library (SHKLOAD data set). The library must be APF-authorized.

### IAVSYSIN DD

Required DD statement. It specifies the input control statements that control the Monitor List Registration utility.

### IAVBJRNL DD

Optional DD statement. It specifies the processing log output data set, which stores processing messages that are issued by the Monitor List Registration utility.

If you do not specify this DD statement, the Monitor List Registration utility dynamically allocates the data set by using SYSOUT=\*

### IAVBRPRT DD

Optional DD statement. It specifies the report output data set, which stores the Monitor List Registration report.

If you do not specify this DD statement, the Monitor List Registration utility dynamically allocates the data set by using SYSOUT=\*

## Control statements for the Monitor List Registration utility

A control statement for the Monitor List Registration utility contains information needed to access IMS Tools Base servers, a list of databases to add or update, and database monitoring attributes to apply to new and updated monitor list entries.

The control statement must be specified in the IAVSYSIN data set. This control statement data set generally resides in the input stream. However, it can also be defined as a sequential data set or as a member of a partitioned data set. It must contain 80-byte, fixed-length records. The block size, if coded, must be a multiple of 80.

The control statement must be coded in columns 1 - 72. Columns 73 - 80 are regarded as comments and ignored.

### GLOBAL command

The **GLOBAL** command specifies the information needed to access IMS Tools Base servers.

The following syntax diagram shows the syntax for the **GLOBAL** command:

►► GLOBAL( — ADXCFGRP( *AD\_XCF\_group\_name* ) — ITKBSRVR( *IMS\_Tools\_KB\_server\_name* ) ) ►►

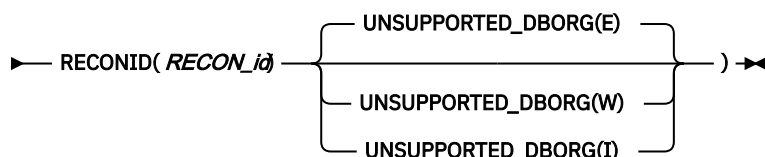

The following table summarizes the keywords for the **GLOBAL** command.

Keyword	Required or optional?	Default	Description
ADXCFGRP	Required	N/A	Specify the name of the Autonomics Director server XCF group.
ITKBSRVR	Required	N/A	Specify the name of the IMS Tools KB server XCF group.

---

Table 6. **GLOBAL** command keywords (continued)

---

<b>Keyword</b>	<b>Required or optional?</b>	<b>Default</b>	<b>Description</b>
RECONID	Required	N/A	Specify the RECON ID that identifies the IMS Tools KB RECON environment.
UNSUPPORTED_DBORG	Optional	E	By using a wildcard (*) in a database name, you might unintentionally select databases of unsupported database organization types. Specify the level of message for the cases where an unsupported database organization type is detected:  <b>E</b> Issues IAV8044E message and sets a return code of 8.  <b>W</b> Issues IAV8064W message and sets a return code of 4.  <b>I</b> Issues IAV8065I message.

---

## **ATTRIBUTE** command

The **ATTRIBUTE** command specifies monitoring attributes. There can be only one **ATTRIBUTE** command. The monitoring attributes supplied with the **ATTRIBUTE** command are applied to all the database entries that are added or updated in the job.

The following syntax diagram shows the syntax for the **ATTRIBUTE** command:

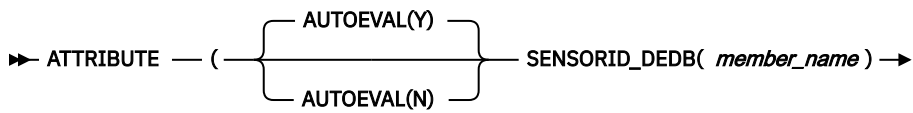

►► SENSORID\_FFDB( *member\_name* ) —►

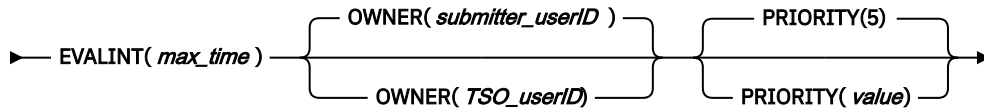
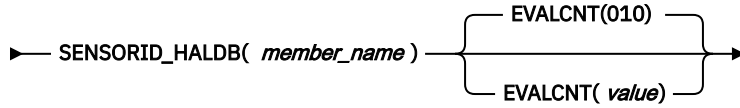

►► SENSOR\_AGE( *max\_age* ) — SENSOR\_JCLDSN( *data\_set\_name* ) —►

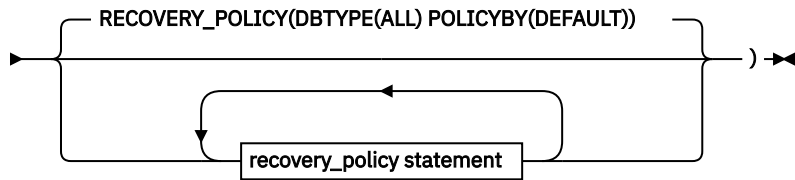
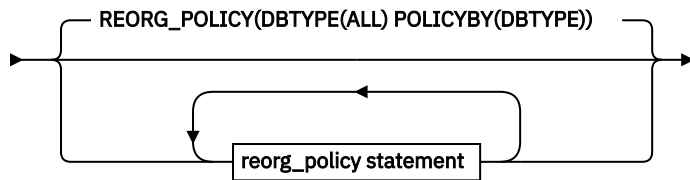

**reorg\_policy statement**

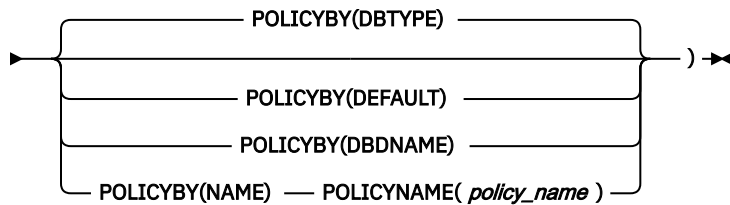
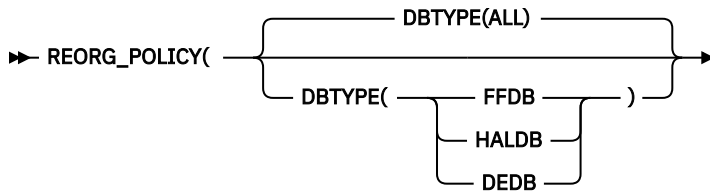

**recovery\_policy statement**

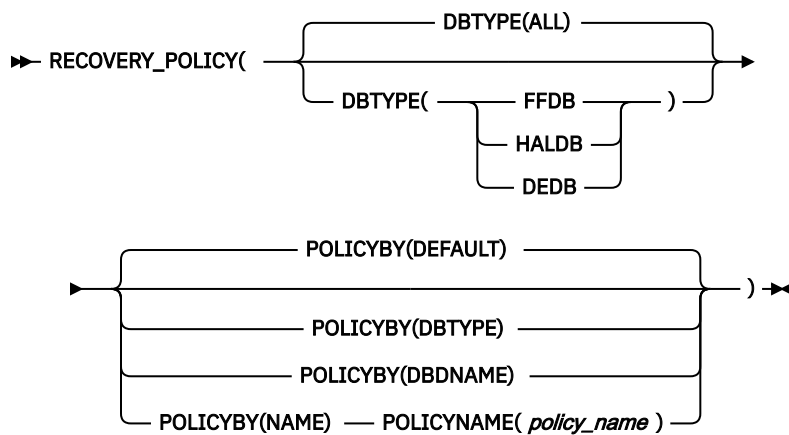

The following table summarizes the keywords for the **ATTRIBUTE** command.

Table 7. **ATTRIBUTE** command keywords

Keyword	Required or optional?	Default	Description
AUTOEVAL	Optional	Y	Specify whether to evaluate the database, partition, or area after each sensor data collection run for the selected database, partition, or area. Valid values are Y (evaluate) and N (do not evaluate).
SENSORID_DEDB	Optional	N/A	At least one SENSORID_XXXX keyword must be specified. If you are adding or updating one or more DEDB area entries, you must specify the SENSORID_DEDB keyword.  Specify the partitioned data set member that contains the JCL for Fast Path DEDB that is used to run the sensor data collector.  During evaluation run scheduling, a domain-specific suffix is added to the member name. Therefore, the member name must not exceed seven characters. For REORG sensor collection, the member name is used as specified. For RECOVERY sensor collection, the letter Y is appended to the specified member name.



Table 7. **ATTRIBUTE** command keywords (continued)

Keyword	Required or optional?	Default	Description
SENSORID_FFDB	Optional	N/A	<p>At least one SENSORID_XXXX keyword must be specified. If you are adding or updating one or more full-function database entries, you must specify the SENSORID_FFDB keyword.</p> <p>Specify the partition data set member that contains the JCL for full-function database that is used to run the sensor data collector.</p> <p>During evaluation run scheduling, a domain-specific suffix is added to the member name. Therefore, the member name must not exceed seven characters. For REORG sensor collection, the member name is used as specified. For RECOVERY sensor collection, the letter Y is appended to the specified member name.</p>
SENSORID_HALDB	Optional	N/A	<p>At least one SENSORID_XXXX keyword must be specified. If you are adding or updating one or more HALDB partition entries, you must specify the SENSORID_HALDB keyword.</p> <p>Specify the partitioned data set member that contains the JCL for HALDB database that is used to run the sensor data collector.</p> <p>During evaluation run scheduling, a domain-specific suffix is added to the member name. Therefore, the member name must not exceed seven characters. For REORG sensor collection, the member name is used as specified. For RECOVERY sensor collection, the letter Y is appended to the specified member name.</p>
EVALCNT	Optional	10	Specify the number of evaluations that are saved for the database, partition, or area. This value is in the range of 1 - 255.
EVALINT	Required	N/A	Specify the maximum amount of time that can elapse before a policy evaluation is scheduled for the selected database, partition, or area. This value is expressed in days, hours, and minutes in <i>days:hrs:mins</i> format. For example, 031:001:30 indicates 31 days, 1 hour, and 30 minutes can elapse before the next evaluation.
OWNER	Optional	User ID of the utility job submitter	Specify the TSO user ID of the owner. Automated jobs of Autonomics Director are submitted by using this user ID. This user ID must have proper RACF authority.

Table 7. **ATTRIBUTE** command keywords (continued)

Keyword	Required or optional?	Default	Description
PRIORITY	Optional	5	Specify the priority level that is used when the database, partition, or area is selected for evaluation. This value is in the range of 1 - 9. A value of 1 indicates the highest priority, which means that this database, partition, or area is evaluated first.
SENSOR_AGE	Required	N/A	Specify the maximum age of sensor data for the database, partition, or area. This value is expressed in days, hours, and minutes in <i>days:hrs:mins</i> format. For example, 031:001:30 indicates 31 days, 1 hour, and 30 minutes is the maximum age of sensor data. If the sensor data is older than the specified age, a sensor run is scheduled before an evaluation run.
SENSOR_JCLDSN	Required	N/A	Specify the name of the cataloged partitioned data set that contains the JCL that is used to run the sensor data collector.

The following tables summarize the keywords for the REORG\_POLICY statement and the RECOVERY\_POLICY statement of the **ATTRIBUTE** command. Up to three REORG\_POLICY statements and RECOVERY\_POLICY statements can be specified, respectively.

Use REORG\_POLICY statement for the REORG domain, and RECOVERY\_POLICY statement for the RECOVERY domain.

Table 8. REORG\_POLICY statement keywords (**ATTRIBUTE** command keywords)

Keyword	Required or optional?	Default	Description
DBTYPE	Optional	ALL	Specify the type of database to which this REORG_POLICY statement applies.  <b>ALL</b> The POLICYBY and POLICYNAME keywords specified in this REORG_POLICY statement apply to all databases regardless of their database type. If you specify DBTYPE(ALL), there must be no other REORG_POLICY statement.  <b>FFDB</b> The POLICYBY and POLICYNAME keywords specified in this REORG_POLICY statement apply only to full-function databases.  <b>HALDB</b> The POLICYBY and POLICYNAME keywords specified in this REORG_POLICY statement apply only to HALDB partitions.  <b>DEDB</b> The POLICYBY and POLICYNAME keywords specified in this REORG_POLICY statement apply only to Fast Path DEDB areas.

Table 8. REORG\_POLICY statement keywords (**ATTRIBUTE** command keywords) (continued)

Keyword	Required or optional?	Default	Description
POLICYBY	Optional	DBTYPE	<p>Specify how Policy Services determines the name of the policy for database evaluation.</p> <p><b>DEFAULT</b> The policy name is determined in the same manner as DBTYPE (using the database organization form).</p> <p><b>DBTYPE</b> The policy name is determined by using the database organization form.</p> <p><b>DBDNAME</b> The policy name is determined by using the policy name that is associated with the database.</p> <p><b>NAME</b> The policy name is determined by using the policy name that is specified on the subsequent POLICYNAME keyword.</p>
POLICYNAME	Optional	N/A	<p>Specify the policy name for database evaluation. This keyword is required when POLICYBY(NAME) is specified. The POLICYNAME keyword is effective only when POLICYBY(NAME) is specified.</p>

Table 9. RECOVERY\_POLICY statement keywords (**ATTRIBUTE** command keywords)

Keyword	Required or optional?	Default	Description
DBTYPE	Optional	ALL	<p>Specify the type of database to which this RECOVERY_POLICY statement applies.</p> <p><b>ALL</b> The POLICYBY and POLICYNAME keywords specified in this RECOVERY_POLICY statement apply to all databases regardless of their database type. If you specify DBTYPE(ALL), there must be no other RECOVERY_POLICY statement.</p> <p><b>FFDB</b> The POLICYBY and POLICYNAME keywords specified in this RECOVERY_POLICY statement apply only to full-function databases.</p> <p><b>HALDB</b> The POLICYBY and POLICYNAME keywords specified in this RECOVERY_POLICY statement apply only to HALDB partitions.</p> <p><b>DEDB</b> The POLICYBY and POLICYNAME keywords specified in this RECOVERY_POLICY statement apply only to Fast Path DEDB areas.</p>

Table 9. RECOVERY\_POLICY statement keywords (**ATTRIBUTE** command keywords) (continued)

Keyword	Required or optional?	Default	Description
POLICYBY	Optional	DEFAULT	<p>Specify how Policy Services determines the name of the policy for database evaluation.</p> <p><b>DEFAULT</b> The default policy is used.</p> <p><b>DBTYPE</b> The policy name is determined by using the database organization form.</p> <p><b>DBDNAME</b> The policy name is determined by using the policy name that is associated with the database.</p> <p><b>NAME</b> The policy name is determined by using the policy name that is specified on the subsequent POLICYNAME keyword.</p>
POLICYNAME	Optional	N/A	<p>Specify the policy name for database evaluation. This keyword is required when POLICYBY(NAME) is specified. The POLICYNAME keyword is effective only when POLICYBY(NAME) is specified.</p>

## DATABASE command

The **DATABASE** command specifies the name of the database that you want to add to the monitor list or update in the monitor list. There can be up to 9,999 **DATABASE** commands.

The following syntax diagram shows the syntax for the **DATABASE** command:

➤ DATABASE( — DBD(*database\_name*) — ) ➤

The Monitor List Registration utility supports adding or updating up to 9,999 databases entries in one job. However, the actual number of entries that can be added or updated in one job may be less depending on the system resource availability. If you want to add or update a large number of database entries, consider running multiple Monitor List Registration utility jobs.

Table 10. **DATABASE** command keywords

Keyword	Required or optional?	Default	Description
DBD	Required	N/A	<p>Specify the name of the database that you want to add to or update in the monitor list.</p> <p>The database name can contain an asterisk (*) as a wildcard for zero or more character matches. A percent sign (%) for a single character match is not supported.</p> <p>For example, DATABASE(DBD(*)) and DATABASE(DBD(NAME*)) are both correctly formatted.</p>

## Output from the Monitor List Registration utility

The Monitor List Registration utility generates a Journal Messages report, a Process Summary report, and a Monitor List Registration report.

### Journal Messages report

The Journal Messages report contains processing messages about the Monitor List Registration utility. This report is generated in the IAVBJRNL data set.

```
Tools Base Autonomics Director - V1R7          Journal Messages          MONITOR LIST REGISTRATION UTIL.
5655-V93                                         Date: 2024-07-29 Time: 20:00:00
2024-07-29 20:00:023 IAV8001I THE MONITOR LIST REGISTRATION UTILITY PROCESS HAS STARTED.
2024-07-29 20:00:023 IAV8063I IAVSYSIN Control Cards follow:
2024-07-29 20:00:023 IAV8063I GLOBAL (
2024-07-29 20:00:023 IAV8063I   ITKBSRVR (FPQSRV01)
2024-07-29 20:00:023 IAV8063I   ADXCFGRP (IAVADM00)
2024-07-29 20:00:023 IAV8063I   RECONID (IMSARECN)
2024-07-29 20:00:023 IAV8063I   UNSUPPORTED_DBORG (E)
2024-07-29 20:00:023 IAV8063I )
2024-07-29 20:00:023 IAV8063I ATTRIBUTE (
2024-07-29 20:00:023 IAV8063I   OWNER (ITBUSR)
2024-07-29 20:00:023 IAV8063I   PRIORITY (5)
2024-07-29 20:00:023 IAV8063I   AUTOEVAL (Y)
2024-07-29 20:00:023 IAV8063I   EVALCNT (010)
2024-07-29 20:00:023 IAV8063I   EVALINT (001:000:00)
2024-07-29 20:00:023 IAV8063I   SENSOR_AGE (001:000:00)
2024-07-29 20:00:023 IAV8063I   SENSOR_JCLDSN (IMSTOOLS.ITB17.JCLLIB)
2024-07-29 20:00:023 IAV8063I   SENSORID_FFDB (FF)
2024-07-29 20:00:023 IAV8063I   SENSORID_HALDB (HALDB)
2024-07-29 20:00:023 IAV8063I   SENSORID_DEDB (FP)
2024-07-29 20:00:023 IAV8063I   REORG_POLICY (DBTYPE (FFDB) POLICYBY (DBTYPE))
2024-07-29 20:00:023 IAV8063I   REORG_POLICY (DBTYPE (HALDB) POLICYBY (DBDNAME))
2024-07-29 20:00:023 IAV8063I   REORG_POLICY (DBTYPE (DEDB) POLICYBY (NAME) POLICYNAME (SYS.DBDTYPE.DEDB))
2024-07-29 20:00:023 IAV8063I   RECOVERY_POLICY (DBTYPE (ALL) POLICYBY (DEFAULT))
2024-07-29 20:00:023 IAV8063I )
2024-07-29 20:00:023 IAV8063I DATABASE (DBD (AUTODB))
2024-07-29 20:00:023 IAV8063I DATABASE (DBD (DEDBJN23))
2024-07-29 20:00:023 IAV8063I DATABASE (DBD (HAL1H1))
2024-07-29 20:00:023 IAV8063I DATABASE (DBD (DEDBJN20))
2024-07-29 20:00:023 IAV8063I DATABASE (DBD (DEDBJN24))
2024-07-29 20:00:023 IAV8063I DATABASE (DBD (GSAMDB))
2024-07-29 20:00:024 IAV8039I CONNECTED TO THE AD SERVER. NAME=IAVSRV01.
2024-07-29 20:00:066 IAV8042W PARTITION HAL1H1C OF DBD HAL1H1 , WHICH EXISTS IN THE MONITOR LIST, IS NOT FOUND IN THE DBD.
2024-07-29 20:00:418 IAV8043E DBD DEDBJN20 DOES NOT EXIST.
2024-07-29 20:00:429 IAV8044E DATABASE ORGANIZATION TYPE GSAM IS NOT SUPPORTED. DBD GSAMDB .
2024-07-29 20:01:045 IAV8041W DBD AUTODB HAS BEEN UPDATED IN THE MONITOR LIST.
2024-07-29 20:01:273 IAV8040I DBD DEDBJN23 HAS BEEN ADDED TO THE MONITOR LIST.
2024-07-29 20:01:298 IAV8041W DBD HAL1H1 HAS BEEN UPDATED IN THE MONITOR LIST.
2024-07-29 20:01:476 IAV8041W DBD DEDBJN24 HAS BEEN UPDATED IN THE MONITOR LIST.
2024-07-29 20:02:230 IAV8004E THE MONITOR LIST REGISTRATION UTILITY PROCESS HAS ENDED WITH ERROR.
```

Figure 15. Journal Messages report

### Process Summary report

The Process Summary report contains the summary of registration processing by the Monitor List Registration utility. This report is generated in the IAVBRPRT data set.

```
Tools Base Autonomics Director - V1R7          Process Summary Report          Page: 1
5655-V93                                         Date: 2024-07-29 Time: 20:00:00
GLOBAL statement:

ITKBSRVR ..... FPQSRV01
ADXCFGRP ..... IAVADM00
RECONID ..... IMSARECN
UNSUPPORTED_DBORG .. E

Summary of monitor list registration:

Number of entries added
Full-function databases ..... nn,nnn,nnn
HALDB partitions ..... nn,nnn,nnn
Fast Path DEDB areas ..... nn,nnn,nnn

Total ..... nn,nnn,nnn

Number of entries updated
Full-function databases ..... nn,nnn,nnn
HALDB partitions ..... nn,nnn,nnn
Fast Path DEDB areas ..... nn,nnn,nnn

Total ..... nn,nnn,nnn

Number of resources failed ..... nn,nnn,nnn

Completion code ..... nn
```

Figure 16. Process Summary report

# Monitor List Registration report

The Monitor List Registration report contains the attributes that were applied to the new and updated database entries, and the names of the databases that were added, updated, and failed. This report is generated in the IAVBRPRT data set.

Tools Base Autonomics Director - V1R7 Monitor List Registration Report Date: 2024-07-29 Page: 2  
5655-V93 Time: 20:00:00

Attributes for full-function database:  
OWNER : ITBUSR  
PRIORITY : 5  
AUTOEVAL : Y  
EVALCNT : 010  
EVALINT : 001:000:00  
SENSOR\_AGE : 001:000:00  
SENSOR\_JCLDSN : IMSTOOLS.ITB17.JCLLIB  
SENSORID\_FFDB : FF  
REORG\_POLICYBY : DBTYPE  
REORG\_POLICYNAME :  
RECOVERY\_POLICYBY : DEFAULT  
RECOVERY\_POLICYNAME :

Note: An asterisk (\*) indicates that the entry was updated. Resources without an asterisk indicate that the entries were added.

Added or updated databases											
*AUTODB	EMPDB2	*CAGDA01	*CAGDA02	CAGDA03	CAGDB01	CAGDB02	CAGDB03	CAGDB04	CAGDB05	CAGDC01	CAGDC02
CAGDC03	CAGDC04	CAGDC05	CAGDF01	CAGDF02	CAGDF03						

Tools Base Autonomics Director - V1R7 Monitor List Registration Report Date: 2024-07-29 Page: 3  
5655-V93 Time: 20:00:00

Attributes for HALDB partitions:  
OWNER : ITBUSR  
PRIORITY : 5  
AUTOEVAL : Y  
EVALCNT : 010  
EVALINT : 001:000:00  
SENSOR\_AGE : 001:000:00  
SENSOR\_JCLDSN : IMSTOOLS.ITB17.JCLLIB  
SENSORID\_HALDB : HALDB  
REORG\_POLICYBY : DBDNAME  
REORG\_POLICYNAME :  
RECOVERY\_POLICYBY : DBDNAME  
RECOVERY\_POLICYNAME :

Note: An asterisk (\*) indicates that the entry was updated. Resources without an asterisk indicate that the entries were added.

DBD name	Added or updated partitions										
HAL1H1	*HAL1H1A	*HAL1H1B									
HAL2H1	H210001	H210002	H210003	H210004	H210005	H210006	H210007	H210008	H210009	H210010	
	H210011	H210012	H210013	H210014	H210015	H210016	H210017	H210018	H210019		

Tools Base Autonomics Director - V1R7 Monitor List Registration Report Date: 2024-07-29 Page: 4  
5655-V93 Time: 20:00:00

Attributes for Fast Path DEDB areas:  
OWNER : ITBUSR  
PRIORITY : 5  
AUTOEVAL : Y  
EVALCNT : 010  
EVALINT : 001:000:00  
SENSOR\_AGE : 001:000:00  
SENSOR\_JCLDSN : IMSTOOLS.ITB17.JCLLIB  
SENSORID\_DEDB : FP  
REORG\_POLICYBY : NAME  
REORG\_POLICYNAME : SYS.DBDBTYPE.DEDB  
RECOVERY\_POLICYBY : NAME  
RECOVERY\_POLICYNAME : SYS.RECOV.\_DEFAULT

Note: An asterisk (\*) indicates that the entry was updated. Resources without an asterisk indicate that the entries were added.

DBD name	Added or updated areas										
DEDBJN22	D22AR11	D22AR31	D22AR51								
DEDBJN23	*D2300000	*D2300001	*D2300002	*D2300003	*D2300004	*D2300005	*D2300006	*D2300007	*D2300008	*D2300009	
	*D2300010	*D2300011	*D2300012	*D2300013	*D2300014	*D2300015	*D2300016	*D2300017	*D2300018	*D2300019	
	*D2300020	*D2300021	*D2300022	*D2300023	*D2300024	*D2300025	*D2300026	*D2300027	*D2300028	*D2300029	
	*D2300030	*D2300031	*D2300032	*D2300033	*D2300034	*D2300035	*D2300036	*D2300037	*D2300038	*D2300039	
	*D2300040	*D2300041	*D2300042	*D2300043	*D2300044	*D2300045	*D2300046	*D2300047	*D2300048	*D2300049	
	*D2300050	*D2300051	*D2300052	*D2300053	*D2300054	*D2300055	*D2300056	*D2300057	*D2300058	*D2300059	
	*D2300060	*D2300061	*D2300062	*D2300063	*D2300064	*D2300065	*D2300066	*D2300067	*D2300068	*D2300069	
	*D2300070	*D2300071	*D2300072	*D2300073	*D2300074	*D2300075	*D2300076	*D2300077	*D2300078	*D2300079	
	*D2300080	*D2300081	*D2300082	*D2300083	*D2300084	*D2300085	*D2300086	*D2300087	*D2300088	*D2300089	
	*D2300090	*D2300091	*D2300092	*D2300093	*D2300094	*D2300095	*D2300096	*D2300097	*D2300098	*D2300099	

Figure 17. Monitor List Registration report

```

Tools Base Autonomics Director - V1R7          Monitor List Registration Report          Page: 5
5655-V93                                     Date: 2024-07-29          Time: 20:00:00

Resources ended with warning status

DBD name   Area/Part   Message (See journal messages for details)
-----
HAL1H1     HAL1H1C     IAV8042W Area/Partition in the monitor list not found in the DBD

Tools Base Autonomics Director - V1R7          Monitor List Registration Report          Page: 6
5655-V93                                     Date: 2024-07-29          Time: 20:00:00

Resources ended with error status

DBD name   Message (See journal messages for details)
-----
DEDBJN20   IAV8043E DBD does not exist
GSAMDB     IAV8044E Database organization type is not supported

```

Figure 18. Monitor List Registration report (cont.)

## Return codes: Monitor List Registration utility

This reference section provides detailed information about the return and reason codes reported by the Monitor List Registration utility.

Table 11. Return codes from the Monitor List Registration utility

Code	Description	User response
0	Job successfully ended.	None.
4	Job ended with a warning message.	Check the messages whose message numbers are suffixed by the letter <i>W</i> . The utility also ends with this return code when it updates existing database entries.
8	Job ended with an error message.	Check the messages whose message numbers are suffixed by the letter <i>E</i> . Correct the error, and rerun the job.
12	Job abnormally ended and recovered by ESTAE routine.	This might be an internal system error. Contact IBM Software Support.
16	Job failed to initialize the BPE environment.	Correct any errors, and rerun the job. If this situation persists, contact IBM Software Support.





# Chapter 13. Reference: BPE commands

Autonomics Director uses the Base Primitive Environment (BPE) and BPE commands.

### Topics:

- “BPE command syntax and invocation” on page 137
- “BPE TRACETABLE commands” on page 139
- “BPE USEREXIT commands” on page 143

## BPE command syntax and invocation

Autonomics Director BPE supports two command formats: a verb only format, and a verb-resource type format.

The verb only format consists of a verb, followed by zero or more keyword-value pairs, with the values enclosed in parentheses.

### BPE verb-only command syntax

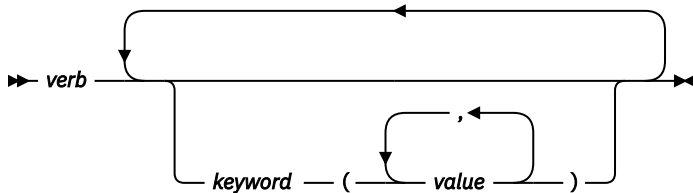

### BPE verb-resource type command syntax

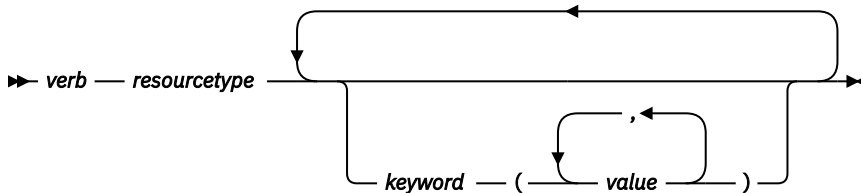

The verb-resource type format consists of a verb, a resource type, and zero or more keyword value pairs.

### *verb*

A command verb that represents an action. Some verb examples are DISPLAY, UPDATE, and REFRESH.

### *resourcetype*

The type of resource that is operated on by the verb. Some resource examples are TRACETABLE and USEREXIT.

### *keyword(value)*

A set of zero or more keywords and values that represent attributes, filters, or other modifiers that apply to the command. For example, NAME() to identify the specific resources or LEVEL() to specify a trace level.

## BPE command invocation

You can invoke Autonomics Director BPE commands only through the MVS **MODIFY** command.

The following diagram illustrates the general syntax for entering commands through the modify interface.

➤ F — *jobname,command* ➤

These elements are defined as follows:

**F**

The MVS **MODIFY** command.

**jobname**

The job name of the address space to which the command is directed.

**command**

The command that is being issued.

## BPE wildcard character support

Some parameters on BPE commands support wildcard characters for pattern matching.

For such parameters, you can use the following wildcard characters:

**\***

Matches zero or more characters

**%**

Matches exactly one character

The following examples illustrate some uses of wildcard characters.

**BE\***

Matches any string that begins with *BE*, of any length. For example: BE, BEE, BEEBLEBROX.

**%%S**

Matches any 3-character string that ends with an *S*. For example: IMS, SMS.

**R\*S\*T%R**

Matches any string that begins and ends with *R*, having an *S*, followed by a *T* in the middle, with any number of intervening characters between the first *R*, the *S*, and the *T*, and exactly one character between the *T* and the final *R*. For example: ROASTER, ROSTER, RESORTER, RESCEPTOR, RSTZR.

**\***

Matches any string.

## Specifying command parameters

Autonomics Director BPE commands enable you to display and update resources that Autonomics Director BPE manages.

### About this task

Some resource types are defined and owned by Autonomics Director BPE itself. These resource types are known as *system resource types*.

Other resource types are defined and owned by Autonomics Director. These resource types are known as *component resource types* or *user-product resource types*.

Autonomics Director BPE commands also provide the ability to restrict the resource types upon which a command operates to either those owned by Autonomics Director BPE, or to those owned by Autonomics Director itself. This is done through the OWNER keyword on commands that support OWNER.

- Use OWNER(BPE) to restrict the command operation to resource types that BPE owns and defines (system resource types).
- Use OWNER(ADAS) to restrict the command operation to resource types that the Autonomics Director server defines and owns (component resource types).

## BPE TRACETABLE commands

The TRACETABLE resource type refers to the internal Autonomics Director BPE-managed trace tables that are defined either by Autonomics Director BPE (for example: DISP, CBS, STG, LATC), or by Autonomics Director.

Two command verbs operate on the TRACETABLE resource type:

### DISPLAY

Display trace level and number of trace table pages of specified trace tables.

### UPDATE

Update trace level attributes of specified trace tables.

## DISPLAY TRACETABLE command

The **DISPLAY TRACETABLE** command displays the current attribute settings for the requested trace tables.

### DISPLAY TRACETABLE command format

Use the **DISPLAY TRACETABLE** command to display the current attribute settings for the requested trace tables.

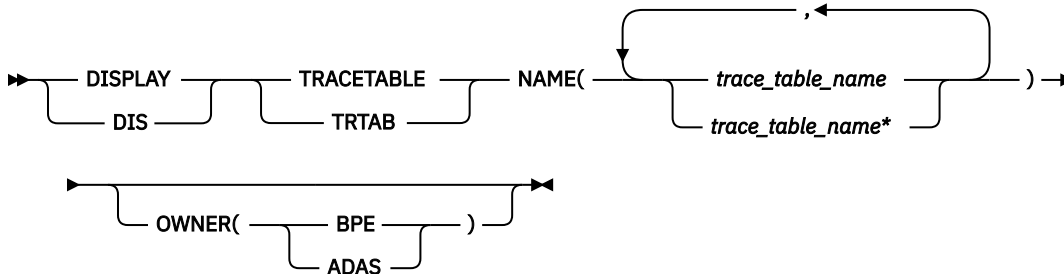

### DISPLAY TRACETABLE command usage rules

Use the **DISPLAY TRACETABLE** command according to its usage rules.

#### DISPLAY | DIS

A required parameter that specifies that the action against the specified resource is to display attributes of the resource.

#### TRACETABLE | TRTAB

A required parameter that specifies that the resource type being acted upon is a BPE-managed trace table.

#### NAME(trace\_table\_name)

A required parameter that specifies the name of the trace table type or types about which you want attributes displayed. You can specify a single trace table name or a list of trace table names separated by commas. Trace table names can contain wildcard characters. Trace table names can be Autonomics Director BPE-defined trace tables or Autonomics Director-defined trace tables.

The following Autonomics Director BPE-defined trace table types are available:

#### AWE

Asynchronous work element (AWE) trace table

#### CBS

Control block services trace table

#### CMD

Command trace table

#### DISP

Dispatcher trace table

**LATC**

Latch trace table

**SSRV**

System services trace table

**STG**

Storage service trace table

**OWNER(BPE | ADAS)**

An optional parameter that specifies the owner of the user exit type or types about which you want attributes displayed. You can specify one of the following values:

**BPE**

For all Autonomics Director components that are running in a BPE address space. No BPE user exit routine types are defined at this time.

**ADAS**

For Autonomics Director server address space-defined trace table types.

The OWNER parameter acts as a filter to help you select the trace tables that you want to display. You could specify NAME (\*) OWNER(BPE) to display all of the Autonomics Director BPE-defined trace table types. If OWNER is omitted, then both Autonomics Director BPE and Autonomics Director component trace tables might be displayed (depending on the tables specified on NAME).

**DISPLAY TRACETABLE command output**

The **DISPLAY TRACETABLE** command output consists of a header line, one line per selected trace table, and one message BPE0032I line that indicates that the command has completed.

The following example shows the output from the **DISPLAY TRACETABLE** command.

```
BPE0030I TABLE OWNER LEVEL #PAGES
BPE0000I DISP BPE HIGH 12
BPE0000I XDCM ADAS HIGH 12
BPE0032I DISPLAY TRACETABLE COMMAND COMPLETED
```

These columns are in the **DISPLAY TRACETABLE** output:

**TABLE**

Specifies the name of the trace table type about which information is being displayed on the current row.

**OWNER**

Specifies the Autonomics Director component that owns the trace table (BPE or ADAS).

**LEVEL**

Specifies the current level setting of the trace table. A trace table's level determines the volume of trace data that is collected. These levels are possible:

**NONE**

No tracing is being done into the table.

**ERROR**

Only traces for error or exception conditions are being made into the table.

**LOW**

Only major event trace entries are made into the table.

**MEDIUM**

Major event trace entries and some minor event trace entries are made into the table.

**HIGH**

All trace entries are made into the table.

**INACTV**

The trace table is inactive and cannot be used. This status occurs only when BPE was unable to get any storage for the trace table. No tracing will be done for the indicated table type, and you

cannot change the level for the trace table with the **UPDATE TRACETABLE** command. You must restart the address space in order to use the trace table again.

### #PAGES

Specifies the number of 4 KB (4096 byte) pages that are allocated for the trace table type.

### DISPLAY TRACETABLE example 1

This example displays the status of the Autonomics Director BPE dispatcher trace table (DISP).

#### Command:

```
F ADAS1,DISPLAY TRACETABLE NAME(DISP)
```

#### Output:

```
BPE0030I TABLE OWNER LEVEL #PAGES
BPE0000I DISP BPE HIGH 4
BPE0032I DIS TRTAB COMMAND COMPLETED
```

### DISPLAY TRACETABLE example 2

This example displays the status of all traces in an Autonomics Director address space.

#### Command:

```
F ADAS1,DIS TRTAB NAME(*)
```

#### Output:

```
BPE0030I TABLE OWNER LEVEL #PAGES
BPE0000I AWE BPE HIGH 2
BPE0000I CBS BPE MEDIUM 4
BPE0000I CMD BPE ERROR 2
BPE0000I DISP BPE HIGH 4
BPE0000I LATC BPE ERROR 4
BPE0000I SSRV BPE HIGH 2
BPE0000I STG BPE MEDIUM 4
BPE0032I DIS TRTAB COMMAND COMPLETED
```

## UPDATE TRACETABLE command

The **UPDATE TRACETABLE** command changes the trace level setting for the requested trace tables.

### UPDATE TRACETABLE command format

Use the **UPDATE TRACETABLE** command to change the trace level setting for the requested trace tables.

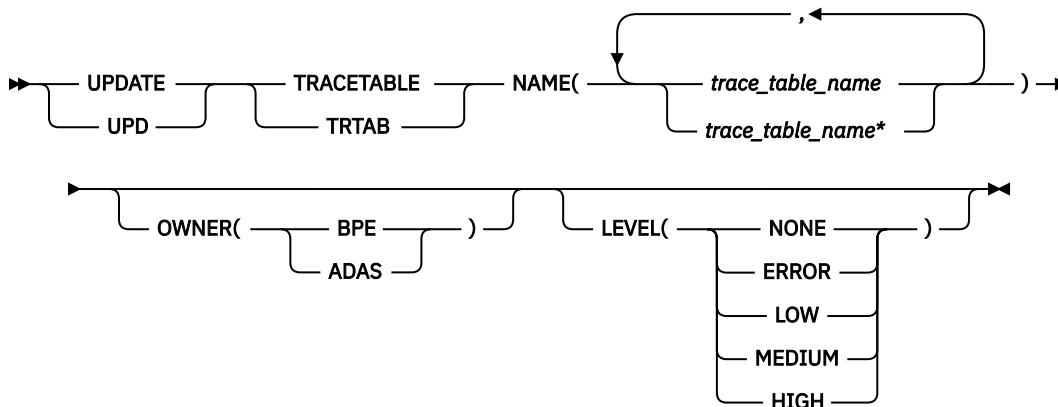

## UPDATE TRACETABLE command usage rules

Use the **UPDATE TRACETABLE** command according to its usage rules.

### **UPDATE | UPD**

A required parameter that specifies that the action against the trace table is to update its attributes.

### **TRACETABLE | TRTAB**

A required parameter that specifies that the resource type being acted upon is an IMS Autonomics Director BPE-managed trace table.

### **NAME(trace\_table\_name)**

A required parameter that specifies the name of the trace table type or types that you want to update. You can specify a single trace table name or a list of trace table names separated by commas. Trace table names can contain wildcard characters. Trace table names can be IMS Autonomics Director BPE-defined trace tables or IMS Autonomics Director-defined trace tables.

The following IMS Autonomics Director BPE-defined trace table types are available:

#### **AWE**

Asynchronous work element (AWE) trace table

#### **CBS**

Control block services trace table

#### **CMD**

Command trace table

#### **DISP**

Dispatcher trace table

#### **LATC**

Latch trace table

#### **SSRV**

System services trace table

#### **STG**

Storage service trace table

You can update IMS Autonomics Director-defined trace tables only for IMS Autonomics Director address spaces.

### **OWNER(BPE|ADAS)**

An optional parameter that specifies the owner of the trace table type or types that you want to update. You can specify one of the following values:

#### **BPE**

For IMS Autonomics Director BPE-defined trace table types

#### **ADAS**

For Autonomics Director server address space-defined trace table types

The OWNER parameter acts as a filter to help you select the trace tables that you want to update. You could specify **NAME (\*) OWNER (ADAS)** to update all of the Autonomics Director Server-defined trace table types. If OWNER is omitted, then both IMS Autonomics Director BPE and IMS Autonomics Director trace tables might be updated (depending on the tables specified on NAME).

### **LEVEL(level)**

An optional parameter that sets the new tracing level for the specified trace tables. If LEVEL is omitted, the level of the specified trace tables is not changed. These levels are possible:

#### **NONE**

No tracing is being done into the table.

#### **ERROR**

Only traces for error or exception conditions are being made into the table.

#### **LOW**

Only major event trace entries are made into the table.

## MEDIUM

Major event trace entries and some minor event trace entries are made into the table.

## HIGH

All trace entries are made into the table.

**Important:** You cannot change the level for the trace table type ERR. IMS Autonomics Director BPE forces the level to HIGH to ensure that error diagnostics are captured. Any level that you specify for the ERR trace table is ignored.

### **UPDATE TRACETABLE command output**

The **UPDATE TRACETABLE** command output consists of message BPE0032I, which indicates that the command has completed.

An example of the **UPDATE TRACETABLE** command output message is:

```
BPE0032I UPDATE TRACETABLE COMMAND COMPLETED
```

### **UPDATE TRACETABLE example 1**

This example updates the level of the Autonomics Director BPE dispatcher trace table (DISP) to HIGH.

#### **Command:**

```
F ADAS1,UPDATE TRACETABLE NAME(DISP) LEVEL(HIGH)
```

#### **Output:**

```
BPE0032I UPDATE TRACETABLE COMMAND COMPLETED
```

### **UPDATE TRACETABLE example 2**

This example updates the level of all Autonomics Director (ADAS) trace tables to MEDIUM.

**Important:** You cannot change the level for the trace table type ERR, even when using a wildcard character to select all tables with a given owner, as in this example. Autonomics Director BPE forces the level to HIGH to ensure that error diagnostics are captured.

#### **Command:**

```
F ADAS1,UPD TRTAB NAME(*) OWNER(ADAS) LEVEL(MEDIUM)
```

#### **Output:**

```
BPE0032I UPDATE TRACETABLE COMMAND COMPLETED
```

## **BPE USEREXIT commands**

---

BPE-specific user exit routines are not supported. Only Autonomics Director-specific user exit routines are available.

Throughout these topics, the term *user exit routine* means user-supplied exit routine.

The USEREXIT resource type refers to the user exit routine types that are defined to and managed by the IMS component that is using BPE (for example, ADAS).

### **DISPLAY**

Display attributes of specified user exit routine types.

### **REFRESH**

Load new copies of the user exit modules for specified user exit routine types.

## DISPLAY USEREXIT command

Use the **DISPLAY USEREXIT** command to display attributes for all modules that are associated with the specified user exit routine types.

### DISPLAY USEREXIT command format

Use the **DISPLAY USEREXIT** command by following its syntax format.

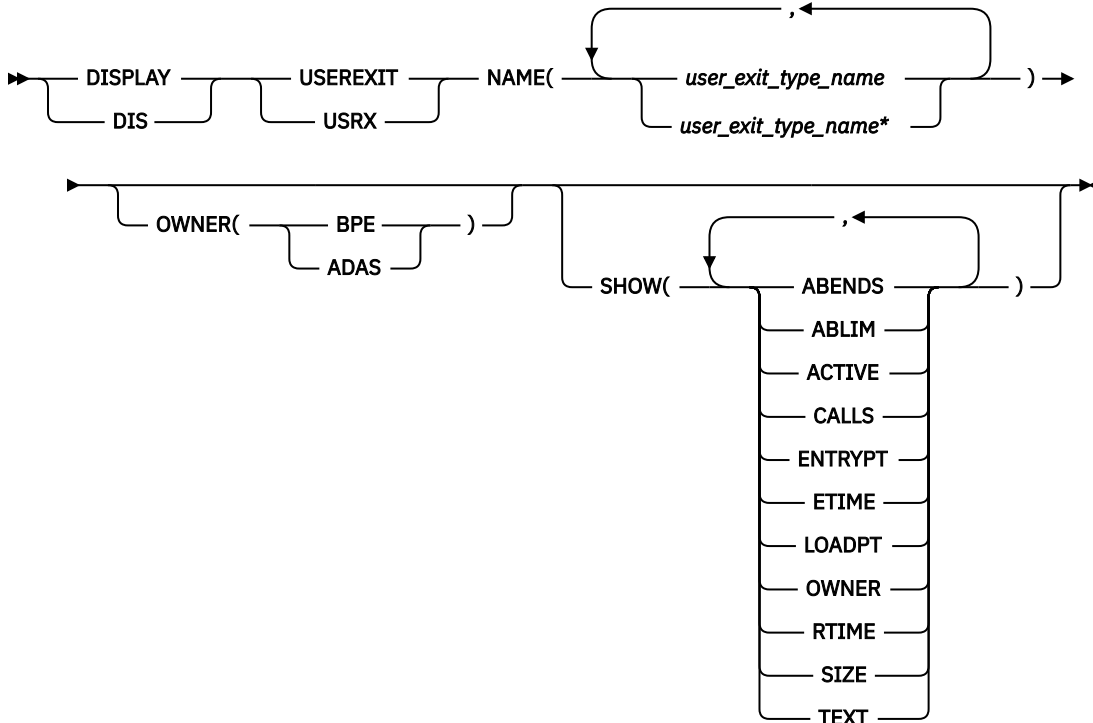

### DISPLAY USEREXIT command usage rules

Use the **DISPLAY USEREXIT** command according to its usage rules.

#### DISPLAY | DIS

A required parameter that specifies that the action against the specified resource(s) is to display attributes of the resources.

#### USEREXIT | USRX

A required parameter that specifies that the resource type being acted upon is a BPE-managed user exit routine type.

#### NAME(*user\_exit\_type\_name*)

A required parameter that specifies the name of the user exit type or types about which you want attributes displayed. You can specify a single user exit type name or a list of user exit type names separated by commas. User exit routine type names can contain wildcard characters.

**Important:** The names that are specified in this parameter are the names of user exit routine types, not the names of individual user exit routine modules.

User exit routine types are defined in the Autonomics Director server address space, as specified by **OWNER(ADAS)**, and include the following types:

#### EXCEPTNS

User exceptions exit routine

#### SECURITY

User security exit routine



## **OWNER(BPE|ADAS)**

An optional parameter that specifies the owner of the user exit routine type or types about which you want attributes displayed. You can specify one of the following values:

### **BPE**

For all IMS components that are running in a BPE address space. No BPE user exit routine types are defined at this time.

### **ADAS**

For Autonomics Director server address space only.

The OWNER parameter acts as a filter to help you select the user exit types that you want to display. For example, you could specify NAME (\*) OWNER (ADAS) to display all of the Autonomics Director server-defined exit routines in the Autonomics Director server address space. If OWNER is omitted, then both BPE and component user exits can be displayed (depending on the exits specified on NAME).

## **SHOW(attribute)**

An optional parameter that specifies the attributes that you want to display about the requested user exits.

When you display information about user exits, each row of display output contains the requested attributes for one user exit module, in columns. Every display for user exits contains the columns labeled EXITTYPE (the type of the exit), and MODULE (the load module name of the exit). Additionally, any of the following attributes can be requested by using the SHOW parameter:

### **ABENDS**

The number of abends that have occurred in the user exit module since the last user exit refresh of that module (or since address space initialization if no refreshes have been done). BPE keeps track of the number of abends that have occurred in each user exit module. When this number reaches the number that is defined on the ABLIM= parameter of the EXITDEF statement for the exit's type, BPE stops calling the module. If the user exit module is refreshed, this count is reset to zero, and BPE calls the module again.

If the abend limit (ABLIM) value is not zero, and if the number of abends is greater than or equal to the abend limit value, then the user exit has reached its abend limit, and is no longer being called by BPE.

The maximum value that can be displayed in this field is 2147483647 ( $2^{31}-1$ ). If the abend count exceeds this value, 2147483647 is displayed.

### **ABLIM**

The abend limit count for the user exit type, as specified on the ABLIM= parameter on the EXITDEF statement for the user exit type in the BPE exit list PROCLIB member. This is the number of times the user exit module is allowed to abend before BPE stops calling the user exit. A value of 0 indicates that there is no abend limit.

The maximum value that can be displayed in this field is 2147483647 ( $2^{31}-1$ ). If the abend limit count exceeds this value, 2147483647 is displayed.

### **ACTIVE**

The number of currently active instances of the user exit routine. This is a point-in-time number that represents the number of calls to the user exit routine that have not yet returned.

The maximum value that can be displayed in this field is 999999. If the active count exceeds this value, 999999 is displayed.

### **CALLS**

The number of calls to the user exit routine since the last user exit routine refresh.

For performance reasons, serialization is not obtained when BPE collects this number. For an exit type that can run multiple instances in parallel, this number should be considered an approximation only.

The maximum value that can be displayed in this field is 2147483647 ( $2^{31}-1$ ). If the call count exceeds this value, 2147483647 is displayed.

**ENTRYPT**

The entry point address of the user exit module.

**ETIME**

The total (cumulative) elapsed time that was spent in the exit module since it was last refreshed, in milliseconds.

For performance reasons, serialization is not obtained when BPE collects this number. For an exit routine type that can run multiple instances in parallel, this number should be considered an approximation only.

The maximum value that can be displayed in this field is 2147483647 ( $2^{31}-1$ ). If the elapsed number of milliseconds exceeds this value, 2147483647 is displayed.

**LOADPT**

The load point address of the user exit module.

**OWNER**

The IMS component that owns the user exit routine type. BPE-owned user exit routine types are system exit routine types, and exist in all IMS component address spaces that use BPE. User exit routine types that are specific to the component show the 1- to 4-character component identifier in this column (for example, ADAS).

**RTIME**

The refresh time of the user exit module. This is the local date and time that the user exit module was last refreshed (or initially loaded, if no refreshes have been done). The format of this output field is:

```
yyyy-mm-dd hh:mm:ss.th
```

**SIZE**

The size of the user exit load module, in bytes (displayed in hexadecimal).

**TEXT**

27 bytes starting from offset +04 from the module's entry point, translated to EBCDIC, with non-printable characters replaced by periods ( . ). This is a common location for module identification information. If your user exits contain printable identification data at this point in the module, the TEXT option enables that information to be displayed.

If the SHOW parameter is not specified, the default attributes that are displayed after the EXITTYPE and MODULE are: OWNER, ACTIVE, and ABENDS.

The order in which you list the attributes on the SHOW parameter has no effect on the order the attributes are displayed. BPE determines the order of the attribute columns in the display output. This order is as follows:

- OWNER
- ACTIVE
- ABENDS
- ABLIM
- CALLS
- ETIME
- RTIME
- ENTRYPT
- LOADPT
- SIZE
- TEXT

**Important:** It is possible to request so many attributes that the length of the output line is too long to display with a WTO. If this occurs, the command is processed, but some lines might be truncated. The maximum line length that BPE displays is 126 characters.

### ***DISPLAY USEREXIT command output***

The **DISPLAY USEREXIT** command output consists of a header line, one line per user exit module about which information is being displayed, and one message BPE0032I line that indicates that the command has completed.

For example, the command:

```
F ADAS1,DISPLAY USEREXIT NAME(EXCEPTNS)
```

returns the following output:

```
BPE0030I EXITTYPE MODULE OWNER ACTIVE ABENDS
BPE0000I EXCEPTNS IAVUEXXT ADAS 0 0
BPE0032I DISPLAY USEREXIT COMMAND COMPLETED
```

The EXITTYPE and MODULE columns are present for all **DISPLAY USEREXIT** commands, regardless of what is specified on SHOW. When multiple exit modules are listed for a single user exit routine type, the order in which they are listed is the order in which they are called.

### ***DISPLAY USEREXIT command example 1***

This example displays the number of calls to, the elapsed time spent in, and the abend limit for all ADAS user exit routine types.

#### **Command:**

```
F ADAS1,DIS USRX NAME(*) OWNER(ADAS) SHOW(CALLS,ETIME,ABLIM)
```

#### **Output:**

```
12.33.24 JOB00176 BPE0030I EXITTYPE MODULE          ABLIM      CALLS      ETIME
12.33.24 JOB00176 BPE0000I EXCEPTNS IAVUEXXT      1           79       232
12.33.24 JOB00176 BPE0032I DIS USRX  COMMAND COMPLETED
```

### ***DISPLAY USEREXIT command example 2***

This example displays the entry point, load point, and size of all of the ADAS EXCEPTNS user exit routine modules.

#### **Command:**

```
F ADAS1,DIS USRX NAME(EXCEPTNS) SHOW(SIZE,ENTRYPT,LOADPT)
```

#### **Output:**

```
BPE0030I EXITTYPE MODULE  ENTRYPT  LOADPT  SIZE
BPE0000I EXCEPTNS IAVUEXXT 91105040 11105040 00000410
BPE0032I DIS USRX  COMMAND COMPLETED
```

### ***DISPLAY USEREXIT command example 3***

This example displays the first part of the module text for all of the ADAS EXCEPTNS user exit modules.

#### **Command:**

```
F ADAS1,DIS USRX NAME(EXCEPTNS) SHOW(TEXT)
```

**Output:**

```
BPE0030I EXITTYPE MODULE TEXT
BPE0000I EXCEPTNS IAVUEXXT .IAVUEXXT+V110+06/28/24+09.
BPE0032I DIS USRX COMMAND COMPLETED
```

**DISPLAY USEREXIT command example 4**

This example displays the refresh time for all of the ADAS EXCEPTNS user exit modules.

**Command:**

```
F ADAS1,DIS USRX NAME(EXCEPTNS) SHOW(RTIME)
```

**Output:**

```
BPE0030I EXITTYPE MODULE RTIME
BPE0000I EXCEPTNS IAVUEXXT 2024-06-29 06:56:49.30
BPE0032I DIS USRX COMMAND COMPLETED
```

**REFRESH USEREXIT command**

The **REFRESH USEREXIT** command requests that BPE reprocess the user exit routine PROCLIB members that are specified in the BPE configuration PROCLIB member, and reloads the user exit routine modules that are currently listed in the user exit PROCLIB members for the types that are specified on the command.

By using this command, you can make updates to your user exit routines without stopping and restarting the address space.

When you enter the command, BPE performs the following processing:

- Reads any user exit PROCLIB members that are specified on EXITMBR= statements in the BPE configuration PROCLIB member. Because BPE re-reads these members at the time you issue the command, you can edit the user exit PROCLIB members before issuing the **REFRESH** command and make changes to the user exit definitions. BPE does not re-read the main BPE configuration PROCLIB member, so you cannot change the names of the user exit routine PROCLIB members; you can change only their contents.
- Loads the user exit routine modules that are specified on the EXITDEF= statements for the user exit routine types that are specified on the command.
- Quiesces all current user exit routines. The command waits for any active exit routines to complete processing, and delays any new calls to the current exit routines. This ensures that no user exit routine is running while the exit routine is being refreshed.
- Replaces pointers to the previous user exit modules with pointers to the newly loaded modules in internal BPE control blocks, which are used to manage the calling of the exit routines.
- Resumes the user exit routines and allows calls to be made to the newly loaded exit routines.
- Deletes the old copy of the user exit routines.

BPE loads the new copies of the user exit modules before deleting the old modules. If an error occurs during this process (for example, a module could not be loaded or BPE internal control block storage could not be obtained), BPE will fail the command and leave the old copies of the user exits in effect. All modules of the specified user exit routine types must be loaded successfully for the command to complete successfully.

When a user exit module is refreshed, its abend count is reset to zero. In this case, a user exit module that had reached its abend limit (as specified by the ABLIM parameter on the EXITDEF statement) was no longer being called by BPE.

**Important:** If you changed the ABLIM parameter for a user exit routine in the PROCLIB member, the new value of ABLIM takes effect after the **REFRESH** command.

## Considerations for refreshing user exit routines

When you are refreshing user exit routines, be aware of the following considerations.

- When you refresh a user exit routine type, BPE reloads all exit routine modules that are defined for that type.

The new copies of the modules will be at a different virtual address than the old copies.

If your modules are re-entrant, no problems should occur.

However, if your modules are not re-entrant and they store data within themselves, they must be able to tolerate being reloaded and losing the information that was previously stored within them.

**Recommendation:** Code and link-edit all user exit routine modules as re-entrant.

- If you refresh a user exit routine module that had previously been loaded, BPE continues to pass the same static work area that the previous copy of the module had been using.

If the new version of the module has a different mapping or use of this area than the previous version, the new version must contain toleration code that can handle the old-style formatted data within this static work area.

**Recommendation:** Place a version number in the static work area so that your exit routines are able to determine when they are using a back-level data structure within this work area.

- If you remove a user exit routine module from an EXITDEF list and refresh the exit routines, BPE deletes the static work area that is associated with that exit routine module.

If you later add the module back to the EXITDEF list and refresh the exit routines, the module gets a new (cleared) static work area, not the work area it had previously.

- If your user exit routines are being managed by LLA by using VLF (or an equivalent product), you must ensure that the copies of the modules that are being refreshed are updated in LLA before issuing the **REFRESH USEREXIT** command.

See the *z/OS MVS Initialization and Tuning Reference* for information about LLA-managed libraries.

- If you have user exit routines that issue MVS WAITs for long periods of time (for example, a WAIT for an external event that might be delayed, such as a WTOR), issuing a **REFRESH USEREXIT** command can cause a performance problem or work stoppage.

This problem results because BPE must quiesce the user exit routines to process the **REFRESH** command. BPE must wait until all of the currently called user exit routines complete before it can perform the user exit routine refresh.

BPE prevents any new calls to user exit routines until after the command completes.

If a user exit routine has been called and does not return to BPE for a long period of time, the **REFRESH** command is delayed until the exit routine returns.

No other user exit routines can be called while BPE is waiting, so the processes that are invoking the user exit routines are also put into a wait.

**Recommendation:** Ensure that your user exit routines avoid long WAITs, and avoid issuing services that might WAIT.

## REFRESH USEREXIT command format

Use the **REFRESH USEREXIT** command by following its syntax format.

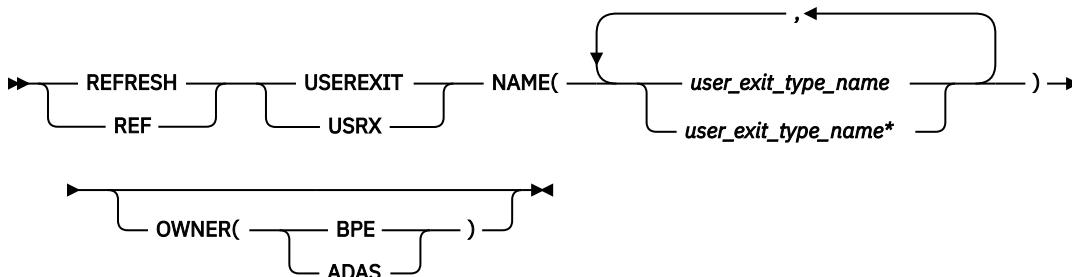

## REFRESH USEREXIT command usage rules

Use the **REFRESH USEREXIT** command according to its usage rules.

### REFRESH | REF

A required parameter that specifies that the action against the specified resources is to refresh the resources.

### USEREXIT | USRX

A required parameter that specifies that the resource type that is being acted upon is a BPE-managed user exit routine type.

### NAME(*user\_exit\_type\_name*)

A required parameter that specifies the name of the user exit type or types that you want to refresh. You can specify a single user exit type name or a list of user exit type names separated by commas. User exit routine type names can contain wildcard characters.

**Important:** The names that are specified in this parameter are the names of user exit routine types, not the names of individual user exit routine modules.

User exit routine types are defined in the Autonomics Director server address space, as specified by **OWNER(ADAS)**, and include the following types:

#### EXCEPTNS

User exceptions exit routine

#### SECURITY

User security exit routine

### OWNER(BPE|ADAS)

An optional parameter that specifies the owner of the user exit routine type or types that you want to refresh. You can specify one of the following values:

#### BPE

For all IMS components that are running in a BPE address space. No BPE user exit routine types are defined at this time.

#### ADAS

For Autonomics Director server address space.

The **OWNER** parameter acts as a filter to help you select the user exit types that you want to refresh. For example, you can specify **NAME(\*) OWNER(ADAS)** to refresh all of the Autonomics Director server-defined user exit routine types in the Autonomics Director server address space. If **OWNER** is omitted, both BPE and component user exit routines can be refreshed (depending on the exits specified on **NAME**).

## REFRESH USEREXIT command output

The **REFRESH USEREXIT** command output consists of message BPE0032I that indicates that the command has completed.

An example of the **REFRESH USEREXIT** command output message is:

```
BPE0032I REFRESH USEREXIT COMMAND COMPLETED
```

### ***REFRESH USEREXIT command example 1***

This example refreshes all user exit routine modules.

#### **Command:**

```
F ADAS1,REFRESH USEREXIT NAME(*)
```

#### **Output:**

```
BPE0032I REFRESH USEREXIT COMMAND COMPLETED
```

### ***REFRESH USEREXIT command example 2***

This example refreshes the Autonomics Director server user exceptions exit routine.

#### **Command:**

```
F ADAS1,REF USRX NAME(EXCEPTNS)
```

#### **Output:**

```
BPE0032I REFRESH USEREXIT COMMAND COMPLETED
```





# Chapter 14. Reference: How to read syntax diagrams

The following rules apply to the syntax diagrams that are used in this information:

- Read the syntax diagrams from left to right, from top to bottom, following the path of the line. The following conventions are used:
  - The >>--- symbol indicates the beginning of a syntax diagram.
  - The ---> symbol indicates that the syntax diagram is continued on the next line.
  - The >--- symbol indicates that a syntax diagram is continued from the previous line.
  - The --->< symbol indicates the end of a syntax diagram.
- Required items appear on the horizontal line (the main path).



- Optional items appear below the main path.

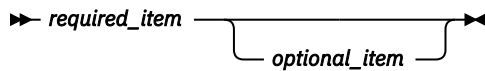

If an optional item appears above the main path, that item has no effect on the execution of the syntax element and is used only for readability.

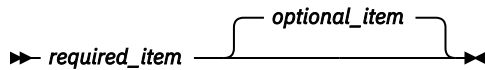

- If you can choose from two or more items, they appear vertically, in a stack.

If you *must* choose one of the items, one item of the stack appears on the main path.

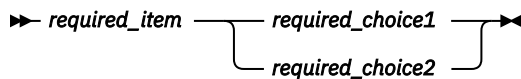

If choosing one of the items is optional, the entire stack appears below the main path.

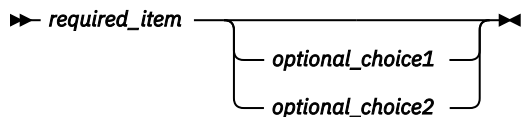

If one of the items is the default, it appears above the main path, and the remaining choices are shown below.

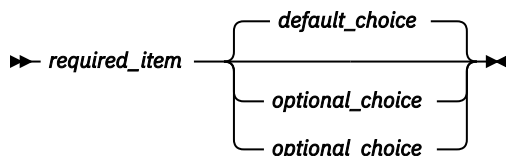

- An arrow returning to the left, above the main line, indicates an item that can be repeated.

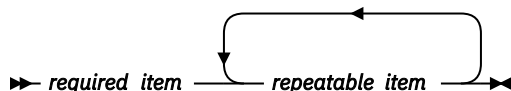

If the repeat arrow contains a comma, you must separate repeated items with a comma.

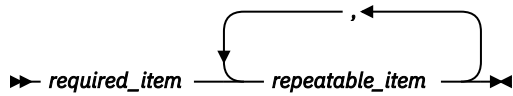

A repeat arrow above a stack indicates that you can repeat the items in the stack.

- Sometimes a diagram must be split into fragments. The syntax fragment is shown separately from the main syntax diagram, but the contents of the fragment should be read as if they are on the main path of the diagram.

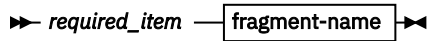

**fragment-name**

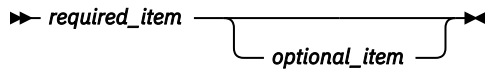

- A b symbol indicates one blank position.
- Keywords, and their minimum abbreviations if applicable, appear in uppercase. They must be spelled exactly as shown. Variables appear in all lowercase italic letters (for example, *column-name*). They represent user-supplied names or values.
- Separate keywords and parameters by at least one space if no intervening punctuation is shown in the diagram.
- Enter punctuation marks, parentheses, arithmetic operators, and other symbols exactly as shown in the diagram.
- Footnotes are shown by a number in parentheses; for example, (1).

## Notices

---

This information was developed for products and services offered in the U.S.A.

This material may be available from IBM in other languages. However, you may be required to own a copy of the product or product version in that language in order to access it.

IBM may not offer the products, services, or features discussed in this document in other countries. Consult your local IBM representative for information on the products and services currently available in your area. Any reference to an IBM product, program, or service is not intended to state or imply that only that IBM product, program, or service may be used. Any functionally equivalent product, program, or service that does not infringe any IBM intellectual property right may be used instead. However, it is the user's responsibility to evaluate and verify the operation of any non-IBM product, program, or service.

IBM may have patents or pending patent applications covering subject matter described in this document. The furnishing of this document does not give you any license to these patents. You can send license inquiries, in writing, to:

IBM Director of Licensing  
IBM Corporation  
North Castle Drive  
Armonk, NY 10504-1785  
U.S.A.

For license inquiries regarding double-byte (DBCS) information, contact the IBM Intellectual Property Department in your country or send inquiries, in writing, to:

Intellectual Property Licensing  
Legal and Intellectual Property Law  
IBM Japan Ltd.  
19-21, Nihonbashi-Hakozakicho, Chuo-ku  
Tokyo 103-8510, Japan

**The following paragraph does not apply to the United Kingdom or any other country where such provisions are inconsistent with local law:** INTERNATIONAL BUSINESS MACHINES CORPORATION PROVIDES THIS PUBLICATION "AS IS" WITHOUT WARRANTY OF ANY KIND, EITHER EXPRESS OR IMPLIED, INCLUDING, BUT NOT LIMITED TO, THE IMPLIED WARRANTIES OF NON-INFRINGEMENT, MERCHANTABILITY OR FITNESS FOR A PARTICULAR PURPOSE. Some states do not allow disclaimer of express or implied warranties in certain transactions, therefore, this statement may not apply to you.

This information could include technical inaccuracies or typographical errors. Changes are periodically made to the information herein; these changes will be incorporated in new editions of the publication. IBM may make improvements and/or changes in the product(s) and/or the program(s) described in this publication at any time without notice.

Any references in this information to non-IBM Web sites are provided for convenience only and do not in any manner serve as an endorsement of those Web sites. The materials at those Web sites are not part of the materials for this IBM product and use of those Web sites is at your own risk.

IBM may use or distribute any of the information you supply in any way it believes appropriate without incurring any obligation to you.

Licensees of this program who wish to have information about it for the purpose of enabling: (i) the exchange of information between independently created programs and other programs (including this one) and (ii) the mutual use of the information which has been exchanged, should contact:

IBM Director of Licensing  
IBM Corporation  
North Castle Drive

Armonk, NY 10504-1785  
U.S.A.

Such information may be available, subject to appropriate terms and conditions, including in some cases, payment of a fee.

The licensed program described in this information and all licensed material available for it are provided by IBM under terms of the IBM Customer Agreement, IBM International Program License Agreement, or any equivalent agreement between us.

This information contains examples of data and reports used in daily business operations. To illustrate them as completely as possible, the examples include the names of individuals, companies, brands, and products. All of these names are fictitious and any similarity to the names and addresses used by an actual business enterprise is entirely coincidental.

#### COPYRIGHT LICENSE:

This information contains sample application programs in source language, which illustrate programming techniques on various operating platforms. You may copy, modify, and distribute these sample programs in any form without payment to IBM, for the purposes of developing, using, marketing or distributing application programs conforming to the application programming interface for the operating platform for which the sample programs are written. These examples have not been thoroughly tested under all conditions. IBM, therefore, cannot guarantee or imply reliability, serviceability, or function of these programs. The sample programs are provided "AS IS", without warranty of any kind. IBM shall not be liable for any damages arising out of your use of the sample programs.

## Trademarks

IBM, the IBM logo, and [ibm.com](http://www.ibm.com)<sup>®</sup> are trademarks or registered trademarks of International Business Machines Corp., registered in many jurisdictions worldwide. Other product and service names might be trademarks of IBM or other companies. A current list of IBM trademarks is available on the web at "Copyright and trademark information" at <http://www.ibm.com/legal/copytrade.shtml>.

Other company, product, and service names may be trademarks or service marks of others.

## Terms and conditions for product documentation

Permissions for the use of these publications are granted subject to the following terms and conditions:

**Applicability:** These terms and conditions are in addition to any terms of use for the IBM website.

**Personal use:** You may reproduce these publications for your personal, noncommercial use provided that all proprietary notices are preserved. You may not distribute, display or make derivative work of these publications, or any portion thereof, without the express consent of IBM.

**Commercial use:** You may reproduce, distribute and display these publications solely within your enterprise provided that all proprietary notices are preserved. You may not make derivative works of these publications, or reproduce, distribute or display these publications or any portion thereof outside your enterprise, without the express consent of IBM.

**Rights:** Except as expressly granted in this permission, no other permissions, licenses or rights are granted, either express or implied, to the publications or any information, data, software or other intellectual property contained therein.

IBM reserves the right to withdraw the permissions granted herein whenever, in its discretion, the use of the publications is detrimental to its interest or, as determined by IBM, the above instructions are not being properly followed.

You may not download, export or re-export this information except in full compliance with all applicable laws and regulations, including all United States export laws and regulations.

IBM MAKES NO GUARANTEE ABOUT THE CONTENT OF THESE PUBLICATIONS. THE PUBLICATIONS ARE PROVIDED "AS-IS" AND WITHOUT WARRANTY OF ANY KIND, EITHER EXPRESSED OR IMPLIED,

INCLUDING BUT NOT LIMITED TO IMPLIED WARRANTIES OF MERCHANTABILITY, NON-INFRINGEMENT, AND FITNESS FOR A PARTICULAR PURPOSE.

## **Privacy policy considerations**

IBM Software products, including software as a service solutions, ("Software Offerings") may use cookies or other technologies to collect product usage information, to help improve the end user experience, to tailor interactions with the end user or for other purposes. In many cases no personally identifiable information is collected by the Software Offerings. Some of our Software Offerings can help enable you to collect personally identifiable information. If this Software Offering uses cookies to collect personally identifiable information, specific information about this offering's use of cookies is set forth below.

This Software Offering does not use cookies or other technologies to collect personally identifiable information.

If the configurations deployed for this Software Offering provide you as customer the ability to collect personally identifiable information from end users via cookies and other technologies, you should seek your own legal advice about any laws applicable to such data collection, including any requirements for notice and consent.

For more information about the use of various technologies, including cookies, for these purposes, see IBM's Privacy Policy at <http://www.ibm.com/privacy> and the section titled "Cookies, Web Beacons, and Other Technologies" in IBM's Online Privacy Statement at <http://www.ibm.com/privacy/details>. Also, see the "IBM Software Products and Software-as-a-Service Privacy Statement" at <http://www.ibm.com/software/info/product-privacy>.



---

# Index

## A

- abend codes [103](#)
- accessibility
  - overview [8](#)
- active autonomics [14](#)
- architecture [6](#)
- automating
  - maintenance tasks [68](#)
  - monitoring tasks [68](#)
- autonomics
  - active [14](#)
  - automatic mode [16](#)
  - CAGRP discovery [17](#)
  - database discovery [17](#)
  - database grouping [20](#)
  - environments [3](#)
  - job scheduling structure [23](#)
  - job submission and started tasks [16](#)
  - modes [15](#)
  - on-demand mode [15](#)
  - overview [13](#)
  - passive [13](#)
  - policy evaluation [20](#)
  - process [13](#)
  - sensor data collection [17](#)
  - services [3](#)
  - sweep and cycle intervals [24](#)

## B

- batch interface
  - reference [70](#)
- BPE
  - command invocation [137](#)
  - command parameters [138](#)
  - command syntax and invocation [137](#)
  - TRACETABLE commands [139](#)
  - USEREXIT commands [143](#)
  - wildcard character support [138](#)
- BPE DISPLAY TRACETABLE
  - command output [140](#)
  - example 1 [141](#)
  - example 2 [141](#)
  - format [139](#)
  - usage rules [139](#)
- BPE DISPLAY USEREXIT
  - command output [147](#)
  - example 1 [147](#)
  - example 2 [147](#)
  - example 3 [147](#)
  - example 4 [148](#)
  - format [144](#)
  - usage rules [144](#)
- BPE reference [137](#)
- BPE REFRESH USEREXIT
  - command output [150](#)

- BPE REFRESH USEREXIT (*continued*)

- considerations [149](#)
- example 1 [151](#)
- example 2 [151](#)
- format [150](#)
- usage rules [150](#)

- BPE TRACETABLE [139](#)
- BPE UPDATE TRACETABLE
  - command output [143](#)
  - example 1 [143](#)
  - example 2 [143](#)
  - format [141](#)
  - usage rules [142](#)
- BPE USEREXIT [143](#)
- business scenarios [109](#)

## C

- CAGRP [21](#)
- CAGRP collection [21](#)
- change accumulation groups (CAGRP) [21](#)
- client dialog
  - setup [30](#)
  - start [29](#)
  - system settings [31](#)
  - updating [31](#)
- collection [21](#)
- components
  - batch interface [12](#)
  - monitor list [11](#)
  - scheduler [11](#)
  - server [9](#)
  - user interface [12](#)
- configuration
  - resources [27](#)
- cookie policy [155](#)
- cycle interval [24](#)

## D

- database grouping
  - area extensions [20](#)
  - CAGRP [21](#)
  - collection [21](#)
  - group-managed reorganizations [20](#)
- diagnostic information
  - gathering diagnostic information [107](#)
- dialog [29](#)
- discovery
  - CAGRP discovery [17](#)
  - database discovery [17](#)
- documentation
  - accessing [7](#)
  - sending feedback [7](#)

## E

error messages  
    database evaluation [102](#)  
    runtime [77](#)  
evaluations  
    view history [69](#)

## F

frequently asked questions [106](#)

## G

group-managed reorganizations [20](#)

## H

hardware prerequisites [27](#)

## I

IAVBUTLO [123](#)  
IAVBUTLO JCL [124](#)  
IAVXNTFY [115](#)  
IAVXSCAN [115](#)  
IAVXTRCO [116](#)  
IBM Unified Management Server for z/OS [111](#)  
IMS Administration Foundation features [111](#)  
IMS Administration Foundation for z/OS [13](#), [17](#)  
IMS Tools Base  
    components [3](#)  
installation  
    hardware and software prerequisites [27](#)  
    process [27](#)  
    verification [27](#)  
ISPF  
    setup [30](#)  
    start [29](#)  
    system settings [31](#)  
    updating [31](#)

## J

job scheduling [23](#)

## L

legal notices  
    cookie policy [155](#)  
    notices [155](#)  
    product documentation [155](#)  
    trademarks [155](#)

## M

management  
    monitor list [57](#)  
    scheduler [43](#)  
    server [33](#)  
messages  
    database evaluation [102](#)

messages (*continued*)  
    runtime [77](#)  
monitor list [11](#)  
monitor list management  
    add and update [57](#)  
    delete entries [58](#)  
    ownership change [59](#)  
Monitor List Registration utility  
    ATTRIBUTE command [126](#)  
    control statements [125](#)  
    DATABASE command [132](#)  
    example JCL [124](#)  
    EXEC and DD statements [124](#)  
    GLOBAL command [125](#)  
    Journal Messages report [133](#)  
    Monitor List Registration report [134](#)  
    Process Summary report [133](#)  
    reports [133](#)  
    return codes [135](#)  
    running [123](#)

## N

notices [155](#)

## O

overview [1](#)

## P

passive autonomics [13](#)  
policy evaluation [20](#)  
problems  
    gathering diagnostic information [107](#)  
process flow [6](#)  
product documentation terms and conditions [155](#)

## R

reader comment form [7](#)  
reason codes  
    sensor data extractor [105](#)  
recommendations  
    view [69](#)  
return codes  
    sensor data extractor [105](#)

## S

scenarios  
    CAGRP autonomics [112](#)  
    monitoring list [110](#)  
    scheduling calendar [109](#)  
    viewing exceptions [111](#)  
scheduler [11](#)  
scheduler management  
    base period definitions [48](#)  
    base period overrides [45](#)  
    define base period [44](#)  
    resume [53](#)  
    resume (command) [54](#)  
    resume (ISPF) [53](#)



- scheduler management (*continued*)
  - suspend [51](#)
  - suspend (command) [52](#)
  - suspend (ISPF) [52](#)
  - terminology [43](#)
  - viewing calendar [49](#)
- scheduling
  - activate/deactivate groups [65](#)
  - add databases to user group [63](#)
  - area extension [61](#)
  - canceling [66](#)
  - continuing [66](#)
  - create user group [61](#)
  - delete user group [63](#)
  - modify group attributes [64](#)
  - on-demand area extensions [66](#)
  - on-demand policy evaluations [67](#)
  - on-demand reorganizations [66](#)
  - on-demand sensor data collection [67](#)
  - pausing [66](#)
  - reorganization [61](#)
  - viewing area extension history [67](#)
  - viewing reorganization history [67](#)
- screen readers and magnifiers [8](#)
- sensor data collection [17](#)
- server management
  - display server resources [35](#)
  - display server resources (command) [36](#)
  - display server resources (ISPF) [36](#)
  - refresh server resources [39](#)
  - refresh server resources (command) [39](#)
  - refresh server resources (ISPF) [39](#)
  - stopping [33](#)
  - stopping (commands) [33](#)
  - stopping (ISPF) [33](#)
- servers
  - active and failover [9](#)
  - master [9](#)
- service information [7](#)
- software prerequisites [27](#)
- summary of changes [1](#)
- support
  - gathering diagnostic information [107](#)
- support information [7](#)
- sweep interval [24](#)
- syntax diagrams
  - how to read [153](#)

## T

- technotes [7](#)
- trademarks [155](#)
- troubleshooting [77](#)

## U

- usage scenarios [109](#)
- utilities
  - Monitor List Registration utility [123](#)
  - Policy Services exception reporting (IAVXTRCO) [116](#)
  - pre-scan utility (IAVXSCAN) [115](#)







Product Number: 5655-V93

SC27-9853-05

