

IBM IMS Database Solution Pack for z/OS
2.2

*IMS Online Reorganization Facility User's
Guide*



Note:

Before using this information and the product it supports, read the information in [“Notices” on page 191.](#)

14th Edition (September 2024)

This edition applies to Version 2.2 of IBM IMS Database Solution Pack for z/OS IMS Online Reorganization Facility (program number 5655-DSP) and to all subsequent releases and modifications until otherwise indicated in new editions.

This edition replaces SC27-9039-12.

© **Copyright International Business Machines Corporation 1996, 2024.**

US Government Users Restricted Rights – Use, duplication or disclosure restricted by GSA ADP Schedule Contract with IBM Corp.

Contents

About this information.....	V
Chapter 1. IMS Online Reorganization Facility overview.....	1
IMS Online Reorganization Facility terminology.....	2
What's new in IMS Online Reorganization Facility.....	4
What does IMS Online Reorganization Facility do?.....	10
IMS Online Reorganization Facility features and benefits.....	11
BMP pause feature.....	12
CICS and ODBA applications pause feature.....	14
DBD change feature.....	14
Overview of the online reorganization process.....	17
Overview of the conditional reorganization process.....	21
Overview of the batch image copy creation process.....	23
Considerations for database data sets (DBDS) organization conversion and DDEFPS2 DD process...	25
IMS Online Reorganization Facility restrictions.....	27
Considerations for the IMS management of ACBs.....	29
Considerations for external logical relationships.....	30
Functional changes in IMS Database Solution Pack 2.2 IMS Online Reorganization Facility.....	32
Service updates and support information.....	32
Product documentation and updates.....	33
Accessibility features.....	34
Chapter 2. Using IMS Online Reorganization Facility.....	35
Running IMS Online Reorganization Facility.....	35
EXEC statements.....	35
DD statements.....	36
HRFSYSIN DD statement.....	46
HRFSYSIN DD statement syntax.....	46
HRFSYSIN DD statement keywords.....	47
Takeover restart processing.....	100
DBD change during reorganization.....	100
Scheduling online reorganization jobs with Autonomics Director.....	102
Examples for IMS Online Reorganization Facility.....	103
Example: Reorganizing a HIDAM using static allocation of image copy and log data sets.....	103
Example: Reorganizing a HDAM using dynamic allocation of image copy and log data sets.....	103
Example: Reorganizing a database in an IMS-managed ACBs environment.....	104
Example: Changing the randomizer parameters of a HDAM database.....	104
Example: Adding or removing a compression routine to a HIDAM database.....	105
Example: Changing database definition in an IMS-managed ACBs environment.....	106
Example: Reorganizing a partition of a PHIDAM database.....	107
Example: Reorganizing a PHDAM database and rebuilding PSINDEXes.....	108
Example: Reorganizing a partition of a PSINDEX.....	108
Example: Unloading a HIDAM database.....	108
Examples: Conditional Reorganization Support Service.....	109
Examples: Using the DDEFPS2 DD statement.....	114
Example: Creating a batch image copy of a HDAM database.....	118
Chapter 3. Changing the IMS Online Reorganization Facility environment.....	119
Customizing the base environment.....	119
Base configuration modules HRFSETOP and HRF#ssid.....	119

Changing the base configuration parameters.....	120
Defining a base configuration module for each IMS ID or IMSPLEX.....	120
Base configuration parameters.....	120
Defining the subordinate address space procedure.....	125
Modifying BMP jobs to have the BMP handler add extra checkpoints.....	126
Modifying BMP jobs so that they are not paused by the BMP handler.....	128
Applying maintenance.....	128
Disabling the BMP pause feature.....	130
Disabling the CICS and ODBA applications pause feature.....	130
Chapter 4. Reference.....	131
Sample library members.....	131
HRFYUTIL utility.....	132
HRFOLOGF exit routine.....	134
How to read syntax diagrams.....	134
Chapter 5. Troubleshooting.....	137
Reorganization job fails to connect to an online IMS subsystem.....	137
Generating additional diagnostic information.....	138
Messages and codes.....	139
Return codes and abend codes.....	139
Messages.....	140
Gathering diagnostic information.....	189
Notices.....	191
Index.....	195

About this information

IBM IMS Database Solution Pack for z/OS® IMS Online Reorganization Facility (also referred to as IMS Online Reorganization Facility) is a database reorganization tool that you can use to maintain your databases so that they run as efficiently as possible.

These topics provide instructions for using IMS Online Reorganization Facility.

To use the procedures in this information, you must first install IMS Online Reorganization Facility as described in the *Program Directory for IMS Database Solution Pack for z/OS*, GI10-8942, and then perform the post-installation steps as described in *IMS Database Solution Pack: Overview and Customization*, SC27-9037.

These topics are designed to help database administrators, system programmers, application programmers, and system operators perform these tasks:

- Customize your IMS Online Reorganization Facility environment
- Reorganize IMS databases with IMS Online Reorganization Facility
- Use IMS Online Reorganization Facility with other IMS products
- Diagnose and recover from IMS Online Reorganization Facility problems

To use these topics, you should have a working knowledge of:

- The z/OS operating system
- ISPF
- SMP/E

Always refer to the IMS Tools Product Documentation web page for complete product documentation resources:

<https://www.ibm.com/support/pages/node/712955>

The IMS Tools Product Documentation web page includes:

- Links to [IBM Documentation](#) for the user guides ("HTML")
- PDF versions of the user guides ("PDF")
- Program Directories for IMS Tools products
- Technical notes from IBM Software Support, referred to as "Tech notes"
- White papers that describe product business scenarios and solutions

Chapter 1. IMS Online Reorganization Facility overview

IBM IMS Database Solution Pack for z/OS IMS Online Reorganization Facility (also referred to as IMS Online Reorganization Facility) performs a one-step reorganization of IMS databases with minimal impact to database availability. IMS Online Reorganization Facility supports logical relationships, secondary indexes, and HALDBs.

Taking systems offline for maintenance can affect your business. In today's market, systems must be highly available because the cost of outage can be too high. Online data reorganization provides users with full access to the database during a data reorganization, improves the overall database availability, and reduces planned downtime.

IMS Online Reorganization Facility provides the following capabilities and benefits:

- Lets you schedule when you want to reorganize online databases by predefining an online reorganization window, which saves DBA resources and CPU time, and increases database availability
- Provides all the necessary reorganization procedures (unload, reload, prefix resolution, prefix update, secondary index building, and image copy) in one simple step
- Supports secondary indexing and logical relationships
- Reduces database downtime significantly
- Improves DBA productivity by providing a single-step reorganization process
- Eliminates the need for operator intervention after database reorganization
- Provides optional pointer checking (HASH Check) and ACB or DMB replacements
- Supports conditional reorganization; evaluates whether a database requires a reorganization and reorganizes the database only when necessary

Reorganizing IMS databases at the right time and keeping the databases in good condition ensures that your IMS applications perform at optimal levels.

Topics:

- [“IMS Online Reorganization Facility terminology” on page 2](#)
- [“What's new in IMS Online Reorganization Facility” on page 4](#)
- [“What does IMS Online Reorganization Facility do?” on page 10](#)
- [“IMS Online Reorganization Facility features and benefits” on page 11](#)
- [“Overview of the online reorganization process” on page 17](#)
- [“Overview of the conditional reorganization process” on page 21](#)
- [“Overview of the batch image copy creation process” on page 23](#)
- [“Considerations for database data sets \(DBDS\) organization conversion and DDEFPS2 DD process” on page 25](#)
- [“IMS Online Reorganization Facility restrictions” on page 27](#)
- [“Considerations for the IMS management of ACBs” on page 29](#)
- [“Considerations for external logical relationships” on page 30](#)
- [“Functional changes in IMS Database Solution Pack 2.2 IMS Online Reorganization Facility” on page 32](#)
- [“Service updates and support information” on page 32](#)
- [“Product documentation and updates” on page 33](#)
- [“Accessibility features” on page 34](#)

IMS Online Reorganization Facility terminology

IMS Online Reorganization Facility uses several unique terms that you must understand before you begin to use it.

Subsections:

- [“Unique terms used in this information” on page 2](#)
- [“Short names and acronyms used in this information” on page 2](#)

Unique terms used in this information

Base configuration module

Refers to the customizable module from which IMS Online Reorganization Facility reads its base configuration parameters.

Change capture

Refers to the change capture process, which runs in the IMS control regions and captures any application update calls to the database during reorganization.

External logical relationship

Refers to the logical relationship that is established between segments in two or more databases.

IMS online change

Refers to the online change function of IMS. It allows modifying IMS resources online.

IMS standard utilities

Refers to the database utilities that are provided by IMS, such as the HD Reorganization Unload utility (DFSURGU0), the HD Reorganization Reload utility (DFSURGL0), and the Database Image Copy utility (DFSUDMP0).

Internal logical relationship

Refers to the logical relationship that is established between segments within a database.

Original data set

Refers to the original copy of the IMS database data set, which is accessed by IMS online systems.

Restart data set

Refers to the repository data set that IMS Online Reorganization Facility uses to store the information of pending reorganization jobs.

Shadow data set

Refers to the temporary copy of the original data set, which is created by IMS Online Reorganization Facility.

Takeover

Refers to the Takeover process, which swaps the name of the original data sets and the shadow data sets at the end of the reorganization.

XCF connection

Refers to the connection established by using XCF Communication Services.

Short names and acronyms used in this information

In this information, the following short names and acronyms are used.

Table 1. Short names for products

Short name	Product name
Autonomics Director	Autonomics Director of IBM IMS Tools Base for z/OS 1.7 or later (5655-V93)
IMS Database Solution Pack	IBM IMS Database Solution Pack for z/OS 2.2 (5655-DSP)
IMS Database Recovery Facility	IBM IMS Recovery Solution Pack for z/OS 2.1, IMS Database Recovery Facility (5655-ISR)

Table 1. Short names for products (continued)

Short name	Product name
IMS HALDB Toolkit	IBM IMS Database Solution Pack for z/OS 2.2, IMS High Availability Large Database Toolkit (5655-DSP)
IMS High Performance Image Copy	IBM IMS High Performance Image Copy for z/OS 4.2 (5655-N45)
IMS High Performance Load	IBM IMS High Performance Load for z/OS 2.1 (5655-M26)
IMS High Performance Pointer Checker	IBM IMS High Performance Pointer Checker for z/OS 3.1 (5655-U09)
IMS High Performance Prefix Resolution	IBM IMS High Performance Prefix Resolution for z/OS 3.1 (5655-M27)
IMS High Performance Unload	IBM IMS High Performance Unload for z/OS 1.2 (5655-E06)
IMS Library Integrity Utilities	IBM IMS Library Integrity Utilities for z/OS 2.2 (5655-U08)
IMS Online Reorganization Facility	IBM IMS Database Solution Pack for z/OS 2.2, IMS Online Reorganization Facility (this product)
IMS Program Restart Facility	IBM IMS Program Restart Facility for z/OS 2.2 (5655-E14)
IMS Recovery Solution Pack	IBM IMS Recovery Solution Pack for z/OS 2.1 (5655-ISR)
IMS Tools Base	IBM IMS Tools Base for z/OS 1.7 or later (5655-V93)
IMS Tools Online System Interface	IMS Tools Online System Interface of IBM IMS Tools Base for z/OS 1.7 or later (5655-V93)
IMS Tools KB	IMS Tools Knowledge Base of IBM IMS Tools Base for z/OS 1.7 or later (5655-V93)
Policy Services	Policy Services of IBM IMS Tools Base for z/OS 1.7 or later (5655-V93)

Table 2. Acronyms for functions, utilities, and components

Acronym	Function, utility, or component name
CICS®	Customer Information Control System
DBRC	Database Recovery Control
HALDB	High availability large database
HALDB OLR	High availability large database (HALDB) online reorganization
HD Unload utility	HD Reorganization Unload utility (DFSURGU0)
IDCAMS	Access method services of DFSMS
ODBA	Open Database Access
PSINDEX	Partitioned secondary index
SMS	System Managed Storage
XCF	Cross-system coupling facility

What's new in IMS Online Reorganization Facility

This topic summarizes the technical changes for this edition.

New and changed information is indicated by a vertical bar (|) to the left of a change. Editorial changes that have no technical significance are not noted.

Revision markers follow these general conventions:

- Only technical changes are marked; style and grammatical changes are not marked.
- If part of an element, such as a paragraph, syntax diagram, list item, task step, or figure is changed, the entire element is marked with revision markers, even though only part of the element might have changed.
- If a topic is changed by more than 50%, the entire topic is marked with revision markers (so it might seem to be a new topic, even though it is not).

Revision markers do not necessarily indicate all the changes made to the information because deleted text and graphics cannot be marked with revision markers.

SC27-9039-13 (September 2024)

Description	Related APARs
Allow DBD change with IMS Online Reorganization Facility to update the IMS catalog When applications use Java or SQL to obtain information from an IMS database, they need the IMS catalog to access the database. If IMS Online Reorganization Facility does not update the IMS catalog during the ACBGEN step, this means the DBA has to add an extra step for the database so that the database becomes useful for the programs that use SQL to access the data. This APAR enables IMS Online Reorganization Facility to update the IMS catalog with the new DBD when the conditions are met. For more information, see the following topics: <ul style="list-style-type: none">• “DFSDF keyword” on page 64• “DBD change when ACB libraries are used” on page 100• New messages “HRF01660I” on page 187, “HRF01661I” on page 187, and “HRF01662I” on page 188	PH61974
NEWDBD(*STAGING) keyword Additional description of the NEWDBD(*STAGING) keyword has been added. For more information, see the following topics: <ul style="list-style-type: none">• “NEWDBD keyword” on page 78• “DBD change when IMS manages ACBs” on page 102	N/A
Notes on IEFORDER DD Additional description of the IEFORDER DD has been added. For more information, see the following topics: <ul style="list-style-type: none">• IEFORDER and IEFORDER2 DD statements in “DD statements” on page 36• “Takeover restart processing” on page 100	N/A

SC27-9039-12 (June 2024)

Description	Related APARs
<p>Allow changes made during the Takeover phase to be backed out</p> <p>BACKOUT option is added to the TAKEOVER keyword to back out any changes made during the Takeover phase if Takeover is not completed successfully.</p> <p>For more information, see the following topics:</p> <ul style="list-style-type: none">• “The Takeover phase” on page 20• “TAKEOVER keyword” on page 96• “Base configuration parameters” on page 120• “Return codes and abend codes” on page 139• New messages “HRF01650E” on page 187 and “HRF01651I” on page 187	PH59907

SC27-9039-11 (April 2024)

Description	Related APARs
<p>Support adding secondary indexes when IMS manages ACBs</p> <p>For more information, see “DBD change feature in an IMS-managed ACBs environment” on page 16.</p>	PH59732

SC27-9039-10 (February 2024)

Description	Related APARs
<p>Allow negative value in the RELOAD.SEARCH keyword</p> <p>See the updated syntax diagram of the “RELOAD.SEARCH keyword” on page 89.</p>	PH59278

SC27-9039-09 (December 2023)

Description	Related APARs
<p>Discard changes made during database initialization</p> <p>IMS Online Reorganization Facility has been enhanced to support an option to discard changes made during database initialization.</p> <p>For more information, see “INITIALIZE keyword” on page 74.</p>	PH57885

SC27-9039-08 (September 2023)

Description	Related APARs
<p>Database data sets (DBDS) organization conversion support</p> <p>IMS Online Reorganization Facility has been enhanced to support DBDS organization conversion.</p> <p>IMS Online Reorganization Facility supports the following conversions:</p> <ul style="list-style-type: none">• OSAM to OSAM LDS• VSAM to OSAM• VSAM to OSAM LDS <p>IMS Online Reorganization Facility provides the following new functions to support the conversion:</p> <ul style="list-style-type: none">• DDEFPS2 DD support• NEWDBD and DDEFPS2 DD combination support <p>For more information, see the following topics:</p> <ul style="list-style-type: none">• “Considerations for database data sets (DBDS) organization conversion and DDEFPS2 DD process” on page 25• “DBD changes that are not allowed” on page 28• DDEFPS2 DD statement in “DD statements” on page 36• “NEWDBD keyword” on page 78• “SHADOW keyword” on page 95• “VOLALLO keyword” on page 99• “Examples: Using the DDEFPS2 DD statement” on page 114• UNITPOOL and VOLPOOL parameters in “Base configuration parameters” on page 120• New messages “HRF01640I” on page 186 to “HRF01648E” on page 187	PH54781

SC27-9039-07 (April 2023)

Description	Related APARs
<p>Allow specifying allocation value for temporary unload data set per job</p> <p>New keywords, UNLSPAC and UNLUNIT, have been added to allow specifying allocation value for temporary unload data set per job. For more information, see the following topics:</p> <ul style="list-style-type: none">• “HRFSYSIN DD statement keywords” on page 47• “UNLSPAC keyword” on page 98• “UNLUNIT keyword” on page 99• New messages “HRF01311I” on page 165 and “HRF01634E” on page 186	PH49853

SC27-9039-06 (July 2022)

Description	Related APARs
Reorganize the IMS catalog IMS Online Reorganization Facility has been enhanced to support reorganization of the IMS catalog. IMS catalog databases are deleted from a list of databases that are not supported.	PH46904

SC27-9039-05 (April 2022)

Description	Related APARs
Run a read-only reorganization job for an index A new option to run a read-only reorganization job for an index has been added. The new keyword, READONLY(Y), is effective only for index reorganization. For more information, see “READONLY keyword” on page 86 .	PH43854
Reorganize a single or selected partitions of a non-recoverable PSINDEX database The new TEMPRECOV(Y) keyword reorganizes a single or selected partitions of a non-recoverable PSINDEX database. For more information, see “TEMPRECOV keyword” on page 98 .	

SC27-9039-04 (December 2021)

Description	Related APARs
Create a batch image copy of a database using a new IMAGECOPY command This APAR enables IMS Online Reorganization Facility to create a batch image copy of a database using a new IMAGECOPY command with minimal impact to database availability. For more information, see the following topics: <ul style="list-style-type: none">• Chapter 1, “IMS Online Reorganization Facility overview,” on page 1• “What does IMS Online Reorganization Facility do?” on page 10• “Overview of the batch image copy creation process” on page 23• “IMS Online Reorganization Facility restrictions” on page 27• Chapter 2, “Using IMS Online Reorganization Facility,” on page 35• “Running IMS Online Reorganization Facility” on page 35• “DD statements” on page 36• “HRFSYSIN DD statement syntax” on page 46• “HRFSYSIN DD statement keywords” on page 47• “Example: Creating a batch image copy of a HDAM database” on page 118	PH41091

SC27-9039-03 (September 2021)

Description	Related APARs
<p>Reorganize databases with external logical relationships</p> <p>Support online reorganization of databases that have external logical relationships.</p> <p>In order to reorganize multiple databases in parallel, IMS Online Reorganization Facility initiates multiple subordinate address spaces. Each subordinate address space is a started task that executes the subordinate address space procedure named HRFSUB, so this procedure must be placed in your PROCLIB data set before running the reorganization job. For more information, see the following topics:</p> <ul style="list-style-type: none">• “Considerations for external logical relationships” on page 30• “DFDSS keyword” on page 62• “DFDSS.FASTREP keyword” on page 62• “DFDSS.FCTOPPRCP keyword” on page 63• “DFDSS.FCTOXRCP keyword” on page 63• “PRERES.HPPRBH keyword” on page 83• “RELOAD.WF1HLQ keyword” on page 90• “RELOAD.WF1SPACE keyword” on page 90• “RELOAD.WF1UNIT keyword” on page 91• “RELOAD.WF1VOL keyword” on page 91• “SASJOBPREF keyword” on page 94• “SASMAX keyword” on page 95• “Defining the subordinate address space procedure” on page 125• New messages “HRF01199E” on page 164, “HRF01631E” on page 185, “HRF01632E” on page 185, and “HRF01633I” on page 185• Modified message “HRF01100I” on page 152	PH33045
Message “HRF01617W” on page 183 has been modified.	PH35989
Message “HRF01163E” on page 161 has been modified.	PH38867

SC27-9039-02 (April 2020)

Description	Related APARs
<p>Specify whether to allow read-only DL/I batch jobs to access the database</p> <p>A new keyword, READON, has been added. You can use this keyword to specify whether to allow read-only DL/I batch jobs to access the database which the IMS Online Reorganization Facility job is processing. This enhancement enables IMS Online Reorganization Facility to minimize impacts to DL/I batch jobs during reorganization. For more information, see “READON keyword” on page 86.</p>	PH04466

Description	Related APARs
<p>Unload a database that has external logical relationships</p> <p>IMS Online Reorganization Facility has been enhanced to support unloading HISAM, HIDAM, HDAM, SHISAM, PHDAM, and PHIDAM databases while the database remains online. It can unload a database that has logical relationships (including external logical relationships), but when it unloads logical child segments whose logical parent's concatenated keys (LPCKs) are virtual, it does not retrieve the LPCKs.</p>	PH10454
<p>Reorganize encrypted VSAM databases</p> <p>A new keyword, KEYLABEL, and a new base configuration parameter, LOGKYLBL, have been added. This enhancement enables IMS Online Reorganization Facility to reorganize encrypted VSAM databases and to dynamically allocate encrypted data sets for image copy and apply log. For more information, see the following topics:</p> <ul style="list-style-type: none"> • “KEYLABEL keyword” on page 75 • “LOGKYLBL=nnnnnnnn” on page 122 	PH11473
<p>Support IMS management of ACBs</p> <p>IMS Online Reorganization Facility has been enhanced to support the IMS management of ACBs.</p> <p>When the IMS management of ACBs is enabled, IMS Online Reorganization Facility can refer to database definitions in the IMS catalog directory instead of the DBD library. If you want to change the database definition in a reorganization job, you can specify the NEWDBD(*STAGING) keyword to have IMS Online Reorganization Facility reload the database using pending database definitions in the IMS catalog staging data sets. For more information, see the following topics:</p> <ul style="list-style-type: none"> • “Considerations for the IMS management of ACBs” on page 29 • “DFSDF keyword” on page 64 • “IMSID keyword” on page 73 • “NEWDBD keyword” on page 78 • “DBD change when IMS manages ACBs” on page 102 • “DBDCLAS=sss” on page 121 • “DBDDSN=pppppppppppppp” on page 121 • “DBDVOL=vvvvvv” on page 121 • “DBSCLAS=sss” on page 121 	PH11847
SC27-9039-01 (September 2018)	
Description	Related APARs
<p>Allocate GDG data sets as log data sets</p> <p>IMS Online Reorganization Facility can allocate GDG data sets as log data sets. For more information, see the following topics:</p> <ul style="list-style-type: none"> • “GDGLIMIT keyword” on page 64 • “LOG1DSN keyword” on page 75 	PH00388

Description	Related APARs
<p>Rebuild PSINDEXes during HALDB reorganization</p> <p>If you specify the PSINDEXBLD keyword, IMS Online Reorganization Facility rebuilds PSINDEXes during HALDB reorganization. For more information, see the following topics:</p> <ul style="list-style-type: none"> • “PSINDEXBLD keyword” on page 85 • “Example: Reorganizing a PHDAM database and rebuilding PSINDEXes” on page 108 	PI89625
<p>Initialize the database during reorganization</p> <p>A new keyword, INITIALIZE, has been added. You can use this keyword to initialize (empty out) the database during reorganization. For more information, see “INITIALIZE keyword” on page 74.</p>	PI90523
<p>Enhancement to the conditional reorganization capability</p> <p>Three new keywords, CR.EVALINDEX, CR.IC, and CR.UNLOAD, have been added. These keywords enhance the conditional reorganization capability. For more information, see the following topics:</p> <ul style="list-style-type: none"> • “CR.EVALINDEX keyword” on page 55 • “CR.IC keyword” on page 55 • “CR.UNLOAD keyword” on page 59 • “Scenario 5: Evaluating secondary indexes and conditionally reorganizing a database” on page 113 	PI91880
<p>Other documentation changes</p> <p>New topic “Applying maintenance” on page 128 has been added. Follow the instructions in this topic to apply maintenance to IMS Online Reorganization Facility when the maintenance requires refreshing the IMS Online Reorganization Facility load modules in online systems.</p>	N/A

What does IMS Online Reorganization Facility do?

IMS Online Reorganization Facility provides a way to reorganize, unload, and create a batch image copy of your IMS databases with minimal impact to their availability.

IMS Online Reorganization Facility allows a database to be updated while the reorganization, unload, or image copy process is occurring. After all changes are captured and applied, the database is taken offline for a brief period at the end of the reorganization. During this period, the shadow data sets that have been reorganized are renamed to match the original database data set names. A shadow data set is a temporary copy of an original data set.

After the online reorganization is complete, no manual intervention is required, unless the database state is undetermined or if you have specified that the shadow database data sets not be renamed.

IMS Online Reorganization Facility supports the following database organization types:

- HDAM (Hierarchical Direct Access Method)
- HIDAM (Hierarchical Indexed Direct Access Method)
- HISAM (Hierarchical Indexed Sequential Access Method)
- SHISAM (Simple Hierarchical Indexed Sequential Access Method)
- PHDAM (Partitioned Hierarchical Direct Access Method)
- PHIDAM (Partitioned Hierarchical Indexed Direct Access Method)
- PSINDEX

- Secondary index

When IMS Online Reorganization Facility reorganizes HISAM, HIDAM, HDAM, and SHISAM databases, it re-creates all associated index data sets. PHIDAM and PHDAM databases are reorganized as single partitions. HALDB partitions are reorganized in a single job step and their internal logical relationships are supported. Index databases (including PSINDEX) can be reorganized while the database remains online.

IMS Online Reorganization Facility supports secondary indexing (for HISAM, HIDAM, HDAM, and SHISAM databases) and internal logical relationships (excluding external logical relationships). IMS Online Reorganization Facility can optionally create a standard HD unload data set for a database, and it also creates a standard image copy data set for all the reorganized databases that are registered as recoverable with DBRC.

IMS Online Reorganization Facility supports unloading HISAM, HIDAM, HDAM, SHISAM, PHDAM, and PHIDAM databases while the database remains online. It can unload a database that has logical relationships (including external logical relationships), but when it unloads logical child segments whose logical parent's concatenated keys (LPCKs) are virtual, it does not retrieve the LPCKs.

IMS Online Reorganization Facility supports creating a batch image copy of HISAM, HIDAM, HDAM, SHISAM, PHDAM, and PHIDAM databases using the IMAGECOPY command while the database remains online. It can create a batch image copy of a database that is registered as recoverable with DBRC. It can also create an image copy of the database that has logical relationships (including external logical relationships).

IMS Online Reorganization Facility features and benefits

Using IMS Online Reorganization Facility to reorganize IMS databases offers some significant benefits over other methods of reorganizing IMS databases.

IMS Online Reorganization Facility provides the following features and benefits:

Increased database availability

All database changes are captured and applied while the databases are being reorganized. You do not need to take the databases offline to reorganize them. IMS Online Reorganization Facility is designed to reorganize databases while they are being updated or accessed within IMS online systems.

Improved performance

IMS Online Reorganization Facility provides high-performance by streamlining parameter setting and running tasks in parallel.

Simplified JCL

IMS Online Reorganization Facility saves time and eliminates the difficulty that is involved with writing DD statements by dynamically allocating the database data sets with DBRC and dynamically allocating image copy data sets and other output data sets by using control statements.

One-step reorganization process

By automatically invoking database maintenance utilities of IMS Database Solution Pack in a single reorganization step, IMS Online Reorganization Facility saves DBA resources and CPU time.

Conditional reorganization

IMS Online Reorganization Facility supports the Conditional Reorganization Support Service (CRSS) of IMS Database Reorganization Expert. The CRSS adds the conditional reorganization capability to the reorganization jobs of IMS Online Reorganization Facility.

- Preserves the maintenance time window by providing the ability to reorganize a database only when it is needed.
- Informs you about the status of your databases by providing early notification of database exceptional conditions.
- Provides practical database reorganization criteria in the out-of-box rule templates, which you can use to reduce complex decision-making tasks.
- Provides a simple customization and maintenance approach for policies and rules through an ISPF interface.

- Provides historical reports that are preserved in the centralized repository. You can use these reports for future analysis, problem-solving, and research on databases.

Compatible data creation

Data that is created by IMS Online Reorganization Facility is compatible with IMS standard utilities. The optional HD unload data set and the DFSURWF1 data set (that is created only for internal logical relationships and not for secondary indexes) are examples of data sets that are compatible with the IMS standard utilities.

DBD changes without manual intervention

DBD changes are supported during the reorganization process and basically do not require any manual intervention after the reorganization.

You can make the DBD change available immediately without using IMS online change because IMS Online Reorganization Facility automatically generates an ACB and performs a DMB replacement in the current online IMS subsystems. This approach eliminates manual intervention and increases database availability.

Statistics reports

Provide statistics reports about data sets, segments, and segment pointers to serve as valuable aids in tuning your databases. The database maintenance utilities that are invoked by IMS Online Reorganization Facility, such as IMS High Performance Load, IMS High Performance Image Copy, and IMS High Performance Pointer Checker, provide reports in their respective output data sets.

Application pause support during /DBRECOVERY and /STOP

Batch message processing programs (BMPs) can be paused during **/DBRECOVERY (/DBR)** and **/STOP (/STO)** commands. CICS and ODBA applications that attempt to access the database can be also paused.

Scheduled Takeover phase

Managing database outages so that they occur with the least amount of service disruption is important. You can use the TAKEOVER.WINDOW keyword to predefine the takeover period.

Takeover phase restart processing

If the previous reorganization job failed or was delayed during the Takeover phase, you can restart the Takeover phase from where it stopped by resubmitting the job.

BMP pause feature

IMS Online Reorganization Facility supports BMP pause, which pauses long-running BMPs while the database is reorganized. If you plan to use IMS Online Reorganization Facility for databases that are used by long-running BMPs, enable BMP pause for any BMPs that access the databases during the reorganization process.

Recommendation: BMP pause is an optional feature that is highly recommended for databases that are used by long-running BMPs.

The environment must be customized to use BMP pause. Ensure that the instructions in the topic "Enabling the BMP pause feature" in *IMS Database Solution Pack: Overview and Customization* have been completed.

Subsections:

- [“How BMPs are affected during a reorganization” on page 12](#)
- [“How BMP pauses affect large checkpoint intervals” on page 13](#)

How BMPs are affected during a reorganization

How BMPs are affected during a reorganization depends on whether a BMP is running at the time of the reorganization or is started during the reorganization.

BMPs running during the reorganization

When IMS Online Reorganization Facility reorganizes a database, it must temporarily stop the database by using the **/STO** or **/DBR** command. IMS does not allow a database to be stopped with a **/STO** or **/DBR** command while an active BMP is accessing that database.

IMS Online Reorganization Facility can communicate with any BMP that is accessing the database when the reorganization job must stop the database with a **/STO** or **/DBR** command. When a BMP detects that IMS Online Reorganization Facility must momentarily stop a database, the BMP temporarily stops until IMS Online Reorganization Facility restarts the database.

To stop a BMP, IMS Online Reorganization Facility requests the BMP to stop. After the completion of the next CHKP call, BMP issues a 3303 pseudo abend. The job step TCB detects that a pseudo abend was issued to allow IMS Online Reorganization Facility to use the **/STO** or **/DBR** command to stop the database. Then the job step TCB waits for IMS Online Reorganization Facility to restart the database. After the database restarts, the job step TCB restarts the BMP from the last completed checkpoint.

When the BMP pause feature is enabled, IMS Online Reorganization Facility pauses the BMP job after the following calls:

- CHKP call
- SYNC call
- GU call against I/O PCB, whose DL/I status is QC

If you have BMP jobs that you do not want to pause, see [“Modifying BMP jobs so that they are not paused by the BMP handler”](#) on page 128.

BMPs started during reorganization

When a new BMP is started during a reorganization, the job step TCB checks the status of the IMS Online Reorganization Facility job. If the job is preparing to momentarily stop the database or it has already stopped the database that the BMP needs to access, the job step TCB waits until IMS Online Reorganization Facility restarts the database and then the job step invokes the application.

The following example explains how BMPs are stopped and restarted during a reorganization:

1. A U3303 pseudo abend is issued when IMS Online Reorganization Facility needs to stop the full-function database with a **/DBR** command after the BMP reaches the next checkpoint:

```
DFS0540I *EXTENDED CHECKPOINT* PROGRAM=Y$$$APPL,CKPTID=CHKPT002,
REGID=0001,DAY=170,TIME=1728184 IM7A
DFS0542I *EXTENDED CHECKPOINT* DAY=170,TIME=172818452297-0700 IM7A
DFS682I BATCH-MSG PROGRAM AHDOPR2 JOB BMP002 MAY BE RESTARTED
FROM CHKPT ID CHKPT002 IM7A
DFS554A BMP002 00001 UPDSTEP AHDOPR2 (2) 000,3303
2021/170 10:28:18 IM7A
DFS552I BATCH REGION BMP002 STOPPED ID=00001 TIME=1028 IM7A
```

2. IMS Online Reorganization Facility issues the **/DBR** command to recover the database:

```
DFS2500I DATABASE HDOPR2 SUCCESSFULLY DEALLOCATED IM7A
DFS0488I DBR COMMAND COMPLETED. DBN= HDOPR2 RC= 0 IM7A
FOI110I ACTION INITIATED: /DBR DB HDOPR2 LOCAL NOFE0V IM7A
```

3. The BMP automatically restarts and runs to completion:

```
DFS551I BATCH REGION BMP002 STARTED ID=00001 TIME=1030 IM7A
DFS552I BATCH REGION BMP002 STOPPED ID=00001 TIME=1030 IM7A
```

How BMP pauses affect large checkpoint intervals

When IMS Online Reorganization Facility needs to pause a BMP, it does it at the next checkpoint call. When the checkpoint frequency is low, reaching the next checkpoint call might take longer than you expect. The IMS Online Reorganization Facility BMP handler allows you to add additional checkpoints. The BMP handler does not manage the application restart.

The application must specify which database PCB to use to trigger a pause. This trigger can be a GU call, or the trigger can occur when a GN call reaches the root segment. IMS Online Reorganization Facility then determines if the pause interval has expired and if a pause request is pending.

If a pause interval has expired or a request is pending, IMS Online Reorganization Facility creates a CHKP call and issues a 3303 abend because a **/DBR** command was issued. The application returns to the IMS Online Reorganization Facility main task and resumes after the pause request is processed. The BMP application must have checkpoints defined.

If the application does not issue CHKP calls, CHKP=N must be specified to indicate that there is no waiting for a checkpoint call. After a pause request is pending, a checkpoint is issued, the BMP is paused, and a 3303 abend is issued.

IMS Online Reorganization Facility captures the first CHKP call and repeats that call. Currently defined checkpoints stay where they were defined and additional checkpoints can be added. The application can be independent of the content of the checkpoint ID because IMS Online Reorganization Facility might create its own ID.

For more information, see [“Modifying BMP jobs to have the BMP handler add extra checkpoints”](#) on page 126.

CICS and ODBA applications pause feature

IMS Online Reorganization Facility supports the CICS and ODBA applications pause feature to pause CICS and ODBA applications that attempt to access the database while the database is reorganized. If you plan to use IMS Online Reorganization Facility for databases that are used by CICS or ODBA applications, you must enable this feature for any CICS and ODBA applications that access the databases during the reorganization process.

During a database reorganization, IMS Online Reorganization Facility must temporarily stop or issue **/DBR** on the database. The **/DBR** command requires a pause of all processing on the IMS database. Long-running jobs that are often associated with CICS and ODBA must be paused. Any attempt to schedule a PSB in a CICS or ODBA application that contains a PCB for a database that has been processed with **/DBR**, results in an abend. When a CICS or ODBA APSB request detects that IMS Online Reorganization Facility needs to momentarily stop, the thread in which the APSB request is made is put into a temporary wait state until IMS Online Reorganization Facility restarts the database.

CICS and ODBA pausing is an optional feature. To use this feature, the CICS and ODBA applications pause feature must be enabled. Ensure that the instructions in the topic "Enabling the CICS and ODBA applications pause feature" in *IMS Database Solution Pack: Overview and Customization* have been completed.

DBD change feature

You can change the DBD during an online reorganization. DBD change basically does not require any manual intervention after the reorganization.

The DBD change feature behaves differently when the IMS management of ACBs is enabled. For the DBD change feature in an IMS-managed ACBs environment, see [“DBD change feature in an IMS-managed ACBs environment”](#) on page 16.

Subsections:

- [“DBD and DMB replacement”](#) on page 14
- [“Supported DBD changes”](#) on page 15
- [“DBD change feature in an IMS-managed ACBs environment”](#) on page 16

DBD and DMB replacement

When a DBD change is specified, the shadow database is unloaded by using the original DBD library, then reloaded by using the new DBD library.

You can make the DBD change available immediately without using the IMS online change because IMS Online Reorganization Facility performs the following actions:

1. Copies the new DBD to current DBDLIB.
2. Generates a DMB for the new DBD.
3. Copies the new DMB to the IMSACBA and IMSACBB libraries.
4. Activates the new DMB in the current IMS subsystems.

During the Takeover phase, IMS Online Reorganization Facility copies the new DBD to the current IMS DBDLIB. Copying the new DBD helps avoid out-of-sync situations between the DBDLIB and the ACBLIB. Then, IMS Online Reorganization Facility automatically performs ACBGEN to generate a DMB of the new DBD. The generated DMB is copied to both the active and inactive ACBLIBs.

IMS Online Reorganization Facility also replaces the DMB in the current online IMS subsystems with the new DBD to eliminate the need of an IMS online change. At the end of the Takeover phase, IMS Online Reorganization Facility clears the prohibit authorization flag in RECON and restarts the database. This approach eliminates manual intervention and increases database availability during DBD change.

DMB cannot be replaced when either of the following conditions is met:

- The specified DBD change involves changes to PSBs.
- The database is either a PHDAM or PHIDAM database.

When either of these conditions is met, a setting of ONLINECHANGE(N) is required. IMS Online Reorganization Facility copies the new DBD to the current DBDLIB and performs an ACBGEN in the staging ACBLIB but does not modify the IMSACBA and IMSACBB libraries. You must perform an IMS online change after the reorganization.

Supported DBD changes

IMS Online Reorganization Facility supports DBD changes during online reorganization.

DBD changes are supported for the following types of full-function databases:

- HDAM databases
- HIDAM databases whose root keys are not compressed
- HISAM databases
- SHISAM databases

DBD changes are also supported for the following types of HALDBs:

- PHDAM databases
- PHIDAM databases whose root keys are not compressed

Requirements: When you change the DBD of a HALDB, the following conditions must be met:

- All partitions must be processed in the IMS Online Reorganization Facility job.
- You must specify ONLINECHANGE(N), and perform an IMS online change after the reorganization.

The following types of DBD changes can be done after the reorganization. These DBD changes require no manual intervention if the database is a full-function database:

Randomizer parameters (HDAM only)

You can change all the parameters except for the randomizer name. When you change randomizer parameters, you must specify RELOAD.SORT(Y) to invoke a physical sequential sort because the randomized sequence of the database records is changed.

COMPRTN parameters

You can change all the parameters except for the fourth parameter.

- The fourth parameter specifies the maximum number of bytes by which fixed-length segments can increase during compression exits. You cannot change the fourth parameter if ONLINECHANGE(Y); when you change the fourth parameter, specify ONLINECHANGE(N).

- When you change the routine name, you must include both the old and new compression routines in the STEPLIB concatenation.
- When you change the COMPRTN parameters of the HALDB database, you must specify ONLINECHANGE(N).

DATASET statement

You can change the following keyword parameters:

- FRSPC (for HDAM and HIDAM)
- SIZE
- BLOCK
- RECORD (for HISAM and SHISAM)

FIELD statement

The following changes are supported:

- Adding a new field at the end of the segment
- Increasing the field length

When you make these changes to a HALDB database, you must specify ONLINECHANGE(N).

The following types of DBD changes can be done, but because IMS Online Reorganization Facility cannot update PSBs in online IMS subsystems, manual intervention is required after the reorganization:

Adding a new segment at the end-of-segment-type sequence (for full-function databases)

IMS Online Reorganization Facility brings the database back online after adding a new segment. You must manually run the Online Change Copy utility (DFSUOCU0) to update the inactive ACBLIB followed by a standard IMS online change to allow applications to use the new segment.

Adding secondary indexes (for full-function databases)

After adding secondary indexes, IMS Online Reorganization Facility leaves the database offline because a setting of ONLINECHANGE(N) is required. You must manually run the Online Change Copy utility to update the inactive ACBLIB followed by a standard IMS online change, turn off the prohibit authorization flag, and then bring the database back online.

The following restrictions and requirements apply when you add secondary indexes:

- Up to five new indexes can be specified.
- The new index DBDs must be placed in the NEWDBD data set.
- Before you run IMS Online Reorganization Facility, the new index DBDs must be registered with DBRC.
- Before you run IMS Online Reorganization Facility, the data sets must be allocated and cataloged.

Adding or removing a COMPRTN keyword

Changing the fourth parameter of the COMPRTN keyword (for full-function databases)

Changing COMPRTN parameters (for HALDB databases)

Adding a new segment at the end-of-segment-type sequence (for HALDB databases)

Adding a new field at the end of the segment or increasing the field length (for HALDB databases)

After reorganizing the database using the new definition, IMS Online Reorganization Facility leaves the database offline because a setting of ONLINECHANGE(N) is required. You must manually run the Online Change Copy utility to update the inactive ACBLIB followed by a standard IMS online change, turn off the prohibit authorization flag, and then bring the database back online.

DBD change feature in an IMS-managed ACBs environment

The DBD change feature in an IMS-managed ACBs environment requires that the new database definitions exist in the IMS catalog staging data sets before running the IMS Online Reorganization Facility job.

When the NEWDBD(*STAGING) keyword is specified in the IMS Online Reorganization Facility job, the shadow database is unloaded by using the active database definition obtained from the IMS catalog

directory data sets, then reloaded by using the pending database definition obtained from the IMS catalog staging data sets. After the reorganization, IMS Online Reorganization Facility leaves the reorganized database offline. You must manually activate the new database definition by issuing the `IMPORT DEFN SOURCE(CATALOG)` command.

All the DBD changes described in “Supported DBD changes” on page 15 are supported in IMS-managed ACBs environments though a setting of `ONLINECHANGE(N)` is required.

Overview of the online reorganization process

IMS Online Reorganization Facility performs the reorganization process in several phases.

Reorganization phases occur in the following sequence:

1. Verification phase
2. Copy phase
3. Reorganization phase
4. Apply phase
5. Takeover phase
6. Completion phase

Descriptive messages are written to the `MSGPRINT` log. These messages indicate the start and end of each phase and the progress of the tasks that are being performed.

IMS Online Reorganization Facility makes a copy of the target databases and reorganizes the copy. While that phase is being processed, IMS Online Reorganization Facility captures any updates that were made since the first copy was taken and processes those recent updates against the reorganized copy. This process continues until all the updates have been applied.

A single **/DBR** command outage is necessary at the end of the reorganization to alter the database data sets from the shadow names to the original names and to make any ACB or DMB replacements in the online systems.

After the updates are applied, a user-scheduled short outage occurs. During the outage, the database data sets are swapped, and the new reorganized database becomes available.

To schedule this outage, use the `TAKEOVER.WINDOW` keyword.

The following figure shows the data flow through the phases of IMS Online Reorganization Facility processing.

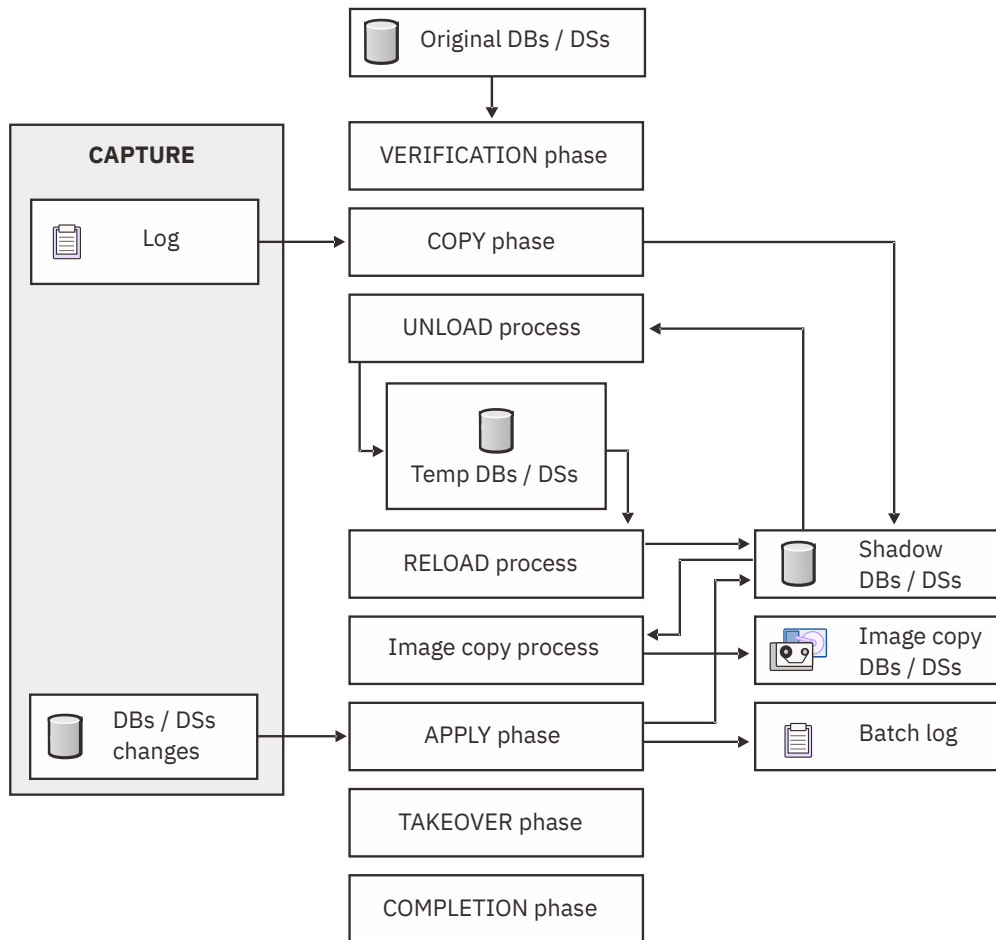

Figure 1. Data flow of the online reorganization process

The Verification phase

The Verification phase is the initial phase during which the IMS environment components and databases are verified to ensure that they meet the requirements. The following verifications are performed during this phase:

- IMS Release and component requirements are met.
- DBRC registration and database state requirements are met.
- Database DBD requirements are met.
- Database data set requirements are met. They cannot exceed 42 characters in length and they must be cataloged.
- The level of IMS Online Reorganization Facility for the STEPLIB in the batch job and the IMS control regions is verified.
- JCL requirements are met.
- Control statement syntax is verified.
- Shadow data set (.S data sets) are constructed and deleted, and reallocation is performed and verified.
- Temporary (.T data sets) ALTER data sets are deleted, and the deletions are verified.
- Other miscellaneous checking is performed.

The Verification phase attempts to perform all necessary verifications at the beginning of the reorganization. If minimum requirements are not met, this phase fails with a U999 abend, and all messages are written to the MSGPRINT log. The original databases are not impacted.

The Copy phase

Before the Copy phase begins, the databases are briefly paused to flush the buffers across all IMS subsystems. Flushing the buffers eliminates the need to issue **/DBR** commands and eliminates the need to unauthorize the databases in DBRC. During the first database sync point pause, the online component of IMS Online Reorganization Facility is notified to perform the following actions:

- It captures all changes that are made to the primary database data sets.
- It sends the changes to the Online Reorganization batch utility.
- It prepares the changes for the application during the Copy phase.

The Copy phase copies only the original primary database to a shadow copy. The shadow data sets are allocated during the Verification phase. The shadow data sets are dynamically constructed based on the original data set names and an appended .S suffix.

Important: You must have enough DASD storage to allocate the data sets within the same SMS pool (most common) or designated DASD volumes on which your original database data sets are allocated. Because most databases are allocated by using SMS, the number of DASD volumes is not an issue. You do not need to provide IDCAMS definitions for the shadow data sets. To construct the shadow data sets, the cataloged information from the original data set names is used.

Near the end of the Copy phase, another database sync point pause is issued. This sync point pause ensures that all of the changes that were made to the primary database data sets have been applied to the shadow database data sets. During this second brief pause, the following actions occur:

- Any application update calls to the primary database are captured.
- Changes are sent to the IMS Online Reorganization Facility batch utility.
- Changes are made to the shadow primary database.
- The shadow primary index (for HIDAM or PHIDAM) is created from the shadow primary database.

The primary index is rebuilt without any effect on the availability of the original databases. Secondary indexes are not copied to shadow databases in this phase; they are rebuilt later.

The Reorganization phase

The following tasks, which are necessary to complete a reorganization of a primary database and all of its associated databases, are performed during the Reorganization phase.

1. The shadow database is unloaded.
2. The shadow database is reloaded.
3. Any existing secondary indexes are rebuilt. (Indexes for HALDB databases are not rebuilt unless you specify PSINDEXBLD(Y).)
4. Any existing internal logical relationships are rebuilt.
5. The reorganized shadow databases of the original databases that are registered as RECOV in DBRC are image copied and can be pointer checked.

During the Reorganization phase, any application update calls that are captured by the online component of IMS Online Reorganization Facility are written to a temporary data set for use in the subsequent Apply phase.

The Apply phase

During the Apply phase, all of the application calls that occurred since the start of the reorganization process are applied to the shadow data sets. Throughout the Apply phase, any application update calls that are issued in the IMS online regions are captured and stored in a temporary data set. After the Apply phase determines that it applied nearly all of the captured update calls, it issues a **/DBR** command. The **/DBR** command stops additional access to the original database in the IMS online regions and turns on the prohibit authorization flag in DBRC. The database and its indexes are unavailable until after the Takeover phase. After all of the captured update calls are applied, the Apply phase ends.

The Takeover phase

The Takeover phase begins when the Apply phase completes.

During the Takeover phase, the original databases are swapped with the reorganized shadow databases. The following tasks are performed in the following order during the Takeover phase:

1. Verifies that the database and its indexes are unavailable.
2. Notifies DBRC of the REORG with a time stamp after the **/DBR** command.
3. Notifies DBRC of the image copy with a time stamp that is greater than the REORG time stamp.
4. Notifies DBRC of logs that were created during the Apply phase. These logs are marked in error until the Takeover phase completes.
5. Notifies DBRC of a DB ALLOC that log data sets require.
6. Swaps the reorganized shadow data sets with the original database data sets.
7. Copies the NEWDBD to the current DBDLIB if DBDCOPY(Y) is specified.
8. Performs the ACBGEN and ACBLIB or DMB replacements if DBD changes have occurred.
9. Authorizes the databases in DBRC.
10. Uses a **/START** command to start the databases.
11. Continues to recover the log marked in error. Uses a valid time stamp that is greater than the DBRC REORG and image copy notifications to correct the previous log that was marked in error. The Takeover phase does not wait for the previous log correction to occur.
12. Notifies DBRC of the log that has the new time stamp.

If the Takeover phase completes abnormally, the job abends, the databases are left in a prohibit authorization (PROHIBIT AUTH = ON) status, and the information that is required to restart the Takeover phase is saved in the restart data set.

You can restart the IMS Online Reorganization Facility batch job only if the job terminated abnormally within the Takeover phase. No other phase of IMS Online Reorganization Facility is restartable. For more information, see [“Takeover restart processing”](#) on page 100.

Backout can be performed when the previous online reorganization job for a specific database (DBD name or partition name) failed during the Takeover phase and TAKEOVER(BACKOUT) is specified in HRFSYSIN.

The following tasks are performed according to the progress of the Takeover phase.

1. Delete a database reorganization record
2. Delete an image copy record
3. Delete an allocation record
4. Delete PRILOG and SLDS records
5. Back out the original database data sets

Issue a **/START** command to start the databases after all backout processes are completed. Databases are online in the original state.

The Completion phase

The Completion phase is the final phase of IMS Online Reorganization Facility processing.

During this phase, the following cleanup tasks are performed:

- All of the final reports and messages are written.
- If you specified DELETE(Y), shadow data sets are deleted.
- Data sets are deallocated.
- Miscellaneous cleanup tasks are performed.
- The IMS Online Reorganization Facility batch job ends.

Overview of the conditional reorganization process

IMS Online Reorganization Facility supports the Conditional Reorganization Support Service (CRSS) of IMS Database Reorganization Expert. Use the CRSS to diagnose a database and determine whether it requires reorganization.

When the CRSS is used with IMS Online Reorganization Facility, it provides the following features:

Conditional reorganization

- Supports the reorganization policies in which user-defined criteria for detecting database exceptions are defined.
- Collects statistics data of the target database and, by using a reorganization policy, evaluates the statistics data to determine if the database needs to be reorganized. When a database needs to be reorganized, the CRSS requests IMS Online Reorganization Facility to run the reorganization process in the same job step.

Exception reporting and process tracking

- Detects database exceptions and notifies the exceptional state of the database to specific TSO users or z/OS operators as a message, or through email or texting.
- Generates a diagnosis report that summarizes the database statistics, whether the criteria for reorganization were met, and, when database is reorganized during the job, the statistics of the reorganized database.

Runtime modes for CRSS

IMS Online Reorganization Facility supports the following three runtime modes for use with the CRSS:

Conditional Reorganization mode

When you run IMS Online Reorganization Facility in this mode, it invokes the CRSS to evaluate the database.

- When the CRSS determines that the database needs to be reorganized, IMS Online Reorganization Facility reorganizes the database. When the reorganization process completes, the CRSS is called to evaluate the reorganized database and to report the processing result and the status of the database before and after reorganization.
- When the CRSS determines that the database does not need to be reorganized, it reports the current database status and requests IMS Online Reorganization Facility to end the job without reorganization.

Conditional Reorganization mode is useful when you do not know the database status and you want to reorganize the database only if database reorganization is needed.

Reorganization Diagnosis mode

When you run IMS Online Reorganization Facility in this mode, IMS Online Reorganization Facility reorganizes the database regardless of the database status. The CRSS evaluates the database and reports the processing results and the status of the database before and after reorganization. Although the CRSS is invoked, the database is reorganized every time a job is run in this mode.

Use Reorganization Diagnosis mode when you want to reorganize the database and want to compare the database status before and after reorganization. You can also obtain a list of exceptions that remained after the reorganization.

Diagnosis-only mode

When you run IMS Online Reorganization Facility in this mode, it invokes the CRSS to evaluate the database and to report the database status. The reorganization process of IMS Online Reorganization Facility is not invoked in this mode.

Use Diagnosis-only mode to check the database status.

The CONDREORG keyword of the HRFSYSIN DD statement requests the CRSS and controls the runtime modes. For more information, see [“CONDREORG keyword”](#) on page 53.

To learn more about the CRSS, see the topic "Conditional Reorganization Support Service" in the *IMS Database Reorganization Expert User's Guide*.

Programs and services used by the CRSS

The CRSS evaluates the database statistics based on the specified reorganization policy, determines the reorganization need, and evaluates the reorganization effect. The following programs and services are used extensively throughout this process.

DB Sensor

DB Sensor is a component of the CRSS. It collects database statistics data from the database and stores the data as sensor data in the Sensor Data repository of IMS Tools Knowledge Base. Sensor data consists of records made up of data elements. Data elements are used for the purpose of measuring the state of a specific database condition.

Policy Services

Policy Services provides sensor data store and read services, and policy definition and management services. These services are internally used by the CRSS for evaluating database status. Policy Services is a component of IMS Tools Base.

IMS Tools Knowledge Base server and repositories

IMS Tools Knowledge Base server and its services provide the capability to centrally manage various repositories that are used by IMS Tools products. IMS Tools Knowledge Base is a component of IMS Tools Base.

The following repositories are used in a typical conditional reorganization job:

Input repository

This repository is used to store and manage policies, rules, notification lists, and the RECON environment information.

Output repository

This repository is used to store and manage reports that are produced by IMS Tools products.

Sensor Data repository

This repository is used to store the database statistics that are collected by the DB Sensor component of the CRSS.

IMS Tools Knowledge Base report service

The IMS Tools Knowledge Base report service stores the IMS Online Reorganization Facility reports in the Output repository of the IMS Tools Knowledge Base server.

Process flow

The following process flow steps describe how IMS Online Reorganization Facility uses the CRSS in Conditional Reorganization mode:

1. The user submits a conditional reorganization job.
2. IMS Online Reorganization Facility calls the CRSS.
3. The CRSS requests Policy Services to retrieve the reorganization policy, read the latest database statistics, and evaluate the statistics by using the policy. Then, the CRSS returns the evaluation result to IMS Online Reorganization Facility.
4. If database reorganization is recommended by the CRSS, IMS Online Reorganization Facility reorganizes the database. If database reorganization is not recommended by the CRSS, the IMS Online Reorganization Facility process continues with step [“7” on page 22](#).
5. IMS Online Reorganization Facility requests the CRSS to collect database statistics after the reorganized database is started online and to store the statistics in the repository.
6. The CRSS requests Policy Services to evaluate the database statistics of the reorganized database by using the same reorganization policy, and returns the result to IMS Online Reorganization Facility.
7. IMS Online Reorganization Facility requests the IMS Tools Knowledge Base report service to store the database diagnosis report that is generated by the CRSS.

Overview of the batch image copy creation process

IMS Online Reorganization Facility supports creating a batch image copy of a database using the IMAGECOPY command while the database remains online.

The target database of the IMAGECOPY command must be a primary database that is registered as recoverable with DBRC. You cannot create a batch image copy of an index database.

When the target database has external logical relationships, an image copy of only the target database is created by default. If you specify DBALL(Y), image copies of all the primary databases that are connected with logical relationships are created.

Requirements: When you use the IMAGECOPY command, the following conditions must be met:

- IMS High Performance Image Copy load library is included in the STEPLIB concatenation.
- ICEIN control statements are supplied.

Process flow

IMS Online Reorganization Facility performs the batch image copy creation process in several phases.

The phases occur in the following sequence:

1. Verification phase
2. Copy phase
3. Image copy phase
4. Completion phase

Descriptive messages are written to the MSGPRINT log. These messages indicate the start and end of each phase and the progress of the tasks that are being performed.

IMS Online Reorganization Facility makes a copy of the target databases and creates a batch image copy.

The following figure shows the data flow through the phases of IMS Online Reorganization Facility batch image copy creation process.

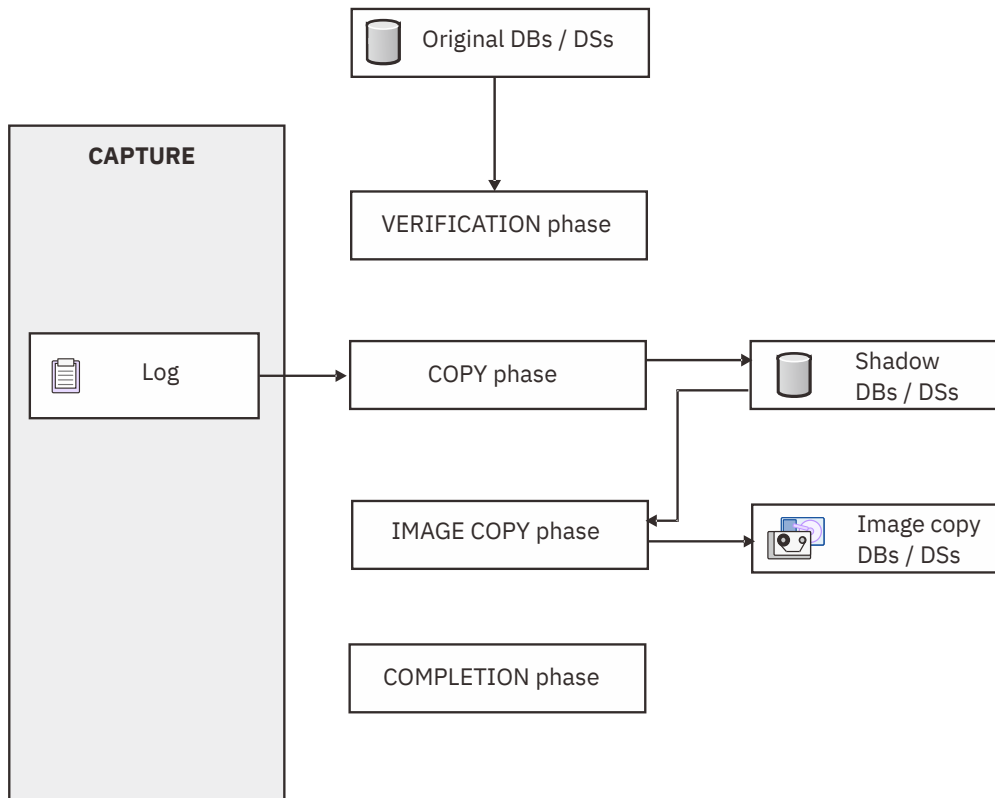

Figure 2. Data flow of the batch image copy creation process

The Verification phase

Perform verifications by referring to the Verification phase in [“Overview of the online reorganization process”](#) on page 17.

The Copy phase

Before the Copy phase begins, the databases are briefly paused to flush the buffers across all IMS subsystems, as described in the Copy phase in [“Overview of the online reorganization process”](#) on page 17.

Similarly, the Copy phase copies only the original primary database to a shadow copy.

Near the end of the Copy phase, another database sync point pause is issued. This sync point pause ensures that all of the changes that were made to the primary database data sets have been applied to the shadow database data sets. During this second brief pause, the following actions occur:

- Any application update calls to the primary database are captured.
- Changes are sent to the IMS Online Reorganization Facility batch utility.
- Changes are made to the shadow primary database.
- A single /DBD command is issued to create a recovery point of the database.

Primary index (for HIDAM or PHIDAM) and secondary indexes are not copied to the shadow data sets.

The Image copy phase

The Image copy phase is the phase to create a batch image copy of a database.

During this phase, the following tasks are performed:

- The shadow databases of the original databases that are registered as recoverable with DBRC are image copied and can be pointer checked.

- An image copy is created and the NOTIFY.IC command is issued for the primary DBD.
- When the database has indexes and its indexes are registered as recoverable with DBRC, the NOTIFY.UIC command is issued for indexes and the index image copies are registered as virtual.

The Completion phase

The Completion phase is the final phase of the batch image copy creation processing.

During this phase, the following cleanup tasks are performed:

- All of the final reports and messages are written.
- Shadow data sets are deleted.
- Data sets are deallocated.
- Miscellaneous cleanup tasks are performed.
- The IMS Online Reorganization Facility batch job ends.

Considerations for database data sets (DBDS) organization conversion and DDEFPS2 DD process

IMS Online Reorganization Facility supports the following DBDS organization conversions:

- OSAM to OSAM LDS
- VSAM to OSAM
- VSAM to OSAM LDS

IMS Online Reorganization Facility provides the following functions to support the conversion:

- DDEFPS2 DD support
- NEWDBD and DDEFPS2 DD combination support

DDEFPS2 DD support

This function is similar to SHADOW(E), except for the following two differences:

- IMS Online Reorganization Facility deletes and defines the shadow data sets before the reload.
- The IDCAMS command to delete and define the shadow data sets is specified with the DDEFPS2 DD statement.

If not all the members of the database data sets are present in the DDEFPS2 data set, IMS Online Reorganization Facility generates IDCAMS commands for the missing database data sets in the Copy phase. In addition, if necessary, IMS Online Reorganization Facility generates IDCAMS commands for the missing database data sets in the reload process.

Procedures to convert OSAM to OSAM LDS

1. Prepare the members of the database data sets in the DDEFPS2 data set. For the data set you want to convert to OSAM LDS, prepare the IDCAMS command for OSAM LDS.
2. Specify the DDEFPS2 DD statement in the IMS Online Reorganization Facility JCL.
3. Run the IMS Online Reorganization Facility job.

Procedures to convert VSAM to OSAM or OSAM LDS

1. Specify the DD name for the NEWDBD keyword that contains the new OSAM DBD to be used.
2. Prepare the members of the database data sets in the DDEFPS2 data set. For the data set you want to convert to OSAM or OSAM LDS, prepare the IDCAMS command for OSAM or OSAM LDS.
3. Specify the NEWDBD keyword in HRFYSIN.

4. Specify the DDEFPS2 DD statement in the IMS Online Reorganization Facility JCL.
5. Run the IMS Online Reorganization Facility job.
6. Databases require manual intervention (copy the new ACBLIB members from the staging ACBLIB to the IMSACBA/IMSACBB and perform an online change) at the end of the reorganization.

Consideration for conversion from OSAM to OSAM LDS

Any OSAM physical sequential data sets that use a block size smaller than 4096 bytes must be changed to a CI size of at least 4096 bytes when converted to OSAM LDS. This can affect current buffer pool definitions and randomization parameters for HDAM databases. Check that the *rbn* parameter times the new CI size does not exceed the OSAM data set maximum of 4 GB or 8 GB.

Considerations for conversion from VSAM to OSAM or OSAM LDS

When the IMS management of ACBs is not enabled:

- When DBDCOPY(Y) is specified, IMS Online Reorganization Facility copies the new DBD to the current DBD library specified with the IMS DD statement.
- IMS Online Reorganization Facility performs an ACBGEN in the staging ACBLIB specified with the IMSACB DD statement to generate a DMB for the new DBD.
- When CATALOG=N and ACBMGMT=ACBLIB are specified, IMS Online Reorganization Facility implements changes to the definition of RECON.
- IMS catalog is not updated. When CATALOG=Y and ACBMGMT=ACBLIB are specified, the IMS catalog must be manually populated after reorganization.
- ONLINECHANGE(N) is required. If ONLINECHANGE(Y) is specified, IMS Online Reorganization Facility ends with errors.
- Databases require manual intervention (copy the new ACBLIB members from the staging ACBLIB to the IMSACBA/IMSACBB and perform an online change) at the end of the reorganization.

When the IMS management of ACBs is enabled, refer to [“Considerations for the IMS management of ACBs”](#) on page 29.

Any OSAM physical sequential data sets that use a block size smaller than 4096 bytes must be changed to a CI size of at least 4096 bytes when converted to OSAM LDS. This can affect current buffer pool definitions and randomization parameters for HDAM databases. Check that the *rbn* parameter times the new CI size does not exceed the OSAM data set maximum of 4 GB or 8 GB.

Restrictions

- Fallback from OSAM LDS to OSAM is not supported.
- Fallback from OSAM LDS or OSAM to VSAM is not supported.

Procedures to fall back offline

You can fall back from OSAM LDS offline.

- Fallback from OSAM LDS to OSAM

For the detailed procedure to convert OSAM to OSAM LDS offline, see the topic "Encrypting full-function OSAM database linear data sets (non-HALDB, or not OLR-capable)" in *IMS System Administration*. Perform the reverse procedure for the fallback.

- Fallback from OSAM LDS to VSAM

For the detailed procedure to change access methods from OSAM to VSAM, see the topic "Changing operating system access methods" in *IMS Database Administration*.

IMS Online Reorganization Facility restrictions

IMS Online Reorganization Facility has the same restrictions as all the other utilities that are used by the reorganization process and some additional restrictions.

Databases that are not supported

IMS Online Reorganization Facility does not support the following databases:

- HSAM and SHSAM databases
- GSAM databases
- Fast Path databases
- HIDAM databases with compressed root keys
- HALDB whose M-V data sets are active
- HALDB databases that have logical relationships and allow the use of a logical path to update logical parent segments



Attention: For HALDB databases that have logical relationships, the following restrictions apply to the insert, delete, and replace rules. The rules are specified by using the RULES= keyword of a SEGM statement in the physical DBD.

- Insert rules L and V are not supported for logical parents. Only the P insert rule is supported.
 - Delete rules L and V are not supported for logical parents. Only the P deletion rule is supported.
 - Replace rule V is not supported for logical parents.
- Databases using PDF
 - Databases and database data sets that are not registered to DBRC
 - Databases that are registered as nonrecoverable with DBRC
 - Uncataloged databases
 - Corrupted databases
 - Multi-volume OSAM databases that are allocated on non-SMS managed volumes
 - Multi-volume OSAM databases that are not created by using the standard DFSMS methods

IMS Online Reorganization Facility cancels the process if it detects any of the online IMS subsystems that shares the same RECON data sets started or stopped during the reorganization process.

Types of database access that are not supported

IMS Online Reorganization Facility does not support the following types of database access during the reorganization process:

- Batch jobs that run as DLI, DBB, or ULU region types and that access the database



Attention: Running outside of DBRC might cause a data integrity exposure. For example, if a DBB or DLIBATCH job is running with DBRC=N, IMS Online Reorganization Facility does not detect it and proceeds with the reorganization. The Takeover phase then attempts to allocate the database data sets as DISP=OLD and fails if the DBB or DLI job is still running. Additionally, if a DBB or DLIBATCH job that runs with DBRC=N finishes before the Takeover phase, those updates are not captured by IMS Online Reorganization Facility because such a job runs as DLI or DBB region type.

- Automatic detection of applications that update the database during the reorganization process by using a PCB that references a logical DBD



Attention: If you have logical DBDs that reference the database that you are reorganizing, use the LOGICALDBD keyword to specify the names of the logical DBDs.

DBD changes that are not allowed

IMS Online Reorganization Facility supports DBD changes for full-function databases and HALDBs. However, IMS Online Reorganization Facility does not allow the following DBD changes:

- DBD name
 - DL/I access method
 - Operating system access method
- Note:** Only the conversion from VSAM to OSAM or OSAM LDS is supported.
- Randomizer name
 - Pointer fields in the segment prefix area
 - Conversion from or to a single secondary index or a shared secondary index
 - Deletion of a secondary index
 - Primary index
 - VSAM control interval size
 - VSAM logical record length
 - DSG structures
 - Deletion of segments
 - Hierarchical structure changes
 - Segment type sequence
 - Segment length
 - Fixed to or from variable length segments
 - Segment sequence key names, offsets, and length
 - Addition of logical relationships
 - Modification or deletion of internal logical relationships
 - HIDAM database root key compression

Use of image copies

IMS Online Reorganization Facility supports creating image copies on tape volumes. However, Database Recovery utility (DFSURDB0), the standard IMS recovery utility, cannot use image copies that are created on tape volumes. To recover a database from image copies on tape volumes, use the IMS Database Recovery Facility of IMS Recovery Solution Pack or the Recovery function of IMS High Performance Image Copy. When you use IMS High Performance Image Copy to recover a database, you must specify TIMECHK=N to prevent the time stamp in the image copy header record from being checked against the time stamp in the DBRC record.

Use of Conditional Reorganization Support Service

When you use IMS Online Reorganization Facility with the Conditional Reorganization Support Service (CRSS), the following restrictions apply:

- The IMS Tools Knowledge Base server and the Policy Services server must be configured and active.
- DBD changes are not allowed in Conditional Reorganization mode or in Reorganization Diagnosis mode.
- For a database that uses VSAM data sets, SHAREOPTIONS (1,3) must not be specified for any of the VSAM data sets of the database.
- When DB Sensor collects sensor data from an online database, the collected data element values might not reflect the latest database condition. For a list of data elements that have the potential of not storing the latest data, see the topic "Considerations for collecting sensor data from a database that is being updated" in the *IMS Database Reorganization Expert User's Guide*.

Databases with external logical relationships

IMS Online Reorganization Facility has the following restrictions that apply to databases that have external logical relationships:

- DBD change is not supported.
- INITIALIZE(Y) keyword is not supported.

Multi-step job

In a multi-step job, any job step that follows the IMS Online Reorganization Facility job step should not statically allocate the database data sets that the IMS Online Reorganization Facility job step reorganized. If static allocation of the database data sets is requested in a subsequent job step, the database data sets will be used exclusively by the job until the job completes (even if DISP=SHR is specified) and online IMS subsystems will not be able to allocate the database data sets.

Considerations for the IMS management of ACBs

When the IMS management of ACBs is enabled, IMS Online Reorganization Facility can refer to database definitions in the IMS catalog directory instead of the DBD library.

IMS catalog definition is retrieved from either:

- The IMS Catalog Definition exit routine (DFS3CDX0) in the STEPLIB concatenation.
- The DFSDFxxx PROCLIB member specified by the DFSDF(xxx) keyword in the HRFSYSIN DD statement and the PROCLIB DD statement.

The following conditions must be satisfied to use IMS-managed ACBs:

- The IMS catalog database must be registered to the RECON data sets
- The name of the IMS catalog database must be defined in the RECON record with the following DBRC command: CHANGE RECON CATALOG(*name*)

The following libraries must be in the STEPLIB concatenation of the IMS Online Reorganization Facility job:

- A library that contains the DFSMDA member of TYPE=CATDSHLQ, if dynamic allocation is used to specify the high-level qualifier of the IMS catalog system data sets
- The load libraries of IMS High Performance utilities with the sufficient maintenance level
- The SGLXLOAD library of IBM IMS Tools Base for z/OS 1.7 or later

If you want to change the database definition in a reorganization job, you can specify the NEWDBD(*STAGING) keyword to have IMS Online Reorganization Facility reload the database using pending database definitions in the IMS catalog staging data sets. The DFSACBPD DD statement is not needed.

The following restrictions apply when reorganizing a database in an IMS-managed ACBs environment:

- LOGICALDBD keyword is not supported because IMS catalog directory does not contain the definitions of logical databases
- ONLINECHANGE(Y) is not supported when changing database definition. Users must manually issue the IMPORT DEFN SOURCE(CATALOG) command to activate pending database definition after the reorganization job.

For details, see [“DBD change when IMS manages ACBs” on page 102](#).

Related reference

DD statements

When you code JCL statements to run IMS Online Reorganization Facility, you must include the appropriate DD statements.

DFSDF keyword

Use this keyword to specify the 3-character suffix of the DFSDfxxx member of the IMS PROCLIB data set that contains the settings and attributes of the IMS catalog.

IMSID keyword

Use this keyword to specify the IMSID parameter.

NEWDBD keyword

Use this keyword to change the DBD during reorganization. When ACB libraries are used, specify the DD name of the DBDLIB that contains the new DBD to be used when reloading the database. You must include this DD name and data set in the JCL and it must contain the primary DBD.

Example: Reorganizing a database in an IMS-managed ACBs environment

The JCL example in this topic does the same reorganization as the example provided in “[Example: Reorganizing a HDAM using dynamic allocation of image copy and log data sets](#)” on page 103. The only difference is that this JCL example is for running the job in an IMS-managed ACBs environment. The JCL does not include IMS DD statement, which describes the DBD library, because IMS Online Reorganization Facility obtains DBDs from IMS catalog.

Example: Changing database definition in an IMS-managed ACBs environment

The JCL example in this topic changes database definition in an IMS-managed ACBs environment.

Considerations for external logical relationships

The following considerations help you reorganize online databases that have external logical relationships.

A group of databases that are connected with logical relationships is called a *logical group*. If the database to be reorganized has external logical relationships, the IMS Online Reorganization Facility job reorganizes all the primary databases in the logical group in a single job step. The number of databases in a logical group must be no more than 14. In order to reorganize multiple databases in parallel, IMS Online Reorganization Facility initiates multiple subordinate address spaces. Each subordinate address space is a started task that executes the subordinate address space procedure named HRFSUB, so this procedure must be placed in your PROCLIB data set before running the reorganization job. For details, see “[Defining the subordinate address space procedure](#)” on page 125.

IMS High Performance Unload and IMS High Performance Load are required if the database has external logical relationships, and IMS Index Builder is additionally required if the database is a HALDB and you specify PSINDEXBLD(Y) in the HRFSYSIN DD statement. The load libraries of those utilities must be included in the STEPLIB concatenations of the IMS Online Reorganization Facility job. The IMS Online Reorganization Facility job passes the entire STEPLIB to the subordinate address spaces so that you do not need to edit the STEPLIB of the HRFSUB started task.

Because the utilities are invoked in subordinate address spaces, reports generated by these utilities are not included in the output of the IMS Online Reorganization Facility job nor stored in the Output repository of the IMS Tools Knowledge Base server.

Use of DFSMSdss in Copy phase

In the Copy phase, IMS Online Reorganization Facility creates shadow data sets of all the primary databases in the logical group by using DFSMSdss regardless of the DFDSS parameter value in the base configuration module. When DFSMSdss is used, the database is stopped while the data sets are copied, so the use of fast replication is highly recommended to reduce downtime. The following HRFSYSIN DD statement keywords are provided to configure the options of the DFSMSdss COPY command in the Copy phase: DFDSS, DFDSS.FASTREP, DFDSS.FCTOPPRCP, DFDSS.FCTOXRCP.

Use of subordinate address spaces

In the Reorganization phase, IMS Online Reorganization Facility executes the unload, reload, and PSINDEX build processes in subordinate address spaces. One address space is created for each database and for each process. The maximum number of subordinate address spaces that are active at a time is the number of databases in the logical group by default and can be limited as needed. If the number

of databases in a logical group exceeds the maximum number, some subordinate address spaces will wait for the termination of other address spaces. The following HRFSYSIN DD statement keywords are provided to configure subordinate address spaces: SASMAX, SASJOBPREF.

Allocation of temporary unload data sets

The unload data sets are dynamically allocated by IMS Online Reorganization Facility before the unload process starts, and deleted after the reload process completes. JCL allocation of unload data sets is not supported when the database has external logical relationships. The following base configuration parameters are provided to configure the allocation of temporary unload data sets: UNLHLQ, UNLSPAC, UNLUNIT.

Prefix resolution and update process for HDAM and HIDAM

To reorganize an HDAM or HIDAM database that has external logical relationships, the prefix resolution and update process must be performed. IMS Online Reorganization Facility invokes the Database Preorganization utility (DFSURPRO) with all the databases in the logical group specified on the DBR utility control statements, and then uses the generated control data set in the subsequent reload process. After the reload process completes, the prefix resolution and update process is done followed by the image copies process.

Considerations for PHDAM and PHIDAM

For PHDAM and PHIDAM databases that have external logical relationships, the prefix resolution and update process is not required.

IMS Online Reorganization Facility processes all databases in the logical group because it allocates shadow data sets of all the databases during the Apply phase. All partitions must be processed in the job as is the case for internal logical relationships. You can use the PSINDEXBLD keyword to select whether the partitioned secondary indexes (PSINDEXes) are built during the reorganization. If you specify PSINDEXBLD(Y), IMS Online Reorganization Facility invokes IMS Index Builder in subordinate address spaces to rebuild all the PSINDEXes of each database in the logical group. If you specify PSINDEXBLD(N), PSINDEXes are reused and the following restrictions apply to the insert, delete, and replace rules of the logical relationships. The rules are specified by using the RULES= keyword of a SEGM statement in the physical DBD.

- Insert rules L and V are not supported for logical parents. Only the P insert rule is supported.
- Delete rules L and V are not supported for logical parents. Only the P deletion rule is supported.
- Replace rule V is not supported for logical parents.

Conditional Reorganization

In the Conditional Reorganization process, only the database that is specified for the DBD keyword is evaluated by the Conditional Reorganization Support Service (CRSS). If the CRSS determines that the specified database needs reorganization, IMS Online Reorganization Facility reorganizes all the databases in the logical group, but DB Sensor collects sensor data only from the specified database and stores it in the Sensor Data repository of IMS Tools Knowledge Base.

Job cancellation

You can cancel a reorganization job by using an MVS™ **CANCEL** command, but the following maintenance will be needed before restarting the job:

- Cancel all the HRFSUBxx started tasks running in the background by using an MVS **CANCEL** command.
- Turn off the REORG INTENT flag for all the involved databases by using a DBRC **CHANGE .DB NOREORGI** command.
- Clean up undeleted temporary data sets as needed.

Functional changes in IMS Database Solution Pack 2.2 IMS Online Reorganization Facility

Major functional enhancements that are made to IMS Online Reorganization Facility in IMS Database Solution Pack 2.2 are summarized in this topic.

- Rebuild PSINDEXes during HALDB reorganization (APAR PI89625). During the reorganization, IMS Online Reorganization Facility can rebuild PSINDEXes. For more information, see [“PSINDEXBLD keyword”](#) on page 85.
- Initialize the database during reorganization (APAR PI90523). During the reorganization, IMS Online Reorganization Facility can initialize (empty out) the database. For more information, see [“INITIALIZE keyword”](#) on page 74.
- Enhancement to the conditional reorganization capability (APAR PI91880). In addition to evaluating the primary database, IMS Online Reorganization Facility can also evaluate secondary indexes to determine the reorganization need. For more information, see [“CR.EVALINDEX keyword”](#) on page 55 and [“Scenario 5: Evaluating secondary indexes and conditionally reorganizing a database”](#) on page 113.
- Support for IMS refreshable exit routines. IMS exit routines can be configured by using IMS refreshable exit routines. For more information, see the topic "Configuring IMS exit routines by using IMS refreshable exit routines" in *IMS Database Solution Pack: Overview and Customization*.
- Allocate GDG data sets as log data sets (APAR PH00388). IMS Online Reorganization Facility can dynamically allocate GDG data sets as log data sets. For more information, see [“LOG1DSN keyword”](#) on page 75.
- Specify whether to allow read-only DL/I batch jobs to access the database (APAR PH04466). Any impacts to DL/I batch jobs that are running during reorganization can be minimized. For more information, see [“READON keyword”](#) on page 86.
- Enhancement to the database unload capability (APAR PH10454). IMS Online Reorganization Facility can unload a database that has logical relationships (including external logical relationships).
- Reorganize encrypted VSAM databases (APAR PH11473). IMS Online Reorganization Facility can reorganize encrypted VSAM databases and dynamically allocate encrypted data sets for image copy and apply log. For more information, see [“KEYLABEL keyword”](#) on page 75.
- Support IMS management of ACBs (APAR PH11847). When the IMS management of ACBs is enabled, IMS Online Reorganization Facility can refer to database definitions in the IMS catalog directory instead of the DBD library. For more information, see [“Considerations for the IMS management of ACBs”](#) on page 29.
- Reorganize databases that have external logical relationships (APAR PH33045). IMS Online Reorganization Facility can initiate multiple subordinate address spaces to process multiple databases in parallel. Each subordinate address space is a started task that executes the subordinate address space procedure named HRFSUB. For more information, see [“Considerations for external logical relationships”](#) on page 30 and [“Defining the subordinate address space procedure”](#) on page 125.

Service updates and support information

Service updates and support information for this product, including software fix packs, PTFs, frequently asked questions (FAQs), technical notes, troubleshooting information, and downloads, are available from the web.

To find service updates and support information, see the following website:

[IBM Support: IMS Database Solution Pack for z/OS](#)

Product documentation and updates

IMS Tools information is available at multiple places on the web. You can receive updates to IMS Tools information automatically by registering with the IBM My Notifications service.

Information on the web

Always refer to the IMS Tools Product Documentation web page for complete product documentation resources:

<https://www.ibm.com/support/pages/node/712955>

The IMS Tools Product Documentation web page includes:

- Links to [IBM Documentation](#) for the user guides ("HTML")
- PDF versions of the user guides ("PDF")
- Program Directories for IMS Tools products
- Technical notes from IBM Software Support, referred to as "Tech notes"
- White papers that describe product business scenarios and solutions

IBM Redbooks® publications that cover IMS Tools are available from the following web page:

<http://www.redbooks.ibm.com>

The IBM Information Management System website shows how IT organizations can maximize their investment in IMS databases while staying ahead of today's top data management challenges:

<https://www.ibm.com/software/data/ims>

Receiving documentation updates automatically

To automatically receive automated emails that notify you when new technote documents are released, when existing product documentation is updated, and when new product documentation is available, you can register with the IBM My Notifications service. You can customize the service so that you receive information about only those IBM products that you specify.

To register with the My Notifications service:

1. Go to <https://www.ibm.com/support/mynotifications>
2. Enter your IBM ID and password, or create one by clicking **register now**.
3. When the My Notifications page is displayed, click **Subscribe** to select those products that you want to receive information updates about. The IMS Tools option is located under **Software > Information Management**.
4. Click **Continue** to specify the types of updates that you want to receive.
5. Click **Submit** to save your profile.

How to send your comments

Your feedback is important in helping us provide the most accurate and highest quality information. If you have any comments about this or any other IMS Tools information, see [How to provide feedback in IBM Documentation](#).

When you provide feedback, include as much information as you can about the content you are commenting on, where we can find it, and what your suggestions for improvement might be.

Accessibility features

Accessibility features help a user who has a physical disability, such as restricted mobility or limited vision, to use a software product successfully.

The major accessibility features in IMS Online Reorganization Facility enable users to perform the following activities:

- Use assistive technologies such as screen readers and screen magnifier software. Consult the assistive technology documentation for specific information when using it to access z/OS interfaces.
- Customize display attributes such as color, contrast, and font size.
- Operate specific or equivalent features by using only the keyboard. Refer to the following publications for information about accessing ISPF interfaces:
 - *z/OS ISPF User's Guide, Volume 1*
 - *z/OS TSO/E Primer*
 - *z/OS TSO/E User's Guide*

These publications describe how to use the ISPF interface, including the use of keyboard shortcuts or function keys (PF keys), include the default settings for the PF keys, and explain how to modify their functions.

Chapter 2. Using IMS Online Reorganization Facility

To use the IMS Online Reorganization Facility to reorganize, unload, or create a batch image copy of a database, create a JCL job that contains the appropriate DD statements and run the job.

Topics:

- [“Running IMS Online Reorganization Facility” on page 35](#)
- [“EXEC statements” on page 35](#)
- [“DD statements” on page 36](#)
- [“HRFSYSIN DD statement” on page 46](#)
- [“Takeover restart processing” on page 100](#)
- [“DBD change during reorganization” on page 100](#)
- [“Scheduling online reorganization jobs with Autonomics Director” on page 102](#)
- [“Examples for IMS Online Reorganization Facility” on page 103](#)

Running IMS Online Reorganization Facility

IMS Online Reorganization Facility runs the reorganization and unload as a standard z/OS batch job. You need to specify an EXEC statement and DD statements that define the input and output data sets in your JCL.

Before you begin

Ensure that all databases to be processed by IMS Online Reorganization Facility are registered with DBRC and that primary databases are recoverable with DBRC.

Procedure

To reorganize, unload, or create a batch image copy of a database:

1. Create a JCL job that contains the appropriate elements.
2. Specify the EXEC statement.

For the format of the EXEC statement, see [“EXEC statements” on page 35](#).

3. Specify the DD statements to define input data sets and output data sets.

For a list of DD statements, see [“DD statements” on page 36](#).

The reorganization, unload, or batch image copy creation of a database is invoked by the REORG, UNLOAD, and IMAGECOPY commands in the HRFSYSIN DD statement. For the format of the HRFSYSIN DD statement, see [“HRFSYSIN DD statement syntax” on page 46](#).

4. Specify the HRFSYSIN DD statement keywords.

For the HRFSYSIN DD statement keywords, see [“HRFSYSIN DD statement keywords” on page 47](#).

5. Run the JCL job.

EXEC statements

When you code JCL statements to run IMS Online Reorganization Facility, you must include the EXEC statement.

The EXEC statement for IMS Online Reorganization Facility is in the following format:

```
//stepname EXEC PGM=HRFREORG, REGION=TRRM,  
// PARM='DBD(dbdname)'
```

Specify HRFREORG as the program name. Ensure that sufficient region size is specified on the REGION parameter.

You can specify the following optional keywords on the PARM parameter:

DBD

Specifies the primary database to reorganize. The DBD keyword can be specified either on the EXEC statement as a z/OS parameter string or in the HRFSYSIN DD statement. If you specify this keyword on the EXEC statement, the DBD keyword in the HRFSYSIN DD statement must be specified as DBD(&PARM).

For more information, see [“DBD keyword” on page 60](#).

PARTITION

Specifies the name of the HALDB partition to reorganize. The PARTITION keyword can be specified either on the EXEC statement as a z/OS parameter string or in the HRFSYSIN DD statement. If you specify this keyword on the EXEC statement, the PARTITION keyword in the HRFSYSIN DD statement must be specified as PARTITION(&PARM2).

For more information, see [“PARTITION keyword” on page 80](#).

Tip: By specifying these keywords on the EXEC statement, you can use a common HRFSYSIN DD statement that can be used across multiple databases.

For example, if you want to use a common HRFSYSIN DD statement between HALDB databases and full-function databases, specify the following EXEC parameters:

- When processing a full-function database:
PARM= ' DBD(*dbdname*) , PARTITION(*) '
- When processing an entire HALDB database:
PARM= ' DBD(*master_dbdname*) , PARTITION(*) '
- When processing a single HALDB partition:
PARM= ' DBD(*master_dbdname*) , PARTITION(*partname*) '

In these cases, specify the DBD and PARTITION keywords on the HRFSYSIN DD statement as DBD(&PARM) and PARTITION(&PARM2).

DD statements

When you code JCL statements to run IMS Online Reorganization Facility, you must include the appropriate DD statements.

DD statements determine the input and output data sets and specify how to run the functions. The DD statements that you need depend on the type of job that you want to run (UNLOAD, REORG or IMAGECOPY) and other characteristics of your environment.

Your database data set names must be a total of 42 characters in length or less.

The following table summarizes the DD statements that you can specify for the IMS Online Reorganization Facility jobs.

Table 3. DD statements

DD statement	REORG command	UNLOAD command	IMAGECOPY command
BBEJRNL	Optional	Not applicable	Not applicable
BBERPRT	Optional	Not applicable	Not applicable
BSNJM01	Optional	Not applicable	Not applicable
DDEFPS2	Optional	Not applicable	Not applicable
DFSPRINT	Optional	Not applicable	Optional
DFSRESLB	Optional	Optional	Optional

Table 3. DD statements (continued)

DD statement	REORG command	UNLOAD command	IMAGECOPY command
DFSUINPT	Conditionally required	Conditionally required	Not applicable
DFSURGU1	Conditionally required	Conditionally required	Not applicable
DFSURWF1	Optional	Not applicable	Not applicable
HRFSYSIN	Required	Required	Required
ICEPRINT	Optional	Not applicable	Optional
IEFRDER	Optional	Not applicable	Not applicable
IEFRDER2	Optional	Not applicable	Not applicable
<i>imagecopy_ddname</i>	Conditionally required	Not applicable	Conditionally required
IMS	Conditionally required	Conditionally required	Conditionally required
IMSACB	Conditionally required	Not applicable	Not applicable
IMSACBA	Conditionally required	Not applicable	Not applicable
IMSACBB	Conditionally required	Not applicable	Not applicable
IMSDALIB	Optional	Optional	Optional
MSGPRINT	Optional	Optional	Optional
<i>newdbd</i>	Conditionally required	Not applicable	Not applicable
PROCLIB	Optional	Optional	Optional
RECON1-3	Optional	Optional	Optional
STEPLIB	Required	Required	Required
SYSPRINT	Optional	Optional	Optional
SYSUDUMP	Optional	Optional	Optional
TRACE	Optional	Optional	Optional

The following list summarizes the DD statements that are used by IMS Online Reorganization Facility.

BBEJRN

This statement is optional for the REORG command. The statement is effective only when you use the Conditional Reorganization Support Service (CRSS). The statement defines the data set for the journal messages that the DB Analyzer and the DB Sensor components of the CRSS issue. The journal messages show the processing information for the DB Analyzer and DB Sensor component, and they can be used for problem determination.

To print the journal messages in the BBEJRN data set, you must specify CR.JOURNAL(Y). IMS Online Reorganization Facility dynamically allocates this DD statement as necessary if you do not provide it. For information about allocating the BBEJRN data set, see the topic "BBEJRN data set" in the *IMS Database Reorganization Expert User's Guide*.

Role

Output

Format

RECFM=FA or FBA, LRECL=133

BBERPRT

This statement is optional for the REORG command. The statement is effective only when you use the Conditional Reorganization Support Service (CRSS). The statement defines the data set for the Diagnosis report that the CRSS generates.

The Diagnosis report is not printed in the BBERPRT data set when CR.PRINTRPRT(N) is specified. IMS Online Reorganization Facility dynamically allocates this DD statement as necessary if you do not provide it. For information about allocating the BBERPRT data set, see the topic "BBERPRT data set: Diagnosis report" in the *IMS Database Reorganization Expert User's Guide*.

Role

Output

Format

RECFM=FA or FBA, LRECL=81

BSNJM01

This statement is optional for the REORG command. The statement is effective only when you use the Conditional Reorganization Support Service (CRSS). The statement defines the data set for the journal messages that Policy Services generates. These messages describe the processing and the policy. If a warning situation or an error occurs while the Policy Services components are in process, one or more warning or error messages are issued as journal messages. You can use the journal messages to identify the cause of the errors.

To print the journal messages in the BSNJM01 data set, you must specify CR.JOURNAL(Y). IMS Online Reorganization Facility dynamically allocates this DD statement as necessary if you do not provide it. For information about allocating the BSNJM01 data set, see the topic "Journal report overview" in the *IMS Tools Base Policy Services User's Guide and Reference*.

Role

Output

Format

RECFM=FA or FBA, LRECL=133

DDEFPS2

When the DDEFPS2 DD statement is specified, IMS Online Reorganization Facility redefines the shadow data sets before reloading the database.

If IMS Online Reorganization Facility does not reorganize the database, the DDEFPS2 DD statement is ignored.

When the DDEFPS2 DD statement is specified, the following keywords in HRFSETOP or HRFSYSIN are effective for the specified members only in the Copy phase:

- VOLPOOL and UNITPOOL keywords in HRFSETOP
- SHADOW keyword in HRFSYSIN
- VOLALLO keyword in HRFSYSIN

The name of each PDS member must be the same as the DD name of the original data set.

If not all the members of the database data sets are present in the DDEFPS2 data set, IMS Online Reorganization Facility, if necessary, generates IDCAMS commands for the missing database data sets.

For the secondary indexes, the members are processed for non-HALDB data sets when the members are present in the DDEFPS2 data set. For HALDB data sets, the members are processed only when PSINDEXBLD(Y) is specified even when the members are present in the DDEFPS2 data set.

The names of shadow data sets defined in the DDEFPS2 DD statement must be in the form of IMS Online Reorganization Facility shadow data set (.S data sets) name:

- non-HALDB: original dbds name + C'S' (*your.dbds.S*)
- HALDB: If the original dbds name is *your_partition.A00001*, add C'S' between *your_partition* and A00001. (*your_partition.S.A00001*)

The following example shows the IDCAMS control statements specified in a PDS member.

Example

```
DELETE (your_partition.S.A00001)
SET MAXCC=0
DEFINE CLUSTER(NAME(your_partition.S.A00001)...)
OR
ALLOCATE DSNAME('your_partition.S.A00001')...
```

- Specify the DELETE command first, and then specify the DEFINE CLUSTER or ALLOCATE command. You do not have to specify SET MAXCC=0.
- Format of the ALLOCATE command that can be specified:
 - Standard format
 - ALLOCATE DATASET('dsname')
 - ALLOCATE DSNAME('dsname')
 - ALLOCATE DSN('dsname')
 - ALLOCATE DA('dsname')
 - Abbreviated format
 - ALLOC DATASET('dsname')
 - ALLOC DSNAME('dsname')
 - ALLOC DSN('dsname')
 - ALLOC DA('dsname')
 - **Note:** Data set names must be enclosed in quotation marks.
- Format of the DEFINE CLUSTER command that can be specified:
 - Standard format
 - DEFINE CLUSTER (NAME(dsname))
 - Abbreviated format
 - DEFINE CL (NAME(dsname))
 - DEF CLUSTER (NAME(dsname))
 - DEF CL (NAME(dsname))
- Format of the DELETE command that can be specified:
 - Standard format
 - DELETE (dsname)
 - DELETE dsname
 - Abbreviated format
 - DEL (dsname)
 - DEL dsname
 - **Note:** Mask characters (asterisks) cannot be used for the data set names.
- Comment lines
 - Lines that start with /* and end with */ are treated as block comments.
- Continuation lines
 - Lines with '-' or '+' are treated as continuation lines.

- Data set names specified in the IDCAMS command are checked in the Verification phase.
 - If the data set name specified in the DELETE command and the DEFINE CLUSTER or ALLOCATE command is different, IMS Online Reorganization Facility issues a message "HRF01000E Data set name in DELETE and ALLOCATE or DEFINE CLUSTER command is different".
 - If the shadow data set name specified in the DEFINE CLUSTER or ALLOCATE command is not the same as the old shadow data set name, IMS Online Reorganization Facility issues a message HRF01645E.
 - If the data set name specified in the IDCAMS command is the same as the original data set name, IMS Online Reorganization Facility issues a message HRF01644E.

It is the user's responsibility to provide a data set of a sufficient size (same as SHADOW(E)).

Role

Input

Format

A partitioned data set (PDS) or a partitioned data set extended (PDSE) with a member name with LRECL=80 and RECFM=FB

DFSPRINT

This statement is optional for the REORG and IMAGECOPY commands. The statement defines a print file for IMS High Performance Image Copy. The data set can reside on DASD, or it can be routed through the output job.

IMS Online Reorganization Facility dynamically allocates this DD statement if you do not provide it.

Role

Output

Format

LRECL=122

DFSRESLB

This statement is optional for the REORG, UNLOAD, and IMAGECOPY commands. The statement points to an authorized library that contains IMS SVC modules.

IMS Online Reorganization Facility dynamically allocates this DD if you do not provide it.

Role

Input

Format

RECFM=U

DFSUINPT

This statement is required by the UNLOAD command if you use IMS High Performance Unload. The statement is required by the REORG command if you want a copy of the HD unload file. The statement describes a repository for the unloaded data that consists of HD unload records.

For the REORG command, if you do not specify this statement, IMS Online Reorganization Facility dynamically allocates a temporary unload data set and deletes it at the end of the job. Use this statement if you want to keep a copy of the HD unload file or override the dynamic allocation of the temporary data set. If you override dynamic allocation, you must supply sufficient space parameters to avoid out-of-space conditions.

If the database that is specified in the DBD keyword has external logical relationships, this statement is ignored.

Role

Output

Format

RECFM=VB

DFSURGU1

This statement is required by the UNLOAD command if you use the standard IMS unload utility (DFSURGU0). This statement is required by the REORG command if you use the standard IMS unload utility. The statement describes a repository for the unloaded data that consists of HD unload records.

Role

Output

Format

RECFM=VB

DFSURWF1

Important: This DD statement is not recommended because IMS Online Reorganization Facility creates the data set dynamically.

This statement is optional for the REORG command. The statement overrides the dynamic allocation of the data set that contains only logical relationship records and no secondary index records. Use this statement if logical relationships exist and you want a copy of the WF1 file for processing after the IMS Online Reorganization Facility job step. This data set is for logical relationship records that Prefix Resolution or Update require.

Role

Output / Input

Format

RECFM=VB, LRECL=900

HRFSYSIN

This statement is required by the REORG, UNLOAD, and IMAGECOPY commands. The statement defines a control statement or data set that contains control statements that specify the functions of IMS Online Reorganization Facility.

For more information about the format of HRFSYSIN DD statements, see [“HRFSYSIN DD statement”](#) on page 46.

Role

Input

Format

LRECL=80

Free form. You do not need to code each keyword on a separate line, and each line can begin in any column from 1 to 71.

ICEPRINT

This statement is optional for the REORG and IMAGECOPY commands. The statement defines the SYSOUT output data set and output from the IMS High Performance Image Copy reports that IMS Online Reorganization Facility generates. This data set can reside on DASD, or it can be routed through the output job.

IMS Online Reorganization Facility dynamically allocates this data set if you do not provide the DD statement.

Role

Output

Format

LRECL=133

IEFRDER

This statement is optional for the REORG command. The statement describes the log data set that IMS Online Reorganization Facility uses during the Apply phase. This data set must reside on DASD. If changes are captured during the reorganization process, these log data sets are registered to DBRC as batch logs. The batch logs are needed in a recovery situation.

Instead of using this DD statement, you can use dynamic allocation for the log data sets. To use the dynamic allocation for the IMS logs, see [“LOG1DSN keyword” on page 75](#), [“LOG2DSN keyword” on page 76](#), [“LOGPRI keyword” on page 77](#), and [“LOGSEC keyword” on page 77](#).

If you specified RESTART(AUTOMATIC) and IEFRDER DD with DISP=(,CATLG,DELETE) as described in some examples in the IMS Online Reorganization Facility documentation, you must change this DD statement to DISP=OLD after the previous online reorganization job for a specific database (DBD name or partition name) failed during the Takeover phase.

Role

Output

Format

RECFM=VB

IEFRDER2

This statement is optional for the REORG command. Instead of using this DD statement, you can use dynamic allocation for the log data sets. The statement describes the secondary copy of the IEFRDER log data set. This data set must reside on DASD. If changes are captured during the Online Reorganization process, these log data sets are registered to DBRC as batch logs that are needed in a recovery situation.

If you specified RESTART(AUTOMATIC) and IEFRDER2 DD with DISP=(,CATLG,DELETE), you must change this DD statement to DISP=OLD after the previous online reorganization job for a specific database (DBD name or partition name) failed during the Takeover phase.

Role

Output

Format

RECFM=VB

imagecopy_ddname

This statement is required for the REORG command if you specified the ICDYN(N) or ICDDN keywords, which indicate that the image copy data sets are not dynamically allocated. This statement specifies the output image copy data set for each database data set being reorganized. This DD statement must correlate to the ICDDN keyword that you specified. Specify one DD statement for each image copy DDN that is specified on the ICDDN keyword. This DDNAME overrides any dynamic allocation for this data set.

This statement is optional for the IMAGECOPY command, based on the options in the ICEIN DD statement.

Role

Output

Format

RECORD=FB or VBS

IMS

This statement is required for the REORG, UNLOAD, and IMAGECOPY commands if the IMS management of ACBs is not enabled. The statement describes the library that contains the DBDs of the database that you are reorganizing and its indexes. If you specified the NEWDBD statement, this file must also describe the library that contains the PSBs that reference the database that you are reorganizing. This data set must reside on DASD. When the IMS management of ACBs is enabled, IMS Online Reorganization Facility ignores the IMS DD statement.

Role

Input

Format

RECFM=U

IMSACB

This statement is required for the REORG command if you specified the NEWDBD keyword and the IMS management of ACBs is not enabled. The statement describes the staging ACBLIB where IMS Online Reorganization Facility generates the new ACBs for the changed DBDs. When the IMS management of ACBs is enabled, IMS Online Reorganization Facility ignores the IMSACB DD statement.

Role

Output

Format

RECFM=U

IMSACBA

IMSACBB

These statements are required for the REORG command if you specified ONLINECHANGE(Y). The statements describe the active and inactive ACBLIBs to which IMS Online Reorganization Facility copies the new DMB-type ACB members. These data sets must reside on DASD.

If you use dynamic allocation for IMSACBA and IMSACBB for the online system, you must include these DD statements in the JCL. IMS Online Reorganization Facility extracts the dsnames of A and B from the online system. When the IMS management of ACBs is enabled, IMS Online Reorganization Facility ignores IMSACBA and IMSACBB DD statements.

Role

Output

Format

RECFM=U

MSGPRINT

This statement is optional for the REORG, UNLOAD and IMAGECOPY commands. The statement defines the IMS Online Reorganization Facility output data set. The data set can reside on DASD, or it can be routed through the output job. The data set contains all the progress messages that are associated with the reorganization, in the order of execution.

IMS Online Reorganization Facility dynamically allocates this data set if you do not provide this DD statement.

Role

Output

Format

LRECL=133

newdbd

If you requested a DBD change for the REORG command and the IMS management of ACBs is not enabled, this statement is required. The DDNAME of this statement must match the name you specify for the NEWDBD keyword. The statement describes the library to use when you request a DBD change. If you specify this DD statement, this library data set must reside on DASD and contain all DBDs for the associated databases that are being reorganized. When the IMS management of ACBs is enabled, IMS Online Reorganization Facility ignores this DD statement.

To invoke the physical sequential sort before reloading any data in the Reload step, you must specify RELOAD.SORT(Y).

If the DBD is an HDAM, the new DBD changes might change the randomized sequence of the database records. When the randomized sequence changes, physical sequence must be sorted.

If IMS Library Integrity Utilities is installed, the new DBD is updated in IMS Library Integrity Utilities. Use the “[IMSID keyword](#)” on [page 73](#) to specify the IMSID parameter that IMS Library Integrity Utilities uses. The IMS Library Integrity Utilities library must be made available to activate this function.

Role

Input

Format

RECFM=U

PROCLIB

This statement is optional for the REORG, UNLOAD, and IMAGECOPY commands. The statement points to the IMS.PROCLIB data set. If the DFSDF(*ddd*) keyword is specified in the HRFSYSIN DD statement, you must specify this DD statement and ensure that the DFSDF*ddd* member exists in the IMS.PROCLIB data set.

Role

Input

Format

RECFM=FB, LRECL=80

RECON1-3

This statement is optional for the REORG, UNLOAD, and IMAGECOPY commands. The statement defines the database recovery control (DBRC) RECON data sets. RECON data sets dictate which databases and IMS online systems to use during the reorganization.



Attention: If you specify IMSDALIB DD dynamic allocation, do not use these RECON DD statements.

If you used JCL to allocate RECON1 as a spare data set, you must restart the database.

Role

Input | Output

Format

KSDS

STEPLIB

This statement is required in all IMS Online Reorganization Facility jobs and must always be APF-authorized, even if a DFSRESLB DD statement is provided. The statement points to two or more authorized library data sets. Authorized library data sets include:

- IMS Online Reorganization Facility load library

- IMS Utilities that are available for IMS Online Reorganization Facility
- IMS RESLIB library
- Any other libraries

The libraries can appear in any order.

```
//STEPLIB DD DISP=SHR,DSN=hrfload
// DD DISP=SHR,DSN=imstools
// DD DISP=SHR,DSN=reslib
```

where:

- *hrfload* is the name of the library that contains the IMS Online Reorganization Facility load modules.
- *imstools* is the optional name of the library that contains the IMS reorganization utilities load modules.
- *reslib* is the name of the library that contains the IMS load modules.

If you do not specify an IMSDALIB DD statement in the JCL, you must specify the MDALIB in the STEPLIB for dynamic allocation purposes.

Role

Input

Format

RECFM=U

SYSPRINT

This statement is optional for the REORG, UNLOAD, and IMAGECOPY commands. The statement defines the statistics output data set and output from other utilities that are executed under the control of IMS Online Reorganization Facility. The data set can reside on DASD, or it can be routed through the output job.

IMS Online Reorganization Facility dynamically allocates this data set if you do not provide it.

Role

Output

Format

LRECL=133

SYSUDUMP

This statement is required only if a dump is requested by IBM Software Support. The statement defines a dump data set. If the IMS Online Reorganization Facility detects an error and ends with a U999 abend, this dump is not necessary. However, if any other system or user abend occurs, this data set might be required for problem diagnosis. This data set can reside on DASD, or it can be routed through the output job.

Role

Output

Format

LRECL=133

TRACE

This statement is optional for the REORG, UNLOAD, and IMAGECOPY commands. The statement defines the output data set that IMS Online Reorganization Facility uses to write diagnostic trace records. This data set might be required for problem diagnosis. This data set can reside on DASD, or it can be routed through the output job.

If you do not provide this DD statement, it is dynamically allocated to SYSOUT by IMS Online Reorganization Facility.

Role

Output

Format

LRECL=133

HRFSYSIN DD statement

The HRFSYSIN DD statement is a required DD statement that defines a control statement or data set that contains the control statements that specify the functions of IMS Online Reorganization Facility.

HRFSYSIN DD statement syntax

The control statement you specify on the HRFSYSIN DD statement must conform to the following syntax rules.

When you code the HRFSYSIN DD statement:

- You must begin the HRFSYSIN DD statement with either the REORG, UNLOAD, or IMAGECOPY command.

Use the REORG command to perform the entire reorganization process. For example:

```
//HRFSYSIN DD *  
REORG DBD(HIOPR1)
```

Use the UNLOAD command to create only an unload file of a database. For example:

```
//HRFSYSIN DD *  
UNLOAD DBD(HIOPR1)
```

Use the IMAGECOPY command to create a batch image copy of a database data sets or HALDB partitions. For example:

```
//HRFSYSIN DD *  
IMAGECOPY DBD(HIOPR1)
```

- The input control HRFSYSIN DD statement contains one command and one or more keywords, many of which have sufficient default values.

The HRFSYSIN DD statement is free form. That is, you do not need to code each keyword on a separate line, and each line can begin in any column from 1 to 71.

- To continue any line to the next line, include a comma after a keyword, followed by a blank and a hyphen. For example:

```
REORG DBD(HALDB0) PARTITION(HALPART0) -  
ICDDN((HALDD0A, ICPRT0))
```

- To continue a line in the middle of a keyword subparameter list, do not separate the first subparameter value that is contained within a set of parentheses. Always code the first subparameter value on the first line, then insert the line continuation. For example:

```
ICDDN((HALDD1A, -  
ICPRT1))
```

The following example shows an incorrectly formatted continuation:

```
ICDDN(( -  
HALDD1A, ICPRT1))
```

HRFSYSIN DD statement keywords

HRFSYSIN DD statement keywords control the behavior of the IMS Online Reorganization Facility reorganization and unload jobs.

The following table summarizes the HRFSYSIN DD statement keywords that you can specify for IMS Online Reorganization Facility jobs.

Table 4. HRFSYSIN DD statement keywords

Keyword	REORG HRFSYSIN DD	UNLOAD HRFSYSIN DD	IMAGECOPY HRFSYSIN DD	Link to topic
ADDBGRP	Optional	Not applicable	Not applicable	“ADDBGRP keyword” on page 52
ADXCGRP	Optional	Not applicable	Not applicable	“ADXCGRP keyword” on page 53
COMPAUTH	Optional	Optional	Not applicable	“COMPAUTH keyword” on page 53
CONDREORG	Optional	Not applicable	Not applicable	“CONDREORG keyword” on page 53
CR.DIAGDATAFROM	Optional	Not applicable	Not applicable	“CR.DIAGDATAFROM keyword” on page 54
CR.EVALINDEX	Optional	Not applicable	Not applicable	“CR.EVALINDEX keyword” on page 55
CR.IC	Optional	Not applicable	Not applicable	“CR.IC keyword” on page 55
CR.JOURNAL	Optional	Not applicable	Not applicable	“CR.JOURNAL keyword” on page 56
CR.POLICYBY	Optional	Not applicable	Not applicable	“CR.POLICYBY keyword” on page 56
CR.POLICYNM	Optional	Not applicable	Not applicable	“CR.POLICYNM keyword” on page 57
CR.PRINTRPRT	Optional	Not applicable	Not applicable	“CR.PRINTRPRT keyword” on page 57
CR.SENSOR_HOME	Optional	Not applicable	Not applicable	“CR.SENSOR_HOME keyword” on page 58
CR.STORERPRT	Optional	Not applicable	Not applicable	“CR.STORERPRT keyword” on page 58
CR.UNLOAD	Optional	Not applicable	Not applicable	“CR.UNLOAD keyword” on page 59
DATACLAS	Optional	Not applicable	Not applicable	“DATACLAS keyword” on page 59
DBALL	Not applicable	Not applicable	Optional	“DBALL keyword” on page 59
DBD	Required	Required	Required	“DBD keyword” on page 60
DBDCOPY	Optional	Not applicable	Not applicable	“DBDCOPY keyword” on page 60

Table 4. HRFSYSIN DD statement keywords (continued)

Keyword	REORG HRFSYSIN DD	UNLOAD HRFSYSIN DD	IMAGECOPY HRFSYSIN DD	Link to topic
DBDLIST	Optional	Not applicable	Not applicable	“DBDLIST keyword” on page 61
DBSTART	Optional	Not applicable	Not applicable	“DBSTART keyword” on page 61
DELETE	Optional	Not applicable	Not applicable	“DELETE keyword” on page 61
DFDSS	Optional	Optional	Optional	“DFDSS keyword” on page 62
DFDSS.FASTREP	Optional	Optional	Optional	“DFDSS.FASTREP keyword” on page 62
DFDSS.FCTOPPRCP	Optional	Optional	Optional	“DFDSS.FCTOPPRCP keyword” on page 63
DFDSS.FCTOXRCP	Optional	Optional	Optional	“DFDSS.FCTOXRCP keyword” on page 63
DFSDF	Optional	Optional	Optional	“DFSDF keyword” on page 64
FEOV	Optional	Not applicable	Not applicable	“FEOV keyword” on page 64
GDGLIMIT	Optional	Not applicable	Not applicable	“GDGLIMIT keyword” on page 64
GDGMODEL	Optional	Not applicable	Not applicable	“GDGMODEL keyword” on page 65
IC.COMP	Optional	Not applicable	Not applicable	“IC.COMP keyword” on page 65
IC.COMPRTN	Optional	Not applicable	Not applicable	“IC.COMPRTN keyword” on page 66
ICDDN	Optional	Not applicable	Not applicable	“ICDDN keyword” on page 66
ICDYN	Optional	Not applicable	Not applicable	“ICDYN keyword” on page 67
IC1DSN	Optional	Not applicable	Not applicable	“IC1DSN keyword” on page 67
IC2DSN	Optional	Not applicable	Not applicable	“IC2DSN keyword” on page 68
ICEIN	Optional	Not applicable	Optional	“ICEIN keyword” on page 68
ICHLQ	Optional	Not applicable	Not applicable	“ICHLQ keyword” on page 69
ICID	Optional	Not applicable	Not applicable	“ICID keyword” on page 69

Table 4. HRFSYSIN DD statement keywords (continued)

Keyword	REORG HRFSYSIN DD	UNLOAD HRFSYSIN DD	IMAGECOPY HRFSYSIN DD	Link to topic
ICMID	Optional	Not applicable	Not applicable	“ICMID keyword” on page 69
ICNUM	Optional	Not applicable	Not applicable	“ICNUM keyword” on page 70
ICTRLR	Optional	Not applicable	Not applicable	“ICTRLR keyword” on page 70
IC.VIC	Optional	Not applicable	Not applicable	“IC.VIC keyword” on page 71
IC.VICDSN	Optional	Not applicable	Not applicable	“IC.VICDSN keyword” on page 71
ICVOLCT	Optional	Not applicable	Not applicable	“ICVOLCT keyword” on page 72
IDXBLD.MAXTASKS	Optional	Not applicable	Not applicable	“IDXBLD.MAXTASKS keyword” on page 72
IDXBLD.SIDXBUF	Optional	Not applicable	Not applicable	“IDXBLD.SIDXBUF keyword” on page 72
IDXBLD.SORTFSZ	Optional	Not applicable	Not applicable	“IDXBLD.SORTFSZ keyword” on page 73
IMSID	Optional	Optional	Optional	“IMSID keyword” on page 73
INITIALIZE	Optional	Not applicable	Not applicable	“INITIALIZE keyword” on page 74
ITKBDATA	Optional	Not applicable	Not applicable	“ITKBDATA keyword” on page 74
ITKBSERVER	Optional	Optional	Optional	“ITKBSERVER keyword” on page 75
KEYLABEL	Optional	Not applicable	Not applicable	“KEYLABEL keyword” on page 75
LOG1DSN	Optional	Not applicable	Not applicable	“LOG1DSN keyword” on page 75
LOG2DSN	Optional	Not applicable	Not applicable	“LOG2DSN keyword” on page 76
LOGICALDBD	Optional	Not applicable	Not applicable	“LOGICALDBD keyword” on page 77
LOGPRI	Optional	Not applicable	Not applicable	“LOGPRI keyword” on page 77
LOGSEC	Optional	Not applicable	Not applicable	“LOGSEC keyword” on page 77
MGMTCLAS	Optional	Not applicable	Not applicable	“MGMTCLAS keyword” on page 78

Table 4. HRFSYSIN DD statement keywords (continued)

Keyword	REORG HRFSYSIN DD	UNLOAD HRFSYSIN DD	IMAGECOPY HRFSYSIN DD	Link to topic
MONITOR	Optional	Optional	Optional	“MONITOR keyword” on page 78
NEWDBD	Optional	Not applicable	Not applicable	“NEWDBD keyword” on page 78
ONLINECHANGE	Optional	Not applicable	Not applicable	“ONLINECHANGE keyword” on page 79
OPTID	Optional	Optional	Optional	“OPTID keyword” on page 79
PARTITION	Optional	Optional	Optional	“PARTITION keyword” on page 80
PARTLIST	Optional	Optional	Optional	“PARTLIST keyword” on page 80
PARTNUM	Optional	Optional	Optional	“PARTNUM keyword” on page 81
PRERES.ALLOWLC	Optional	Not applicable	Not applicable	“PRERES.ALLOWLC keyword” on page 81
PRERES.ALLOWLP	Optional	Not applicable	Not applicable	“PRERES.ALLOWLP keyword” on page 82
PRERES.AVGRLLEN	Optional	Not applicable	Not applicable	“PRERES.AVGRLLEN keyword” on page 82
PRERES.FILSZ	Optional	Not applicable	Not applicable	“PRERES.FILSZ keyword” on page 82
PRERES.HPPRBH	Optional	Not applicable	Not applicable	“PRERES.HPPRBH keyword” on page 83
PRERES.OPRTLCL	Optional	Not applicable	Not applicable	“PRERES.OPRTLCL keyword” on page 83
PRERES.OPRTLPL	Optional	Not applicable	Not applicable	“PRERES.OPRTLPL keyword” on page 83
PRERES.UPDLPC	Optional	Not applicable	Not applicable	“PRERES.UPDLPC keyword” on page 84
PRERES.XAVGRLLEN	Optional	Not applicable	Not applicable	“PRERES.XAVGRLLEN keyword” on page 84
PRERES.XFILSZ	Optional	Not applicable	Not applicable	“PRERES.XFILSZ keyword” on page 84
PSINDEXBLD	Optional	Not applicable	Not applicable	“PSINDEXBLD keyword” on page 85
PTRCHECK	Optional	Not applicable	Not applicable	“PTRCHECK keyword” on page 85
READON	Optional	Not applicable	Not applicable	“READON keyword” on page 86

Table 4. HRFSYSIN DD statement keywords (continued)

Keyword	REORG HRFSYSIN DD	UNLOAD HRFSYSIN DD	IMAGECOPY HRFSYSIN DD	Link to topic
READONLY	Optional	Not applicable	Not applicable	“READONLY keyword” on page 86
RELOAD.DBIOBUF	Optional	Not applicable	Not applicable	“RELOAD.DBIOBUF keyword” on page 86
RELOAD.DBRLBUF	Optional	Not applicable	Not applicable	“RELOAD.DBRLBUF keyword” on page 87
RELOAD.FRSPC	Optional	Not applicable	Not applicable	“RELOAD.FRSPC keyword” on page 87
RELOAD.HPIO	Optional	Not applicable	Not applicable	“RELOAD.HPIO keyword” on page 87
RELOAD.OADSPR	Optional	Not applicable	Not applicable	“RELOAD.OADSPR keyword” on page 88
RELOAD.RAAFORMAT	Optional	Not applicable	Not applicable	“RELOAD.RAAFORMAT keyword” on page 88
RELOAD.SEARCH	Optional	Not applicable	Not applicable	“RELOAD.SEARCH keyword” on page 89
RELOAD.SORT	Optional	Not applicable	Not applicable	“RELOAD.SORT keyword” on page 89
RELOAD.USEREXIT	Optional	Not applicable	Not applicable	“RELOAD.USEREXIT keyword” on page 89
RELOAD.WF1HLQ	Optional	Not applicable	Not applicable	“RELOAD.WF1HLQ keyword” on page 90
RELOAD.WF1SPACE	Optional	Not applicable	Not applicable	“RELOAD.WF1SPACE keyword” on page 90
RELOAD.WF1UNIT	Optional	Not applicable	Not applicable	“RELOAD.WF1UNIT keyword” on page 91
RELOAD.WF1VOL	Optional	Not applicable	Not applicable	“RELOAD.WF1VOL keyword” on page 91
RELOAD.WFPHLQ	Optional	Not applicable	Not applicable	“RELOAD.WFPHLQ keyword” on page 92
RELOAD.WFPSPACE	Optional	Not applicable	Not applicable	“RELOAD.WFPSPACE keyword” on page 92
RELOAD.WFPUNIT	Optional	Not applicable	Not applicable	“RELOAD.WFPUNIT keyword” on page 92
RELOAD.WFPVOL	Optional	Not applicable	Not applicable	“RELOAD.WFPVOL keyword” on page 93
RELOAD.WFPVOLCNT	Optional	Not applicable	Not applicable	“RELOAD.WFPVOLCNT keyword” on page 93
RESTART	Optional	Not applicable	Not applicable	“RESTART keyword” on page 94

Table 4. HRFSYSIN DD statement keywords (continued)

Keyword	REORG HRFSYSIN DD	UNLOAD HRFSYSIN DD	IMAGECOPY HRFSYSIN DD	Link to topic
SASJOBPREF	Optional	Not applicable	Not applicable	“SASJOBPREF keyword” on page 94
SASMAX	Optional	Not applicable	Not applicable	“SASMAX keyword” on page 95
SHADOW	Optional	Optional	Optional	“SHADOW keyword” on page 95
SORTNUM	Optional	Not applicable	Not applicable	“SORTNUM keyword” on page 96
STORCLAS	Optional	Not applicable	Not applicable	“STORCLAS keyword” on page 96
TAKEOVER	Optional	Not applicable	Not applicable	“TAKEOVER keyword” on page 96
TAKEOVER.WINDOW	Optional	Not applicable	Not applicable	“TAKEOVER.WINDOW keyword” on page 97
TEMPRECOV	Optional	Not applicable	Not applicable	“TEMPRECOV keyword” on page 98
UNLSPAC	Optional	Not applicable	Not applicable	“UNLSPAC keyword” on page 98
UNLUNIT	Optional	Not applicable	Not applicable	“UNLUNIT keyword” on page 99
VOLALLO	Optional	Not applicable	Not applicable	“VOLALLO keyword” on page 99

ADDBGRP keyword

Use this keyword to specify the database group name to send with the system notification to the Autonomics Director server.

Requirement: An Autonomics Director server must be configured and active. For more information, see the *IMS Tools Base Autonomics Director User's Guide and Reference*.

If you specify the ADDBGRP keyword, you must also specify the ADXCFGRP keyword.

The ADDBGRP keyword is optional for REORG HRFSYSIN DD statements.

Format

```
▶▶ ADDBGRP( database_group_name ) ▶▶
```

Default value

None.

ADXCFCGRP keyword

Use this keyword to specify the XCF group name of the Autonomics Director server. At the end of the IMS Online Reorganization Facility job, a system notification is sent to the specified server to notify Autonomics Director of the results of online reorganization.

Requirement: An Autonomics Director server must be configured and active. For more information, see the *IMS Tools Base Autonomics Director User's Guide and Reference*.

The ADCFCGRP keyword is optional for REORG HRFSYSIN DD statements.

The ADCFCGRP keyword is effective only when all the following conditions are met:

- The SHKTLOAD library of IMS Tools Base is specified in the STEPLIB concatenations.
- TAKEOVER(Y) is specified in the REORG HRFSYSIN DD statement.
- The primary database to reorganize is not an index database.
- DBD change is not requested.

Format

```
►► ADCFCGRP( xcf_group_name ) ◄◄
```

Default value

None.

COMPAUTH keyword

Use this keyword to specify the COMPAUTH option that IMS High Performance Unload and IMS High Performance Load use during the reorganization.

This keyword is optional for REORG and UNLOAD HRFSYSIN DD statements. If you specify COMPAUTH(Y), IMS High Performance Unload and IMS High Performance Load call the segment compression exit in supervisor state.

Format

```
►► COMPAUTH(  $\begin{array}{c} \text{N} \\ \text{Y} \end{array}$  ) ◄◄
```

Default value

N

CONDREORG keyword

Use this keyword to enable the Conditional Reorganization Support Service (CRSS) and to specify which runtime mode to use.

Requirement: The Policy Services server must be configured and active. For more information, see the topic "Configuring Policy Services" in the *IMS Tools Base Configuration Guide*.

The CONDREORG keyword is optional for REORG HRFSYSIN DD statements.

If CONDREORG(Y) is specified for multiple partitions of a HALDB, IMS Online Reorganization Facility reorganizes only the partitions that need to be reorganized. If CONDREORG(Y) is specified and IMS HD Unload is used for unloading data, IMS Online Reorganization Facility reorganizes all the specified partitions when one or more partitions require reorganization.

Specify one of the following values:

CONDREORG(Y)

The job runs in Conditional Reorganization mode.

CONDREORG(Y,DIAGONLY)

The job runs in Diagnosis-only mode.

CONDREORG(Y,REORGDIAG)

The job runs in Reorganization Diagnosis mode.

CONDREORG(N)

The CRSS is not called in the job.

For details about CRSS modes, see [“Runtime modes for CRSS” on page 21.](#)

Usage note: To enable the CRSS, all of the following conditions must be met:

- The load library of IMS Database Reorganization Expert is included in the STEPLIB concatenations.
- The SHKTLOAD library of IMS Tools Base is included in the STEPLIB concatenations.
- The primary database to reorganize is not an index database.
- The ITKBSERVER keyword is specified in the REORG HRFSYSIN DD statement.
- TAKEOVER(N) keyword is not specified in the REORG HRFSYSIN DD statement.
- DBD change is not requested.

Format

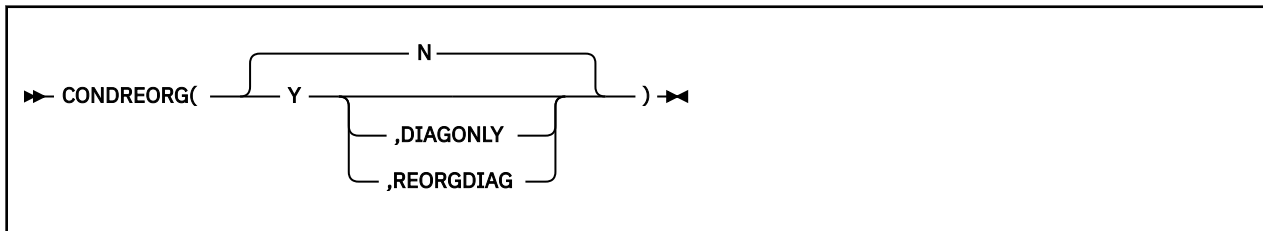

Default value

N

CR.DIAGDATAFROM keyword

Use this keyword to specify how the Conditional Reorganization Support Service (CRSS) retrieves database statistics data. This data is used for database diagnosis in the first evaluation phase to determine whether database reorganization is needed.

The CR.DIAGDATAFROM keyword is optional for REORG HRFSYSIN DD statements. If the CRSS is not used, this keyword is ignored.

Specify one of the following values:

CR.DIAGDATAFROM(DBSENSOR)

The CRSS requests DB Sensor to collect database statistics and uses them for database diagnosis.

CR.DIAGDATAFROM(REPOSITORY)

The CRSS retrieves the latest statistics from the Sensor Data repository of IMS Tools KB and uses them for database diagnosis.

Format

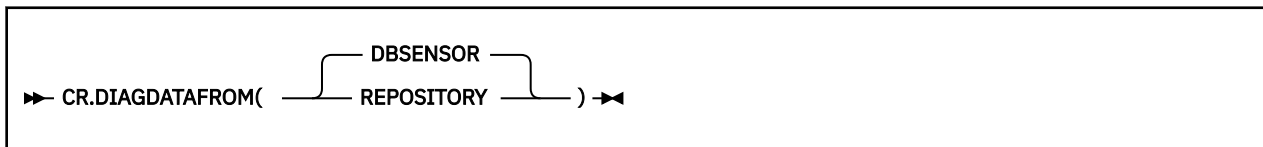

Default value

DBSENSOR

CR.EVALINDEX keyword

Use this keyword to additionally evaluate secondary index data sets when the Conditional Reorganization Support Service (CRSS) evaluates database data sets to determine the reorganization need.

The CR.EVALINDEX keyword is optional for REORG HRFSYSIN DD statements.

This keyword is effective only when all of the following conditions are met:

- CONDREORG(Y), CONDREORG(Y,DIAGONLY), or CONDREORG(Y,REORGDIAG) is specified.
- If the database is a HALDB, PSINDEXBLD(Y) is specified.

Specify one of the following values:

CR.EVALINDEX(Y)

The CRSS evaluates not only the primary database but also the secondary indexes. Diagnosis reports are created for both the primary database and the secondary indexes.

If the reorganization policy that is applied to the secondary indexes uses the rule whose action is set to REORG, the CRSS takes into consideration the evaluation results of the secondary indexes to determine the reorganization need. If the CRSS determines that one or more of the secondary indexes need reorganization, the primary database is reorganized and all the secondary indexes are rebuilt even if the primary database does not require reorganization.

To learn more about this option, see [“Scenario 5: Evaluating secondary indexes and conditionally reorganizing a database”](#) on page 113.

CR.EVALINDEX(N)

The CRSS does not evaluate secondary indexes and Diagnosis reports are not created for secondary indexes.

Format



Default value

N

CR.IC keyword

Use this keyword to create image copies of database data sets or HALDB partitions even if the Conditional Reorganization Support Service (CRSS) determines that reorganization is not needed.

The CR.IC keyword is optional for REORG HRFSYSIN DD statements.

This keyword is effective only when all of the following conditions are met:

- CONDREORG(Y) is specified.
- IMS High Performance Image Copy is available.
- ICEIN keyword is specified.

Specify one of the following values:

CR.IC(ALWAYS)

Creates image copies of all the database data sets or HALDB partitions regardless of whether the data sets or HALDB partitions are reorganized.

CR.IC(COND)

Creates image copies of only the data sets or HALDB partitions that are reorganized.

Format



Default value

COND

CR.JOURNAL keyword

Use this keyword to print the journal messages to the output stream.

The CR.JOURNAL keyword is optional for REORG HRFSYSIN DD statements. If the Conditional Reorganization Support Service (CRSS) is not used, this keyword is ignored.

When CR.JOURNAL(Y) is specified, the following journal messages are printed:

- The journal messages that the CRSS issues are printed to the output stream that is specified by the BBEJRN DD statement.
- The journal messages that Policy Services issues are printed to the output stream that is specified by the BSNJM01 DD statement.

Note: If you specify CR.JOURNAL(N) and specify the BBEJRN DD statement, the BSNJM01 DD statement, or both in the JCL, journal messages are printed to the specified DD data sets.

Format

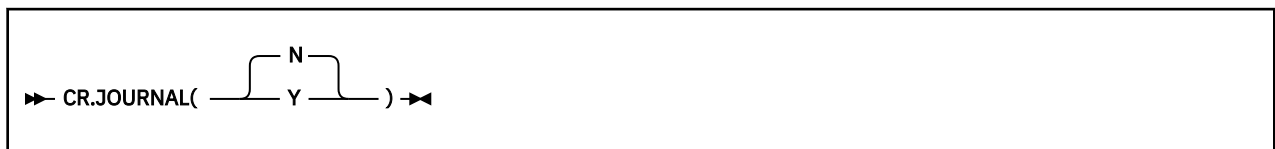

Default value

N

CR.POLICYBY keyword

Use this keyword to specify how the Conditional Reorganization Support Service (CRSS) selects the reorganization policy for database diagnosis.

The CR.POLICYBY keyword is optional for REORG HRFSYSIN DD statements. If the CRSS is not used, this keyword is ignored.

Specify one of the following values:

CR.POLICYBY(DBDNAME)

The reorganization policy is selected based on the DBD name of the target database.

If you specify this option, the reorganization policy that is named SYS.DBDNAME.*dbdname* in the Input repository of IMS Tools KB is used. *dbdname* is the DBD name of the target database.

CR.POLICYBY(DBTYPE)

The reorganization policy is selected based on the type of the target database.

If you specify this option, the reorganization policy that is named SYS.DBDBTYPE.*dbtype* in the Input repository of IMS Tools KB is used. *dbtype* is one of HDAM, HIDAM, PHDAM, PHIDAM, HISAM, or SHISAM.

CR.POLICYBY(NAME)

The reorganization policy is selected based on the policy name that is specified on the CR.POLICYNM keyword. If you specify this option, you must also specify the CR.POLICYNM keyword.

Format

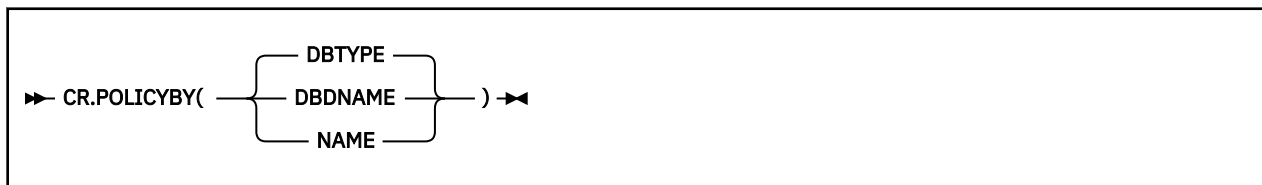

Default value

DBTYPE

CR.POLICYNM keyword

Use this keyword to specify the name of the reorganization policy for database diagnosis.

The CR.POLICYNM keyword is optional for REORG HRFSYSIN DD statements. If the Conditional Reorganization Support Service (CRSS) is not used, this keyword is ignored.

If you specify the CR.POLICYNM keyword, you must also specify the CR.POLICYBY(NAME) keyword.

Format

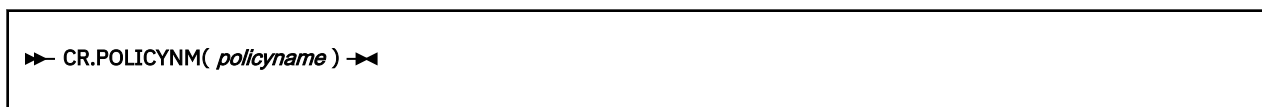

where *policyname* is the 1- to 20-character alphanumeric name of the reorganization policy.

Default value

None.

CR.PRINTRPRT keyword

Use this keyword to print the Diagnosis report to the output stream.

The CR.PRINTRPRT keyword is optional for REORG HRFSYSIN DD statements. If the Conditional Reorganization Support Service (CRSS) is not used, this keyword is ignored.

If you specify CR.PRINTRPRT(Y), the Diagnosis report is printed to the output stream. To suppress the Diagnosis report, specify CR.PRINTRPRT(N).

Format

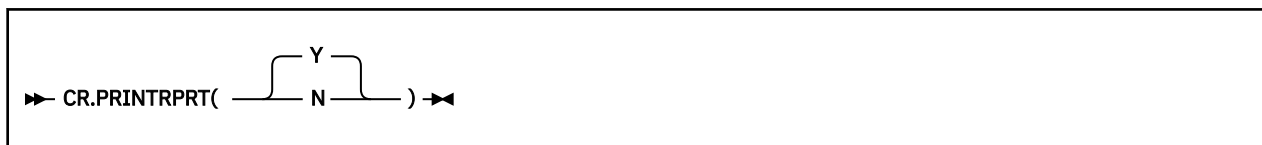

Default value

Y

CR.SENSOR_HOME keyword

Use this keyword to request DB Sensor to collect additional data elements that are related to root segment distribution.

The CR.SENSOR_HOME keyword is optional for REORG HRFSYSIN DD statements. If the Conditional Reorganization Support Service (CRSS) is not used, this keyword is ignored.

When CR.SENSOR_HOME(Y) is specified, DB Sensor collects the following additional data elements:

- DB_NUM_ROOT_NOHOME
- DB_PCT_NUM_ROOT_NOHOME
- DB_AVG_LEN_SYNONYM_CHAIN

The data elements that are additionally collected when CR.SENSOR_HOME(Y) are useful factors for determining the need of database reorganization. Because DB Sensor calls a randomizer to collect data for these elements, the CPU time and the elapsed time increase compared to when CR.SENSOR_HOME(N) is specified.

Restriction: If the key compression option of the Segment Edit/Compression exit routine is specified for the root segment, these data elements are not collected even when CR.SENSOR_HOME(Y) is specified.

For more information about these data elements, see the topic "GLOBAL command keywords for FF Stand-alone DB Sensor" in the *IMS Solution Packs: Data Sensor User's Guide*.

Format

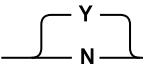
►► CR.SENSOR_HOME() ◄◄

Default value

Y

CR.STORERPRT keyword

Use this keyword to store the Diagnosis report in the Output repository of IMS Tools KB.

The CR.STORERPRT keyword is optional for REORG HRFSYSIN DD statements. If the Conditional Reorganization Support Service (CRSS) is not used, this keyword is ignored.

If you specify CR.STORERPRT(Y), the Diagnosis report is stored in the Output repository of IMS Tools KB. If you do not want to store the report in the repository, specify CR.STORERPRT(N).

Format

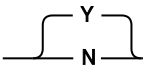
►► CR.STORERPRT() ◄◄

Default value

Y

CR.UNLOAD keyword

Use this keyword to create the HD unload file even when the Conditional Reorganization Support Service (CRSS) determines that reorganization is not needed.

The CR.UNLOAD keyword is optional for REORG HRFYSIN DD statements.

This keyword is effective only when all of the following conditions are met:

- CONDREORG(Y) is specified.
- IMS High Performance Unload and IMS High Performance Load are available.
- DFSUINPT DD statement is specified.
- The database specified in the DBD keyword does not have logical relationships.

Specify one of the following values:

CR.UNLOAD(ALWAYS)

Creates an HD unload file that contains data from all the database data sets or HALDB partitions regardless of whether the data sets or HALDB partitions are reorganized.

CR.UNLOAD(COND)

Creates an HD unload file that contains data from reorganized database data sets or HALDB partitions.

Format



Default value

COND

DATACLAS keyword

Use this keyword to specify the SMS data class to use for the dynamic allocation of image copy data sets. This keyword is ignored if the ICEIN keyword is specified.

The DATACLAS keyword is optional for REORG HRFYSIN DD statements.

Format

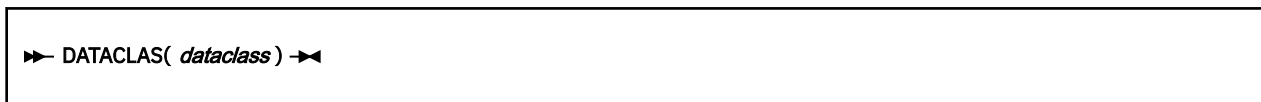

Default value

None.

DBALL keyword

Use this keyword to specify whether to process all the databases in the logical group when the database specified in the DBD has external logical relationships.

Specify DBALL(Y) to process all the databases or DBALL(N) to process only the specified databases in the logical group. When DBALL(Y) is specified, DFDSS(Y) is forced. If the database specified in the DBD does not have external logical relationships, this keyword is ignored.

Format



Default value

N

DBD keyword

Use this keyword to identify the primary database to reorganize by IMS Online Reorganization Facility.

The DBD keyword is required for REORG, UNLOAD, and IMAGECOPY HRFSYSIN DD statements. If you do not specify the DBD keyword, the online reorganization batch job terminates during the Verification phase, resulting in a U999 abend and message.

Format



Specify a DBD name or the variable &PARAM. If you specify the variable, the DBD name must be specified in the z/OS parameter string as PARM='DBD(*dbdname*)'.

Default value

None.

Related reference

DD statements

When you code JCL statements to run IMS Online Reorganization Facility, you must include the appropriate DD statements.

DBDCOPY keyword

Use this keyword to specify whether to copy the NEWDBD to the IMS DDNAME when a database has DBD changes. If a database has DBD changes, it is highly recommended that you specify DBDCOPY(Y) and ONLINECHANGE(Y) so that the databases do not require manual intervention at the end of the reorganization.

This keyword is optional for REORG HRFSYSIN DD statements and is effective when the NEWDBD keyword is specified and the parameter for the TAKEOVER keyword is not N.

Format

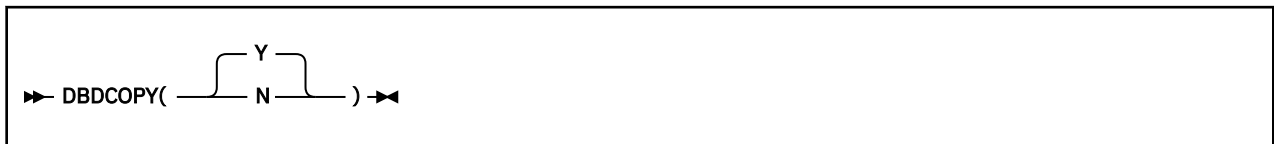

Default value

Y

DBDLIST keyword

The ddname that the DBDLIST keyword specifies is included in the JCL. The ddname must be a SYSOUT file. If the ddname is not found, it is allocated dynamically. The DBD source statements are printed to the specified file.

The DBDLIST keyword is optional for REORG HRFYSIN DD statements.

Format

```
➤ DBDLIST( ddname ) ➤
```

Default value

None.

DBSTART keyword

Use this keyword to specify whether to start the database, even if it was not started at the beginning of the IMS Online Reorganization Facility job.

The DBSTART keyword is optional for REORG HRFYSIN DD statements.

Format

```
➤ DBSTART(           ) ➤
```

N
Y

Default value

N

DELETE keyword

Use this keyword to indicate whether the database copies that were made before reorganization are deleted. After the shadow database names are altered to the original names, the .S copies of the databases contain the data as it was before reorganization.

The DELETE keyword is optional and is applicable only if you specify TAKEOVER(Y).

Format

```
➤ DELETE(           ) ➤
```

Y
N

Default value

Y

DFDSS keyword

Use this keyword to specify whether to use DFSMSdss during the Copy phase when the primary database data sets are copied. When DFSMSdss is used, the database is stopped while the data sets are copied.

The DFDSS keyword is optional for REORG, UNLOAD, and IMAGECOPY HRFYSIN DD statements. This keyword is effective when both of the following conditions are met:

- The primary database to reorganize is not an index.
- The database data sets reside on SMS-managed volumes.

Format



Default value

Determined by the DFDSS base configuration parameter.

DFDSS.FASTREP keyword

Use this keyword to specify the DFSMSdss FASTREPLICATION option for the DFSMSdss COPY command that IMS Online Reorganization Facility issues during the Copy phase.

The DFDSS.FASTREP keyword is optional for REORG, UNLOAD, and IMAGECOPY HRFYSIN DD statements. If DFSMSdss is not used, this keyword is ignored.

Specify one of the following values:

REQUIRED | REQ

FASTREPLICATION(REQUIRED) is specified in the DFSMSdss COPY command. DFSMSdss must use fast replication for data set copy operation. If fast replication cannot be used, the job fails in the Copy phase.

PREFERRED | PREF

FASTREPLICATION(PREFERRED) is specified in the DFSMSdss COPY command. DFSMSdss uses fast replication for data set copy operation if possible. If fast replication cannot be used, DFSMSdss uses traditional data movement methods.

NONE | NO

FASTREPLICATION(NONE) is specified in the DFSMSdss COPY command. DFSMSdss uses traditional data movement methods.

For details, see the description of the FASTREPLICATION keyword in *z/OS DFSMSdss Storage Administration*.

Format

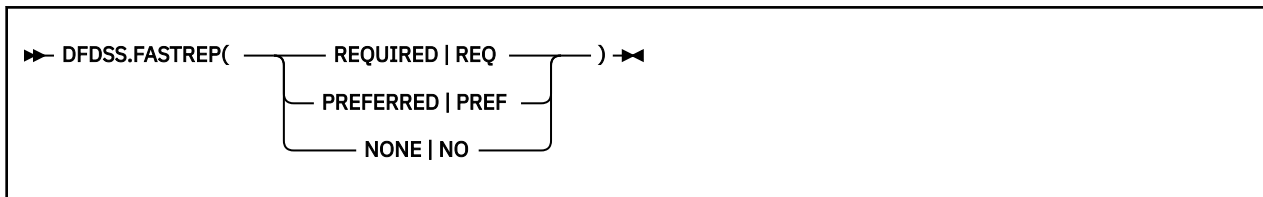

Default value

None. The FASTREPLICATION option is not specified for the DFSMSdss COPY command. The DFSMSdss default, which is FASTREPLICATION(PREFERRED), is applied unless the default value is changed by the installation.

DFDSS.FCTOPPRCP keyword

Use this keyword to specify the DFSMSDss FCTOPPRCPPRIMARY option for the DFSMSDss COPY command that IMS Online Reorganization Facility issues during the Copy phase.

The DFDSS.FCTOPPRCP keyword is optional for REORG, UNLOAD, and IMAGECOPY HRFSYSIN DD statements. If DFSMSDss is not used, this keyword is ignored.

If you specify the DFDSS.FCTOPPRCP keyword, the FCTOPPRCPPRIMARY option is specified in the DFSMSDss COPY command so that a Peer-to-Peer Remote Copy (PPRC) primary volume is allowed to become the target of a FlashCopy® operation. Specify one of the following values:

PRESMIRREQ | PMR

FCTOPPRCPPRIMARY(PRESMIRREQ) is specified in the DFSMSDss COPY command. The device pair must not go into a duplex pending state as the result of a FlashCopy operations.

PRESMIRPREF | PMP

FCTOPPRCPPRIMARY(PRESMIRPREF) is specified in the DFSMSDss COPY command. It would be preferable that the device pair does not go into a duplex pending state as the result of a FlashCopy operation.

PRESMIRNONE | PMN

FCTOPPRCPPRIMARY(PRESMIRNONE) is specified in the DFSMSDss COPY command. The device pair is to go into a duplex pending state while the secondary device is updated with the tracks to be copied.

For details, see the description of the FCTOPPRCPPRIMARY keyword in *z/OS DFSMSDss Storage Administration*.

Format

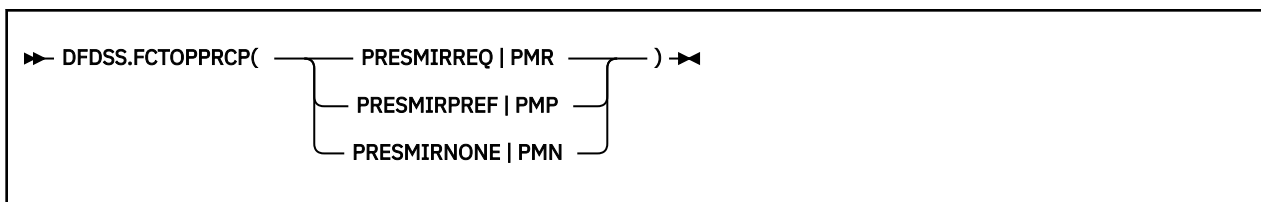

Default value

None. The FCTOPPRCPPRIMARY option is not specified for the DFSMSDss COPY command.

DFDSS.FCTOXRCP keyword

Use this keyword to specify the DFSMSDss FCTOXRCPPRIMARY option for the DFSMSDss COPY command that IMS Online Reorganization Facility issues during the Copy phase.

The DFDSS.FCTOXRCP keyword is optional for REORG, UNLOAD, and IMAGECOPY HRFSYSIN DD statements. If DFSMSDss is not used, this keyword is ignored.

If you specify DFDSS.FCTOXRCP(Y), the FCTOXRCPPRIMARY option is specified in the DFSMSDss COPY command. If the target volume is an XRC primary device, it is allowed to become the target of a FlashCopy operation.

For details, see the description of the FCTOXRCPPRIMARY keyword in *z/OS DFSMSDss Storage Administration*.

Format



Default value

N

DFSDF keyword

Use this keyword to specify the 3-character suffix of the DFSDFxxx member of the IMS PROCLIB data set that contains the settings and attributes of the IMS catalog.

The specified member is used when either of the following conditions is met:

- Condition 1
 - IMS management of ACBs is enabled (ACBMGMT=CATALOG).
 - IMS Catalog Definition exit routine (DFS3CDX0) is not used.

Ensure that the CATALOG section of the DFSDFxxx member specifies CATALOG=Y, ACBMGMT=CATALOG, and the alias name for the IMS catalog.
- Condition 2
 - The active ACBs are managed by your installation in the ACBLIB data sets. (ACBMGMT=ACBLIB)
 - The NEWDBD keyword is specified. The DFSDF keyword is optional for REORG, UNLOAD, and IMAGECOPY HRFSYSIN DD statements.

Format

►► DFSDF(ddd) ◄◄

Default value

None.

FEOV keyword

This keyword indicates whether the **/DBR** command specifies FEOV (force end-of-volume) or NOFEOV during the Takeover phase. This keyword also indicates whether the **/DBD** command specifies FEOV or NOFEOV in the Copy phase when CR.IC(ALWAYS) is specified.

The FEOV keyword is optional for REORG HRFSYSIN DD statements.

Format

►► FEOV(Y) ◄◄
 N

Default value

The default is to use the value in the base configuration module.

GDGLIMIT keyword

This keyword specifies the maximum number of GDG (generation data group) data sets. The keyword value is applied when IMS Online Reorganization Facility is requested to automatically define a GDG base for image copy data sets or log data sets.

The GDGLIMIT keyword is optional for REORG HRFSYSIN DD statements.

The value specified on this keyword is used when both of the following conditions are true:

- IMS Online Reorganization Facility is requested to dynamically allocate a GDG data set as an image copy data set or a log data set.
- A GDG base for the specified GDG data set does not exist.

Dynamic allocation of a GDG data set is requested if one or more of the following conditions are true:

- ICDYN(Y) and ICTRLR(1) are specified.
- ICDYN(Y) is specified, and the &GDG variable is specified for the IC1DSN keyword, the IC2DSN keyword, or for both keywords.
- IEFORDER DD is not specified, and the &GDG variable is specified for the LOG1DSN keyword, the LOG2DSN keyword, or for both keywords.

Before allocating a GDG data set, IMS Online Reorganization Facility verifies the existence of a GDG base. If a GDG base does not exist, IMS Online Reorganization Facility automatically defines one by using the GDGLIMIT keyword value as the number of generations to keep. You cannot specify different values for image copy data sets and log data sets.

Format



Default value

20

GDGMODEL keyword

Use this keyword to identify a model for the GDG image copy data sets.

The GDGMODEL keyword is optional for REORG HRFSYSIN DD statements.

The value specified on this keyword is used only when both of the following conditions are true:

- A GDG is requested for an image copy data set.
- IMS Online Reorganization Facility dynamically allocates the image copy data set.

The GDG model name (*gdgmodel*) must be the name of a cataloged image copy data set. This keyword is not applicable to GDG log data sets.

Format

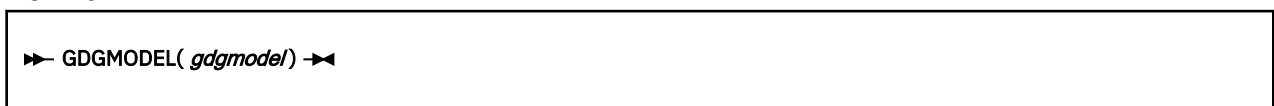

Default value

None.

IC.COMP keyword

Use this keyword to indicate whether the image copy utility compresses image copies. The IC.COMP keyword must be used with the IC.COMPRTN keyword.

The IC.COMP keyword is optional for REORG HRFSYSIN DD statements.

Format



Default value

N

IC.COMPRTN keyword

Use this keyword to specify the compression routine to use when IC.COMP(Y) is specified. The IC.COMPRTN keyword must be used with the IC.COMP keyword.

The IC.COMPRTN keyword is optional for REORG HRFSYSIN DD statements.

Format

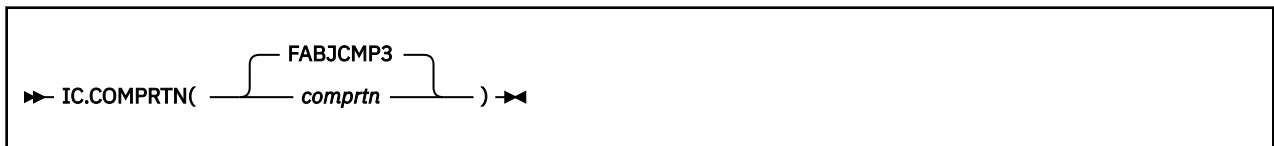

Default value

FABJCOMP3

ICDDN keyword

Use this keyword to specify the image copy DDNAME that is associated with a DBD DDNAME if the JCL specifies an image copy data set. If ICNUM(2) is specified, you must identify a second DDNAME to use if one is specified in the JCL. Otherwise, if ICDYN(Y) is specified, the ICHLQ, ICMID, ICID, and ICTRLR keywords are used to dynamically allocate the second copy.

The ICDDN keyword is required for REORG HRFSYSIN DD statements if an image copy is specified in the JCL and so, are not dynamically allocated by using ICDYN(Y).

Format

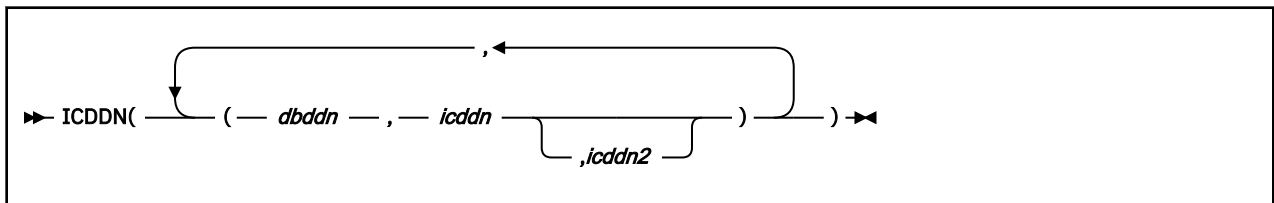

To specify multiple database DDNAMEs and their associated image copy DDNAMEs, code the ICDDN keyword as follows:

```
ICDDN((dbddn,icddn,icddn2),(dbddn2,icddn3,icddn4),(dbddn3,icddn5,icddn6))
```

Default value

None.

ICDYN keyword

Use this keyword to identify whether to use the ICHLQ, ICMID, ICID, and ICTRLR keywords to dynamically allocate one or more image copies. If the ICDDN keyword and the JCL specify an image copy, this keyword is ignored for that image copy.

The ICDYN keyword is required for REORG HRFSYSIN DD statements if the JCL does not specify one or more image copies.

Format



Default value

N

IC1DSN keyword

To specify the data set name for an image copy, you can use this keyword that provides an alternative to using the ICHLQ, ICID, ICMID, and ICTRLR keywords.

The IC1DSN keyword is optional for REORG HRFSYSIN DD statements.

The data set name can contain variables. To specify a variable, use an ampersand (&) and enclose the variable in periods (.). The following variables are supported:

&JOBNAME

Name of this job.

&DBD

The DBD name. This value changes to the first partition name when not all partitions are processed.

&DDNAME

The DD name of the database data set.

&DATE1

This variable is substituted as *Dyyyyddd*.

&DATE2

This variable is substituted as *Ddddyyyy*.

&DATE3

This variable is substituted as *Dddmmyy*.

&DATE4

This variable is substituted as *Dmmdyy*.

&DATE5

This variable is substituted as *Dyymmdd*.

&TIME1

This variable is substituted as *Thhmmss*.

&TIME2

This variable is substituted as *Thhmm*.

&GDG

The identifier of the GDG data set. This variable must be specified in the last position in the pattern, and it should not be specified with variables related to date or time.

where:

- *yyyy* is the 4-digit year

- *yy* is the last 2 digits of the year
- *mm* is the month
- *ddd* is the day of the year
- *dd* is the day of the month
- *hh* is the hour (24-hour clock) local time
- *mm* is the minute
- *ss* is the second

Format

```
▶▶ IC1DSN( dsname ) ◀◀
```

Default value

None.

IC2DSN keyword

Use this keyword to specify a secondary image copy data set name. To create the data set name, use the same method that is described for the IC1DSN keyword. You must specify a unique data set name. This keyword is ignored when ICNUM(2) is not specified.

The IC2DSN keyword is optional for REORG HRFSYSIN DD statements.

Format

```
▶▶ IC2DSN( dsname ) ◀◀
```

Default value

None.

ICEIN keyword

Use this keyword to specify the DD name of the file that contains the control statements for IMS High Performance Image Copy. The options in the file can be specified in a similar format as the options used for stand-alone IMS High Performance Image Copy jobs. If you use this keyword, you do not need to use the other image copy (IC) keywords.

The ICEIN keyword is optional for REORG and IMAGECOPY HRFSYSIN DD statements. If you use this keyword, you must include the specified DD name in the JCL statements. If IMAGECOPY HRFSYSIN DD statements are specified and you do not specify the ICEIN keyword, ICEIN(ICEIN) is used as default. If you specify ICEIN(ICEIN) and the IMS HP Image Copy site default table (FABJGLB0) is included in your STEPLIB, you do not need to code the ICEIN DD statement in the JCL.

Restriction: Certain IMS High Performance Image Copy keywords cannot be used when IMS High Performance Image Copy is called from IMS Online Reorganization Facility. For more information about these keywords, see the *IMS High Performance Image Copy User's Guide*.

Format for the REORG command

```
▶▶ ICEIN( ddname ) ◀◀
```

Format for the IMAGECOPY command



Default value

REORG: None.

IMAGECOPY: ICEIN

ICHLQ keyword

Use this keyword to specify the high-level qualifier to use to dynamically allocate image copy data sets. Use this keyword with the ICDYN(Y), ICMID, ICID, and ICTRLR keywords. If the ICDDN keyword and the JCL specify an image copy, this keyword is ignored for that image copy.

The ICHLQ keyword is required for REORG HRFSYSIN DD statements if one or more image copies are not specified in the JCL and the ICDYN(Y) keyword is specified.

Format

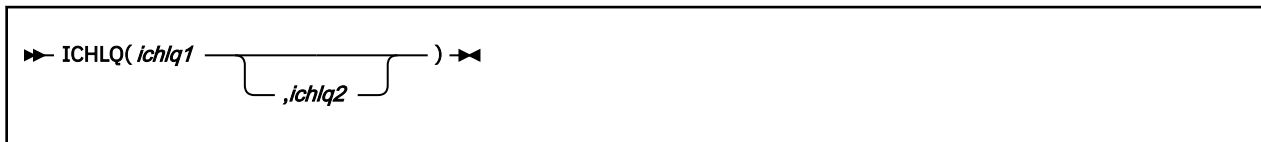

Default value

None.

ICID keyword

Use this keyword to distinguish between single or dual image copy data sets when you dynamically allocate dual image copies. Use this keyword with the ICDYN(Y), ICHLQ, ICMID, and ICTRLR keywords. If the ICDDN keyword and the JCL specify an image copy, this keyword is ignored for that image copy. Specifying ICID(1) renders IC1 or IC2. Specifying ICID(2) renders none.

The ICID keyword is optional for REORG HRFSYSIN DD statements.

Format



Default value

1

ICMID keyword

Use this keyword to specify the mid-level data set qualifier when you dynamically allocate any image copy data set. Use this keyword with the ICDYN(Y), ICHLQ, ICID, and ICTRLR keywords. If the ICDDN keyword and the JCL specify an image copy, this keyword is ignored for that image copy.

The ICMID keyword is optional for REORG HRFSYSIN DD statements.

Specify 1 to render: dbdname . ddname .

Specify 2 to render: dbdname .

Specify 3 to render: ddname .

Specify 4 to render no mid-level data set qualifier.

Format

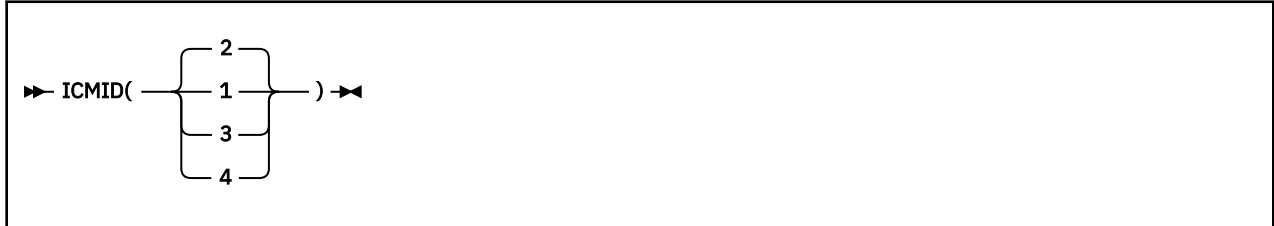

Default value

2

ICNUM keyword

Use this keyword to indicate single or dual image copies. Specify ICNUM(1) to dynamically allocate a single image copy. Specify ICNUM(2) to dynamically allocate dual image copies.

The ICNUM keyword is required for REORG HRFSYSIN DD statements if a second copy of an image copy is to be dynamically allocated.

Format



Default value

1

ICTRLR keyword

Use this keyword to specify whether a dynamically allocated image copy is a GDG data set and to use a different final suffix qualifier. If a dynamically allocated image copy is not a GDG, the ICTRLR keyword identifies the last qualifier of the image copy data set. Use the ICTRLR keyword with the ICDYN(Y), ICHLQ, ICMID, and ICID keywords. If the ICDDN keyword and the JCL specify an image copy, this keyword is ignored for that image copy.

The ICTRLR keyword is required for REORG HRFSYSIN DD statements when all the following conditions are true:

- You do not specify one or more image copies in the JCL.
- You specified ICDYN(Y).
- The dynamically allocated image copy is a GDG.

The ICTRLR keyword specifications render the following final suffix qualifiers:

ICTRLR(1)

GDG

ICTRLR(2)

Dyymmdd.Thmmss

ICTRLR(3)*Dmmdyy.Thhmmss***ICTRLR(4)***Dddmmyy.Thhmmss***ICTRLR(5)**

None

Format**Default value**

2

IC.VIC keyword

Use this keyword to specify whether all index image copies are registered as virtual.

The IC.VIC keyword is optional for REORG HRFSYSIN DD statements.

Specifying Y for this keyword results in a USER IC that uses the IC.VICDSN as user data. The IC.VIC keyword is effective only for the index databases that are registered as recoverable with DBRC.

Format**Default value**

N

IC.VICDSN keyword

Use this keyword to specify the virtual image copy data set name.

The IC.VICDSN keyword is optional for REORG HRFSYSIN DD statements.

Format**Default value**

VIRT.IC

ICVOLCT keyword

Use this keyword to specify the number of volumes to allocate for image copy data sets. If you specify ICDYN(Y) to dynamically allocate image copy data sets, use the ICVOLCT keyword to control the number of volumes.

The ICVOLCT keyword is optional for REORG HRFSYSIN DD statements.

If an image copy data set requires more space than is available on a single volume, specify a value larger than 1. The ICVOLCT value is applied to all image copy data sets that are dynamically defined in the IMS Online Reorganization Facility job.

Format



Default value

1

IDXBLD.MAXTASKS keyword

Use this keyword to specify the number of subordinate address spaces that IMS Index Builder creates.

The value must be in the range of 0 - 36. You can specify the PSORT option as the second parameter so that the PSINDEX partitions are sorted in parallel.

The IDXBLD.MAXTASKS keyword is optional for REORG HRFSYSIN DD statements.

This keyword is effective only when PSINDEXBLD(Y) is specified.

For details and default values, see the *IMS Index Builder User's Guide*.

Format

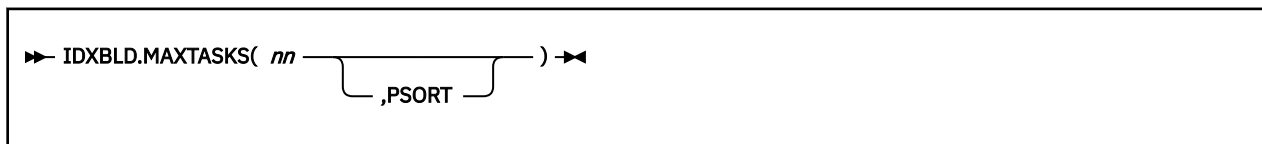

Default value

Determined by IMS Index Builder.

IDXBLD.SIDXBUF keyword

Use this keyword to specify the number of buffers that IMS Index Builder uses for building PSINDEXes.

The IDXBLD.SIDXBUF keyword is optional for REORG HRFSYSIN DD statements.

This keyword is effective only when PSINDEXBLD(Y) is specified.

The following variables are supported:

ddd

The number of VSAM buffers that are to be used for the data component of the KSDS data set. The value must be in the range of 1 - 255.

iii

The number of VSAM buffers that are to be used for the index component of the KSDS data set. The value must be in the range of 1 - 255.

sss

The number of QSAM buffers for reading the SORTOUT data set of striped sort. The value must be in the range of 1 - 255.

For details and default values, see the *IMS Index Builder User's Guide*.

Format

```

  >> IDXBLD.SIDXBUF( ddd,iii _____ ) <<
                    _____
                    ,sss
  
```

Default value

Determined by IMS Index Builder.

IDXBLD.SORTFSZ keyword

Use this keyword to specify the size of the sort stripes that IMS Index Builder allocates to build PSINDEXEs.

The value must be in the range of 1 - 999999999.

The IDXBLD.SORTFSZ keyword is optional for REORG HRFSYSIN DD statements.

This keyword is effective only when PSINDEXBLD(Y) is specified.

For details and default values, see the *IMS Index Builder User's Guide*.

Format

```

  >> IDXBLD.SORTFSZ( nnnnnnnnn ) <<
  
```

Default value

Determined by IMS Index Builder.

IMSID keyword

Use this keyword to specify the IMSID parameter.

The IMSID parameter is used when either of the following conditions is met:

- The IMS Catalog Definition exit routine (DFS3CDX0) that refers to the IMSID parameter is used.
- The Integrity Checker utility of IMS Library Integrity Utilities is active and the unique ID for the DBD is recalculated.

The IMSID keyword is optional for REORG, UNLOAD, and IMAGECOPY HRFSYSIN DD statements.

To recalculate the unique ID for the DBD, you must include IMS Library Integrity Utilities in your STEPLIB; DBDCOPY must be (Y); and ONLINECHANGE must be (Y).

Format

```

  >> IMSID( xxxx ) <<
  
```

where xxxx is the IMSID to use.

Default value

The default value is taken from the IMS RESLIB (DFSVC000) value.

INITIALIZE keyword

Use this keyword to initialize (empty out) the database during the reorganization. In the Reorganization phase, IMS Online Reorganization Facility initializes the shadow database instead of reloading the data.

The INITIALIZE keyword is optional for REORG HRFSYSIN DD statements.

INITIALIZE(Y) is applicable only when all of the following conditions are met:

- The load library of IMS High Performance Load is included in the STEPLIB.
- The primary database to reorganize is not an index.
- If the primary database to reorganize is a HALDB with PSINDEXes, PSINDEXBLD(Y) is specified and the load library of IMS Index Builder is included in the STEPLIB.
- DFSUINPT DD statement defines a dummy data set.

When initialization is requested (INITIALIZE(Y)) and if online updates to any existing database records occur during the job, the job fails in the Apply phase because the shadow database is initialized before the Apply phase and the shadow database contains no database records to apply online updates to.



Attention: Use the INITIALIZE(Y) option with caution because this option removes all the database records from the online database.

You can specify INITIALIZE(Y,NOAPPLY) to avoid failure of the job. When INITIALIZE(Y,NOAPPLY) is specified, Online Reorganization Facility skips the process in the Apply phase. This means that during initialization of the shadow database, online updates are applied to the original database, but not to the shadow database.

Format



Default value

N

ITKBDATA keyword

Use this keyword to specify the type of additional data to store in the IMS Tools KB repository.

The ITKBDATA keyword is optional for REORG HRFSYSIN DD statements. To specify ITKBDATA(UTILHIST), you must also specify the ITKBSERVER keyword.

UTILHIST is the only supported value for the ITKBDATA keyword. If you specify ITKBDATA(UTILHIST), the utility history data for the reorganization job is stored in the Sensor Data repository of IMS Tools KB. The utility history data contains the reorganization timestamp, which indicates the time when the database or the HALDB partition was reorganized.

Format

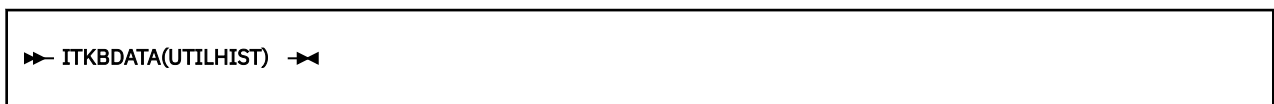

Default value

None.

ITKBSERVER keyword

Use this keyword to specify the XCF group name of the IMS Tools KB server that stores output. See the IMS Tools KB installation for detail.

This keyword is optional.

Format

```
▶▶ ITKBSERVER( xxxxxxxx ) ▶▶
```

where xxxxxxxx is the 8-character XCF group name of the IMS Tools KB server.

Default value

None.

KEYLABEL keyword

Use this keyword to specify the encryption key label for encrypting dynamically allocated image copy data sets. The key label can be up to 64 bytes. This keyword is ignored if the ICEIN keyword is specified.

The KEYLABEL keyword is optional for REORG HRFSYSIN DD statements.

Format

```
▶▶ KEYLABEL( keylabel ) ▶▶
```

Default value

None.

LOG1DSN keyword

Use this keyword to specify the data set name for the primary log data set. The data set name can contain variables. To specify a variable, use an ampersand (&) and enclose the variable in periods (.).

The following variables are supported:

&JOBNAME

Name of this job.

&DBD

The DBD name. This value changes to the first partition name when not all partitions are processed.

&DATE1

This variable is substituted as *Dyyyyddd*.

&DATE2

This variable is substituted as *Ddddyyyy*.

&DATE3

This variable is substituted as *Dddmmyy*.

&DATE4

This variable is substituted as *Dmmdyy*.

&DATE5

This variable is substituted as *Dyymmdd*.

&TIME1

This variable is substituted as *Thhmmss*.

&TIME2

This variable is substituted as *Thhmm*.

&GDG

The identifier of the GDG data set. This variable must be specified in the last position in the pattern, and it should not be specified with variables related to date or time.

where:

- *yyyy* is the 4-digit year
- *yy* is the last 2 digits of the year
- *mm* is the month
- *ddd* is the day of the year
- *dd* is the day of the month
- *hh* is the hour (24-hour clock) local time
- *mm* is the minute
- *ss* is the second

The following example shows a LOG1DSN keyword and variables:

```
LOG1DSN(HLQ1.HLQ2.&DBD.&DATE5.&TIME2.LOG1)
```

If the DBD name is MYDBD, the following data set name is created:

```
HLQ1.HLQ2.MYDBD.D070924.T1055.LOG1
```

The following example shows how to request a GDG log data set with the LOG1DSN keyword:

```
LOG1DSN(HLQ1.HLQ2.&DBD.LOG1.&GDG)
```

A new GDG log data set is created in the following GDG:

```
HLQ1.HLQ2.MYDBD.LOG1
```

If a GDG base with this name does not exist, IMS Online Reorganization Facility automatically defines it and applies the GDGLIMIT keyword value as the number of generations to keep.

Format

```
►► LOG1DSN( dsname ) ◄◄
```

Default value

None.

LOG2DSN keyword

Use this keyword to specify the data set name for the secondary log data set. You can create the data set name by using the same method that is described for LOG1DSN. Ensure that you create a unique data set name.

The LOG2DSN keyword is optional for REORG HRFSYSIN DD statements.

Format

► LOG2DSN(*dsname*) ◄

Default value

None.

LOGICALDBD keyword

Use this keyword to specify the names of the logical DBDs that are defined to the physical database specified by the DBD keyword.

Specify this keyword only if you have applications that update the database during the reorganization process by using a PCB that references a logical DBD. You can specify up to five logical DBD names.

The LOGICALDBD keyword is optional for REORG HRFSYSIN DD statements.

Format

► LOGICALDBD(*dbdname*) ◄

Default value

None.

LOGPRI keyword

Use this keyword to specify the primary space allocation in the cylinder. The maximum value is 9999.

The LOGPRI keyword is optional for REORG HRFSYSIN DD statements.

Format

► LOGPRI(200 0-9999) ◄

Default value

200

LOGSEC keyword

Use this keyword to specify the secondary space allocation in the cylinder. The maximum value is 9999.

The LOGSEC keyword is optional for REORG HRFSYSIN DD statements.

Format

► LOGSEC(100 0-9999) ◄

Default value

100

MGMTCLAS keyword

Use this keyword to specify the SMS management class to use for the dynamic allocation of image copy data sets. This keyword is ignored if the ICEIN keyword is specified.

The MGMTCLAS keyword is optional for REORG HRFSYSIN DD statements.

Format

►► MGMTCLAS(*mgmtclass*) ◄◄

Default value

None.

MONITOR keyword

Use this keyword to generate a message in MSGPRINT every xxx minute to indicate the progress of the reorganization process. The message indicates what phase the reorganization process is in and how many updates have been captured and applied up to that point.

This keyword is optional. If you do not specify the MONITOR keyword, or if you specify MONITOR(0), IMS Online Reorganization Facility does not automatically generate these messages. In either case, though, the operator can issue an MVS **MODIFY** command (F *jobname*,MONITOR), and IMS Online Reorganization Facility sends the progress information to both the MSGPRINT data set and to the MVS console.

Format

►► MONITOR(0) ◄◄
 0-999

Default value

0

NEWDBD keyword

Use this keyword to change the DBD during reorganization. When ACB libraries are used, specify the DD name of the DBDLIB that contains the new DBD to be used when reloading the database. You must include this DD name and data set in the JCL and it must contain the primary DBD.

When IMS manages ACBs, specify NEWDBD(*STAGING) to obtain the pending database definition from the IMS catalog staging data sets and use it when reloading the database. The database definition and all index definitions must exist in the IMS catalog staging data set.

This keyword is required for REORG HRFSYSIN DD statements if you request DBD changes.

If you request DBD changes and the IMS management of ACBs is not enabled, it is highly recommended that you specify both the NEWDBD and ONLINECHANGE(Y) keywords so that the databases do not require manual intervention at the end of the reorganization. Include only the primary DBD and any other associated DBDs that have changed in this library because the DMB is replaced for those DBDs.

If the IMS management of ACBs is enabled or the database being changed is a HALDB database, ONLINECHANGE(N) is forced and manual intervention is required after the reorganization.

When you convert VSAM to OSAM or OSAM LDS:

- You must specify the DDEFPS2 DD statement.
- You must specify the ONLINECHANGE(N) keyword.

For more information, see [“DBD change during reorganization” on page 100](#).

Format



Default value

None.

ONLINECHANGE keyword

Use this recommended keyword if you request DBD changes. This keyword is used to indicate whether a DMB replacement is performed by IMS Online Reorganization Facility, if the databases had DBD changes.

The ONLINECHANGE keyword is optional for REORG HRFSYSIN DD statements.

If the databases had DBD changes, it is highly recommended that you specify both the NEWDBD and ONLINECHANGE(Y) keywords so that the databases do not require manual intervention at the end of the reorganization. This keyword is ignored for HALDB.

When IMS uses dynamic allocation for the ACBLIB, the A and B data sets must be included in the JCL.

For more information, see [“DBD change during reorganization” on page 100](#).

Format



Default value

Y

OPTID keyword

Use this keyword to specify a suffix that identifies the SETOP member to use. IMS Online Reorganization Facility appends the specified suffix to HRF# to determine the name of the SETOP member to locate. IMSID indicates that the default IMS ID that is defined in SDFSRESL is used as the suffix. If the SETOP member name that is created by appending the OPTID value is not in STEPLIB, the default SETOP member name HRFSETOP is used.

This keyword is optional. Use this keyword when a SETOP member is defined for an IMSPLEX set of IMS subsystems.

Format

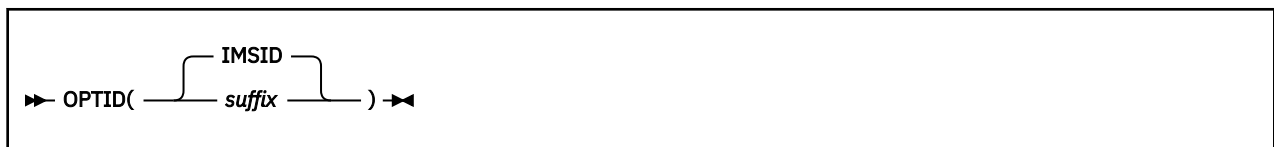

where *suffix* is a 1- to 4-character suffix.

Default value

IMSID

PARTITION keyword

Use this keyword to specify the partition to reorganize. The DBD keyword must contain the master DBD. If you do not specify the PARTITION keyword or the PARTLIST keyword, all partitions of the HALDB or PSINDEX are reorganized.

PARTITION and PARTLIST keywords are mutually exclusive.

Generally this keyword is optional because the default value is PARTITION(*), which specifies all partitions.

The following HRFSYSIN DD statement is for a full-function database that is not doing selected partition reorganization:

```
//HRFSYSIN DD *
  REORG DBD(HDOPR1) -
  ICDYN(N) ICDDN((HDOPR11,ICPR1))
//*
```

The following HRFSYSIN DD statement reorganizes the HALPART1 partition of a HALDB database:

```
//HRFSYSIN DD *
  REORG DBD(HALDB1) PARTITION(HALPART1) -
  ICDDN((HALDD1A,ICPRT1))
//*
```

The following HRFSYSIN DD statement includes the UNLOAD command but does not include the PARTITION keyword because the default is PARTITION(*), which specifies all partitions:

```
//HRFSYSIN DD *
  UNLOAD DBD(HDOPR1)
//*
```

Format

►► PARTITION(^{*} partition) ◄◄

Default value

* (All partitions)

Related reference

DD statements

When you code JCL statements to run IMS Online Reorganization Facility, you must include the appropriate DD statements.

PARTLIST keyword

Use this keyword to specify the list of partitions to reorganize. The DBD keyword must contain the master DBD.

If you do not specify the PARTITION or PARTLIST keyword, all partitions for the HALDB or PSINDEX are reorganized.

PARTITION and PARTLIST keywords are mutually exclusive.

You can specify up to 99 partitions. The specified partitions are processed in the order of this list.

For example, the following HRFSYSIN DD statement reorganizes three partitions of HALDB database HALDB1:

```
//HRFSYSIN DD *  
  REORG DBD(HALDB1) -  
  PARTLIST(HALPART4,HALPART1,HALPART6)  
/*
```

Format



Default value

None.

PARTNUM keyword

Use this keyword to specify the number of partitions in a HALDB or PSINDEX database to reorganize or unload.

The partitions are counted from the first partition that is specified by the PARTITION keyword. The number of the partitions specified by the PARTNUM keyword must be less than the total number of partitions of the HALDB or the PSINDEX database.

This keyword is optional. Use this keyword when you specify a PARTITION keyword and the value of the PARTITION keyword is not an asterisk (*).

For example, the following HRFSYSIN DD statement reorganizes three consecutive partitions of a HALDB database, starting with the HALPART4 partition:

```
//HRFSYSIN DD *  
  REORG DBD(HALDB1) PARTITION(HALPART4) PARTNUM(3)  
/*
```

Format



Default value

1

PRERES.ALLOWLC keyword

Use this keyword to control prefix resolution handling when logical children that do not have logical parents are present.

The PRERES.ALLOWLC keyword is optional for REORG HRFSYSIN DD statements.

For more information, see the topic "Control statements for Stand-Alone Prefix Resolution" in the *IMS High Performance Prefix Resolution User's Guide*.

Format

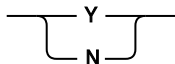
```
►► PRERES.ALLOWLC(  ) ►►
```

Default value

Determined by IMS High Performance Prefix Resolution.

PRERES.ALLOWLP keyword

Use this keyword to control prefix resolution handling when logical parents that do not have logical children are present.

The PRERES.ALLOWLP keyword is optional for REORG HRFSYSIN DD statements.

For more information, see the topic "Control statements for Stand-Alone Prefix Resolution" in the *IMS High Performance Prefix Resolution User's Guide*.

Format

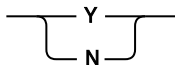
```
►► PRERES.ALLOWLP(  ) ►►
```

Default value

Determined by IMS High Performance Prefix Resolution.

PRERES.AVGRLLEN keyword

Use this keyword to optimize the use of the LPLCWKxx and TWINWKxx data sets during prefix resolution.

The PRERES.AVGRLLEN keyword is optional for REORG HRFSYSIN DD statements.

For more information, see the topic "Control statements for Stand-Alone Prefix Resolution" in the *IMS High Performance Prefix Resolution User's Guide*.

Format

```
►► PRERES.AVGRLLEN( nnn ) ►►
```

Default value

Determined by IMS High Performance Prefix Resolution.

PRERES.FILSZ keyword

Use this keyword to optimize the use of the LPLCWKxx and TWINWKxx data sets during prefix resolution.

The PRERES.FILSZ keyword is optional for REORG HRFSYSIN DD statements.

For more information, see the topic "Control statements for Stand-Alone Prefix Resolution" in the *IMS High Performance Prefix Resolution User's Guide*.

Format

```
►► PRERES.FILSZ( nnnnnnnn ) ◄◄
```

Default value

Default is determined by IMS High Performance Prefix Resolution.

PRERES.HPPRBH keyword

Use this keyword to specify whether the Prefix Update function uses the HPPR buffer handler to update OSAM data sets.

The PRERES.HPPRBH keyword is optional for REORG HRFSYSIN DD statements.

For more information, see the *IMS High Performance Prefix Resolution User's Guide*.

Format

```
►► PRERES.HPPRBH(  ) ◄◄
```

Default value

Default is determined by IMS High Performance Prefix Resolution.

PRERES.OPRTLC keyword

Use this keyword to control the printing of orphan logical children during prefix resolution.

The PRERES.OPRTLC keyword is optional for REORG HRFSYSIN DD statements.

For more information, see the topic "Control statements for Stand-Alone Prefix Resolution" in the *IMS High Performance Prefix Resolution User's Guide*.

Format

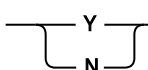
```
►► PRERES.OPRTLC(  ) ◄◄
```

Default value

Default is determined by IMS High Performance Prefix Resolution.

PRERES.OPRTLPL keyword

Use this keyword to control the printing of orphan logical parents during prefix resolution.

The PRERES.OPRTLPL keyword is optional for REORG HRFSYSIN DD statements.

For more information, see the topic "Control statements for Stand-Alone Prefix Resolution" in the *IMS High Performance Prefix Resolution User's Guide*.

Format

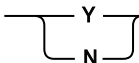
```
PRERES.OPRTLPC(  )
```

Default value

Default is determined by IMS High Performance Prefix Resolution.

PRERES.UPDLPC keyword

Use this keyword to control the updating of the counter in logical parents during prefix resolution.

The PRERES.UPDLPC keyword is optional for REORG HRFSYSIN DD statements.

For more information, see the *IMS High Performance Prefix Resolution User's Guide*.

Format

```
PRERES.UPDLPC(  )
```

Default value

Default is determined by IMS High Performance Prefix Resolution.

PRERES.XAVGLEN keyword

Use this keyword to optimize the use of the INDXWKxx data set during prefix resolution.

The PRERES.XAVGLEN keyword is optional for REORG HRFSYSIN DD statements.

For more information, see the topic "Control statements for Stand-Alone Prefix Resolution" in the *IMS High Performance Prefix Resolution User's Guide*.

Format

```
PRERES.XAVGLEN( nnn )
```

Default value

Default is determined by IMS High Performance Prefix Resolution.

PRERES.XFILSZ keyword

Use this keyword to optimize the use of the INDXWKxx data set during prefix resolution.

The PRERES.XFILSZ keyword is optional for REORG HRFSYSIN DD statements.

For more information, see the topic "Control statements for Stand-Alone Prefix Resolution" in the *IMS High Performance Prefix Resolution User's Guide*.

Format

►► PRERES.XFILSZ(nnnnnnnn) ◄◄

Default value

Default is determined by IMS High Performance Prefix Resolution.

PSINDEXBLD keyword

Use this keyword to specify whether the partitioned secondary indexes (PSINDEXes) for the database are built during the reorganization.

The PSINDEXBLD keyword is optional for REORG HRFSYSIN DD statements.

This keyword is effective only when the primary database is a HALDB and one or more PSINDEXes are defined to the HALDB. To apply PSINDEXBLD(Y), all of the following conditions must be met:

- Both IMS High Performance Load and IMS Index Builder load libraries are included in the STEPLIB concatenation.
- Reorganization of all partitions of the HALDB are requested in the IMS Online Reorganization Facility job.
- Either the WFHLQ base configuration parameter or the RELOAD.WFPHLQ keyword is specified.

Format

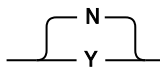
►► PSINDEXBLD() ◄◄

Default value

N

PTRCHECK keyword

Use this keyword to specify whether HASH Check concurrently checks the pointers of the image copies. If PTRCHECK is set to (Y), IMS High Performance Pointer Checker load library must be in the STEPLIB.

The PTRCHECK keyword is optional for REORG HRFSYSIN DD statements.

Format

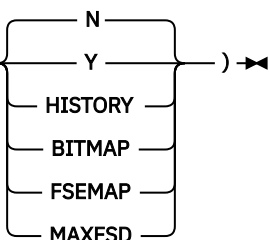
►► PTRCHECK() ◄◄

Default value

N

READON keyword

Use this keyword to specify whether to allow read-only DL/I batch jobs to access the database which the IMS Online Reorganization Facility job is processing.

Specify one of the following values:

READON(Y)

IMS Online Reorganization Facility turns on the READ ONLY flag in DBRC for the target database at the end of the Verification phase. Read-only DL/I batch jobs are allowed to access the database before the Takeover phase. If a read-only DL/I batch job is running when the IMS Online Reorganization Facility job is ready for Takeover, IMS Online Reorganization Facility makes retry attempts every 10 seconds up to the number specified by the DLIRETRY base configuration parameter. When the number is exceeded, the IMS Online Reorganization Facility job stops.



Attention: Because IMS Online Reorganization Facility turns on the READ ONLY flag, online subsystems that have not been authorized before the IMS Online Reorganization Facility job started are prevented from updates during the reorganization.

READON(N)

IMS Online Reorganization Facility turns on the REORG INTENT flag in DBRC for the target database at the end of the Verification phase. No DL/I batch jobs are allowed to access the database during the reorganization.

Format



Default value

N

READONLY keyword

Use this keyword to specify whether to put the index into read-only mode during index reorganization. If you specify READONLY(Y), the index is put into read-only mode. If you specify READONLY(N), the database is updatable.

If the database specified in the DBD is not an index, this keyword is ignored.

Format



Default value

N

RELOAD.DBIOBUF keyword

Use this keyword to specify the DBIOBUF (VSAM or BSAM I/O buffers) option that IMS High Performance Load manages during the reorganization.

The RELOAD.DBIOBUF keyword is optional for REORG HRFSYSIN DD statements.

For more information, see the topic "DBIOBUF control statement" in the *IMS High Performance Load User's Guide*.

Format

```
➤ RELOAD.DBIOBUF( nnn ) ➤
```

Default value

Determined by IMS High Performance Load.

RELOAD.DBRLBUF keyword

Use this keyword to specify the DBRLBUF (load buffers) option that IMS High Performance Load uses during the reorganization.

The RELOAD.DBRLBUF keyword is optional for REORG HRFSYSIN DD statements.

For more information, see the topic "DBRLBUF control statement" in the *IMS High Performance Load User's Guide*.

Format

```
➤ RELOAD.DBRLBUF( nnn ) ➤
```

Default value

Determined by IMS High Performance Load.

RELOAD.FRSPC keyword

Use this keyword to specify the FRSPC (free space) option that IMS High Performance Load uses during the reorganization.

The RELOAD.FRSPC keyword is optional for REORG HRFSYSIN DD statements.

For more information, see the topic "FRSPC control statement" in the *IMS High Performance Load User's Guide*.

Format

```
➤ RELOAD.FRSPC(  $\begin{array}{c} \text{--- Y ---} \\ | \\ \text{--- N ---} \end{array}$  ) ➤
```

Default value

Determined by IMS High Performance Load.

RELOAD.HPIO keyword

Use this keyword to specify the HPIO performance option that IMS High Performance Load uses during the reorganization. If you do not specify this keyword in the HRFSYSIN, the IMS High Performance Load default value is used.

The RELOAD.HPIO keyword is optional for REORG HRFSYSIN DD statements.

For more information, see the topic "HPIO control statement" in the *IMS High Performance Load User's Guide*.

Format

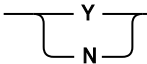
```
➤ RELOAD.HPIO(  ) ➤
```

Default value

Determined by IMS High Performance Load.

RELOAD.OADSPR keyword

Use this keyword to affect how IMS High Performance Load uses data space storage during the Reload step.

The RELOAD.OADSPR keyword is optional for REORG HRFSYSIN DD statements.

For more information, see the topic "OADSPR control statement" in the *IMS High Performance Load User's Guide*.

Format

```
➤ RELOAD.OADSPR(  ) ➤
```

Default value

Determined by IMS High Performance Load.

RELOAD.RAAFORMAT keyword

Use this keyword to specify the RAAFORMAT (format of the root addressable area) option that IMS High Performance Load uses during the reorganization.

The RELOAD.RAAFORMAT keyword is optional for REORG HRFSYSIN DD statements.

For more information, see the topic "RAAFORMAT control statement" in the *IMS High Performance Load User's Guide*.

Format

```
➤ RELOAD.RAAFORMAT(  ) ➤
```

Default value

Determined by IMS High Performance Load.

RELOAD.SEARCH keyword

Use this keyword to specify the SEARCH algorithm that IMS High Performance Load uses during the reorganization.

The RELOAD.SEARCH keyword is optional for REORG HRFSYSIN DD statements.

For more information, see the topic "SEARCH control statement" in the *IMS High Performance Load User's Guide*.

Format



Default value

Determined by IMS High Performance Load.

RELOAD.SORT keyword

Use this keyword to cause IMS High Performance Load to invoke the physical sequential sort before reloading any data in the Reload step.

The RELOAD.SORT keyword is optional for REORG HRFSYSIN DD statements.

If the reorganization job implements DBD changes that might cause the sequence of the database records to change, you must specify RELOAD.SORT(Y) to perform a physical sequential sort during the Reload step. If you do not specify the RELOAD.SORT keyword in HRFSYSIN, the IMS High Performance Load default is used.

For more information, see the topic "SORT control statement" in the *IMS High Performance Load User's Guide*.

Format

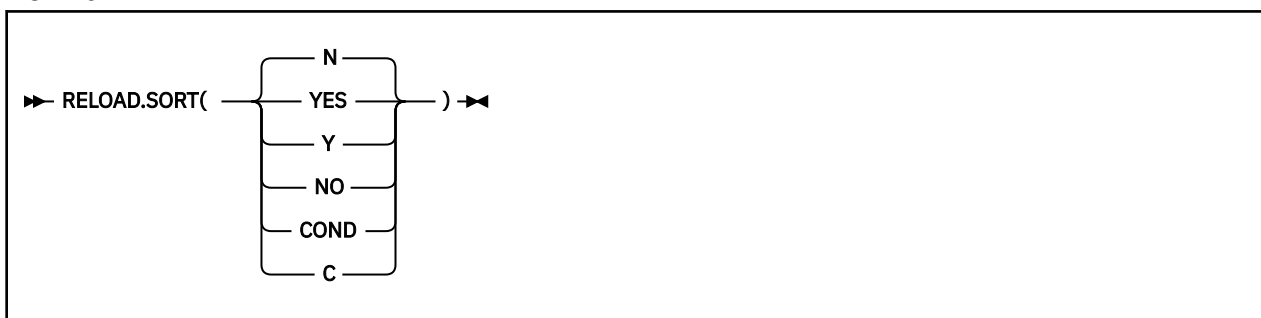

Default value

N

RELOAD.USEREXIT keyword

Use this keyword to specify the name of the user exit to use for data conversion or manipulation of the database during reload. User exits are only supported during the reload of the database.

The RELOAD.USEREXIT keyword is optional for REORG HRFSYSIN DD statements.

For more information, see the topic "USEREXIT control statement" in the *IMS High Performance Load User's Guide*.

Format

```
➤ RELOAD.USEREXIT( exitname ) ➤
```

Default value

None.

RELOAD.WF1HLQ keyword

Use this keyword to specify the high-level qualifier of the WF1 data sets that IMS High Performance Load generates during the reorganization when the database has external logical relationships.

The value must be a 1- to 26-character data set name.

The RELOAD.WF1HLQ keyword is optional for REORG HRFSYSIN DD statements. This keyword is effective only when both of the following conditions are met:

- The database has external logical relationships.
- The database is not a HALDB.

Format

```
➤ RELOAD.WF1HLQ( dsn ) ➤
```

Default value

Determined by the WFHLQ base configuration parameter.

RELOAD.WF1SPACE keyword

Use this keyword to specify the SPACE parameter for the WF1 data sets when IMS High Performance Load dynamically allocates WF1 data sets during the reorganization.

The RELOAD.WF1SPACE keyword is optional for REORG HRFSYSIN DD statements. This keyword is effective only when both of the following conditions are met:

- The database has logical relationships.
- The database is not a HALDB.

If this keyword is not specified, IMS High Performance Load estimates the size based on the allocation size of the database data set.

The following variables are supported:

uuu

The space allocation unit. The valid values are 'CYL' and 'TRK'.

pppp

The primary space quantity. It must be in the range of 1 - 9999.

ssss

The secondary space quantity. It must be in the range of 1 - 9999.

For more information, see the topic "WF1SPACE control statement" in the *IMS High Performance Load User's Guide*.

Format

```
➤ RELOAD.WF1SPACE( uuu,pppp,sss ) ➤
```

Default value

None.

RELOAD.WF1UNIT keyword

Use this keyword to specify the device for the WF1 data sets when IMS High Performance Load dynamically allocates WF1 data sets during the reorganization.

The RELOAD.WF1UNIT keyword is optional for REORG HRFSYSIN DD statements. This keyword is effective only when both of the following conditions are met:

- The database has logical relationships.
- The database is not a HALDB.

For more information, see the topic "WF1UNIT control statement" in the *IMS High Performance Load User's Guide*.

Format

```
➤ RELOAD.WF1UNIT( unitname ) ➤
```

Default value

Determined by the WFUNIT base configuration parameter.

RELOAD.WF1VOL keyword

Use this keyword to specify the volume names for the WF1 data set when IMS High Performance Load dynamically allocates WF1 data set during the reorganization. You can specify up to five volume names. You can indicate nonspecific volumes by designating an asterisk (*).

The RELOAD.WF1VOL keyword is optional for REORG HRFSYSIN DD statements. This keyword is effective only when both of the following conditions are met:

- The database has logical relationships.
- The database is not a HALDB.

For more information, see the topic "WF1VOL control statement" in the *IMS High Performance Load User's Guide*.

Format

```
➤ RELOAD.WF1VOL( volname ) ➤
```

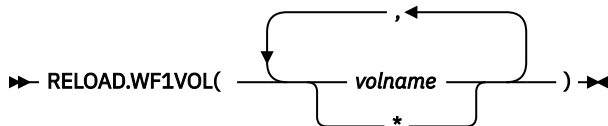

Default value

None.

RELOAD.WFPHLQ keyword

Use this keyword to specify the high-level qualifier of the WFP data sets that are generated by IMS High Performance Load during the reorganization.

The value must be a 1- to 32-character data set prefix.

The RELOAD.WFPHLQ keyword is optional for REORG HRFSYSIN DD statements.

This keyword is effective only when PSINDEXBLD(Y) is specified.

For more information, see the topic "WFPHLQ control statement" in the *IMS High Performance Load User's Guide*.

Format

```
►► RELOAD.WFPHLQ( wfphlq ) ◄◄
```

Default value

Determined by the WFHLQ base configuration parameter.

RELOAD.WFPSPACE keyword

Use this keyword to specify the SPACE parameter for the WFP data sets when IMS High Performance Load dynamically allocates WFP data sets during the reorganization.

The RELOAD.WFPSPACE keyword is optional for REORG HRFSYSIN DD statements.

This keyword is effective only when PSINDEXBLD(Y) is specified. If the RELOAD.WFPSPACE keyword is not specified, IMS High Performance Load estimates the size based on the allocation size of the partition data set.

The following variables are supported:

uuu

The space allocation unit. The valid values are 'CYL' and 'TRK'.

pppp

The primary space quantity. It must be in the range of 1 - 9999.

ssss

The secondary space quantity. It must be in the range of 1 - 9999.

For more information, see the topic "WFPSPACE control statement" in the *IMS High Performance Load User's Guide*.

Format

```
►► RELOAD.WFPSPACE( uuu,pppp,ssss ) ◄◄
```

Default value

Determined by IMS High Performance Load.

RELOAD.WFPUNIT keyword

Use this keyword to specify the device for the WFP data sets when IMS High Performance Load dynamically allocates WFP data sets during the reorganization.

The RELOAD.WFPUNIT keyword is optional for REORG HRFSYSIN DD statements.

This keyword is effective only when PSINDEXBLD(Y) is specified.

For more information, see the topic "WFPUNIT control statement" in the *IMS High Performance Load User's Guide*.

Format

```
➤ RELOAD.WFPUNIT( unitname ) ➤
```

Default value

Determined by the WFPUNIT base configuration parameter.

RELOAD.WFPVOL keyword

Use this keyword to specify the volume names for the WFP data sets when IMS High Performance Load dynamically allocates WFP data sets during the reorganization.

You can specify up to five volume names. You can indicate nonspecific volumes by designating an asterisk (*).

The RELOAD.WFPVOL keyword is optional for REORG HRFSYSIN DD statements.

This keyword is effective only when PSINDEXBLD(Y) is specified.

For more information, see the topic "WFPVOL control statement" in the *IMS High Performance Load User's Guide*.

Format

```
➤ RELOAD.WFPVOL( volname ) ➤
```

Default value

Determined by IMS High Performance Load.

RELOAD.WFPVOLCNT keyword

Use this keyword to specify the volume count for the WFP data sets that are generated by IMS High Performance Load during the reorganization.

The value must be in the range of 1 - 59.

The RELOAD.WFPVOLCNT keyword is optional for REORG HRFSYSIN DD statements.

This keyword is effective only when PSINDEXBLD(Y) is specified.

For more information, see the topic "WFPVOLCNT control statement" in the *IMS High Performance Load User's Guide*.

Format

```
➤ RELOAD.WFPVOLCNT( nn ) ➤
```

Default value

Determined by IMS High Performance Load.

RESTART keyword

Use this keyword to specify whether IMS Online Reorganization Facility continues with a TAKEOVER-restart if it detects that the previous job failed.

The RESTART keyword is optional for REORG HRFSYSIN DD statements.

If you specify RESTART(AUTOMATIC) or RESTART(AUTO) and the restart data set contains a restart record for the previous job, the Takeover phase restarts from where it last ended.

If you specify RESTART(NO) or RESTART(N) and the restart data set contains a restart record for the previous job, IMS Online Reorganization Facility issues a message to inform you that a prior job failed, a restart is required, and you might need to investigate.

Specify RESTART(OVERRIDE) only if a previous job failed during the Takeover phase and you manually recovered the database.



Attention: If you specify RESTART(OVERRIDE) without first manually recovering the database, data integrity problems might occur. Specifying RESTART(OVERRIDE) causes the job to override the restart record in the restart data set. Be aware that after the restart record is overridden, you cannot restart the failed or delayed job.

Format

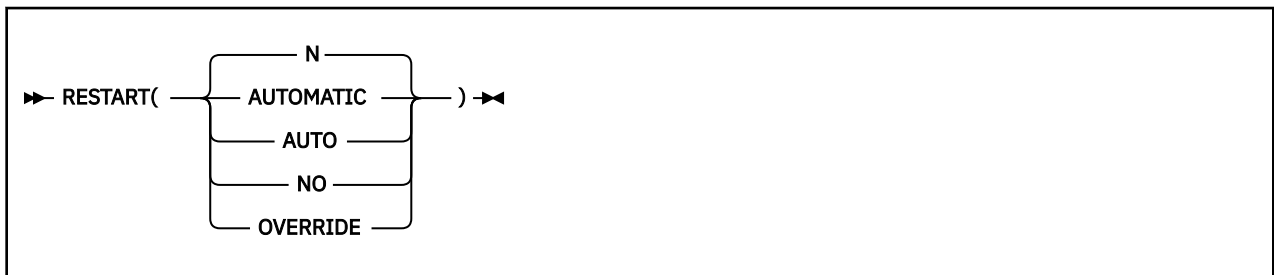

Default value

N

SASJOBPREF keyword

Use this keyword to specify the job name prefix of sub address spaces (SAS) that IMS Online Reorganization Facility creates during the reorganization when the database has external logical relationships.

You can specify up to 6-character prefix.

The SASJOBPREF keyword is optional for REORG HRFSYSIN DD statements. This keyword is effective only when the database has external logical relationships.

Format

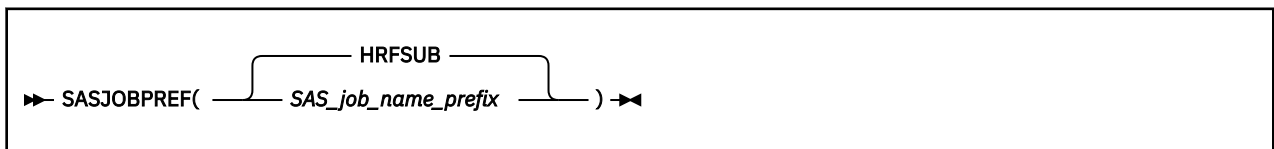

Default value

HRFSUB

SASMAX keyword

Use this keyword to specify the maximum number of sub address spaces (SAS) that IMS Online Reorganization Facility dynamically creates during the reorganization when the database has external logical relationships.

The SASMAX keyword is optional for REORG HRFSYSIN DD statements. This keyword is effective only when the database has external logical relationships.

Format

► SASMAX(1-14) ◄

Default value

The number of databases in the logical group.

SHADOW keyword

Use this keyword to specify whether all shadow data sets exist as predefined shadows or whether IMS Online Reorganization Facility will delete or define the shadows.

This keyword is optional.

When the DDEFPS2 DD statement is specified, the SHADOW keyword is effective for the specified database data sets only in the Copy phase.

Specify one of the following options:

- SHADOW(A) to specify that IMS Online Reorganization Facility deletes the shadows if they exist, and then uses the attributes of the original data sets to define shadows.
- SHADOW(E) to specify that predefined shadows exist. Use this option when you want to use different attributes for cluster definition from those that the original data set uses.
- SHADOW(R) to specify that IMS Online Reorganization Facility deletes the shadows if they exist, and then uses the attributes of the original data sets to define shadows. The allocated size of the original data sets is used for the primary allocation size. Use this option to store all of the database records in the primary extent of the database data sets after reorganization.



Attention:

- If the original data sets are SMS-managed multi-volume data sets with the guaranteed space attribute, using SHADOW(R) might cause the shadow data sets to be larger than necessary because SMS preallocates primary space on all volumes.
- If DFDSS=Y is set in the base configuration module, the attributes of the shadow data sets are determined by DFSMSdss unless you specify SHADOW(E).

Format

► SHADOW($\left. \begin{array}{l} \text{A} \\ \text{E} \\ \text{R} \end{array} \right\}$) ◄

where:

A
Allocate

E

Exist

R

Allocate and resize

Default value

A (Allocate)

SORTNUM keyword

Use this keyword to specify the segment count threshold to switch from in-memory processing to using external sorting when IMS Online Reorganization Facility reorganizes a database that has non-unique keys. If the number of segments exceeds this value, IMS Online Reorganization Facility uses external sorting to map the relative byte addresses (RBAs) of segments between the original database and the shadow database.

The SORTNUM keyword is optional for REORG HRFSYSIN DD statements.

This keyword is effective only when you use IMS High Performance Unload. If you do not use IMS High Performance Unload, external sorting is used.

Format**Default value**

5000

STORCLAS keyword

Use this keyword to specify the SMS storage class to use for the dynamic allocation of image copy data sets. This keyword is ignored if the ICEIN keyword is specified.

The STORCLAS keyword is optional for REORG HRFSYSIN DD statements.

Format**Default value**

None.

TAKEOVER keyword

Use this keyword to specify whether IMS Online Reorganization Facility performs the Takeover phase, which affects the original database.

The TAKEOVER keyword is optional for REORG HRFSYSIN DD statements.

If you specify TAKEOVER(Delay), the original data sets are not affected. After the reorganization process and before the databases are brought online, you can perform manual steps, if necessary. The database remains in the DB recovery needed state with the prohibit authorization flag set in DBRC. Restart

information is saved in a restart data set. To complete the Takeover phase, specify the TAKEOVER(Y) and RESTART(AUTO) keywords and resubmit the job.

If you specify TAKEOVER(Y), the original databases are swapped with the shadow data sets. After the Takeover phase completes, the reorganized databases are made available online and the reorganization is considered complete.

You must specify TAKEOVER(Y) if you specify all of the following keywords: ONLINECHANGE(Y), DELETE(Y), and DBDCOPY(Y).

If you specify TAKEOVER(BACKOUT) and the job abends during the Takeover phase, IMS Online Reorganization Facility backs out any changes it has made during the Takeover phase.

TAKEOVER(BACKOUT) is ignored, and processing continues as TAKEOVER(Y) because one of the following conditions is detected.

- NEWDBD keyword is specified.
- There are records in the restart data set in RESTART(AUTO).

Format



Default value

Determined by the TAKEOVER base configuration parameter.

TAKEOVER.WINDOW keyword

Use this keyword to specify the time period for the Takeover phase and to define the action to take if the Takeover phase does not start before the end of the time period.

The TAKEOVER.WINDOW keyword is optional for REORG HRFSYSIN DD statements.

This keyword is applicable only if TAKEOVER(Y) is specified.

This keyword is not applicable during a RESTART.

Specify begHH:MM to start the Takeover phase at a specific time. If IMS Online Reorganization Facility is ready for the Takeover phase before begHH:MM, a message is issued and the program goes into idle mode. Any changes that occur are captured and applied to the database. After the time that is specified by begHH:MM, IMS Online Reorganization Facility begins the Takeover phase. Any time that the IMS Online Reorganization Facility job idles, you can specify an MVS modify (/F jobname,TAKEOVER) to begin the Takeover phase.

Optionally specify endHH:MM to ensure that the Takeover phase does not start after the specified time.

Specify an endaction to specify the action to take if the Takeover phase does not start before the end of the time period (endHH:MM). endaction is applicable only if you specify endHH:MM. Valid values for endaction are:

ABEND

Abend the job if the Takeover phase has not started.

NEXTDAY

Reset the time period for the next day. NEXTDAY is valid only if you specify begHH:MM.

WTOR

Issue a WTOR to query the operator for the action to take.

Format

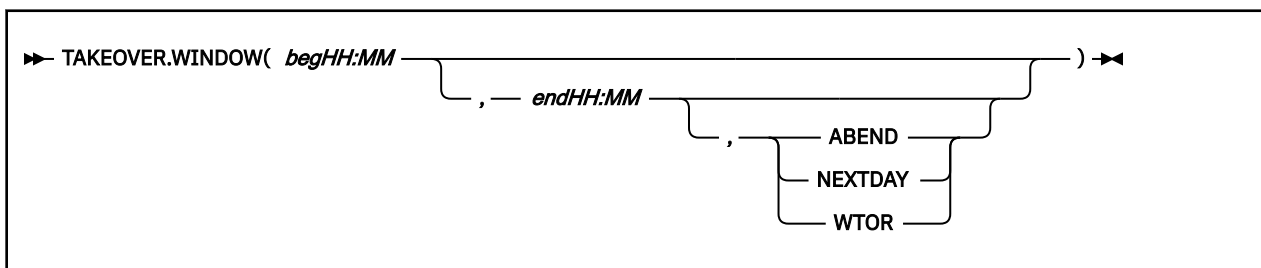

Valid values are 00:00 to 23:59. Times are in 24-hour time.

The following example specifies a takeover period from 5 PM to 5:15 PM. If the Takeover phase does not start within that period, a WTOR is issued.

```
TAKEOVER.WINDOW(17:00,17:15,WTOR)
```

Default value

Begin the Takeover phase when ready.

TEMPRECOV keyword

When the database specified in the DBD is PSINDEX and defined as non-recoverable in the RECON, use this keyword to reorganize only the selected partitions.

When TEMPRECOV(Y) is specified, database definition in the RECON is temporarily changed to recoverable only during reorganization. This means that before and after the reorganization, IMS Online Reorganization Facility issues the /DBR command to the master PSINDEX DBD in addition to the partition to reorganize. When the /DBR command is issued, the entire HALDB database temporarily becomes unavailable.

TEMPRECOV(Y) is effective only when all of the following conditions are met. Otherwise, this keyword is ignored:

- The database specified in the DBD is PSINDEX and defined as non-recoverable in the RECON
- Not all the partitions are specified for reorganization; only the selected partitions are specified by the PARTITION or PARTLIST keyword
- READONLY(Y) is not concurrently specified

Format

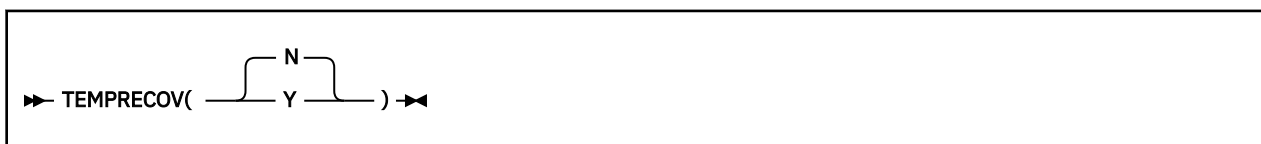

Default value

N

UNLSPAC keyword

Specifies a 4-digit numeric space allocation value for unload data set allocations.

Specify a numeric value for the number of cylinders to allocate to each temporary data set.

The number of data sets that are allocated is determined by IMS Online Reorganization Facility.

The following variable is supported:

ssss

The secondary space quantity. It must be in the range of 1 - 3000.

Format

```
▶ UNLSPAC( ssss ) ◀
```

Default value

Determined by the UNLSPAC base configuration parameter.

UNLUNIT keyword

Specifies any valid direct-access 8-character unit name for unload data set allocations.

Format

```
▶ UNLUNIT( unitname ) ◀
```

Default value

Determined by the UNLUNIT base configuration parameter.

VOLALLO keyword

Use this keyword to override the space allocation when creating the database data sets.

The VOLALLO keyword is optional for REORG HRFSYSIN DD statements.

When the DDEFPS2 DD statement is specified, the VOLALLO keyword is effective for the specified database data sets only in the Copy phase.

Format

```
▶ VOLALLO( nn,pppp,ssss ) ◀
```

0,300,300

where:

nn

Number of volumes to use. This parameter is for SMS-controlled allocations. If *nn* is greater than 1, candidate volumes are defined. If *nn* is 0, the VOLALLO keyword is ignored. The default is 0.

pppp

Number of cylinders for the primary allocation. The default is 300, and the maximum is 2000.

ssss

Number of cylinders for the secondary allocation. The default is 300, and the maximum is 2000.

Default value

(0,300,300)

Takeover restart processing

IMS Online Reorganization Facility allows a Takeover phase restart to occur if the previous reorganization job failed or was delayed during the Takeover phase. When a takeover restart occurs, the Takeover phase automatically restarts from where it stopped to continue IMS Online Reorganization Facility processing.

The restart key-sequenced data set, which is defined during installation, ensures data integrity and availability if a reorganization fails or is delayed. IMS Online Reorganization Facility stores information that is required to restart during the Takeover phase in this data set. At the beginning of each job, this data set is read to determine if a restart record exists for a specific DBD or partition name.

A restart can be performed when the previous online reorganization job for a specific database (DBD name or partition name) failed during the Takeover phase or was delayed (TAKEOVER(DELAY)) by the previous control statements.

If the control statements or restart data set are not modified, the next time that the same reorganization job runs, IMS Online Reorganization Facility reads the data in the restart data set at the beginning of the job and detects a restart pending. If you specified RESTART(AUTOMATIC), a restart automatically begins. If the restart completes successfully, the database is made available online, and the restart data is removed from the restart data set so that subsequent jobs can start from the beginning.

If you specified RESTART(AUTOMATIC) and IEFORDER DD with DISP=(,CATLG,DELETE) as described in some examples in the IMS Online Reorganization Facility documentation, you must change this DD statement to DISP=OLD after the previous online reorganization job for a specific database (DBD name or partition name) failed during the Takeover phase.

The default is RESTART(N). In this case, the reorganization job fails with the following error message:

```
HRF01147E  RESTART(N0) specified for this execution
```

To allow a restart to begin, you must change the RESTART option to RESTART(AUTOMATIC).

If you recovered the database or partition or if you do not need to perform a restart, specify RESTART(OVERRIDE) to override the restart status. Generally, if you manually recovered the database or the database state, you can consider using the RESTART(OVERRIDE) option. In this case, the reorganization job starts at the first phase as though a restart pending never occurred.



Attention: Use the RESTART(OVERRIDE) option with caution because this option removes the restart data for the database or partition from the restart data set.

DBD change during reorganization

To change the DBD during an online reorganization, specify the NEWDBD keyword.

Subsections:

- [“DBD change when ACB libraries are used” on page 100](#)
- [“DBD change when IMS manages ACBs” on page 102](#)

DBD change when ACB libraries are used

When the NEWDBD keyword is specified, the shadow database is unloaded by using the current DBD library specified with the IMS DD statement, then reloaded by using the DBD library whose DD name is specified with the NEWDBD keyword. If the DBD change does not involve changes to PSBs, no manual intervention is required after reorganization.

IMS Online Reorganization Facility performs the following actions during the Takeover phase:

1. Copies the new DBD to the current DBD library specified with the IMS DD statement.
2. Performs an ACBGEN in the staging ACBLIB specified with the IMSACB DD statement to generate a DMB for the new DBD.
3. Updates the IMS catalog with the new DBD when the following conditions are met.

- a. CATALOG=Y and ACBMGMT=ACBLIB are defined in the DFSDF member of the IMS system.
- b. The name of the IMS catalog database is defined in the RECON record with the following DBRC command: CHANGE RECON CATALOG(*name*)
- c. PROCLIB DD is specified in the IMS Online Reorganization Facility job.
- d. DFSDF keyword is specified in HRFSYSIN.

Attention: If DFS3PU00 ended with an error, you must manually rerun the job.

Recommendation: If you are updating an existing IMS catalog, create an image copy of the IMS catalog data sets when the updates are complete. You can create a batch image copy of a database using the ORF IMAGECOPY command while the database remains online.

4. Copies the new DMB from the staging ACBLIB to the IMSACBA and IMSACBB libraries.
5. Activates the new DMB in the current IMS subsystems.

Requirement: Because IMS Online Reorganization Facility performs an ACBGEN, you must include both the current DBD and PSB libraries in the IMS DD concatenation.

You can specify two keywords that affect the final stages of DBD or DMB replacement: ONLINECHANGE and DBDCOPY. These keywords are effective when the NEWDBD keyword is specified and the parameter for the TAKEOVER keyword is not N.

Recommendation: If you plan DBD changes, consider enabling the following options:

- ONLINECHANGE(Y) to avoid manual intervention at the end of the reorganization.
- DBDCOPY(Y) to avoid out-of-sync situations between the DBDLIB and the ACBLIB.



Attention: If the DBD change involves changes to PSBs, IMS Online Reorganization Facility requires a setting of ONLINECHANGE(N) because it cannot update PSBs in online IMS subsystems. You must manually perform an online change after the reorganization.

ONLINECHANGE

Use the ONLINECHANGE keyword to indicate whether a DMB replacement (similar to IMS online change) is done to complete the takeover process and make the database available.

If you specify ONLINECHANGE(Y), the following actions occur:

- Before the database is started in online systems, a DMB is loaded.
- The DMB-type ACB members are copied from the staging ACBLIB into the IMSACBA and IMSACBB libraries. Specifying the IMSACBA and IMSACBB DD statements is optional when the online systems are available during the phase and they do not use dynamic allocation for IMSACBA and IMSACBB libraries. In this case, IMS Online Reorganization Facility obtains both the active and inactive ACB libraries that are allocated to the online systems; otherwise you must specify the IMSACBA and IMSACBB DD statements in the JCL.
- If the IMSACBA and IMSACBB DD statements that you specify in the JCL are different from the available online systems, the DMB-type ACB members are copied to the libraries that the JCL specifies and to the ACB libraries that are allocated in the control region.

If you specify ONLINECHANGE(N), DMB is not replaced and copy to the IMSACBA and IMSACBB libraries is not performed. After the ACBGEN is performed in the staging ACBLIB, the database remains offline in prohibit authorization status. Perform these steps to complete the DBD change:

1. Use the Online Change Copy utility (DFSUOCU0) and copy the staging ACBLIB to the inactive ACBLIB. Skip this step if you use ACB library member online change.
2. Perform an IMS online change.
3. If the Integrity Checker utility of IMS Library Integrity Utilities is active in your environment, use the LICON utility and re-create the RDE.
4. Turn off the prohibit authorization flag and bring the database back online.

DBDCOPY

Use the DBDCOPY keyword to indicate whether to copy the new DBD to the current DBDLIB (IMS DD statement).

If the Integrity Checker utility of IMS Library Integrity Utilities is active in your environment, you can specify both DBDCOPY(Y) and ONLINECHANGE(Y) to update the unique ID of the DBD. IMS Online Reorganization Facility uses IMS Library Integrity Utilities to recalculate the unique ID for the DBD.

The results from the DBDCOPY and ONLINECHANGE copies are found in the IEBPRINT output of the IMS Online Reorganization Facility job.

If the ACBGEN, the DBDCOPY, or the online change fails, a message is written to MSGPRINT and to the applicable output data sets, such as IEBPRINT and SYSPRINT.

If any of these operations fail, the database is left in prohibit authorization status and remains unavailable to the online systems until you manually fix the problem, complete the unfinished operations, and restart the database.

DBD change when IMS manages ACBs

When the NEWDBD(*STAGING) keyword is specified in the IMS Online Reorganization Facility job, the shadow database is unloaded by using the active database definition obtained from the IMS catalog directory data sets, then reloaded by using the pending database definition obtained from the IMS catalog staging data sets. After the reorganization, the IMS Online Reorganization Facility job leaves the reorganized database offline and ends with return code 4. You must manually activate the new database definition by issuing the IMPORT DEFN SOURCE(CATALOG) command.

Requirement: Before running the IMS Online Reorganization Facility job, the new database definitions and all index definitions must exist in the IMS catalog staging data sets.

When IMS manages ACBs, the only supported value for the NEWDBD keyword is *STAGING. When NEWDBD(*STAGING) is specified, ONLINECHANGE(N) is forced and the DBDCOPY keyword is ignored. After the reorganized shadow data sets are swapped with the original database data sets, the database remains offline in prohibit authorization status. Perform these steps to complete the DBD change:

1. Issue the IMPORT DEFN SOURCE(CATALOG) command to activate the new database definition.
2. If the Integrity Checker utility of IMS Library Integrity Utilities is active in your environment, use the LICON utility and re-create the RDE.
3. Turn off the prohibit authorization flag and bring the database back online.

Scheduling online reorganization jobs with Autonomics Director

If you use IMS Tools Base Autonomics Director, you can schedule online reorganization jobs of IMS Online Reorganization Facility. To schedule online reorganization jobs, you must prepare skeleton JCL for Autonomics Director and establish the environment for automatic online reorganization.

Procedure

1. Configure Autonomics Director. For configuration information, see the topic "Configuring Autonomics Director" in the *IMS Tools Base Configuration Guide*.

When you configure Autonomics Director, you create skeleton JCL for Autonomics Director. The JCL is used to automatically generate online reorganization JCL.

For DD statements and control statements of IMS Online Reorganization Facility, see ["DD statements" on page 36](#) and ["HRFSYSIN DD statement" on page 46](#).

2. Using the Autonomics Director ISPF interface, establish the environment for automatic online reorganization.

For instructions, see the topic "Automate monitoring and maintenance tasks" in the *IMS Tools Base Autonomics Director User's Guide and Reference*.

What to do next

The Autonomics Director scheduler initiates the job based on the schedule.

When an online reorganization job completes, IMS Online Reorganization Facility sends a notification about the result of the online reorganization. To verify the completion of online reorganization jobs, use the Autonomics Director ISPF interface.

Examples for IMS Online Reorganization Facility

The examples provided in the following topics show some of the typical ways that you can use the IMS Online Reorganization Facility.

Example: Reorganizing a HIDAM using static allocation of image copy and log data sets

The JCL example in this topic reorganizes a HIDAM database that has no secondary indexes. The JCL specifies to statically allocate both the log data set and image copy data sets. After the completion of the job, the HIDAM database remains online because the reorganization process is done in a single job step.

```
//*-----  
/* Online Reorganization of a HIDAM OSAM database with no secondary indexes  
/* (no DBD changes)  
/*-----  
//ORF EXEC PGM=HRFREORG,REGION=80M  
//STEPLIB DD DSN=DBSP.SHRFLD,DISP=SHR  
// DD DSN=your_userlib,DISP=SHR <=== ROUTINES  
// DD DSN=DBSP.SHPSLMD0,DISP=SHR <=== IMS TOOLS  
// DD DSN=IMS.SDFSRESL,DISP=SHR  
//IMS DD DSN=your_dbdlib,DISP=SHR  
//IMSDALIB DD DSN=your_mdalib,DISP=SHR  
//IEFRDER DD DSN=ims_log_dataset,  
// DISP=(,CATLG,DELETE),  
// SPACE=(CYL,(300,50),RLSE),UNIT=SYSALLDA  
/*  
//ICPR11 DD DISP=(,CATLG,DELETE),DSN=yourhlq.HIOPR1.HIOPR11.IC(+1),  
// SPACE=(CYL,(300,50),RLSE),UNIT=SYSALLDA,DCB=(yourhlq.MODEL.DCB)  
//ICPX1 DD DISP=(,CATLG,DELETE),DSN=yourhlq.HIOPX1.HIOPX1.IC(+1),  
// SPACE=(CYL,(100,50),RLSE),UNIT=SYSALLDA,DCB=(yourhlq.MODEL.DCB)  
/*  
//HRFSYSIN DD *  
 REORG DBD(HIOPR1) -  
 ICDDN(HIOPR11,ICPR11), -  
 (HIOPX1,ICPX1)  
/*
```

Example: Reorganizing a HDAM using dynamic allocation of image copy and log data sets

The JCL example in this topic reorganizes a HDAM database that has a secondary index. The JCL does not include DD statements for log data sets and image copy data sets. IMS Online Reorganization Facility dynamically allocates the log data set based on the HRFSYSIN DD statement keywords, and IMS High Performance Image Copy dynamically allocates the image copy data sets based on the ICEIN DD statement keywords.

```

//ORFSTEP EXEC PGM=HRFREORG,REGION=80M,DYNAMNBR=999
//STEPLIB DD DSN=DBSP.SHRFLD,DISP=SHR
// DD DSN=your_userlib,DISP=SHR <=== USER ROUTINES
// DD DSN=DBSP.SHPSLMD0,DISP=SHR <=== IMS TOOLS
// DD DSN=IMS.SDFSRESL,DISP=SHR
//DFSRESLB DD DSN=IMS.SDFSRESL,DISP=SHR
//IMSDALIB DD DSN=your_mdalib,DISP=SHR
//IMS DD DSN=your_dbdlib,DISP=SHR
//HRFSYSIN DD *
REORG DBD(HDV8) -
ICEIN(ICEIN) -
LOG1DSN(your.hlq.&DBD.&DATE3.&TIME1.LOG1) -
LOG2DSN(your.hlq.&DBD.&DATE3.&TIME1.LOG2) -
LOGPRI(10) LOGSEC(10)
//ICEIN DD *
GLOBAL ICDALLOC=Y,ICHLQ=hlq1.IC,UNIT=SYSALLDA
//*

```

Example: Reorganizing a database in an IMS-managed ACBs environment

The JCL example in this topic does the same reorganization as the example provided in [“Example: Reorganizing a HDAM using dynamic allocation of image copy and log data sets”](#) on page 103. The only difference is that this JCL example is for running the job in an IMS-managed ACBs environment. The JCL does not include IMS DD statement, which describes the DBD library, because IMS Online Reorganization Facility obtains DBDs from IMS catalog.

This JCL example includes the PROCLIB DD statement and the DFSDF keyword in the HRFSYSIN DD statement, which IMS Online Reorganization Facility uses to obtain the settings and attributes of the IMS catalog. The PROCLIB DD and DFSDF keyword are ignored if the IMS Catalog Definition exit routine (DFS3CDX0) is included in the STEPLIB DD concatenation.

```

//ORFSTEP EXEC PGM=HRFREORG,REGION=80M,DYNAMNBR=999
//STEPLIB DD DSN=DBSP.SHRFLD,DISP=SHR
// DD DSN=your_userlib,DISP=SHR <=== USER ROUTINES
// DD DSN=DBSP.SHPSLMD0,DISP=SHR <=== IMS TOOLS
// DD DSN=IMS.SDFSRESL,DISP=SHR
//DFSRESLB DD DSN=IMS.SDFSRESL,DISP=SHR
//IMSDALIB DD DSN=your_mdalib,DISP=SHR
//PROCLIB DD DSN=IMS.PROCLIB,DISP=SHR <=== IMS PROCLIB
//HRFSYSIN DD *
REORG DBD(HDV8) -
DFSDF(A01) -
ICEIN(ICEIN) -
LOG1DSN(your.hlq.&DBD.&DATE3.&TIME1.LOG1) -
LOG2DSN(your.hlq.&DBD.&DATE3.&TIME1.LOG2) -
LOGPRI(10) LOGSEC(10)
//ICEIN DD *
GLOBAL ICDALLOC=Y,ICHLQ=hlq1.IC,UNIT=SYSALLDA
//*

```

Example: Changing the randomizer parameters of a HDAM database

The JCL example in this topic reorganizes a HDAM database and changes the randomizer parameters in the DBD. The new DBD, which contains the new randomizer parameters, is copied to your DBD library, and the new DMB-type ACB in your ACB library is copied to the libraries that the IMSACBA and IMSACBB DD statements specify. After the completion of the job, the HDAM database remains online because the reorganization process is done in a single job step.

```

//*-----
//*          DBDGEN (changing the randomizer parameters)
//*-----
//DBDGEN      EXEC DBDGEN,MBR=HDVPR1
//L.SYSLMOD DD DSN=your_new_dbdlib(HDVPR1),DISP=SHR
//*-----
//* Online Reorganization of an HDAM database with 2 secondary indexes
//*          (DBD changes and IC dynamic allocation)
//*-----
//ORF        EXEC PGM=HRFREORG,REGION=0M
//STEPLIB    DD DSN=DBSP.SHRFLOAD,DISP=SHR
//           DD DSN=your_mdalib,DISP=SHR
//           DD DSN=your_userlib,DISP=SHR          <=== ROUTINES
//           DD DSN=DBSP.SHPSLMD0,DISP=SHR        <=== IMS TOOLS
//           DD DSN=IMS.SDFSRESL,DISP=SHR
//IMS        DD DSN=your_dbdlib,DISP=SHR
//           DD DSN=your_psblib,DISP=SHR
//IMSACB     DD DSN=your_acblib,DISP=SHR
//IMSACBA    DD DSN=your_acbliba,DISP=SHR
//IMSACBB    DD DSN=your_acblibb,DISP=SHR
//IMSNEW     DD DSN=your_new_dbdlib,DISP=SHR      <=== changed DBDs
//IEFRDER    DD DSN=ims_log_dataset,
//           DISP=(,CATLG,DELETE),
//           SPACE=(CYL,(300,50),RLSE),UNIT=SYSALLDA
//*
//HRFSYSIN DD *
REORG DBD(HDVPR1) NEWDBD(IMSNEW) ONLINECHANGE(Y) DBDCOPY(Y) -
RELOAD, SORT(Y) -
ICDYN(Y) ICHLQ(yourhlq.IC) ICMID(2) ICTRLR(5)
//*

```

Example: Adding or removing a compression routine to a HIDAM database

The example in this topic reorganizes a HIDAM database and adds or removes a compression routine. Because such a DBD change involves changes to PSBs, ONLINECHANGE(N) must be specified. After the job ends, you must perform some post-processing tasks.

1. The following JCL example reorganizes a HIDAM database. IMS Online Reorganization Facility updates the staging ACBLIB with the new database definition, but it does not update the ACBs in online IMS subsystems. The job ends with return code 4, and the HIDAM database remains offline with the prohibit authorization flag turned on.

```

//*-----
//*          DBDGEN (adding or removing a compression exit routine)
//*-----
//DBDGEN      EXEC DBDGEN,MBR=HIOPR1
//L.SYSLMOD DD DSN=your_new_dbdlib(HIOPR1),DISP=SHR
//*-----
//* Online Reorganization of an HIDAM database with a compression routine
//* either added or removed.
//*-----
//ORF        EXEC PGM=HRFREORG,REGION=0M
//STEPLIB    DD DSN=DBSP.SHRFLOAD,DISP=SHR
//           DD DSN=your_mdalib,DISP=SHR
//           DD DSN=your_userlib,DISP=SHR          <=== ROUTINES
//           DD DSN=DBSP.SHPSLMD0,DISP=SHR        <=== IMS TOOLS
//           DD DSN=IMS.SDFSRESL,DISP=SHR
//IMS        DD DSN=your_dbdlib,DISP=SHR          <=== DBD library
//           DD DSN=your_psblib,DISP=SHR          <=== PSB library
//IMSACB     DD DSN=your_acblib,DISP=SHR          <=== staging ACB library
//IMSNEW     DD DSN=your_new_dbdlib,DISP=SHR      <--- changed DBDs
//IEFRDER    DD DSN=ims_log_dataset,
//           DISP=(,CATLG,DELETE),
//           SPACE=(CYL,(300,50),RLSE),UNIT=SYSALLDA
//*
//HRFSYSIN DD *
REORG DBD(HIOPR1) NEWDBD(IMSNEW) ONLINECHANGE(N) DBDCOPY(Y) -
ICDYN(Y) IC1DSN(DATADS. ORF. IC.&DBD.&DATE1.&TIME2)
//*

```

2. Use the Online Change Copy utility (DFSUOCU0) and copy the staging ACBLIB to the inactive ACBLIB. Skip this step if you use ACB library member online change.

The following JCL examples use the OLCUTL procedure to invoke the Online Change Copy utility.

Example for local online change

```
//ACBCOPY EXEC PROC=OLCUTL,SOUT='*',TYPE=ACB,IN=S,OUT=U
```

Example for global online change

```
//ACBCOPY EXEC PROC=OLCUTL,SOUT='*',TYPE=ACB,IN=S,OUT=G
```

3. Issue **/MODIFY** commands or **INITIATE OLC** commands to complete the IMS online change.

Local online change commands

- a. **/MODIFY PREPARE ACBLIB**
- b. **/MODIFY COMMIT**

Global online change commands

- a. **INITIATE OLC PHASE(PREPARE) TYPE(ACBLIB)**
- b. **INITIATE OLC PHASE(COMMIT)**

Global online change commands for ACB library member online change

- a. **INITIATE OLC PHASE(PREPARE) TYPE(ACBMBR) NAME(*dbdname*)**
- b. **INITIATE OLC PHASE(COMMIT)**

4. If the Integrity Checker utility of IMS Library Integrity Utilities is active in your environment, use the LICON utility and re-create the RDE.

Example for re-creating an RDE

```
//LICONUTL EXEC PGM=FABLIU00  
// DD DSN=DBSP.SHPSLMD0,DISP=SHR  
// DD DSN=IMS.SDFSRESL,DISP=SHR  
//ACBLIB DD DSN=your_acblib,DISP=SHR  
//FABLPRNT DD SYSOUT=*  
//FABLIN DD *  
INIT.DB DBD(dbdname) REPLACE  
/*
```

5. Turn off the prohibit authorization flag and restart the database. For a HALDB, you must restart both the HALDB master and each partition.

Related topics: See the following topics for IMS functions and utilities:

- "Overview of the local online change function" in *IMS System Administration*
- "Overview of the global online change function" in *IMS System Administration*
- "Online Change Copy utility (DFSUOCU0)" in *IMS System Utilities*
- "OLCUTL procedure" in *IMS System Utilities*
- "ACB library member online change" in *IMS System Administration*

Example: Changing database definition in an IMS-managed ACBs environment

The JCL example in this topic changes database definition in an IMS-managed ACBs environment.

This JCL example does the same DBD change as the example provided in "Example: Adding or removing a compression routine to a HIDAM database" on page 105. The only difference is that this JCL example is for running the job in an IMS-managed ACBs environment.

ONLINECHANGE(N) is forced regardless of the type of DBD change. Therefore, after the job ends, you must perform some post-processing tasks.

Complete the following steps to change database definitions in an IMS-managed ACBs environment:

1. Create a new database definition in the IMS catalog staging data set.
2. Review the following JCL example.

- This JCL example does not include IMS, IMSACB, and IMSNEW (the name specified by the NEWDBD keyword) DD statements because IMS Online Reorganization Facility obtains DBDs, PSBs, and ACBs from the IMS catalog if necessary.
- The NEWDBD keyword specifies NEWDBD(*STAGING). This causes IMS Online Reorganization Facility to obtain new database definitions from the IMS catalog staging data set.
- The PROCLIB DD statement and the DFSDF keyword are present to obtain the settings and attributes of the IMS catalog. If you add the IMS Catalog Definition exit routine (DFS3CDX0) to the STEPLIB DD concatenation, the PROCLIB DD statement and the DFSDF keywords are not necessary.

```

//*-----
/* Online Reorganization of an HIDAM database with a compression routine
/* either added or removed.
/*-----
//ORF      EXEC PGM=HRFREORG,REGION=0M
//STEPLIB DD DSN=DBSP.SHRFLOAD,DISP=SHR
//          DD DSN=your_mdalib,DISP=SHR
//          DD DSN=your_userlib,DISP=SHR          <=== ROUTINES
//          DD DSN=DBSP.SHPSLMD0,DISP=SHR        <=== IMS TOOLS
//          DD DSN=IMS.SDFSRESL,DISP=SHR
//PROCLIB DD DSN=IMS.PROCLIB,DISP=SHR          <=== IMS PROCLIB
//IEFRDER DD DSN=ims_log_dataset,
//          DISP=(,CATLG,DELETE),
//          SPACE=(CYL,(300,50),RLSE),UNIT=SYSALLDA
//*
//HRFSYSIN DD *
REORG DBD(HIOPR1) NEWDBD(*STAGING) ONLINECHANGE(N) DFSDF(004) -
ICDYN(Y) IC1DSN(DATADS.ORF.IC.&DBD.&DATE1.&TIME2)
//*

```

3. Issue the IMPORT DEFN SOURCE(CATALOG) command to activate the new database definition in online IMS subsystems.
4. If the Integrity Checker utility of IMS Library Integrity Utilities is active in your environment, use the LICON utility and re-create the RDE.
5. Turn off the prohibit authorization flag and bring the database back online. If the database is a HALDB, you must restart both the HALDB master and each partition.

Related topics: See the following topics for IMS functions and commands:

- "Online changes in managed-ACB environments" in *IMS System Administration*
- "Online activation of new and changed database resources when IMS manages ACBs" in *IMS Database Administration*
- "IMPORT DEFN SOURCE(CATALOG) command" in *IMS Commands*

Example: Reorganizing a partition of a PHIDAM database

The JCL example in this topic reorganizes a partition of a PHIDAM database.

```

//*-----
/* Online Reorganization of a partition of PHIDAM
/*-----
//ORF      EXEC PGM=HRFREORG,REGION=80M
//STEPLIB DD DSN=DBSP.SHRFLOAD,DISP=SHR
//          DD DSN=your_userlib,DISP=SHR          <=== ROUTINES
//          DD DSN=DBSP.SHPSLMD0,DISP=SHR        <=== IMS TOOLS
//          DD DSN=IMS.SDFSRESL,DISP=SHR
//IMS      DD DSN=your_dbdlib,DISP=SHR
//IMSDALIB DD DSN=your_mdalib,DISP=SHR
//IEFRDER DD DSN=ims_log_dataset,
//          DISP=(,CATLG,DELETE),
//          SPACE=(CYL,(300,50),RLSE),UNIT=SYSALLDA
//*
//HRFSYSIN DD *
REORG DBD(PHIDAM1) PARTITON(PHIDAM1A) -
ICDYN(Y) ICHLQ(ichlq) ICMID(3)
//*

```

Example: Reorganizing a PHDAM database and rebuilding PSINDEXes

The JCL example in this topic reorganizes a PHDAM database and rebuilds PSINDEXes.

To have PSINDEXes rebuilt during the job, the load library of IMS Index Builder and IMS High Performance Load must be included in the STEPLIB concatenation. Also reorganization of all the partitions of the target HALDB must be requested.

If the RELOAD.WFPHLQ keyword is not coded in the HRFYSIN DD, the value set for the WFHLQ base configuration parameter is applied.

```
//*-----  
/* Online Reorganization of PHDAM with rebuilding PSINDEXes  
/*-----  
//ORF EXEC PGM=HRFREORG,REGION=80M  
//STEPLIB DD DSN=DBSP.SHRFLOAD,DISP=SHR  
// DD DSN=your_userlib,DISP=SHR <=== ROUTINES  
// DD DSN=DBSP.SHPSLMD0,DISP=SHR <=== IMS TOOLS  
// DD DSN=DBSP.SIIULMOD,DISP=SHR <=== INDEX BUILDER  
// DD DSN=IMS.SDFSRESL,DISP=SHR  
//IMS DD DSN=your_dbdlib,DISP=SHR  
//IMSDALIB DD DSN=your_mdalib,DISP=SHR  
//IEFRDER DD DSN=ims_log_dataset,  
// DISP=(,CATLG,DELETE),  
// SPACE=(CYL,(300,50),RLSE),UNIT=SYSALLDA  
/*  
//HRFYSIN DD *  
REORG DBD(PHDAM1) -  
ICDYN(Y) ICHLQ(ichlq) ICMID(3) -  
PSINDEXBLD(Y) RELOAD.WFPHLQ(wfphlq)  
/*
```

Example: Reorganizing a partition of a PSINDEX

The example in this topic shows the JCL to use to reorganize a PSINDEX partition.

```
/* Reorganizing a partition of a PSINDEX  
/*-----  
//ORF EXEC PGM=HRFREORG,REGION=80M  
//STEPLIB DD DSN=DBSP.SHRFLOAD,DISP=SHR  
// DD DSN=your_userlib,DISP=SHR <=== ROUTINES  
// DD DSN=DBSP.SHPSLMD0,DISP=SHR <=== IMS TOOLS  
// DD DSN=IMS.SDFSRESL,DISP=SHR  
//IMS DD DSN=your_dbdlib,DISP=SHR  
//IMSDALIB DD DSN=your_mdalib,DISP=SHR  
//HRFYSIN DD *  
REORG DBD(PX04) PARTITION(PX04A)  
/*
```

Example: Unloading a HIDAM database

The example in this topic shows the JCL to use to unload a HIDAM OSAM database.

```
/* Unload of a HIDAM OSAM database  
/*-----  
//ORF EXEC PGM=HRFREORG,REGION=80M  
//STEPLIB DD DSN=DBSP.SHRFLOAD,DISP=SHR  
// DD DSN=your_userlib,DISP=SHR <=== ROUTINES  
// DD DSN=DBSP.SHPSLMD0,DISP=SHR <=== IMS TOOLS  
// DD DSN=IMS.SDFSRESL,DISP=SHR  
//IMS DD DSN=your_dbdlib,DISP=SHR  
//IMSDALIB DD DSN=your_mdalib,DISP=SHR  
//DFSUINPT DD DSN=your_unload_dataset,  
// DISP=(,CATLG,DELETE),  
// SPACE=(CYL,(300,50),RLSE),UNIT=SYSALLDA  
//HRFYSIN DD *  
UNLOAD DBD(HIOPR1)  
/*
```

Examples: Conditional Reorganization Support Service

You can use the Conditional Reorganization Support Service (CRSS) of IMS Database Reorganization Expert to enable conditional reorganization or to diagnose the database.

The following scenarios describe using the CRSS in IMS Online Reorganization Facility jobs and contain JCL examples for using the CRSS.

Scenario 1: Conditionally reorganizing a database by using the reorganization policy defined for the database type

To conditionally reorganize a database and obtain a Diagnosis report, run the job in Conditional Reorganization mode. This scenario is one of the most typical use cases of the Conditional Reorganization Support Service (CRSS).

The following JCL example specifies to use the reorganization policy that is defined for the database type to conditionally reorganizes a database. For example, if the target database is an HDAM database, the CRSS uses the reorganization policy for HDAM databases for policy evaluation.

When you submit the job, the CRSS evaluates the database statistics against the reorganization policy to determine if reorganization is needed. If the CRSS determines that the database requires reorganization, the reorganization process starts. If the CRSS determines that the database does not need reorganization, the CRSS reports the current database status and the job ends.

For this scenario, you must specify the following keywords in the HRFSYSIN DD statement:

- CONDREORG(Y) starts the CRSS and runs the job in Conditional Reorganization mode.
- ITKBSERVER(xxxxxxxx) specifies the XCF group name of the IMS Tools KB server.

```
//ORFJOB JOB CLASS=A
//*-----
//REORG EXEC PGM=HRFREORG, REGION=80M, DYNAMNBR=999
//STEPLIB DD DISP=SHR, DSN=ITB.SFOILOAD
// DD DISP=SHR, DSN=ITB.SHKTLOAD
// DD DISP=SHR, DSN=DBSP.SHRFLOAD
// DD DISP=SHR, DSN=DBSP.SHPSLMD0
// DD DISP=SHR, DSN=IMS.SDFSRESL
//DFSRESLB DD DISP=SHR, DSN=IMS.SDFSRESL
//IMS DD DISP=SHR, DSN=IMS.DBDLIB
//IMSDALIB DD DISP=SHR, DSN=IMS.MDALIB
//SYSPRINT DD SYSOUT=*
//HRFSYSIN DD *
REORG DBD(dbname) -
CONDREORG(Y) -
ITKBSERVER(xxxxxxxx) -
LOG1DSN(DATADS. ORF. LOG. &DBD. &DATE1. &TIME2) -
ICDYN(Y) -
IC1DSN(DATADS. ORF. IC. &DBD. &DATE1. &TIME2)
/*
```

When the job ends, review the Diagnosis report to learn the status of the database. The report is written to the job log and is also stored in the Output repository of IMS Tools KB. This report contains a policy evaluation summary message, which describes the result of the policy evaluation. For information about the policy evaluation summary message, see the topic "Checking the policy evaluation summary message" in the *IMS Database Reorganization Expert User's Guide*.

Scenario 2: Conditionally reorganizing a database based on the number of days since the last reorganization

If the reorganization policy uses the IBM.LAST_REORG.10 rule, the Conditional Reorganization Support Service (CRSS) evaluates the number of days since the last reorganization. If the number of days exceeds the threshold, IMS Online Reorganization Facility reorganizes the database. Conditional Reorganization mode of the CRSS is used in this scenario.

Steps [“1” on page 110](#) and [“2” on page 110](#) in the following scenario are one-time tasks.

1. Use the Policy Services ISPF interface to create a new reorganization policy or customize an existing reorganization policy.

The reorganization policy must include the rule IBM.LAST_REORG.10, which evaluates the number of days since the last reorganization.

For more information about creating or customizing reorganization policies, see the topic "Using Policy Services" in the *IMS Tools Base Policy Services User's Guide and Reference*.

Note: When you create or customize the policy, if the IBM.LAST_REORG.10 rule is not in the list of rules, install the latest policy package and apply the latest maintenance to Policy Services.

2. Run a reorganization job to store utility history data in the IMS Tools KB Sensor Data repository.

Run at least one reorganization job that does not invoke the CRSS. This job stores the utility history data in the IMS Tools KB Sensor Data repository. Utility history data contains the time stamp of the reorganization. The CRSS uses this time stamp to determine the number of days since the last reorganization.

As shown in the following JCL example, the following keywords must be specified in the HRFSYSIN DD statement:

- ITKBSERVER(xxxxxxxx) specifies the XCF group name of the IMS Tools KB server.
- ITKBDATA(UTILHIST) stores the utility history data in the IMS Tools KB repository.

```
//ORFJOB JOB CLASS=A
//*-----
//REORG EXEC PGM=HRFREORG,REGION=80M,DYNAMNBR=999
//STEPLIB DD DISP=SHR,DSN=ITB.SFOILOAD
// DD DISP=SHR,DSN=ITB.SHKTLOAD
// DD DISP=SHR,DSN=DBSP.SHRFLOAD
// DD DISP=SHR,DSN=DBSP.SHPSLMDO
// DD DISP=SHR,DSN=IMS.SDFSRESL
//DFSRESLB DD DISP=SHR,DSN=IMS.SDFSRESL
//IMS DD DISP=SHR,DSN=IMS.DBDLIB
//IMSDALIB DD DISP=SHR,DSN=IMS.MDALIB
//SYSPRINT DD SYSOUT=*
//HRFSYSIN DD *
REORG DBD(dbname) -
ITKBSERVER(xxxxxxxx) -
ITKBDATA(UTILHIST) -
LOG1DSN(DATADS.ORF.LOG.&DBD.&DATE1.&TIME2) -
ICDYN(Y) -
IC1DSN(DATADS.ORF.IC.&DBD.&DATE1.&TIME2)
/*
```

When the job ends, look for the following message, which confirms that the IMS Tools KB repository contains the utility history data:

```
HRF01604I Utility history data for dbname [partname] stored
```

3. Run the conditional reorganization job in Conditional Reorganization mode.

The CRSS refers to the utility history data in the IMS Tools KB repository, evaluates the number of days since the last reorganization, and determines if the database requires reorganization. If reorganization is necessary, IMS Online Reorganization Facility reorganizes the database, and the CRSS adds new utility history data in the IMS Tools KB repository.

As shown in the following JCL example, the following keywords must be specified in the HRFSYSIN DD statement:

- CONDREORG(Y) starts the CRSS and runs the job in Conditional Reorganization mode.
- ITKBSERVER(xxxxxxxx) specifies the XCF group name of the IMS Tools KB server.
- ITKBDATA(UTILHIST) stores the utility history data in the IMS Tools KB repository. The utility history data is stored only when the database is reorganized.

In the following JCL example, the reorganization policy that was customized in step “1” on page 110 is specified by the CR.POLICYBY and CR.POLICYNM keywords. The reorganization policy uses the rule IBM.LAST_REORG.10 to evaluate the number of days since the last reorganization.

Tip: For alternative ways to specify the reorganization policy, see “CR.POLICYBY keyword” on page 56.

```
//ORFJOB JOB CLASS=A
/*-----
//REORG EXEC PGM=HRFREORG,REGION=80M,DYNAMNBR=999
//STEPLIB DD DISP=SHR,DSN=ITB.SFOILOAD
//          DD DISP=SHR,DSN=ITB.SHKTLOAD
//          DD DISP=SHR,DSN=DBSP.SHRFLOAD
//          DD DISP=SHR,DSN=DBSP.SHPSLMD0
//          DD DISP=SHR,DSN=IMS.SDFSRESL
//DFSRESLB DD DISP=SHR,DSN=IMS.SDFSRESL
//IMS      DD DISP=SHR,DSN=IMS.DBDLIB
//IMSDALIB DD DISP=SHR,DSN=IMS.MDALIB
//SYSPRINT DD SYSOUT=*
//HRFSYSIN DD *
REORG      DBD(dbname) -
           CONDREORG(Y) -
           CR.POLICYBY(NAME) -
           CR.POLICYNM(your.policy.name) -
           ITKBSERVER(xxxxxxx) -
           ITKBDATA(UTILHIST) -
           LOG1DSN(DATADS.ORF.LOG.&DBD.&DATE1.&TIME2) -
           ICDYN(Y) -
           IC1DSN(DATADS.ORF.IC.&DBD.&DATE1.&TIME2)
/*
```

The Diagnosis report contains data element DB_DAYS_SINCE_LAST_REORG because the rule IBM.LAST_REORG.10 was used.

Database Statistics (DBD: *dbname*)

```
-----
                                     =====
                                     Events Statistics
                                     =====
Note: The mark * in column P means that the data element is used in the policy.
```

Data Element Name	P	Before Reorg	After Reorg	Difference
DB_DAYS_SINCE_LAST_REORG	*	7	0	7

Scenario 3: Reorganizing a database and generating a Diagnosis report

To reorganize a database and obtain a Diagnosis report, run the job in Reorganization Diagnosis mode. Both before and after the reorganization, the Conditional Reorganization Support Service (CRSS) retrieves database statistics and summarizes the statistics in a Diagnosis report, which describes the status of the database.

In Reorganization Diagnosis mode, the CRSS evaluates database statistics against a reorganization policy. However, the evaluation does not affect the job. Even if evaluation indicates that the database does not require reorganization, the database is reorganized.

As shown in the following JCL example, the following keywords must be specified in the HRFSYSIN DD statement:

- CONDREORG(Y,REORGDIAG) starts the CRSS and runs the job in Reorganization Diagnosis mode.
- ITKBSERVER(xxxxxxx) specifies the XCF group name of the IMS Tools KB server.

```

//ORFJOB  JOB CLASS=A
//*-----
//REORG  EXEC PGM=HRFREORG,REGION=80M,DYNAMNBR=999
//STEPLIB DD DISP=SHR,DSN=ITB.SFOILOAD
//        DD DISP=SHR,DSN=ITB.SHKTLOAD
//        DD DISP=SHR,DSN=DBSP.SHRFLOAD
//        DD DISP=SHR,DSN=DBSP.SHPSLMD0
//        DD DISP=SHR,DSN=IMS.SDFSRESL
//DFSRESLB DD DISP=SHR,DSN=IMS.SDFSRESL
//IMS      DD DISP=SHR,DSN=IMS.DBDLIB
//IMSDALIB DD DISP=SHR,DSN=IMS.MDALIB
//SYSPRINT DD SYSOUT=*
//HRFSYSIN DD *
//        REORG  DBD(dbname) -
//                CONDREORG(Y,REORGDIAG) -
//                ITKBSERVER(xxxxxxxx) -
//                LOG1DSN(DATADS.ORF.LOG.&DBD.&DATE1.&TIME2) -
//                ICDYN(Y) -
//                IC1DSN(DATADS.ORF.IC.&DBD.&DATE1.&TIME2)
/*

```

When the job ends, review the Diagnosis report to learn the status of the database. The report is written to the job log and is also stored in the Output repository of IMS Tools KB. This report contains a policy evaluation summary message, which describes the result of the policy evaluation. For more information about the policy evaluation summary message, see the topic "Checking the policy evaluation summary message" in the *IMS Database Reorganization Expert User's Guide*.

Scenario 4: Generating a Diagnosis report without reorganizing the database

To generate only a Diagnosis report, run a job in Diagnosis-only mode. The Conditional Reorganization Support Service (CRSS) retrieves database statistics and summarizes the statistics in a Diagnosis report, which describes the current status of the database.

In Diagnosis-only mode, the CRSS evaluates database statistics against a reorganization policy. However, the evaluation does not affect the job. Even if the evaluation indicates that the database requires reorganization, the database is not reorganized.

As shown in the following JCL example, the following keywords must be specified in the HRFSYSIN DD statement:

- CONDREORG(Y,DIAGONLY) starts the CRSS and runs the job in Diagnosis-only mode.
- ITKBSERVER(*xxxxxxxx*) specifies the XCF group name of the IMS Tools KB server.

```

//ORFJOB  JOB CLASS=A
//*-----
//REORG  EXEC PGM=HRFREORG,REGION=80M,DYNAMNBR=999
//STEPLIB DD DISP=SHR,DSN=ITB.SFOILOAD
//        DD DISP=SHR,DSN=ITB.SHKTLOAD
//        DD DISP=SHR,DSN=DBSP.SHRFLOAD
//        DD DISP=SHR,DSN=DBSP.SHPSLMD0
//        DD DISP=SHR,DSN=IMS.SDFSRESL
//DFSRESLB DD DISP=SHR,DSN=IMS.SDFSRESL
//IMS      DD DISP=SHR,DSN=IMS.DBDLIB
//IMSDALIB DD DISP=SHR,DSN=IMS.MDALIB
//SYSPRINT DD SYSOUT=*
//HRFSYSIN DD *
//        REORG  DBD(dbname) -
//                CONDREORG(Y,DIAGONLY) -
//                ITKBSERVER(xxxxxxxx) -
//                LOG1DSN(DATADS.ORF.LOG.&DBD.&DATE1.&TIME2) -
//                ICDYN(Y) -
//                IC1DSN(DATADS.ORF.IC.&DBD.&DATE1.&TIME2)
/*

```

When the job ends, review the Diagnosis report to learn the status of the database. The report is written to the job log and is also stored in the Output repository of IMS Tools KB. This report contains a policy evaluation summary message, which describes the result of the policy evaluation. For information about the policy evaluation summary message, see the topic "Checking the policy evaluation summary message" in the *IMS Database Reorganization Expert User's Guide*.

Scenario 5: Evaluating secondary indexes and conditionally reorganizing a database

The Conditional Reorganization Support Service (CRSS) can evaluate secondary indexes to determine the reorganization need.

To have the CRSS evaluate secondary indexes and take into consideration the evaluation results of the secondary indexes, change the action associated to the rule that is applied to secondary indexes from INDEXBLD to REORG and run the conditional reorganization job in Conditional Reorganization mode with the CR.EVALINDEX(Y) keyword. If the CRSS determines that one or more of the secondary indexes need reorganization, the primary database is reorganized and all the secondary indexes are rebuilt even when the primary database does not require reorganization.

In this example, the SYS.DBDDTYPE.FFDBALL policy is updated so that the secondary indexes are rebuilt when the number of CI/CA splits is increased. Step “1” on page 113 in the following scenario is a one-time task.

1. Use the Policy Services ISPF interface to customize the SYS.DBDDTYPE.FFDBALL policy.

Update the following rules so that the actions associated with their CRITICAL level are changed from INDEXBLD to REORG:

- IBM.IX_CICA_SPLIT.10, which evaluates CI/CA splits in an index primary data set
- IBM.IX_CICA_SPLIT.11, which evaluates CI/CA splits in a PHIDAM primary index

You can modify the thresholds of these rules as needed. For more information about customizing reorganization policies and rules, see the topic "Using Policy Services" in the *IMS Tools Base Policy Services User's Guide and Reference*.

Note: If the SYS.DBDDTYPE.FFDBALL policy is not in the list of policies, apply the latest maintenance to Policy Services and install the latest policy package.

2. Run the conditional reorganization job in Conditional Reorganization mode with the CR.EVALINDEX(Y) keyword.

The CRSS evaluates secondary indexes in addition to the primary database. If one or more indexes need reorganization, IMS Online Reorganization Facility reorganizes the primary database and rebuilds all the secondary indexes.

As shown in the following JCL example, specify the following keywords in the HRFSYSIN DD statement:

- CONDREORG(Y) starts the CRSS and runs the job in Conditional Reorganization mode.
- CR.EVALINDEX(Y) evaluates secondary index data sets.
- CR.POLICYBY(NAME) selects the reorganization policy based on the policy name.
- CR.POLICYNM(SYS.DBDDTYPE.FFDBALL) specifies the reorganization policy.
- ITKBSERVER(xxxxxxxx) specifies the XCF group name of the IMS Tools KB server.

```

//ORFJOB JOB CLASS=A
//*-----
//REORG EXEC PGM=HRFREORG,REGION=80M,DYNAMNBR=999
//STEPLIB DD DISP=SHR,DSN=ITB.SFOILOAD
// DD DISP=SHR,DSN=ITB.SHKTLOAD
// DD DISP=SHR,DSN=DBSP.SHRFLOAD
// DD DISP=SHR,DSN=DBSP.SHPSLMD0
// DD DISP=SHR,DSN=IMS.SDFSRESL
//DFSRESLB DD DISP=SHR,DSN=IMS.SDFSRESL
//IMS DD DISP=SHR,DSN=IMS.DBDLIB
//IMSDALIB DD DISP=SHR,DSN=IMS.MDALIB
//SYSPRINT DD SYSOUT=*
//HRFSYSIN DD *
REORG DBD(dbname) -
CONDREORG(Y) -
CR.EVALINDEX(Y) -
CR.POLICYBY(NAME) -
CR.POLICYNM(SYS.DBDTYPE.FFDBALL) -
ITKBSERVER(xxxxxxxx) -
LOG1DSN(hlq1.LOG.&DBD.&DATE1.&TIME2) -
ICEIN(ICEIN)
//ICEIN DD *
GLOBAL ICDALLOC=Y,ICHLQ=hlq1.IC,UNIT=SYSALLDA
//*

```

Examples: Using the DDEFPS2 DD statement

The JCL examples in this topic show the steps to perform DBDS organization conversion using the DDEFPS2 DD statement.

Example 1: Allocating DDEFPS2 DD

The JCL example in this topic allocates the DDEFPS2 DD statement as partitioned data set.

```

//*-----
/* CREATE DDEFPS2
//*-----
//DELDEF EXEC PGM=IDCAMS
//SYSPRINT DD SYSOUT=*
//SYSIN DD *
DELETE your.DDEFPS2
SET MAXCC=0
/*
//ALLOC EXEC PGM=IEFBR14
//DDEFPS2 DD UNIT=SYSDA,DISP=(NEW,CATLG),
// DCB=(DSORG=PO,BLKSIZE=27920,LRECL=80,RECFM=FB),
// SPACE=(CYL,(1,1,16)),
// DSN=your.DDEFPS2
/*

```

Example 2: Creating DDEFPS2 DD for non-HALDB

The JCL example in this topic creates an IDCAMS command that defines the data set as OSAM LDS before reorganizing the non-HALDB database.

```

//STEP1 EXEC PGM=IEBUPDTE,PARM=NEW
//SYSUT1 DD UNIT=SYSDA,DISP=SHR,
// DSN=your.DDEFPS2
//SYSUT2 DD UNIT=SYSDA,DISP=SHR,
// DSN=your.DDEFPS2
//SYSPRINT DD SYSOUT=*
//SYSIN DD DATA,DLM=ZZ
./ ADD NAME=HDAMDS1,LIST=ALL
DELETE DATADS.ORF.HDAM1.HDAMDS1.S
SET MAXCC=0
DEFINE CLUSTER(NAME(DATADS.ORF.HDAM1.HDAMDS1.S) -
LINEAR -
REUSE SHR(3,3) -
CISZ(4096) CYL(5,5) -
DATACLAS(dataclas) KEYLABEL(keylabel) -
)
ZZ
/*
//STEP2 EXEC PGM=IEBUPDTE,PARM=NEW

```



```

//SYSUT1 DD UNIT=SYSDA,DISP=SHR,
//      DSN=your.DDEFPPDS2
//SYSUT2 DD UNIT=SYSDA,DISP=SHR,
//      DSN=your.DDEFPPDS2
//SYSPRINT DD SYSOUT=*
//SYSIN DD DATA,DLM=ZZ
./ ADD NAME=HDAMDS2,LIST=ALL
DELETE DATADS. ORF. HDAM1. HDAMDS2. S
SET MAXCC=0
DEFINE CLUSTER(NAME(DATADS. ORF. HDAM1. HDAMDS2. S) -
             LINEAR -
             REUSE SHR(3,3) -
             CISZ(4096) CYL(5,5) -
             DATACLAS(dataclas) KEYLABEL(keylabel) -
             )
ZZ
/*

```

Example 3: Creating DDEFPPDS2 DD for HALDB

The JCL example in this topic creates an IDCAMS command that defines the data set as OSAM LDS before reorganizing the HALDB database.

```

//STEP11A EXEC PGM=IEBUPDTE,PARM=NEW
//SYSUT1 DD UNIT=SYSDA,DISP=SHR,
//      DSN=your.DDEFPPDS2
//SYSUT2 DD UNIT=SYSDA,DISP=SHR,
//      DSN=your.DDEFPPDS2
//SYSPRINT DD SYSOUT=*
//SYSIN DD DATA,DLM=ZZ
./ ADD NAME=PHID11A,LIST=ALL
DELETE DATADS. ORF. PHIDAM1. S. A00001
SET MAXCC=0
DEFINE CLUSTER(NAME(DATADS. ORF. PHIDAM1. S. A00001) -
             LINEAR -
             REUSE SHR(3,3) -
             CISZ(8192) CYL(10,10) -
             DATACLAS(dataclas) KEYLABEL(keylabel) -
             )
ZZ
/*
//STEP11B EXEC PGM=IEBUPDTE,PARM=NEW
//SYSUT1 DD UNIT=SYSDA,DISP=SHR,
//      DSN=your.DDEFPPDS2
//SYSUT2 DD UNIT=SYSDA,DISP=SHR,
//      DSN=your.DDEFPPDS2
//SYSPRINT DD SYSOUT=*
//SYSIN DD DATA,DLM=ZZ
./ ADD NAME=PHID11B,LIST=ALL
DELETE DATADS. ORF. PHIDAM1. S. B00001
SET MAXCC=0
DEFINE CLUSTER(NAME(DATADS. ORF. PHIDAM1. S. B00001) -
             LINEAR -
             REUSE SHR(3,3) -
             CISZ(8192) CYL(10,10) -
             DATACLAS(dataclas) KEYLABEL(keylabel) -
             )
ZZ
/*
//STEP11L EXEC PGM=IEBUPDTE,PARM=NEW
//SYSUT1 DD UNIT=SYSDA,DISP=SHR,
//      DSN=your.DDEFPPDS2
//SYSUT2 DD UNIT=SYSDA,DISP=SHR,
//      DSN=your.DDEFPPDS2
//SYSPRINT DD SYSOUT=*
//SYSIN DD DATA,DLM=ZZ
./ ADD NAME=PHID11L,LIST=ALL
DELETE DATADS. ORF. PHIDAM1. S. L00001
SET MAXCC=0
DEFINE CLUSTER (NAME(DATADS. ORF. PHIDAM1. S. L00001) -
             VOL(*)          CYL(10 10)          INDEXED          -
             REUSE          SHR(3 3)          KEYS(9,0)          -
             CISZ(4096)     RECSZ(50 50))
ZZ
/*
//STEP11X EXEC PGM=IEBUPDTE,PARM=NEW
//SYSUT1 DD UNIT=SYSDA,DISP=SHR,
//      DSN=your.DDEFPPDS2
//SYSUT2 DD UNIT=SYSDA,DISP=SHR,

```

```

//          DSN=your.DDEFPS2
//SYSPRINT DD SYSOUT=*
//SYSIN   DD DATA,DLM=ZZ
./ ADD NAME=PHID11X,LIST=ALL
DELETE  DATADS. ORF. PHIDAM1. S. X00001
SET MAXCC=0
DEFINE CLUSTER (NAME(DATADS. ORF. PHIDAM1. S. X00001) -
              VOL(*)          CYL(10 10)      INDEXED          -
              REUSE          SHR(3 3)        KEYS(10,5)         -
              CISZ(4096)     RECSZ(16 16))
ZZ
/*

```

Example 4: Converting a database from OSAM to OSAM LDS using DDEFPS2 DD

The JCL example in this topic reorganizes a HDAM database and converts the database from OSAM to OSAM LDS using the DDEFPS2 DD statement.

Before reorganization, you must create the DDEFPS2 DD statement (Example 1) and the IDCAMS command (Example 2) for the database data sets that you want to convert to OSAM LDS.

```

/*-----
/* Online Reorganization of a HDAM OSAM database with no secondary indexes
/* Converting a database from OSAM to OSAM LDS using DDEFPS2 DD
/*-----
//ORF      EXEC PGM=HRFREORG,REGION=80M
//STEPLIB DD DSN=DBSP. SHRFLD,DISP=SHR
//          DD DSN=your_userLib,DISP=SHR          <=== ROUTINES
//          DD DSN=DBSP. SHPSLMD0,DISP=SHR        <=== IMS TOOLS
//          DD DSN=IMS. SDFSRESL,DISP=SHR
//IMS      DD DSN=your_dbdLib,DISP=SHR
//IMSDALIB DD DSN=your_mdalib,DISP=SHR
//IEFRDER DD DSN=ims_log_dataset,
//          DISP=(,CATLG,DELETE),
//          SPACE=(CYL,(300,50),RLSE),UNIT=SYSALLDA
//DDEFPS2 DD DSN=your_DDEFPS2,DISP=SHR          <===DDEFPS2 DD
/*
//HRFSYSIN DD *
REORG DBD(HDAM1) -
ICDYN(Y) ICHLQ(ichlq) ICMID(3)
/*

```

Example 5: Converting a database from VSAM to OSAM LDS using DDEFPS2 DD

The JCL example in this topic reorganizes a HDAM database and converts the database from VSAM to OSAM LDS using the DDEFPS2 DD statement.

Because such a DBD change involves changes to PSBs, ONLINECHANGE(N) must be specified. After the job ends, you must perform some post-processing tasks.

1. The following JCL example reorganizes a HDAM database. IMS Online Reorganization Facility updates the staging ACBLIB with the new database definition, but it does not update the ACBs in online IMS subsystems. The job ends with return code 4, and the HDAM database remains offline with the prohibit authorization flag turned on.

```

/*-----
/* DBDGEN (Converting a database from VSAM to OSAM LDS)
/*-----
//DBDGEN   EXEC DBDGEN,MBR=HDAM1
//L.SYSLMOD DD DSN=your_new_dbdLib(HDAM1),DISP=SHR
//C.SYSIN  DD *
          DBD   NAME=HDAM1,ACCESS=(HDAM,OSAM),RMNAME=(DFSHDC40,5,5)
*
          DATASET DD1=HDAMDS1,DEVICE=3390,SIZE=4096
*
          SEGM   NAME=ROOT,BYTES=(50),PTR=T
          FIELD  NAME=(ROOTK,SEQ,U),BYTES=8,START=1
*
          DATASET DD1=HDAMDS2,DEVICE=3390,SIZE=4096
*

```

```

        SEGM  NAME=DEP01,PARENT=ROOT,BYTES=(50),PTR=T
        FIELD NAME=(DEP01K,SEQ,U),BYTES=6,START=1
*
        DBDGEN
        FINISH
        END
//*
//*-----
//* Online Reorganization of an HDAM database with no secondary indexes
//* Converting a database from VSAM to OSAM LDS using DDEFPS2 DD
//*-----
//ORF      EXEC PGM=HRFREORG,REGION=0M
//STEPLIB DD DSN=DBSP.SHRFLOAD,DISP=SHR
//         DD DSN=your_mdalib,DISP=SHR
//         DD DSN=your_userlib,DISP=SHR          <=== ROUTINES
//         DD DSN=DBSP.SHPSLMD0,DISP=SHR        <=== IMS TOOLS
//         DD DSN=IMS.SDFSRESL,DISP=SHR
//IMS      DD DSN=your_dbdlib,DISP=SHR          <=== DBD library
//         DD DSN=your_psblib,DISP=SHR        <=== PSB library
//IMSACB   DD DSN=your_acblib,DISP=SHR        <=== staging ACB library
//IMSNEW   DD DSN=your_new_dbdlib,DISP=SHR    <=== changed DBDs
//IEFRDER  DD DSN=ims_log_dataset,
//         DISP=(,CATLG,DELETE),
//         SPACE=(CYL,(300,50),RLSE),UNIT=SYSALLDA
//DDEFPS2 DD DSN=your_DDEFPS2,DISP=SHR      <===DDEFPS2 DD
//*
//HRFSYSIN DD *
        REORG DBD(HDAM1) NEWDBD(IMSNEW) ONLINECHANGE(N) DBDCOPY(Y) -
        ICDYN(Y) IC1DSN(DATADS. ORF. IC.&DBD.&DATE1.&TIME2)
//*

```

2. Use the Online Change Copy utility (DFSUOCU0) and copy the staging ACBLIB to the inactive ACBLIB. Skip this step if you use ACB library member online change.

The following JCL examples use the OLCUTL procedure to invoke the Online Change Copy utility.

Example for local online change

```
//ACBCOPY EXEC PROC=OLCUTL,SOUT='*',TYPE=ACB,IN=S,OUT=U
```

Example for global online change

```
//ACBCOPY EXEC PROC=OLCUTL,SOUT='*',TYPE=ACB,IN=S,OUT=G
```

3. Issue **/MODIFY** commands or **INITIATE OLC** commands to complete the IMS online change.

Local online change commands

- a. /MODIFY PREPARE ACBLIB
- b. /MODIFY COMMIT

Global online change commands

- a. INITIATE OLC PHASE(PREPARE) TYPE(ACBLIB)
- b. INITIATE OLC PHASE(COMMIT)

Global online change commands for ACB library member online change

- a. INITIATE OLC PHASE(PREPARE) TYPE(ACBMBR) NAME(*dbdname*)
- b. INITIATE OLC PHASE(COMMIT)

4. If the Integrity Checker utility of IMS Library Integrity Utilities is active in your environment, use the LICON utility and re-create the RDE.

Example for re-creating an RDE

```

//LICONUTL EXEC PGM=FABLIU00
//         DD DSN=DBSP.SHPSLMD0,DISP=SHR
//         DD DSN=IMS.SDFSRESL,DISP=SHR
//ACBLIB   DD DSN=your_acblib,DISP=SHR
//FABLPRNT DD SYSOUT=*
//FABLIN   DD *
        INIT.DB DBD(dbdname) REPLACE
//*

```

5. Turn off the prohibit authorization flag and restart the database. For a HALDB, you must restart both the HALDB master and each partition.

Example 6: Converting a database from VSAM to OSAM LDS using DDEFPS2 DD when the IMS management of ACBs is enabled

By specifying the additional DDEFPS2 DD statement with an IDCAMS command that defines the data set as OSAM LDS, you can convert the database from VSAM to OSAM LDS when the IMS management of ACBs is enabled.

For JCL example to change database definition in an IMS-managed ACBs environment, see [“Example: Changing database definition in an IMS-managed ACBs environment”](#) on page 106.

Example: Creating a batch image copy of a HDAM database

The example in this topic shows the JCL to create a batch image copy of a HDAM database.

```
//* Create Batch IC of a HDAM VSAM database
/*-----
//ORF      EXEC PGM=HRFREORG,REGION=80M
//STEPLIB DD DSN=DBSP.SHRFLD0,DISP=SHR
//          DD DSN=your_userlib,DISP=SHR      <=== ROUTINES
//          DD DSN=DBSP.SHPSLMD0,DISP=SHR     <=== IMS TOOLS
//          DD DSN=IMS.SDFSRESL,DISP=SHR
//IMS      DD DSN=your_dbdlib,DISP=SHR
//IMSDALIB DD DSN=your_mdalib,DISP=SHR
//HRFSYSIN DD *
//          IMAGECOPY DBD(HDV8) -
//              ICEIN(ICEIN)
//ICEIN DD *
//          GLOBAL ICDALLOC=Y,ICHLQ=hlq1.IC,UNIT=SYSALLDA
//
```

Chapter 3. Changing the IMS Online Reorganization Facility environment

There might be occasions where you want to change the IMS Online Reorganization Facility environment. Read the following topics to change the IMS Online Reorganization Facility environment.

Topics:

- [“Customizing the base environment” on page 119](#)
- [“Defining the subordinate address space procedure” on page 125](#)
- [“Modifying BMP jobs to have the BMP handler add extra checkpoints” on page 126](#)
- [“Modifying BMP jobs so that they are not paused by the BMP handler” on page 128](#)
- [“Applying maintenance” on page 128](#)
- [“Disabling the BMP pause feature” on page 130](#)
- [“Disabling the CICS and ODBA applications pause feature” on page 130](#)

Customizing the base environment

To change base configuration parameters or define a set of base configuration parameters for each IMS subsystem (IMS ID) or IMSPLEX, use the SAMPLIB member HRFCCNFG. The HRFCCNFG job creates the base configuration module HRFSETOP or the alternate base configuration module HRF#*ssid*.

Base configuration modules HRFSETOP and HRF#*ssid*

IMS Online Reorganization Facility uses customizable module HRFSETOP, HRF#*ssid*, or both to define base configuration parameters.

During IMS Online Reorganization Facility initialization, these modules are loaded from the STEPLIB concatenation in the IMS control region and the IMS Online Reorganization Facility address spaces. To create one or more base configuration modules, run the SAMPLIB member HRFCCNFG.

If you need a different set of base configuration parameters for each IMS subsystem or IMSPLEX, you can define multiple base configuration modules in the same library. When you define multiple base configuration modules, the member name of each additional module must begin with HRF# and use the suffix IMS ID or IMSGROUP.

When the STEPLIB concatenation of an IMS control region contains multiple base configuration modules, the modules are searched for in the following order:

1. HRF#*imsid*
2. HRF#*imgroup*
3. HRFSETOP

The control region uses the first base configuration module that is found.

In an IMS Online Reorganization Facility job, use the OPTID keyword with the REORG command to specify an IMS ID or an IMSGROUP. The default for the OPTID keyword is IMSID, which specifies that the IMSID from DFSVC000 in RESLIB is the suffix for the base configuration module name.

In the IMS Online Reorganization Facility jobs, base configuration modules are searched for in the following order:

1. HRF#*optid*
2. HRFSETOP

Important: For the IMS control region and IMS Online Reorganization Facility batch jobs, the contents of a base configuration module is not merged from one level to another. Consequently, you must specify all of the required values in the base configuration module.

Changing the base configuration parameters

To change the base configuration parameters, which are defined in the HRFSETOP module, assemble and link-edit or bind the module.

Procedure

1. Edit the SAMPLIB member HRFCCNFG.
2. Add or modify any configuration parameters that you want to specify.

For the parameters that you can specify, see [“Base configuration parameters” on page 120](#).

3. Save the SAMPLIB member HRFCCNFG.
4. Submit the HRFCCNFG job to load, link-edit, and bind the HRFSETOP module.
5. If you added or modified one or more of the following base configuration parameters, recycle all affected control regions so that the new base configuration parameters take effect.

XCFGROUP, ULOGID, ENQNAME, DEBUG, NONBLANK, XCFRETRY

Defining a base configuration module for each IMS ID or IMSPLEX

To define a set of base configuration parameters for each IMS ID or IMSPLEX, define alternate base configuration modules.

Procedure

1. Edit the SAMPLIB member HRFCCNFG.
2. Provide the applicable values to all parameters to suit your environment.

For the parameters that you can specify, see [“Base configuration parameters” on page 120](#).

3. In the link-edit step (EXEC PGM=HEWL) SYSIN DD statement, edit the name of the load module and specify the name that you want to create. For example, change the load module name to HRF#*imsid* or HRF#*imsgrp*.
4. Save the modified HRFCCNFG JCL member to the HRF#*imsid* or HRF#*imsgrp* JCL members.
5. Submit the job to load, link-edit, and bind the new base configuration module.
6. Add the new base configuration module to the STEPLIB DD concatenation of IMS control region JCL. Then recycle all affected control regions so that the new base configuration parameters take effect.

Base configuration parameters

The IMS Online Reorganization Facility base configuration modules HRFSETOP and HRF#*ssid* contain the parameters that you defined in the SYSIN DD statement of the SAMPLIB member HRFCCNFG.

Set the base configuration parameters to suit your environment.

BMPRETRY=nnn

Specify a numerical value that indicates how many retry attempts to make when a WTOR is issued to stop BMP jobs. A retry attempt is made every 10 seconds. When the number is exceeded, the IMS Online Reorganization Facility job stops. The original database remains available and is returned to active status.

Default: 999

CHGDATAAC=sss

Specifies a 1- to 8-character SMS data class name for the temporary data sets that store the change records that the IMS online regions send.

This parameter is optional for SMS environments. Specify this parameter only when you want to use a specific SMS data class to allocate the data sets.

Default: None.

CHGSTORC=sss

Specifies a 1- to 8-character SMS storage class name for the temporary data sets that store the change records that the IMS online regions send.

This parameter is optional for SMS environments. Specify this parameter only when you want to use a specific SMS storage class to allocate the data sets.

Default: None.

DBDCLAS=sss

Specifies a 1- to 8-character SMS data class name for the temporary DBDLIB data set that is required when a database is reorganized in an IMS-managed ACBs environment.

Default: None.

DBDDSN=pppppppppppppp

Specifies a 1- to 26-character data set prefix for creating a temporary DBDLIB data set that is required when a database is reorganized in an IMS-managed ACBs environment.

Default: ORF.DBDLIB.HLQ

DBDVOL=vvvvvv

Specifies a 1- to 6-character volume serial for the temporary DBDLIB data set that is required when a database is reorganized in an IMS-managed ACBs environment. This value is required for non-SMS environments.

Default: None.

DBRCHIPR=Y | YES | N | NO

Specifies the timestamp precision for DBRC commands. DBRCHIPR=N or NO generates DBRC commands that have 12-digit time stamps. DBRCHIPR=Y or YES generates DBRC commands that have 16-digit time stamps. DBRC commands that have 16-digit time stamps can be processed only when the MINVERS value in the RECON data set is equal to or higher than 10.1.

Default: Y

DBSCLAS=sss

Specifies a 1- to 8-character SMS storage class name for the temporary DBDLIB data set that is required when a database is reorganized in an IMS-managed ACBs environment.

Default: None.

DBSTART=N | NO | Y | YES

If UPDATE DB STOP() was used to stop the database before running the IMS Online Reorganization Facility job, the database does not start after the reorganization. Use this parameter to indicate whether to start the database. Specify Y to start the database during the Takeover phase even if it was stopped at the start of the IMS Online Reorganization Facility job. DBSTART (Y|N) can also be specified in the job control card.

Default: N

DEBUG=N | NO | Y | YES

Additional debugging within the IMS control region. DEBUG=Y indicates that IMS Online Reorganization Facility can write additional messages and traces to aid in debugging or diagnosing IMS Online Reorganization Facility activity in the IMS control region.

Default: N

DFDSS=N | Y

Specifies whether to use DFSMSdss during the Copy phase when the primary database data sets are copied. When DFSMSdss is used, the database is stopped while the data sets are copied.

DFDSS=Y is effective when all of the following conditions are met:

- The HRFSYSIN DD statement begins with the REORG command.
- The primary database to reorganize is not an index.
- The database data sets reside on SMS-managed volumes.

Default: N

DLIRETRY=*nnn*

Specify a numerical value that indicates how many retry attempts to make when a WTOR is issued to stop DLI batch jobs. A retry attempt is made every 10 seconds. When the number is exceeded, the IMS Online Reorganization Facility job stops. Specify 0 if you want no retry attempts to be made.

Default: 0

DUALLOG=N | Y

Specifies whether to use dual logging to apply captured changes.

Default: N

ENQNAME=*nnn*

Specifies the QNAME to use for IMS Online Reorganization Facility enqueues. Change this parameter only if the default value conflicts with other components or products in your environment. The value can be any valid 1- to 8-character ENQ major name.

Default: \$ORFENQ\$

FEOV= Y | YES | N | NO

Specifies whether to include the NOFEOV keyword in the **/DBR** command during the Takeover phase. FEOV=N or NO includes the NOFEOV keyword, and no end of volume is forced. To override the value of this parameter, use the FEOV keyword in the HRFSYSIN DD statement.

Default: Y

LOGDATAC=*sss*

Specifies a 1- to 8-character SMS data class to use to define temporary log data sets that are required to apply captured changes.

Default: None.

LOGKYLBL=*nnnnnnnnnn*

Specifies a 1- to 64-character encryption key label for encrypting log data sets that are used during the Apply phase.

Default: None.

LOGMGMTC=*sss*

Specifies a 1- to 8-character SMS management class to use to define temporary log data sets that are required to apply captured changes.

Default: None.

LOGSTORC=*sss*

Specifies a 1- to 8-character SMS storage class to use to define temporary log data sets that are required to apply captured changes.

Default: None.

LOGHLQ=*pppppppppppppppp*

Specifies a 1- to 26-character data set prefix that defines temporary log data sets that are required to apply captured changes. To create the data set name, IMS Online Reorganization Facility appends a DBD or HALDB partition name and an internal name that is generated from the time stamp to the prefix. The data set is deleted upon successful completion of the reorganization job.

Default: ORF.APPLYLOG.HLQ

LOGUNIT=*uuuuuuuuuu*

Specifies a 1- to 8-character unit name that defines temporary log data sets that are required to apply captured changes. This value is required for non-SMS environments.

Default: TOIGROUP=TOIXCF in the HRFSETOP module and XCFGROUP=XCF in the FOI*msid*P would result in TOIXCF.

ULOGID=*ln*

Specifies the user log record ID. The ID is a 2-character hexadecimal value, A0 - FF, for the user log records that IMS Online Reorganization Facility generates.

Default: F0

UNITPOOL=*uuuuuuuuuu*

Specifies a 1- to 8-character unit name for OSAM shadow data set allocations. This parameter is required if you want to allocate shadow data sets in a specified unit pool. This parameter is effective only for OSAM databases.

This parameter is ignored when SHADOW(E) is specified.

When the DDEFPS2 DD statement is specified, the UNITPOOL parameter is effective for the specified member only in the Copy phase.

Default: None.

UNLHLQ=*pppppppppppppppp*

Specifies a 1- to 26-character data set prefix for the temporary unload data sets that are dynamically allocated during the reorganization when the database has external logical relationships.

To create the data set name, IMS Online Reorganization Facility appends an internal name that is generated from the time stamp to the prefix.

The data sets are deleted upon successful completion of the job.

Default: ORF.UNLOAD.HLQ

UNLMAXRC=*n*

Specifies a 1-digit numeric value for the maximum acceptable return code from the HD Unload utility. This parameter is ignored when you use IMS High Performance Unload. Valid values are 0 and 4. Specify 4 only if you can accept the return code 4 from the HD Unload utility and want to continue reorganization.

Default: 0

UNLSPAC=*nnn*

Specifies a 3-digit numeric space allocation value for temporary unload data set allocations. Specify a numeric value for the number of cylinders to allocate to each temporary data set. The number of data sets that are allocated is determined by IMS Online Reorganization Facility.

Default: 200

UNLUNIT=*nnn*

Specifies any valid direct-access 8-character unit name for temporary unload data set allocations. These files are temporary files that default to SYSALLDA, unless otherwise specified.

Default: SYSALLDA

VOLPOOL=*vvvvvv*

Specifies 1- to 6-character volume serial for OSAM shadow data set allocations. This parameter is required only if you want to allocate shadow data sets in the specified volume pool. This parameter is effective only for OSAM databases.

This parameter is ignored when SHADOW(E) is specified.

When the DDEFPS2 DD statement is specified, the VOLPOOL parameter is effective for the specified member only in the Copy phase.

Default: None.

WFHLQ=*pppppppppppppppp*

Specifies a 1- to 26-character data set prefix for the work data sets that are dynamically created during the reorganization.

To create the data set name, IMS Online Reorganization Facility appends an internal name that is generated from the time stamp to the prefix.

The data sets are deleted upon successful completion of the job.

Default: ORF.WORK.HLQ

WFUNIT=uuuuuuuuu

Specifies a 1- to 8-character unit name for the work data sets that are dynamically created during the reorganization.

The data sets are deleted upon successful completion of the job.

Default: None.

XCFGROUP=nnn

Specifies a 1- to 8-character valid XCF group name that is not used as a TOI XCFGROUP name. This group name is used for XCF communication between IMS control regions and IMS Online Reorganization Facility batch utilities. This name must be unique within the sysplex.

Default: ORFXCF

XCFMAX=nnn

Specifies a numeric value for the size (in MB) of the internal message buffers that the IMS Online Reorganization Facility job uses to receive XCF messages. These buffers are provided to protect against cases where IMS Online Reorganization Facility cannot keep up with the changes that are being captured from the online IMS subsystems. When the internal message buffers are exhausted, the IMS Online Reorganization Facility job ends abnormally. Valid values are 256 - 2047.

Default: 256

XCFRETRY=nn

Specifies a 2-digit numeric value for the number of times that IMS Online Reorganization Facility automatically retries sending XCF messages when sufficient XCF message buffer is not available (IXCMGORSNNOBUFFER). When the number is exceeded, the IMS Online Reorganization Facility job stops.



Attention: Be aware that this parameter might degrade the performance of IMS when the XCF send errors occur repeatedly.

Default: 0

Defining the subordinate address space procedure

IMS Online Reorganization Facility can initiate multiple subordinate address spaces to process multiple databases in parallel. Each subordinate address space is a started task that executes the subordinate address space procedure named HRFSUB. Follow the procedure in this topic to define the HRFSUB started task.

Before you begin

Before setting up the subordinate address spaces, make sure that you have established proper security authorizations and access.

The IMS Online Reorganization Facility job issues an MVS **START** command internally to start the subordinate address space. If the user ID does not have an authority to issue an MVS **START** command, use the following **PERMIT** command to specify the user ID. The OPERCMDS class is RACLIST'ed and must be refreshed after you make updates.

```
PERMIT MVS.START.STC.* CLASS(OPERCMD) ID(userid) ACCESS(UPDATE)
SETROPTS RACLIST(OPERCMD) REFRESH
```

The user ID for the subordinate address space is obtained in two phases:

1. Before the IMS Online Reorganization Facility code is dispatched in the subordinate address space and has the opportunity to set its security identity, the operating system attempts to use the user ID from the profile definitions in the security system's STARTED class as the user ID for these started tasks. You can use the following RDEFINE to specify the user ID. The STARTED class is RACLIST'ed and must be refreshed after you make updates.

```
RDEFINE STARTED HRFSUB.* STDATA(USER(userid))
SETROPTS RACLIST(STARTED) REFRESH
```

2. After the IMS Online Reorganization Facility code is dispatched in the subordinate address space, IMS Online Reorganization Facility processing determines the user ID under which the master address space runs. The subordinate address space changes its own initial user ID to match that of the master address space. When this change occurs, the subordinate address space runs with the same security authorities as the master.

Procedure

1. Ensure that the JCL that runs IMS Online Reorganization Facility has the IMS Online Reorganization Facility load library in the STEPLIB concatenation.

The master address space determines its load library's data set name from its STEPLIB. This data set name is passed through the PGMLIB parameter when the master address space starts the HRFSUB procedure. This process ensures that the master and subordinate address spaces use the same software level. The rest of libraries specified in the STEPLIB DD statement of the master address space are dynamically allocated in the subordinate address space, so you do not need to manually update the HRFSUB started task JCL when the IMS Online Reorganization Facility JCL is updated.

2. Define the HRFSUB started task JCL, as shown in the following example.

This example is also placed into SHRFSAMP during the SMP/E installation.

```

/*****
/* Standard SAS Procedure for ORF V1.1
/*****
// PROC PGMLIB=
//IEFPROC EXEC PGM=HRFYADSP,REGION=80M,DYNAMNBR=999
//STEPLIB DD DISP=SHR,DSN=&PGMLIB
//SYSPRINT DD DUMMY
//SYSUDUMP DD DUMMY
/*

```

Figure 3. Example of subordinate address space procedure (HRFSUB)

Modifying BMP jobs to have the BMP handler add extra checkpoints

If the interval between checkpoints for your applications is long, use the IMS Online Reorganization Facility BMP handler to enable additional checkpoints.

About this task

The BMP handler adds checkpoint calls. You must manage application restarts using other methods.

Important: This task is effective only when BMP pauses are managed by IMS Online Reorganization Facility. If BMP pauses are managed by IMS Program Restart Facility, use the application management features provided by IMS Program Restart Facility.

Procedure

Specify the CHKPNTS DD statement in the JCL of the BMP.

You must adhere to the following syntax rules when you specify the CHKPNTS DD statement:

- Enter only one parameter on each line.

- The parameter must start within the first 20 positions.
- To include a comment, type three or more blanks after the parameter, and then type the comment.
- Do not use a comma at the end of a parameter.
- If you specify multiple occurrences of the same parameter, only the last occurrence is used.

The CHKPNTS DD statement contains the following parameters:

PCB=*nnn*|*name*

nnn|*name* specifies the PCB to trigger the checkpoint. Specify a name or the PCB number, where 1 is the IOPCB. If you do not specify a value, PCB=2 is the default. If AIB calls are made, you must specify the PCB=*name*.

INTVL=*nnn*

nnn specifies the pause interval in seconds. If you do not specify a value, INTVL=30 is the default.

CALLTYPE=GU

This parameter specifies that a GU|GHU call triggers the pause test. This parameter is effective only when you specify CHKP=N.

POS=ROOT

This parameter specifies that whenever a root segment is reached, a pause test is triggered. This parameter is effective only when you specify CHKP=N.

APPLWAIT=Y

This parameter specifies that a TIMER wait of the application triggers the pause test. If the pause test is positive, the application is paused with a 3303 abend. Specify this parameter if the application does TIMER waits.

CHKP=(U | X | N)

This parameter specifies how the BMP handler adds a checkpoint. Specify this parameter with one of the following values if the application does not issue CHKP calls.

- Specify U to interrupt at any IMS call for a specified PCB. If you specify CHKP=U, you must also specify the PCB parameter.
- Specify X to interrupt at any IMS call for any of the PCBs.
- Specify N to interrupt at the timing specified by either the CALLTYPE or POS parameter. If you specify CHKP=N, you must also specify the PCB parameter and either CALLTYPE or POS parameters.

Example

The following example checks PCB 4 for GN calls. When a root segment is returned, it determines if the 20-second interval has expired. If it has, IMS Online Reorganization Facility performs a pause test. If the BMP needs to be paused, a CHKP call is issued, the BMP is paused, and a 3303 abend is issued. The application restarts after the pause request has passed.

```
//CHKPNTS DD *
PCB=4
INTVL=20
POS=ROOT
```

The following example checks every 10 seconds for a pause request. If the application is in a TIMER wait, it pauses the application with a 3303 abend. The application restarts after the pause request has passed.

```
//CHKPNTS DD *
INTVL=10
APPLWAIT=Y
```

Modifying BMP jobs so that they are not paused by the BMP handler

If you enable the BMP pause feature and you have some BMP jobs that you do not want to pause, you can disable the BMP pause feature only for such BMP jobs.

Procedure

To disable the BMP pause feature for a BMP job, specify the HRFBPOFF DD statement in the JCL of the BMP job.

For example, if you add the following HRFBPOFF DD statement to the JCL of a BMP job, the BMP handler does not pause the BMP job even when IMS Online Reorganization Facility requests the BMP job to stop.

```
//HRFBPOFF DD DUMMY
```

When this BMP job starts, IMS Online Reorganization Facility issues the following message to notify you about a BMP job that will not pause:

```
HRF01000I: BMP PAUSING IS DISABLED FOR THIS JOB
```

Applying maintenance

IMS Online Reorganization Facility maintenance sometimes requires the IMS Online Reorganization Facility load modules in online IMS subsystems to be refreshed. You can refresh the load modules without recycling the IMS subsystem by using the HRFYUTIL utility.

Before you begin

- Ensure that both IMS Online Reorganization Facility and the IMS Tools Online System Interface component are installed.
- The online IMS subsystems must have previously been started with a load library that includes all the IMS Online Reorganization Facility load modules specified in the STEPLIB or JOBLIB of IMS control regions.



Attention: You must not specify the SMP/E-managed IMS Online Reorganization Facility library directly in the STEPLIB or JOBLIB because SMP/E needs exclusive control of the library when applying maintenance.

- You must run the HRFYUTIL job on the same z/OS system on which the IMS control region is running for the targeted IMS subsystem. This job fails if there are any IMS Online Reorganization Facility jobs running at that time.

Restriction: Not all maintenance updates can be installed by this procedure because some maintenance updates still require recycling IMS subsystems.

Procedure

Complete the following steps to apply IMS Online Reorganization Facility maintenance to an online IMS subsystem:

1. Apply the maintenance to the SMP/E-managed IMS Online Reorganization Facility libraries.
2. Update the load library in the STEPLIB or JOBLIB of each IMS control region with the latest IMS Online Reorganization Facility load modules.
3. Refresh the IMS Online Reorganization Facility load modules in each online IMS subsystem by using the REFRESH command of the HRFYUTIL utility. The following example JCL shows the job to run the REFRESH command. Substitute the appropriate values for the italicized text in the JCL and submit the job.

```

//REFRESH EXEC PGM=HRFYUTIL,REGION=0M
//STEPLIB DD DISP=SHR,DSN=dbsp.shrfload
//MSGPRINT DD SYSOUT=*
//HRFSYSIN DD *
REFRESH IMSID(ssid)
//

```

Results

The IMS Online Reorganization Facility load modules are reloaded in each online IMS subsystem. You can verify the current maintenance level by the messages in the control region. When IMS control region is started, the messages that shows the build dates of IMS Online Reorganization Facility load modules are displayed in the MSGPRINT DD output of the control region. After running the REFRESH command, the same set of messages are displayed with the build dates of the refreshed load modules.

In the following example output, the IMS Online Reorganization Facility load modules are reloaded by the REFRESH command, and a new version of HRFOXCF load module becomes effective in online subsystem IMS1.

```

                                Runtime Messages
21:15:17,3 HRF01502I Online Reorg Facility DEBUG started
21:15:17,3 HRF01000I OSYS located at 0F277018
21:15:17,3 HRF01000I HRFOXCF -10/31/20-22.55
21:15:17,3 HRF01000I HRFORQ00-06/16/20-05.38
21:15:17,3 HRF01000I HRFORQ01-06/16/20-05.38
21:15:17,3 HRF01000I HRFORQ11-06/16/20-05.39
21:15:17,3 HRF01000I HRFORQ02-06/16/20-05.38
21:15:17,3 HRF01000I HRFORQ03-06/16/20-05.39
21:15:17,3 HRF01000I HRFORQ04-06/16/20-05.39
21:15:17,3 HRF01000I HRFORQ05-06/16/20-05.39
21:15:17,3 HRF01000I HRFORQ06-06/16/20-05.39
21:15:17,3 HRF01000I HRFORQ08-06/16/20-05.39
21:15:17,3 HRF01000I HRFORQ09-06/16/20-05.39
21:15:17,3 HRF01000I HRFORQ10-06/16/20-05.39
21:15:17,3 HRF01503I Joined XCF group ORFXCF as member IMS1
                :
                :
21:18:39,0 HRF01503I Left XCF group ORFXCF as member IMS1
21:18:39,0 HRF01502I Online Reorg Facility DEBUG ended
End of messages
                                Runtime Messages
21:18:39,1 HRF01502I Online Reorg Facility DEBUG started
21:18:39,1 HRF01000I OSYS located at 0F277018
21:18:39,1 HRF01000I HRFOXCF -07/26/20-22.18
21:18:39,1 HRF01000I HRFORQ00-06/16/20-05.38
21:18:39,1 HRF01000I HRFORQ01-06/16/20-05.38
21:18:39,1 HRF01000I HRFORQ11-06/16/20-05.39
21:18:39,1 HRF01000I HRFORQ02-06/16/20-05.38
21:18:39,1 HRF01000I HRFORQ03-06/16/20-05.39
21:18:39,1 HRF01000I HRFORQ04-06/16/20-05.39
21:18:39,1 HRF01000I HRFORQ05-06/16/20-05.39
21:18:39,1 HRF01000I HRFORQ06-06/16/20-05.39
21:18:39,1 HRF01000I HRFORQ08-06/16/20-05.39
21:18:39,1 HRF01000I HRFORQ09-06/16/20-05.39
21:18:39,1 HRF01000I HRFORQ10-06/16/20-05.39
21:18:39,1 HRF01503I Joined XCF group ORFXCF as member IMS1

```

Related reference

[HRFYUTIL utility](#)

The IMS Online Reorganization Facility utility (HRFYUTIL) provides supplemental functions for problem determination or maintenance. Use the HRFYUTIL utility to refresh the IMS Online Reorganization Facility load modules in an online system and to perform diagnostic tests.

Disabling the BMP pause feature

How you disable the BMP pause feature depends on how you originally enabled the feature.

Procedure

- If you followed the instructions in the topic "Enabling BMP pauses without modifying BMP application jobs" in *IMS Database Solution Pack: Overview and Customization*, restore the USERMOD, and then run the sample member HRFCBPR1 to relink the IMS region controller.
- If you followed the instructions in the topic "Enabling BMP pauses by modifying BMP application jobs" or "Enabling BMP pauses with IMS Program Restart Facility" in *IMS Database Solution Pack: Overview and Customization*, restore the USERMODs.

Disabling the CICS and ODBA applications pause feature

How you disable the pause feature for CICS and ODBA applications depends on how you originally enabled the feature.

Procedure

- If you followed the instructions in the topic "Enabling CICS and ODBA applications pauses without modifying the IMS SDFSRESL data set" in *IMS Database Solution Pack: Overview and Customization*, remove the DFSDBCTG module that is created by IMS Online Reorganization Facility from the STEPLIB DD concatenation of IMS control region JCL, and recycle the all affected control regions.
- If you followed the instructions in the topic "Enabling CICS and ODBA applications pauses by modifying the IMS SDFSRESL data set" in *IMS Database Solution Pack: Overview and Customization*, run the sample member HRFCAPJ3 to restore the USERMOD; run the sample member HRFCAPR1 to relink the DFSDBCTG module; and then recycle the all affected control regions.

Chapter 4. Reference

The following topics describe IMS Online Reorganization Facility sample members and supplemental tools.

Topics:

- [“Sample library members” on page 131](#)
- [“HRFYUTIL utility” on page 132](#)
- [“HRFOLOGF exit routine” on page 134](#)
- [“How to read syntax diagrams” on page 134](#)

Sample library members

The sample library (SAMPLIB) that is supplied with IMS Online Reorganization Facility contains JCL that you can use as a model to create your own jobs.

The IMS Online Reorganization Facility SAMPLIB includes the following samples:

HRFCAPxx

These members contain sample JCL to install the pause feature for CICS and ODBA applications of IMS Online Reorganization Facility.

To install this feature, see the topic "Enabling the CICS and ODBA applications pause feature" in *IMS Database Solution Pack: Overview and Customization*.

HRFCBPxx

These members contain sample JCL and USERMODs to install the BMP pause feature of IMS Online Reorganization Facility.

To install this feature, see the topic "Enabling the BMP pause feature" in *IMS Database Solution Pack: Overview and Customization*.

HRFCINST

This member contains the JCL to install IMS Online Reorganization Facility.

You must run this member for the initial installation. This JCL defines the restart data set (KSDS).

HRFCCNFG

This member contains the JCL to define base configuration parameters for IMS Online Reorganization Facility.

Run this member when you want to customize the base environment after you perform the initial installation. This JCL creates the base configuration module HRFSETOP or an alternate base configuration module HRF#ssid.

HRFELOGF

Use this member to select and format the IMS Online Reorganization Facility change records. Use this member for debugging.

HRFEORG1 **HRFEORG2**

These members contain sample JCL to run the reorganization.

HRFERCOV

This member contains sample JCL to synchronize image copy time stamps to recover a database data set from image copy by using the standard IMS recovery utility.

HRFERINT

This member contains sample JCL to turn on and turn off the REORG INTENT flag in DBRC.

HRFERSTA

This member contains sample JCL to restart a delayed or failed IMS Online Reorganization Facility job. The HRFERSTA job works if the previous job was delayed in TAKEOVER (TAKEOVER(Delay)) or failed during the Takeover phase.

HRFYUTIL utility

The IMS Online Reorganization Facility utility (HRFYUTIL) provides supplemental functions for problem determination or maintenance. Use the HRFYUTIL utility to refresh the IMS Online Reorganization Facility load modules in an online system and to perform diagnostic tests.

You must run the HRFYUTIL job on the same z/OS system on which the IMS control region is running for the targeted IMS subsystem.

EXEC statement

The EXEC statement for the HRFYUTIL utility is in the following format:

```
//stepname EXEC PGM=HRFYUTIL,REGION=rrrM
```

Specify HRFYUTIL as the program name. Ensure that sufficient region size is specified on the REGION parameter.

DD statements

HRFSYSIN

Required. Indicates the input control statement data set.

Format: RECFM=F or FB, LRECL=80

MSGPRINT

Optional. Indicates the SYSOUT data set where runtime messages are logged. If this DD statement is not specified, it is dynamically allocated.

Format: RECFM=FA, LRECL=133

Control statements

You must specify control statements in the HRFSYSIN input control data set to identify the function of the HRFYUTIL utility. You can specify any number of control statements to identify which databases and data sets to process for diagnostic analysis.

A control statement consists of one command and one or more keywords. You must begin the control statement with the DEBUG command or the REFRESH command.

Commands

DEBUG

The DEBUG command starts and stops the diagnostic test. During the diagnostic test, additional diagnostic information is generated in the IMS control region. For more information, see [“Generating additional diagnostic information” on page 138](#). This command fails if it is executed while IMS Online Reorganization Facility jobs are running.



Attention: Use the DEBUG command only at the direction of IBM Software Support and only during a time when additional system processing can be accommodated. This utility causes additional system processing for all the calls and logging in the IMS control region. A large amount of SYSOUT data might be written in the IMS control region while this utility is active.

REFRESH

The REFRESH command refreshes the IMS Online Reorganization Facility load modules in an online system. The load modules are reloaded from the STEPLIB or JOBLIB DD concatenation of the IMS

control region. This command fails if it is executed while IMS Online Reorganization Facility jobs are running.

Restriction: Not all the IMS Online Reorganization Facility load modules are reloaded by this command because some modules are reloaded only when IMS is recycled.

Keywords for the DEBUG command

IMSID

Required. Indicates the target IMS subsystem ID on which to activate or stop diagnostic tests.

Format

Any valid 1- to 4-character subsystem ID.

Default

None.

ACTION

Required. Indicates whether to start or stop diagnostic tests.

Format

Specify **START**: starts providing additional diagnostic tests.

Specify **STOP**: stops providing additional diagnostic tests.

Keywords for the REFRESH command

IMSID

Required. Indicates the target IMS subsystem ID in which the IMS Online Reorganization Facility load modules are reloaded.

Format

Any valid 1- to 4-character subsystem ID.

Default

None.

Examples

Examples for the DEBUG command

The following example starts a diagnostic test. The example includes the EXEC statement, the DD statements, and the control statements.

```
//UTIL EXEC PGM=HRFYUTIL,REGION=0M
//STEPLIB DD DISP=SHR,DSN=DBSP.SHRFLOAD
//MSGPRINT DD SYSOUT=*
//HRFSYSIN DD *
DEBUG IMSID(IMS1) ACTION(START)
//
```

The following example stops a diagnostic test. The example includes the EXEC statement, the DD statements, and the control statements.

```
//UTIL EXEC PGM=HRFYUTIL,REGION=0M
//STEPLIB DD DISP=SHR,DSN=DBSP.SHRFLOAD
//MSGPRINT DD SYSOUT=*
//HRFSYSIN DD *
DEBUG IMSID(IMS1) ACTION(STOP)
//
```

Examples for the REFRESH command

The following example refreshes the IMS Online Reorganization Facility load modules in online system IMS1.

```
//UTIL EXEC PGM=HRFYUTIL,REGION=0M
//STEPLIB DD DISP=SHR,DSN=DBSP.SHRFLOAD
//MSGPRINT DD SYSOUT=*
//HRFSYSIN DD *
```

```
REFRESH IMSID(IMS1)
//
```

HRFOLOGF exit routine

The HRFOLOGF exit routine formats the log records that IMS Online Reorganization Facility writes to the IMS log for the databases that have change capture active. The HRFOLOGF exit routine is for the IMS File Select and Formatting Print utility (DFSERA10).

For more information about the DFSERA10 utility, see *IMS System Utilities*.

The following example requests the HRFOLOGF exit routine through the DFSERA10 utility.

```
//LOGPRINT EXEC PGM=DFSERA10
//STEPLIB DD DISP=SHR,DSN=IMS.SDFSRESL
// DD DISP=SHR,DSN=DBSP.SHRFLOAD
//SYSPRINT DD SYSOUT=*
//SYSUT1 DD DISP=SHR,DSN=ims_log_dataset
//SYSIN DD *
CONTROL CNTL SKIP=0,STOPAFT=EOF,DDNAME=SYSUT1
OPTION PRINT OFFSET=5,VALUE=F0,EXITR=HRFOLOGF, +
PARM=(IOAREA=Y,DUMP=N,DEBUG=Y)
END
//
```

The important values in the SYSIN control statements include the following items:

EXITR=HRFOLOGF

Calls the IMS Online Reorganization Facility formatting exit routine for the selected log records.

OFFSET=5

Identifies the offset of the log record ID.

VALUE=F0

Specifies the log records to select. This value must be the same value as was specified in the HRFSETOP options ULOGID=.

The default for HRFSETOP is 'F0'.

PARM=

Specifies the processing options for the IMS Online Reorganization Facility formatting exit routine (HRFOLOGF).

IOAREA=

Controls whether to format the user I/O area for any captured log records. Formatting the I/O area substantially increases the amount of print output that is generated.

Specify IOAREA=Y to format the user IOAREA. Specify IOAREA=N to not format the user I/O area.

DUMP=

Specifies whether to include a hex dump of each log record with the formatted output.

Specify DUMP=Y to include a hex dump of each log record. Specify DUMP=N to not include a hex dump of each log record.

DEBUG=

Controls whether to format the additional log records that DEBUG generates. Formatting the additional log records substantially increases the amount of print output that is generated.

Specify DEBUG=Y to format the additional log records. Specify DEBUG=N to not format the additional log records.

How to read syntax diagrams

The following rules apply to the syntax diagrams that are used in this information:

- Read the syntax diagrams from left to right, from top to bottom, following the path of the line. The following conventions are used:

- The >>--- symbol indicates the beginning of a syntax diagram.
- The ---> symbol indicates that the syntax diagram is continued on the next line.
- The >--- symbol indicates that a syntax diagram is continued from the previous line.
- The --->< symbol indicates the end of a syntax diagram.
- Required items appear on the horizontal line (the main path).

▶▶ *required_item* ▶▶

- Optional items appear below the main path.

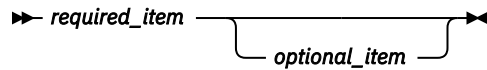

If an optional item appears above the main path, that item has no effect on the execution of the syntax element and is used only for readability.

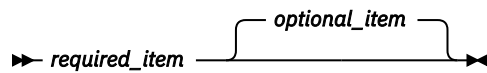

- If you can choose from two or more items, they appear vertically, in a stack.

If you *must* choose one of the items, one item of the stack appears on the main path.

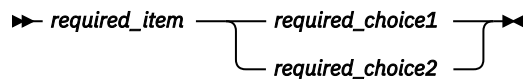

If choosing one of the items is optional, the entire stack appears below the main path.

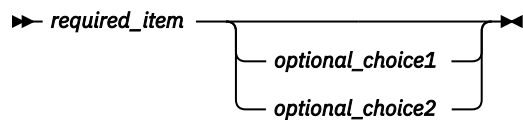

If one of the items is the default, it appears above the main path, and the remaining choices are shown below.

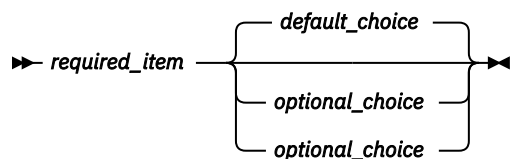

- An arrow returning to the left, above the main line, indicates an item that can be repeated.

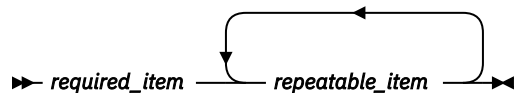

If the repeat arrow contains a comma, you must separate repeated items with a comma.

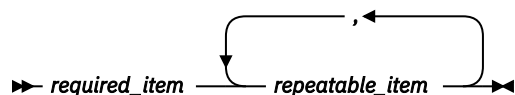

A repeat arrow above a stack indicates that you can repeat the items in the stack.

- Sometimes a diagram must be split into fragments. The syntax fragment is shown separately from the main syntax diagram, but the contents of the fragment should be read as if they are on the main path of the diagram.

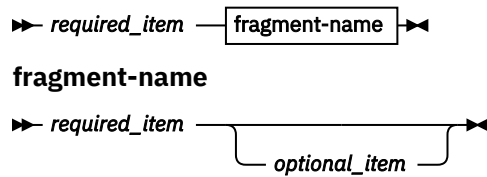

- A b symbol indicates one blank position.
- Keywords, and their minimum abbreviations if applicable, appear in uppercase. They must be spelled exactly as shown. Variables appear in all lowercase italic letters (for example, *column-name*). They represent user-supplied names or values.
- Separate keywords and parameters by at least one space if no intervening punctuation is shown in the diagram.
- Enter punctuation marks, parentheses, arithmetic operators, and other symbols exactly as shown in the diagram.
- Footnotes are shown by a number in parentheses; for example, (1).

Chapter 5. Troubleshooting

Use the following information to troubleshoot IMS Online Reorganization Facility problems.

Topics:

- [“Reorganization job fails to connect to an online IMS subsystem” on page 137](#)
- [“Generating additional diagnostic information” on page 138](#)
- [“Messages and codes” on page 139](#)
- [“Gathering diagnostic information” on page 189](#)

Reorganization job fails to connect to an online IMS subsystem

A problem that users sometimes encounter is the failure of an IMS Online Reorganization Facility job to connect to an online IMS subsystem.

The following subsections describe what happens when an IMS Online Reorganization Facility job cannot connect to an online IMS subsystem.

Symptoms

The following messages are displayed when you try to run the job:

```
HRF01511E Target member imsid not active  
HRF01107E Online subsystem imsid not available
```

The messages are incorrect because the specified IMS subsystem is active and available.

Cause

The IMS Tools Online System Interface component was not activated in the control region, or a different XCF group name was specified in the control region and in the IMS Online Reorganization Facility job.

When you submit an IMS Online Reorganization Facility job, it attempts to connect to every online IMS subsystem that has access to the database that is being reorganized. These connections capture concurrent updates and control access to the database during certain points of the reorganization process. If the job cannot connect to every online IMS subsystem, the job abnormally terminates.

Description

To determine which online IMS subsystems have access to the database that is being reorganized IMS Online Reorganization Facility reads the subsystem records from the RECON. If the RECON lists any abnormally terminated online subsystems, IMS Online Reorganization Facility cannot continue because it cannot connect to the subsystem to determine the database status.

IMS Online Reorganization Facility attempts to establish two XCF connections to each active online subsystem in the RECON. The first XCF connection captures and receives concurrent updates that might occur while IMS Online Reorganization Facility performs the reorganization. This connection is called the change capture interface.

The second connection issues operator commands that displays or control access to the database if necessary. This connection is called the IMS Tools Online System Interface.

Two XCF connections are required because the change capture interface is for only IMS Online Reorganization Facility, whereas the IMS Tools Online System Interface can be shared by several IMS Tools.

Solution

Complete the following configuration tasks, which are described in *IMS Database Solution Pack: Overview and Customization*.

- "Configuring IMS exit routines for IMS Online Reorganization Facility"
- "Configuring the base environment for IMS Online Reorganization Facility"

After you configure the XCF connections, verify that the following messages are displayed:

```
HRF01000I Change receiver started
HRF01503I Joined XCF group ORFXCF as member jobname.dbdname
HRF01108I Change receiver interface connected to online subsystem ssid
HRF01000I TOSI interface started
HRF01503I Joined XCF group TOIXCF as member jobname
HRF01108I TOSI interface connected to online subsystem ssid
```

Generating additional diagnostic information

Use the IMS Online Reorganization Facility utility (HRFYUTIL) to generate additional diagnostic information for use in troubleshooting.

About this task

Use the HRFYUTIL utility to start and stop a diagnostic test. During the test, the change capture process gathers additional information about the updates that occur within the control region.

When you start a diagnostic test, MSGPRINT and TRACE SYSOUT files are dynamically allocated in the IMS control region. The additional information is provided to these two data sets. Additional IMS Online Reorganization Facility log records are written to the IMS log for the databases that have change capture active. To format the log records, use the HRFOLOGF exit routine and the IMS File Select and Formatting Print utility (DFSERA10).

Important: Perform a diagnostic test only at the direction of IBM Software Support and only when additional system processing can be accommodated. The diagnostic test causes additional system processing for all the calls and logging in the IMS control region. A large amount of SYSOUT data might be written in the IMS control region while this utility is active.

Procedure

Complete the following steps to generate additional diagnostic information:

1. Start a diagnostic test by using the DEBUG command and the ACTION(START) keyword of the HRFYUTIL utility.

For instructions, see [“HRFYUTIL utility” on page 132](#).

2. Run the online reorganization job that you want to diagnose.

Additional diagnostic information is written to MSGPRINT and TRACE SYSOUT files in the IMS control region.

3. Stop the diagnostic test by using the DEBUG command and the ACTION(STOP) keyword of the HRFYUTIL utility.

4. Format the IMS Online Reorganization Facility log records that are written to the IMS log by using the HRFOLOGF exit routine with the IMS File Select and Formatting Print utility (DFSERA10).

For instructions, see [“HRFOLOGF exit routine” on page 134](#). The formatted log records are written to the output data set of the DFSERA10 utility.

Results

Additional diagnostic information is written to MSGPRINT and TRACE SYSOUT files in the IMS control region. The IMS Online Reorganization Facility log records are extracted from the IMS log and written to the output data set of the DFSERA10 utility. Provide this diagnostic information to IBM Software Support.

Messages and codes

Messages and abend codes that might be issued by IMS Online Reorganization Facility are listed here.

Return codes and abend codes

The following table shows the return codes and abend codes, associated reason codes, and meanings.

Table 5. Return codes and abend codes of the IMS Online Reorganization Facility process

Return code or abend code	Reason code	Meaning
Return code 0	None	IMS Online Reorganization Facility processing completed successfully.
Return code 4	None	<ul style="list-style-type: none">• A DBD change was requested with ONLINECHANGE(N) specified. The database is left in the prohibit authorization (PROHIBIT AUTH = ON) state. You must manually complete the remaining tasks to make the DBD change available.• Data sets were found for a DBD change with ONLINECHANGE(Y) specified and with no IMSACBA or IMSACBB specified. The database is left in the prohibit authorization (PROHIBIT AUTH = ON) state.• A job reached the Takeover phase successfully and you specified TAKEOVER(DELAY). Restart information was saved in the RESTART data set. The database is left offline and in the prohibit authorization (PROHIBIT AUTH = ON) state.
Return code 20	None	A critical error occurred. Processing terminated with a U999 abend.
Abend code U999		Processing did not complete successfully. Processing terminated. The reason code identifies the status of databases. For more information, see MSGPRINT.
	1	Processing terminated before the Takeover phase. Databases remain online in the original state. Backout process ended successfully.
	2	Processing terminated after the Takeover phase. Databases have been reorganized and are online.
	F	Processing terminated during the Takeover phase. Databases are left offline and in the prohibit authorization (PROHIBIT AUTH = ON) state.

Messages

Use the information in these messages to diagnose and solve IMS Online Reorganization Facility problems.

Message format

IMS Online Reorganization Facility messages adhere to the following format:

```
HRF0nnnnx
```

where:

HRF0

Indicates that the message was issued by IMS Online Reorganization Facility

nnnn

Indicates the message identification number

x

Indicates the severity of the message:

A

Indicates that operator intervention is required before processing can continue.

E

Indicates that an error, which might or might not require operator intervention, occurred.

I

Indicates that the message is informational only.

W

Indicates that the message is a warning to alert you to a possible error condition.

Each message also includes the following information:

Explanation:

The Explanation section explains what the message text means, why it occurred, and what its variables represent.

System action:

The System action section explains what the system does in response to the event that triggered the message.

User response:

The User response section describes whether a response is necessary, what the appropriate response is, and how the response will affect the system or program.

HRF01000I *text*

Explanation

The *text* of this message provides information about the error.

System action

None.

User response

None. This message is informational.

HRF01000E *text*

Explanation

The *text* of this message provides information about the error.

System action

None.

User response

None.

HRF01001I **Control cards used in this run**

Explanation

Displays the control statements that you supplied.

System action

None.

User response

None. This message is informational.

HRF01002I Utility driver [started | ended | terminated] with error.

Explanation

This message indicates the start or termination of a batch run. Previous messages indicate a possible error reason.

System action

None.

User response

None. This message is informational.

HRF01003I Highest return code is *nnnn*

Explanation

The highest return code of the utilities and functions is *nnnn*.

System action

None.

User response

None. This message is informational.

HRF01004E Error return code is *nnnn*, reason code *rrrr*

Explanation

A utility function ended with an error. The return code is indicated by *nnnn*, and the reason code is indicated by *rrrr*.

System action

The utility has been terminated.

User response

Evaluate the preceding error messages to determine the cause of the problem and resolve the error condition.

HRF01005E Expected continuation not received.

Explanation

The control statements are in error. A continuation was indicated, but no additional control statement was found.

System action

Processing terminates.

User response

Correct the control statement error, and resubmit the job.

HRF01006E No commands found.

Explanation

The HRFSYSIN file was specified, but no control statements were specified.

System action

Processing terminates.

User response

Provide the necessary control statements.

HRF01007E Invalid command *cmd* found in line *nnn*.

Explanation

The command *cmd* is invalid. The control statement line is indicated by *nnn*.

System action

Processing terminates.

User response

Correct the control statement and resubmit the job.

HRF01008E Invalid keyword *key* found in line *nnn*.

Explanation

The keyword *key* is not valid for the specified command.

System action

Processing terminates.

User response

Correct the control statement and resubmit the job.

HRF01009E Invalid syntax for keyword *key* in line *nnn*.

Explanation

The keyword requires syntax rules. Syntax rules are *numeric*, *ddname*, *dsname*; or *yes* or *no*. Message HRF01014I is issued to show the reason for the error.

System action

Processing terminates.

User response

Correct the control statement and resubmit the job.

HRF01010E Duplicate keyword *key* in line *nnn*.

Explanation

The keyword *key* is being used more than once in the same command.

System action

Processing terminates.

User response

Remove the duplicate keyword and resubmit the job.

HRF01011E No command found in line *nnn*.

Explanation

A command must start within the first 20 bytes of a control statement. No command was found.

System action

Processing terminates.

User response

Correct the control statement and resubmit the job.

HRF01012E Command *cmd* requires keyword *key*.

Explanation

The indicated keyword *key* is required for this command *cmd*.

System action

Processing terminates.

User response

Add the keyword and resubmit the job.

HRF01013E Keyword *key* and *key* are mutually exclusive.

Explanation

Mutually exclusive keywords have been specified.

System action

Processing terminates.

User response

Correct the control statement and resubmit the job.

HRF01014I Reason is *rsn*

Explanation

This message explains control statement errors. The variable *rsn* provides information about the control statement errors.

System action

None.

User response

None. This message is informational.

HRF01015E Keyword *key* requires keyword *key*

Explanation

Both of the specified keywords are required and must be specified.

System action

Processing terminates.

User response

Add the missing keyword and resubmit the job.

HRF01016I **Command ccccc started/ended/
terminated**

Explanation

Command ccccc has either started or ended.

System action

None.

User response

None. This message is informational.

HRF01017E **Nothing to schedule**

Explanation

After all control cards have been checked, no command was scheduled to be processed.

System action

Processing stops.

User response

Keep the output listing, and contact IBM Software Support.

HRF01018E **No control cards specified.**

Explanation

The file HRFSYSIN is empty.

System action

Processing terminates.

User response

Provide control statements.

HRF01019I **IMS batch driver started/ended**

Explanation

To support additional functionality, the IMS batch driver component is used to run IMS applications in a shell.

System action

None.

User response

None. This message is informational.

HRF01020E **DBD nnnnn is in error, reason: rrr**

Explanation

The DBD decoder found errors for DBD nnnnn. These errors are typically caused by one or more of the following conditions:

- The DBD version is not supported.
- The DBD type is not supported.
- DBD nnnnn is not a valid DBD.
- The DBD name is different from the member name. The member name in the DBD library and the name inside the DBD are different. The name inside the DBD is the valid name.
- The index DBD has no primary DBD.

System action

Processing stops.

User response

Correct the invalid DBDs, and restart the process.

HRF01021E **IMS or DBDLIB DD-statement
missing**

Explanation

The JCL is missing one or both of these statements.

System action

Processing stops.

User response

Add the IMS DD statement that describes the appropriate DBDLIBs.

HRF01022E **RESLIB not in STEPLIB
concatenation**

Explanation

The IMS SDFSRESL is not available to this job step.

System action

Processing stops.

User response

Add the IMS SDFSRESL to the STEPLIB.

HRF01025E DBD *nnnnn* not found

Explanation

DBD *nnnnn* was requested, but is not in the DBD library.

System action

The job step ends.

User response

Ensure that the correct DBD library is being used. The IMS DD statement is pointing to those files.

HRF01030E DBRC not operational

Explanation

DBRC was requested, but DBRC initialization failed.

System action

Processing stops.

User response

Keep the output listing and contact IBM Software Support.

**HRF01031I DBRC subsystem *nnnnn* signon/
signoff successful/failed**

Explanation

This message is displayed at the start or the end of the DBRC connection. *nnnnn* indicates the specified subsystem name.

System action

None.

User response

If no request to DBRC is required, this message might be appropriate. However, if subsequent errors are displayed, the reason might be an error in DBRC connection.

HRF01032E HALDB master DBD *nnnnn* is not in the RECON

Explanation

The master DBD definition of a HALDB is kept in the RECON. A HALDB DBD named *nnnnn* was requested. The RECON does not have a record for this DBD.

System action

Processing stops.

User response

Ensure that the correct DBD name is being requested. If the correct DBD name is being requested, the RECON that was specified might be incorrect.

HRF01033E DBD *nnnnn* is not HALDB

Explanation

The DBD *nnnnn* is not a HALDB DBD.

System action

Processing stops.

User response

Ensure that the correct DBDLIB is being used. If the DBDLIB is correct, you must convert the specified DBD to HALDB.

HRF01034E Partition *nnnnn* is not in master DBD *dddd*

Explanation

Partition *nnnnn* was requested. However, *nnnnn* is not defined within its master DBD *dddd*.

System action

Processing stops.

User response

Ensure that the partition and the DBD names are correct. If the partition and the DBD names are correct, then the RECON that was specified might be incorrect.

HRF01035I Partition *pppp* authorized *nnnn*

Explanation

Partition *pppp* has been authorized with DBRC. *nnnn* is the authorization scope. It can be read, read exclusive, update, or exclusive.

System action

The specified partition is authorized with DBRC.

User response

None. This message is informational.

HRF01036E **Partition *pppp* not authorized, reason is *nn***

Explanation

Partition *pppp* could not be authorized with DBRC. The reason code *cc* can be found in message DFS047I.

System action

Processing stops.

User response

Make the database available by issuing the appropriate IMS commands.

HRF01037I **Partition *pppp* authorization released**

Explanation

Partition *pppp* is no longer authorized for the current function.

System action

None.

User response

None. This message is informational.

HRF01038E **Error during START of ISPF, reason code is *xx***

Explanation

The ISPF application failed during startup.

System action

The application terminated.

User response

Take the appropriate action based on the reason code:

- Reason code 20 indicates that a previous error occurred.
Save the trace screen, and contact IBM Software Support.
- Reason code 21 is accompanied by a trace screen.
Save the trace screen, and contact IBM Software Support.
- Reason codes 22 - 24 indicate that an internal error occurred.

Contact IBM Software Support.

HRF01039E **orphaned split data is *nnn***

Explanation

When IMS Online Reorganization Facility scanned the primary database to build a shadow copy of the primary index, the data portions of some split root segments did not have corresponding segment portions.

System action

The IMS Online Reorganization Facility job continues.

User response

The number of orphaned split data segments should be small. If the number is 10 or higher, the primary database might have a problem. Check the primary database.

HRF01040I **Data set *dsname* not found**

Explanation

Dynamic allocation returned an error when allocating the data set named *dsname*. The data set was not found.

System action

If the data set is essential, the process terminates with error.

User response

The data set name comes from the MDALIB or from the RECON. Correct the data set name in those places and resubmit the job.

HRF01041I **Data set *dsname* in use**

Explanation

Dynamic allocation returned an error when allocating the data set. The data set is allocated in an exclusive state by a different job.

System action

The process terminates.

User response

Wait until the other job releases the data set and resubmit your job.

HRF01042E **Subtask *task id* has terminated abnormally.**

Explanation

The functions of IMS Online Reorganization Facility run as subtasks. Some subtasks might run in parallel. The specified subtask did not complete normally.

System action

The process is terminated. The final abend code is U999.

User response

Collect the job output, including the dump, and contact IBM Software Support.

HRF01043E **Abend code is *code***

Explanation

This message follows HRF01042E and displays the abend code.

System action

The process terminates.

User response

Collect the job output, including the dump, and contact IBM Software Support.

HRF01044E **Unexpected end of service task *task***

Explanation

The service task *task* terminated unexpectedly.

System action

The process terminates.

User response

Collect the job output, including the dump, and contact IBM Software Support.

HRF01045I **Return code is *nnnn***

Explanation

The command ended with return code *nnnn*.

System action

None.

User response

None. This message is informational.

HRF01050E **DD statement *ddname* not found in JCL**

Explanation

The DD statement *ddname*, which is required, is not present in the JCL.

System action

Processing terminates.

User response

Provide the specified DD statement and resubmit the job.

HRF01052E **Error from Sort**

Explanation

Standard sort is used. The sort returned with an error.

System action

Processing terminates.

User response

Collect the sort job output, including the dump, and contact IBM Software Support.

HRF01053E **VSAM *func* error DD=*ddname*, RC=*rc*, RPL feedback=*fdbk*.**

Explanation

The indicated VSAM function experienced an error.

System action

Processing terminates.

User response

Collect the VSAM job output, including the dump, and contact IBM Software Support.

HRF01055E **Errors in control cards.**

Explanation

This message is preceded by other messages that identify errors in control statements.

System action

Processing terminates.

User response

Correct control statement errors and resubmit the job.

HRF01057E **Data set *dsname* ignored**

Explanation

The IDCAMS rebuild process is attempting to retrieve the data set attributes from existing data sets. The specified data set *dsname* could not be found.

System action

No IDCAMS statements are created for the target file.

User response

Manually allocate the file to copy.

HRF01060I **Total records in index *xxxxx* are
*nnnn***

Explanation

The message displays the number of records in index *xxxxx*.

System action

None.

User response

None. This message is informational.

HRF01061I **Initial load for DBD *dbd***

Explanation

The specified DBD is loading the database by using a PROCOPT=L PSB.

System action

None.

User response

None. This message is informational.

HRF01062I **Loading index DBD *dbd***

Explanation

While the primary database is loaded (see HRF01061I), the secondary index *dbd* is also loaded.

System action

None.

User response

None. This message is informational.

HRF01063I **Loading index file *ddname***

Explanation

The PSINDEX file *ddname* is loaded as part of loading the secondary index.

System action

None.

User response

None. This message is informational.

HRF01064I **Number of records in file *ddname*
is *nnn***

Explanation

The PSINDEX file *ddname* has been loaded. The number of records in this file is *nnn*.

System action

None.

User response

None. This message is informational.

HRF01065I **Application program *pgm* started/
ended**

Explanation

The application program *pgm* is participating in the PROCOPT=L support function. The message shows the start and the end of the program.

System action

None.

User response

None. This message is informational.

HRF01066I **PSB is *psb***

Explanation

The message shows the PSB that was used by this application.

System action

None.

User response

None. This message is informational.

HRF01067I **Application program return code is *nnnn***

Explanation

The application ended with the specified return code.

System action

None.

User response

None. This message is informational.

HRF01068I **IMS version is *vers***

Explanation

The message shows the IMS version that is currently being used.

System action

None.

User response

None. This message is informational.

HRF01069E **DDname *ddn* is not part of the DBD *dbd***

Explanation

The DD name *ddn* does not belong to the specified DBD.

System action

Processing stops.

User response

Keep the output listing, and contact IBM Software Support.

HRF01070E **DBD *dbd* is OSAM, but file allocated is VSAM**

Explanation

During data set verification, a mismatch was found between the DBD type and the file type.

System action

Processing stops.

User response

Verify that both the MDA library and the DBD library are correct.

HRF01071E **DBD *dbd* is VSAM, but file allocated as OSAM**

Explanation

During data set verification, a mismatch was found between the DBD type and the file type.

System action

Processing stops.

User response

Verify that both the MDA library and the DBD library are correct.

HRF01072E **File *ddn* is OSAM/KSDS/ESDS but should be OSAM/KSDS/ESDS**

Explanation

The DD name *ddn* has an invalid file type.

System action

Processing stops.

User response

Assign the correct data set to the file that is indicated by *ddn*.

HRF01073I **IMS region controller started or ended**

Explanation

This message is issued to indicate the start or the end of an IMS Batch region.

System action

None.

User response

None. This message is informational.

HRF01074I **Sorting index file *ddn***

Explanation

This is part of the initial load support function. The PSINDEX file *ddn* is being sorted and created.

System action

None.

User response

None. This message is informational.

HRF01075E **Database record key out of range**

Explanation

The current function unloads a DBD that is participating in a user-partitioning conversion, during which multiple identical DBDs are converted to one HALDB. The high-level qualifier key of each DBD has been specified. The unload function of this DBD detected that a key is not within its boundaries.

System action

Processing stops.

User response

Begin the boundary selection process again. The initial boundary selection might be incorrect.

HRF01076I **Key: *kkkkkkkkkkkkkkkkkkkk***

Explanation

This message is related to HRF01075E. It shows the key in process.

System action

Processing stops.

User response

Begin the boundary selection process again. The initial boundary selection might be incorrect.

HRF01077I **Low key: *kkkkkkkkkkkkkkkkkkkk***

Explanation

This message is related to HRF01075E. It shows the lowest key that this DBD is allowed to accept.

System action

Processing stops.

User response

Begin the boundary selection process again. The initial boundary selection might be incorrect.

HRF01078I **High key: *kkkkkkkkkkkkkkkkkkkk***

Explanation

This message is related to HRF01075E. It shows the highest key that this DBD is allowed to accept.

System action

Processing stops.

User response

Begin the boundary selection process again. The initial boundary selection might be incorrect.

HRF01079I **HSSR region controller started or ended.**

Explanation

This message is issued during the unload phase. HSSR is used to assist the unload function.

System action

None.

User response

None. This message is informational.

HRF01080I **Start of *ddname* listing.**

Explanation

The specified file is being listed. The possible DDNAMEs are DFSVSAMP and DFSHALDB.

System action

None.

User response

None. This message is informational.

HRF01081I **End of *ddname* listing**

Explanation

The listing of the specified file has ended.

System action

None.

User response

None. This message is informational.

HRF01082I **Unloading DBD *dbd***

Explanation

The database *dbd* is currently being unloaded.

System action

None.

User response

None. This message is informational.

HRF01083I **Loading DBD *dbd***

Explanation

The database *dbd* is currently being loaded.

System action

None.

User response

None. This message is informational.

HRF01084I ***nnnn* database records read
[*FINAL*]**

Explanation

This progress message is issued every 250,000 database records (root segments). *FINAL* is appended to the message when it is issued for the last set of records.

System action

None.

User response

None. This message is informational.

HRF01085E **Error in partition part *part*, data set *ddn***

Explanation

This message is accompanied by HRF01086E or HRF01087E.

System action

Processing stops.

User response

Keep the output listing, and contact IBM Software Support.

HRF01086E **Expected partition *part*, found *part***

Explanation

The partitioning scheme is in the wrong order.

System action

Processing stops.

User response

Keep the output listing, and contact IBM Software Support.

HRF01087E **Status code *cc* received**

Explanation

The status code *cc* was received as a response from an IMS call.

System action

Processing stops.

User response

If the status code indicates that a database is unavailable, make the database available and rerun the job. In all other cases, keep the output listing, and contact IBM Software Support.

HRF01088E **Utility terminates with error**

Explanation

An error condition occurred. Previous messages explain the error.

System action

Processing stops.

User response

Proceed as instructed by previous messages that explain the error.

HRF01089I Analyzing DBD *dbdname*

Explanation

The specified DBD is analyzed.

System action

None.

User response

None. This message is informational.

HRF01090E Last partition is already empty

Explanation

The last partition does not contain any data. The request to add an empty partition at the end is not necessary.

System action

The request to add an additional empty partition is ignored. The requested process is not performed.

User response

None. Because the last partition is already empty, you do not need to run the process again.

HRF01091E MDA *dbdname* DDname *ddname* not found

Explanation

The MDA member *dbdname* does not have the specified DD defined.

System action

The process terminates.

User response

Correct the specified MDA member, and resubmit the job.

HRF01092I DBDGEN complete for DBD *dbdname*

Explanation

The specified DBD has been compiled and linked.

System action

None.

User response

None. This message is informational.

HRF01093E DDname *dbdname* not found

Explanation

The specified DD statement was not found in the JCL.

System action

The process terminates.

User response

Add the specified DD statement, and resubmit the job.

HRF01094I DBD *dbdname* has external logical relationship

Explanation

The specified DBD has a logical relationship to a different DBD.

System action

Processing continues.

User response

None. This message is informational.

HRF01094E DBD *dbdname* has external logical relationship.

Explanation

The specified DBD has a logical relationship to a different DBD. This type of relationship is not supported by the REORG command of IMS Online Reorganization Facility; therefore, the specified DBD

cannot be reorganized with IMS Online Reorganization Facility.

System action

Processing terminates.

User response

None.

HRF01095E **DBD *dbdname* has HALDB OLR active.**

Explanation

IMS OLR is currently reorganizing this partition. IMS Online Reorganization Facility cannot run with OLR active. This situation can also occur when OLR is paused. The indication is that both the A-J and M-V data sets are active.

System action

Processing terminates.

User response

Reorganize a different partition, or resubmit the job after OLR completes.

HRF01096E **DBD *dbdname* is HALDB with logical relationship**

Explanation

The specified DBD is a HALDB and has a logical relationship. To process a HALDB database with logical relationships, all partitions must be processed in the IMS Online Reorganization Facility job.

System action

Processing terminates.

User response

To process all partitions in one IMS Online Reorganization Facility job, specify the PARTITION(*) keyword, and resubmit the job.

HRF01097E **DBD *dbdname* is not registered.**

Explanation

The specified DBD is not in DBRC. IMS Online Reorganization Facility requires that the DBDs must be registered. This requirement also applies to the index DBDs.

System action

Processing terminates.

User response

Register this DBD and all its index DBDs and resubmit the job.

HRF01098E **DBD *dbdname* has conflicting DBRC definitions.**

Explanation

The specified DBD does not match its DBRC definition.

System action

Processing terminates.

User response

Compare the DBD to a LIST.RECON of the DBD. Correct the errors and resubmit the job.

HRF01099E **DBD *dbdname* has *dbrc status*.**

Explanation

The specified DBD has a DBRC status that does not allow the processing of this DBD.

System action

Processing terminates.

User response

Correct the DBRC exception and resubmit the job.

HRF01100I ***process started in sub address space: JOBID=jobid, JOBNAME=jobname***

Explanation

The specified process started in a dependent address space.

System action

None.

User response

None. This message is informational.

HRF01101I ***process ended in sub address space, return code code***

Explanation

The specified process ended in a dependent address space.

System action

None.

User response

None. This message is informational.

HRF01102E Sub address space terminated abnormally

Explanation

The dependent address space did not end normally.

System action

The primary address space terminates. The messages are displayed in the message file.

User response

This message is accompanied by another message that indicates the cause of the error. If you cannot resolve the problem, contact IBM Software Support.

HRF01103E DBD *dbdname* does not have DBDS *ddname* in DBRC

Explanation

The specified DBD does not have the DBDS record defined in DBRC. The DBD definition in DBRC is incomplete.

System action

The process terminates.

User response

Add the specified DBDS to the RECON. Use the INIT.DBDS function of the DBRC utility.

HRF01104E Dynamic allocation failed, DSN *dsname*

Explanation

The *dsname* data set is probably a database data set. The data set name was obtained from the RECON. Additional messages explain the reason for the allocation failure.

System action

Processing terminates.

User response

Correct the reason for the allocation failure and resubmit the job.

HRF01105E DSN *dsname* is too long.

Explanation

The length of the specified database data set name exceeds the maximum allowable length. Database data set names are appended with ".S", which means that database data set names can be a maximum of 42 characters.

System action

Processing terminates.

User response

Shorten the data set names. If you cannot shorten the names, IMS Online Reorganization Facility cannot process the DBD.

HRF01106I Allocating the shadow files.

Explanation

The shadow files are being defined and allocated. This message precedes the IDCAMS list from the allocation.

System action

None.

User response

None. This message is informational.

HRF01107E Online subsystem *imsid* not available.

Explanation

The RECON subsystem records show this subsystem as an online IMS subsystem. However, IMS Online Reorganization Facility is not active in this subsystem.

System action

Processing terminates.

User response

Add the IMS Online Reorganization Facility load library to the online system STEPLIB. Verify that IMS Online Reorganization Facility is properly set up.

HRF01108I **AOI interface connected to *imsid*.**

Explanation

The IMS Online Reorganization Facility job established operator command capability with the IMS subsystem that is named in the message.

System action

None.

User response

None. This message is informational.

HRF01109I **No online subsystem active.**

Explanation

No online IMS subsystem was active at this time.

System action

The process continues.

User response

None. This message is informational.

HRF01110E **HIDAM root segment has compressed key.**

Explanation

The root segment of a HIDAM or PHIDAM database is compressed. The compression is not only DATA, but also KEY. IMS Online Reorganization Facility does not allow compressed root keys for HIDAM databases.

System action

Processing terminates.

User response

The database must not have key compression. Use the offline utilities to remove the key compression, and perform a DBD change between unload and reload.

HRF01111E **Software for *product* not available.**

Explanation

The named product is required for IMS Online Reorganization Facility to do the reorganization.

System action

Processing terminates.

User response

Add the program library for the specified product to the STEPLIB. Make sure that the library is APF authorized.

HRF01112I **Reloading DD *ddname* DSN *dsname***

Explanation

The target data sets that are identified in this message will be used to load the database.

System action

None.

User response

None. This message is informational.

HRF01113E **OPEN failed for DDname *ddname*.**

Explanation

The OPEN operation failed for the *ddname*.

System action

Processing terminates.

User response

Collect the output and contact IBM Software Support.

HRF01114I **Secondary index build started or ended.**

Explanation

A secondary index build process started or ended.

System action

None.

User response

None. This message is informational.

HRF01115I DDname *ddname* found in JCL. It is deallocated.

Explanation

The specified DD statement is allocated internally.

System action

None.

User response

Remove the DD statement from the JCL and resubmit the job.

HRF01116I Shared index written with index DBD *dbdname*.

Explanation

The shared secondary index will be assigned to the first DBD.

System action

None.

User response

None. This message is informational.

HRF01117I Pre Reorganization Utility started or ended

Explanation

The prereorganization utility started or ended.

System action

None.

User response

None. This message is informational.

HRF01118I Prefix Resolution started or ended.

Explanation

The prefix resolution started or ended.

System action

None.

User response

None. This message is informational.

HRF01119I Prefix Update started or ended.

Explanation

The prefix update started or ended.

System action

None.

User response

None. This message is informational.

HRF01120E Primary DBD *dbdname* is NONRECOV.

Explanation

The primary DBD is defined as NONRECOV in DBRC. This is not permitted.

System action

Processing terminates.

User response

Change the DBD to RECOV in DBRC, and resubmit the job.

HRF01121E DBD *dbdname* is not supported for this function.

Explanation

The specified DBD is one of the following unsupported DBD types: HSAM, DEDB, or Index DBD.

System action

Processing terminates.

User response

The specified DBD cannot be reorganized with this tool

HRF01122I IC *ddname* specified but ignored. DBD is NONRECOV.

Explanation

The specified database DDNAME was specified to be image copied. However, the DBD is defined as NONRECOV. Therefore, an image copy is unnecessary.

System action

None.

User response

If you need an image copy, run the offline utility.

HRF01123E **IC *ddname* is not a valid DDname.**

Explanation

The ICDDN keyword specifies a database DD statement. Neither the Primary DBD nor its index DBDs contain this DD.

System action

Processing terminates.

User response

Correct the ICDDN keyword and resubmit the job.

HRF01124E **IC *ddname* DDname *icddn* specified, but not in JCL.**

Explanation

The ICDDN keyword specifies an image copy DD *icddn* for the database DD *ddname*. The specified *icddn* was not found in the JCL.

System action

Processing terminates.

User response

Provide a DD statement for the image copy, and resubmit the job.

HRF01125E **Duplicate DDname *ddname* in ICDDN keyword.**

Explanation

The ICDDN keyword is used to describe the image copies. The specified DDNAME is used more than once.

System action

Processing terminates.

User response

Provide a unique DD statement for each image copy, and resubmit the job.

HRF01126E **Inconsistent shared index *dbdname* DBD. Reason *rsn*.**

Explanation

Shared secondary indexes must point to the same primary DBD and all shared secondary indexes must have the same DBDS in DBRC.

System action

Processing terminates.

User response

IMS Online Reorganization Facility does not support shared secondary indexes that point to different primary DBDs.

HRF01127E **No IC1 found for *ddname*.**

Explanation

The ICDDN keyword for the database DD *ddname* does not have a primary image copy specified.

System action

Processing terminates.

User response

A secondary IC must be specified with the primary IC. Change the ICDDN keyword and resubmit the job.

HRF01128E **IC *ddname* DSN for *icddn* too long.**

Explanation

Dynamic allocation for image copy data sets is being used. The generated *ddname* is too long.

System action

Processing terminates.

User response

Create a shorter IC data set name, and resubmit the job.

HRF01129E **IC DDname *ddname* is for database.**

Explanation

The ICDDN keyword specified a database as the target for image copy.

System action

Processing terminates.

User response

Specify a unique file for the image copy, and resubmit the job.

HRF01130E **DSname for *ddname* is the same as for *ddname***

Explanation

The image copy data sets that the ICDDN keyword specifies have different DD statements but have the same data set name.

System action

Processing terminates.

User response

Specify different data sets for the image copies, and resubmit the job.

HRF01131E **dsname for *icddn* is the same as for database *ddname*.**

Explanation

The name of a database data set was specified for an image copy.

System action

Processing terminates.

User response

Provide a different data set name for the image copy, and resubmit the job.

HRF01132E **GDG *gdgbase* not defined.**

Explanation

GDG was specified as a data set name for an image copy. However, the GDG base does not exist.

System action

Processing terminates.

User response

Create the GDG base, and resubmit the job.

HRF01133E **Index DBD *dbdname* for primary DBD *dbdname* in error.**

Explanation

The index DBD for the primary DBD is in error.

System action

Processing terminates.

User response

Collect the output, the specified DBD source, and contact IBM Software Support.

HRF01134E **NEWDBD DD not in JCL.**

Explanation

The NEWDBD keyword was specified in the control statements. The specified DD statement has not been provided.

System action

Processing terminates.

User response

Provide the DD statement that specifies the library that contains the changed DBDs, and resubmit the job.

HRF01135E **No DBD specified.**

Explanation

No DBD keyword was specified in the control statements.

System action

Processing terminates.

User response

Provide a DBD and resubmit the job.

HRF01136E **Multiple REORG commands specified**

Explanation

More than one REORG command was found in HRFSYSIN.

System action

Processing terminates.

User response

Run each REORG as separate job step.

HRF01137E DBD *dbdname* compare error.
Reason is: *rsn*

Explanation

The NEWDBD keyword is specified in the control statement and the old and new DBDs were compared. The new DBD contains changes that are not supported. The reason text provides an explanation.

System action

Processing terminates.

User response

The changes that can be made to the DBD are restricted when IMS Online Reorganization Facility is used. Use offline utilities for the reorganization.

HRF01138E Primary DBD *dbdname* is not in NEWDBD.

Explanation

The NEWDBD keyword is specified in the control statements. However, the library does not contain the primary DBD.

System action

Processing terminates.

User response

To make a DBD change, move the changed DBD to the file that the NEWDBD keyword specifies.

HRF01139E Post reorganization processing failed in *phase*:

Explanation

A process failed in the Takeover phase.

System action

Processing terminates.

User response

Use the RESTART parameter to restart the Takeover phase. The database is still in prohibit authorization status. Do not change the prohibit authorization status. The Takeover phase must complete. The Takeover phase will restart where the last operation stopped.

HRF01140I Attempting to restart in phase *phase*

Explanation

This informational message is issued when the RESTART function continues the Takeover phase.

System action

None.

User response

None. This message is informational.

HRF01141I Last phase completed was *phase*.

Explanation

This message is issued during restart. The last phase completed is indicated by *phase*.

System action

None.

User response

None. This message is informational.

HRF01142E Neither data set *dsname* or *dsname* was found.

Explanation

During the Takeover phase, the data sets are renamed. In this case, none of the data sets were found.

System action

The process terminates.

User response

This error typically occurs during a RESTART process. Because a database data set was deleted, you must recover the database.

HRF01143E Index *dbdname* not in NEWDBD library

Explanation

A secondary index was changed, but the new DBD was not provided.

System action

The process terminates.

User response

Correct the changed DBD, and resubmit the job.

HRF01144E **New primary DBD has external logical relationships.**

Explanation

The NEWDBD keyword specifies a new DBD that adds external logical relationships, which are not supported.

System action

Processing terminates.

User response

Use offline utilities for this process.

HRF01145I **NEWDBD library now in effect.**

Explanation

This message is issued after unload has completed.

System action

None.

User response

None. This message is informational.

HRF01146I **Prior job *jobname* at time for DBD *dbdname* in phase *phase***

Explanation

This message indicates a pending restart. A previous job ran at the specified time for the specified DBD and stopped at the specified phase.

System action

None.

User response

None. This message is informational.

HRF01147I **(*param*) specified for this execution.**

Explanation

The RESTART function is used.

System action

None.

User response

None. This message is informational.

HRF01148I **DBD *dbdname* has non-unique segments**

Explanation

The DBD has segment types that do not have a sequence field or that have a non-unique sequence field.

System action

None.

User response

None. This message is informational.

HRF01149E **IMSACB DD required with NEWDBD and ONLINECHANGE(Y).**

Explanation

The new DBD will be propagated to the online system, which requires the staging library ACBLIB.

System action

Processing terminates.

User response

Add the ACBLIB DD to the JCL and resubmit the job.

HRF01150E **Invalid *attrib* for *ddname* DD**

Explanation

The attributes for a KSDS are invalid.

System action

The process terminates.

User response

Correct the attributes for the shadow data sets and resubmit the job.

HRF01151I **Temporary RECON created or deleted.**

Explanation

A HALDB partition was specified. A temporary RECON was created to define the partitions and the shadow data set names. This RECON is used for the reorganization process.

System action

None.

User response

None. This message is informational.

HRF01152E **NEWDBD specified with HALDB database.**

Explanation

IMS Online Reorganization Facility does not support DBD changes for HALDB databases.

System action

Processing terminates.

User response

Use an offline utility to reorganize all partitions. If you want to change only the randomizing parameters for a HALDB partition, you do not need to perform a DBD change.

HRF01153E ***ddname* DD cannot be a temporary data set.**

Explanation

A temporary data set was specified for the indicated DD.

System action

Processing terminates.

User response

Specify a permanent data set and resubmit the job.

HRF01154E **Unable to load module *modname*.**

Explanation

The specified module *modname* was not found.

System action

Processing terminates.

User response

Make the user exit available in the JCL and resubmit the job.

HRF01155I **Rebuilding primary index.**

Explanation

A HIDAM or PHIDAM database is being used. The primary index is created in the shadow data set.

System action

None.

User response

None. This message is informational.

HRF01156E **Error creating interim LOG**

Explanation

IMS Online Reorganization Facility was unable to allocate a data set for use as a batch log during the apply process. The allocation parameters of this interim data set are based on the IEFORDER DD statement in the JCL.

System action

The IMS Online Reorganization Facility job terminates.

User response

Review the preceding messages to determine why the allocation failed. Resolve the allocation problems and resubmit job.

HRF01157E **Shadow data set for *ddname* too small**

Explanation

The space allocation for the specified predefined shadow data set was insufficient.

System action

The process terminates.

User response

Increase the size of the specified data set and resubmit the job.

HRF01158E Partition keyword required for HALDB

Explanation

A HALDB database was specified; however, no partition was specified. You must specify the partition to reorganize.

System action

The process terminates.

User response

Specify the PARTITION keyword in the HRFSYSIN DD statement to specify the partition, and resubmit the job.

HRF01159E Invalid component DSN *dsname*

Explanation

The specified *dsname* is a component name of a VSAM cluster. The *dsname* is too long to use to create shadow data sets.

System action

The process terminates.

User response

Shorten the data set name and resubmit the job.

HRF01160E Primary DSN *dsname* and shadow have different attributes

Explanation

Preallocated shadow data sets were used. The data set attributes of the shadow data sets must match the original data sets. The specified data set attributes and the attributes of the shadow data sets do not match.

System action

The process terminates.

User response

Ensure that the attributes are correct. If this data set is an index data set, you might have specified the wrong *keylen*, *key offset*, or *record length*. Specify the correct attributes, and resubmit the job.

HRF01161E HALDB partition *name* is on M-V data sets

Explanation

The partition that is identified by *name* is currently on the M-V data sets. IMS Online Reorganization Facility was unable to create a copy of the data sets on the shadow file.

System action

IMS Online Reorganization Facility processing terminates.

User response

Use an offline reorganization utility, or make the A-J data sets active and then resubmit the job.

HRF01162E Invalid subparameter for PTRCHECK keyword

Explanation

The PTRCHECK keyword must have a Y or N in the first position and up to four additional parameters. The specified parameters are invalid.

System action

The process terminates.

User response

Provide valid parameters for the PTRCHECK keyword and resubmit the job.

HRF01163E DD *ddname* block size is not size defined in RECON

Explanation

The actual block size of the indicated OSAM data set is not the same as the block size that is defined in the RECON data sets.

System action

Processing terminates.

User response

Correct the block size in the RECON data sets and rerun the job.

HRF01164E Dynamic allocation failed, DD *ddname*

Explanation

IMS Online Reorganization Facility did not dynamically allocate a required DD. Messages that were issued

prior to this one explain the reason for the allocation failure.

System action

Processing terminates.

User response

Correct the allocation failure, and resubmit the IMS Online Reorganization Facility job.

HRF01165E Invalid PARTITION specified

Explanation

A name was entered in the PARTITION keyword, but the partition name is not part of the master DBD.

System action

Processing terminates.

User response

Correct the partition name and resubmit the IMS Online Reorganization Facility job.

HRF01166I DBD *dbdname* has internal logical relationship

Explanation

The *dbdname* that you specified contains at least one internal logical relationship.

System action

Processing continues. IMS Online Reorganization Facility performs any prefix resolution and update processing that is required for the process that is being performed.

User response

None. This message is informational.

HRF01169E More than 255 RAPS

Explanation

More than 255 reset attached processes (RAPS) were specified for a partition, which exceeds the limit in IMS.

System action

The process terminates.

User response

Specify fewer than 255 RAPS.

HRF01170E Byte limit too large

Explanation

The byte limit exceeded the maximum size, which is 16 MB.

System action

The process terminates.

User response

Specify a smaller byte limit.

HRF01171E DBD *dbdname* has logical relationship

Explanation

The current function converts an entire DBDLIB. However, the function does not allow for logically related DBDs.

System action

The DBD is excluded from this process.

User response

Use a different method to process this DBD.

HRF01172I DBD *dbdname* was excluded, reason is: *reason*

Explanation

The current function converts an entire DBDLIB. The specified DBD was excluded from this function because of one or more of the following reasons:

- DBD construct error
- DBD is not supported
- DBD is HALDB
- DBD has logical relation
- Primary index is missing
- Secondary index is missing
- Primary database is missing
- MDA library member is missing
- MDA DDname not in member
- Data set not cataloged
- Index DBD in error

System action

The DBD is excluded from the conversion.

User response

Make the necessary changes, and resubmit the job. Or run the conversion as is, and work on the failed DBDs at a later time.

HRF01173I **DBD *dbdname* is an index**

Explanation

The specified DBD is a PSINDEX or a secondary index. The selected function does not allow for an index DBD.

System action

The process terminates.

User response

Specify a primary DBD.

HRF01174E **Orphaned split segment found**

Explanation

When scanning the primary database in order to build a shadow copy of the primary index, IMS Online Reorganization Facility detected that a root had been split and the pointer to the data portion was invalid.

System action

Processing terminates.

User response

The original database data set might have one or more pointer errors. Run IMS High Performance Pointer Checker or an equivalent tool against the original database to determine the pointer errors. Resolve the pointer errors and resubmit the IMS Online Reorganization Facility job.

HRF01175E **Either all partitions or
TEMPRECOV(Y) required for
NONRECOV DBD *dbdname***

Explanation

A nonrecoverable HALDB was specified in the DBD keyword. The command that was specified requires that IMS Online Reorganization Facility change the database to be recoverable during the IMS Online Reorganization Facility processing. Either all partitions or specifying TEMPRECOV(Y) for the

selected partitions are required for the IMS Online Reorganization Facility processing.

System action

Processing terminates.

User response

Remove the PARTITION keyword from the command so that all partitions are processed, specify the TEMPRECOV(Y) keyword, or manually change the DBD to recoverable. Then resubmit the IMS Online Reorganization Facility job.

HRF01176E **Data set found empty**

Explanation

This message is preceded by message HRF01085, which identifies the primary database DDname and DSname. One record that contains the partition ID and the reorg number should be found but the data set is empty.

System action

The process terminates.

User response

Verify the load process of the partition. Run the partition initialization, and reload the partition.

HRF01177E **Shadow data set *dsname* defined
as NOREUSE but data set is not
empty**

Explanation

The specified data set must be empty.

System action

The process terminates.

User response

Either specify the data set as REUSE, or DELETE and DEFINE it prior to this process.

HRF01178E **Dynamic allocation limit reached.
Specify larger DYNAMNBR.**

Explanation

The maximum dynamic allocation limit has been reached.

System action

The process terminates.

User response

Specify the DYNAMNBR parameter on the EXEC statement. A value of DYNAMNBR=999 typically resolves this problem.

HRF01179E **VIO has been allocated to *ddname***

Explanation

The current process does not support VIO data sets.

System action

The process terminates.

User response

Specify a unit name that is not VIO. Use the IHCXUNIT member in IHCXSAMP file to locate other non-VIO unit names.

HRF01180E **Sort work *ddname* has not enough disk space**

Explanation

The indicated *ddname* cannot allocate enough sort work space.

System action

Processing terminates.

User response

Override the DD with sufficient disk space so that the system can allocate enough sort work space for the DD.

HRF01181E **Logical DBD *dbdname* is invalid**

Explanation

The specified logical DBD does not reference the database the DBD keyword specifies.

System action

Processing terminates.

User response

Ensure that the logical DBD is defined to the database that you are reorganizing.

HRF01182E **All partitions required for NEWDBD with HALDB**

Explanation

The NEWDBD keyword is specified but not all of the HALDB partitions are specified. To change the DBD of a HALDB, all partitions must be processed in the job.

System action

Processing terminates.

User response

Remove the PARTITION keyword from the command so that all partitions are processed, then resubmit the IMS Online Reorganization Facility job.

HRF01199E **DFDSS COPY command failed, RC=*rc***

Explanation

A DFSMSdss COPY command failed.

System action

The IMS Online Reorganization Facility job ends abnormally.

User response

The error message from DFSMSdss is written to SYSPRINT. Correct the error and rerun the job.

HRF01200E **FROMDBD *ddname1* TODBD *dbdname2* compare failed: *reason***

Explanation

The merge process detected one or more errors. Potential reasons include:

- DBD names are identical
- Segment structure is different
- Segment definition is different
- DBD type is different
- DBD has secondary index
- DBD has logical relation
- DBD has different partition selection exits
- IHCPSEL0 is defined different

System action

The process terminates.

User response

None. Merging these two HALDBs is not possible.

HRF01201E DBD *ddname* is PSINDEX

Explanation

The specified DBD is an index DBD.

System action

The process terminates.

User response

None. A PSINDEX DBD cannot be specified for merging.

HRF01202E PGM *name* not found

Explanation

The specified program was not found.

System action

The process terminates.

User response

Correct the program name, and resubmit the job.

HRF01203E PSB *name* not found

Explanation

The specified PSB was not found.

System action

The process terminates.

User response

Correct the PSB name, and resubmit the job.

HRF01204E PSB not found or valid

Explanation

The specified PCB is not in the PSB or does not have PROCOPT=L.

System action

The process terminates.

User response

Correct the PSB or PCB parameter, and resubmit the job.

HRF01301W Dynamic allocation failed, SVC 99 reason code 'xxxx'

Explanation

IMS Online Reorganization Facility was unable to dynamically allocate a data set. You can find information about the SVC 99 reason codes in the z/OS *MVS Authorized Assembler Services Guide*.

System action

If the data set is required, processing terminates. Otherwise, processing continues.

User response

Correct the allocation failure, and resubmit the IMS Online Reorganization Facility job.

HRF01311I Data set information for dynalloc - UNIT NAME: xxxxxxxx CYL: yyyy

Explanation

xxxxxxx is the unit name and yyyy is the number of cylinders specified in the SVC 99 parameter list.

System action

None.

User response

When either of the following messages is issued immediately before this message, specify a value larger than yyyy to the UNLSPAC keyword and rerun the job.

- HRF01301W with the reason code 0238
- HRF01634E

If not, no action is required.

HRF01500I Online Reorg Facility initialization for *imsid* completed

Explanation

During IMS control region startup, IMS Online Reorganization Facility was initialized successfully in the IMS subsystem, *imsid*.

System action

IMS startup continues.

User response

None. This message is informational.

HRF01500W **Online Reorg Facility [initialization for *imsid*] logger exit initialization] failed, RC=xxxx**

Explanation

During IMS control region startup, IMS Online Reorganization Facility was not initialized in the IMS subsystem, *imsid*.

System action

IMS startup continues but IMS Online Reorganization Facility will be active for the IMS subsystem, *imsid*, only when it is restarted.

User response

Review the previous error messages and try to correct the problem. If you are unable to correct the problem, contact IBM Software Support.

The following table lists the HRF01500W return codes and their meanings.

Return code	Meaning
2	Unable to locate SCD. Contact IBM Software Support.
3	Unable to locate IMS Online Reorganization Facility anchor. Logger exit initialization failed. Verify that the logger exit routine that is provided by IMS Online Reorganization Facility (HRFFLGX0) is configured correctly.
4	IEANTRT call failed. The error was returned from IEANTRT.
5	BLDL failed for the required module. Unable to load IMS Online Reorganization Facility module into ECSA. Verify that the complete IMS Online Reorganization Facility library is in the STEPLIB.
6	LOAD failed for required module. Verify that the complete IMS Online Reorganization Facility library is in the STEPLIB.
7	Unable to obtain ECSA.
8	Unsupported IMS release.
9	Logger exit initialization failed.
17	Unable to load the HRFYOFxx module or the HRFYOFxx module is not reentrant. Ensure that the IMS Online Reorganization Facility library is in the STEPLIB.

HRF01501W **DEBUG setup failed: *reason*, RC=xxxx**

Explanation

IMS Online Reorganization Facility was unable to start additional debugging options. The *reason* specified explains why setup failed.

System action

Processing continues with DEBUG off.

User response

Report the reason and return code to IBM Software Support.

HRF01502I **Online Reorg Facility DEBUG status**

Explanation

The DEBUG services started or stopped.

System action

None.

User response

None. This message is informational.

HRF01503I ***action* XCF group *groupname* as member *membername***

Explanation

The job joined or left an XCF group.

System action

None.

User response

Verify that *groupname* is the same group name as other address spaces in order to be able to communicate with them.

HRF01504E **Target IMS system *imsid* is not active on this host**

Explanation

An IMS Online Reorganization Facility maintenance utility ran on an MVS system, and the target IMS subsystem, *imsid*, is not active on that MVS system.

System action

The IMS Online Reorganization Facility job terminates.

User response

Resubmit the job on the same MVS system where the target IMS subsystem is active.

**HRF01505E Online Reorg Facility is not active
 in target IMS system**

Explanation

An IMS Online Reorganization Facility maintenance utility ran but IMS Online Reorganization Facility is not active in the target IMS subsystem.

System action

The IMS Online Reorganization Facility job terminates.

User response

Verify that the target IMS subsystem is correct. IMS Online Reorganization Facility must initially be activated in an IMS subsystem with a restart of the IMS control region. Verify that this was done and that the HRF01500I message was issued to indicate that the IMS Online Reorganization Facility was initialized successfully.

**HRF01506W DEBUG status for IMS *imsid*
 already state**

Explanation

An IMS Online Reorganization Facility utility was run to set the DEBUG state. The DEBUG state for the IMS subsystem was already in the requested state.

System action

None. DEBUG status is left in previous state.

User response

Verify that the DEBUG status is in the appropriate state.

**HRF01507I DEBUG action request for IMS
 imsid completed**

Explanation

An IMS Online Reorganization Facility utility was run and has successfully changed the DEBUG state for an IMS subsystem.

System action

The requested DEBUG state is now in effect for the target IMS subsystem.

User response

None. This message is informational.

**HRF01508W Unable to install new
 maintenance: *reason***

Explanation

The IMS Online Reorganization Facility maintenance utility was unable to install new maintenance into an IMS online subsystem.

System action

The previous maintenance level is still in effect for the IMS subsystem.

User response

Correct the *reason* that new maintenance was unable to be installed and resubmit the job.

**HRF01509W IMS using ORF library
 datasetname, new maintenance
 being loaded from *datasetname***

Explanation

IMS Online Reorganization Facility maintenance utility is being executed with a different library than that of which the IMS control region was initially started with.

System action

New maintenance is installed into the IMS control region from the different library.

User response

The next time the IMS subsystem is restarted it will activate IMS Online Reorganization Facility from the library in the control region STEPLIB. If you want the installation of the new maintenance level to be permanently installed into the IMS subsystem, the new maintenance level must either be copied into the STEPLIB data set for the IMS control region, or the library with the new maintenance level must be added to the STEPLIB of the IMS control region.

**HRF01510I Online Reorg Facility *Vv.r*
 maintenance successfully
 installed in *imsid***

Explanation

A new maintenance level was successfully installed in the *imsid* online IMS subsystem.

System action

The new maintenance level is in effect in the target IMS subsystem.

User response

None. This message is informational.

HRF01511E **Target member *membername*
action reason**

Explanation

An attempt to connect to the IMS Online Reorganization Facility or IMS Tools Online System Interface component in an IMS control region address space failed for the specified reason.

System action

The IMS Online Reorganization Facility job terminates.

User response

If the IMS subsystem is down, it must either be restarted or the SUBSYS record must be removed from DBRC. If the IMS subsystem is active, verify that either the IMS Online Reorganization Facility or IMS Tools Online System Interface component was successfully initialized in that subsystem and that the component joined the same XCF group.

HRF01512I **Connected with target member
*membername***

Explanation

The job successfully connected to the corresponding member.

System action

Processing continues.

User response

None. This message is informational.

HRF01513E **ORF subtask failed RC=xxxx**

Explanation

The IMS Online Reorganization Facility subtask in the IMS control region terminated unexpectedly.

System action

IMS Online Reorganization Facility processing in the IMS control region is no longer available.

User response

Report the problem to IBM Software Support. The IMS subsystem must be restarted in order to reactivate IMS Online Reorganization Facility in that IMS subsystem.

HRF01514I ***capturetype* capture for
DBD(*dbdname*) action**

Explanation

This informational message indicates that capturing log or change records for the DBD has either been started or has just ended.

System action

If capture has been activated, the captured records will begin being sent to the remote IMS Online Reorganization Facility utility. If capture has been stopped, no more change records for the DBD will be sent to the IMS Online Reorganization Facility utility.

User response

None. This message is informational.

HRF01515W ***message_type* from member
*membername***

Explanation

An unexpected XCF message was received from the corresponding member. *message_type* shows one of the following values:

NEWMBR

The member that newly joined the XCF group. This type of message is typically received when an IMS subsystem is started during the reorganization.

LOSTCONN

The connection to the member was lost. This type of message is typically received when an IMS subsystem terminates during the reorganization or the reorganization job abnormally terminates.

System action

If the IMS Online Reorganization Facility job receives the message, the job terminates. If the message is received in the IMS control region, capturing changes for the remote IMS Online Reorganization Facility utility ends.

User response

None.

HRF01517E **Error encountered during capturetype capture for DBD dbdname: FUNC=function RC=xxxx RSN=xxxx**

Explanation

The IMS Online Reorganization Facility was unable to capture a change record for a DBD.

System action

Record capture is terminated for the DBD. The IMS Online Reorganization Facility job is notified of the records that were being captured. The IMS Online Reorganization Facility job ends abnormally.

User response

If the parameters in the message are FUNC=IXCMMSGO, RC=000C, RSN=0004, an XCF send error, which is caused by an XCF message buffer shortage, occurred. In this case, consider increasing the MAXMSG value on the CLASSDEF or PATHOUT definition. You can find information about XCF message buffers in *z/OS MVS Setting Up a Sysplex*. Alternatively, you can use the XCFRETRY parameter in HRFSETOP to specify the retry count for such XCF send errors.

If the parameters in the message indicate other errors, report the problem to IBM Software Support.

HRF01518E **command call failed: RC=xxxx RSN=xxxx**

Explanation

IMS Online Reorganization Facility encountered an error when issuing the IMS command, *command*.

System action

IMS Online Reorganization Facility ends abnormally.

User response

Review the return and reason codes that are described in the *IMS Messages and Codes, Volume 4: IMS Component Codes*.

HRF01519I **Number of records captured was xxxx**

Explanation

Number of records captured was xxxx.

System action

None.

User response

None. This message is informational.

HRF01520E **calltype call ended with "statuscode status code**

Explanation

When applying captured changes to the reorganized shadow data sets, IMS Online Reorganization Facility encountered an unexpected status code.

System action

The IMS Online Reorganization Facility job ends abnormally.

User response

Report the problem to IBM Software Support.

HRF01521W **Error from modulename: FUNC=function RC=xxxx RSN=xxxx**

Explanation

An error was encountered while capturing records in the IMS control region.

System action

The IMS Online Reorganization Facility job ends abnormally.

User response

Report the problem to IBM Software Support.

HRF01522E **DBRC request request for DBD dbdname DDN ddname failed, RC=xxxx**

Explanation

A DBRC request failed.

System action

The IMS Online Reorganization Facility job ends abnormally.

User response

To determine whether you can correct the error, locate the return code and the reason code in *IMS*

Messages and Codes, Volume 4: IMS Component Codes. Correct the problem, and then restart the IMS Online Reorganization Facility job. The failed DBRC request will be reattempted. If you cannot correct the error, report the problem to IBM Software Support.

HRF01523E **DBRC request request for LOGDSN datasetname failed, RC=xxxx**

Explanation

A DBRC request for a log data set failed.

System action

The IMS Online Reorganization Facility job ends abnormally.

User response

Review the return and reason code listed in the *IMS Messages and Codes, Volume 4: IMS Component Codes* to see if it can be corrected. Correct the problem, and then restart the IMS Online Reorganization Facility job. The failed DBRC request will be reattempted. If the error cannot be corrected, report the problem to IBM Software Support.

HRF01524I **The following jobs currently have DBD dbdname allocated:**

Explanation

This message is issued in conjunction with messages HRF01525I and HRF01526I.

System action

None.

User response

None. This message is informational.

HRF01525I **Jobname jobname IMSID imsid Reg# regionnumber**

Explanation

This message is issued in conjunction with messages HRF01524I and HRF01526I.

System action

None.

User response

None. This message is informational.

HRF01526I **The jobs must be stopped before jobname can continue**

Explanation

This message is issued in conjunction with messages HRF01524I and HRF01525I when an IMS Online Reorganization Facility job needs to run the **/STOP** or **/DBRECOVERY** command on a DBD and it is unable to do so until the jobs that are listed relinquish control of the DBD. Message HRF01526A follows this message.

System action

None.

User response

None. This message is informational.

HRF01526A **(jobname): Waiting for BMPs (imsid): Reply 'RETRY' or 'CANCEL'**

Explanation

This WTOR message is issued after messages HRF01524I, HRF01525I, and HRF01526I. This message indicates that IMS Online Reorganization Facility is trying to issue the **/STOP** or **/DBRECOVERY** command on a DBD but the attempt to do so is failing because active BMP jobs exist.

System action

The IMS Online Reorganization Facility job waits for the operator reply. During the wait, the IMS Online Reorganization Facility job makes retry attempts in the background and deletes the WTOR message after a successful retry attempt.

User response

Take one of the following actions:

- Type **RETRY** to make IMS Online Reorganization Facility immediately retry the attempt.
- Type **CANCEL** to cancel the reorganization job.
- Type nothing and wait for the listed BMP jobs to end or to be paused, or manually end the BMP jobs so that the control of the DBD is released.

HRF01527W **reply is an invalid reply**

Explanation

An invalid response to the previous WTOR was entered.

System action

The previous WTOR is reissued.

User response

Enter a valid reply.

HRF01528I **The reply was *reply***

Explanation

The operator had this response for the previous outstanding WTOR.

System action

Processing continues according to reply.

User response

None. This message is informational.

HRF01529W **Takeover processing delayed due to TAKEOVER(DELAY)**

Explanation

TAKEOVER(DELAY) was specified in the control statements. The IMS Online Reorganization Facility job ends without doing takeover processing.

System action

Restart information is saved, and the IMS Online Reorganization Facility job ends with RC=4. The original database is left in a DB recovery needed state with the prohibit authorization flag set in DBRC.

User response

Determine the reason for delaying the takeover processing. When takeover processing is required, resubmit the IMS Online Reorganization Facility job with TAKEOVER(YES) specified.

HRF01530I ***datasetname* allocated to DD *ddname***

Explanation

During restart, IMS Online Reorganization Facility allocates certain DD statements to the data sets that were in effect at the time the previous job terminated. If the ddname is in the JCL that is used to restart the job, the data set will be deallocated first.

System action

Processing continues.

User response

None. This message is informational.

HRF01531I ***TOIrequest* request for DBD *dbdname* action**

Explanation

IMS Tools Online System Interface requests have been made and have completed to an IMS control region.

System action

Processing continues.

User response

None. This message is informational.

HRF01532I **Restart information save**

Explanation

This informational message is issued before processing starts in the Takeover phase. Restart information was successfully saved in the IMS Online Reorganization Facility restart data set.

System action

Takeover processing begins unless TAKEOVER(DELAY) was specified.

User response

None. This message is informational.

HRF01533W ***TOIrequest* request for DBD *dbdname* action RC=*xxxx* RSN=*xxxx***

Explanation

An IMS Tools Online System Interface request to the target IMS subsystem failed.

System action

The IMS Online Reorganization Facility job ends abnormally.

User response

Locate the return code and reason code in the *IMS Tools Base IMS Tools Common Services User's Guide and Reference*. The IMS control region might also contain messages that describe why the request failed. The most likely cause is the status of a DBD in the IMS control region. If you correct the problem,

resubmit the IMS Online Reorganization Facility job. If you cannot correct the problem, contact IBM Software Support.

HRF01534E **Unknown segment *segmentname* in change record**

Explanation

When applying captured change records to the shadow data sets, IMS Online Reorganization Facility encountered a change record that involved a segment that is not in the DBD for which the IMS Online Reorganization Facility job is running.

System action

The IMS Online Reorganization Facility job ends abnormally.

User response

Verify that the DMB used in the online IMS subsystems corresponds to the DBD for which the IMS Online Reorganization Facility job is running.

HRF01535E **DBRC command request for Partition *partitionname* failed, RC=xxxx**

Explanation

A DBRC request failed.

System action

The IMS Online Reorganization Facility job ends abnormally.

User response

Review the return and reason code in the *IMS Messages and Codes, Volume 4: IMS Component Codes*. Correct the problem, and then restart the IMS Online Reorganization Facility job. The failed DBRC request will be reattempted. If you cannot correct the error, report the problem to IBM Software Support.

HRF01536I **Online Reorg Facility Vv.r maintdate mainttime**

Explanation

This informational message indicates the version, release, maintenance date, and maintenance time of IMS Online Reorganization Facility for the job or IMS control region.

System action

Processing continues.

User response

None. This message is informational.

HRF01537E **Change capture already active for DBD *dbdname* on *insid***

Explanation

An IMS Online Reorganization Facility job for a DBD was started and an IMS Online Reorganization Facility job for the same DBD is already active in the IMS subsystem. Only one IMS Online Reorganization Facility job can be executing for a DBD or HALDB partition.

System action

The duplicate IMS Online Reorganization Facility job ends abnormally.

User response

Wait for the current IMS Online Reorganization Facility job for the DBD to end. Then resubmit the subsequent IMS Online Reorganization Facility job if necessary.

HRF01538E **AOI command request to *insid* failed, RC=return code RSN=reason**

Explanation

An IMS Online Reorganization Facility request that was issued to the IMS Tools Online System Interface failed.

System action

The IMS Online Reorganization Facility job terminates.

User response

Review the return codes for IMS Tools Online System Interface. If the return and reason codes indicate a problem that you can fix in the IMS subsystem, correct the problem and resubmit the job. If you cannot fix the problem, contact IBM Software Support.

HRF01539I **Caught up with applying changes, waiting for TAKEOVER Window**

Explanation

IMS Online Reorganization Facility has reached the point in the job where it can begin the Takeover phase.

A TAKEOVER window was specified and the begin takeover time has not been reached.

System action

IMS Online Reorganization Facility begins idling until the begin takeover time that was specified is reached. During this idling time, any changes being applied to the original database are captured and applied to the shadow database.

User response

If no action is taken, IMS Online Reorganization Facility begins the Takeover phase at the specified time. To perform the takeover sooner, enter a TAKEOVER command with an MVS modify command; the Takeover phase begins.

HRF01540I *command command was entered*

Explanation

An MVS **MODIFY** or **STOP** command was entered by an operator for the IMS Online Reorganization Facility job.

System action

If the command is valid, IMS Online Reorganization Facility processes the command.

User response

None. This message is informational.

HRF01541I *Current phase is: phase started at hh:mm:ss*

Explanation

This message indicates the current status of the IMS Online Reorganization Facility job. The message is the result of the MONITOR keyword being specified or a MONITOR request on the **MODIFY** command by an operator.

System action

Processing continues.

User response

None. This message is informational.

HRF01542I *nnnnn type records captured, nnnnn type records applied – nnn%*

Explanation

This message is the second part of monitor information. The message indicates the number of log records or change records that were captured by the online systems and the number and percentage of those records that were applied to the shadow data sets being reorganized. The message is the result of the MONITOR keyword being specified or a MONITOR request on a **MODIFY** command by an operator.

System action

Processing continues.

User response

None. This message is informational.

HRF01543W **Takeover window has expired**

Explanation

The end time that was specified by the TAKEOVER.WINDOW parameter has been reached and IMS Online Reorganization Facility is not yet ready to perform takeover processing for the job.

System action

IMS Online Reorganization Facility will take the action specified by the endaction operand of the TAKEOVER.WINDOW parameter.

User response

If WTOR was specified as the action to take when the takeover window expires, determine the action that you want to take and reply to message HRF01544I accordingly.

HRF01544I **Specify action to take: N - keep idling until next window, T - do TAKEOVER when ready, C - continue until TAKEOVER then ask again, A - abend job**

Explanation

The specified TAKEOVER window expired, and WTOR was specified as the action to take.

System action

The IMS Online Reorganization Facility job continues processing and waits for an operator response.

User response

Determine the action to take and enter a response through the operator console. The options are:

- N**
The IMS Online Reorganization Facility job continues processing and tries to perform takeover during the same window on the following day.
- T**
Finish reorganizing the shadow data sets, and perform takeover when the job reaches that point.
- C**
Finish reorganizing the shadow data sets, and then ask the operator what to do when the takeover point is reached.
- A**
Abend the job.

HRF01544A (jobname): Reply 'N', 'T', 'C', or 'A'

Explanation

This WTOR message is issued after message HRF01544I. This message indicates that the IMS Online Reorganization Facility job is waiting for an operator response.

System action

Processing waits for an operator response. During the wait, the IMS Online Reorganization Facility job continues reorganization in the background. If the job is ready for the Takeover phase, it goes into idle mode and waits for a response to the WTOR message.

User response

Take one of the actions listed in the preceding HRF01544I message.

HRF01545I Ready for Takeover

Explanation

The IMS Online Reorganization Facility job is ready for takeover.

System action

The IMS Online Reorganization Facility job issues HRF01544I and waits for an operator response.

User response

See message HRF01544I.

HRF01546W Unable to complete
ONLINECHANGE – reason

Explanation

The IMS Online Reorganization Facility job detected DBD changes. ONLINCHANGE(Y) was in effect, but IMS Online Reorganization Facility was unable to locate any IMSACBA or IMSACBB data sets to copy new ACBs into.

System action

The IMS Online Reorganization Facility job continues takeover processing but ends with return code 4. The databases are left in the prohibit authorization (PROHIBIT AUTH = ON) state.

User response

The new ACBs were generated into the IMSACB data set. You must manually copy these ACBs into the appropriate IMSACBA and IMSACBB data sets. After copying the ACBs, reset the prohibit authorization flag in DBRC. In future runs of IMS Online Reorganization Facility, if all online IMS subsystems are down, provide the appropriate IMSACBA and IMSACBB DD statements in the IMS Online Reorganization Facility job to identify the appropriate data sets.

HRF01547E Backout failed for DBD *dbname*
on *imsid* – original database is in
inconsistent state

Explanation

When IMS Online Reorganization Facility was replicating changes that were made to the original database in the online IMS subsystems to the shadow database, the online IMS subsystem encountered an error when it attempted to back out some of the changes that were made to the original database.

System action

IMS stops the original database and leaves it with some changes that were not backed out. Because the IMS Online Reorganization Facility job cannot determine which changes should or should not be applied to the shadow database, the job terminates.

User response

Correct the problem in the original database and resubmit the IMS Online Reorganization Facility job.

HRF01548E Change capture terminated with
inflight changes

Explanation

IMS Online Reorganization Facility is terminating the Apply phase and cannot determine if some of the captured changes should be committed or backed out.

System action

The IMS Online Reorganization Facility job terminates abnormally.

User response

This is likely a logic error in IMS Online Reorganization Facility. Contact IBM Software Support.

HRF01549E **Unexpected return code (*return code*) from USEREXIT**

Explanation

During the Apply phase, IMS Online Reorganization Facility received an invalid return code from the USEREXIT that was specified in the RELOAD.USEREXIT keyword.

System action

The IMS Online Reorganization Facility job terminates abnormally.

User response

Correct the problem with the USEREXIT, and resubmit the IMS Online Reorganization Facility job.

HRF01550E **USEREXIT requested source segment (*segment name*) in HALDB database be deleted**

Explanation

During the Apply phase, the USEREXIT returned a return code that requested a source segment to be deleted. For HALDB databases, IMS Online Reorganization Facility does not support deletion of index source segments.

System action

The IMS Online Reorganization Facility job terminates abnormally.

User response

Either resubmit the job without the USEREXIT, or change the USEREXIT so that it does not delete any index source segments.

HRF01551E **Another ORF job already running for DBD *dbdname***

Explanation

IMS Online Reorganization Facility is already running for this DBD.

System action

The process terminates.

User response

None.

HRF01552E **Error saving information in restart data set**

Explanation

The restart data could not be saved.

System action

The process terminates.

User response

Contact IBM Software Support.

HRF01553E ***nn* status code from *nnnn* call to HSSR for segment *segname***

Explanation

An unexpected status code was received.

System action

The process terminates.

User response

Contact IBM Software Support.

HRF01554E ***dsname* not found in catalog**

Explanation

A database data set that should be in the catalog was not found.

System action

The process terminates.

User response

Contact IBM Software Support.

HRF01555E Information in catalog for *dsname* is different

Explanation

The allocated and cataloged data sets have discrepancies. This message is followed by messages HRF01556E and HRF01557E.

System action

The process terminates.

User response

Contact IBM Software Support.

HRF01556E *type in catalog is/are: text*

Explanation

See message HRF01555E.

System action

The process terminates.

User response

Contact IBM Software Support.

HRF01557E *type in this job is/are: text*

Explanation

See message HRF01555E.

System action

The process terminates.

User response

Contact IBM Software Support.

HRF01558W DBs are left in prohibit auth state

Explanation

The takeover process did not finish completely. The databases are left in a prohibit authorization (PROHIBIT AUTH = ON) state.

System action

The process ended.

User response

Complete one of the following tasks depending on the situation:

- If the takeover was delayed because you specified TAKEOVER(Delay), specify the RESTART(AUTO) keyword and resubmit the job. The process restarts from the Takeover phase to finish the job.
- If the takeover is incomplete because you specified ONLINECHANGE(N), see the preceding HRF01578W message.
- If the takeover is incomplete because of an error, correct the error. Then specify the RESTART(AUTO) keyword and resubmit the job or manually complete the remaining tasks.

HRF01559E DBD *dbdname* is not in prohibit auth state

Explanation

The specified DBD should still be in prohibit authorization state. However, it is not in that state anymore. The previous IMS Online Reorganization Facility operation did not finish normally.

This problem was probably detected during an IMS Online Reorganization Facility restart operation during which the database was activated by an operator command. The database might have been updated in between two IMS Online Reorganization Facility runs. The current status of the database is not known.

System action

The process terminates.

User response

Collect all output, including output from the previous runs, and check the IMS messages from the CTL and DLISAS region for information that might be related to this database. A time stamp recovery also might be necessary. Contact IBM Software Support.

HRF01560E [SORT | IDCAMS] failed, Return code is *retcode*

Explanation

The call to the specified utility failed. Additional error messages are issued.

System action

The process terminates.

User response

Refer to the additional messages for information about how to resolve this error.

HRF01561E **RESTART data set can only be single volume**

Explanation

The file allocation of the restart data set is invalid.

System action

The process terminates.

User response

Resubmit the IMS Online Reorganization Facility restart data set definition.

HRF01562E **Unable to locate RECON data sets**

Explanation

The RECON data sets were not allocated.

System action

The process terminates.

User response

Provide RECON data sets by:

- Specifying RECONx DDs, or
- Specifying IMSDALIB that has the RECON MDAs

HRF01563E **Captured change records out of sequence**

Explanation

A sequence error was detected when the captured change records were applied.

System action

The process terminates.

User response

Resubmit the job and contact IBM Software Support to inform them about this error.

HRF01564W **Unable to *imscmd* DBD *dbdname* on IMS *imsid***

Explanation

The specified IMS command failed on the indicated IMS system for this DBD. This message is followed by message IHC01565A and a WTOR to ask for an action.

System action

Respond to the reply message.

User response

Act on the WTOR.

HRF01565A *text*

Explanation

This message follows message 01564W and is self-explanatory.

System action

None.

User response

None.

HRF01566E **DBD *dbdname* has been allocated by unknown subsystem since IMS Online Reorganization Facility stopped capturing changes**

Explanation

The database was allocated after the changes were applied, but before the Takeover process started.

System action

The function ends abnormally.

User response

The original database might have been updated. These updates will be lost if a takeover is performed; therefore, restart the process from the beginning.

HRF01567E **Not all DBDs defined to *imsid***

Explanation

The database definition in the online system is inconsistent. The primary DBD or some index DBDs might be missing.

System action

The process terminates.

User response

Correct the IMS GEN.

HRF01568I DBDs not defined to *imsid*

Explanation

The requested DBDs are not defined in the specified IMS system.

System action

The XCF connection to this IMS system is terminated.

User response

None. This message is informational.

HRF01569I DLI batch job: *jobname* active

Explanation

IMS Online Reorganization Facility detected that the database to reorganize is being accessed by a DLI batch job. This message is followed by message HRF01569A or HRF01571E.

System action

None.

User response

See the subsequent message HRF01569A or HRF01571E.

HRF01569A (*jobname*): Waiting for DLI batch jobs to finish. Reply 'C' to cancel

Explanation

This WTOR message is issued after message HRF01569I. This message indicates that the IMS Online Reorganization Facility job is waiting for the DLI batch jobs to stop.

System action

Processing waits for the DLI batch jobs to stop. During the wait, the IMS Online Reorganization Facility job makes retry attempts in the background and deletes the WTOR message after all the DLI batch jobs stop.

User response

Take one of the following actions:

- Type 'C' to cancel the reorganization job.

- Type nothing and wait for the listed DLI batch jobs to end, or manually end the DLI batch jobs so the reorganization job can proceed.

HRF01570E Waiting for BMPs has expired

Explanation

The number of retry attempts to stop BMP jobs reached the maximum number set by the BMPRETRY parameter in the base configuration module.

System action

The process terminates.

User response

Wait for the BMP jobs that are shown in the WTOR message to end, and resubmit the IMS Online Reorganization Facility job.

You can increase the maximum number of retry attempts by specifying the BMPRETRY parameter in the base configuration module.

If the database is used by long-running BMP jobs, consider enabling BMP job pause handling. For more information, see [“BMP pause feature”](#) on page 12.

HRF01571E Waiting for DLI batch jobs has expired

Explanation

The number of retry attempts to wait for DLI batch jobs reached the maximum number set by the DLIRETRY parameter in the base configuration module.

System action

The process terminates.

User response

Wait for the DL/I batch jobs that are shown in the preceding message HRF01569I to end, and resubmit the IMS Online Reorganization Facility job. You can increase the maximum number of retry attempts by specifying the DLIRETRY parameter in the base configuration module.

HRF01572E Waiting for database pause has expired

Explanation

An attempt to pause the database has timed out.

System action

The process terminates.

User response

Resubmit the IMS Online Reorganization Facility job. If the error persists, contact IBM Software Support.

HRF01573E	Logical DBD <i>dbdname</i> is not specified by the LOGICALDBD keyword.
------------------	---

Explanation

The database was updated by using a PCB that references the indicated logical DBD, but the LOGICALDBD keyword does not specify the logical DBD. Any logical DBD that applications use for update during the reorganization must be specified with the LOGICALDBD keyword.

System action

Processing terminates.

User response

Use the LOGICALDBD keyword to specify the logical DBD.

HRF01574E	DBD <i>dbdname</i> has insert, delete, or replace rules that are not supported.
------------------	--

Explanation

Unsupported path type is specified in the insert, delete, or replace rules of the indicated DBD. For HALDB databases that have internal logical relationships, the following restrictions apply to the insert, delete, and replace rules. The rules are specified by using the RULES= keyword of a SEGM statement in the physical DBD.

- Insert rules L and V are not supported for logical parents. Only the P insert rule is supported.
- Delete rules L and V are not supported for logical parents. Only the P deletion rule is supported.
- Replace rule V is not supported for logical parents.

No restrictions apply to the insert, delete, and replace rules of full-function databases.

System action

Processing terminates.

User response

None. You cannot use IMS Online Reorganization Facility to process a HALDB DBD with these rules.

HRF01575E	Internal message buffer allocation failed
------------------	--

Explanation

IMS Online Reorganization Facility cannot allocate the internal message buffers for receiving XCF messages.

System action

Processing terminates.

User response

Adjust the size of the internal message buffers by specifying the XCFMAX parameter in the base configuration module. For more information, see [“Base configuration parameters” on page 120](#).

HRF01576E	Internal message buffers are exhausted
------------------	---

Explanation

The internal message buffers that receive XCF messages are full.

System action

Processing terminates.

User response

Increase the size of the internal message buffers by specifying the XCFMAX parameter in the base configuration module. For more information, see [“Base configuration parameters” on page 120](#).

HRF01577E	ONLINECHANGE(N) required because PSBs must be rebuilt
------------------	--

Explanation

The specified DBD change involves changes to PSBs, which requires the ONLINECHANGE(N) keyword.

System action

Processing terminates.

User response

Specify ONLINECHANGE(N) and resubmit the job. After the job ends, perform any required post-processing tasks.

HRF01578W IMS online change is required

Explanation

IMS Online Reorganization Facility updated the staging ACB library with the new database definition, but the ACBs in online IMS subsystems are not updated.

System action

Processing continues.

User response

Use the Online Change Copy utility to copy the ACBs from the staging ACB library to the inactive ACB library. Then perform a standard IMS online change.

**HRF01579W Unable to change DEBUG status:
reason**

Explanation

IMS Online Reorganization Facility could not change the DEBUG state for the target IMS subsystem.

System action

The previous DEBUG state is still in effect for the target IMS subsystem.

User response

Correct the condition reported in the message and resubmit the job.

**HRF01580W Database *database* was not
allocated on STA request**

Explanation

Database was started on online IMS subsystems, but the database was not allocated due to a dynamic allocation failure. The database will be allocated when it is scheduled.

This message might be issued when a job step that follows the IMS Online Reorganization Facility job step attempts to statically allocate the database data sets. After the database data sets are reorganized, the job will have exclusive use of the database data sets until the job completes. Therefore, even if DISP=SHR is specified in the allocation job step, the online IMS subsystem fails to allocate the database data sets.

System action

Processing continues.

User response

If static allocation of database data set is requested in a subsequent job step, remove that job step and included it in another job.

**HRF01581E Number of online IMS subsystems
has changed**

Explanation

The IMS Online Reorganization Facility job detected a change in the number of online IMS subsystems during reorganization. See the preceding HRF01515W message to determine whether IMS subsystem was started or terminated.

System action

Processing terminates.

User response

If you do not plan to start or shutdown any online IMS subsystems, resubmit the IMS Online Reorganization Facility job. If you received this message as a result of an error or a sudden termination of the IMS control region, correct the problem in the IMS control region and resubmit the IMS Online Reorganization Facility job.

**HRF01582W One of dual image copy data sets
was not created**

Explanation

Dual image copy was requested but either the primary or the secondary image copy data set was not created due to an error in the image copy process.

System action

Processing continues.

User response

To create another copy, use the Create Image Copy (CRC) function of IMS High Performance Image Copy. For more information, see the *IMS High Performance Image Copy User's Guide*.

**HRF01583E Unexpected return code
from partition selection exit,
FUNC=function, RC=rc**

Explanation

The partition selection exit returned an unexpected return code. *function* is the function code, and *rc* is the return code from the exit.

System action

Processing stops.

User response

Correct the error in the partition selection exit, and resubmit the IMS Online Reorganization Facility job.

HRF01601I	Notification for <i>dbname</i> [<i>partname</i>] has been sent to AD server
------------------	--

Explanation

A system notification was sent to the Autonomics Director server.

System action

Processing continues.

User response

None. This message is informational.

HRF01602W	Notification failed, FUNC=<i>function</i>, RC=<i>rc</i>, RSN=<i>rsn</i>
------------------	--

Explanation

IMS Online Reorganization Facility failed to send the system notification to the Autonomics Director server.

System action

Processing continues.

User response

Ensure that the Autonomics Director server, which the ADXCFGRP keyword specifies, is started correctly.

HRF01603W	Notification to AD was canceled: <i>reason</i>
------------------	---

Explanation

IMS Online Reorganization Facility did not send a system notification to the Autonomics Director server.

System action

Processing continues. But the system notification to the Autonomics Director server is not sent.

User response

Complete one of the following tasks depending on the *reason* indicated in the message:

IAVNTFYO LOAD FAILURE

Ensure that the SHKTLOAD library of IMS Tools Base is specified in the STEPLIB concatenations correctly.

INITIALIZATION FAILURE

Ensure that the XCF group name specified with the ADXCFGRP keyword is correct and the specified Autonomics Director server is correctly configured.

UNSUPPORTED FUNCTION

Ensure that all the conditions for using the ADXCFGRP keyword are met. For the conditions, see “[ADXCFGRP keyword](#)” on page 53.

INTERNAL ERROR

Contact IBM Software Support.

HRF01604I	Utility history data for <i>dbname</i> [<i>partname</i>] stored
------------------	--

Explanation

IMS Online Reorganization Facility stored the utility history data for the indicated resource in the IMS Tools KB Sensor Data repository. If the database is a full-function database, *dbname* is the name of the database. If the database is a HALDB, *dbname* is the master DBD name, and *partname* is the name of the HALDB partition.

System action

Processing continues.

User response

None. This message is informational.

HRF01605W	An error occurred in HKTEXST call, FUNC=<i>function</i>, RC=<i>rc</i>, RSN=<i>rsn</i>
------------------	--

Explanation

An error occurred during the IMS Tools KB job statistics API (HKTEXST) call. *function* is the function code, and *rc* and *rsn* are the return code and the reason code from the API.

System action

Processing continues, but the utility history data is not stored in the IMS Tools KB Sensor Data repository.

User response

Contact IBM Software Support.

HRF01606W **Utility history data process was canceled. REASON: *reason***

Explanation

An error occurred and the utility history data process was canceled. *reason* is one of the following texts:

- INITIALIZATION FAILURE
- INTERNAL ERROR

System action

Processing continues, but the utility history data is not stored in the Sensor Data repository.

User response

Complete one of the following tasks depending on the *reason*:

INITIALIZATION FAILURE

Ensure that the SHKTLOAD library of IMS Tools Base is included in the STEPLIB concatenation and that the IMS Tools KB server is configured correctly.

INTERNAL ERROR

Contact IBM Software Support.

HRF01611I **Reorganization starts for [database *dbname* | partition *partname*]**

Explanation

The Conditional Reorganization Support Service (CRSS) determined that the database or the partition requires a reorganization. IMS Online Reorganization Facility is starting the reorganization process for the indicated database or partition.

System action

Processing continues.

User response

None. This message is informational.

HRF01612I **Reorganization is not needed for [database *dbname* | partition *partname*]**

Explanation

The Conditional Reorganization Support Service (CRSS) determined that the indicated database or partition does not need to be reorganized.

System action

The IMS Online Reorganization Facility job ends without reorganizing the database or the partition.

User response

None. This message is informational.

HRF01613I **One or more exceptions are detected in [database *dbname* | partition *partname*]**

Explanation

The Conditional Reorganization Support Service (CRSS) evaluated the indicated database or partition and detected one or more database exceptions.

System action

Processing continues.

User response

Complete the following steps:

1. Check the output from the job.

If the reorganization policy was customized to send exception notification messages by using the z/OS WTO service, the TSO/E SEND command, or through email or texting, check those messages that are issued by the job. Those messages include a job summary message (policy evaluation summary message) that summarizes the result of policy evaluation performed by Policy Services during the job.

For more information, see the topic "Checking the policy evaluation summary message" in the *IMS Database Reorganization Expert User's Guide*.

For information about finding the Diagnosis report that was created by this job and that is stored in the Output repository of IMS Tools Knowledge Base, see the topic "Finding Diagnosis reports by using report completion codes" in the *IMS Database Reorganization Expert User's Guide*.

2. Check the exceptions in the Diagnosis report and identify the cause of the database exceptions.

For more information, see the topic "Identifying the cause of database exceptions" in the *IMS Database Reorganization Expert User's Guide*.

HRF01614I **No exception is detected in [database *dbname* | partition *partname*]**

Explanation

The Conditional Reorganization Support Service (CRSS) evaluated the indicated database or partition and detected no database exceptions.

System action

Processing continues.

User response

None. This message is informational.

HRF01615I **[Database *dbname* | Partition *partname*] is reorganized because REORGDIAG is specified**

Explanation

The indicated database or partition is reorganized regardless of its status because the job runs in Reorganization Diagnosis mode.

System action

Processing continues.

User response

None. This message is informational.

HRF01616W **An error occurred in BBECRAPI call, FUNC=*function*, RC=*rc*, RSN=*rsn***

Explanation

An error occurred during the Conditional Reorganization Support Service (CRSS) API call. *function* is the function code, and *rc* and *rsn* are the return code and the reason code from the API.

System action

Processing continues.

User response

The detail of the error or the warning is recorded in the journal messages that are issued by the CRSS. Correct the error and rerun the job.

HRF01617W **Conditional Reorg service is deactivated. REASON: *reason***

Explanation

The Conditional Reorganization Support Service (CRSS) cannot continue the job because of the reason displayed.

System action

The processing continues without the CRSS. If the job runs in either Conditional Reorganization mode or Reorganization Diagnosis mode, IMS Online Reorganization Facility reorganizes the database regardless of database status, but the CRSS does not generate a Diagnosis report.

User response

Complete one of the following tasks depending on the *reason*:

BBECRI00 LOAD FAILURE

Ensure that the IMS Database Reorganization Expert load library is included in the STEPLIB concatenation.

INITIALIZATION FAILURE

Ensure that Policy Services is configured correctly.

ITKB INIT FAILURE

Ensure that the SHKTLOAD library of IMS Tools Base is included in the STEPLIB concatenation and that the Tools KB Server is configured correctly.

ITS FAILURE

The CRSS failed. The cause of the error is shown in BBExxxxx messages.

ITKBSERVER NOT SPECIFIED

Ensure that the ITKBSERVER keyword is specified in the HRFSYSIN DD statement.

UNSUPPORTED FUNCTION

Ensure that all of the following conditions for the CRSS are met:

- The primary database to reorganize is a full-function database or a single partition of a HALDB.
- The primary database to reorganize is not an index database.
- TAKEOVER(N) is not specified in the REORG HRFSYSIN DD statement.
- DBD change is not requested.

INTERNAL ERROR

Contact IBM Software Support.

HRF01621E PSINDEXBLD(Y) not available.
REASON: reason

Explanation

PSINDEXBLD(Y) cannot be applied because the requirements to apply PSINDEXBLD(Y) are not satisfied.

System action

Processing terminates.

User response

Perform the action that corresponds to the reason shown in the message and rerun the job.

INDEX BUILDER NOT FOUND

Ensure that the load library of IMS Index Builder is included in the STEPLIB concatenation.

HP LOAD NOT FOUND

Ensure that the load library of IMS High Performance Load is included in the STEPLIB concatenation.

ALL PARTITIONS REQUIRED

Remove the PARTITION or PARTLIST keyword from the command so that all partitions are processed.

WFHLQ NOT SPECIFIED

Specify the WFHLQ parameter in the base configuration module or add the RELOAD.WFPHLQ keyword to the HRFSYSIN DD statement.

HRF01622I PSINDEXBLD(Y) is ignored

Explanation

PSINDEXBLD(Y) is ignored because one of the following conditions has been detected:

- The primary database to reorganize is not a HALDB.
- No PSINDEXes are defined to the primary database to reorganize.

System action

None.

User response

None. This message is informational.

HRF01623E INITIALIZE(Y) not available.
REASON: reason

Explanation

INITIALIZE(Y) cannot be applied because the conditions for applying INITIALIZE(Y) are not met.

System action

Processing terminates.

User response

Complete one of the following tasks depending on the reason indicated in the message and resubmit the job:

HP LOAD NOT FOUND

Ensure that the load library of IMS High Performance Load is specified in the STEPLIB concatenations correctly.

INDEX NOT SUPPORTED

Ensure that the primary database to reorganize is not an index database.

PSINDEXBLD(Y) REQUIRED

Add the PSINDEXBLD(Y) keyword to the HRFSYSIN DD statement.

HRF01624E DFSUINPT DD must define a dummy data set when INITIALIZE(Y) is specified

Explanation

Database initialization failed because DFSUINPT DD statement does not define a dummy data set.

System action

Processing terminates.

User response

To initialize (empty out) the database during reorganization, add the DFSUINPT DD statement that defines a dummy data set and rerun the job.

HRF01626I Primary database is reorganized because one or more indexes need reorganization

Explanation

The Conditional Reorganization Support Service (CRSS) determined that one or more secondary indexes need to be reorganized. IMS Online Reorganization Facility is starting the reorganization process for the primary database and the rebuilding process for all the secondary indexes.

System action

Processing continues.

User response

None. This message is informational.

HRF01627I **Image copies are taken because CR.IC(ALWAYS) is specified**

Explanation

The Conditional Reorganization Support Service (CRSS) determined that the database does not need to be reorganized. IMS Online Reorganization Facility does not reorganize the database but it creates image copies of the primary database because CR.IC(ALWAYS) is specified.

System action

Processing continues.

User response

None. This message is informational.

HRF01628I **Database is unloaded because CR.UNLOAD(ALWAYS) is specified**

Explanation

The Conditional Reorganization Support Service (CRSS) determined that the database does not need to be reorganized. IMS Online Reorganization Facility does not reorganize the database but it starts the unload process to create an HD unload file.

System action

Processing continues.

User response

None. This message is informational.

HRF01631E **Unable to process external logical relationship. REASON: *reason***

Explanation

The database has external logical relationships, but the requirements to process external logical relationships are not satisfied.

System action

Processing terminates.

User response

Complete one of the following tasks depending on the *reason* indicated in the message and resubmit the job:

HP LOAD NOT FOUND

Ensure that the load library of IMS High Performance Load is included in the STEPLIB concatenation.

HP UNLOAD NOT FOUND

Ensure that the load library of IMS High Performance Unload is included in the STEPLIB concatenation.

ALL PARTITIONS REQUIRED

Remove the PARTITION or PARTLIST keyword from the command so that all partitions are processed.

UNLHLQ NOT SPECIFIED

Specify the UNLHLQ parameter in the base configuration module.

WFHLQ NOT SPECIFIED

Specify the WFHLQ parameter in the base configuration module.

HRF01632E **Number of logically-related databases exceeds the maximum allowed**

Explanation

The number of the databases that are logically related to the target database exceeds the maximum supported by IMS Online Reorganization Facility.

System action

Processing terminates.

User response

Use offline utilities for this process.

HRF01633I **DBD *dbdname* is processed because it has logical relationship**

Explanation

The indicated DBD is processed because it is in the same logical group as the DBD specified by the DBD keyword.

System action

None.

User response

None. This message is informational.

HRF01634E **Number of unload files exceeds the maximum allowed****Explanation**

The number of the unload files exceeds the maximum supported by IMS Online Reorganization Facility.

System action

Processing terminates.

User response

This message is issued in conjunction with message HRF01311I. Please refer to the user response of message HRF01311I.

HRF01640I **DDEFPS2 data set is used for allocating shadow space****Explanation**

The IDCAMS commands that are specified in the DDEFPS2 data set are used by the IDCAMS program to delete and define the shadow data sets.

System action

None.

User response

None. This message is informational.

HRF01641I **Member name: *membname* in DDEFPS2 DD overrides the allocation of the shadow data set****Explanation**

The data set specified for the DDEFPS2 DD statement contains a member with the indicated name.

System action

The IDCAMS commands override the allocation of the shadow data set.

User response

None. This message is informational.

HRF01642I **Member name: *membname* in DDEFPS2 DD does not override the allocation of the shadow data set****Explanation**

The data set specified for the DDEFPS2 DD statement does not contain a member with the indicated name.

System action

IMS Online Reorganization Facility generates IDCAMS commands automatically for the indicated member if necessary.

User response

None. This message is informational.

HRF01643E **Conversion from OSAM LDS to OSAM not supported****Explanation**

Conversion from OSAM LDS to OSAM PS is not supported.

System action

Processing stops.

User response

You can convert OSAM LDS to OSAM PS manually.

HRF01644E **Data set name in member: *member_name* is the same as original DBDS name****Explanation**

The data set name specified in a member of the DDEFPS2 DD is the same as the original DBDS name.

System action

Processing stops.

User response

Specify the data set name in message HRF01645E and rerun the job.

HRF01645E **Data set name in member: *member_name* is not the same as shadow data set name****Explanation**

The data set name specified in a member of the DDEFPS2 DD is not the same as the shadow data set name.

System action

Processing stops.

User response

Specify the data set name in message HRF01645E and rerun the job.

HRF01646E **Specify shadow data set name:**
dataset_name

Explanation

This message indicates the data set name that you should specify.

System action

Processing stops.

User response

Specify the data set name and rerun the job.

HRF01647E **When converting VSAM to OSAM,**
DDEFPS2 DD must be specified

Explanation

When converting VSAM to OSAM, DDEFPS2 DD must be specified.

System action

Processing stops.

User response

Specify DDEFPS2 DD and rerun the job.

HRF01648E **When converting VSAM to OSAM,**
OSAM PS or LDS must be specified
in DDEFPS2 DD

Explanation

When converting VSAM to OSAM, OSAM PS or LDS must be specified in DDEFPS2 DD.

System action

Processing stops.

User response

Specify OSAM PS or LDS in DDEFPS2 DD and rerun the job.

HRF01650E **BACKOUT process failed**

Explanation

The process specified by the BACKOUT option of the TAKEOVER keyword fails.

System action

Processing stops. Databases are left offline and in the prohibit authorization (PROHIBIT AUTH = ON) state.

User response

You need to manually back out the changes IMS Online Reorganization Facility has already completed during the Takeover phase. You can confirm the changes in MSGPRINT DD.

HRF01651I **TAKEOVER(BACKOUT) is ignored**
and processing continues as
TAKEOVER(Y)

Explanation

TAKEOVER(BACKOUT) is ignored, and processing continues as TAKEOVER(Y) because one of the following conditions is detected:

- NEWDBD keyword is specified.
- There are records in the restart data set in RESTART(AUTO).

System action

None.

User response

None. This message is informational.

HRF01660I **Updating the IMS catalog started**

Explanation

The IMS catalog update process started.

System action

None.

User response

None. This message is informational.

HRF01661I **Updating the IMS catalog skipped**

Explanation

The IMS catalog update process was skipped because an error occurred.

System action

Processing continues.

User response

Rerun the DFS3PU00 utility manually if needed.

HRF01662I Updating the IMS catalog ended

Explanation

The IMS catalog update process ended.

System action

None.

User response

None. This message is informational.

HRF01701E HPSCCATI API failed RC=*rc*, RSN=*rsn*

Explanation

IMS Online Reorganization Facility received an error from the HPSCCATI API. *rc* and *rsn* are the return code and reason code in decimals.

System action

Processing terminates.

User response

This message accompanies other warning or error messages. Follow the directions in the user response sections of the accompanying messages.

HRF01702I IMS management of ACBs is enabled

Explanation

The IMS management of ACBs is enabled.

System action

Processing continues.

User response

None. This message is informational.

HRF01703E GEX\$CATQ API failed RC=*rc*, RSN=*rsn*, DBD=*nnnnn*

Explanation

The GEX\$CATQ API returned an error indication. The return code from the macro call was *rc* and the reason code was *rsn*. For the reason of the error, see the preceding GEX messages that were issued by the GEX\$CAQ API.

System action

Processing terminates.

User response

This message accompanies other warning or error messages. Follow the directions in the user response sections of the accompanying messages.

HRF01705E Failed to process IMS-managed ACBs. REASON: *reason*

Explanation

IMS Online Reorganization Facility failed to process IMS-managed ACBs because of the reason displayed.

System action

Processing terminates.

User response

Perform the action that corresponds to the reason shown in the message and rerun the job.

CATALOG OPEN FAILURE

Ensure that the IMS Tools Generic Exits load library is included in the STEPLIB concatenation.

DBDDSN NOT SPECIFIED

Specify the DBDDSN parameter in the base configuration module.

HP LOAD NOT FOUND

Ensure that the load library of IMS High Performance Load is included in the STEPLIB concatenation.

HP PREFIX RESOLUTION NOT FOUND

Ensure that the load library of IMS High Performance Prefix Resolution is included in the STEPLIB concatenation.

TEMP DBDLIB ALLOC FAILURE

Ensure that the required parameter DBDDSN and optional parameters DBDCLAS, DBSCLAS and DBDVOL in the base configuration module have appropriate values.

If the reason is not in this list, contact IBM Software Support.

HRF01706E **NEWDBD(*STAGING) is specified, but IMS management of ACBs is not enabled.**

Explanation

NEWDBD(*STAGING) cannot be applied because the IMS management of ACBs is not enabled.

System action

Processing terminates.

User response

Ensure that the IMS management of ACBs is enabled and that the DFSDF and IMSID keywords, the PROCLIB DD statement or the IMS Catalog Definition exit routine (DFS3CDX0) is configured correctly.

HRF01707I **NEWDBD will be obtained from catalog staging data set**

Explanation

The new DBD will be obtained from the IMS catalog staging data set.

System action

None.

User response

None. This message is informational.

HRF01708W **IMPORT DEFN SOURCE(CATALOG) is required**

Explanation

IMS Online Reorganization Facility reorganized the database using the new database definition obtained from the IMS catalog staging data set, but the staging data sets are not activated in online IMS subsystems.

System action

Processing continues.

User response

Perform these steps to complete the DBD change:

1. Issue the IMPORT DEFN SOURCE(CATALOG) command to activate the new database definition in online IMS subsystems.
2. If the Integrity Checker utility of IMS Library Integrity Utilities is active in your environment, use the LICON utility and re-create the RDE.
3. Turn off the prohibit authorization flag and bring the database back online.

Gathering diagnostic information

Before you report a problem with IMS Online Reorganization Facility to IBM Software Support, you need to gather the appropriate diagnostic information.

Procedure

Provide the following information for all IMS Online Reorganization Facility problems:

- A clear description of the problem and the steps that are required to re-create the problem
- All messages that were issued as a result of the problem
- Product release number and the number of the last program temporary fix (PTF) that was installed
- The version of IMS that you are using and the type and version of the operating system that you are using

Provide additional information based on the type of problem that you experienced:

For online abends, provide the following information

- The job log from the TSO session that encountered the abend
- The job log from the server
- A description of the task that you were doing before the abend occurred

For errors in batch processing, provide the following information

- The complete job log
- Print output

- Contents of any data sets that were used during the processing

Notices

This information was developed for products and services offered in the US. This material might be available from IBM in other languages. However, you may be required to own a copy of the product or product version in that language in order to access it.

IBM may not offer the products, services, or features discussed in this document in other countries. Consult your local IBM representative for information on the products and services currently available in your area. Any reference to an IBM product, program, or service is not intended to state or imply that only that IBM product, program, or service may be used. Any functionally equivalent product, program, or service that does not infringe any IBM intellectual property right may be used instead. However, it is the user's responsibility to evaluate and verify the operation of any non-IBM product, program, or service.

IBM may have patents or pending patent applications covering subject matter described in this document. The furnishing of this document does not give you any license to these patents. You can send license inquiries, in writing, to:

*IBM Director of Licensing IBM Corporation
North Castle Drive, MD-NC119
Armonk, NY 10504-1785 US*

For license inquiries regarding double-byte (DBCS) information, contact the IBM Intellectual Property Department in your country or send inquiries, in writing, to:

*Intellectual Property Licensing Legal and Intellectual Property Law IBM Japan Ltd.
19-21, Nihonbashi-Hakozakicho, Chuo-ku
Tokyo 103-8510, Japan*

INTERNATIONAL BUSINESS MACHINES CORPORATION PROVIDES THIS PUBLICATION "AS IS" WITHOUT WARRANTY OF ANY KIND, EITHER EXPRESS OR IMPLIED, INCLUDING, BUT NOT LIMITED TO, THE IMPLIED WARRANTIES OF NON-INFRINGEMENT, MERCHANTABILITY OR FITNESS FOR A PARTICULAR PURPOSE. Some jurisdictions do not allow disclaimer of express or implied warranties in certain transactions, therefore, this statement may not apply to you.

This information could include technical inaccuracies or typographical errors. Changes are periodically made to the information herein; these changes will be incorporated in new editions of the publication. IBM may make improvements and/or changes in the product(s) and/or the program(s) described in this publication at any time without notice.

Any references in this information to non-IBM websites are provided for convenience only and do not in any manner serve as an endorsement of those websites. The materials at those websites are not part of the materials for this IBM product and use of those websites is at your own risk.

IBM may use or distribute any of the information you supply in any way it believes appropriate without incurring any obligation to you.

Licensees of this program who wish to have information about it for the purpose of enabling: (i) the exchange of information between independently created programs and other programs (including this one) and (ii) the mutual use of the information which has been exchanged, should contact:

*IBM Director of Licensing IBM Corporation
North Castle Drive, MD-NC119
Armonk, NY 10504-1785 US*

Such information may be available, subject to appropriate terms and conditions, including in some cases, payment of a fee.

The licensed program described in this document and all licensed material available for it are provided by IBM under terms of the IBM Customer Agreement, IBM International Program License Agreement or any equivalent agreement between us.

This information contains examples of data and reports used in daily business operations. To illustrate them as completely as possible, the examples include the names of individuals, companies, brands, and products. All of these names are fictitious and any similarity to actual people or business enterprises is entirely coincidental.

COPYRIGHT LICENSE:

This information contains sample application programs in source language, which illustrate programming techniques on various operating platforms. You may copy, modify, and distribute these sample programs in any form without payment to IBM, for the purposes of developing, using, marketing or distributing application programs conforming to the application programming interface for the operating platform for which the sample programs are written. These examples have not been thoroughly tested under all conditions. IBM, therefore, cannot guarantee or imply reliability, serviceability, or function of these programs. The sample programs are provided "AS IS", without warranty of any kind. IBM shall not be liable for any damages arising out of your use of the sample programs.

Each copy or any portion of these sample programs or any derivative work must include a copyright notice as shown below:

© (your company name) (year).

Portions of this code are derived from IBM Corp. Sample Programs.

© Copyright IBM Corp. (enter the year or years).

If you are viewing this information softcopy, the photographs and color illustrations may not appear.

Trademarks

IBM, the IBM logo, and [ibm.com](http://www.ibm.com)[®] are trademarks or registered marks of International Business Machines Corp., registered in many jurisdictions worldwide. Other product and service names might be trademarks of IBM or other companies. A current list of IBM trademarks is available on the web at "Copyright and trademark information" at <http://www.ibm.com/legal/copytrade.shtml>.

Linux is a registered trademark of Linus Torvalds in the United States, other countries, or both.

Microsoft, Windows, Windows NT, and the Windows logo are trademarks of Microsoft Corporation in the United States, other countries, or both.

UNIX is a registered trademark of The Open Group in the United States and other countries.

Java and all Java-based trademarks and logos are trademarks or registered trademarks of Oracle and/or its affiliates.

Terms and conditions for product documentation

Permissions for the use of these publications are granted subject to the following terms and conditions:

Applicability: These terms and conditions are in addition to any terms of use for the IBM website.

Personal use: You may reproduce these publications for your personal, noncommercial use provided that all proprietary notices are preserved. You may not distribute, display or make derivative work of these publications, or any portion thereof, without the express consent of IBM.

Commercial use: You may reproduce, distribute and display these publications solely within your enterprise provided that all proprietary notices are preserved. You may not make derivative works of these publications, or reproduce, distribute or display these publications or any portion thereof outside your enterprise, without the express consent of IBM.

Rights: Except as expressly granted in this permission, no other permissions, licenses or rights are granted, either express or implied, to the publications or any information, data, software or other intellectual property contained therein.

IBM reserves the right to withdraw the permissions granted herein whenever, in its discretion, the use of the publications is detrimental to its interest or, as determined by IBM, the above instructions are not being properly followed.

You may not download, export or re-export this information except in full compliance with all applicable laws and regulations, including all United States export laws and regulations.

IBM MAKES NO GUARANTEE ABOUT THE CONTENT OF THESE PUBLICATIONS. THE PUBLICATIONS ARE PROVIDED "AS-IS" AND WITHOUT WARRANTY OF ANY KIND, EITHER EXPRESSED OR IMPLIED, INCLUDING BUT NOT LIMITED TO IMPLIED WARRANTIES OF MERCHANTABILITY, NON-INFRINGEMENT, AND FITNESS FOR A PARTICULAR PURPOSE.

Privacy policy considerations

IBM Software products, including software as a service solutions, ("Software Offerings") may use cookies or other technologies to collect product usage information, to help improve the end user experience, to tailor interactions with the end user, or for other purposes. In many cases no personally identifiable information is collected by the Software Offerings. Some of our Software Offerings can help enable you to collect personally identifiable information. If this Software Offering uses cookies to collect personally identifiable information, specific information about this offering's use of cookies is set forth below.

This Software Offering does not use cookies or other technologies to collect personally identifiable information.

If the configurations deployed for this Software Offering provide you as customer the ability to collect personally identifiable information from end users via cookies and other technologies, you should seek your own legal advice about any laws applicable to such data collection, including any requirements for notice and consent.

For more information about the use of various technologies, including cookies, for these purposes, see IBM's Privacy Policy at <http://www.ibm.com/privacy> and IBM's Online Privacy Statement at <http://www.ibm.com/privacy/details> the section entitled "Cookies, Web Beacons and Other Technologies" and the "IBM Software Products and Software-as-a-Service Privacy Statement" at <http://www.ibm.com/software/info/product-privacy>.

Index

Special Characters

/DBR command [17](#)
/DBR FEOV command [17](#)
/START command [17](#)

A

ABEND TAKEOVER.WINDOW action [97](#)
ACB
 replacement [11](#)
ACBGEN [17](#)
ACBLIB [100](#)
ACBLIB or DMB replacement [17](#)
access methods, database [10](#)
accessibility
 overview [34](#)
actions, TAKEOVER.WINDOW ABEND [97](#)
add
 checkpoints [126](#)
ADDBGRP keyword [52](#)
ADXCGRP keyword [53](#)
Apply phase [17](#)
Autonomics Director [102](#)
availability of databases [11](#)

B

base configuration parameters
 changing [120](#)
 module [119](#)
 per IMSID or IMSPLEX [120](#)
batch image copy creation process [23](#)
BBEJRN DD statement [37](#)
BBERPRT DD statement [38](#)
BMP handler [128](#)
BMP jobs [12](#), [126](#), [128](#)
BMP pause feature
 disabling [130](#)
BMPRETRY HRFSETOP option [120](#)
BMPs
 controlling during reorganization [12](#)
 running during the reorganization [12](#)
 started during reorganization [12](#)
BSNJM01 DD statement [38](#), [40](#)

C

changes
 ACBGEN [100](#)
 DBD [100](#)
checkpoint intervals [12](#), [126](#)
CHGDATA HRFSETOP option [120](#)
CHGSTORC HRFSETOP option [120](#)
CHKP call [12](#), [126](#)
CHKPNTS

CHKPNTS (*continued*)
 DD statement [12](#), [126](#)
CICS access, controlling [14](#)
CICS and ODBA applications pause feature
 disabling [130](#)
commands
 /DBR [17](#)
 /DBR FEOV [17](#)
 /START [17](#)
 REORG
 syntax [46](#)
 UNLOAD
 syntax [46](#)
communications, IMS Online Reorganization Facility and
 BMPs [12](#)
compatibility, data [11](#)
COMPAUTH keyword [53](#)
Completion phase [17](#)
concurrent BMPs [12](#)
conditional reorganization [21](#)
conditional reorganization by database type JCL sample [109](#)
conditional reorganization by days passed JCL sample [109](#)
conditional reorganization JCL sample [109](#)
Conditional Reorganization Support Service [21](#)
CONDREORG keyword [53](#)
connecting an IMS Online Reorganization Facility job to an
 online IMS subsystem [137](#)
controlling BMPs during reorganization [12](#)
controlling CICS and ODBA access [14](#)
cookie policy [191](#)
Copy phase [17](#)
CR.DIAGDATAFROM keyword [54](#)
CR.EVALINDEX keyword [55](#)
CR.IC keyword [55](#)
CR.JOURNAL keyword [56](#)
CR.POLICYBY keyword [56](#)
CR.POLICYNM keyword [57](#)
CR.PRINTRPRT keyword [57](#)
CR.SENSOR_HOME keyword [58](#)
CR.STORERPRT keyword [58](#)
CR.UNLOAD keyword [59](#)
creating a batch image copy of a HDAM database sample
 [118](#)
CRSS [21](#)
customizing the environment
 base configuration module [120](#)
 default base configuration parameters [120](#)
 disabling the BMP pause feature [130](#)
 disabling the CICS and ODBA applications pause feature
 [130](#)
 options, environment [119](#)

D

data flow [17](#), [23](#)
database
 authorization [17](#)

database (*continued*)
 data set name length [36](#)
 database types
 IMS Online Reorganization Facility [10](#)
 DATACLAS keyword [59](#)
 DBALL keyword [59](#)
 DBD
 changes not allowed [27](#)
 replacement [11](#)
 DBD change
 in IMS management of ACBs [14](#), [100](#)
 specifying [100](#)
 supported DBD changes [14](#)
 DBD keyword [60](#)
 DBDCLAS HRFSETOP option [120](#)
 DBDCOPY [73](#)
 DBDCOPY keyword [60](#), [100](#)
 DBDDSN HRFSETOP option [120](#)
 DBDLIB [100](#)
 DBDLIST keyword [61](#)
 DBDS name length [36](#)
 DBDS organization conversion and DDEFPS2 DD process
 considerations [25](#)
 DBDVOL HRFSETOP option [120](#)
 DBRC
 notifications [17](#)
 PROHIBIT AUTH [11](#)
 DBRCHIPR HRFSETOP option [120](#)
 DBSCLAS HRFSETOP option [120](#)
 DBSTART HRFSETOP option [120](#)
 DBSTART keyword [61](#)
 DD statements
 BBEJRNL [37](#)
 BBERPRT [38](#)
 BSNJM01 [38](#), [40](#)
 CHKPNTS [126](#)
 DFSPRINT [40](#)
 DFSRESLB [40](#)
 DFSUINPT [41](#)
 DFSURGU1 [41](#)
 DFSURWF1 [41](#)
 HRFBPOFF [128](#)
 HRFSYSIN [41](#)
 ICEPRINT [42](#)
 IEFRDER [42](#)
 imagecopy [42](#)
 IMS [43](#)
 IMSACB [43](#), [100](#)
 MSGPRINT [43](#)
 NEWDBD [44](#)
 PROCLIB [44](#)
 RECON [44](#)
 STEPLIB [45](#)
 summary of [36](#)
 SYSPRINT [45](#)
 SYSUDUMP [45](#)
 TRACE [46](#)
 DDEFPS2 DD JCL sample [114](#)
 DEBUG diagnostic record formatting [134](#)
 DEBUG HRFSETOP option [120](#)
 DELETE keyword [61](#)
 DFDSS HRFSETOP option [120](#)
 DFDSS keyword [62](#)
 DFDSS.FASTREP keyword [62](#)
 DFDSS.FCTOPPRCP keyword [63](#)
 DFDSS.FCTOXRCP keyword [63](#)
 DFSDF keyword [64](#)
 DFSPRINT DD statement [40](#)
 DFSRESLB DD statement [40](#)
 DFSUINPT DD statement [41](#)
 DFSURGU1 DD statement [41](#)
 DFSURWF1 DD statement [41](#)
 diagnostic information
 gathering [189](#)
 diagnostics activation utility (HRFYUTIL)
 description [132](#)
 disabling CICS and ODBA application communication [14](#)
 disallowed DBD changes [27](#)
 DLIRETRY HRFSETOP option [120](#)
 DMB
 replacement [11](#)
 DMB or ACBLIB replacement [17](#)
 DMB replacement [11](#), [100](#)
 documentation
 accessing [33](#)
 sending feedback [33](#)
 documentation changes [4](#)

E

ENQNAME HRFSETOP option [120](#)
 evaluate secondary indexes [113](#)
 EXEC statement [35](#)
 external logical relationships
 considerations [30](#)

F

FEOV HRFSETOP option [120](#)
 FEOV keyword [64](#)
 flow of data [17](#)
 formatting diagnostic records [134](#)
 full-function sample JCL [46](#)
 functional changes [32](#)
 functions
 overview [10](#)
 functions of IMS Online Reorganization Facility [11](#)

G

GDGLIMIT keyword [64](#)
 GDGMODEL keyword [65](#)
 generate Diagnosis report without reorganization JCL sample [112](#)

H

HD unload data set [10](#)
 HDAM database sample JCL [103](#)
 HDAM VSAM database JCL sample [104](#)
 HIDAM database JCL sample [105](#)
 HIDAM OSAM database sample JCL [103](#)
 how data flows through IMS Online Reorganization Facility [17](#)
 HRF [131](#)
 HRFCAPxx [131](#)
 HRFCBPxx [131](#)

HRFCCNFG [131](#)
HRFCINST [131](#)
HRFELOGF [131](#)
HRFEORG1 [131](#)
HRFEORG2 [131](#)
HRFERCOV [131](#)
HRFERINT [131](#)
HRFERSTA [131](#)
HRFSETOP module options, ENQNAME [120](#)
HRFSYSIN [132](#)
HRFSYSIN DD

keyword

ADDBGRP [52](#)
ADXCFGRP [53](#)
COMPAUTH [53](#)
CONDREORG [53](#)
CR.DIAGDATAFROM [54](#)
CR.EVALINDEX [55](#)
CR.IC [55](#)
CR.JOURNAL [56](#)
CR.POLICYBY [56](#)
CR.POLICYNM [57](#)
CR.PRINTRPRT [57](#)
CR.SENSOR_HOME [58](#)
CR.STORERPRT [58](#)
CR.UNLOAD [59](#)
DATACLAS [59](#)
DBALL [59](#)
DBD [60](#)
DBDCOPY [60](#), [100](#)
DBDLIST [61](#)
DBSTART [61](#)
DELETE [61](#)
DFDSS [62](#)
DFDSS.FASTREP [62](#)
DFDSS.FCTOPPRCP [63](#)
DFDSS.FCTOXRCP [63](#)
DFSDF [64](#)
FEOV [64](#)
GDGLIMIT [64](#)
GDGMODEL [65](#)
IC.COMP [65](#)
IC.COMPRTN [66](#)
IC.VIC [71](#)
IC.VICDSN [71](#)
IC1DSN [67](#)
IC2DSN [68](#)
ICDDN [66](#)
ICDYN [67](#)
ICEIN [68](#)
ICHLQ [69](#)
ICID [69](#)
ICMID [69](#)
ICNUM [70](#)
ICTRLR [70](#)
ICVOLCT [72](#)
IDXBLD.MAXTASKS [72](#)
IDXBLD.SORTFSZ [73](#)
IMSID [73](#)
INITIALIZE [74](#)
ITKBDATA [74](#)
ITKBSERVER [75](#)
KEYLABEL [75](#)
LOG1DSN [75](#)

HRFSYSIN DD (continued)

keyword (continued)

LOG2DSN [76](#)
LOGICALDBD [77](#)
LOGPRI [77](#)
LOGSEC [77](#)
MGMTCLAS [78](#)
MONITOR [78](#)
NEWDBD [78](#)
ONLINECHANGE [79](#), [100](#)
OPTID [79](#)
PARTITION [80](#)
PARTLIST [80](#)
PARTNUM [81](#)
PRERES.ALLOWLC [81](#)
PRERES.ALLOWLP [82](#)
PRERES.AVGRLN [82](#)
PRERES.FILSZ [82](#)
PRERES.HPPRBH [83](#)
PRERES.OPRTLQ [83](#)
PRERES.OPRTLPC [83](#)
PRERES.UPDLPC [84](#)
PRERES.XAVGRLN [84](#)
PRERES.XFILSZ [84](#)
PSINDEXBLD [85](#)
PTRCHECK [85](#)
READON [86](#)
READONLY [86](#)
RELOAD.DBIOBUF [86](#)
RELOAD.DBRLBUF [87](#)
RELOAD.FRSPC [87](#)
RELOAD.HPIO [87](#)
RELOAD.OADSPR [88](#)
RELOAD.RAAFORMAT [88](#)
RELOAD.SEARCH [89](#)
RELOAD.SORT [89](#)
RELOAD.USEREXIT [89](#)
RELOAD.WF1HLQ [90](#)
RELOAD.WF1SPACE [90](#)
RELOAD.WF1UNIT [91](#)
RELOAD.WF1VOL [91](#)
RELOAD.WFPHLQ [92](#)
RELOAD.WFPSPACE [92](#)
RELOAD.WFPUNIT [92](#)
RELOAD.WFPVOL [93](#)
RELOAD.WFPVOLCNT [93](#)
RESTART [94](#)
SASJOBPREF [94](#)
SASMAX [95](#)
SHADOW [95](#)
SORTNUM [96](#)
STORCLAS [96](#)
TAKEOVER [96](#)
TAKEOVER.WINDOW [97](#)
TEMPRECOV [98](#)
UNLSPAC [98](#)
UNLUNIT [99](#)
VOLALLO [99](#)
required keywords [46](#)
HRFSYSIN DD keywords summary [47](#)
HRFSYSIN DD statement [41](#)
HRFYUTIL
description [132](#)
syntax [132](#)

I

IC.COMP keyword [65](#)
IC.COMPRTN keyword [66](#)
IC.VIC keyword [71](#)
IC.VICDSN keyword [71](#)
IC1DSN keyword [67](#)
IC2DSN keyword [68](#)
ICDDN keyword [66](#)
ICDYN keyword [67](#)
ICEIN keyword [68](#)
ICEPRINT DD statement [42](#)
ICHLQ keyword [69](#)
ICID keyword [69](#)
ICMID keyword [69](#)
ICNUM keyword [70](#)
ICTRLR keyword [70](#)
ICVOLCT keyword [72](#)
IDXBLD.MAXTASKS keyword [72](#)
IDXBLD.SORTFSZ keyword [73](#)
IEFRDER DD statement [42](#)
imagecopy DD statement [42](#)
IMS Database Reorganization Expert [21](#)
IMS DD statement [43](#)
IMS Library Integrity Utilities [73, 100](#)
IMS management of ACBs
 changing database definition [106](#)
 considerations [29](#)
 DBD change [14, 100](#)
 reorganizing database [104](#)
IMS Tools Base Autonomics Director [102](#)
IMSACB DD statement [43, 100](#)
IMSID keyword [73](#)
INITIALIZE keyword [74](#)
internal logical relationships [1](#)
invoking
 DFSERA10 file select and print utility [134](#)
ITKBDATA keyword [74](#)
ITKBSERVER keyword [75](#)

J

JCL samples
 changing compression routine [105](#)
 changing database definition in IMS management of ACBs [106](#)
 changing randomizer parameters [104](#)
 conditional reorganization [109, 111–113](#)
 creating a batch image copy of a HDAM database [118](#)
 DDEFPS2 DD statement [114–116, 118](#)
 dynamic allocation [103](#)
 EXEC statement [35](#)
 full-function [46](#)
 rebuilding PSINDEXes [108](#)
 reorganization of a PSINDEX partition [108](#)
 reorganizing in IMS management of ACBs [104](#)
 reorganizing partition of PHIDAM [107](#)
 reorganizing PHIDAM [108](#)
 UNLOAD [46](#)
 unload of a HIDAM OSAM database [108](#)
 without DBD changes [103](#)
jobs
 pause [12, 126](#)
 sample [131](#)

K

KEYLABEL keyword [75](#)
keywords
 ADDBGRP [52](#)
 ADXCFGRP [53](#)
 COMPAUTH [53](#)
 CONDREORG [53](#)
 CR.DIAGDATAFROM [54](#)
 CR.EVALINDEX [55](#)
 CR.IC [55](#)
 CR.JOURNAL [56](#)
 CR.POLICYBY [56](#)
 CR.POLICYNM [57](#)
 CR.PRINTRPRT [57](#)
 CR.SENSOR_HOME [58](#)
 CR.STORERPRT [58](#)
 CR.UNLOAD [59](#)
 DATACLAS [59](#)
 DBALL [59](#)
 DBD [60](#)
 DBDCOPY [60, 100](#)
 DBDLIST [61](#)
 DBSTART [61](#)
 DELETE [61](#)
 DFDSS [62](#)
 DFDSS.FASTREP [62](#)
 DFDSS.FCTOPPRCP [63](#)
 DFDSS.FCTOXRCP [63](#)
 DFSDF [64](#)
 FEOV [64](#)
 GDGLIMIT [64](#)
 GDGMODEL [65](#)
 IC.COMP [65](#)
 IC.COMPRTN [66](#)
 IC.VIC [71](#)
 IC.VICDSN [71](#)
 IC1DSN [67](#)
 IC2DSN [68](#)
 ICDDN [66](#)
 ICDYN [67](#)
 ICEIN [68](#)
 ICHLQ [69](#)
 ICID [69](#)
 ICMID [69](#)
 ICNUM [70](#)
 ICTRLR [70](#)
 ICVOLCT [72](#)
 IDXBLD.MAXTASKS [72](#)
 IDXBLD.SORTFSZ [73](#)
 IMSID [73](#)
 INITIALIZE [74](#)
 ITKBDATA [74](#)
 ITKBSERVER [75](#)
 KEYLABEL [75](#)
 LOG1DSN [75](#)
 LOG2DSN [76](#)
 LOGICALDBD [77](#)
 LOGPRI [77](#)
 LOGSEC [77](#)
 MGMTCLAS [78](#)
 MONITOR [78](#)
 NEWDBD [78](#)
 ONLINECHANGE [79, 100](#)

keywords (*continued*)

OPTID [79](#)
PARTITION [80](#)
PARTLIST [80](#)
PARTNUM [81](#)
PRERES.ALLOWLC [81](#)
PRERES.ALLOWLP [82](#)
PRERES.AVGRLN [82](#)
PRERES.FILSZ [82](#)
PRERES.HPPRBH [83](#)
PRERES.OPRTLCL [83](#)
PRERES.OPRTLPL [83](#)
PRERES.UPDLPC [84](#)
PRERES.XAVGRLN [84](#)
PRERES.XFILSZ [84](#)
PSINDEXBLD [85](#)
PTRCHECK [85](#)
READON [86](#)
READONLY [86](#)
RELOAD.DBIOBUF [86](#)
RELOAD.DBRLBUF [87](#)
RELOAD.FRSPC [87](#)
RELOAD.HPIO [87](#)
RELOAD.OADSPR [88](#)
RELOAD.RAAFORMAT [88](#)
RELOAD.SEARCH [89](#)
RELOAD.SORT [89](#)
RELOAD.USEREXIT [89](#)
RELOAD.WF1HLQ [90](#)
RELOAD.WF1SPACE [90](#)
RELOAD.WF1UNIT [91](#)
RELOAD.WF1VOL [91](#)
RELOAD.WFPHLQ [92](#)
RELOAD.WFPSPACE [92](#)
RELOAD.WFPUNIT [92](#)
RELOAD.WFPVOL [93](#)
RELOAD.WFPVOLCNT [93](#)
required for HRFSYSIN DD [46](#)
RESTART [94](#)
SASJOBPREF [94](#)
SASMAX [95](#)
SHADOW [95](#)
SORTNUM [96](#)
STORCLAS [96](#)
TAKEOVER [96](#)
TAKEOVER.WINDOW [97](#)
TEMPRECOV [98](#)
UNLSPAC [98](#)
UNLUNIT [99](#)
VOLALLO [99](#)

L

legal notices

cookie policy [191](#)
notices [191](#)
programming interface information [191](#)
trademarks [191](#)

length of DBDS names [36](#)

log recovery [17](#)

LOG1DSN keyword [75](#)

LOG2DSN keyword [76](#)

LOGDATAC HRFSETOP option [120](#)

LOGHLQ HRFSETOP option [120](#)

logical relationships, internal [1](#)

LOGICALDBD keyword [77](#)

LOGKYLBL HRFSETOP option [120](#)

LOGMGMTC HRFSETOP option [120](#)

LOGPRI keyword [77](#)

LOGSEC keyword [77](#)

LOGSTORC HRFSETOP option [120](#)

LOGUNIT HRFSETOP option [120](#)

M

maintenance

installation utility [132](#)

MGMTCLAS keyword [78](#)

MONITOR keyword [78](#)

MSGPRINT data set [11](#)

MSGPRINT DD statement [43](#)

N

NEWDBD DD statement [44](#)

NEWDBD keyword [78](#)

NEXTDAY TAKEOVER.WINDOW action [97](#)

notices [191](#)

notifying DBRC [17](#)

NOTINIT HRFSETOP option [120](#)

O

ODBA access, controlling [14](#)

one-step reorganization [11](#)

online change [100](#)

ONLINECHANGE [73](#)

ONLINECHANGE keyword [79](#), [100](#)

OPTID keyword [79](#)

options, environment setup [119](#)

options, HRFSETOP [120](#)

out-of-sync [100](#)

P

PARTITION keyword [80](#)

PARTLIST keyword [80](#)

PARTNUM keyword [81](#)

pause

job [12](#), [126](#)

phases of IMS Online Reorganization Facility

apply [17](#)

completion [17](#)

copy [17](#)

reorganization [17](#)

takeover [17](#)

verification [17](#)

PHIDAM database JCL sample [107](#), [108](#)

PRERES.ALLOWLC keyword [81](#)

PRERES.ALLOWLP keyword [82](#)

PRERES.AVGRLN keyword [82](#)

PRERES.FILSZ keyword [82](#)

PRERES.HPPRBH keyword [83](#)

PRERES.OPRTLCL keyword [83](#)

PRERES.OPRTLPL keyword [83](#)

PRERES.UPDLPC keyword [84](#)

PRERES.XAVGRLN keyword [84](#)

PRERES.XFILSZ keyword [84](#)
problems
 diagnostic information about [189](#)
PROCLIB DD statement [44](#)
programming interface information [191](#)
PROHIBIT AUTH
 DBRC [11](#)
 status [17](#)
prohibit authorization [100](#)
PSINDEX [10](#)
PSINDEXBLD keyword [85](#)
PTRCHECK keyword [85](#)

R

RCDATA HRFSETOP option [120](#)
RCMGMT HRFSETOP option [120](#)
RCSTORC HRFSETOP option [120](#)
RCVOL HRFSETOP option [120](#)
reader comment form [33](#)
READON keyword [86](#)
READONLY keyword [86](#)
RECON DD statement [44](#)
RECON HRFSETOP option [120](#)
recovery, log [17](#)
region types [27](#)
relationships, internal logical [1](#)
RELOAD.DBIOBUF keyword [86](#)
RELOAD.DBRLBUF keyword [87](#)
RELOAD.FRSPC keyword [87](#)
RELOAD.HPIO keyword [87](#)
RELOAD.OADSPR keyword [88](#)
RELOAD.RAAFORMAT keyword [88](#)
RELOAD.SEARCH keyword [89](#)
RELOAD.SORT keyword [89](#)
RELOAD.USEREXIT keyword [89](#)
RELOAD.WF1HLQ keyword [90](#)
RELOAD.WF1SPACE keyword [90](#)
RELOAD.WF1UNIT keyword [91](#)
RELOAD.WF1VOL keyword [91](#)
RELOAD.WFPHLQ keyword [92](#)
RELOAD.WFPSPACE keyword [92](#)
RELOAD.WFPUNIT keyword [92](#)
RELOAD.WFPVOL keyword [93](#)
RELOAD.WFPVOLCNT keyword [93](#)
REORG command [46](#)
reorganization of a PSINDEX partition JCL sample [108](#)
Reorganization phase [17](#)
reorganize and generate Diagnosis report JCL sample [111](#)
replacement
 ACBLIB or DMB [17](#)
 DBD and ACB or DMB [11](#)
replacement DMB [100](#)
replacing a DMB [11](#)
reports
 reorganization progress [11](#)
 statistical [11](#)
required keywords, HRFSYSIN DD [46](#)
RESTART
 data set [100](#)
 option [100](#)
RESTART keyword [94](#)
restart processing [11](#)
restrictions [27](#)

RSTRTDSN HRFSETOP option [120](#)

S

sample library members
 overview [131](#)
SASJOBPREF keyword [94](#)
SASMAX keyword [95](#)
scheduling online reorganization [102](#)
screen readers and magnifiers [34](#)
secondary indexes [10](#)
service information [32](#)
setup
 options, environment [120](#)
shadow data set
 deletion of [17](#)
 primary index [17](#)
SHADOW keyword [95](#)
SORTNUM keyword [96](#)
statement
 DD [36](#)
 EXEC [35](#)
statistic reports [11](#)
STEPLIB DD statement [45](#)
STORCLAS keyword [96](#)
subordinate address space [125](#)
summary of changes [4](#)
support
 required information [189](#)
support information [32](#)
swap of databases [17](#)
syntax [46](#)
syntax diagrams
 how to read [134](#)
SYSPRINT DD statement [45](#)
SYSUDUMP DD statement [45](#)

T

TAKEOVER HRFSETOP option [120](#)
TAKEOVER keyword [96](#)
Takeover phase [17](#)
Takeover restart [11](#), [100](#)
Takeover Restart utility [17](#)
TAKEOVER.WINDOW keyword
 actions [97](#)
technotes [33](#)
TEMPRECOV keyword [98](#)
terminology [2](#)
TOIGROUP HRFSETOP option [120](#)
TRACE DD statement [46](#)
trademarks [191](#)
troubleshooting IMS Online Reorganization Facility
 connections
 cause [137](#)
 description [137](#)
 solution [137](#)
 symptoms [137](#)
types of databases
 supported by IMS Online Reorganization Facility [10](#)

U

- ULOGID HRFSETOP option [120](#)
- UNITPOOL HRFSETOP option [120](#)
- UNLMAXRC HRFSETOP option [120](#)
- unload [10](#)
- UNLOAD command [46](#)
- UNLOAD command valid keywords [46](#)
- UNLOAD sample JCL [46](#)
- unloading a HIDAM OSAM database JCL sample [108](#)
- UNLSPAC HRFSETOP option [120](#)
- UNLSPAC keyword [98](#)
- UNLUNIT HRFSETOP option [120](#)
- UNLUNIT keyword [99](#)
- utilities
 - debug test [132](#)
 - maintenance installation [132](#)
 - related to IMS Online Reorganization Facility [1](#)
 - Takeover Restart [17](#)

V

- valid keywords for the UNLOAD command [46](#)
- Verification phase [17](#)
- VOLALLO keyword [99](#)
- VOLPOOL HRFSETOP option [120](#)

W

- WFHLQ HRFSETOP option [120](#)
- WFUNIT HRFSETOP option [120](#)
- what's new [4](#), [32](#)
- WTOR TAKEOVER.WINDOW action [97](#)

X

- XCFGROUP HRFSETOP option [120](#)
- XCFMAX HRFSETOP option [120](#)
- XCFRETRY HRFSETOP option [120](#)



Product Number: 5655-DSP

SC27-9039-13

