

IBM z/OS Debugger
16.0.5

Customization Guide



Note!

Before using this information and the product it supports, be sure to read the general information under [“Notices” on page 215.](#)

Sixth Edition (June 2024)

This edition applies to IBM® z/OS® Debugger, 16.0.5 (Program Number 5724-T07 with the PTF for PH60292), which supports the following compilers:

- Open Enterprise SDK for Go 1.21 and 1.22 (Program Number 5655-GOZ)
- Open XL C/C++ for z/OS 1.1 (Program Number 5650-ZOS)
- z/OS XL C/C++ Version 2 (Program Number 5650-ZOS)
- C/C++ feature of z/OS Version 1 (Program Number 5694-A01)
- C/C++ feature of OS/390® (Program Number 5647-A01)
- C/C++ for MVS/ESA Version 3 (Program Number 5655-121)
- AD/Cycle C/370 Version 1 Release 2 (Program Number 5688-216)
- Enterprise COBOL for z/OS 6.1, 6.2, 6.3, and 6.4 (Program Number 5655-EC6)
- Enterprise COBOL for z/OS Version 5 (Program Number 5655-W32)
- Enterprise COBOL for z/OS Version 4 (Program Number 5655-S71)
- Enterprise COBOL for z/OS and OS/390 Version 3 (Program Number 5655-G53)
- COBOL for OS/390 & VM Version 2 (Program Number 5648-A25)
- COBOL for MVS™ & VM Version 1 Release 2 (Program Number 5688-197)
- COBOL/370 Version 1 Release 1 (Program Number 5688-197)
- VS COBOL II Version 1 Release 3 and Version 1 Release 4 (Program Numbers 5668-958, 5688-023) - with limitations
- OS/VS COBOL, Version 1 Release 2.4 (5740-CB1) - with limitations
- High Level Assembler for MVS & VM & VSE Version 1 Release 4, Version 1 Release 5, Version 1 Release 6 (Program Number 5696-234)
- Enterprise PL/I for z/OS 6.1 (Program Number 5655-PL6)
- Enterprise PL/I for z/OS Version 5 Release 1, Release 2, and Release 3 (Program Number 5655-PL5)
- Enterprise PL/I for z/OS Version 4 (Program Number 5655-W67)
- Enterprise PL/I for z/OS and OS/390 Version 3 (Program Number 5655-H31)
- VisualAge® PL/I for OS/390 Version 2 Release 2 (Program Number 5655-B22)
- PL/I for MVS & VM Version 1 Release 1 (Program Number 5688-235)
- OS PL/I Version 2 Release 1, Version 2 Release 2, Version 2 Release 3 (Program Numbers 5668-909, 5668-910) - with limitations

This edition also applies to all subsequent releases and modifications until otherwise indicated in new editions or technical newsletters.

You can find out more about IBM z/OS Debugger by visiting the following IBM Web sites:

- IBM Debug for z/OS: <https://www.ibm.com/products/debug-for-zos>
- IBM Developer for z/OS: <https://www.ibm.com/products/developer-for-zos>
- IBM Z and Cloud Modernization Stack: <https://www.ibm.com/docs/z-modernization-stack>

© **Copyright International Business Machines Corporation 1992, 2024.**

US Government Users Restricted Rights – Use, duplication or disclosure restricted by GSA ADP Schedule Contract with IBM Corp.

Contents

About this document.....	ix
Who might use this document.....	ix
Accessing z/OS licensed documents on the Internet.....	ix
How this document is organized.....	x
Terms used in this document.....	x
How to read syntax diagrams.....	xii
Symbols.....	xii
Syntax items.....	xii
Syntax examples.....	xii
How to provide your comments.....	xiv
What's new in IBM z/OS Debugger.....	xv
What's removed from IBM z/OS Debugger.....	xx
Overview of IBM z/OS Debugger.....	xxiii
Chapter 1. Customizing z/OS Debugger: checklist.....	1
Requisite products.....	5
Chapter 2. Product Registration.....	7
Registering z/OS Debugger.....	7
Removing old registrations.....	8
Chapter 3. Installing the z/OS Debugger SVCs.....	9
Verifying the installation of the SVCs.....	10
Checking the level of the z/OS Debugger SVCs.....	10
Running the installation verification programs for SVCs.....	10
Using the Authorized Debug facility for protected programs.....	11
Chapter 4. Setting up the APF-authorized system link list data set (SEQABMOD)...	13
Chapter 5. Setting up the link list data set (SEQAMOD).....	15
Chapter 6. Enabling debugging in full-screen mode using the Terminal Interface Manager.....	17
How users start a full-screen mode debug session with the Terminal Interface Manager.....	17
Enabling full-screen mode using the Terminal Interface Manager.....	19
Defining the VTAM EQAMVnnn APPL definition statements.....	19
Defining the Terminal Interface Manager APPL definition statements.....	20
Starting the Terminal Interface Manager.....	21
Verifying the enablement of full-screen mode using the Terminal Interface Manager.....	22
Example: Defining the VTAM EQAMVnnn and Terminal Interface Manager APPL definition statements when z/OS Debugger runs on four LPARs.....	23
Chapter 7. Adding support for remote debug users.....	25
Activating the TCP/IP Socket Interface for CICS.....	25
Enabling communication with Debug Manager.....	25
Debug Manager configuration.....	26
Debug Manager configuration reference.....	34

Adding support for Remote Debug Service.....	52
Installing Remote Debug Service.....	53
Customizing with the sample job EQARMTSU.....	53
Customizing the system PROCLIB.....	55
Remote Debug Service security definitions.....	56
Updating PARMLIB to start Remote Debug Service during IPL.....	58
Starting and stopping Remote Debug Service dynamically.....	58
Adding support for Debug Profile Service.....	58
Installing Debug Profile Service.....	59
Customizing with the sample job EQAPRFSU.....	60
Configuring the server.....	60
Adding support for Debug Profile Service API.....	67
Adding support for IMS Transaction Isolation Service API.....	72
Starting and stopping the server.....	73
Managing profiles with z/OS Debugger Profile Management.....	75
Debug Profile Service diagnostics.....	76
Enabling secure communication between z/OS Debugger and the remote debugger for incoming debug sessions.....	77

Chapter 8. Specifying the TEST runtime options through the Language

Environment user exit.....	81
Editing the source code of CEEBXITA.....	82
Modifying the naming pattern.....	82
Modifying the message display level.....	83
Modifying the call back routine registration.....	84
Activate the cross reference function and modifying the cross reference table data set name.....	84
Comparing the two methods of linking CEEBXITA.....	84
Linking the CEEBXITA user exit into a private copy of a Language Environment runtime module.....	85
Creating and managing the TEST runtime options data set.....	85

Chapter 9. Installing the browse mode RACF facility.....87

Choose and install appropriate RACF facility.....	87
Set up user access to facility.....	88

Chapter 10. Customizing IBM z/OS Debugger Utilities.....89

Choosing a method to start IBM z/OS Debugger Utilities.....	90
Customizing the data set names in EQASTART.....	91
Adding IBM z/OS Debugger Utilities to the ISPF menu.....	92
Customizing z/OS Debugger Setup Utility.....	92
Customizing for JCL for Batch Debugging utility.....	92
Parameters you can set.....	93
Customizing JCL for Batch Debugging for multiple systems.....	94
Customizing for Other IBM Application Delivery Foundation for z/OS tools.....	94
Parameters you can set.....	95
Customizing Other IBM Application Delivery Foundation for z/OS tools for multiple systems.....	95
Customizing Program Preparation.....	96
Parameters you can set.....	96
Customizing Program Preparation for multiple systems.....	98
Configuring for IMSplex users.....	98
Customizing z/OS Debugger User Exit Data Set.....	99
Customizing IMS BTS Debugging.....	100
Customizing Delay Debug Profile.....	102
Customizing IMS Transaction and User ID Cross Reference Table	102
Customizing Non-CICS Debug Session Start and Stop Message Viewer	103
Customizing z/OS Debugger Code Coverage.....	104
Installing and customizing z/OS Debugger JCL Wizard.....	105

Chapter 11. Preparing your environment to debug Db2 stored procedures.....	107
Chapter 12. Adding support for debugging under CICS.....	109
Activating CICS non-Language Environment exits.....	113
Storing DTCN debug profiles in a VSAM file.....	114
Migrating a debug profiles VSAM file from an earlier release.....	114
Sharing DTCN debug profile repository among CICS systems.....	114
Deleting or deactivating debug profiles stored in a VSAM data set.....	117
Deleting DTCN profiles with the DTCN LINK service.....	118
Requiring users to specify resource types.....	119
Direct QSAM access through a CICS task-related user exit.....	119
Running multiple debuggers in a CICS region.....	119
Running the installation verification programs in a CICS region.....	120
Configuring z/OS Debugger to run in a CICSplex environment.....	120
Terminal connects to an AOR that runs the application.....	120
Terminal connects to a TOR which routes the application to an AOR; debugging profiles managed by DTCN.....	121
Terminal connects to an AOR that runs an application that does not use a terminal.....	122
Screen control mode terminal connects to a TOR and application runs in an AOR.....	122
Separate terminal mode terminal connects to a TOR and application runs in an AOR.....	123
Authorizing DTST transaction to modify storage.....	124
Authorizing DTCN and DTCI transactions to delete or deactivate debug profiles.....	125
Chapter 13. Adding support for debugging under IMS.....	127
Scenario A: Running IMS and managing TEST runtime options with a user exit.....	128
Scenario B: Running IMS and managing TEST runtime options with CEEUOPT or CEEROPT.....	128
Scenario C: Running assembler program without Language Environment in IMS TM and managing TEST runtime options with EQASET.....	129
Scenario D: Running IMSplex environment.....	129
Scenario F: Enabling the Transaction Isolation Facility.....	130
Sample customization of the IMS Transaction Isolation Facility.....	134
Batch interface for the IMS Transaction Isolation Facility.....	139
Configuring the IMS Transaction Isolation Service API for Debug Profile Service.....	140
Installing and configuring the IMS transaction isolation extension for the ADFz Common Components server.....	141
Chapter 14. Enabling the EQAUEDAT user exit.....	143
Chapter 15. Using EQACUIDF to specify values for NATLANG, LOCALE, and LINECOUNT.....	145
Changing the default and allowable values in EQACUIDF.....	145
Enabling additional languages for some z/OS Debugger components through EQACUIDF.....	146
Chapter 16. EQAOPTS commands.....	147
Format of the EQAOPTS command.....	153
EQAOPTS commands that have equivalent z/OS Debugger commands.....	154
Providing EQAOPTS commands at run time.....	155
Creating EQAOPTS load module.....	155
Descriptions of EQAOPTS commands.....	156
ALTDISP.....	156
BROWSE.....	156
CACHENUM.....	157
CCOUTPUTDSN.....	157
CCOUTPUTDSNALLOC.....	157
CCPROGSELECTDSN.....	158

CEEREACTAFTERQDBG.....	159
CICSASMPGMND.....	159
CODEPAGE.....	160
COMMANDSDSN.....	162
DEFAULTVIEW.....	162
DISABLERLIM.....	163
DLAYDBG.....	163
DTCNDELETEDEADPROF.....	166
DTCNFORCExxxx.....	167
DYNDEBUG.....	168
EQAQPP.....	168
EXPLICITDEBUG.....	169
GPFDSN.....	169
HOSTPORTS.....	170
IGNOREEODOLIMIT.....	170
IMSISOORIGPSB.....	171
LDDAUTOLANGX.....	171
LOGDSN.....	172
LOGDSNALLOC.....	173
MAXTRANUSER.....	174
MDBG.....	174
MULTIPROCESS.....	175
NAMES.....	176
NODISPLAY.....	176
PREFERENCESDSN.....	177
SAVEBPDSN, SAVESETDSN.....	178
SAVESETDSNALLOC, SAVEBPDSNALLOC.....	178
SESSIONTIMEOUT.....	180
STARTSTOPMSG.....	180
SUBSYS.....	182
SVCSCREEN.....	182
TCPIPDATADSN.....	185
THREADTERMCOND.....	186
TIMACB.....	186
END.....	187

Appendix A. SMP/E USERMODs..... 189

Appendix B. Enabling debugging in full-screen mode using a dedicated terminal. 191

How z/OS Debugger uses full-screen mode using a dedicated terminal.....	191
Enabling full-screen mode using a dedicated terminal.....	192
Defining the VTAM EQAMVnnn APPL definition statements.....	192
Defining terminal LUs used by z/OS Debugger.....	194
Configuring the TN3270 Telnet Server to access the terminal LUs.....	195
Example: Activating full-screen mode using a dedicated terminal when using TCP/IP TN3270	
Telnet Server.....	196
Defining z/OS Debugger to VTAM.....	197
Defining the terminals used by z/OS Debugger.....	197
Configuring the TN3270 Telnet Server.....	197
Verifying the customization of the facility to debug full-screen mode using a dedicated terminal.....	199
Using z/OS Debugger Terminal Interface Manager as a dedicated terminal.....	200
Example: a debugging session using the z/OS Debugger Terminal Interface Manager.....	200
Enabling full-screen mode using a dedicated terminal with z/OS Debugger Terminal Interface	
Manager.....	201
Defining the Terminal Interface Manager APPL definition statements.....	202
Starting the z/OS Debugger Terminal Interface Manager as a dedicated terminal.....	202
Configuring the TN3270 Telnet Server to access the Terminal Interface Manager.....	203

Example: Connecting a VTAM network with multiple LPARs with one Terminal Interface Manager.....	204
Running the Terminal Interface Manager on more than one LPAR on the same VTAM network.....	204
Configuring Terminal Interface Manager as an IBM Session Manager application.....	205
Verifying the customization of the Terminal Interface Manager.....	206
Appendix C. Applying maintenance.....	207
Applying Service APAR or PTF.....	207
What you receive.....	207
Checklist for applying an APAR or PTF.....	207
Appendix D. Support resources and problem solving information.....	209
Accessing the IBM Support portal.....	209
Getting fixes.....	209
Subscribing to support updates.....	209
Contacting IBM Support.....	210
Determine the business impact of your problem.....	210
Gather diagnostic information.....	210
Submit the problem to IBM Support.....	211
Appendix E. Accessibility.....	213
Using assistive technologies	213
Keyboard navigation of the user interface.....	213
Accessibility of this document.....	213
Notices.....	215
Trademarks and service marks.....	215
Glossary.....	217
IBM z/OS Debugger publications.....	221
Index.....	223

About this document

z/OS Debugger combines the richness of the z/OS environment with the power of Language Environment® to provide a debugger for programmers to isolate and fix their program bugs and test their applications. z/OS Debugger gives you the capability of testing programs in batch, using a nonprogrammable terminal in full-screen mode, or using a workstation interface to remotely debug your programs.

This document describes the tasks you must do to customize z/OS Debugger. You can use [IBM Host Configuration Assistant for Z Development](#) to generate a customized checklist for z/OS Debugger, and then refer to this guide for more details. [IBM Host Configuration Assistant for Z Development](#) is an interactive wizard that is designed to simplify planning and configuring of Z development products. Besides z/OS Debugger, you can also find the configuration information for other host components like z/OS Explorer and z/OS Source Code Analysis. Only the latest product releases are supported.

Who might use this document

This document is intended for system programmers who need to customize z/OS Debugger.

z/OS Debugger runs on the z/OS operating system and supports the following subsystems:

- CICS®
- Db2®
- IMS
- JES batch
- TSO
- UNIX System Services in remote debug mode or full-screen mode using the Terminal Interface Manager only

Accessing z/OS licensed documents on the Internet

z/OS licensed documentation is available on the Internet in PDF format at the IBM Resource Link® Web site at:

<http://www.ibm.com/servers/resourcelink>

Licensed documents are available only to customers with a z/OS license. Access to these documents requires an IBM Resource Link user ID and password, and a key code. With your z/OS order you received a Memo to Licensees, (GI10-8928), that includes this key code.

To obtain your IBM Resource Link user ID and password, log on to:

<http://www.ibm.com/servers/resourcelink>

To register for access to the z/OS licensed documents:

1. Sign in to Resource Link using your Resource Link user ID and password.
2. Select **User Profiles** located on the left-hand navigation bar.

Note: You cannot access the z/OS licensed documents unless you have registered for access to them and received an e-mail confirmation informing you that your request has been processed.

Printed licensed documents are not available from IBM.

You can use the PDF format on either **z/OS Licensed Product Library CD-ROM** or IBM Resource Link to print licensed documents.

How this document is organized

Note: Chapter 4, 6, 10, 15, and Appendix B are not applicable to IBM Developer for z/OS (non-Enterprise Edition), IBM Z and Cloud Modernization Stack (Wazi Code).

This document is divided into areas of similar information for easy retrieval of appropriate information.

- Chapter 1. Customizing z/OS Debugger: checklist
- Chapter 2. Product Registration
- Chapter 3. Installing the z/OS Debugger SVCs
- Chapter 4. Setting up the APF-authorized system link list data set (SEQABMOD)
- Chapter 5. Setting up the link list data set (SEQAMOD)
- Chapter 6. Enabling debugging in full-screen mode using the Terminal Interface Manager
- Chapter 7. Adding support for remote debug users
- Chapter 8. Specifying the TEST runtime options through the Language Environment user exit
- Chapter 9. Installing the browse mode RACF[®] facility
- Chapter 10. Customizing IBM z/OS Debugger Utilities
- Chapter 11. Preparing your environment to debug Db2 stored procedures
- Chapter 12. Adding support for debugging under CICS
- Chapter 13. Adding support for debugging under IMS
- Chapter 14. Enabling the EQAUEDAT user exit
- Chapter 15. Using EQACUIDF to specify values for NATLANG, LOCALE, and LINECOUNT
- Chapter 16. EQAOPTS commands
- Appendix A. SMP/E USERMODs
- Appendix B. Enabling debugging in full-screen mode using a dedicated terminal
- Appendix C. Applying maintenance
- Appendix D. Support resources and problem solving information
- Appendix E. Accessibility

The last several topics list notices, bibliography, and glossary of terms.

Terms used in this document

Because of differing terminology among the various programming languages supported by z/OS Debugger, as well as differing terminology between platforms, a group of common terms is established. The following table lists these terms and their equivalency in each language.

z/OS Debugger term	C and C++ equivalent	COBOL or LangX COBOL equivalent	PL/I equivalent	assembler
Compile unit	C and C++ source file	Program	<ul style="list-style-type: none">• Program• PL/I source file for Enterprise PL/I• A package statement or the name of the main procedure for Enterprise PL/I¹	CSECT

z/OS Debugger term	C and C++ equivalent	COBOL or LangX COBOL equivalent	PL/I equivalent	assembler
Block	Function or compound statement	Program, nested program, method, or PERFORM group of statements	Block	CSECT
Label	Label	Paragraph name or section name	Label	Label

Note:

1. The PL/I program must be compiled with and run in one of the following environments:
 - Compiled with Enterprise PL/I for z/OS, Version 3.6 or later
 - Compiled with Enterprise PL/I for z/OS, Version 3.5, with the PTFs for APARs PK35230 and PK35489 applied

z/OS Debugger provides facilities that apply only to programs compiled with specific levels of compilers. Because of this, this document uses the following terms:

assembler

Refers to assembler programs with debug information assembled by using the High Level Assembler (HLASM).

COBOL

Refers to the all COBOL compilers supported by z/OS Debugger except the COBOL compilers described in the term *LangX COBOL*.

Disassembly or disassembled

Refers to high-level language programs compiled without debug information or assembler programs without debug information. The debugging support z/OS Debugger provides for these programs is through the disassembly view.

Enterprise PL/I

Refers to the Enterprise PL/I for z/OS and OS/390 and the VisualAge PL/I for OS/390 compilers.

LangX COBOL

Refers to any of the following COBOL programs that are supported through use of the EQALANGX debug file:

- Programs compiled using the IBM OS/VS COBOL compiler.
- Programs compiled using the VS COBOL II compiler with the NOTEST compiler option.
- Programs compiled using the Enterprise COBOL for z/OS V3 and V4 compiler with the NOTEST compiler option.

When you read through the information in this document, remember that OS/VS COBOL programs are non-Language Environment programs, even though you might have used Language Environment libraries to link and run your program.

VS COBOL II programs are non-Language Environment programs when you link them with the non-Language Environment library. VS COBOL II programs are Language Environment programs when you link them with the Language Environment library.

Enterprise COBOL programs are always Language Environment programs. Note that COBOL DLL's cannot be debugged as LangX COBOL programs.

Read the information regarding non-Language Environment programs for instructions on how to start z/OS Debugger and debug non-Language Environment COBOL programs, unless information specific to LangX COBOL is provided.

PL/I

Refers to all levels of PL/I compilers. Exceptions will be noted in the text that describe which specific PL/I compiler is being referenced.

How to read syntax diagrams

This section describes how to read syntax diagrams. It defines syntax diagram symbols, items that may be contained within the diagrams (keywords, variables, delimiters, operators, fragment references, operands) and provides syntax examples that contain these items.

Syntax diagrams pictorially display the order and parts (options and arguments) that comprise a command statement. They are read from left to right and from top to bottom, following the main path of the horizontal line.

Symbols

The following symbols may be displayed in syntax diagrams:

Symbol	Definition
--------	------------



Indicates the beginning of the syntax diagram.



Indicates that the syntax diagram is continued to the next line.



Indicates that the syntax is continued from the previous line.



Indicates the end of the syntax diagram.

Syntax items

Syntax diagrams contain many different items. Syntax items include:

- Keywords - a command name or any other literal information.
- Variables - variables are italicized, appear in lowercase and represent the name of values you can supply.
- Delimiters - delimiters indicate the start or end of keywords, variables, or operators. For example, a left parenthesis is a delimiter.
- Operators - operators include add (+), subtract (-), multiply (*), divide (/), equal (=), and other mathematical operations that may need to be performed.
- Fragment references - a part of a syntax diagram, separated from the diagram to show greater detail.
- Separators - a separator separates keywords, variables or operators. For example, a comma (,) is a separator.

Keywords, variables, and operators may be displayed as required, optional, or default. Fragments, separators, and delimiters may be displayed as required or optional.

Item type	Definition
-----------	------------

Required	Required items are displayed on the main path of the horizontal line.
-----------------	---



Optional	Optional items are displayed below the main path of the horizontal line.
-----------------	--

Default	Default items are displayed above the main path of the horizontal line.
----------------	---

Syntax examples

The following table provides syntax examples.

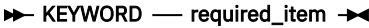
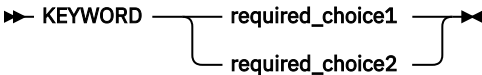
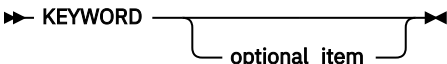
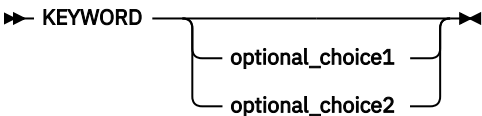
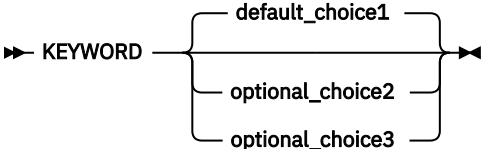
Table 1. Syntax examples

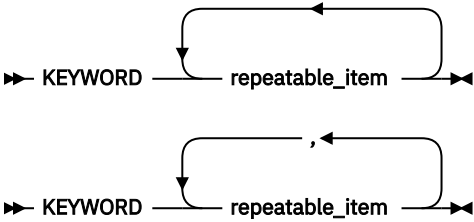
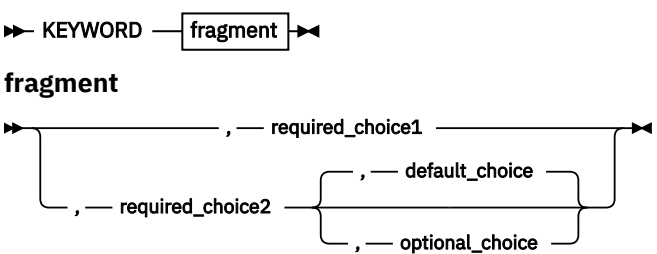
Item	Syntax example
<p>Required item.</p> <p>Required items appear on the main path of the horizontal line. You must specify these items.</p>	
<p>Required choice.</p> <p>A required choice (two or more items) appears in a vertical stack on the main path of the horizontal line. You must choose one of the items in the stack.</p>	
<p>Optional item.</p> <p>Optional items appear below the main path of the horizontal line.</p>	
<p>Optional choice.</p> <p>An optional choice (two or more items) appears in a vertical stack below the main path of the horizontal line. You may choose one of the items in the stack.</p>	
<p>Default.</p> <p>Default items appear above the main path of the horizontal line. The remaining items (required or optional) appear on (required) or below (optional) the main path of the horizontal line. The following example displays a default with optional items.</p>	
<p>Variable.</p> <p>Variables appear in lowercase italics. They represent names or values.</p>	
<p>Repeatable item.</p> <p>An arrow returning to the left above the main path of the horizontal line indicates an item that can be repeated.</p> <p>A character within the arrow means you must separate repeated items with that character.</p> <p>An arrow returning to the left above a group of repeatable items indicates that one of the items can be selected, or a single item can be repeated.</p>	
<p>Fragment.</p> <p>The — fragment — symbol indicates that a labelled group is described below the main syntax diagram. Syntax is occasionally broken into fragments if the inclusion of the fragment would overly complicate the main syntax diagram.</p>	

How to provide your comments

Your feedback is important in helping us to provide accurate, high-quality information. If you have comments about this document or any other z/OS Debugger documentation, you can leave a comment in [IBM Documentation](#):

- IBM Developer for z/OS and IBM Developer for z/OS Enterprise Edition: <https://www.ibm.com/docs/developer-for-zos>
- IBM Debug for z/OS: <https://www.ibm.com/docs/debug-for-zos>
- IBM Z and Cloud Modernization Stack: <https://www.ibm.com/docs/z-modernization-stack>

When you send information to IBM, you grant IBM a nonexclusive right to use or distribute the information in any way it believes appropriate without incurring any obligation to you.

What's new in IBM z/OS Debugger

16.0.5

New support

- Support is added for CICS Transaction Server for z/OS 6.2.

Debug Profile Service

- The configuration section was refactored to provide better experience. For more information, see [Adding support for Debug Profile Service](#).
- The default number of requests per second to allow or deny into the Debug Profile Service (`requestsPerSec`) is increased from 20 to 1000. For more information, see [Customizing the `eqaprof.env` file](#).
- A new optional property `corAllowedOrigins` is added to define the allowed origins for Cross-Origin Resource Sharing (CORS). For more information, see [Customizing the `eqaprof.env` file](#) and [Customizing the `eqaprof.env` file](#).

16.0.4

New support

- Support is added for IBM Open Enterprise SDK for Go 1.22.
- LangX COBOL now includes programs compiled with Enterprise COBOL for z/OS 6.

IBM Z® Open Debug 4.0

- Zowe Explorer is now the prerequisite. If it was not installed previously, when you install Z Open Debug 4.0, Zowe Explorer is installed automatically.
- Instead of installing two extensions, now you need to install only one extension: IBM Z Open Debug (`zopendebug-<version>.vsix`)
- Connections to the remote z/OS machine are now defined as `zOpenDebug` connection profiles in the Zowe team configuration file. A connection profile is created automatically based on the values you specified in Settings when you migrate to Z Open Debug 4.0. You can create multiple Zowe connection profiles to switch from one connection to another.
- The **Z Open Debug Profiles** view is now renamed as **z/OS Debugger Profiles** view and integrated into Zowe Explorer. If you installed an earlier version of the extension for IBM Z Open Debug Profiles view and have profiles in that view, when you install Z Open Debug 4.0, the profiles can be automatically migrated and the IBM Z Open Debug Profiles view will be uninstalled.
- The logging information previously available in the user's home directory is now available in the **Output** panel. Select **IBM Z Open Debug** from the list to filter out relevant log.
- You can no longer get the Debug profile Service URL from the Developer Tools window. Open a browser and visit the URL directly at: `{host_name}:{dps_port}/api/v1/profile/dtcn}`.

For more information, see "Migrating from Z Open Debug v3 to v4", "Setting up for IBM Z Open Debug", and "Creating and managing debug profiles with Z Open Debug" in [IBM Documentation](#).

Debug Profile Service

- Debug Profile Service can now be used with Java 17, but IBM z/OS Liberty Embedded 23.0.0.12 or later is required.

Debug Manager

- You can now configure Debug Manager by using environment variables. For more information, see [Running Debug Manager as a started task by using environment variables](#).

- You can now set the **TRUSTEDTCP** parameter to ON so that Debug Manager supports authentication of other Debug Manager instances connecting to its hub port using trusted TCP. For more information, see [Trusted TCP authentication for sysplex connections](#).
- An example is added to show an overview of how an Eclipse client connects and communicates to the system in a DVIPA environment with multiple LPARs. For more information, see [Distributed Dynamic VIPA: Communication example](#).

16.0.3

New support

- Support is added for z/OS 3.1.
- Support is added for IMS 15.4.
- Support is added for CICS Transaction Server for z/OS 6.2 (open beta).
- Support is added for IBM Open Enterprise SDK for Go 1.21.

Code Coverage

- In the code coverage report, you can switch to the tree view for a graphical representation of the hierarchy of files, modules, and flow points. In this tree view, you can click the name beside any node to open the source in the editor. For more information, see "Viewing coverage information in the tree view" in [IBM Documentation](#).
- You can now optimize collection to include only the modules being tested by ZUnit with the `z`, `zunit` parameters. For more information, see "Starting and stopping the headless code coverage collector" and "Specifying code coverage options in the startup key" in [IBM Documentation](#).

Eclipse debugger

- When you debug CICS applications, you can now specify `QUIT DEBUG` or `QUIT DEBUG TASK` in the z/OS Debugger Preferences page. For more information, see "Setting debug preferences" in [IBM Documentation](#).
- During playback, the **Variables** view now displays values collected during recording. Variables cannot be updated during replay. For more information, see "Using the Playback toolbar" in [IBM Documentation](#).

IMS Transaction Isolation

- You can perform any operation from a single connection and IMS Transaction Isolation facility will notify other LPARs of the configuration changes. For more information, see "Using IMS Transaction Isolation to create a private message-processing region and select transactions to debug" in *IBM z/OS Debugger User's Guide* and ["Scenario F: Enabling the Transaction Isolation Facility"](#) on page 130.
- The EQAZDFLT settings are now used when you start the IMS Transaction Isolation Facility with the batch interface, Debug Profile Service and ADFz Common Components server, as they already are with the z/OS Debugger Utilities. For more information, see ["Scenario F: Enabling the Transaction Isolation Facility"](#) on page 130.

EQANDBG

- EQANDBG is now available as an alias of EQANMDBG. It passes the unmodified input parameter list to the application and collects all debugger parameters from EQANMDBG DD. For more information, see "Starting z/OS Debugger for programs that start outside of Language Environment" or "Passing parameters to EQANMDBG or EQANDBG using only the EQANMDBG DD statement" in *IBM z/OS Debugger User's Guide*.

EQAOPTS command

- Command `LDDAUTOLANGX` can now be specified to control whether LDD is automatically run on LangX COBOL compile units. For more information, see [LDDAUTOLANGX](#).

Remote Debug Service

- Remote Debug Service can now be secured with AT-TLS. For more information, see [Customizing with the sample job EQARMTSU](#) and [Enabling secure communication with AT-TLS](#).

Debug Profile Service

- Debug Profile Service now runs on IBM z/OS Liberty Embedded instead of Apache Tomcat on z/OS. Refresh the `eqaprof.env` with the latest sample file to include environment variable **liberty_dir**. For more information, see [Customizing with the sample job EQAPRFSU](#).
- In addition to JCERACFKS, you can now also use a JCECCARACFKS keyring managed by RACF for secure communication. For more information, see [Enabling secure communication with a RACF managed key ring](#).
- You can now configure the number of requests per second to allow or deny into the Debug Profile Service. For more information, see [Customizing with the sample job EQAPRFSU](#).

Documentation updates

- A new page is added to list the requisites to use debug functions. For more information, see [Requisite products](#).
- Details of environment variables in `eqaprof.env` for Debug Profile Service and `eqarmtd.env` for Remote Debug Service are now documented. For more information, see [Customizing with the sample job EQAPRFSU \(Debug Profile Service\)](#) and [Customizing with the sample job EQARMTSU \(Remote Debug Service\)](#).

16.0.2

Compiler support

- Support is added for IBM Open Enterprise SDK for Go 1.20.
- Interoperability is now supported between 64-bit Java and 31-bit PL/I programs if you use 64-bit PL/I programs in between. Use delay debug mode to improve efficiency. For more information, see "Using delay debug mode to delay starting of a debug session" in *IBM z/OS Debugger User's Guide*.

IBM Z Open Debug

- Microsoft Visual Studio Code - Open Source is now the default browser-based IDE in Wazi for Dev Spaces. Support for Eclipse Theia has been deprecated as an IDE choice in Red Hat OpenShift Dev Spaces and will be removed in a future release.

IMS Transaction Isolation

- When Debug Profile Service is used, you can now use a filter to retrieve only the matching transactions instead of all the transactions for the specified IMS system to add to the IMS Isolation profile.
- You can now specify the range start and length for message pattern matching in the Eclipse IDE. For more information, see "Creating a debug profile for an IMS application using IMS Isolation with an Eclipse IDE" in [IBM Documentation](#).

Property group

- You can now choose whether to display the **Select Property Group** window when the debug editor initializes. For more information, see "Associating property groups with debug sessions" in [IBM Documentation](#).

Debug Profile Service

In addition to an SSL or a CA certificate, you can now enable Debug Profile Service to communicate with AT-TLS. For more information, see [Enabling secure communication with AT-TLS](#).

16.0.1

Installation Manager

- You can now install the Eclipse IDE via Installation Manager again:
 - For IBM Developer for z/OS, you can install the Eclipse IDE via Installation Manager as in Version 15.0 and before. For more information, see [Installing the IBM Developer for z/OS client by using IBM Installation Manager](#).
 - For IBM Debug for z/OS, you can now install the Eclipse IDE via Installation Manager as an extension offering to the IBM Explorer for z/OS offering, and you no longer need to install via IBM Developer for z/OS. For more information, see [Installing the IBM Debug for z/OS Eclipse IDE with IBM Installation Manager](#).

Compiler support

- Support is added for IBM Open Enterprise SDK for Go 1.19.
- Support is added for 31-bit PL/I applications compiled with TEST(SOURCE).

The following APARs are required for this support:

- z/OS Language Environment APAR PH49423
- Enterprise PL/I for z/OS 6.1 APAR PH50085

Code Coverage

- The multiple import menu actions and buttons in the **Code Coverage Results** view are now consolidated into a single menu action and button to import code coverage results. With the new **Code Coverage Import** wizard, you can select the following result formats to import into any result location in the **Code Coverage Results** view:
 - **CCZIP**: Import coverage results with a file extension of `.cczip`, which are produced by headless code coverage collection or via the Eclipse UI. Older formats ending with `.clcoveragedata`, `.ccresult`, or `.zip` are also supported with this option.
 - **JaCoCo**: Import coverage results data execution files with a file extension of `.exec`, which are produced by JaCoCo.
 - **z/OS Debugger**: Import coverage information that is stored in a sequential data set, which is produced in z/OS Debugger using CC or DCC in the TEST runtime option via MFI.
 - **Java Code Coverage**: Import legacy Java code coverage results with a file extension of `.coveragedata`. This option is available only in IBM Developer for z/OS and IBM Developer for z/OS Enterprise Edition.

All files are converted to the `.cczip` format during import. For more information, see "Importing compiled code coverage results", "Importing JaCoCo code coverage results", "Importing z/OS Debugger code coverage data", and "Importing legacy Java code coverage results" in [IBM Documentation](#).

- With Code Coverage Service, you can now download exporter formats PDF, SonarQube, and Cobertura, in addition to CCZIP. For more information, see "Code Coverage Service RESTful API Documentation" in [IBM Documentation](#).
- The summary section in the code coverage reports now provides more useful statistics and improved usability.
- You can now customize the colors that are used to indicate the threshold statuses (failure, warning, passed) for code coverage results in the code coverage reports.

z/OS Debugger Profiles view

- In the Debug Profile Editor, the CICS user ID field is now pre-populated with the reserved keyword `&USERID`, which is substituted with the currently logged-in user ID upon profile activation.
- On the **IBM z/OS Debugger Preferences** page, you can now choose whether to automatically synchronize debug profiles in the view with those in the remote system when you establish an RSE connection. For more information, see the "Setting debug preferences" topic in [IBM Documentation](#).

Debug Manager

- Debug Manager can now establish communication between the client and the debugger when the LPAR the client is connect to and the LPAR that the debug session is started are different. The sysplex support requires Eclipse IDE 16.0.1 or later. For more information, see [Enabling sysplex support](#).
- You can now use a configuration file to start Debug Manager. With a configuration file, you can start Debug Manager even when the length of command line with all necessary options exceeds 100 characters limit, for example, in the sysplex environment. For more information, see [Running Debug Manager as a started task using a configuration file](#).

16.0.0

Compiler support

- Support is added for IBM Open XL C/C++ for z/OS 1.1. z/OS Language Environment APAR PH46617 is required for this support.
- Support is added for IBM Open Enterprise SDK for Go 1.18.
- Interoperability is now supported between 31-bit and 64-bit PL/I programs. Use delay debug mode to improve efficiency. For more information, see "Using delay debug mode to delay starting of a debug session" in *IBM z/OS Debugger User's Guide*.

The following APARs are required for this support:

- z/OS Language Environment APARs PH48829 and PH48239
- Enterprise PL/I for z/OS 6.1 APAR PH49506

64-bit support

- With the removal of standard mode, 64-bit PL/I programs are now supported in Debug Tool compatibility mode with some limitations. For more information, see the "Limitations of 64-bit support in remote debug mode" topic in *IBM z/OS Debugger User's Guide*.

The following APARs are required for this support:

- z/OS Language Environment APARs PH48829 and PH48239
- Enterprise PL/I for z/OS 6.1 APAR PH49506
- Enterprise PL/I for z/OS 5.3 APAR PH49425

Code Coverage

- New web-based code coverage reports and comparison reports are available. You can now view the compared source files line by line. For more information, see "Working with a code coverage report" and "Working with a code coverage comparison report" in [IBM Documentation](#).
- Java code coverage is now strategically based on open source packages, in particular JaCoCo. You can import JaCoCo results into the **Code Coverage Results** view and work with the imported results. You can still import results previously generated with IBM Java code coverage tools into the view. The Java code coverage results already in the workspace will be migrated automatically. For more information, see "Working with Java code coverage results" in [IBM Documentation](#).
- You can now specify a warning threshold, in addition to failure threshold for code coverage result status. For more information, see "Setting the code coverage acceptance level" in [IBM Documentation](#).
- When you export code coverage results in SonarQube format, you can now specify a different encoding than the default UTF-8. For more information, see "Exporting code coverage results in SonarQube format", "Starting and stopping the headless code coverage collector", "Specifying code coverage options in the startup key", and "Merging and exporting code coverage results from z/OS" in [IBM Documentation](#).

Source level debug

- If you debug programs compiled with Enterprise COBOL for z/OS Version 6 Release 2 and later, you can now specify compiler option TEST (NOSOURCE) to use the **Source** view as the default in the Eclipse IDE, or you can switch to the **Source** view during the debug session if you compile with TEST (SOURCE). With TEST (NOSOURCE), the compiler does not include the source of your program as part of your debug data whether the location of the debug data is in the load module or in the SYSDEBUG file. For more information, see "Working with different debug views" in [IBM Documentation](#).

IMS Transaction Isolation

- You can now access IMS Transaction Isolation Facility with Debug Profile Service. ADFzCC configuration is no longer needed when Debug Profile Service is running on the selected RSE connection with z/OS Debugger 16.0.0 or later. The system programmer needs to configure the IMS Transaction Isolation API to enable this function. For more information, see [Configuring the IMS Transaction Isolation API for Debug Profile Service](#).
- You can now specify a character to be used as the job class for the isolated region when you create a debug profile for an IMS application. For more information, see "Creating a debug profile for an IMS application using IMS Isolation with an Eclipse IDE" in [IBM Documentation](#).
- Pattern matching used to filter transactions for isolation can now be limited to a range within a transaction message. For more information, see "Using IMS Transaction Isolation to create a private message-processing region and select transactions to debug" in *IBM z/OS Debugger User's Guide*.

Debug Profile Service

- On the **IBM z/OS Debugger Preferences** page, you can specify to ignore the SSL certificate errors when the Debug Profile Service that you want to connect to does not have a valid SSL certificate. For more information, see the "Setting debug preferences" topic in [IBM Documentation](#).
- As a system programmer, you can now set up Debug Profile Service to use external CICS interface (EXCI) to manage debug profiles stored in the region's repository instead of using the DTCN API. For more information, see [Defining the CICS EXCI CONNECTION and SESSIONS resources](#).

Property group

- You can associate property groups to avoid parsing errors in the language editors and ensure that visual debug can work properly. The property group can now be added or changed during a debug session, if you use a **z/OS Batch Application using existing JCL** or **z/OS Unix Application** launch configuration. For more information, see "Associating property groups with debug sessions" in [IBM Documentation](#).

EQAOPTS command

- Command CICSASMPGMND can now be specified to control whether z/OS Debugger allows debugging assembler programs when the language attribute of the program resource is not defined. For more information, see CICSASMPGMND and "Starting z/OS Debugger for non-Language Environment programs under CICS" in *IBM z/OS Debugger User's Guide*.

What's removed from IBM z/OS Debugger

Deprecation announcement

The following features are superseded by newer features and will be removed in a future release.

- z/OS Debugger Code Coverage: You can collect code coverage with the headless code coverage collector or the Eclipse IDE.
- TEST runtime suboption VADSCPnnnnn: Use EQAXOPT CODEPAGE for a code page other than 037.
- DTCN API and ADFzCC server support: DTCN profiles are supported by Debug Profile Service, and developers can use Debug Profile Service REST API to manage debug profiles.

- IMS Isolation ADFzCC server support: IMS Isolation debug profiles in the Eclipse IDE are now supported by Debug Profile Service, which provides more IMS Isolation features.

16.0.0

- Standard mode is no longer supported. Debug Tool compatibility mode is now the only remote debug mode and is referred to as remote debug mode directly. If you use `DIRECT` or `DBM` in the `TEST` runtime option, Debug Tool compatibility mode is invoked instead.
- Debug Tool plug-ins are removed. If you migrate from previous releases, any Debug Tool plug-in views are automatically closed in workspaces.
The same functions are available with other features.
 - You can use the `z/OS Debugger Profiles` view in the Eclipse IDE or the `z/OS Debugger Profiles` view provided with Z Open Debug to create and manage debug profiles. If you are a system programmer, you can use `z/OS Debugger Profile Management` to manage CICS (DTCN) profiles from all users.
 - You can use the **z/OS Batch Application with existing JCL** launch configuration to dynamically instrument and submit JCL to the host.
 - You can use the **Code Coverage Results** view to work with code coverage results.
- Load Module Analyzer is no longer bundled with z/OS Debugger.
- Generating code coverage for Java applications is no longer supported. You can import Java results that are generated by open source packages, in particular JaCoCo, into the **Code Coverage Results** view.
- Jython Debugger is no longer supported.
- Team debug is no longer supported.
- IMS message region templates (IBM z/OS Debugger Utilities options 4.3 Swap IMS Transaction Class and Run Transaction and option 4.4 Manage IMS Message Region Templates) are removed. Use options 4.5 IMS Transaction Isolation and option 4.6 Administer IMS Transaction Isolation Environment instead.
- `TEST` runtime suboption `VADTCP&` is no longer supported. Use `TCPIP&` instead.

Overview of IBM z/OS Debugger

IBM z/OS Debugger is the next iteration of IBM debug technology on IBM Z and consolidates the IBM Integrated Debugger and IBM Debug Tool engines into one unified technology.

IBM z/OS Debugger is a host component that supports various debug interfaces, like the Eclipse and Visual Studio Code IDEs. z/OS Debugger and the supported debug interfaces are provided with the following products:

IBM Developer for z/OS Enterprise Edition

This product is included in [IBM Application Delivery Foundation for z/OS](#). IBM Developer for z/OS Enterprise Edition provides all the debug features.

IBM Developer for z/OS Enterprise Edition currently provides debug functions in the following IDEs:

- IBM Developer for z/OS Eclipse
- Wazi for Dev Spaces, through IBM Z Open Debug
- Wazi for VS Code, through IBM Z Open Debug

IBM Developer for z/OS

IBM Developer for z/OS is a subset of IBM Developer for z/OS Enterprise Edition. IBM Developer for z/OS, previously known as IBM Developer for z Systems or IBM Rational® Developer for z Systems®, is an Eclipse-based integrated development environment for creating and maintaining z/OS applications efficiently.

IBM Developer for z/OS includes all enhancements in IBM Developer for z/OS Enterprise Edition except for the debug features noted in [Table 2 on page xxiii](#).

IBM Debug for z/OS

IBM Debug for z/OS is a subset of IBM Developer for z/OS Enterprise Edition. IBM Debug for z/OS focuses on debugging solutions for z/OS application developers. See [Table 2 on page xxiii](#) for the debug features supported.

IBM Debug for z/OS does not provide advanced developer features that are available in IBM Developer for z/OS Enterprise Edition.

For information about how to install the IBM Debug for z/OS Eclipse IDE, see [Installing the IBM Debug for z/OS Eclipse IDE](#).

IBM Z and Cloud Modernization Stack

IBM Z and Cloud Modernization Stack brings together component capabilities from IBM Z into an integrated platform that is optimized for Red Hat OpenShift Container Platform. With this solution, you can analyze the impact of application changes on z/OS, create and deploy APIs for z/OS applications, work on z/OS applications with cloud native tools, and standardize ID automation for z/OS. Starting from 2.0, Wazi Code is delivered in IBM Z and Cloud Modernization Stack. Wazi Code 1.x is still available in IBM Wazi Developer for Red Hat CodeReady Workspaces.

The debug functions are available in the IDEs provided with Wazi Code:

- Wazi for Dev Spaces, through IBM Z Open Debug
- Wazi for VS Code, through IBM Z Open Debug

Table 2 on page xxiii maps out the features that differ in products. Not all the available features are listed. To find the features available in different remote IDEs, see [Table 3 on page xxv](#).

	IBM Debug for z/OS	IBM Developer for z/OS	IBM Developer for z/OS Enterprise Edition	IBM Z and Cloud Modernization Stack (Wazi Code)
Main features				

Table 2. Debug feature comparison (continued)

	IBM Debug for z/OS	IBM Developer for z/OS	IBM Developer for z/OS Enterprise Edition	IBM Z and Cloud Modernization Stack (Wazi Code)
3270 interface, including z/OS Debugger Utilities	√		√	
Eclipse IDE, see Table 3 on page xxv for feature details. ¹	√	√	√	
IBM Z Open Debug provided with the Wazi for Dev Spaces IDE, see Table 3 on page xxv for feature details. ¹			√	√
IBM Z Open Debug provided with the Wazi for VS Code IDE, see Table 3 on page xxv for feature details. ¹			√	√
Code Coverage features				
Compiled Language Code Coverage ²	√	√ ³	√	
Headless Code Coverage	√	√	√	
ZUnit Code Coverage ⁴		√	√	
z/OS Debugger Code Coverage (3270 and remote interfaces) ⁵	√		√	
3270 features				
z/OS Debugger full screen, batch or line mode	√		√	
IMS Isolation support	√		√	
Compiler support features				
Assembler support: Create EQALANGX files	√	√	√	

	IBM Debug for z/OS	IBM Developer for z/OS	IBM Developer for z/OS Enterprise Edition	IBM Z and Cloud Modernization Stack (Wazi Code)
Assembler support: Debugging ⁶	√	√	√ ⁷	√ ⁷
LangX COBOL support ⁸	√	√	√	
Support for Automatic Binary Optimizer (ABO)	√	√	√	

Notes:

- The following features are supported only in remote debug mode:
 - Support for 64-bit COBOL feature of z/OS for COBOL V6.3 and later
 - Support for 64-bit Enterprise PL/I for z/OS Version 5 and later
 - Support for 64-bit C/C++ feature of z/OS
 - Support for Open Enterprise SDK for Go 1.21 and 1.22.
 - Support for Open XL C/C++ for z/OS 1.1 and later.
- Code coverage does not support Go programs.
- IBM Developer for z/OS includes z/OS Debugger remote debug and compiled code coverage Eclipse interface, but does not include z/OS Debugger Code Coverage.
- ZUnit Code Coverage is only supported in Debug Tool compatibility mode.
- z/OS Debugger Code Coverage can only be enabled in the 3270 interface. This function is deprecated and will be removed in a future release.
- Debugging assembler requires that you have EQALANGX files that have been created via ADFz Common Components or a product that ships the ADFz Common Components.
- This feature is only available with the Eclipse IDE.
- LangX COBOL refers to any of the following programs:
 - A program compiled with the IBM OS/VS COBOL compiler.
 - A program compiled with the IBM VS COBOL II compiler with the NOTEST compiler option.
 - A program compiled with the IBM Enterprise COBOL for z/OS 3, 4, or 6 compiler with the NOTEST compiler option.

Feature	Eclipse-based debug interface	IBM Z Open Debug ^{1,6}
Integration with Language Editors ⁶	<ul style="list-style-type: none"> COBOL Editor² PL/I Editor² Remote C/C++ Editor² System z LPEX Editor² 	<ul style="list-style-type: none"> Z Open Editor
Visual Debug	√ ^{2,6}	
Debugging ZUnit tests	√ ⁶	
Debug profile management	√ ⁶	√

Table 3. Remote IDE debug feature comparison (continued)

Feature	Eclipse-based debug interface	IBM Z Open Debug ^{1,6}
IMS Isolation UI	√ ³	
Integration with CICS Explorer views	√ ²	
Integration with property groups	√ ^{2,6}	
Integrated launch ⁶	<ul style="list-style-type: none"> • z/OS UNIX Application launch configuration • z/OS Batch Application using existing JCL • z/OS Batch Application using a property group⁴ 	
Modules	√	
Memory	√	
Program navigation		
Step over/Next	√	√
Step into/Step in	√	√
Step return/Step out	√	√
Jump to location	√ ⁶	
Run to location/Run to cursor	√ ⁶	√
Resume/Continue	√	√
Terminate	√	√
Animated step	√	
Playback	√ ⁶	
Breakpoints		
Statement breakpoints	√	√
Entry breakpoints	√	
Source entry breakpoints	√ ⁶	
Event breakpoint	√ ⁶	
Address breakpoint	√ ⁶	
Watch breakpoint	√ ⁶	
Variables & Registers		
Variables	√	√
Registers	√	√ ⁵
Modifying variable and register values	√	√
Setting variable filter	√ ⁶	
Changing variable representation	√	

Table 3. Remote IDE debug feature comparison (continued)

Feature	Eclipse-based debug interface	IBM Z Open Debug ^{1,6}
Displaying in memory view	√	
Monitors		
Displaying monitor	√	√
Modifying monitor value	√	
Changing variable representation	√	
Debug Console		
Evaluating variables and expressions		√
z/OS Debugger commands	√ ⁷	

Notes:

1. IBM Z Open Debug is provided with Wazi for Dev Spaces and Wazi for VS Code.
2. This feature is not available in IBM Debug for z/OS.
3. This feature is only available in IBM Developer for z/OS Enterprise Edition.
4. IBM Developer for z/OS does not include z/OS Debugger Code Coverage 3270 interfaces.
5. Registers are available in the **Variables** view.
6. The automonitor filters do not support programs compiled with Open Enterprise SDK for Go or Open XL C/C++ for z/OS.
7. Programs compiled with IBM Open Enterprise SDK for Go are not supported.

Chapter 1. Customizing z/OS Debugger: checklist

Note: You can also use [IBM Host Configuration Assistant for Z Development](https://zdev-hca.ibm.com) (<https://zdev-hca.ibm.com>) to generate a customized checklist for z/OS Debugger. [Host Configuration Assistant for Z Development](https://zdev-hca.ibm.com) is an interactive wizard that is designed to simplify planning and configuring of Z development products. Besides z/OS Debugger, you can also find the configuration information for other host components like z/OS Explorer and z/OS Source Code Analysis. Only the latest product releases are supported.

This topic helps you identify which customization tasks you must do. Begin by reviewing the topic "Planning your debug session" in the *IBM z/OS Debugger User's Guide* with your application programmers and library system administrator. Reviewing that topic helps you gather the following information, which you need to identify which customization tasks you must do:

- Which version of compilers you are using
- Whether you are debugging Db2, Db2 stored procedures, CICS, and IMS programs
- Whether you are using full-screen mode, full-screen mode using the Terminal Interface Manager, batch mode, or remote debug mode
- How your programs will call z/OS Debugger
- Whether you will be using IBM z/OS Debugger Utilities, ADFz Common Components, or Application Delivery Foundation for z/OS tools
- Whether you will need to modify some behaviors of the debugger

After you gather this information, review the following checklists. As you read each item on the checklist, you use the information you gathered to determine if you need to do that customization task. If the task is not applicable to your site, you can skip that task.

You must do all of the following compulsory customization tasks:

- [Chapter 2, "Product Registration," on page 7](#)
- [Chapter 3, "Installing the z/OS Debugger SVCs," on page 9.](#)
- [Chapter 4, "Setting up the APF-authorized system link list data set \(SEQABMOD\)," on page 13](#)
- [Chapter 5, "Setting up the link list data set \(SEQAMOD\)," on page 15](#)
- [Chapter 6, "Enabling debugging in full-screen mode using the Terminal Interface Manager," on page 17.](#)
- If your application programmers debug in remote debug mode, review [Chapter 7, "Adding support for remote debug users," on page 25.](#)
- Read [Chapter 8, "Specifying the TEST runtime options through the Language Environment user exit," on page 81](#) and review with your users to see if they need you to do this customization.

If you previously installed any of these Language Environment user exits: EQADDCXT, EQADICXT, EQADBCXT, switch to the EQAD3CXT user exit.

If you previously installed the Language Environment user exit EQAD3CXT, rebuild this exit. z/OS Debugger has updated the sample assembler user exits and the load modules.

- Read [Chapter 9, "Installing the browse mode RACF facility," on page 87](#) if you want to control which users have access to z/OS Debugger, or control which users can access z/OS Debugger only through browse mode.

Note: If you have defined a generic Facility class profile (for example, **), you might have to install the browse mode RACF facilities, even if neither of the previous considerations applies. For example, if you have a generic Facility class profile of ** with UACC(NONE) and you do not install the browse mode RACF facilities, no users would be allowed to use z/OS Debugger.

If you are using IBM z/OS Debugger Utilities, you must do the required customization tasks described in the following topics:

- [“Choosing a method to start IBM z/OS Debugger Utilities” on page 90.](#)
- [“Customizing the data set names in EQASTART” on page 91.](#)
- [“Adding IBM z/OS Debugger Utilities to the ISPF menu” on page 92.](#)
- For the JCL for Batch Debugging utility, you must specify default values for the yb1dtmod and yb1dtbin parameters. See [“Customizing for JCL for Batch Debugging utility” on page 92.](#)

If you are using any of the following utilities in IBM z/OS Debugger Utilities, you must do an additional customization task:

- If you are using z/OS Debugger Setup Utility, see [“Customizing z/OS Debugger Setup Utility” on page 92.](#)
- If you are using other IBM Application Delivery Foundation for z/OS tools, such as File Manager for z/OS, see [“Customizing Other IBM Application Delivery Foundation for z/OS tools for multiple systems” on page 95.](#)
- If you are using Program Preparation, see [“Customizing Program Preparation” on page 96.](#)
- For the IMS BTS Debugging option, you must specify default values for yb2* parameters. See [“Customizing IMS BTS Debugging” on page 100.](#)

If you are debugging Db2 stored procedures, CICS program, or IMS programs, you must do the following required customization tasks:

- If your site debugs Db2 stored procedures, see [Chapter 11, “Preparing your environment to debug Db2 stored procedures,” on page 107.](#)
- If your site debugs CICS programs, see [Chapter 12, “Adding support for debugging under CICS,” on page 109.](#)
- If your site debugs IMS programs, see [Chapter 13, “Adding support for debugging under IMS,” on page 127](#) and implement scenario A.
- If your site debugs non-Language Environment IMS programs, see [Chapter 13, “Adding support for debugging under IMS,” on page 127](#) and implement scenario C.

In Debug Tool Version 13.1, the EQALANGP and EQALANGX modules were moved from Debug Tool's EQAW.SEQAMOD library to Common Component's IPV.SIPVMODA library, where they will be aliases of IPVLANGP and IPVLANGX respectively. This removes duplication between the two tools. If you have library build processes or other tools that reference either of these routines, and IPV.SIPVMODA is not in link list, then you will need to update your processes to point to the new location for these routines. See *Preparing a LangX COBOL program* and *Preparing an assembler program* in the *IBM z/OS Debugger Customization Guide* for more information about EQALANGX.

Note: Debug Tool for z/OS is now named as z/OS Debugger, and Problem Determination Tools for z/OS Common Component is now named IBM Application Delivery Foundation for z/OS Common Components.

As you review the rest of the checklist, if you need to do an item that requires that you specify an EQAOPTS command, you can print a copy of the checklist and use it to record the commands you need to specify and the values for any options. When you are done reviewing the checklist, you can specify all the EQAOPTS commands at one time as described in [“Creating EQAOPTS load module” on page 155.](#)

For any of the following situations, see [“CODEPAGE” on page 160:](#)

- Application programmers are debugging in remote debug mode and the source or compiler use a code page other than 037. If your C/C++ source contains square brackets or other special characters, you might need to specify an EQAOPTS CODEPAGE command to override the z/OS Debugger default code page (037). Check the code page specified when you compiled your source. The C/C++ compiler uses a default code page of 1047 if you do not explicitly specify one. If the code page used is 1047 or a code page other than 037, you need to specify an EQAOPTS CODEPAGE command specifying that code page.
- Application programmers are debugging in full screen mode and encounter one of the following situations:
 - They use the STORAGE command to update COBOL NATIONAL variables.
 - The source is coded in a code page other than 037.

- Application programmers use the XML (CODEPAGE(ccsid)) parameter on a LIST CONTAINER or LIST STORAGE command to specify an alternate code page.

Do the customization tasks in the following list only if your site needs the features described:

- These EQAOPTS commands enable certain z/OS Debugger functions:
 - [“ALTDISP” on page 156](#)
You want z/OS Debugger to display the at sign (@) in the prefix area of a line to indicate that the line contains a breakpoint, instead of using a colored line.
 - [“BROWSE” on page 156](#)
You want to restrict access to z/OS Debugger or control which users¹ must debug in browse mode.
 - [“CCOUTPUTDSN” on page 157](#)
You want to use Code Coverage and need to specify the name of the Observation data set.
 - [“CCOUTPUTDSNALLOC” on page 157](#)
You want to use Code Coverage and need to specify the allocation parameters for the Observation data set.
 - [“CCPROGSELECTDSN” on page 158](#)
You want to use Code Coverage and need to specify the name of the Options data set.
 - [“DLAYDBG” on page 163](#)
You want to allow users to use the delay debug mode.
 - [“EQAQPP” on page 168](#)
Your site needs to debug Q++ programs.
 - [“IGNOREODOLIMIT” on page 170](#)
You want to tell z/OS Debugger to display COBOL table items even when an ODO value is out of range.
 - [“LOGDSNALLOC” on page 173](#)
You want z/OS Debugger to automatically create a LOG data set for each user.
 - [“MDBG” on page 174](#)
Your site uses z/OS XL C/C++, Version 1.10, or later, and you want z/OS Debugger to retrieve source and debug information from .mdbg files.
 - [“SAVESETDSNALLOC, SAVEBPDSNALLOC” on page 178](#)
You want z/OS Debugger to automatically create either of the following data sets:
 - A data set to save and restore settings
 - A data set to save and restore breakpoints, monitor values and LOADDEBUGDATA (LDD) specifications
 - [“STARTSTOPMSG” on page 180](#)
You want z/OS Debugger to issue a message when each debugging session is initiated or terminated.
 - [“SUBSYS” on page 182](#)
If your site uses a library system that uses the SUBSYS allocation parameter and your application programmers debug C, C++, or Enterprise PL/I programs, review this command to determine if you need to change the SUBSYS parameter.
 - [“SVCSCREEN” on page 182](#)
You need to debug non-Language Environment programs that start under Language Environment, Language Environment programs that use the MVS LINK, LOAD or DELETE services, LangX COBOL programs, or your site has any host products that might use SVC screening when z/OS Debugger is started.
- If your site uses any of the following functions in a Japanese or Korean environment, see [“Enabling additional languages for some z/OS Debugger components through EQACUIDF” on page 146](#):

¹ If you want to enforce browse mode restrictions, you must use the RACF Facility Class Profile as described in Chapter 9, “Installing the browse mode RACF facility,” on page 87. You can learn how the EQAOPTS BROWSE command works with the RACF profiles by reviewing the table in the topic “Controlling browse mode” of the *IBM z/OS Debugger User's Guide*.

- IBM z/OS Debugger Utilities ISPF panels
- z/OS Debugger Code Coverage
- EQANMDBG (non-CICS non-Language Environment support)

Do the customization tasks in the following list only if you want to modify the behavior described:

- These EQAOPTS commands modify the behavior of certain z/OS Debugger functions:
 - [“CACHENUM” on page 157](#)
You want to reduce z/OS Debugger's CPU consumption in certain cases.
 - [“CEEREACTAFTERQDBG” on page 159](#)
You want to restart z/OS Debugger with CEETEST after you use QUIT DEBUG.
 - [“COMMANDSDSN” on page 162](#)
You want to change the default data set name for the user's commands file.
 - [“DEFAULTVIEW” on page 162](#)
You want to change the default setting for SET DEFAULT VIEW so that assembler macro-generated statements are not displayed in the Source window.
 - [“DLAYDBGEND” on page 164](#)
You want to change the default delay debug setting for monitoring condition events.
 - [“DLAYDBGDSN” on page 164](#)
You want to change the default name of the delay debug profile data set.
 - [“DLAYDBGTRC” on page 165](#)
You want to change the default delay debug pattern match trace message level.
 - [“DLAYDBGXRF” on page 165](#)
You want to instruct delay debug to use the cross reference file to find the user ID when it constructs the delay debug profile data set name.
 - [“DTCNDELETEDEADPROF” on page 166](#)
You want to change the default setting for controlling the deletion of dead DTCN profiles.
 - [“DTCNFORCExxxx” on page 167](#)
You want to change the default DTCN behavior for certain resource types.
 - [“DYNDEBUG” on page 168](#)
You want to change the initial or default value of SET DYNDEBUG.
 - [“GPFDSN” on page 169](#)
Your site wants to control the appearance or settings, through z/OS Debugger commands, of all debugging sessions, create a global preferences file. The global preferences file is a file that is processed at the beginning of every debugging session and contains z/OS Debugger commands. See this command for instructions on how to create a global preferences file.
 - [“HOSTPORTS” on page 170](#)
Your users are using the remote debugger and you need to specify a host port or range of ports for a TCP/IP connection from the host to the workstation.
 - [“LOGDSN” on page 172](#)
You want to change the default data set name for the LOG data set.
 - [“MAXTRANUSER” on page 174](#)
You want to use the IMS Transaction Isolation Facility described in [Chapter 13, “Adding support for debugging under IMS,” on page 127](#), and you need to set the maximum number of transactions that a single user can debug to something less than 15.
 - [“MULTIPROCESS” on page 175](#)
You want to change the default behavior of z/OS Debugger when a new POSIX process is created by a fork() or exec() function.
 - [“NAMES” on page 176](#)
Your site needs to issue a NAMES command for the initial load module or any of its compile units.
 - [“NODISPLAY” on page 176](#)

To modify the debugger's behavior when a full-screen mode using the Terminal Interface Manager or a remote debugger is not available.

- [“PREFERENCESDSN” on page 177](#)
You want to change the default data set name for the user's preferences file.
- [“SAVEBPDSN, SAVESETDSN” on page 178](#)
Your site wants to change the default names, which are *userid*.DBGT00L.SAVESETS and *userid*.DBGT00L.SAVEBPS, of the data sets that store settings, breakpoints, and monitor values.
- [“SESSIONTIMEOUT” on page 180](#)
You want to specify an idle session timeout for users who are using the Terminal Interface Manager.
- [“STARTSTOPMSGDSN” on page 181](#)
You want z/OS Debugger to write information to a log data set when each non-CICS debugging session is initiated or terminated.
- [“TCPIPDATA” on page 185](#)
Your users are using the remote debugger and your host TCP/IP does not have a specification for GLOBALTCPIPDATA.
- [“THREADTERMCOND” on page 186](#)
Your site wants z/OS Debugger to suppress the prompt that Language Environment displays every time when the statements like STOP RUN, GOBACK, or EXEC CICS RETURN are run. These statements can occur frequently in an application program, creating unnecessary interruptions for a user trying to debug the application program.
- [“TIMACB” on page 186](#)
You want to change the default ACB name for the Terminal Interface Monitor.
- If your site is using the EQAUEDAT user exit to direct z/OS Debugger to the location of source, listing, or separate debug files, see [Chapter 14, “Enabling the EQAUEDAT user exit,” on page 143](#).
- If your site needs to change the defaults for NATLANG, LOCALE, or LINECOUNT, see [“Changing the default and allowable values in EQACUIDF” on page 145](#).

Requisite products

z/OS Debugger has a list of prerequisite software that must be installed and operational before it works. There is also a list of corequisite software to support specific features of the product. These requisites must be installed and operational at run time for the corresponding features to work as designed.

For a complete listing of the software requirements including prerequisites and co-requisites for a product, see the Software Product Compatibility Reports (SPCR) tool (<https://www.ibm.com/software/reports/compatibility/clarity/index.html>). Search for the product that you acquired z/OS Debugger with.

The key requisites for a basic setup are:

- The Debug Profile Service API is hosted on the IBM z/OS Liberty Embedded application server and is compatible with the default IBM z/OS Liberty Embedded installation on your z/OS system. You do not need to install or modify the existing IBM z/OS Liberty Embedded application server to accommodate the Debug Profile Service API, but you need to refresh the [`eqaprof.env`](#) to include environment variable `liberty_dir`.
- z/OS Explorer
- Java:
 - Java 11 or 17 is required for [Remote Debug Service](#).
 - Java 8, 11, or 17 (with IBM z/OS Liberty Embedded 23.0.0.12 or later) is required for [Debug Profile Service](#).

After installation, you need to [configure z/OS to run Java applications](#).

- [Remote Debug Service](#) and the headless code coverage collector are built on [Eclipse](#) and [Java](#) technology. Configuration options for Eclipse and Java might affect the behavior of [Remote Debug Service](#) and headless code coverage collector.

Chapter 2. Product Registration

You must set up product registration for z/OS Debugger.

Registering z/OS Debugger

z/OS Debugger is available as a component of multiple products. Different functions of z/OS Debugger are enabled according to the product you purchased.

- IBM Developer for z/OS Enterprise Edition 16.0, program number 5755-A05 (Shopz orderable)
 - IBM Developer for z/OS Enterprise Edition is one of the products included in IBM Application Delivery Foundation for z/OS 4.0, program number 5755-A01 (Shopz orderable).
- IBM Debug for z/OS 16.0, program number 5755-A06 (Shopz orderable)
- IBM Developer for z/OS 16.0, program number 5724-T07 (web download)
- IBM Z and Cloud Modernization Stack 2023, program number 5900-A8N (web download)

You must set up z/OS product registration for z/OS Debugger to enable its functions. Products to be enabled on z/OS are defined in the IFAPRDxx parmlib member that is used for IPL.

If you already defined the product using FEATURENAME(' * ') for another component of the product, you do not need to repeat the definition. Otherwise, you must specify **one** of the following IFAPRDxx entries, depending on how you purchased z/OS Debugger:

- If you acquired z/OS Debugger as a part of IBM Application Delivery Foundation for z/OS (product code 5755-A01), specify the following definition in IFAPRDxx. Sample member EQAWIFAA, which contains the next statements, is provided in the SEQASAMP sample library.

```
PRODUCT OWNER(' IBM CORP' )
        NAME(' IBM APP DLIV FND' )
        ID(5755-A01)
        VERSION(*) RELEASE(*) MOD(*)
        FEATURENAME(*)
        STATE(ENABLED)
```

- If you acquired z/OS Debugger as a part of IBM Developer for z/OS Enterprise Edition (product code 5755-A05), specify the following definition in IFAPRDxx. Sample member EQAWIFAE, which contains the next statements, is provided in the SEQASAMP sample library.

```
PRODUCT OWNER(' IBM CORP' )
        NAME(' IBM IDz EE' )
        ID(5755-A05)
        VERSION(*) RELEASE(*) MOD(*)
        FEATURENAME(*)
        STATE(ENABLED)
```

- If you acquired z/OS Debugger as a part of IBM Debug for z/OS (product code 5755-A06), specify the following definition in IFAPRDxx. Sample member EQAWIFAD, which contains the next statements, is provided in the SEQASAMP sample library.

```
PRODUCT OWNER(' IBM CORP' )
        NAME(' IBM Debug for z' )
        ID(5755-A06)
        VERSION(*) RELEASE(*) MOD(*)
        FEATURENAME(*)
        STATE(ENABLED)
```

- If you acquired z/OS Debugger as a part of IBM Developer for z/OS (product code 5724-T07), specify the following definition in IFAPRDxx. Sample member EQAWIFAZ, which contains the next statements, is provided in the SEQASAMP sample library.

```
PRODUCT OWNER(' IBM CORP' )
        NAME(' IBM IDz' )
```

```
ID(5724-T07)
VERSION(*) RELEASE(*) MOD(*)
FEATURENAME(*)
STATE(ENABLED)
```

- If you acquired z/OS Debugger as a part of Wazi Code delivered in IBM Z and Cloud Modernization Stack (product code 5900-A8N), specify the following definition in IFAPRDxx. Sample member EQAWIFAW, which contains the next statements, is provided in the SEQASAMP sample library.

```
PRODUCT OWNER('IBM CORP')
NAME('IBM Wazi Code')
ID(5900-A8N)
VERSION(*) RELEASE(*) MOD(*)
FEATURENAME(*)
STATE(ENABLED)
```

Notes:

- These sample definitions enable all features of the selected product. To register each feature individually, create a PRODUCT block for each feature and specify FEATURENAME (' IDz -DEBUGGER ') to register the z/OS Debugger feature.
- If you do not register any of the listed products in the IFAPRDxx parmlib member, z/OS Debugger will assume that you purchased IBM Developer for z/OS (product code 5724-T07) and enable only the related functions.
- No matter which product you bought and registered, any Copyright statement at z/OS Debugger startup always shows 5724-T07 for the product ID. The same is true for "CALL %VER", as well as Copyright statements in samples, ISPF parts, program objects or load modules.

After you update IFAPRDxx, issue the **SET PROD=xx** operator command to dynamically activate the definitions. z/OS Debugger will then be enabled in your z/OS environment.

IBM advises against defining IFAPRDxx entries that have NAME (*) or ID (*) fields, as this will result in all z/OS applications that utilize product registration to find a match on the first test, and adhere to the related STATE () definition. For z/OS Debugger with STATE (ENABLED), this means that the application will register as Application Delivery Foundation for z/OS (product code 5755-A01).

If your site has coded a generic entry in IFAPRDxx, complete the following steps:

1. Code an entry for each item that you did not purchase STATE (NOTDEFINED).
2. Code an entry for the item you did purchase as shown in the previous text.
3. Issue a **SET PROD=xx** operator command.

Removing old registrations

Remove all old registration entries that belonged to z/OS Debugger. Older versions of z/OS Debugger were known as Debug Tool, or Debug Tool Utilities and Advanced Functions.

To remove old registration entries, complete the following steps:

1. Change the STATE (ENABLED) parameter for the old entries in the IFAPRDxx parmlib member to STATE (NOTDEFINED).
2. Issue a **SET PROD=xx** operator command to activate your changes.
3. Remove the old entries from IFAPRDxx. This update will become active at next IPL.

Chapter 3. Installing the z/OS Debugger SVCs

z/OS Debugger requires the installation of the z/OS Debugger SVC programs EQA00SVC (IGC0014E) and EQA01SVC (IGX00051):

- EQA00SVC is a type 3 SVC with a reserved number of 145 (x'91').
- EQA01SVC is a type 3 using SVC number 109 (X'6D') with function code 51.

The z/OS Debugger SVCs are compatible with z/OS Debugger Version 14 and 15 (Program Number 5724-T07), Debug Tool Version 13 Release 1 (Program Number 5655-Q10), and Version 12 Release 1 (Program Number 5655-W70).

The z/OS Debugger SVCs support the Dynamic Debug facility and other necessary z/OS Debugger functions.

To install the SVCs, do the following steps on each of the LPARs that z/OS Debugger will be used on:

1. For a new installation, complete both [step a](#) (for using the debugger after the next IPL) and [step b](#) (for immediate usage of the new debugger). For a service update (a PTF installation), the work that was done in [step a](#) in the first installation will pick up the new service at the next IPL, and doing [step b](#) will provide the new service immediately to the users.
 - a. Install the SVCs through a system IPL. The SMP/E APPLY operation, which you run when you install z/OS Debugger or apply a PTF, updates the library *hlq*.SEQALPA with the SVCs. To place *hlq*.SEQALPA in the LPA list, add it to an LPALSTxx member of parmlib that is used for IPL. If you have earlier releases of z/OS Debugger installed at your site, remove any other SEQALPA data sets. The next time you IPL your system, the SVCs are automatically installed.

Check the other data sets in LPA list for old copies of these members. If you find them, remove them.²

- EQA00SVC
- EQA01SVC
- IGC0014E (ALIAS of EQA00SVC)
- IGX00051 (ALIAS of EQA01SVC)

These members might have been placed there by previous installations of z/OS Debugger.

- b. Install the SVCs without a system IPL for immediate usage (dynamic installation). The SMP/E APPLY operation, which you run when you install z/OS Debugger or apply a PTF, updates the library *hlq*.SEQAAUTH with the SVCs and the dynamic SVC installer.
 - i) Mark the *hlq*.SEQAAUTH data set as APF-authorized. This data set contains SVC installation programs; therefore, access to it must be limited to system programmers.
 - ii) Update both places in the SVC dynamic install job EQAWISVC (shipped as a member of the data set *hlq*.SEQASAMP) with the fully qualified name for the z/OS Debugger *hlq*.SEQAAUTH data set. Eye-catchers (<<<<<) in the job highlight the statements that require changing. You might also need to update the job card.
 - iii) Submit the job. The job installs both SVCs. After the job is completed, verify that the return code is 00 (RC=00).
 - iv) Any CICS or IMS regions that are running when these SVCs are installed, and that may have had z/OS Debugger sessions, should be stopped and restarted.

² You can either browse each data set in LPA list directly or refer to [Finding out what dataset a module resides in](#).

³ To APF-authorize a data set, add an APF ADD statement for the data set to a PROGxx member of parmlib that is used for IPL. To immediately APF-authorize the data set, use the SETPROG APF MVS command.

- If your users need to use the Dynamic Debug facility to debug programs that are loaded into protected storage (located in subpool 251 or 252), follow the instructions in [“Using the Authorized Debug facility for protected programs”](#) on page 11. Most CICS installations need to do this.

Verifying the installation of the SVCs

To verify the installation of the SVCs, you need to check the level of the z/OS Debugger SVCs, then run the installation verification programs.

Checking the level of the z/OS Debugger SVCs

Display the level of the z/OS Debugger SVCs installed by entering the following command:

```
EXEC 'h1q.SEQAEXEC(EQADTSVC)'
```

Information about EQA00SVC that is similar to the following is displayed. Verify that the version and compile date that are displayed are the same or higher than what is shown here.

Note: The string Debug Tool in the output of EQADTSVC is expected. The string was preserved for downward compatibility with Debug Tool. The 5724-T07 denotes that the SVC is from z/OS Debugger.

```
...EQA00SVC 2024.060Licensed Materials - Property of IBM 5724-T07 Debug Tool Version 05
EQA00SVC-r88942Copyright Copyright IBM Corp. US Government Users
***> EQA00SVC is Version 05 with compile date 29 Feb 2024
```

Information about EQA01SVC that is similar to the following is displayed. Verify that the version and compile date that are displayed are the same or higher than what is shown here.

```
...EQA01SVC 2024.060Licensed Materials - Property of IBM 5724-T07 Debug Tool Version 21
EQA01SVC-r93783Copyright Copyright IBM Corp. US Government Users
***> EQA01SVC is Version 21 with compile date 29 Feb 2024
```

```
...EQA01SV2 2024.060Licensed Materials - Property of IBM 5724-T07 Debug Tool Version 05
EQA01SV2-r88233Copyright Copyright IBM Corp. US Government Users
***> EQA01SV2 is Version 05 with compile date 29 Feb 2024
```

```
...EQA01TSR 2024.060Licensed Materials - Property of IBM 5724-T07 Debug Tool Version 00
EQA01TSR-f8730eCopyright Copyright IBM Corp. US Government Users
***> EQA01TSR is Version 00 with compile date 29 Feb 2024
```

Running the installation verification programs for SVCs

To help you verify the installation of the z/OS Debugger SVCs (that the SVCs are installed and working correctly), the `h1q.SEQASAMP` data set contains installation verification programs (IVPs) in the following members. Run the IVPs that are appropriate for the tasks that your users will be performing. Before you run any IVP, customize it for your installation as described in the member.

<i>Table 4. Name of the installation verification program and the programming language corresponding to that installation verification program.</i>	
IVP	Task
EQAWIVP4	COBOL TEST (NONE , SYM) or TEST (NOHOOK)
EQAWIVPF	PL/I TEST (ALL , SYM, NOHOOK)
EQAWIVPI	Enterprise PL/I TEST (ALL , SYM, NOHOOK , SEPARATE)
EQAWIVPJ	LangX Enterprise COBOL
EQAWIVPP	COBOL TEST (NONE , SYM, SEPARATE) or TEST (NOHOOK , SEPARATE)
EQAWIVPT	Enterprise COBOL for z/OS Version 5 and later TEST
EQAWIVPS	disassembly

Table 4. Name of the installation verification program and the programming language corresponding to that installation verification program. (continued)

IVP	Task
EQAWIVPA	Language Environment assembler
EQAWIVPB ⁴	Language Environment assembler - interactive
EQAWIVPC	non-Language Environment assembler
EQAWIVPV	OS/VS COBOL
EQAWIVPX	non-Language Environment VS COBOL II

Notes:

- There are no installation verification programs for SVCs written specifically for IBM Z and Cloud Modernization Stack (Wazi Code). You can though, modify EQAWIVP4, EQAWIVPF, EQAWIVPI, EQAWIVPP or EQAWIVPT to run interactively with the workstation GUI for IBM Z and Cloud Modernization Stack (Wazi Code).

Using the Authorized Debug facility for protected programs

Important: Before you do this task, you must have installed and verified the SVCs.

If your users need to use the Dynamic Debug facility to debug programs that are loaded into protected storage (located in subpool 251 or 252), your security administrator must authorize those users to use the Authorized Debug facility. Examples of reentrant programs that are loaded into protected storage are:

- Re-entrant programs loaded from an APF authorized library by MVS
- Programs loaded by CICS into RDSA or ERDSA because RENTPGM=PROTECT (the default).

Note: Most CICS programs are re-entrant. This task is required if your CICS regions use the SIT parameter RENTPGM=PROTECT (the default).

To authorize users to use the Authorized Debug facility:

1. Establish a profile for the Authorized Debug Facility in the FACILITY class by entering the RDEFINE command:

```
RDEFINE FACILITY EQADTOOL.AUTHDEBUG UACC(NONE)
```

2. Verify that generic profile checking is in effect for the class FACILITY by entering the following command:

```
SETROPTS GENERIC(FACILITY)
```

3. Give a user permission to use the Authorized Debug Facility by entering the following command, where *DUSER1* is the name of a RACF-defined user or group profile:

```
PERMIT EQADTOOL.AUTHDEBUG CLASS(FACILITY) ID(DUSER1) ACCESS(READ)
```

Instead of connecting individual users, the security administrator can specify *DUSER1* to be a RACF group profile and then connect authorized users to the group.

In CICS, z/OS Debugger checks that the region user ID is authorized instead of an individual CICS user ID.

⁴ This IVP is provided for customers that purchased z/OS Debugger via IBM Developer for z/OS - non-Enterprise Edition. In this case, z/OS Debugger only runs with the IBM Developer for z/OS IDE. This IVP has instructions that describe how to run the IVP with the IBM Developer for z/OS IDE. The other IVPs in this table do not.

4. If the FACILITY class is not active, activate the class by entering the SETROPTS command:

```
SETROPTS CLASSACT(FACILITY)
```

Issue the SETROPTS LIST command to verify that FACILITY class is active.

5. Refresh the FACILITY class by issuing the SETROPTS RACLIST command:

```
SETROPTS RACLIST(FACILITY) REFRESH
```

Chapter 4. Setting up the APF-authorized system link list data set (SEQABMOD)

Note: This chapter is not applicable to IBM Developer for z/OS (non-Enterprise Edition) or IBM Z and Cloud Modernization Stack (Wazi Code).

You must make certain z/OS Debugger load modules available in an APF-authorized data set that is in the system link list concatenation. You can do this in one of the following ways, depending on your site policy:

- Mark and add the load modules by doing the following steps:
 1. Mark the *hlq*.SEQABMOD data set as APF-authorized.
 2. Add the data set to the system link list concatenation.⁵
 3. If you have earlier releases of z/OS Debugger installed, remove any other SEQABMOD data sets.
 4. Do an LLA refresh to make the members in *hlq*.SEQABMOD available to z/OS Debugger.
- Copy the load modules and refresh the members by doing the following steps:
 1. Copy⁶ all the members of the *hlq*.SEQABMOD data set into an existing APF-authorized system link list data set.
 2. Do an LLA refresh to make these members available to z/OS Debugger.

⁵ To add a data set to the link list, add a LNKLST ADD statement for the data set to a PROGxx member of parmlib that is used for IPL. To immediately add a data set to the link list, use the SETPROG LNKLST MVS command. Then, if the link list data set is managed by LLA, enter a F LLA, REFRESH MVS command to refresh the Library Lookaside Directories.

⁶ If you do this copy, you must repeat this copy after you apply any service to z/OS Debugger. SMP/E does not do this copy for you.

Chapter 5. Setting up the link list data set (SEQAMOD)

The *hlq*.SEQAMOD data set must be in the load module search path whenever you debug a program with z/OS Debugger. Except for two cases, it will be convenient for your users if you put *hlq*.SEQAMOD in the system link list concatenation. The exceptions are:

- CICS, where *hlq*.SEQAMOD must be placed in the DFHRPL concatenation. See [Chapter 12, “Adding support for debugging under CICS,”](#) on page 109.
- When the z/OS Debugger Setup Utility component of the IBM z/OS Debugger Utilities ISPF function is used to start the debugging session (where DTSU accesses *hlq*.SEQAMOD for you).

In all other cases, unless you put *hlq*.SEQAMOD in the system link list concatenation, the user will have to alter the execution environment of any program being debugged so that *hlq*.SEQAMOD is in the load module search path (such as placing it in JOBLIB, STEPLIB, ISPLLIB or via use of TSOLIB). Therefore, it is recommended that you add the *hlq*.SEQAMOD data set to the system link list concatenation⁵. For CICS, you also need to mark *hlq*.SEQAMOD as APF-authorized.

Unless you put *hlq*.SEQAMOD in the system link list concatenation, the user will have to alter the execution environment of any program being debugged so that *hlq*.SEQAMOD is in the load module search path (such as placing it in JOBLIB, STEPLIB, ISPLLIB or via use of TSOLIB). Therefore, it is recommended that you add the *hlq*.SEQAMOD data set to the system link list concatenation⁵.

hlq.SEQAMOD must be placed before any other library in the load module search path that contains CEEEVDBG for z/OS Debugger to get control of a debug session.

Chapter 6. Enabling debugging in full-screen mode using the Terminal Interface Manager

Note: This chapter is not applicable to IBM Developer for z/OS (non-Enterprise Edition) or IBM Z and Cloud Modernization Stack (Wazi Code).

To enable users to debug the following types of programs while using a 3270-type terminal, you need to enable full-screen mode using the Terminal Interface Manager:

- Batch programs
- TSO programs (using a separate terminal for debugging)
- Programs running under UNIX System Services
- Db2 stored procedures
- IMS programs

This topic focuses on setting up the Terminal Interface Manager to enable a terminal session that can be used to debug these types of programs in full-screen mode. To set up a dedicated terminal without using Terminal Interface Manager, see [Appendix B, “Enabling debugging in full-screen mode using a dedicated terminal,”](#) on page 191.

To understand how a user and z/OS Debugger interact with the Terminal Interface Manager, see [“How users start a full-screen mode debug session with the Terminal Interface Manager”](#) on page 17.

To enable debugging in full-screen mode using the Terminal Interface Manager, see [“Enabling full-screen mode using the Terminal Interface Manager”](#) on page 19. If you are running the Terminal Interface Manager on a VTAM® network with multiple LPARs, see [“Example: Defining the VTAM EQAMVnnn and Terminal Interface Manager APPL definition statements when z/OS Debugger runs on four LPARs”](#) on page 23 for variations on the instructions.

How users start a full-screen mode debug session with the Terminal Interface Manager

The following steps describe how a user would start a full-screen mode debugging session for a batch job with the Terminal Interface Manager. Study these steps to understand how z/OS Debugger uses the Terminal Interface Manager to display a full-screen mode debugging session and to understand why you need to do the configuration steps described in [“Enabling full-screen mode using the Terminal Interface Manager”](#) on page 19.

1. Start two terminal sessions. These sessions can be either of the following situations:
 - Two separate terminal emulator sessions.
 - If you use a session manager, two sessions selected from the session manager menu.In either situation, ensure that the second session connects to the Terminal Interface Manager.
2. On the first terminal session, log on to TSO.
3. On the second terminal session, provide your login credentials to the Terminal Interface Manager and press Enter. The login credentials can be your TSO user ID and password, PassTicket, password phrase, or MFA token.

Notes:

- a. You are not logging on TSO. You are indicating that you want your user ID associated with this terminal LU.
- b. When the number of characters entered into the password field, including blanks, exceeds 8, the input is passed to the security system as a password phrase.

- c. To use PassTickets with Terminal Interface Manager, define the PTKTDATA profile by following the rules for MVS batch jobs. For more information, see [Defining profiles in the PTKTDATA class in the z/OS documentation](#).

A panel similar to the following panel is then displayed on the second terminal session:

```
z/OS Debugger Terminal Interface
Manager
EQAY001I Terminal TRMLU001 connected for user USER1
EQAY001I Ready for z/OS Debugger

PF3=EXIT PF10=Edit LE options data set
PF12=LOGOFF
```

The terminal is now ready to receive a full-screen mode debugging session.

4. Edit the PARM string of your batch job so that you specify the TEST runtime parameter as follows:

```
TEST(,,,VTAM%userid:*)
```

5. Submit the batch job. The following tasks are done:
 - a. z/OS Debugger allocates a VTAM ACB (EQAMVnnn) for its end of a VTAM session.
 - b. z/OS Debugger communicates with the Terminal Interface Manager to request a session with the terminal LU on which it is running.
 - c. The Terminal Interface Manager releases the terminal LU and passes control of it to z/OS Debugger.
6. On the second terminal session, a full-screen mode debugging session is displayed. Interact with it the same way you would with any other full-screen mode debugging session.
7. After you exit z/OS Debugger, the second terminal session displays the panel and messages you saw in step “3” on page 17. This indicates that z/OS Debugger can use this session again. (This happens each time you exit z/OS Debugger.)
8. If you want to start another debugging session, return to step “5” on page 18. If you are finished debugging, you can do one of the following tasks:
 - Close the second terminal session.
 - Exit the Terminal Interface Manager by choosing one of the following options:
 - Press PF12 to display the Terminal Interface Manager logon panel. You can log in with the same ID or a different user ID.
 - Press PF3 to exit the Terminal Interface Manager.

This technique requires you to define and configure a number of items in the z/OS Communications Server. Section “[Enabling full-screen mode using the Terminal Interface Manager](#)” on page 19 describes these definitions and configuration.

Enabling full-screen mode using the Terminal Interface Manager

To enable full-screen mode using the Terminal Interface Manager, do the following steps:

1. Define the VTAM APPL definition statements that z/OS Debugger uses for its end of the session, as described in [“Defining the VTAM EQAMVnnn APPL definition statements”](#) on page 19.
2. Define the VTAM APPL definition statements that the Terminal Interface Manager uses, as described in [“Defining the Terminal Interface Manager APPL definition statements”](#) on page 20.
3. Start the Terminal Interface Manager, as described in [“Starting the Terminal Interface Manager”](#) on page 21.
4. Verify that full-screen mode using the Terminal Interface Manager is enabled, as described in [“Verifying the enablement of full-screen mode using the Terminal Interface Manager”](#) on page 22.

Defining the VTAM EQAMVnnn APPL definition statements

You must define the APPL definition statements that z/OS Debugger uses for its end of the VTAM session with the terminal LU. You can define up to 999 APPLs for z/OS Debugger. You can define an APPL by using one of the following naming conventions:

- Define each APPL with the following naming convention: the first five characters of the APPL name must be EQAMV and the last three characters must be consecutive three digit numbers, starting with 001. Do not code an ACBNAME operand on the APPL definition statements for this method.
- Define each APPL name with the naming convention you use at your site. Code an ACBNAME operand on the APPL definition statement that uses EQAMV as the first five characters, and three numeric digits (starting with 001) as the last three characters.

The number of APPL names you define must be sufficient to allow for the maximum number of concurrent z/OS Debugger full-screen mode using the Terminal Interface Manager sessions. (z/OS Debugger uses one of these APPL names for its end of each VTAM session that is initiated with a terminal LU.)

The descriptions and examples used in this book assume you defined APPL names by using the EQAMVnnn naming convention. z/OS Debugger uses the EQAMVnnn names for internal processing.

The EQAWAPPL member in the *hlq*.SEQASAMP data set predefines 50 APPL names, EQAMV001 to EQAMV050. You can do one of the following tasks to add this member to the VTAM definitions library (VTAMLST).

- Copy EQAWAPPL into a new member:
 1. Create a new member in the VTAM definitions library (VTAMLST). The VTAM definitions library is often stored in the data set SYS1.VTAMLST.
 2. Copy the contents of the EQAWAPPL member into the new member.
 3. Add the new member's name to the VTAM start options configuration file, ATCCONxx, so that VTAM activates the z/OS Debugger APPL definitions at initialization.
- Copy EQAWAPPL into an existing member that is already defined in VTAMLST:
 1. Select a member in the VTAM definitions library (VTAMLST) that contains the major node definitions.
 2. Copy the APPL definition statements for z/OS Debugger from the EQAWAPPL member into the selected member.

Tip: The existing member has the VBUILD TYPE=APPL statement, so do not copy this statement from EQAWAPPL.

If you are running VTAM in a multi-domain environment and you require the ability to debug full-screen mode using the Terminal Interface Manager on more than one host, edit the copy of EQAWAPPL on each system to make the names for z/OS Debugger major and minor nodes unique for each system.

For example, if you have hosts SYSA, SYSB, and SYSC, and need to provide definitions for up to 50 concurrent users debugging programs in full-screen mode using the Terminal Interface Manager on each system, you can code the following entries:

- SYSA VTAMLST EQAWAPPL entry:

```
EQAAPPLA VBUILD TYPE=APPL
EQAMV001 APPL AUTH=(PASS,ACQ),PARSESS=NO
EQAMV002 APPL AUTH=(PASS,ACQ),PARSESS=NO
...
EQAMV050 APPL AUTH=(PASS,ACQ),PARSESS=NO
```

- SYSB VTAMLST EQAWAPPL entry:

```
EQAAPPLB VBUILD TYPE=APPL
EQAMV051 APPL AUTH=(PASS,ACQ),PARSESS=NO
EQAMV052 APPL AUTH=(PASS,ACQ),PARSESS=NO
...
EQAMV100 APPL AUTH=(PASS,ACQ),PARSESS=NO
```

- SYSC VTAMLST EQAWAPPL entry:

```
EQAAPPLC VBUILD TYPE=APPL
EQAMV101 APPL AUTH=(PASS,ACQ),PARSESS=NO
EQAMV102 APPL AUTH=(PASS,ACQ),PARSESS=NO
...
EQAMV150 APPL AUTH=(PASS,ACQ),PARSESS=NO
```

You can have up to 999 unique APPL names for full-screen mode using the Terminal Interface Manager spread across your network. For an example on how to configure many APPL names in a network with multiple LPARs, see [“Example: Defining the VTAM EQAMVnnn and Terminal Interface Manager APPL definition statements when z/OS Debugger runs on four LPARs”](#) on page 23.

As an alternative to coding each minor node name, you can use the Model Application Names function. With this function, VTAM dynamically creates the minor nodes. Use one of the following ways (alter these examples, if needed, to maintain unique names per system as discussed in [“Defining the VTAM EQAMVnnn APPL definition statements”](#) on page 19):

- EQAMV??? APPL AUTH=(PASS,ACQ),PARSESS=NO
- ABCDE??? APPL AUTH=(PASS,ACQ),PARSESS=NO,ACBNAME=EQAMV???

Activating the VTAM EQAMVnnn APPLs

Activate the VTAM APPLs by entering the following command from the console, where *member-name* is the member name in the VTAM library (VTAMLST):

```
VARY NET,ACT,ID=member-name
```

Defining the Terminal Interface Manager APPL definition statements

You must define the APPL definition statements that the Terminal Interface Manager will use for its sessions. To define the APPL definition statements, do the following steps:

1. Define the APPL definition statements as shown in the EQAWSESS member in the *hlq.SEQASAMP* data set by doing one of the following tasks:
 - Copy EQAWSESS into a new member:
 - a. Create a new member in the VTAM definitions library (VTAMLST). The VTAM definitions library is often stored in the data set SYS1.VTAMLST.
 - b. Copy the contents of the EQAWSESS member into the new member.
 - c. Add the new member's name to the VTAM start options configuration file, ATCCONxxx.
 - Copy EQAWSESS into an existing member:
 - a. Select a member in the VTAM definitions library (VTAMLST) that contains the major node definitions.

- b. Copy the APPL definition statements for z/OS Debugger from the EQAWSESS member into the selected member.

To activate the new definitions, enter the following command from the console:

```
VARY NET,ACT,ID=member-name
```

member-name is the member name in the VTAM definitions library.

Starting the Terminal Interface Manager

The Terminal Interface Manager is a VTAM application that must be started (following the start of VTAM itself) before users can access it. Follow these steps to start it:

1. Copy the EQAYSESM member of the data set *hlq*.SEQASAMP to the SYS1.PROCLIB data set, making any changes required by your installation.
2. Make sure that the Terminal Interface Manager load modules, EQAYSESM and EQAYTRMM, reside in an APF authorized library (these module can be found in the *hlq*.SEQAAUTH data set). This is required to allow access to functions to validate users by login credentials.
3. Start the Terminal Interface Manager using the START command from the console. The START command can be added to the COMMNDxx member of SYS1.PARMLIB to start the Terminal Interface Manager when the system is IPLed.

The user ID associated with the STARTED class entry in RACF for the Terminal Interface Manager started task must have an OMVS segment defined. This enables the started task to use the POSIX thread functions.

The Terminal Interface Manager load module accepts six parameters, which you can provide by using the OPTS substitution variable on the START command or in the EQAYSESM PROC definition. You can code the parameters in any sequence and all of them are optional. The following list describes the parameters:

-a *acbname*

Specifies an alternate VTAM ACB name for the Terminal Interface Manager to open. For more information about this parameter, see [“Example: Defining the VTAM EQAMVnnn and Terminal Interface Manager APPL definition statements when z/OS Debugger runs on four LPARs” on page 23.](#)

-m

Instructs the Terminal Interface Manager not to fold passwords to upper case. If your security product is set up to use mixed-case passwords, and Terminal Interface Manager does not accept them, code this parameter.

-p *pattern-string*

Specifies a naming pattern for the TEST runtime options data set. You can use this parameter to override the default naming pattern. *pattern-string* must contain the string &USERID for substitution purposes. Otherwise, an error will be recognized and the default naming pattern &USERID.DBGTOOL.EQAUOPTS will be used.

-s

Instructs the Terminal Interface Manager to provide an entry field on each Terminal Interface Manager panel, in which the user can enter a session manager escape sequence.

+T

Display detailed trace messages for the Terminal Interface Manager. Do not use this parameter unless instructed by IBM support personnel.

-r

Start Terminal Interface Manager in repository mode. This enables users to register to debug IMS transactions or DB/2 stored procedures that are started by a generic user ID.

See [“DLAYDBGXRF” on page 165](#) for additional customization required when using this option.

The following example starts the Terminal Interface Manager for alternate ACB EQASESS2 and instructs it to provide an extra entry field for use with a session manager:

```
START EQAYSESM,OPTS='-a EQASESS2 -s'
```

Using the MODIFY operator command to display a list of Terminal Interface Manager users

Console operators can list the users who are currently logged on to the Terminal Interface Manager by using the z/OS MVS system MODIFY command. The list of users contains the user ID, the terminal LU that each user requests, and the job information if the user is currently in a z/OS Debugger session.

The syntax of the MODIFY command is:

```
►► MODIFY — tim-stc-name — , — APPL=LIST —
```

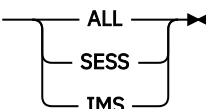

The following list describes the parameters of the MODIFY APPL=LIST command:

tim-stc-name

Is the name of the started task or job that is running the Terminal Interface Manager.

ALL

Lists all users who are logged on to the Terminal Interface Manager.

SESS

Only lists users who are logged on to the Terminal Interface Manager and are currently in a z/OS Debugger session.

IMS

Only lists users who are logged on to the Terminal Interface Manager and are currently in a z/OS Debugger session for an IMS message processing program.

Example

```
MODIFY EQAYSESM,APPL=LIST ALL
```

Example output

```
EQA9896I z/OS Debugger TIM USERS
USER ID   FLAGS   TERMINAL  JOBNAME
-----
USRT002   I       TRMLU006  MPRCI10X
USRT001   B       T1302     USRT001A
USRT003   L       TRMLU004  **NONE**
-----
L=LOGGED ON, NOT IN SESSION
I=IN SESSION; IMS JOB
B=IN SESSION; BATCH OR DB/2 JOB
```

Verifying the enablement of full-screen mode using the Terminal Interface Manager

To help you verify the enablement of full-screen mode using the Terminal Interface Manager, do the following steps:

1. Select which of the following installation verification jobs you want to run:
 - EQAWIVP5 (COBOL)
 - EQAWIVP6 (C)
 - EQAWIVP7 (PL/I)

- EQAWIVP9 (Enterprise PL/I)
 - EQAWIVPB (Language Environment assembler)
 - EQAWIVPD (non-Language Environment assembler)
 - EQAWIVPK (LangX Enterprise COBOL)
 - EQAWIVPW (OS/VS COBOL)
 - EQAWIVPY (non-Language Environment VS COBOL II)
2. Copy the job from the *hlq*.SEQASAMP data set to your own private data set and customize it for your installation as described in the sample.
 3. Connect a terminal session to the Terminal Interface Manager and log on to the Terminal Interface Manager with your TSO user ID.
 4. Run the customized installation verification jobs.

Example: Defining the VTAM EQAMVnnn and Terminal Interface Manager APPL definition statements when z/OS Debugger runs on four LPARs

The instructions in Chapter 6, “Enabling debugging in full-screen mode using the Terminal Interface Manager,” on page 17 assume that you create all the definitions and start the Terminal Interface Manager on one LPAR. This example describes the connections that need to be made in a VTAM network that has four LPARs that run z/OS Debugger jobs with one of the LPARs managing the terminals.

- LPAR 1 runs a TN3270E server and the Terminal Interface Manager with the default ACB name. Its VTAM also owns all the terminal LUs. Users connect their TN3270E emulator to this LPAR for the Terminal Interface Manager session. Users use the Terminal Interface Manager to create the connection between z/OS Debugger and the terminal LU used for their full-screen mode using the Terminal Interface Manager debugging session.
- VTAM on LPAR 1 defines the terminal LU APPL definition statements and the EQASESSM APPL definition statement for the Terminal Interface Manager.
- VTAM on LPAR 1 needs visibility to the EQAMVnnn APPL definition statements on LPARs 2, 3 and 4. This enables communication between the Terminal Interface Manager and z/OS Debugger.
- Each VTAM on LPAR 1, 2, 3 and 4 has a unique set of EQAMVnnn APPL definition statements. For example, LPAR 1 has APPL definition statements 001-050, LPAR 2 has APPL definition statements 051-100, LPAR 3 has APPL definition statements 101-150, and LPAR 4 has APPL definition statements 151-200.
- Each VTAM on LPAR 2, 3 and 4 needs visibility to the EQASESSM APPL definition statement on LPAR 1. This enables communication between z/OS Debugger and the Terminal Interface Manager.
- Each VTAM on LPAR 2, 3 and 4 needs visibility to the terminal LU APPL definition statements on LPAR 1.

Chapter 7. Adding support for remote debug users

If you have users running z/OS Debugger in remote debug mode, review the following list and complete the applicable tasks:

- Create an OMVS segment for each user ID that uses the remote debugger.
- If your TCP/IP stack name is not TCPIP, you can use the TCPIPDATADSN EQAOPTS command to instruct z/OS Debugger to dynamically allocate the correct SYSTCPD DD.
- If the source or compiler uses a code page other than 037, see [“CODEPAGE” on page 160](#).
- If you want z/OS Debugger to switch to full-screen mode or batch mode if the remote debugger is not available, see [“NODISPLAY” on page 176](#).
- For your CICS users, see [“Activating the TCP/IP Socket Interface for CICS” on page 25](#).
- With Debug Manager, remote Eclipse users do not need to open an outgoing port for the debug daemon on the z/OS system, or supply an IP address and port for debugging. For the differences between using Debug Manager and Debug Daemon port 8001, see [“TCP/IP ports” on page 42](#). For more information, see [“Enabling communication with Debug Manager” on page 25](#) and [“Understanding Debug Manager” on page 34](#).
- To enable interactive debugging in IBM Z Open Debug, see [“Adding support for Remote Debug Service” on page 52](#).
- If your users create and manage debug profiles in the **z/OS Debugger Profiles** view, see [“Adding support for Debug Profile Service” on page 58](#). For your CICS users, you can set up Debug Profile Service to [use external CICS interface \(EXCI\)](#) or [add support for the DTCN profiles API](#).
- To enable secure communication for incoming debug and code coverage sessions in the remote Eclipse IDE, see [“Enabling secure communication between z/OS Debugger and the remote debugger for incoming debug sessions” on page 77](#).

Related references

"Remote debug mode" in the *IBM z/OS Debugger User's Guide*

Activating the TCP/IP Socket Interface for CICS

You need to activate the appropriate TCP/IP socket interface to manage communication between your CICS region and the remote debugger. z/OS Debugger supports only the TCP/IP Socket Interface for CICS.

Activate the TCP/IP Socket Interface for CICS to enable the following functions:

- Communication between your CICS region and the remote debugger.
- Use of the IPv6 protocol in remote debug mode.

For instructions on activating the TCP/IP Socket Interface for CICS, see the *z/OS Communications Server IP CICS Sockets Guide*.

Enabling communication with Debug Manager

Debug Manager (DBGMGR) provides communication-related services to z/OS Debugger and the remote Eclipse client.

To use Debug Manager, apart from the host debugger, you also need to install the following components or products:

- IBM z/OS Explorer host.
- An Eclipse client of the following products:
 - IBM Debug for z/OS
 - IBM Developer for z/OS

Specifically, if the DBMDT TEST runtime parameters are used, Debug Manager is used with z/OS Explorer's Remote System Explorer daemon (RSED) to allow z/OS Debugger to resolve the client's workstation address.

This chapter describes how to set up the Debug Manager's started task, encryption, and security definitions.

To learn more about Debug Manager, see [“Understanding Debug Manager”](#) on page 34. For the differences between using Debug Manager and Debug Daemon port 8001, see [“TCP/IP ports”](#) on page 42.

Debug Manager configuration

PARMLIB changes

Adding the started task to COMMNDxx

Add a start command for the Debug Manager server to SYS1.PARMLIB(COMMNDxx) to start it automatically at the next system IPL. Define CMD=xx in the IEASYSxx parmlib member to specify the COMMNDxx parmlib member that is used during IPL.

After the server is defined and configured, it can be started dynamically (until the next IPL) with the following console command:

```
S DBGMGR
```

Note: There is no specific startup order for the server. The only requirement is that the server is up and running before the first user tries to connect. Note that the Debug Manager server depends on the z/OS Explorer's Remote System Explorer daemon server (RSED) to also be running.

APF authorization in PROGxx

For Debug Manager to work, the modules in the EQAW.SEQAAUTH load library must be APF-authorized.

APF authorizations are defined in SYS1.PARMLIB(PROGxx) by default. Define PROG=xx in the IEASYSxx parmlib member to specify the PROGxx parmlib member that is used during IPL.

APF authorization can be set dynamically (until the next IPL) with the following console command, where `volser` is the volume on which the data set resides if it is not SMS-managed:

- SETPROG APF,ADD,DSN=EQAW.SEQAAUTH,SMS
- SETPROG APF,ADD,DSN=EQAW.SEQAAUTH,VOL=volser

Note: Some of the prerequisite and co-requisite products, such as z/OS Explorer, also require APF authorization. For more information, see the related product customization guides.

Running Debug Manager as a started task or user job

You can add the Debug Manager started task to the system PROCLIB to run it as a started task, or you can define a RACF profile to run it as a user job.

Running Debug Manager as a started task by using command line parameters

You can add the Debug Manager started task to the system PROCLIB to run it as a started task by using command-line parameters.

Customize the EQAW.SEQASAMP(EQAZPCM) sample started task member, as described within the member, and copy it to SYS1.PROCLIB as member DBGMGR. As shown in the following code sample, provide the following information:

- The time-zone offset, default EST5DST
- The port used for external (client-host) communication, default 5335

- The port used for internal (host-confined) communication, default 5336
- The high-level qualifier of the load library, default EQAW

```

/*
/* z/OS Debugger Debug Manager
/*
/*DBGMGR   PROC PRM=,           * PRM=DEBUG TO START TRACING
/*          LEPRM='RPTOPTS(ON)',
/*          TZ='EST5EDT',
/*          CLIENT=5335,
/*          HOST=5336,
/*          HLQ=EQAW
/*
/*DBGMGR   EXEC PGM=EQAZPCM,REGION=0M,TIME=NOLIMIT,
/*          PARM=('&LEPRM ENVAR("TZ=&TZ")/&HOST &CLIENT &PRM')
/*STEPLIB DD DISP=SHR,DSN=&HLQ..SEQAAUTH
/*SYSPRINT DD SYSOUT=*
/*SYSOUT   DD SYSOUT=*
/*          PEND
/*
/*

```

Figure 1. DBGMGR: Debug Manager started task by using command-line parameters

Notes:

- This started task is optional. It is used by z/OS Debugger if the DBMDT TEST runtime parameter is used.
- For the recommended Workload Manager (WLM) goals for this task, see [“WLM considerations” on page 48](#).

Running Debug Manager as a started task with a configuration file

You can start Debug Manager with a configuration file, especially when the length of the command line with all necessary options exceeds the 100 characters limit, for example, in the sysplex environment.

The configuration file is a z/OS UNIX file that is passed to Debug Manager as a command-line parameter.

```

/*
/* z/OS Debugger Debug Manager
/*
/*DBGMGR   PROC PRM=,           * PRM=DEBUG TO START TRACING
/*          LEPRM='RPTOPTS(ON)',
/*          HLQ=EQAW
/*
/*DBGMGR   EXEC PGM=EQAZPCM,REGION=0M,TIME=NOLIMIT,
/*          PARM=('&LEPRM /CONFIG=/u/ibmuser/dbm.cfg')
/*STEPLIB DD DISP=SHR,DSN=&HLQ..SEQAAUTH
/*SYSPRINT DD SYSOUT=*
/*SYSOUT   DD SYSOUT=*
/*          PEND
/*
/*

```

Figure 2. DBGMGR: Debug Manager started task with a configuration file

Figure 3 on page 27 shows the example configuration file dbm.cfg called in Figure 2 on page 27.

```

#required parameters
INTERNALPORT = 5336
EXTERNALPORT = 5335
#optional parameters
SVCNUMBER = 0
TRACELEVEL = DEBUG
SAFCLASS = FACILITY
HUBIP = 1.2.3.4
HUBPORT = 5337
HUBKEY = passphrase
VIPA = OFF
#environment vars
TZ=EST5EDT

```

Figure 3. Debug Manager configuration file

The configuration file is not case-sensitive and consists of lines in the key=value format. A line can also start with # and is considered a comment in this case.

The following parameter keys can be specified in the configuration file:

INTERNALPORT

Port for local communication

EXTERNALPORT

Port for client-host communication

SVCNUMBER

SVC number, which is always 0 unless you need compatibility with the Integrated Debugger in Rational Developer for z System 9.5.x.

TRACELEVEL

Trace level for DBM output. The following values are valid:

- ERROR
- INFO
- DEBUG
- VERBOSE

TRUSTEDTCP

- ON: Trusted TCP authentication is enabled. This is the default value. You also need to give access to trusted TCP to the user that the Debug Manager task is started under. For more information, see “Trusted TCP authentication for sysplex connections” on page 34.
- OFF: Trusted TCP authentication is disabled.

SAFCLASS

RACF SAF class for the case where DBM is started as a user job. The default value is FACILITY.

HUBIP

IPv4 or IPv6 IP address for the primary node in the sysplex. All DBM instances must use the same IP address.

HUBPORT

Port for inter-sysplex communication

HUBKEY

Key used to authenticate secondary nodes. The maximum length is 32 characters.

VIPA

- OFF: LPARs are accessible externally by their IP addresses. This is the default value.
- ON: The client uses a single IP address to connect to sysplex. LPARs must use unique EXTERNALPORT values so that the client can connect to the LPAR with a debug session.

Any other key is set as an environment variable, for example, TZ as in Figure 3 on page 27.

Running Debug Manager as a started task by using environment variables

Starting from z/OS Debugger 16.0.4, Debug Manager supports passing parameters through environment variables.

During its startup, Debug Manager checks whether any environment variable has the same name as its parameter, such as INTERNALPORT, EXTERNALPORT. This approach allows passing parameters by using XL C/C++ _CEE_ENVFILE parameter as follows.

```

...
// *
//DBGMGR EXEC PGM=EQAZPCM,REGION=0M,TIME=NOLIMIT,
// PARM=('&LEPRM,ENVAR("_CEE_ENVFILE=DD:ENVARS")/')
//ENVARS DD *
INTERNALPORT=5336
EXTERNALPORT=5335
TRACELEVEL=DEBUG
SAFCLASS=FACILITY
HUBIP=1.2.3.4
HUBPORT=5337
VIPA=OFF
TZ=EST5EDT
...

```

Figure 4. DBGMGR: Debug Manager started task by using environment variables

Starting Debug Manager as a user job

When not run as a started task, Debug Manager queries your security product for explicit permission to start.

Table 5. Debug Manager batch startup profile	
Security profile	Required access
EQADTOOL.START.BATCH.jobname.port	READ

Table 6. Substitutions	
Name	Substitution
jobname	Name of the job
port	port number (the port used for internal communication)

The security class where this profile resides can be specified with SAFCLASS command line parameter, and is defined as FACILITY by default. Use SAFCLASS=CLASS_NAME command line option to modify the default name. When the profile is not defined or the class is not active, permission is denied and batch startup fails.

Use the following sample RACF commands to allow user ID IBMUSER to start Debug Manager in batch with job name EQADBM and port 5336:

- RDEFINE FACILITY EQADTOOL.START.BATCH.EQADBM.5336 UACC(NONE) DATA('start DBM in batch')
- PERMIT EQADTOOL.START.BATCH.EQADBM.5336 CLASS(FACILITY) ACCESS(READ) ID(IBMUSER)
- SETROPTS RACLIST(FACILITY) REFRESH

Network configuration

Debug Manager TCP/IP updates

The Debug Manager uses the following TCP/IP ports:

- Port for client-host communication (default 5335). Communication on this port can be encrypted.
- Port for host-confined communication (default 5336).
- Port for inter-sysplex communication (default 5337), when the sysplex support is enabled.

Encrypted communication

If the debug client uses encryption to communicate with the Remote System Explorer (RSE) daemon, by default, the client also uses encryption to communicate with the host-based Debug Manager.

The following table shows whether a debug session can be started successfully with encrypted communication disabled or enabled for RSE and Debug Manager.

	DBGMGR encrypted communication enabled ¹	DBGMGR encrypted communication disabled
RSE encrypted communication enabled	The debug session starts in secured mode. ²	Ask the user to confirm unsecured connection and then proceed as normal.
RSE encrypted communication disabled	The debug session cannot be started.	The debug session starts in unsecured mode.

Notes:

1. Unlike RSE daemon, Debug Manager does not have native support for encrypted communication. To enable encryption, [create an AT-TLS policy for the port used by Debug Manager](#).
2. Users can start debug sessions without prompts only when the same certificates as RSE, or different chained certificates of the same CA root are used for Debug Manager. Certificates of different CA roots are considered as untrusted, and users need to take actions before they establish debug connection.

Creating an AT-TLS policy for the port used by Debug Manager

The Debug Manager relies on a TCP/IP service called Application Transparent Transport Layer Security (AT-TLS) for encrypted communication. For a step-by-step setup guide, see [“Setting up AT-TLS” on page 35](#).

To enable encryption, create an AT-TLS policy for the port used by Debug Manager for external communication, by default 5335. See the following sample policy.

```
TTLSPolicy zOS_Debugger_Debug_Manager
{
  LocalPortRange 5335
  Direction      Inbound
  TTLSPolicyRef  grp_Production
  TTLSActionRef  act_zOS_Debugger_Debug_Manager
}
TTLSAction act_zOS_Debugger_Debug_Manager
{
  HandshakeRole Server
  TTLSKeyRingParms
  {
    Keyring dbgmgr.racf # Keyring must be owned by the Debug Manager
  }
}
TTLSPolicyRef grp_Production
{
  TTLSActionEnabled On
  Trace 2
}
```

Debug Manager security definitions

The following list is an overview of the actions that are required to complete the basic security setup of Debug Manager. As documented in the following sections, different methods can be used to fulfill these requirements, depending on the required security level.

For more information about the sample RACF commands, see *RACF Command Language Reference* (SA22-7687).

Activating the security settings and classes

Debug Manager uses a variety of security mechanisms to ensure a secure and controlled host system environment for the client. To do so, several classes and security settings must be active, as shown with the following sample RACF commands:

- Display current settings
 - SETROPTS LIST
- Activate facility class for Debug Manager
 - SETROPTS GENERIC(FACILITY)
 - SETROPTS CLASSACT(FACILITY) RACLIST(FACILITY)
- Activate started task definitions for Debug Manager
 - SETROPTS GENERIC(STARTED)
 - RDEFINE STARTED ** STDATA(USER(=MEMBER) GROUP(STCGROUP) TRACE(YES))
 - SETROPTS CLASSACT(STARTED) RACLIST(STARTED)

Defining the Debug Manager started task

The following sample RACF commands create the DBGMGR started task, with protected user ID (STCDBM) and the STCGROUP group assigned to it.

- ```
ADDGROUP STCGROUP OMVS(AUTOUID)
DATA('GROUP WITH OMVS SEGMENT FOR STARTED TASKS')
```
- ```
ADDUSER STCDBM DFLTGRP(STCGROUP) NOPASSWORD NAME('DEBUG MANAGER')
OMVS(AUTOUID HOME(/tmp) PROGRAM(/bin/sh) )
DATA('IBM z/OS Debugger')
```
- ```
RDEFINE STARTED DBGMGR.* DATA('DEBUG MANAGER')
STDATA(USER(STCDBM) GROUP(STCGROUP) TRUSTED(NO))
```
- ```
SETROPTS RACLIST(STARTED) REFRESH
```

Note:

- Ensure that the started task user ID is protected by specifying the NOPASSWORD keyword.
- The Debug Manager started task (DBGMGR) is used only by z/OS Debugger when the DBMDT TEST runtime parameter is used.

Defining Debug Manager as a secure z/OS UNIX server

Debug Manager requires UPDATE access to the BPX.SERVER profile to create or delete the security environment for the debug thread.

Note: Using UID(0) to bypass this requirement is not supported.

This permit is required only when the Debug Manager feature is used.

- RDEFINE FACILITY BPX.SERVER UACC(NONE)
- PERMIT BPX.SERVER CLASS(FACILITY) ACCESS(UPDATE) ID(STCDBM)
- SETROPTS RACLIST(FACILITY) REFRESH



Attention: Defining the BPX.SERVER profile makes z/OS UNIX as a whole switch from UNIX level security to z/OS UNIX level security, which is more secure. This switch might impact other z/OS UNIX applications and operations. Test the security before activating it on a production system. For more information about the different security levels, see *UNIX System Services Planning* (GA22-7800).

Defining the MVS program controlled libraries for Debug Manager

Servers with authority to BPX.SERVER must run in a clean, program-controlled environment. This requirement implies that all programs called by Debug Manager must also be program controlled. For MVS load libraries, program control is managed by your security software.

Debug Manager uses system libraries, Language Environment's runtime, and the z/OS Debugger (EQAW.SEQAAUTH) load library.

- RALTER PROGRAM ** UACC(READ) ADDMEM('SYS1.LINKLIB'//NOPADCHK)
- RALTER PROGRAM ** UACC(READ) ADDMEM('SYS1.CSSLIB'//NOPADCHK)
- RALTER PROGRAM ** UACC(READ) ADDMEM('CEE.SCEERUN'//NOPADCHK)
- RALTER PROGRAM ** UACC(READ) ADDMEM('CEE.SCEERUN2'//NOPADCHK)
- RALTER PROGRAM ** UACC(READ) ADDMEM('EQAW.SEQAAUTH'//NOPADCHK)
- SETROPTS WHEN(PROGRAM) REFRESH

Note: Do not use the ** profile if you already have a * profile in the PROGRAM class. The profile obscures and complicates the search path used by your security software. In this case, you must merge the existing * and the new ** definitions. Use the ** profile, as documented in *Security Server RACF Security Administrator's Guide* (SA22-7683).

Verifying the security settings

- Security setting and classes
 - SETROPTS LIST
- Started tasks
 - LISTGRP STCGROUP OMVS
 - LISTUSER STCDBM OMVS
 - RLIST STARTED DBGMGR.* ALL STDATA
- Debug Manager as a secure z/OS UNIX server
 - RLIST FACILITY BPX.SERVER ALL
- MVS program controlled libraries for Debug Manager
 - RLIST PROGRAM ** ALL

Verifying the DBGMGR started task

Start the DBGMGR started task or user job. The server issues the following console message upon successful startup, where `clientport` is the number of the port used for external (client-host) communication, and `hostport` is the port number used for internal (host-confined) communication.

```
EQACM001I Debug Manager startup complete (clientport/hostport)
```

If the job ends with return code 66, then EQAW.SEQAAUTH is not APF-authorized.

Running the installation verification programs for Debug Manager

The following installation verification programs are available for Debug Manager:

- Batch. For more information, see [“Running the installation verification programs for SVCs” on page 10](#).
- CICS. For more information, see [“Running the installation verification programs in a CICS region” on page 120](#).

Enabling sysplex support

With the sysplex support enabled, Debug Manager can establish communication between the client and the debugger if the LPAR that the client is connected to via RSE and the LPAR with a started debug session are different.

To enable sysplex support, complete the following steps:

1. Ensure that Debug Manager is configured in all LPARs that the debugger runs on or that the user connects to via RSE.
2. Start Debug Manager instances on all LPARs with HUBIP and HUBPORT parameters equal to the IP address and port number of one of the LPARs. That LPAR will become a primary node and the others will connect to it and act as secondary nodes. Any instance that fails to bind or connect will continue to work stand-alone on its LPAR, periodically trying to connect to the hub. If you want to change the primary node assignment when Debug Manager is running, you can use the [Debug Manager console command H](#). For more information on how to start Debug Manager with a configuration file, see [“Running Debug Manager as a started task with a configuration file”](#) on page 27.

Below is how it works after sysplex support is enabled:

1. Secondary nodes connect to the primary node.
2. The primary instance is notified when a debug session is started in an LPAR but no RSE connection can be found.
3. The primary node finds the LPAR with an active RSE connection and connect it to the LPAR where the debug session is waiting.

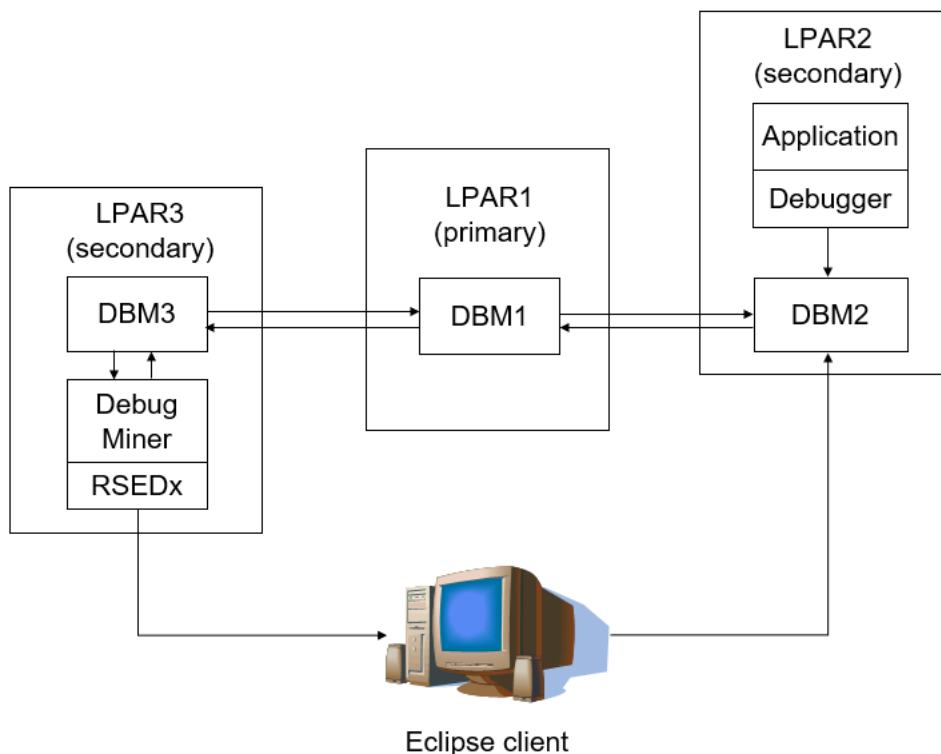

Figure 5. Debug Manager instances in a sysplex environment.

Trusted TCP authentication for sysplex connections

Starting from 16.0.4, Debug Manager supports authentication of other Debug Manager instances connecting to its hub port by using [Trusted TCP](#). To enable it in Debug Manager, set the **TRUSTEDTCP** parameter to ON and enter the following RACF commands or their equivalents in other security products:

```
RDEFINE SERVAUTH EZB.IOCTL.sysname.tcpprocname.PARTNERINFO UACC(NONE)
PERMIT EZB.IOCTL.sysname.tcpprocname.PARTNERINFO CLASS(SERVAUTH) ID(dbgmgrSTCUser) ACCESS(READ)
SETROPTS RACLIST(SERVAUTH) REFRESH
RDEFINE SERVAUTH EZBDOMAIN APPLDATA('EQAZPCMDOMAIN')
SETROPTS RACLIST(SERVAUTH) REFRESH
```

You can use wildcards in the values for *sysname* and *tcpprocname*.

For more information about these commands, see [Steps for retrieving partner security credentials](#).

Note: Debug Manager instances on all LPARS must be started under the same user ID.

Debug Manager configuration reference

Understanding Debug Manager

Debug Manager provides communication-related services to z/OS Debugger and the remote Eclipse client. It circumvents the need to open outbound ports from z/OS and for users to track their IP address. For differences between usages with and without Debug Manager, see the figures in [“TCP/IP ports”](#) on page 42.

Figure 6 on page 34 shows a schematic overview of how an Eclipse client uses Debug Manager when you debug an application. In a Sysplex environment, Debug Manager instances on different LPARs also maintain a communication with each other to establish connection even in the case when the LPAR that a user is logged on and the LPAR where a debug session has started are different. For more information, see [“Enabling sysplex support”](#) on page 33.

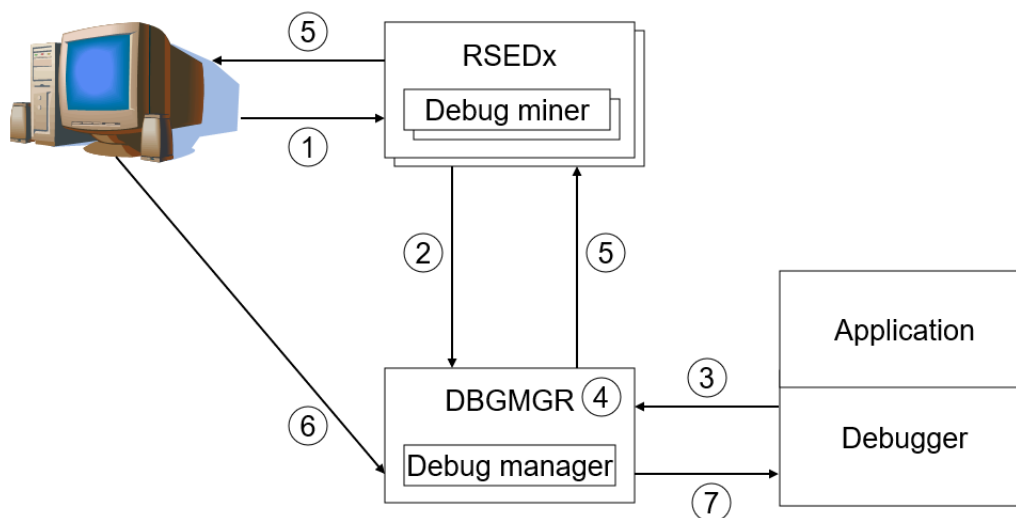

Figure 6. Debug Manager

1. The client connects to the host by using a z/OS connection in the **Remote Systems** view.
2. As part of the logon, Debug Miner registers the user with Debug Manager, which is active within the DBGMGR started task.
3. When the program to be debugged starts, z/OS Debugger sends the debug request to Debug Manager.

4. Debug Manager checks whether the debug session user is registered. If the user is not registered at this moment, the debug session goes dormant. z/OS Debugger will wait up to two times of *\$VALUE*. If the user still has not signed on to the z/OS connection in the **Remote Systems** view and is not registered with Debug Manager, the debug session will time out.
5. If the user is registered, Debug Manager notifies the Eclipse client that a new debug session is available.
6. The Eclipse client makes a TCPIP connection to the external Debug Manager port.
7. Debug Manager passes the TCPIP connection to z/OS Debugger, which allows the user to control the debug session.

For more information about TCPIP and DBMDT options and the *user_id* option for DBM/DBMDT, see "Syntax of the TEST runtime option" in *IBM z/OS Debugger Reference and Messages*.

Setting up AT-TLS

This section is provided to assist you with some common problems that you might encounter when setting up Application Transparent Transport Layer Security (AT-TLS), or during checking or modifying an existing setup.

The Transport Layer Security (TLS) protocol defined in RFC 2246 provides communications privacy over the internet. Similar to its predecessor Secure Socket Layer (SSL), the protocol enables client and server applications to communicate in a way that is designed to prevent eavesdropping, tampering, and message forgery. Application Transparent Transport Layer Security (AT-TLS) consolidates TLS implementation for z/OS-based applications in one location, allowing all applications to support TLS-based encryption without knowledge of the TLS protocol. For more information on AT-TLS, See *Communications Server IP Configuration Guide* (SC31-8775).

The information in this section shows how to set up the TCP/IP Policy Agent that manages AT-TLS and define a policy for usage by DBGMR on a z/OS 1.13 system, with support for TLS v1.2.

1. [“Setting up syslogd” on page 35](#)
2. [“AT-TLS configuration in PROFILE.TCPIP” on page 36](#)
3. [“Policy Agent started task” on page 36](#)
4. [“Policy Agent configuration” on page 37](#)
5. [“AT-TLS policy” on page 37](#)
6. [“AT-TLS security updates” on page 39](#)
7. [“AT-TLS policy activation” on page 42](#)

Throughout this section, a uniform naming convention is used:

- Debug Manager port for external communication: 5335
- Debug Manager user ID: stcdbm
- Policy agent user ID: pagent
- Certificate: dbgmgr
- Key and certificate storage: dbgmgr.racf

Some tasks described in the following sections expect you to be active in z/OS UNIX. This can be done by issuing the TSO command **OMVS**. Use the **oedit** command to edit files in z/OS UNIX. Use the **exit** command to return to TSO.

Setting up syslogd

The TCP/IP documentation recommends writing Policy Agent messages to the z/OS UNIX syslog instead of using the default log file. AT-TLS always writes messages to the z/OS UNIX syslog.

In order to do so, the z/OS UNIX syslog daemon, `syslogd`, must be configured and active. You also need a mechanism to control the size of the log files created by `syslogd`.

The following sample configuration file updates can be used to configure and start syslogd, with a simple log file management mechanism (erase existing logs when z/OS UNIX starts and create new ones upon syslogd startup).

- /etc/services

```
syslog      514/udp
```

- /etc/syslog.conf

```
# /etc/syslog.conf - control output of syslogd
# 1. all files with will be printed to /tmp/syslog.auth.log
auth.*      /tmp/syslog.auth.log
# 2. all error messages printed to /tmp/syslog.error.log
*.err       /tmp/syslog.error.log
# 3. all debug and above messages printed to /tmp/syslog.debug.log
*.debug     /tmp/syslog.debug.log
# The files named must exist before the syslog daemon is started,
# unless -c startup option is used
```

- /etc/rc

```
# Start the SYSLOGD daemon for logging
# (clean up old logs)
sed -n '/^#/#/!s/.* \\.*)\\|1/p' /etc/syslog.conf | xargs -i rm {}
# (create new logs and add userid of message sender)
_BPX_JOBNAME='SYSLOGD' /usr/sbin/syslogd -cuf /etc/syslog.conf &
sleep 5
```

AT-TLS configuration in PROFILE.TCPIP

AT-TLS support is activated by the TTLS parameter on the TCPCONFIG statement in the PROFILE.TCPIP data set. AT-TLS is managed by the Policy Agent, which must be active to be able to enforce the AT-TLS policy. Since the Policy Agent must wait for TCP/IP to be active, the AUTOSTART statement in PROFILE.TCPIP is a good place to trigger startup of this server.

These requirements result in the following changes to PROFILE.TCPIP, often named TCPIP.TCPPARMS(TCPPROF).

```
TCPCONFIG TTLS          ; Required for AT-TLS
AUTOLOG
  PAGENT                ; POLICY AGENT, required for AT-TLS
ENDAUTOLOG
```

Policy Agent started task

As mentioned in the previous text, AT-TLS is managed by the Policy Agent, which can be started as a started task. Use the following JCL to create SYS1.PROCLIB(PAGENT), using the default configuration file and the recommended log location (SYSLOGD). The necessary definitions in your security software are covered later.

```
//PAGENT  PROC PRM='-L SYSLOGD'                * '' or '-L SYSLOGD'
//*
//* TCP/IP POLICY AGENT
//*                                     (PARM) (envar)
//* default cfg file: /etc/pagent.conf      (-C) (PAGENT_CONFIG_FILE)
//* default log file: /tmp/pagent.log      (-L) (PAGENT_LOG_FILE)
//* default log size: 300,3 (3x 300KB files) (PAGENT_LOG_FILE_CONTROL)
//*
//PAGENT  EXEC PGM=PAGENT,REGION=0M,TIME=NOLIMIT,
//        PARM='ENVAR("TZ=EST5DST")/&PRM'
//SYSPRINT DD SYSOUT=*
//SYSOUT  DD SYSOUT=*
//*
```

Policy Agent configuration

The Policy Agent enforces TCP/IP related policies created by the TCP/IP administrator. It manages policies for AT-TLS, called TTLS, but also for other services such as IPSec. The Policy Agent uses a configuration file to know which policies must be enforced, and where they can be found. The default configuration file is `/etc/pagent.conf`, but a different location can be specified in the Policy Agent started task JCL.

```
#
# TCP/IP Policy Agent configuration information.
#
TTLSConfig /etc/pagent.ttls.conf
# Specifies the path of a TTLS policy file holding stack specific
# statements.
#
#TcpImage TCPIP /etc/pagent.conf
# If no TcpImage statement is specified, all policies will be installed
# to the default TCP/IP stack.
#
#LogLevel 31
# The sum of the following values that represent log levels:
# LOGL_SYSERR      1
# LOGL_OBJERR      2
# LOGL_PROTERR     4
# LOGL_WARNING     8
# LOGL_EVENT       16
# LOGL_ACTION      32
# LOGL_INFO        64
# LOGL_ACNTING    128
# LOGL_TRACE       256
# Log Level 31 is the default log loglevel.
#
#Codepage IBM-1047
# Specify the EBCDIC code page to be used for reading all configuration
# files and policy definition files. IBM-1047 is the default code page.
```

This sample configuration file specifies where the Policy Agent can find the TTLS policy. It uses Policy Agent default values for other statements.

AT-TLS policy

A TTLS policy describes the desired AT-TLS rules. As defined in the Policy Agent configuration file, the TTLS policy is located in `/etc/pagent.ttls.conf`. The necessary definitions in your security software are covered later.

This example shows a fairly simple, two-rule policy that disables SSL v3 and enables TLS v1, TLS v1.1, and TLS v1.2 support for both communication paths supported by the z/OS RSE connection, Debug Manager, and Debug Engine-Client. As defined in the Policy Agent configuration file, the TTLS policy is located in `/etc/pagent.ttls.conf`.

```
###
### TCP/IP Policy Agent AT-TLS configuration information.
###
###-----
TTLSRule                                zOS_Debugger_Debug_Manager
{
  LocalPortRange                        5335
  Direction                             Inbound
  TTLSGroupActionRef                   grp_Production
  TTLSEnvironmentActionRef              act_zOS_Debugger_Debug_Manager
}
###-----
TTLSEnvironmentAction                    act_zOS_Debugger_Debug_Manager
{
  HandshakeRole Server
  TTLSKeyRingParms
  {
    Keyring dbgmgr.racf                # Keyring must be owned by the Debug Manager
  }
}
TTLSEnvironmentAdvancedParms
{
  ApplicationControlled Off
  TLsv1.2 On
  # TLsv1 & TLsv1.1 are on by default
```

```

SSLV3 Off
# disable SSLv30
}
}
###-----
TTLSTGroupAction          grp_Production
{
  TTLSEnabled              On
  Trace                    3      # Log Errors to syslogd & IP joblog
#Trace                    254    # Log everything to syslogd
}

```

A TTLS policy allows for a wide range of filters to specify when a rule applies.

Debug Manager is a server that listens on port 5335 for incoming connections from Debug Engine. This information is captured in the `zOS_Debugger_Debug_Manager` rule.

Since encrypted communication requires the usage of a server certificate, you specify that the Policy Manager must use the certificates on the `dbgmgr.racf` key ring, which is owned by the Debug Manager started task user ID. By default, TLS v1.2 support is disabled, so this policy explicitly enables it. SSLv3.0 is explicitly disabled due to known vulnerabilities in this protocol.

Note: For more complex policies, you should use the IBM Configuration Assistant for z/OS Communications Server. This is a GUI-based tool that provides a guided interface for configuring TCP/IP policy-based networking functions and is available as a task in IBM z/OS Management Facility (z/OSMF), and as a stand-alone workstation application.

AT-TLS policy in the sysplex environment

Similar to AT-TLS rules for configuring the communication between Debug Manager and the client via the external port, communication between Debug Manager instances running on different LPARs in the sysplex environment can also be configured with AT-TLS policies.

The primary node can use a configuration identical to the example above. A secondary node is acting as a client that connects to `primary_node_ip:5337` in this communication. The example below shows outbound policy that disables SSL v3 and enables TLS v1, TLS v1.1, and TLS v1.2 support. The group action reference `grp_Production` is identical to the one above and thus not shown here.

```

###
### TCP/IP Policy Agent AT-TLS configuration information.
###
###-----
TTLSTRule                  zOS_Debugger_DBM_SN
{
  RemoteAddr               primary_node_ip
  RemotePortRange          5337
  Direction                 Outbound
  TTLSGroupActionRef       grp_Production
  TTLSEnvironmentActionRef act_zOS_Debugger_DBM_SN
}

###-----
TTLSEnvironmentAction      act_zOS_Debugger_DBM_SN
{
  HandshakeRole Client
  TTLSKeyRingParms
  {
    Keyring dbgmgr.racf      # Keyring must be owned by the Debug Manager
  }
  TTLSEnvironmentAdvancedParms
  {
    ApplicationControlled Off
    TTLSV1.2 On
    # TTLSv1 & TTLSv1.1 are on by default
    SSLV3 Off
    # disable SSLv3
  }
}
}

```

AT-TLS security updates

Several updates are required to your security setup for AT-TLS to work properly. Use sample RACF commands in this topic to do the required setup.

Started task setup

As mentioned in “Policy Agent started task” on page 36, you use a started task to run the Policy Agent. This requires the definition of a started task user ID and a profile in the STARTED class.

```
# define started task user ID
# BPX.DAEMON permit is required for non-zero UID
ADDUSER PAGENT DFLTGRP(SYS1) OMVS(UID(0) SHARED HOME('/')) +
  NAME('TCP/IP POLICY AGENT') NOPASSWORD

# define started task
RDEFINE STARTED PAGENT.* STDATA(USER(PAGENT) GROUP(SYS1)) +
  DATA('TCP/IP POLICY AGENT')

# refresh to make the changes visible
SETROPTS RACLIST(STARTED) REFRESH
```

Policy Agent startup permission

Define a profile named MVS.SERV MGR.PAGENT in the OPERCMDS class and give user ID PAGENT CONTROL access to it. The profile restricts who can start the Policy Agent. If the profile is not defined, and access to it is prevented through a generic profile, PAGENT will not be able to start the Policy Agent, which will prevent TCP/IP stack initialization.

```
# restrict startup of policy agent
RDEFINE OPERCMDS MVS.SERV MGR.PAGENT UACC(NONE) +
  DATA('restrict startup of policy agent')
PERMIT MVS.SERV MGR.PAGENT CLASS(OPERCMDS) ACCESS(CONTROL) ID(PAGENT)

# refresh to make the changes visible
SETROPTS RACLIST(OPERCMDS) REFRESH
```

INITSTACK protection

As mentioned in “AT-TLS configuration in PROFILE.TCPIP” on page 36, the Policy Agent is started after TCP/IP is initialized. This means that there is a (small) window where applications can use the TCP/IP stack without the TTLS policy being enforced. Define the EZB.INITSTACK.** profile in the SERVAUTH class to prevent access to the stack during this time window, except for applications with READ access to the profile. You must permit a limited set of administrative applications to the profile to ensure full initialization of the stack, as documented in “TCP/IP stack initialization access control” in *Communications Server IP Configuration Guide (SC31-8775)*.

Note: The Policy Agent issues message EZD1586I when all policies are active.

```
# block stack access between stack and AT-TLS availability
# SETROPTS GENERIC(SERVAUTH)
# SETROPTS CLASSACT(SERVAUTH) RACLIST(SERVAUTH)
RDEFINE SERVAUTH EZB.INITSTACK.** UACC(NONE)
# Policy Agent
PERMIT EZB.INITSTACK.** CLASS(SERVAUTH) ACCESS(READ) ID(PAGENT)
# OMROUTE daemon
PERMIT EZB.INITSTACK.** CLASS(SERVAUTH) ACCESS(READ) ID(OMROUTE)
# SNMP agent and subagents
PERMIT EZB.INITSTACK.** CLASS(SERVAUTH) ACCESS(READ) ID(OSNMPD)
PERMIT EZB.INITSTACK.** CLASS(SERVAUTH) ACCESS(READ) ID(IOBSNMP)
# NAME daemon
PERMIT EZB.INITSTACK.** CLASS(SERVAUTH) ACCESS(READ) ID(NAMED)

# refresh to make the changes visible
SETROPTS RACLIST(SERVAUTH) REFRESH
```

Optional: pasearch protection

The z/OS UNIX pasearch command displays active policy definitions. Define profile EZB.PAGENT.** in the SERVAUTH class to restrict access to the pasearch command.

```
# restrict access to pasearch command
# RDEFINE SERVAUTH EZB.PAGENT.** UACC(NONE) +
# DATA('restrict access to pasearch command')
# PERMIT EZB.PAGENT.** CLASS(SERVAUTH) ACCESS(READ) ID(tcpadmin)

# refresh to make the changes visible
# SETROPTS RACLIST(SERVAUTH) REFRESH
```

Certificate setup

As mentioned in [“AT-TLS policy” on page 37](#), Debug Manager needs a certificate so that AT-TLS can set up encrypted communication on Debug Manager’s behalf. These sample commands create a new certificate that is labeled dbgmgr, which is stored in a RACF key ring named dbgmgr.racf. Both the certificate and the key ring are owned by STCDBM, the Debug Manager started task user ID.

```
# activate class holding profiles that control certificate access
SETROPTS CLASSACT(RDATALIB) RACLIST(RDATALIB)

# define profiles that control certificate access
RDEFINE RDATALIB STCDBM.DBGMGR.RACF.LST UACC(NONE)

# permit server user ID to access key ring and related private keys
PERMIT STCDBM.DBGMGR.RACF.LST CLASS(RDATALIB) ACCESS(CONTROL) ID(stcdbm)

# refresh to dynamically activate the changes
SETROPTS RACLIST(RDATALIB) REFRESH

# ALTERNATIVE to using RDATALIB profiles
# # define profiles that control certificate access
# RDEFINE FACILITY IRR.DIGTCERT.LIST UACC(NONE)
# RDEFINE FACILITY IRR.DIGTCERT.LISTRING UACC(NONE)
#
# # permit server user ID to access certificates
# PERMIT IRR.DIGTCERT.LIST CLASS(FACILITY) ACCESS(READ) ID(stcdbm)
# PERMIT IRR.DIGTCERT.LISTRING CLASS(FACILITY) ACCESS(READ) ID(stcdbm)
#
# # refresh to dynamically activate the changes
# SETROPTS RACLIST(FACILITY) REFRESH

# create self-signed certificate
RACDCERT ID(stcdbm) GENCERT SUBJECTSDN(CN('Debug Manager') +
OU('RTP labs') O('IBM') L('Raleigh') SP('NC') C('US')) SIZE(2048) +
NOTAFTER(DATE(2015-12-31)) KEYUSAGE(HANDSHAKE) WITHLABEL('dbgmgr')

# create key ring
RACDCERT ID(stcdbm) ADDRING(dbgmgr.racf)

# add certificate to key ring
RACDCERT ID(stcdbm) CONNECT(LABEL('dbgmgr') RING(dbgmgr.racf) +
DEFAULT USAGE(PERSONAL))

# refresh to make the changes visible
SETROPTS RACLIST(DIGTCERT) REFRESH
```

(Optional) If you sign the server certificate with a trusted certificate authority (CA), the client trusts the signed certificate directly. Use the following commands to convert your self-signed certificate to a CA-signed one. These sample commands place the signing request in sequential data set &SYSUID..EQACERT.REQ, and assume that the signed certificate is staged in sequential VB84 data set &SYSUID..EAQCERT.CER. Sequential VB84 data set &SYSUID..CACERT.CER is used as input staging data set if you must add the public CA certificate that matches the private key used by the CA to sign your request.

```
# create a signing request for the self-signed certificate
# Do NOT delete the self-signed certificate before replacing it.
# If you do, you lose the private key that goes with the
# certificate, which makes the certificate useless.
RACDCERT ID(stcdbm) GENREQ (LABEL('dbgmgr')) +
DSN(EQACERT.REQ)
```

```

# send the signing request to your CA of choice

# ensure the CA is known and trusted by RACF
# list all CA certificates defined in the database
RACDCERT CERTAUTH LIST
# mark the CA certificate used to sign your certificate as trusted
RACDCERT CERTAUTH ALTER(LABEL('CA cert')) TRUST
# or add the CA certificate used to sign yours to the database
RACDCERT CERTAUTH ADD(CACERT.CER) WITHLABEL('CA cert') TRUST

# add the CA certificate to the key ring
RACDCERT ID(stcdbm) CONNECT(CERTAUTH LABEL('CA cert') +
RING(dbgmgr.racf))

# add the signed certificate to the database;
# this will replace the self-signed one
RACDCERT ID(stcdbm) ADD(EQACERT.CER) +
WITHLABEL('dbgmgr') TRUST

# refresh to dynamically activate the changes
SETROPTS RACLIST(DIGTCERT) REFRESH

```

The result can be verified with the following `list` and `listring` options:

```

RACDCERT ID(stcdbm) LIST
Digital certificate information for user STCDBM:

Label: dbgmgr
Certificate ID: 2QjW10Xi0sXZ1aaEqZmihUBA
Status: TRUST
Start Date: 2007/05/24 00:00:00
End Date: 2015/12/31 23:59:59
Serial Number:
  >00<
Issuer's Name:
  >CN=CA cert.OU=CA.0=IBM.L=Raleigh.SP=NC.C=US<
Subject's Name:
  >CN=Debug Manager.OU=zexpl.0=IBM.L=Raleigh.SP=NC.C=US<
Private Key Type: Non-ICSF
Private Key Size: 2048
Ring Associations:
  Ring Owner: STCDBM
  Ring:
    >dbgmgr.racf<

RACDCERT ID(stcdbm) LISTRING(dbgmgr.racf)
Digital ring information for user STCDBM:

Ring:
  >dbgmgr.racf<

```

Certificate Label Name	Cert Owner	USAGE	DEFAULT
dbgmgr	ID(STCDBM)	PERSONAL	YES
CA cert	CERTAUTH	CERTAUTH	NO

Verification

Use the following commands to verify your setup:

```

# verify started task setup
LISTGRP SYS1 OMVS
LISTUSER PAGENT OMVS
RLIST STARTED PAGENT.* ALL STDATA

# verify Policy Agent startup permission
RLIST OPERCMDS MVS.SERVMMGR.PAGENT ALL

# verify initstack protection
RLIST SERVAUTH EZB.INITSTACK.** ALL

# verify pasearch protection
RLIST SERVAUTH EZB.PAGENT.** ALL

# verify certificate setup
RACDCERT CERTAUTH LIST(LABEL('CA cert'))

```

```
RACDCERT ID(stcdbm) LIST(LABEL('dbgmgr'))
RACDCERT ID(stcdbm) LISTRING(dbgmgr.racf)
```

AT-TLS policy activation

AT-TLS setup is now complete, and the policy will be activated at next IPL of the system. Follow these steps to start using the policy without an IPL:

1. Activate AT-TLS support in the TCP/IP stack.

- Create a TCP/IP obey file, for example, TCPIP.TCPPARMS(OBEY), with the following content:

```
TCPCONFIG TTLS
```

- Activate it with this operator command:

```
V TCPIP,,OBEY,TCPIP.TCPPARMS(OBEY)
```

- Verify the result by checking for this console message:

```
EZZ4249I stackname INSTALLED TTLS POLICY HAS NO RULES
```

2. Start the Policy Agent.

- Issue operator command:

```
S PAGENT
```

- Verify the result by checking for console message:

```
EZD1586I PAGENT HAS INSTALLED ALL LOCAL POLICIES FOR stackname
```

3. Restart Debug Manager.

- Issue operator commands:

```
P DBGMGR
S DBBMGR
```

Note: Restarting Debug Manager interrupts all active debug sessions that are in pass-thru mode.

Debug Manager authentication

Client authentication is done by RSE daemon as part of the client's connection request. After the user is authenticated, self-generated PassTickets are used for all future authentication requests, including the automatic logon to Debug Manager.

In order for Debug Manager to validate the user ID and PassTicket presented by RSE, Debug Manager must be allowed to evaluate the PassTicket. This implies that load module EQAZPCM, by default located in load library EQAW.SEQAAUTH, must be APF-authorized.

When a client-based Debug Engine connects to the Debug Manager, it must present a valid security token for authentication.

TCP/IP considerations

TCP/IP ports

Figure 7 on page 43 shows the TCP/IP ports that can be used by z/OS Explorer, z/OS Debugger and if installed, IBM Developer for z/OS. The arrows show the party that does the bind (arrowhead side) and the one that connects.

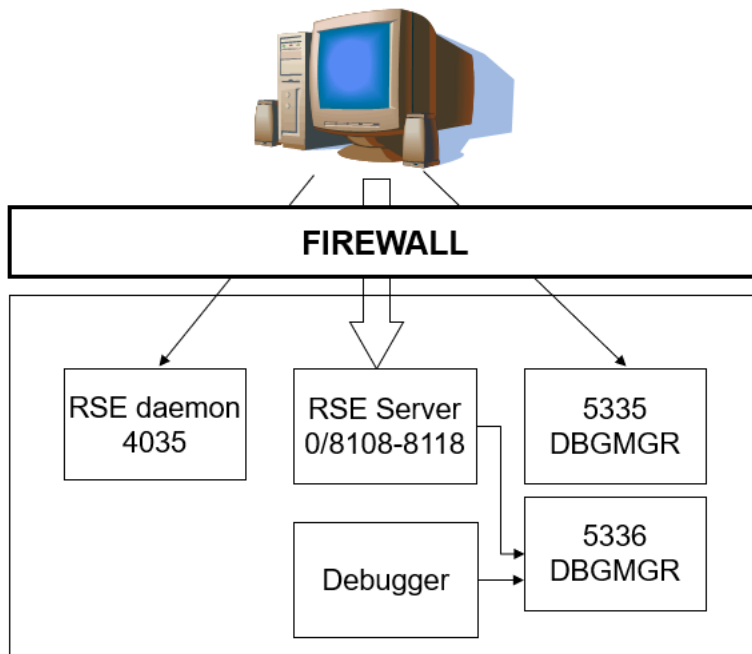

Figure 7. TCP/IP ports for the usage of z/OS Debugger with Debug Manager

Figure 8 on page 43 shows how the TCP/IP port works without Debug Manager.

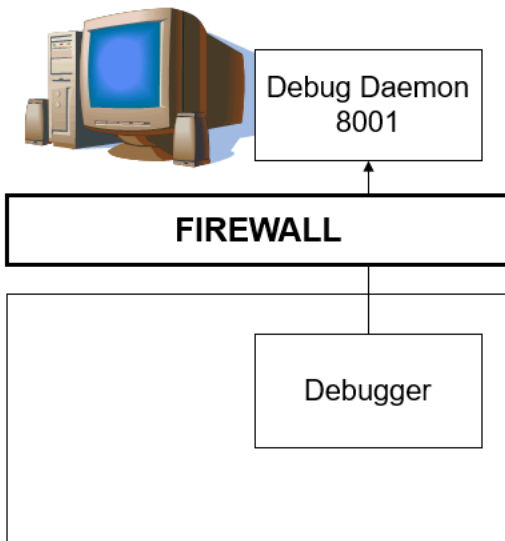

Figure 8. TCP/IP port for the usage of z/OS Debugger without Debug Manager

For more information on RSE ports, see the "External Communication" topic in the *IBM Developer for z/OS Host Configuration Reference*.

External communication

Define the following ports to your firewall that protect the z/OS host, as they are used for client-host communication (using the tcp protocol):

- Debug manager services, default port 5335. The port can be set in the DBGMGR started task JCL. Communication on this port can be encrypted.
- When z/OS Debugger is started with Language Environment (LE) option TEST(, , TCPIP&&ipaddress%8001:*) or TEST(, , DIRECT&&ipaddress%8001:*), it is instructed

not to use Debug Manager but contact the Eclipse client directly at port 8001. This implies, from a TCP/IP perspective, that z/OS Debugger is a client that contacts a server (the Debug UI) in the Eclipse IDE.

Internal communication

Several z/OS Debugger host services run in separate threads or address spaces and are using TCP/IP sockets as communication mechanism, using your system's loopback address, making their data stream confined to the host only. For some services any available port will be used, for others the system programmer can choose the port or port range that will be used:

- (Optional) Debug Manager for debug related services, default port 5336. The port can be set in the DBGMR started task JCL.

TCP/IP port reservation

If you use the PORT or PORTRANGE statement in PROFILE.TCPIP to reserve the ports used by z/OS Explorer, z/OS Debugger, and optionally IBM Developer for z/OS, note that many binds are done by threads active in an RSE thread pool. The job name of the RSE thread pool is RSEdx, where RSEd is the name of the RSE started task, and x is a random single digit number, so wildcards are required in the definition.

```
PORT      5335      TCP DBGMR ; z/OS Debugger - debug manager
PORT      5336      TCP DBGMR ; z/OS Debugger - debug manager
```

Loopback localhost

IBM Developer for z/OS and z/OS Debugger use the TCP/IP loopback and TCP/IP localhost definitions. Communication will fail if these definitions are set up using different TCP/IP addresses.

To avoid address resolution issues, define one of the following lines in the local host table, as described in section "Configuring the local host table" of the *Communications Server: IP Configuration Guide* (SC31-8775).

- 127.0.0.1 loopback localhost # for IPv4 only
- ::1 loopback localhost # for IPv6 only

Note: Ensure that the definition is valid for both the MVS and z/OS UNIX search orders.

Refer to *Communications Server: IP Configuration Guide* (SC31-8775) and *Communications Server: IP Configuration Reference* (SC31-8776) for additional information on TCP/IP configuration. The *IBM Explorer for z/OS Host Reference Guide* (SC27-8438) also provides related information in the "Setting up TCP/IP" chapter.

Multi-stack (CINET)

z/OS Communication Server allows you to have multiple TCP/IP stacks concurrently active on a single system. This is referred to as a CINET setup.

When multiple TCP/IP stacks are active on a host system, it is important that Debug Manager and Debug Probe are using the same TCP/IP stack in order for them to communicate. Debug Engine (on the client) must also be able to communicate with Debug Manager. By default, Debug Manager binds to every stack available on the host to simplify matching Debug Probe and Debug Client setup.

If this is not desired, then stack affinity can be used to instruct Debug Manager to bind to a single specified TCP/IP stack. Stack affinity is set with the `_BPXK_SETIBMOPT_TRANSPORT` environment variable, which must be passed on to Language Environment. You can set stack affinity by adjusting the startup command in the started task JCL:

```
//DBGMR  PROC PRM=,
//*      LEPRM='RPTOPTS(ON)',
//      LEPRM='RPTOPTS(ON) ENVAR("_BPXK_SETIBMOPT_TRANSPORT=TCPIP)",
//      TZ='EST5EDT',
//      CLIENT=5335,
//      HOST=5336,
//      HLQ=EQAW
```

Notes:

- BPXK_SETIBMOPT_TRANSPORT specifies the name of the TCP/IP stack to be used, as defined in the TCPIPJOBNAME statement in the related TCPIP.DATA.
- Coding a SYSTCPD DD statement does not set the requested stack affinity.

Distributed Dynamic VIPA

With Dynamic Virtual IP Addressing (DVIPA), you can concurrently run identical setups on different systems in your sysplex, and have TCP/IP, optionally with the help of WLM, distribute the client connections among these systems.

As Debug Manager works together with IBM Explorer for z/OS to allow remote debugging from Eclipse clients, the distributed DVIPA supported by z/OS Explorer is also available with Debug Manager, but with the following considerations:

- Debug Manager only communicates with z/OS Explorer's Remote System Explorer daemon (RSED) started task that is active on the same system. This implies that a Debug Manager started task (DBGMGR) must be active on each system of your sysplex where RSED is active.
- Unlike in z/OS Explorer where TCP/IP can choose which system a user will connect to, the client connection to Debug Manager must be sent to the system that the debug session has started. To achieve this, each Debug Manager must use a unique external port (the CLIENT variable in the started task).
- Each of the unique Debug Manager ports must be defined to TCP/IP in the VIPADISTRIBUTE PORT statement.

Unique external ports

When a remote debug session is started, Debug Manager informs the Eclipse client about the port that it is listening at. In a distributed DVIPA scenario, this port must be unique in the sysplex so that the Sysplex Distributor can use this to send the client connection to the correct system.

You can use a started task JCL per system, and use a unique port number in each JCL to ensure that each Debug Manager has a unique external port. A system symbol that holds the unique port number for that system can be used if you want to share the started task JCL across the systems.

- If you already have a system symbol with a numeric value that is unique per system, for example, &SYSCONE, you can make it part of the CLIENT port number definition in the started task JCL like in the following example:

```
//DBGMGR  PROC PRM=,  
//          LEPRM=' RPTOPTS(ON) ',  
//          TZ=' EST5EDT ',  
//          CLIENT=53&SYSCONE,  
//          HOST=5336,  
//          HLQ=EQAW
```

- Or you can use sample JCL SEQASAMP (EQADVIPA) to create system symbol EQADBAM that holds the unique port number, and then reference EQADBAM in the started task JCL:

```
//DBGMGR  PROC PRM=,  
//          LEPRM=' RPTOPTS(ON) ',  
//          TZ=' EST5EDT ',  
//          CLIENT=&EQADBAM,  
//          HOST=5336,  
//          HLQ=EQAW
```

Note: The EQADBAM system symbol must exist before the Debug Manager started task (DBGMGR) is started. For example, you can define EQADVIPA as started task to start it early in your IPL sequence.

Sample setup

In this example, the TCP/IP definitions for an existing z/OS Explorer distributed DVIPA setup are extended with Debug Manager ports 5331 and 5332 added to the definition. For more information about the original setup, see the “Distributed Dynamic VIPA” section in the “TCP/IP considerations” chapter of the *IBM Explorer for z/OS Host Configuration Reference Guide*.

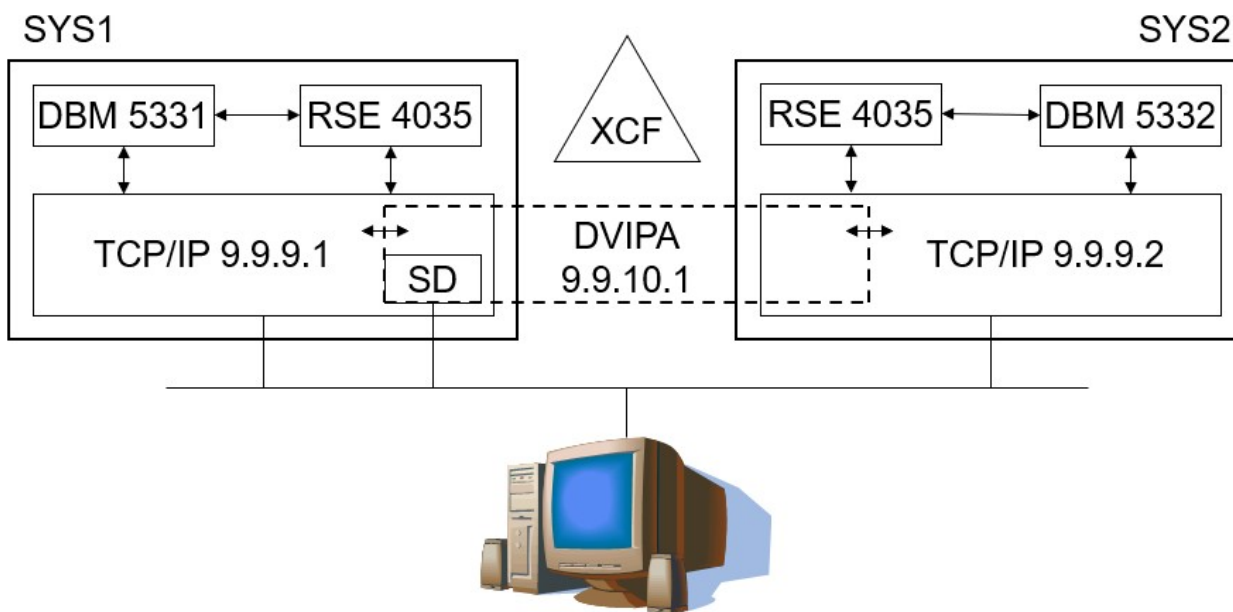

Figure 9. Distributed Dynamic VIPA sample

```

IPCONFIG
; SYSPLXROUTING is required as this stack needs sysplex communication
  SYSPLXRouting
; DYNAMICXCF defines device/link with home address 9.9.9.1 as needed
  DYNAMICXCF 9.9.9.1 255.255.255.0 1
  IGNORERedirect

VIPADYNAMIC
; VIPADEFINE defines 9.9.10.1 as DVIPA, with this system as main controller
  VIPADEFINE 255.255.255.0 9.9.10.1
; VIPADISTRIBUTE makes 9.9.10.1 a distributed DVIPA, must match SYS2
  VIPADISTRIBUTE DEFINE
    SYSPLXEXPORTS          ; prereq, must be in first VIPADISTRIBUTE
    DISTMETHOD BASEWLM    ; BASEWLM
    9.9.10.1                ; DVIPA address used by z/OS Explorer clients
    PORT 4035 5331 5332    ; zExpl & DBM ports used by zExpl clients
    DESTIP 9.9.9.1 9.9.9.2 ; z/OS Explorer active on SYS1 and SYS2
  ENDVIPADYNAMIC
  
```

Figure 10. System SYS1 – TCP/IP profile

```

IPCONFIG
; SYSPLEXROUTING is required as this stack needs sysplex communication
SYSPLEXRouting
; DYNAMICXCF defines device/link with home address 9.9.9.2 as needed
DYNAMICXCF 9.9.9.2 255.255.255.0 1
IGNORERedirect

VIPADYNAMIC
; VIPABACKUP defines 9.9.10.1 as DVIPA, with this system as backup controller
VIPABACKUP 255.255.255.0 9.9.10.1
; VIPADISTRIBUTE makes 9.9.10.1 a distributed DVIPA, must match SYS1
VIPADISTRIBUTE DEFINE
  SYSPLEXPORTS ; prereq, must be in first VIPADISTRIBUTE
  DISTMETHOD BASEWLM ; BASEWLM
  9.9.10.1 ; DVIPA address used by z/OS Explorer clients
  PORT 4035 5331 5332 ; zExpl & DBM ports used by zExpl clients
  DESTIP 9.9.9.1 9.9.9.2 ; z/OS Explorer active on SYS1 and SYS2
ENDVIPADYNAMIC

```

Figure 11. System SYS2 – TCP/IP profile

Communication example

Figure 12 on page 47 shows an overview of how an Eclipse client connects and communicates to the host in a DVIPA environment with two LPARs. Debug Manager instances on those LPARs are listening to external ports 5334 and 5335 respectively.

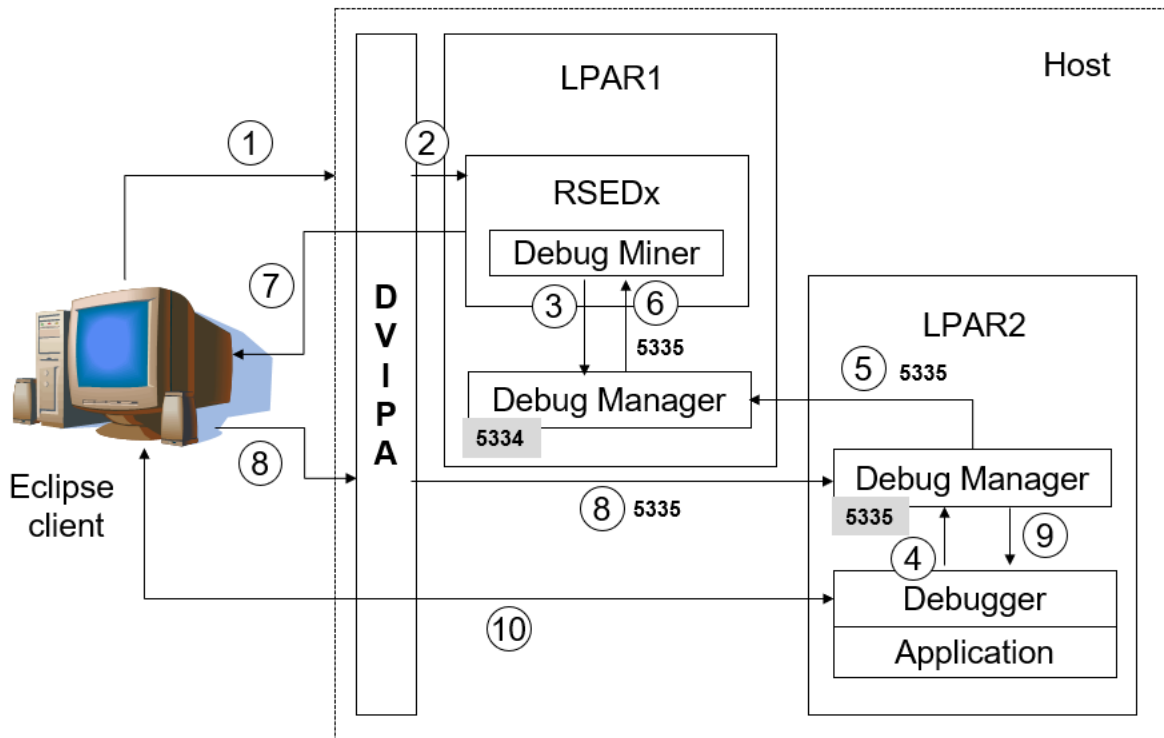

Figure 12. Debug Manager communication example in the DVIPA environment

1. When a user tries to log in to the host from an Eclipse client, Remote System Explorer (RSE) on the client connects to the RSE daemon on the host by using the virtual IP address and RSEd port.
2. DVIPA picks an LPAR to connect to. In this example, LPAR1 is selected.
3. Debug Miner, a component of the RSE daemon finds out the DBM name-token pair in the system, reads the DBM internal port, connects to DBM, and notifies it that the user *username* is logged on to the system.

4. The user starts a job with TEST runtime option `DBMDT%username`. In this example, the job goes to LPAR2. The debugger finds out the host port of DBM in LPAR2 by reading its name-token pair and notifies DBM that a debug session for user `username` is waiting for a workstation to connect.
5. As the DBM on LPAR2 does not have `username` logged on, it contacts other DBM instances in the sysplex, notifying that a debug session is waiting and adding its external port number 5335 to the request. For more information, see [“Enabling sysplex support”](#) on page 33.
6. The DBM on LPAR1 has `username` logged on, so it picks up the request and notifies Debug Miner that there is a debug session for user `username` on port 5335.
7. The RSE daemon notifies the Eclipse client about the debug session and passes the port to connect to.
8. The remote debugger in the Eclipse client uses port 5335 to connect to DBM. As the connection IP address is a DVIPA address, a unique port is available, which only allows DVIPA to forward the request to the correct DBM instance in the sysplex.
9. DBM links the workstation connection to the debugger.
10. The debugger and the Eclipse client can now communicate directly to each other by using the established connection.

WLM considerations

Setting goals

z/OS Explorer, z/OS Debugger, and IBM Developer for z/OS create different types of workloads on your system. These different tasks communicate with each other, which implies that the actual elapse time becomes important to avoid time-out issues for the connections between the tasks. As a result, these tasks should be placed in high-performance service classes, or in moderate-performance service classes with a high priority.

A revision, and possibly an update, of your current WLM goals is therefore advised. This is especially true for traditional MVS shops new to time-critical OMVS workloads.

Note:

- The goal information in this section is deliberately kept at a descriptive level, because actual performance goals are very site-specific.
- To help understand the impact of a specific task on your system, terms like minimal, moderate, and substantial resource usage are used. These are all relative to the total resource usage of IBM Developer for z/OS or z/OS Debugger, not the whole system.

All z/OS Debugger started tasks are servicing real-time client requests.

<i>Table 8. WLM workloads - STC</i>		
Description	Task name	Workload
Debug Manager	DBGMGR	STC

- Debug Manager

Debug Manager provides services to connect programs being debugged to clients debugging them. You should specify a high-performance, one-period velocity goal, because the task does not report individual transactions to WLM. Resource usage depends heavily on user actions, and will therefore fluctuate, but is expected to be minimal.

Tuning considerations

Debug Manager resource usage

Use the information in this section to estimate the normal and maximum resource usage by Debug Manager, so you can plan your system configuration accordingly.

- [“Overview” on page 49](#)
- [“Address space count” on page 49](#)
- [“Process count” on page 49](#)
- [“Thread count” on page 49](#)

For more information about resource usage, see the topic about resource usage in *IBM Explorer for z/OS Host Configuration Reference Guide* (SC27-8438).

Overview

Table 9 on page 49 gives an overview of the number of address spaces, processes, and threads used by DBGMGR.

<i>Table 9. Common resource usage</i>			
Started task	Address spaces	Processes	Threads
DBGMGR	1	1	4

For more information about the number of address spaces, processes, and threads used by z/OS Explorer, see the overview topic in *IBM Explorer for z/OS Host Configuration Reference Guide* (SC27-8438).

Address space count

Table 10 on page 49 lists the address spaces that are used by Debug Manager.

<i>Table 10. Address space count</i>				
Count	Description	Task name	Shared	Ends after
1	Debug Manager	DBGMGR	Yes	Never

For more information about the address spaces that are used by z/OS Explorer, see the topic about address space count in *IBM Explorer for z/OS Host Configuration Reference Guide* (SC27-8438).

Process count

Table 11 on page 49 lists the number of processes per address space that is used by Debug Manager.

<i>Table 11. Process count</i>			
Processes	Address spaces	Description	User ID
1	1	Debug Manager	STCDBM

For more information about the number of processes per address space that is used by z/OS Explorer, see the topic about process count in *IBM Explorer for z/OS Host Configuration Reference Guide* (SC27-8438).

Thread count

Table 12 on page 50 lists the number of threads used by Debug Manager. The thread count is listed per process, as limits are set at this level.

- RSEDx: These threads are created in the RSE thread pool, which is shared by multiple clients. All threads ending up in the same thread pool must be added together to get the total count.
- Active: These threads are part of the process that actually does the requested function. Each process is a stand-alone unit, so there is no need to sum the thread counts, even if they are assigned to same user ID, unless noted otherwise.
- Bootstrap: Bootstrap processes are needed to start the actual process. Each has 1 thread, and there can be multiple consecutive bootstraps. There is no need to sum the thread counts.

Table 12. Thread count

Threads			User ID	Description
RSEDx	Active	Bootstrap		
-	4 or 5 ¹	-	STCDBM	Debug Manager

Notes:

1. In the sysplex mode, an extra thread for inter-sysplex communication is started.

For more information about the number of threads, see *IBM Explorer for z/OS Host Configuration Reference Guide* (SC27-8438).

Running multiple instances

- The Debug Manager started task is backwards compatible, and thus the most recent version can be shared across releases .
- Only one Debug Manager (DBM) is allowed on a given LPAR.

Troubleshooting configuration problems

Debug Manager logging

• **SYSPRINT DD**

Trace logging and logging of normal operations. The default value in the sample JCL EQAW.SEQASAMP (EQAZPCM) is SYSOUT=*.

Debug Manager tracing

Debug Manager tracing is controlled by the system operator, as described in [“Operator commands”](#) on page 50.

- Starting the DBGMR started task with the PRM=DEBUG parameter activates tracing.
- The **modify loglevel** operator command let you select the desired detail level for log messages.

Operator commands

The following operator or console commands are available for Debug Manager.

Start (S)

Use the **START** command to dynamically start a started task (STC). The abbreviated version of the command is the letter S.

START DBGMGR operator command

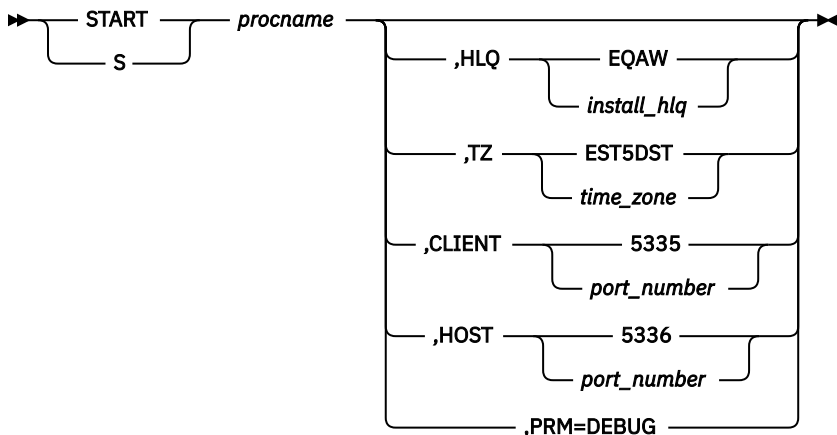

procname

The name of the member in a procedure library that is used to start the server. The default name used during the host system configuration is **DBGMGR**.

HLQ=install_hlq

High-level qualifier used to install z/OS Debugger. The default is **EQAW**.

TZ=time_zone

Time zone offset. The default is **EST5DST**.

CLIENT=port_number

The port used for external (client-host) communication, default **5335**.

HOST=port_number

The port used for internal (host-confined) communication, default **5336**.

PRM=DEBUG

Enable verbose (trace) mode. Tracing will cause performance degradations and should only be done under the direction of the IBM support center.

Modify (F)

The **MODIFY** command can be used to dynamically query and change the characteristics of an active task. The abbreviated version of the command is the letter F.

MODIFY DBGMGR operator command

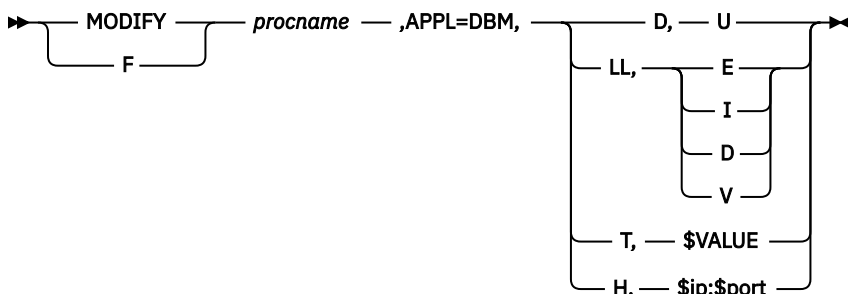

Note: The comma is the only delimiter. There is no space before or after a comma.

procname

The name of the member in a procedure library that is used to start the server. The default name used during the host system configuration is **DBGMGR**.

D, U

Display the active users with a single, multi-line, EQACM104I console message. Message EQACM103I is issued if there are no active users. The user list shows the state of that user in the server.

```
EQACM104I
User:IBMUSER RegisterSocket(2)
User:IBMUSR2 18354752 ProbeSocket(3) waits for register connection
User:IBMUSR3 25387329 ProbeSocket(5) waits for engine connection
User:IBMUSR4 24113603 Engine(4) connected to Probe(8)
Module(EQATST)
EQACM103I There is no active user
```

The first message (for IBMUSER) indicates that the user is registered, but there is no debug activity. The second message (for IBMUSR2) indicates that a debug session is waiting for the user to register. The third message (for IBMUSR3) indicates that a debug session is being set up. The fourth message (for IBMUSR4) shows an active debug session for module EQATST.

LL,{E | I | D | V}

Control the detail level of the Debug Manager message log (DD SYSPRINT). The default is E. A message "LOGLEVEL command processed normally" is written to the console with message ID EQACM101I.

Value	Description
E	Error messages only (default)
I	Error and informational messages
D	Error, informational, and debug/dump messages
V	Debug level and hex value of all packets of interest

Detailed tracing will cause performance degradations and should only be done under the direction of the IBM support center.

T,\$VALUE

The DBM check cycle value. The observed timeout is between *\$VALUE* and two times of *\$VALUE*. The value can be in the range 15 - 150 seconds and is integer only. The default value is 15.

This setting applies to pending debugging requests only. Established sessions that are already shown on the UI are not affected.

H,\$ip:\$port

Change the primary node in sysplex. *\$ip* is the IP address of the new node and *\$port* is its port number. IP address can either be IPv4 or IPv6 IP address. The IPv6 IP address that you use must be enclosed in brackets, [], for example, H, [::1234:5678] :5337.

Stop (P)

Use the **STOP** command to stop an active task. The abbreviated version of the command is the letter P.

STOP operator command

➤ STOP *procname* ➤
P

procname

The name of the member in a procedure library that was used to start the server. The default name used during the host system configuration is DBGMGR for Debug Manager.

Adding support for Remote Debug Service

Remote Debug Service acts as a proxy between the Debug Engine and Debug Adapter Protocol (DAP) clients, like the Visual Studio Code (VS Code) extensions. Remote Debug Service enables interactive

debugging of COBOL and PL/I applications in these remote debuggers. Remote Debug Service can also be configured to collect headless code coverage.

Notes:

- Remote Debug Service is only available with IBM Developer for z/OS Enterprise Edition and IBM Z and Cloud Modernization Stack (Wazi Code).
- Remote Debug Service requires Java 11 or 17. After installation, you need to [configure z/OS to run Java applications](#).
- Remote Debug Service and the headless code coverage collector are built on Eclipse and Java technology. Configuration options for Eclipse and Java might affect the behavior of Remote Debug Service and headless code coverage collector.

Installing Remote Debug Service

Remote Debug Service is an Eclipse Rich Client Platform (RCP) application. The files are installed as z/OS UNIX files in the default location `/usr/lpp/IBM/debug` by using SMP/E during product installation. You can change the installation location to a directory of your choice.

Note: The user ID used for the SMP/E installation must be UID 0, or have at least READ access to the BPX.SUPERUSER profile in the FACILITY class. In addition, if the BPX.FILEATTR.APF or BPX.FILEATTR.PROGCTL profiles are defined in the FACILITY class, the user ID must have READ access to those profiles.

Customizing with the sample job EQARMTSU

You need to create directories in z/OS® UNIX and copy sample configuration files from the installation directory to these directories for customization. The sample job EQAW.SEQASAMP (EQARMTSU) is provided to help you complete these tasks.

Follow the instructions within the EQARMTSU member and submit the job to customize your installation. The job performs the following tasks:

- Create `/etc/debug/*` and populate it with sample configuration files.
- Create `/var/debug/*` as work directories required to run the service.
- Set the proper z/OS UNIX file permissions on the files and directories.

The `eqarmtd.env` and `eqahcc.env` sample files are copied to `/etc/debug` by the sample job. Edit these files under `/etc/debug` and customize them to match your system environment:

eqarmtd.env

Environment variables that control, for example:

- Which internal and external ports to use for the service.
- Where to locate the security keystore file for SSL encryption. You can use the sample keystore file from Debug Profile Service located in the `/etc/debug` directory.
- Whether to allow headless code coverage collection, and how many requests per second as well as how many concurrent requests Code Coverage Service allows.

The following environment variables are available for Remote Debug Service:

java_dir="java_directory"

Home directory of the 64-bit Java SDK. For example: `java_dir="/usr/lpp/java/J11.0_64"`

port_internal="port_number"

Port number the service listens to for internal debug backend connections from the local z/OS machine. Secure this port with AT-TLS if encryption of *localhost-localhost* connections is desired.

This port is mandatory.

allow_unsecured_remote_connections="true"

Allow the internal port number to also listen for unsecured incoming requests from remote debug clients.

Uncomment this line to enable listening for unsecured remote connections on **port_internal**.

port_external="port_number"

Port number the service listens to for incoming requests from remote debug clients.

AT-TLS can be used to secure this port. This option is mutually-exclusive with **port_external_secure**.

You must specify either **port_external** or **port_external_secure**, but you cannot specify both.

port_external_secure="port_number"

Port number the service listens to for secured incoming requests from remote debug clients. This port is encrypted by Java. Do not use AT-TLS to secure this port.

You must specify either **port_external** or **port_external_secure**, but you cannot specify both.

Values for TLS keystore and password must be specified when **port_external_secure** is specified.

keystoreFile="keystore_file"

Pathname of the keystore file where the server certificate is loaded. You can use the sample keystore file from Debug Profile Service located in the /etc/debug directory. For example:
keystoreFile="\$EQARMTD_CFG_DIR/keystore.jks"

keystorePass="password"

Password to access the server certificate from the keystore file.

keystoreType="keystore_type"

The type of keystore file to be used for the server certificate. Only JKS keystore types are supported at this time: keystoreType="JKS".

You can comment or uncomment the following parameters:

- Diagnostic tracing of service and debug connections:

```
eqarmtd_logdir="$EQARMTD_WRK_DIR/logs"  
trace=true
```

- Low level tracing of Remote Debug Service application and debug connections:

```
detailedTraceOptions="$EQARMTD_CFG_DIR/trace.options"  
detailedTrace=true
```

- File permissions in umask format used when you create files or directories

```
umask="u+rwx,g+rx"
```

- Headless code coverage and Code Coverage Service options:

```
headless_cc=true  
headless_cc_config=SharedServiceFiles/samples/eqahcc.env  
ccs_maxRequestsPerSec=25  
ccs_maxConcurRequests=20
```

eqahcc.env

Environment variables that control, for example:

- Whether to start Code Coverage Service. To start Code Coverage Service, configure a port for it. Code Coverage Service automatically uses the same keystore information as Remote Debug Service for SSL encryption.

Code Coverage Service provides a simpler way for users to access the code coverage results that they generate, and eliminates the need for granting access at the file and directory levels.

- Where code coverage results are stored. By default, the results are output to *\$HOME/CC/user_ID*, where *\$HOME* is the home directory of the user running Remote Debug Service. You can specify a different root location than *\$HOME/CC/*. Ensure that the code coverage users know the path to this directory to access results and have the following authority:

- A minimum of read access to the parent directory to read their user ID subdirectory `root_location/user_ID`, where `root_location` is one of the following:
 - The value for the output property specified in `eqahcc .env`
 - `$HOME/CC`, where `$HOME` is the home directory of the user that is running Remote Debug Service

The subdirectory and the results within inherit the permissions of the parent directory. You can add user access through group or public permissions. This is not required if users access results using Code Coverage Service.

- Enough authority to change the ownership of z/OS UNIX files. Remote Debug Service changes the owner of both the subdirectory and code coverage results to the user ID. When users do not have authority, results can still be created, but users can only manage any results based on file permissions. This is not required if users access results using Code Coverage Service.
- Whether to support only connections from the local host.

For more details on headless code coverage options, see the "Starting and stopping the headless code coverage daemon" topic in [IBM Documentation](#). Not all options for headless code coverage are supported in Remote Debug Service. The `eqahcc .env` file provides all the supported options.

You can run the sample job EQARMTSU more than once. If a file exists in the configuration directory, a backup is created for the existing file before a new one is copied over.

Customizing the system PROCLIB

Customize the EQAW.SEQASAMP (EQARMTD) sample started task member, as described within the member, and copy it to SYS1.PROCLIB.

As shown in the code sample, provide the following information:

- The home directory where Remote Debug Service is installed. The default directory is `/usr/lpp/IBM/debug`.
- The location of the configuration files. The default location is `/etc/debug`.
- The name of the environment configuration file. The default name is `eqarmtd.env`.

Figure 13. Remote Debug Service started task

```

//*****
//* Licensed Materials - Property of IBM *
//* * *
//* 5724-T07: IBM z/OS Debugger *
//* Copyright IBM Corp. 2020, 2023 All Rights Reserved *
//* * *
//* US Government Users Restricted Rights - Use, duplication or *
//* disclosure restricted by GSA ADP Schedule Contract with IBM Corp. *
//* * *
//* This JCL procedure is used to start the Remote Debug Service. *
//* * *
//* You will have to make the following modifications: *
//* * *
//* 1) If you installed the product in a different directory than *
//* the default /usr/lpp/IBM/debug, change SVRPATH to refer to *
//* the correct directory. *
//* * *
//* 2) If you customized the configuration files in a different *
//* directory than the default /etc/debug, change CFGDIR to *
//* refer to the correct directory. *
//* * *
//* 3) If you want the server to use a different work directory *
//* then the default /var/debug, change WRKDIR to refer to the *
//* desired directory. *
//* * *
//* 4) If you customized the environment variables file in CFGDIR *
//* to a different file name than the default eqarmtd.env, change *
//* ENVFILE to refer to the correct name. *
//* * *
//* Note(s): *
//*
```

```

/** 1. This procedure contains case sensitive path statements.      *
/**                                                                    *
/** 2. Add a job card on line 1 and '//EQARMTD EXEC EQARMTD' at the *
/**    bottom to submit this procedure as a user job.              *
/**                                                                    *
/*******
/**
/** Remote Debug Service
/**
/**EQARMTD  PROC SVRPATH='/usr/lpp/IBM/debug',
/**          CFGDIR='/etc/debug',
/**          WRKDIR='/var/debug',
/**          ENVFILE='eqarmtd.env'
/**          SET QUOTE='''
/**EXPORTS  EXPORT SYMLIST=*
/**          SET SVRPATH=&QUOTE&SVRPATH&QUOTE
/**          SET CFGDIR=&QUOTE&CFGDIR&QUOTE
/**          SET WRKDIR=&QUOTE&WRKDIR&QUOTE
/**          SET ENVFILE=&QUOTE&ENVFILE&QUOTE
/**-----
/** Start the Remote Debug Service
/**-----
/**EQARMTD EXEC PGM=BPXBATSL,REGION=0M,TIME=NOLIMIT,
/**  PARM='PGM /bin/sh &SVRPATH/remote-debug-service/eqarmtd.sh'
/**STDOUT   DD SYSOUT=*
/**STDERR   DD SYSOUT=*
/**STDENV   DD *,SYMBOLS=JCLONLY
EQARMTD_CFG_DIR=&CFGDIR
EQARMTD_WRK_DIR=&WRKDIR
EQARMTD_ENVFILE=&CFGDIR/&ENVFILE
EQARMTD_BASE=&SVRPATH/remote-debug-service
_BPXK_AUTOCVT=ON
/**
/**          PEND
/**

```

Tip: On the STDENV DD card, you can specify the TZ environment variable to control the timestamps used in the default file names of newly created code coverage report files.

Remote Debug Service security definitions

Perform the following tasks to complete the basic security setup to run Remote Debug Service.

Defining the Remote Debug Service started task

The following sample RACF commands create the EQARMTD started task, with protected user ID (STCEQA2) and the STCGROUP group assigned to it:

1. ADDGROUP STCGROUP OMVS(AUTOGID) -
DATA('GROUP WITH OMVS SEGMENT FOR STARTED TASKS')
2. ADDUSER STCEQA2 DFLTGRP(STCGROUP) NOPASSWORD -
NAME('REMOTE DEBUG SERVICE') -
OMVS(AUTOUID HOME('/tmp') PROGRAM('/bin/sh'))
- DATA('IBM z/OS Debugger')
3. RDEFINE STARTED EQARMTD.* -
STDATA(USER(STCEQA2) GROUP(STCGROUP) TRUSTED(NO)) -
DATA('REMOTE DEBUG SERVICE')
4. SETROPTS RACLIST(STARTED) REFRESH

Notes:

- Ensure that the started task user ID is protected by specifying the NOPASSWORD keyword.
- Ensure that the home directory exists and is readable, writable, and executable by the started task user. Otherwise, Remote Debug Service will not start.
- If you are enabling Remote Debug Service to collect code coverage without enabling Code Coverage Service, ensure that the started task user ID or related group has enough authority to change the ownership of z/OS UNIX files. For more information on code coverage options with Remote Debug

Service, see [“Customizing with the sample job EQARMTSU” on page 53](#). For more information on changing file ownership, see [Steps for authorizing selected users to transfer ownership of any file and Steps for setting up the CHOWN.UNRESTRICTED profile](#).

Enabling secure communication

You can enable Remote Debug Service to communicate via a [Secure Sockets Layer \(SSL\) certificate with a private key and self-signed certificate stored in a keystore file](#) or [AT-TLS](#).

Enabling secure communication with a keystore file

You can enable Remote Debug Service to communicate via Secure Sockets Layer (SSL) with a private key and self-signed certificate stored in a keystore file.

1. Create a JKS keystore file by using the Java runtime utility keytool:

```
keytool -genkey -alias rmtd -keyalg RSA -storetype JKS -keystore keystore.jks
```

2. Edit `/etc/debug/eqar.mtd.env` and update the keystore variables to use the new keystore file.
3. To ensure that the keystore file is only readable by the protected user ID STCEQA2, change the owner and permission of the file with:

```
chown STCEQA2:STCGROUP keystore.jks  
chmod 640 keystore.jks
```

4. Export the SSL certificate with:

```
keytool -export -keystore keystore.jks -alias rmtd -storetype JKS -file rmtd.cer -rfc
```

The SSL certificate can be distributed to remote users to be imported into the client keystore.

Enabling secure communication with AT-TLS

You can also use the TCP/IP service called Application Transparent Transport Layer Security (AT-TLS) to enable secure communication with Remote Debug Service. For a step-by-step guide to setting up AT-TLS itself, see [“Setting up AT-TLS” on page 35](#).

Create an AT-TLS policy for the port used by Remote Debug Service as specified in the `eqar.mtd.env` configuration file. See the following sample policy.

```
TTLSSRule EQARMTD  
{  
    LocalPortRange          8002  
    Direction Inbound  
    TTLSTLSGroupActionRef.  EQARMTD_group  
    TTLSEnvironmentActionRef EQARMTD_env  
    TTLSSConnectionActionRef EQARMTD_conn  
}  
  
TTLSTLSGroupAction EQARMTD_group  
{  
    TTLSEnabled          On  
}  
  
TTLSEnvironmentAction EQARMTD_env  
{  
    HandshakeRole          Server  
    TTLSSKeyringParms  
    {  
        # Keyring must be owned by the user id running the EQARMTD started task  
        Keyring             EQARMTD.keyring  
    }  
}  
  
TTLSSConnectionAction EQARMTD_conn  
{  
    HandshakeRole          Server  
    TTLSSCipherParmsRef.  EQARMTD_cipherparms  
    TTLSSConnectionAdvancedParmsRef. EQARMTD_Conn_adv
```

```

    CtraceClearText          Off
}

TTLSConnectionAdvancedParms EQARMTD_Conn_adv
{
    TLSv1                    Off
    TLSv1.1                  Off
    TLSv1.2                  On
    SSLV3                    Off
    ApplicationControlled    Off
    SecondaryMap              Off
    HandshakeTimeout         20
}

TTLSCipherParms EQARMTD_cipherparms
{
    V3CipherSuites TLS_ECDHE_ECDSA_WITH_AES_256_GCM_SHA384
    V3CipherSuites TLS_ECDHE_ECDSA_WITH_AES_128_GCM_SHA256
    V3CipherSuites TLS_ECDHE_RSA_WITH_AES_256_GCM_SHA384
    V3CipherSuites TLS_ECDHE_RSA_WITH_AES_128_GCM_SHA256
    V3CipherSuites TLS_DHE_RSA_WITH_AES_256_GCM_SHA384
    V3CipherSuites TLS_DHE_RSA_WITH_AES_128_GCM_SHA256
}

```

Updating PARMLIB to start Remote Debug Service during IPL

Add a start command for Remote Debug Service to SYS1.PARMLIB(COMMNDxx) to start it automatically at the next system IPL. Define CMD=xx in the IEASYSxx parmlib member to specify the COMMNDxx parmlib member that is used during IPL.

Starting and stopping Remote Debug Service dynamically

To start the service, use the following console command:

```
S EQARMTD
```

To stop the server, use the following console command:

```
P EQARMTD
```

Adding support for Debug Profile Service

Debug Profile Service consists of a server and REST APIs that use the HTTP protocol to provide RESTful services to a set of resources related to managing debug profiles and IMS Isolation.

The server runs on z/OS, and uses [IBM z/OS Liberty Embedded](#) as the web server.

The following REST APIs are provided with Debug Profile Service:

- [Debug Profile Service API \(DPS API\)](#) is a REST API that runs on z/OS to manage debug profiles in both CICS and non-CICS environments. It is similar to the [DTCN profiles API](#), except that it also handles batch, IMS, and Db2 stored procedure profiles stored in EQAUOPTS data sets.
- [IMS Transaction Isolation Service API \(IMS ISO API\)](#) is a REST API that runs on z/OS that allows users to isolate IMS transactions for debugging. It is similar to the Batch Interface of IMS Transaction Isolation Facility of z/OS Debugger, which invokes the program EQANIPSB to perform IMS Transaction Isolation functions.

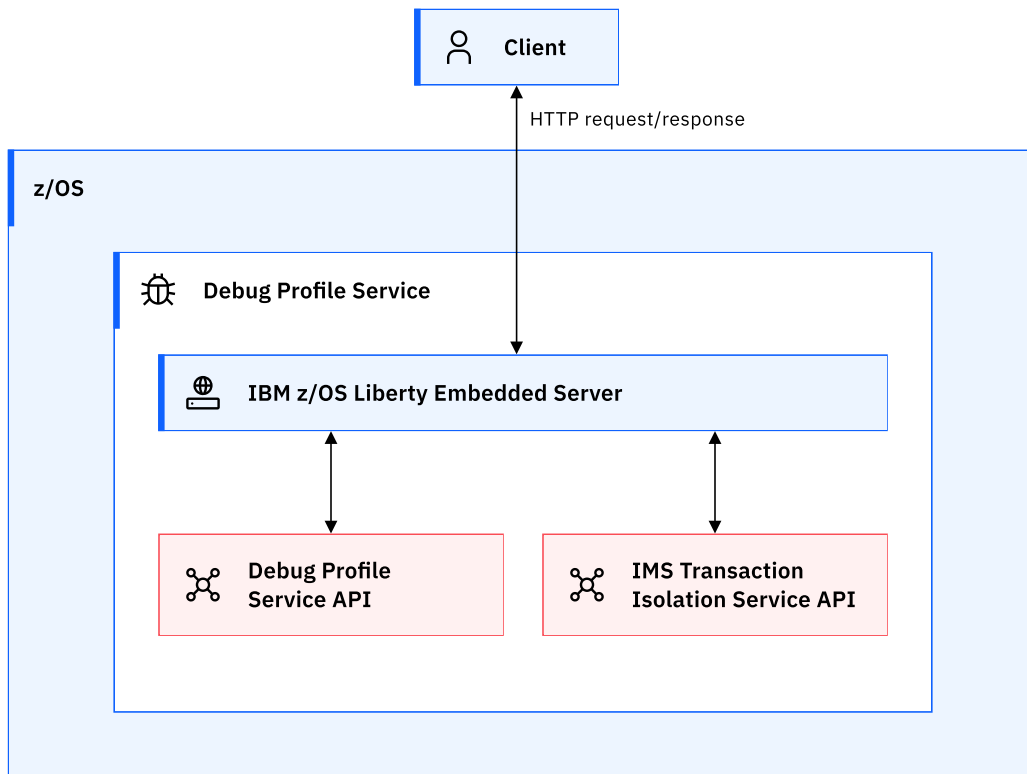

Figure 14. Debug Profile Service

To enable the RESTful services, you need to configure the server and APIs, and then restart the server.

Notes:

- Debug Profile Service requires Java 8, 11, or 17 (with IBM z/OS Liberty Embedded 23.0.0.12 or later). After installation, you need to configure z/OS to run Java applications.
- Debug Profile Service is hosted on the IBM z/OS Liberty Embedded application server and is compatible with the default IBM z/OS Liberty Embedded installation on your z/OS system. You do not need to install or modify the existing IBM z/OS Liberty Embedded application server to accommodate the Debug Profile Service, but you need to refresh the `eqaprof.env` to include environment variable `liberty_dir`.
- To enable all the features in the **z/OS Debugger Profiles** view with Eclipse, you need to install, configure and start z/OS Explorer 3.2.0.13 or later and Debug Profile Service. For CICS, also see the instructions in “Activating the TCP/IP Socket Interface for CICS” on page 25.

Installing Debug Profile Service

The Debug Profile Service files are installed as z/OS UNIX files in the default location `/usr/lpp/IBM/debug` by using SMP/E during product installation. You can change the installation location to a directory of your choice.

Note: The user ID used for the SMP/E installation must be UID 0, or have at least READ access to the `BPX.SUPERUSER` profile in the FACILITY class. In addition, if the `BPX.FILEATTR.APF` or `BPX.FILEATTR.PROGCTL` profiles are defined in the FACILITY class, the user ID must have READ access to those profiles.

Customizing with the sample job EQAPRFSU

After the SMP/E installation, use sample job EQAW . SEQASAMP (EQAPRFSU) to create configuration and work directories in z/OS UNIX, and copy sample configuration files from the installation directory to the configuration directory for customization.

The following directories are created by EQAPRFSU:

- The home directory for the customized configuration files. The default is `/etc/debug`.
- The home directory for the logs and temporary work files generated by IBM z/OS Liberty Embedded. The default is `/var/debug`.

The following files are copied to the configuration directory by EQAPRFSU. Customize these files to match your system environment:

- `eqaprof.env` contains all parameters needed to deploy the server, including the parameters required for [Debug Profile Service API](#) and [IMS Transaction Isolation Service API](#).
- `dtn.ports` defines the CICS region names, the associated DTCN ports, and the associated hosts and IP addresses used by the Debug Profile Service API.

`keystore.p12` is a sample keystore file generated by EQAPRFSU. It contains a self-signed SSL certificate that you can specify as the server certificate when the file type is PKCS12. The keystore password for generating the keystore sample file is configurable in EQAPRFSU.

Configuring the Debug Profile Service server

Before you add support for the APIs, ensure that the server is configured.

Debug Profile Service is hosted on the [IBM z/OS Liberty Embedded application server](#).

`eqaprof.env`, the Debug Profile Service deployment configuration file

The `eqaprof.env` configuration file contains all parameters needed to deploy the server, the [Debug Profile Service API](#) and [IMS Transaction Isolation Service API](#). For example:

- Java and IBM z/OS Liberty Embedded installation paths
- Which port to use for the service
- Whether SSL security is enabled
- To enable or disable debug logs
- Rate limiting traffic control
- Cross-Origin Resource Sharing (CORS) control
- Configurations to use Debug Profile Service API
- Configurations to use IMS Transaction Isolation Service API

Below is a sample of `eqaprof.env`:

```
# Debug Profile Service configurations
#####
# Changes
#
# APIVersion: 1.2
#   - Removed: port_http & port_https fields.
#   - Added:
#     - 'port' field to support single port
#     - 'SECURE' field to state http or https connection
#     - Set to "Y" for HTTPS (Secure) connection
#     - Set to "N" for HTTP (Non-secure) connection
#
# APIVersion: 1.4
#   - Added fields to enable IMS ISO API:
#     imsiso_dd_eqatipsb
#     imsiso_dd_syslib
#     imsiso_dd_sysproc
#     imsiso_dd_jcllib
```



```

#####

#-----
# Java configuration
#
# Define the path where Java is installed.
#-----
# Home directory of the 64-bit Java SDK
# ** COMMONLY CUSTOMIZED **
java_dir="/usr/lpp/java/J8.0_64"

#-----
# Liberty configuration
#
# Define the path where Liberty is installed.
#-----
# Home directory of IBM z/OS Liberty Embedded web server
# ** COMMONLY CUSTOMIZED **
liberty_dir="/usr/lpp/liberty_zos"

#-----
# Server Generic Configurations
#
# Define the port, secure communication,
# debug logs, rate limiting, and CORS
#-----

# Port number the server listens to for incoming requests
# ** COMMONLY CUSTOMIZED **
port="8143"

# Enable or disable secure communication
# For non-secured HTTP protocol
#SECURE="N"

# For secured HTTPS protocol with an AT-TLS policy
#SECURE="AT-TLS"

# For secured HTTPS protocol with PKCS12, JCERACFKS, or JCECCARACFKS
SECURE="Y"

# [Certificate scenario 1: PKCS12 keystore file]
# Type of certificate storage
keystoreType="PKCS12"
# Pathname of the keystore file where the server certificate is loaded
# ** COMMONLY CUSTOMIZED **
keystoreFile="$EQAPROF_CFG_DIR/keystore.p12"
# Password to access the server certificate from the keystore file
# ** COMMONLY CUSTOMIZED **
keystorePass="liberty"

# [Certificate scenario 2: JCERACFKS (z/OS Keyring) ]
# Type of certificate storage
#keystoreType="JCERACFKS"
# Pathname of the z/OS keyring
# ** COMMONLY CUSTOMIZED **
#keystoreFile="safkeyringjce://STCEQA/EQAPROF.Keyring"
# Password to access the server certificate from the keystore file
# ** COMMONLY CUSTOMIZED **
#keystorePass="password"

# [Certificate scenario 3: JCECCARACFKS (z/OS Keyring) ]
# Type of certificate storage
#keystoreType="JCECCARACFKS"
# Pathname of the z/OS keyring
# ** COMMONLY CUSTOMIZED **
#keystoreFile="safkeyringjcecca://STCEQA/EQAPROF.Keyring"
# Password to access the server certificate from the keyring
# ** COMMONLY CUSTOMIZED **
#keystorePass="password"

# The context path of the URI
# <protocol>://<hostname>:<port>/<context_path>/<endpoint>
context_path="/api/v1"

# Log prints
# ** COMMONLY CUSTOMIZED **

```

```

# true/false - debug log prints/info log prints
enableDebugLogger=false

# Rate Limiter
# true/false - enable rate limiter/disable rate limiter
# If not defined, then the server defaults to true
# ** COMMONLY CUSTOMIZED **
enableRateLimit=true
# double - set the number of request per second allowed into the API
# If not defined, then the server defaults to its own internal values
# ** COMMONLY CUSTOMIZED **
requestsPerSec=1000.0

# CORS (Cross-Origin Resource Sharing)
# Use this option to explicitly define the allowed CORS origins of incoming requests.
# The value of an entry should be of the form:
# <protocol>://<host>:<port>
# For multiple origins, use comma separated values
#
# If property is not defined, then resource is publicly accessible,
# with no access control checks.
# ** COMMONLY CUSTOMIZED **
#corAllowedOrigins=https://localhost:8143

#-----
# Debug Profile Service Components
#
# The supported components are DPS API, IMS ISO API
#-----

#-----
# DPS API - Debug Profile Service API
#-----

# Naming pattern used by the API for working with EQUOPTS data sets
# Note: the ampersand (&) is a reserved character in shell script so
# it must be escaped with a backslash (\) character.
# Note: \&USERID is the naming pattern that gets replaced with the user name.
# If the user is USRT001, then it translates to USRT001.DLAYBDG.EQUOPTS
# ** COMMONLY CUSTOMIZED **
default_dsname="\&USERID.DLAYDBG.EQUOPTS"

# Define the pathname of the configuration file containing the list of CICS region
# Note that this property is required to be defined even if not used.
# ** COMMONLY CUSTOMIZED **
dtn_ports="$EQAPROF_CFG_DIR/dtn.ports"

#-----
# IMS ISO API - IMS Isolation API
#
# These are DD program definitions that enables the EQANIPSB backend program
# that runs on the mainframe. This allows the API to drive EQANIPSB to support
# IMS Isolation
#
# Replace the z/OS Debugger data set names, SEQAMOD, SEQAEXEC, and SEQATLIB with
# the installed z/OS Debugger data set names.
#
# Replace the IMS data set name SDFSRESL with the installed IMS data set name.
#-----

# The EQATIPSB DD is a set of comma separated load libraries that the EQANBSWT Batch
Message Processing (BMP) program will use.
# Note: EQAW.SEQAMOD must be set in this property, and must match the EQAW.SEQAMOD set in
# EQAW.SEQASAMP(EQAPROF) job STEPLIB or system linked-list.
# ** COMMONLY CUSTOMIZED **
imsiso_dd_eqatipsb=EQAW.SEQAMOD,IMS.SDFSRESL,CEE.SCEERUN

# The SYSPROC DD is a set of comma separated REXX routines where the system searches.
# In this case, the debugger's REXX library is specified to prepare JCL for cloning the MPR
job
# ** COMMONLY CUSTOMIZED **
imsiso_dd_sysproc=EQAW.SEQAEXEC

# The JCLLIB DD contains the EQAZPROC member needed to analyze the JCL of an existing
message region.
# ** COMMONLY CUSTOMIZED **
imsiso_dd_jcllib=EQAW.SEQATLIB

imsiso_dd_syslib=SYS1.MACLIB

```

Debug Profile Service security definitions

Perform the following tasks to complete the basic security setup to run Debug Profile Service.

For more information about the sample RACF commands, see *RACF Command Language Reference* (SA22-7687).

Activating the security settings and classes

Debug Profile Service uses various security mechanisms to ensure a secure and controlled host system environment for the client. To do so, several classes and security settings must be active, as shown in the following sample RACF commands:

1. Display current settings:
 - a. SETROPTS LIST
2. Activate FACILITY class:
 - a. SETROPTS GENERIC(FACILITY)
 - b. SETROPTS CLASSACT(FACILITY) RACLIST(FACILITY)
3. Activate SURROGAT class:
 - a. SETROPTS GENERIC(SURROGAT)
 - b. SETROPTS CLASSACT(SURROGAT) RACLIST(SURROGAT)
4. Activate started task definitions:
 - a. SETROPTS GENERIC(STARTED)
 - b. RDEFINE STARTED ** STDATA(USER(=MEMBER) GROUP(STCGROUP) TRACE(YES))
 - c. SETROPTS CLASSACT(STARTED) RACLIST(STARTED)

Defining the Debug Profile Service started task

The following sample RACF commands create the EQAPROF started task, with protected user ID (STCEQA) and the STCGROUP group assigned to it:

1.

```
ADDGROUP STCGROUP OMVS(AUTOUID) -  
DATA('GROUP WITH OMVS SEGMENT FOR STARTED TASKS')
```
2.

```
ADDUSER STCEQA DFLTGRP(STCGROUP) NOPASSWORD -  
NAME('DEBUG PROFILE SERVER') -  
OMVS(AUTOUID HOME('/tmp') PROGRAM('/bin/sh') ASSIZEMAX(2147483647) )  
- DATA('IBM z/OS Debugger')
```
3.

```
RDEFINE STARTED EQAPROF.* -  
STDATA(USER(STCEQA) GROUP(STCGROUP) TRUSTED(NO)) -  
DATA('DEBUG PROFILE SERVICE')
```
4.

```
SETOPTS RACLIST(STARTED) REFRESH
```

Note: Ensure that the started task user ID is protected by specifying the NOPASSWORD keyword.

Enabling Debug Profile Service to switch user context

Debug Profile Service must be able to switch to the client user ID to perform I/O operations on EQAUOPTS data sets. Define specific BPX.SRV profiles in the SURROGAT class in RACF, or specify a general profile to allow the API to switch to any user ID:

1. RDEFINE SURROGAT BPX.SRV.** UACC(NONE)
2. PERMIT BPX.SRV.** CLASS(SURROGAT) ID(STCEQA) ACCESS(READ)
3. SETROPTS RACLIST(SURROGAT) REFRESH

Note: Ensure that the started task user ID is protected by specifying the NOPASSWORD keyword.

Enabling secure communication

You can enable Debug Profile Service to communicate via a Secure Sockets Layer (SSL) certificate with a private key and self-signed certificate stored in a keystore file , a Certificate Authority (CA) certificate with a RACF managed key ring, or AT-TLS.

Remote clients such as the z/OS Debugger Profiles view might perform hostname verification when communicating with Debug Profile Service. Make sure that the hostname is defined in the Subject Alternative Name (SAN) extension of the SSL certificate.

Enabling secure communication with a keystore file

You can use the sample keystore file installed in `/etc/debug/keystore.p12`, or create a new one with the following steps:

1. Create a keystore file by using the Java runtime utility `keytool`:

```
keytool -genkey -alias liberty -keyalg RSA -storetype PKCS12 -keystore keystore.p12 -ext "SAN=DNS: /bin/hostname "
```

2. Edit `/etc/debug/eqaprof.env` and update the keystore variables to use the new keystore file.
3. To ensure that the keystore file is only readable by the protected user ID STCEQA, change the owner and permission of the file with:

```
chown STCEQA:STCGROUP keystore.p12
chmod 640 keystore.p12
```

4. Export the SSL certificate with:

```
keytool -export -keystore keystore.p12 -alias liberty -storetype PKCS12 -file liberty.cer -rfc
```

The SSL certificate can be distributed to remote users to be imported into the client keystore.

For Eclipse users, manually importing the certificate for **z/OS Debugger Profiles** view users is not required because users will be prompted to accept the certificate if it is not already in the keystore the first time the view connects to Debug Profile Service.

Z Open Debug users still need to manually import the self-signed certificate.

Enabling secure communication with a RACF managed key ring

Instead of a keystore file, you can use a RACF managed key ring to enable secure communication with Debug Profile Service. To create a RACF key ring and certificates, you must have authorization to issue RACDCERT commands. For more information about the RACDCERT commands and authorizations that are required, see "RACDCERT (Manage RACF digital certificates)" in the *z/OS Security Server RACF Command Language Reference*.

1. Create a RACF key ring for Debug Profile Service to use as its keystore:

```
RACDCERT ADDRING(EQAPROF.Keyring) ID(STCEQA)
```

2. Create a CA certificate and add it to the key ring:

```
RACDCERT GENCERT CERTAUTH SUBJECTSDN(CN('CA for Debugger Services') O('IBM') OU('IBM z/OS Debugger') C('US')) SIZE(2048) WITHLABEL('zosDebuggerCA') NOTAFTER(DATE(2030-12-31))
RACDCERT CONNECT(CERTAUTH RING(EQAPROF.Keyring) LABEL('zosDebuggerCA')) ID(STCEQA)
```

3. Create a signed personal certificate and add to the key ring:

```
RACDCERT GENCERT SUBJECTSDN(CN('Debug Profile Service') O('IBM') OU('IBM z/OS Debugger') C('US')) ALTNAME(DOMAIN('dps.hostname.com')) SIZE(2048) SIGNWITH(CERTAUTH LABEL('zosDebuggerCA')) WITHLABEL('EQAPROF') NOTAFTER(DATE(2030-12-31)) ID(STCEQA)
RACDCERT CONNECT(RING(EQAPROF.Keyring) LABEL('EQAPROF')) ID(STCEQA)
```

4. Confirm that the key ring and certificates were created correctly:

```
RACDCERT LISTRING(EQAPROF.Keyring) ID(STCEQA)
RACDCERT CERTAUTH LIST(LABEL('zosDebuggerCA'))
RACDCERT LIST(LABEL('EQAPROF')) ID(STCEQA)
```

5. Enable the protected user ID STCEQA authority to access the key ring:

```
PERMIT IRR.DIGTCERT.LIST CLASS(FACILITY) ID(STCEQA) ACC(READ)
PERMIT IRR.DIGTCERT.LISTRING CLASS(FACILITY) ID(STCEQA) ACC(READ)
SETROPTS RACLIST(FACILITY) REFRESH
```

6. Edit `/etc/debug/eqaprof.env` and update the keystore variables to use the key ring:

```
keystoreFile="safkeyringjce://STCEQA/EQAPROF.Keyring"
keystorePass="password"
keystoreType="JCERACFKS"
```

Similar to JCERACFKS, a JCECCARACFKS key ring uses RACF with the addition of ICSF to protect certificates and key material. To use a JCECCARACFKS key ring, edit `/etc/debug/eqaprof.env` with the following:

```
keystoreFile="safkeyringjcecca://STCEQA/EQAPROF.Keyring"
keystorePass="password"
keystoreType="JCECCARACFKS"
```

Notes:

- The value for `keystorePass` must be exactly "password" to satisfy the underlying HTTP server, even though SAF key rings do not have a password.
- Access to ICSF is protected by profiles in the CSFSERV security class. The protected user ID STCEQA must have the proper permissions in order to access the key ring. For more information, see the *z/OS Cryptographic Services ICSF Administrator's Guide*.

7. Export the CA certificate that contains the public key to a z/OS sequential file:

```
RACDCERT CERTAUTH EXPORT(LABEL('zosDebuggerCA')) DSN('<sequential data set>') FORMAT(CERTDER)
```

The CA certificate can be distributed to remote users to be imported into the client keystore manually if necessary.

For Eclipse users, manually importing the certificate for **z/OS Debugger Profiles** view users is not required because users will be prompted to accept the certificate if it is not already in the keystore the first time the view connects to Debug Profile Service.

Z Open Debug users still need to manually import the self-signed certificate.

Enabling secure communication with AT-TLS

You can also use the TCP/IP service called Application Transparent Transport Layer Security (AT-TLS) to enable secure communication with Debug Profile Service. For a step-by-step guide to setting up AT-TLS itself, see [“Setting up AT-TLS” on page 35](#).

1. In the `eqaprof.env` configuration file, specify `SECURE="AT-TLS"`.
2. Create an AT-TLS policy for the port used by Debug Profile Service as specified in the `eqaprof.env` configuration file. See the following sample policy.

```
TTLRule EQAPROF
{
    LocalPortRange          8143
    Direction Inbound
    TTLGroupActionRef      EQAPROF_group
    TTLEnvironmentActionRef EQAPROF_env
    TLSConnectionActionRef EQAPROF_conn
}

TTLGroupAction EQAPROF_group
{
    TTLEnabled          On
}
```

```

TTLSEnvironmentAction EQAPROF_env
{
    HandshakeRole          Server
    TLSKeyringParams
    {
        # Keyring must be owned by the user id (STCEQA) running the EQAPROF started task
        Keyring             eqaprof.keyring
    }
}

TTLSConnectionAction  EQAPROF_conn
{
    HandshakeRole          Server
    TTLSCipherParamsRef   EQAPROF_cipherparms
    TLSConnectionAdvancedParamsRef. EQAPROF_Conn_adv
    CtraceClearText       Off
}

TTLSConnectionAdvancedParams EQAPROF_Conn_adv
{
    TLSv1                  Off
    TLSv1.1                Off
    TLSv1.2                On
    SSLV3                  Off
    ApplicationControlled  Off
    SecondaryMap            Off
    HandshakeTimeout.     20
}

TTLSCipherParams      EQAPROF_cipherparms
{
    V3CipherSuites TLS_ECDHE_ECDSA_WITH_AES_256_GCM_SHA384
    V3CipherSuites TLS_ECDHE_ECDSA_WITH_AES_128_GCM_SHA256
    V3CipherSuites TLS_ECDHE_RSA_WITH_AES_256_GCM_SHA384
    V3CipherSuites TLS_ECDHE_RSA_WITH_AES_128_GCM_SHA256
    V3CipherSuites TLS_DHE_RSA_WITH_AES_256_GCM_SHA384
    V3CipherSuites TLS_DHE_RSA_WITH_AES_128_GCM_SHA256
}

```

Defining Debug Profile Service as a secure z/OS UNIX server

Debug Profile Service requires UPDATE access to the BPX.SERVER resource in the FACILITY class to create or delete the security environment for the client thread:

1. RDEFINE FACILITY BPX.SERVER UACC(NONE)
2. PERMIT BPX.SERVER CLASS(FACILITY) ID(STCEQA) ACCESS(UPDATE)
3. SETROPTS RACLIST(FACILITY) REFRESH



Attention: Defining the BPX.SERVER resource makes z/OS UNIX as a whole switch from UNIX level security to z/OS UNIX level security, which is more secure. This switch might impact other z/OS UNIX applications and operations. Test the security before activating it on a production system. For more information about the different security levels, see *UNIX System Services Planning* (GA22-7800).

Establishing security for Cross-Origin Resource Sharing (CORS)

Cross-Origin Resource Sharing (CORS) is a security feature that is implemented by web browsers to restrict cross-origin HTTP requests initiated by the client-side. By default, web browsers enforce a same-origin policy, which means a web application can only make a request to the same origin it was loaded from. However, CORS relaxes this restriction by allowing servers to specify which origins are permitted to access its resource.

To enable CORS for Debug Profile Service, configure the server configuration `corAllowedOrigins` in the `eqaprof.env` file. Identify the origins from which you want to allow requests, and explicitly add them as an entry. For example, `corAllowedOrigins=https://localhost:8143`.

Adding support for Debug Profile Service API

Debug Profile Service API is a REST API that runs on z/OS to manage debug profiles between CICS and non-CICS environments.

It provides POST/GET/ PUT/DELETE methods to handle the creation, retrieval, updating, and deleting of debug profiles.

Debug Profile Service API handles debug profiles differently between CICS and non-CICS.

- For CICS, debug profiles are stored in a repository that is owned by the region. The repository can either be a CICS temporary storage queue (TSQ), or a VSAM data set allocated to DD:EQADPFMB. To get started, Debug Profile Service API can act as a client, relaying the HTTP request to the DTCN API to handle, which requires a CICS TCPIP SERVICE resource to be set up per region, and each TCPIP SERVICE will require its own TCP/IP port exposed. Alternatively, Debug Profile Service API can be set up to use external CICS interface (EXCI) to manage debug profiles stored in the region's repository, bypassing the DTCN API all together. However, the region names in the configuration file `dtcn.ports` are still required for both setups. To configure the external components, see [“Adding support for the DTCN profiles API” on page 67](#) or [“Defining the CICS EXCI CONNECTION and SESSIONS resources” on page 71](#).
- For non-CICS, debug profiles are stored in EQAUOPTS data sets. Debug Profile Service API manipulates the data sets directly, and therefore needs to be running on the z/OS host. Also, proper RACF setup is required during the API installation to allow for authentication and data set authorization that use SAF/RACF. All required security steps are in [“Debug Profile Service security definitions” on page 63](#).

For the API details, see the "z/OS Debug Profile Service API" documentation in [IBM Documentation](#).

dtcn.ports, the Debug Profile Service CICS DTCN configuration file

The `dtcn.ports` configuration file defines the CICS region names, the associated DTCN ports, and the associated hosts and IP addresses.

A sample of `dtcn.ports` can be found below:

```
# Define the CICS region names, the associated DTCN ports, and
# the associated hosts/IP addresses here.
#
# Note:
#
# For more information on how to set up the CICS TCPIP SERVICE
# resource for the DTCN ports, see "Defining the CICS TCPIP SERVICE
# resource" in the IBM z/OS Debugger Customization Guide (SC27-9583)
#
# Format:
#
# <REGIONNAME>:<HTTP_PORT>,HOST=<HOSTNAME>
#
# REGIONNAME          - CICS region name
# HTTP_PORT           - Port number that DTCN API server in the CICS region listens to for
incoming requests
#
# HOSTNAME [optional] - OR -1 to use CICS EXCI Connections
Fully Qualified Domain Name (FQDN) hostname or IP of the DTCN API
server in the CICS region
#
# For example:
#
# CICTS54A:6000
# CICTS54B:6001
# CICTS54C:6002,HOST=127.1.2.3
# CICTS54D:6003,HOST=tempCICShost11.test.ibm.com
# CICTS54F:-1
```

Adding support for the DTCN profiles API

In a DTCN profile, or a CICS profile, users can specify, for example, the program they want to debug on CICS. Remote users can create, delete, or modify a profile in the following ways:

- Use the **z/OS Debugger Profiles** view to create and manage CICS profiles.

- Write their own application that uses the APIs described in *IBM z/OS Debugger API User's Guide and Reference*.
- Use the DTCN transaction in a 3270 session.

For the first two cases, you need to enable TCP/IP communication between the remote application and an HTTP server running in a CICS region on the z/OS system, as described in [“Defining the CICS TCPIP SERVICE resource” on page 68](#). Then inform your users that you have enabled this support.

For the first case, to enable all the features in the **z/OS Debugger Profiles** view, configure Debug Profile Service for best user experience. For more information, see [“Adding support for Debug Profile Service” on page 58](#).

For all cases, if you want users other than the profile owners to modify or delete DTCN profiles, see [“Defining who can create, modify, or delete DTCN profiles” on page 71](#).

Defining the CICS TCPIP SERVICE resource

Before your users can use the profile view or develop applications that use the APIs, you must define the CICS TCPIP SERVICE resource and add a URIMAP definition for every CICS region that users access.

For every region that users access, do these steps:

1. Define the TCP/IP address and host name for the z/OS system. By default, they are defined in the PROFILE.TCPIP and TCPIP.DATA data sets.
2. Add a TCP/IP listener to CICS. Use the following CEDA command to define a TCPIP SERVICE in a group:

```
CEDA DEF TCPIP SERVICE(service-name) GROUP(group-name)
```

Ensure that the group in which you define the service is in the startup GRPLIST, so that the listener starts when CICS starts. The following list explains what values to use for some of the key fields:

TCpipservice(*service-name*)

Create a name that is eight characters or less.

GRoup(*group-name*)

Create a name that is eight characters or less.

Urm

Specify EQADCAN0.

POrtnumber

Specify an unused port number that Debug Profile Service uses for the API's communication.

STatus

Specify Open.

PROtocol

Specify Http.

TRansaction

Specify CWXN.

Backlog

The number of TCP/IP requests that are queued before TCP/IP starts to reject incoming requests. For example, 30.

SOcketclose

Specify No.

Maxdatalen

Specify the maximum size, in bytes, of the body (the XML document) of the HTTP request or response. For example, 032768 represents 32K bytes.

SSI

Specify Yes if you are using SSL encryption with the HTTPS protocol.

AUthenticate

Specify Basic.

GRPcritical

Specify No.

3. Add a URIMAP definition to match the URLs of the incoming HTTP requests:

```
CEDA DEF URIMAP(map-name) GROUP(group-name)
```

The following list explains what values to use for the key fields:

URIMAP(*map-name*)

Create a name that is eight characters or less.

GROUP(*group-name*)

Specify the same *group-name* as used in the TCPIP SERVICE resource definition.

STATUS

Specify Enabled.

USAGE

Specify Server.

SCHEME

Specify HTTP.

HOST

Specify *.

PATH

Specify /dtcn/*.

ANALYZER

Specify Yes.

4. Enter the following commands to install the TCPIP SERVICE and URIMAP definitions:

```
CEDA INS TCPIP SERVICE(service-name) GROUP(group-name)
```

```
CEDA INS URIMAP(map-name) GROUP(group-name)
```

5. If you encounter problems with the connection from the workstation to the HTTP server in the CICS region, issue the command `CEMT INQUIRE TCPIP SERVICE(service-name)` on the server region to verify if your settings are correct. Your settings must be as follows:

- Port(*nnnn*), where *nnnn* is the port that the workstation connects to.
- Authentication(Basic)
- Maxdatalen(032000)
- Urm(EQADCAN0)

6. Ask your system administrator to provide access to transactions CWBA and CWXN because they are used in the HTTP request processing.

Establishing secure communication between the z/OS Debugger Profiles view and your z/OS system for CICS

These steps help you enable secure communication via Secure Sockets Layer (SSL) between the **z/OS Debugger Profiles** view with Eclipse and your z/OS system. The communication between the client and server uses the HTTP protocol. Z Open Debug provided with Wazi for Dev Spaces or Wazi for VS Code does not support the direct communication between the client and the DTCN API.

Server-side setup

To enable SSL communication, do the following tasks for the server side:

- Generate key pair and self-signed certificate.
 1. Use the RACF GENCERT command to create a key entry for the CICS region owner. The key entry contains the key pair and self-signed certificate.

Note: The following example shows the RACF commands as they would be coded in a REXX exec. This is recommended because of the length of the commands.

Example (Create a key entry for user USERID with label: USERID-DTCNPLG-CERT):

```
/* generate key entry */
"RACDCERT ID(USERID) GENCERT",
" SUBJECTSDN(CN('your_host_name.com' ))",
" T ('USERID-DTCNPLG-CERT' )",
" OU('IBM' )",
" O ('IBM' )",
" L ('San Jose' )",
" SP('CA' )",
" C ('US' )",
" NOTBEFORE (DATE(2011-02-28) TIME(20:00:00) )",
" NOTAFTER (DATE(2031-12-31) TIME(19:59:59) )",
" WITHLABEL ('USERID-DTCNPLG-CERT' )",
" SIZE (1024 )"
```

The common name of the subject DSN must be the host name of the server that the client uses to connect to host.

2. Connect the key entry to a key ring that belongs to the CICS region owner ID.

Example (Connect it to a key ring named USERID):

```
/* connect key entry to key ring */
"RACDCERT ID(USERID)",
"CONNECT( RING(USERID) )",
" LABEL('USERID-DTCNPLG-CERT' )"
```

3. Export the certificate and store it in a data set using the printable encoding format defined by the internet RFC 1421 standard.

Example (Export the certificate to a data set: USERID.DTCNPLG.CERT):

```
/* export certificate to a data set */
"RACDCERT EXPORT(LABEL('USERID-DTCNPLG-CERT' )",
" ID(USERID) )",
" DSN('USERID.DTCNPLG.CERT' )",
" FORMAT(CERTB64 )"
```

- Update system initialization parameters in CICS region.

1. Add a KEYPING system initialization parameter to the CICS region job and point it to the key ring created for the region owner ID.
2. The following example adds KEYPING to the CICS region's system initialization parameters:

```
SIT=6$,
START=INITIAL,
RENTPGM=PROTECT,
...
TRANISO=YES,
KEYRING=key-ring-name,
EDSALIM=132M,
...
```

- Modify the TCIPSERVICE you defined above to set these two attributes:
 - SSL : Yes Yes | No | Clientauth
 - Certificate : USERID-DTCNPLG-CERT

Client-side setup

To enable SSL communication, do the following tasks for the client side. For the **z/OS Debugger Profiles** view users with Eclipse, the following tasks are not required because users will be prompted to accept or decline any certificates that are not installed when using the view.

- Install client certificate.

Because the server certificate generated is not from an authorized CA, you need to install the certificate into the keystore that IBM Developer for z/OS uses.

1. Get a client certificate by downloading a copy of the exported server certificate (using text mode) that is created in step 3 of Server-side setup above to your workstation.
2. Import the client certificate into the keystore. The following is an example how to import the certificate into keystore using keytool provided by Java™.

```
For Java version 1.7: keytool -importcert -alias myprivateroot -keystore
```

```
C:\YOUR_WORKSPACE_DIRECTORY\.metadata\.plugins\com.ibm.cics.core.comm\explorer_keystore.jks -file dtcnplg.cer
```

dtcnplg.cer is the client certificate. The initial password for the keystore is changeit.

Notes:

- For Java version 1.7, the default keystore is:
C:\YOUR_WORKSPACE_DIRECTORY\.metadata\.plugins\com.ibm.cics.core.comm\explorer_keystore.jks
- For IBM Developer for z/OS, the keytool utility can be found in this Java installation bin directory,
C:\DEVELOPER_FOR_Z_SYSTEMS\jdk\jre\bin.

Defining who can create, modify, or delete DTCN profiles

Profile owners can always create, modify or delete their own profiles. However, you can define, through RACF profiles, other users that can modify or delete any profiles. This might be useful, for example, if you want a system administrator to delete unused or obsolete profiles owned by a user that no longer has access to those profiles.

Only the security administrator of the z/OS system can add or remove IDs to the RACF profiles. After you identify the IDs of the users you want to have this access, do these steps:

1. Establish the profile in the FACILITY class by entering the following RDEFINE command:

```
RDEFINE FACILITY EQADTOOL.DTCNCHNGEANY UACC(NONE)
```

2. Verify that generic profile checking is in effect for the class FACILITY by entering the following command:

```
SETROPTS GENERIC(FACILITY)
```

3. Give a user (for example, user DUSER1) permission to modify another user's profiles by entering the following command:

```
PERMIT EQADTOOL.DTCNCHNGEANY CLASS(FACILITY) ID(DUSER1) ACCESS(UPDATE)
```

Instead of connecting individual users, you can specify that DUSER1 be a RACF group profile and then connect authorized users to that group.

4. If the FACILITY class is not active, activate the class by entering the following command:

```
SETROPTS CLASSACT(FACILITY)
```

Enter the SETROPTS LIST command to verify that the FACILITY class is active.

5. Refresh the FACILITY class by entering the following command:

```
SETROPTS RACLIST(FACILITY) REFRESH
```

Defining the CICS EXCI CONNECTION and SESSIONS resources

Instead of using the DTCN API, Debug Profile Service can be set up to use external CICS interface (EXCI) to manage debug profiles stored in the region's repository. Define a CICS CONNECTION resource and a CICS SESSIONS resource for every CICS region that you want Debug Profile Service to access.

1. Use the following CEDA command to define a CONNECTION resource in a group:

```
CEDA DEF CONNECTION(connection-name) GROUP(group-name)
```

Ensure that the group in which you define the resource is in the startup GRPLIST so that the connection starts when CICS starts. Specify values for the key fields:

Key field	Value
CONnection(<i>connection-name</i>)	Name of the connection. Specify a name that is 4 characters or less, for example, DPSC.
Group(<i>group-name</i>)	Name of the group. Specify a name that is 8 characters or less.
Netname	EQAPROF
ACcessmethod	IRC
PRotocol	EXCI
COnnotype	SPECIFIC
INservice	YES
ATtachsec	LOCAL

2. Use the following CEDA command to define a SESSIONS resource in a group:

```
CEDA DEF SESSIONS(sessions-name) GROUP(group-name)
```

Specify values for the key fields:

Key field	Value
Sessions(<i>sessions-name</i>)	Name of the session. Specify a name that is 4 characters or less, for example, DPSC.
Group(<i>group-name</i>)	Name of the group. Use the same group name as in the CONNECTION resource definition.
COnnnection	Name of the connection. Use the same connection name as in the CONNECTION resource definition.
PRotocol	EXCI
RECEIVEPfx	<
RECEIVECount	200

3. Use the following CEDA command to install the CONNECTION and SESSIONS resource definitions in the group:

```
CEDA INS GROUP(group-name)
```

Adding support for IMS Transaction Isolation Service API

IMS Transaction Isolation Service API is a REST API that runs on z/OS to isolate IMS transactions for debugging.

It provides POST/GET/ PUT/DELETE methods to handle the following:

- User's registration for a given transaction

- Retrieving in-memory IMS Transaction Isolation table of registered and nonregistered transaction, which includes metadata such as the user name, region status, region class ID, and pattern matching data.
- Updating a user's registration such as pattern matching criteria
- Deregistering a user for a specific transaction
- Starting a private region for the specified user
- Stopping a private region for the specified user

To use the IMS Transaction Isolation Service API, complete the following:

- [Configure the IMS Transaction Isolation Service API.](#)
- Configure IMS Transaction Isolation Facility:
 - [“Scenario F: Enabling the Transaction Isolation Facility” on page 130](#)
 - [“Sample customization of the IMS Transaction Isolation Facility” on page 134](#)

IMS Transaction Isolation Service API has a dependency with IMS Transaction Isolation Facility, which must be enabled to operate the API. Both the IMS Transaction Isolation Service API and IMS Transaction Isolation Facility use the same in-memory IMS Transaction Isolation table to perform IMS Isolation functions.

- For Eclipse IDE users to access IMS Isolation for non-CICS with Debug Profile Service, also configure the [Debug Profile Service API](#).

Notes:

- The IMS Transaction Isolation Service API works by calling the EQANIPSB program to support IMS Isolation functions, and to interface with IMS subsystem. Both IMS Transaction Isolation Service API and EQANIPSB programs must be able to locate the same SEQAMOD driver in order to operate successfully.
The installation provides a sample job called `EQAW.SEQASAMP(EQAPROF)` that sets SEQAMOD in the STEPLIB of the job. Alternatively, SEQAMOD can be added in the system linked-list. Both options enable IMS Transaction Isolation Service API to locate the current EQANIPSB program. However, SEQAMOD must also be set in the `imso_dd_eqatipsb` property defined in `eqaprof.env`. This enables EQANIPSB to locate the current programs that interface with IMS. A discrepancy between SEQAMODs can cause internal errors.
- A private message processing region (MPR) may transition into a Terminated state if the in-memory IMS Transaction Isolation table expected the private region to be Started, but it discovered that it is Stopped. This can occur if the private MPR is stopped or stops unexpectedly by a process external from IMS Isolation, which causes the in-memory IMS Transaction Isolation table to be out-of-sync with the actual state of the private region. A stop request is required to re-sync the in-memory IMS Transaction Isolation table.

Starting and stopping the Debug Profile Service server

You can use the sample job `EQAW.SEQASAMP(EQAPROF)` to deploy the server.

This job calls the BPXBATCH program to execute the `EQAPROF` start script. The start script is a shell program that parses the `eqaprof.env` configuration file and sets the properties for the server to use.

After the server properties are set, IBM z/OS Liberty Embedded is called to deploy the server.

Customizing the system PROCLIB

Customize the `EQAW.SEQASAMP(EQAPROF)` sample started task member, as described at the beginning of the member file, and copy it to `SYS1.PROCLIB`. The customization is described here for your reference.

As shown in the code sample, provide the following information:

- The home directory where Debug Profile Service is installed. The default directory is `/usr/lpp/IBM/debug`.

- The location of the configuration files. The default location is /etc/debug.
- The name of the environment configuration file. The default name is eqaprof.env.
- The high-level qualifier for the z/OS Debugger load library SEQAMOD.
- The high-level qualifier for the CICS EXCI load library SDFHEXCI.

A sample of EQAPROF can be found below:

```

//*****
//* Licensed Materials - Property of IBM *
// * *
// * 5724-T07: IBM z/OS Debugger *
// * Copyright IBM Corp. 2019, 2022 All Rights Reserved *
// * *
// * US Government Users Restricted Rights - Use, duplication or *
// * disclosure restricted by GSA ADP Schedule Contract with IBM Corp. *
// * *
// * This JCL procedure is used to start the Debug Profile Service. *
// * *
// * You will have to make the following modifications: *
// * *
// * 1) If you installed the product in a different directory than *
// * the default /usr/lpp/IBM/debug, change SVRPATH to refer to *
// * the correct directory. *
// * *
// * 2) If you customized the configuration files in a different *
// * directory than the default /etc/debug, change CFGDIR to *
// * refer to the correct directory. *
// * *
// * 3) If you want the server to use a different work directory *
// * then the default /var/debug, change WRKDIR to refer to the *
// * desired directory. *
// * *
// * 4) If you customized the environment variables file in CFGDIR *
// * to a different file name than the default eqaprof.env, change *
// * ENVFILE to refer to the correct name. *
// * *
// * 5) Change EQAHLQ to meet your installation requirements for *
// * SEQAMOD. *
// * *
// * 5) Change DFHHLQ to meet your installation requirements for *
// * SDFHEXCI. *
// * *
// * Note(s): *
// * *
// * 1. This procedure contains case sensitive path statements. *
// * *
// * 2. Add a job card on line 1 and '//EQAPROF EXEC EQAPROF' at the *
// * bottom to submit this procedure as a user job. *
// * *
//*****
// *
// * Debug Profile Service
// *
//EQAPROF PROC SVRPATH='/usr/lpp/IBM/debug',
// CFGDIR='/etc/debug',
// WRKDIR='/var/debug',
// ENVFILE='eqaprof.env',
// EQAHLQ='EQAW',
// DFHHLQ='DFH.CICS',
// TZ='EST5EDT'
// SET QUOTE='''
//EXPORTS EXPORT SYMLIST=*
// SET SVRPATH=&QUOTE&SVRPATH&QUOTE
// SET CFGDIR=&QUOTE&CFGDIR&QUOTE
// SET WRKDIR=&QUOTE&WRKDIR&QUOTE
// SET ENVFILE=&QUOTE&ENVFILE&QUOTE
// SET TZ=&QUOTE&TZ&QUOTE
// *-----
// * Start the Debug Profile Service
// *-----
//EQAPROF EXEC PGM=BPXBATCH,REGION=0M,TIME=NOLIMIT,MEMLIMIT=2G,
// PARM='PGM /bin/sh &SVRPATH/servers/eqaProfile/bin/start.sh'
//STEPLIB DD DSN=&EQAHLQ..SEQAMOD,DISP=SHR
// DD DSN=&DFHHLQ..SDFHEXCI,DISP=SHR
//STDOUT DD SYSOUT=*
//STDERR DD SYSOUT=*
//STDENV DD *,SYMBOLS=JCLONLY

```

```
TZ=&TZ
EQAPROF_CFG_DIR=&CFGDIR
EQAPROF_WRK_DIR=&WRKDIR
EQAPROF_ENVFILE=&CFGDIR/&ENVFILE
_BPXK_AUTOCVT=ON
/*
//          PEND
//*
```

Starting and stopping Debug Profile Service dynamically

To start the server, use the following console command:

```
S EQAPROF
```

To stop the server, use the following console command:

```
P EQAPROF1
```

Updating PARMLIB to start the server during IPL

Add a start command for Debug Profile Service to SYS1.PARMLIB(COMMNDxx) to start it automatically at the next system IPL. Define CMD=xx in the IEASYSxx parmlib member to specify the COMMNDxx parmlib member that is used during IPL.

Managing profiles with z/OS Debugger Profile Management

In z/OS Debugger Profile Management, system administrators can identify and delete profiles that might interfere with z/OS system resources. Currently, only CICS profiles (also known as DTCN profiles) are supported.

Before you can use z/OS Debugger Profile Management, ensure that [Debug Profile Service](#) is installed and configured, and that your z/OS user ID has [the authority to manage other users' CICS \(DTCN\) profiles](#).

Accessing z/OS Debugger Profile Management

1. Access z/OS Debugger Profile Management with one of the following methods:

- Go to the website directly with a URL in one of the following formats:
 - <https://{hostname}:{port}/profile-management>, if you specify SECURE="Y" in [eqaprof.env](#).
 - <http://{hostname}:{port}/profile-management>, if you specify SECURE="N" in [eqaprof.env](#).

where:

hostname

The name of your z/OS host.

port

The port number defined in [eqaprof.env](#).

- In the z/OS Debugger Profiles view, click the view menu (▾) in the view toolbar to display the **Show Profile Management** menu option. When you hover your mouse over **Show Profile Management**, the name of the host that is connected through the **Remote Systems** view is displayed. Ensure that the connection port is set to the RSE port that supports Debug Profile Service.
2. In z/OS Debugger Profile Management, log in with your z/OS user ID with administration privilege to Debug Profile Service.

What is displayed in the table

Search field: Enter the search text to display only the profiles that match your search text.

Region list: Select the CICS region to display all the profiles in this region.

In the table, the following columns are displayed:

Owner

Displays the owner of the profile. Generic profiles that might cause unexpected debug sessions are highlighted with a warning icon (▲) next to the owner name.

State

Indicates that the profile is active or inactive.

Transaction

Displays the transaction to trigger a debug session.

Terminal ID

Displays the terminal ID to trigger a debug session.

Net Name

Displays the name of a CICS terminal or CICS system to trigger a debug session.

You can click any column header to sort the list of profiles based on the contents of that column in default, ascending, or descending order.

Working with the profile data

To evaluate whether a profile is causing problems, you can click the owner to display the profile data in the **Profile Data** window. Generic profiles that might cause unexpected debug sessions are highlighted with a warning icon (▲) next to the owner name.

In this window, you can complete the following tasks:

- View the profile data.
- Copy the profile data with the **Copy to clipboard** icon (□).
- Save the profile data in a .json file.

You can then use the copied profile data or downloaded file to collaborate with others.

To prevent generic profiles, specify DTCNFORCExxxx settings to make some fields mandatory.

Deleting a profile

If necessary, you can delete other users' profiles in the table.

- Select one or more owners.
- Click **Delete**. The profiles under the selected owns are deleted.

Debug Profile Service diagnostics

- Debug Profile Service uses standard HTTP status codes to indicate the success or failure of the API call. If a failure occurs, the response contains a JSON body with an IBM message ID, which can be used to look-up more information about the error in Debug Profile Service messages in *IBM z/OS Debugger Reference and Messages*.
- Debug Profile Service produces debug, information, and error logs that can be managed in eqaprof.env. All logs are written in the server's job standard output (STDOUT).
- IBM z/OS Liberty Embedded server unifies logging and tracing with a feature known as First Failure Data Capture (FFDC) services. It collects information about an event that might lead up to a failure. The FFDC logs are written in the work directory: "#{WRKDIR}" /eqaProfile/logs/ffdc, where:
 - "#{WRKDIR}" is defined in EQAW.SEQASAMP (EQAPROF).
 - The eqaProfile/logs directory is created when the IBM z/OS Liberty Embedded server is started, if it does not exist.

- The `ffdc` directory is created when an exception occurs, if it does not exist. You can clean log files in the `ffdc` directory if there are too many.
- Debug Profile Service has successfully deployed if it logs that Debug Profile Service API and IMS Transaction Isolation Service API have started in the job standard output (STDOUT).
- Use the Debug Profile Service API discovery endpoint in a web browser of your choice to produce a single manual HTTP request to the server, if in doubt whether the server is not running or cannot fulfill a request. The discovery endpoint is in the form of `<protocol>://<hostname>:<port>/<context_path>/profile/dtcn`, and it queries the contents in the `dtcn.ports` file. If the server fulfills the discovery endpoint request, then it responds back with a JSON body that contains `{"hostname": "<hostname>", "apiversion": "<version>", "regions": <a list of regions defined in dtcn.ports file>}`.

Enabling secure communication between z/OS Debugger and the remote debugger for incoming debug sessions

This section assists you in setting up a secure communication by using the z/OS Communications Server: IP Application Transparent – Transport Layer Security (AT-TLS) service when you use the TCPIP or DIRECT suboption in the TEST runtime option. By exploiting the Secure Sockets Layer (SSL) functions of AT-TLS, z/OS Debugger provides a secure (encrypted) communication with the remote Eclipse debugger.

The setup assumes that the remote debugger is the TCP/IP server and z/OS Debugger is the TCP/IP client.

Carry out the following steps:

- Add a client certificate.

Export a copy of a client certificate from the keystore that the remote debugger uses. This client certificate is used by AT-TLS to authenticate the TCP/IP server (remote debugger) during SSL handshaking. If the remote debugger does not have a certificate, you can use the following Java runtime utility to create a keystore and certificate and to export a client certificate.

Create a keystore and certificate

```
keytool -genkeypair
```

Export a client certificate

```
keytool -exportcert
```

Each Eclipse IDE user must configure the debug daemon to start on a secured port with the location and password of the keystore created previously. These settings can be found on **Preferences > Run/Debug > Debug Daemon** preference page. For more information about the Debug Daemon preference page, see the "Setting debug preferences" topic in [IBM Documentation](#).

Upload the certificate to z/OS in binary mode and store it as a SITE or CERTAUTH certificate in RACF or other equivalent security facility. The following examples use the **RACDCERT** command to add a certificate:

```
RACDCERT SITE
ADD('USERID1.DTPDT.CERT1') WITHLABEL('DTPDT-CERT1') TRUST

RACDCERT CERTAUTH
ADD('USERID1.DTPDT.CERT1') WITHLABEL('DTPDT-CERT1') TRUST
```

where `USERID1.DTPDT.CERT1` is a file that contains the uploaded certificate and `DTPDT-CERT1` is a label of the certificate in RACF.

The following information is used in the previous examples:

USERID1.DTPDT.CERT1

A file that contains the uploaded certificate.

DTPDT-CERT1

A label of the certificate in RACF.

Note: Both SITE and CERTAUTH certificates work with the key ring ***SITE*/*** parameter in TTLSKeyRingParms definition below. If you use a CERTAUTH certificate, also define the ***AUTH*/*** parameter.

- Add an AT-TLS rule.

The rule allows AT-TLS to enable SSL when z/OS Debugger connects to the remote debugger on a specified port. The following example shows that the remote debugger listens to the secure port 9101. In your development environment, you must determine which secure port the remote debugger listens to and use it in the RemotePortRange statement.

```

TTLSRule DTPDTRL1
{
  RemotePortRange 9101                <=== secure port
  Direction Outbound                  <=== outbound direction
  TTLSGroupActionRef DTPDTRL1GrpAct
  TTLSEnvironmentActionRef DTPDTRL1EnvAct
}
TTLSGroupAction DTPDTRL1GrpAct
{
  TTLSEnabled On                      <=== enable rule
  Trace 30
}
TTLSEnvironmentAction DTPDTRL1EnvAct
{
  TTLSKeyRingParms
  {
    Keyring *SITE*/*                  <=== virtual key ring
  }
  HandShakeRole Client
}

```

AT-TLS currency

A TLS v1.2 protocol is available that uses more secured algorithms during SSL handshake operations. To use the protocol, take the following steps.

For z/OS Version 1 Release 13

1. Two APARs OA39422 and PM62905 are required to enable TLS v1.2 in z/OS v1.13.
2. AT-TLS rule update. The following code is an example for secure port 9102:

```

TTLSRule DTPDTRL2
{
  RemotePortRange 9102
  Direction Outbound
  TTLSGroupActionRef DTPDTRL2GrpAct
  TTLSEnvironmentActionRef DTPDTRL2EnvAct
}
TTLSGroupAction DTPDTRL2GrpAct
{
  TTLSEnabled On
  Trace 30
  TTLSGroupAdvancedParms
  {
    Envfile /etc/pagent/DTPDTRL2grp.env <== DTPDTRL2grp.env contains
    GSK_PROTOCOL_TLSV1_2=ON
  }
  <=== system SSL environment variable.
}
TTLSEnvironmentAction DTPDTRL2EnvAct
{
  TTLSKeyRingParms
  {
    Keyring *SITE*/*
  }
  HandShakeRole Client
}

```

For z/OS Version 2 Release 1

1. TLS v1.2 support is included in z/OS v2.1 base.

2. AT-TLS rule update. The following code is an example for secure port 9102:

```
TTLSSRule DTPDTRL2
{
  RemotePortRange 9102
  Direction Outbound
  TTLSSGroupActionRef DTPDT2GrpAct
  TTLSEnvironmentActionRef DTPDT2EnvAct
}
TTLSSGroupAction DTPDT2GrpAct
{
  TTLSSEnabled On
  Trace 30
}
TTLSEnvironmentAction DTPDT2EnvAct
{
  TTLSKeyRingParms
  {
    Keyring *SITE*/*
  }
  HandShakeRole Client
  TTLSEnvironmentAdvancedParms
  {
    TLSv1.2 On
  }
}
}
```

Chapter 8. Specifying the TEST runtime options through the Language Environment user exit

z/OS Debugger provides a customized version of the Language Environment user exit (CEEEXITA). The user exit returns a TEST runtime option when called by the Language Environment initialization logic. z/OS Debugger provides a user exit that supports three different environments. This topic is also described in *IBM z/OS Debugger User's Guide* with information specific to application programmers.

The user exit extracts the TEST runtime option from a user controlled data set with a name that is constructed from a naming pattern. The naming pattern can include the following tokens:

&USERID

z/OS Debugger replaces the &USERID token with the user ID of the current user. Each user can specify an individual TEST runtime option when debugging an application. This token is optional.

&PGMNAME

z/OS Debugger replaces the &PGMNAME token with the name of the main program (load module). Each program can have its own TEST runtime options. This token is optional.

z/OS Debugger provides the user exit in two forms:

- A load module. The load modules for the three environments are in the *hlq.SEQAMOD* data set. Use this load module if you want the default naming patterns and message display level. The default naming pattern is &USERID.DBGTOOL.EQAUOPTS and the default message display level is X'00'.
- Sample assembler user exit that you can edit. The assembler user exits for the three environments are in the *hlq.SEQASAMP* data set. You can also merge this source with an existing version of CEEEXITA. Use this source code if you want naming patterns or message display levels that are different than the default values.

z/OS Debugger provides a customized version of the Language Environment user exit named EQAD3CXT. The following table shows the environments in which this user exit can be used. The EQAD3CXT user exit determines the runtime environment internally and can be used in multiple environments.

Environment	User exit name
The following types of Db2 stored procedures that run in WLM-established address spaces: <ul style="list-style-type: none"> • type MAIN¹ • type SUB² 	EQAD3CXT
IMS TM ³ and BTS ⁴	EQAD3CXT
Batch	EQAD3CXT

Note:

1. EQAD3CXT is supported for DB2 version 7 or later. If Db2 RUNOPTS is specified, EQAD3CXT takes precedence over Db2 RUNOPTS.
2. EQAD3CXT supports Db2 stored procedures PROGRAM TYPE=SUB if you set the RRTN_SW flag as x'01'.
3. For IMS TM, if you do not sign on to the IMS terminal, you might need to run the EQASET transaction with the TS0ID option. For instructions on how to run the EQASET transaction, see "Debugging Language Environment IMS MPPs without issuing /SIGN ON" in the *IBM z/OS Debugger User's Guide*.
4. For BTS, you need to specify Environment command (./E) with the user ID of the IO PCB. For example, if the user ID is ECSVT2, then the Environment command is ./E USERID=ECSVT2.

Your users can use the user exit in the following ways:

- The user can link the user exit into his application program.
- The user can link the user exit into a private copy of a Language Environment module (CEEBINIT, CEEPIPI, or both), and then, only for the modules the user might debug, place the SCEERUN data set containing this module in front of the system Language Environment modules in CEE.SCEERUN in the load module search path.

To learn about the advantages and disadvantages of each method, see [“Comparing the two methods of linking CEEBXITA”](#) on page 84.

To prepare your site to use the Language Environment user exit, do the following tasks:

1. [“Editing the source code of CEEBXITA”](#) on page 82.
2. [“Linking the CEEBXITA user exit into a private copy of a Language Environment runtime module”](#) on page 85.

To do the instructions in [“Customizing for JCL for Batch Debugging utility”](#) on page 92, you need the following information:

- If you change the naming pattern of the TEST runtime options data set, you need the new naming pattern you set in [“Modifying the naming pattern”](#) on page 82.
- The name of the *hlq*.BATCH.SCEERUN data set you create when you do the instructions in [“Linking the CEEBXITA user exit into a private copy of a Language Environment runtime module”](#) on page 85.

To do the instructions in [“Customizing z/OS Debugger User Exit Data Set”](#) on page 99, you need the following information:

- If you change the naming pattern of the TEST runtime options data set, you need the new naming pattern you set in [“Modifying the naming pattern”](#) on page 82.

To do the instructions in [“Customizing IMS Transaction and User ID Cross Reference Table ”](#) on page 102, you need the following information:

- If you change the name of the cross reference table data set, you need the data set name you set in [“Activate the cross reference function and modifying the cross reference table data set name”](#) on page 84.

Editing the source code of CEEBXITA

You can edit the sample assembler user exit that is provided in *hlq*.SEQASAMP to customize the naming patterns or message display level by doing one of the following tasks:

- Use SMP/E USERMOD EQAUMODK⁷ to update the copy of the exit in the *hlq*.SEQAMOD data set. The USERMOD is in *hlq*.SEQASAMP.
- Create a private load module for the customized exit. Copy the assembler user exit that has the same name as the user exit from *hlq*.SEQASAMP to a local data set. Edit the patterns or message display level. Customize and run the JCL to generate a load module.

Modifying the naming pattern

The naming pattern of the data set that has the TEST runtime option is in the form of a sequential data set name. You can optionally specify a &USERID token, which z/OS Debugger substitutes with the user ID of the current user. You can also add a &PGMNAME token, which z/OS Debugger substitutes with the name of the main program (load module). However, if users create and manage the TEST runtime option data set with the **DTSP Profile** view in the remote debugger, do not specify the &PGMNAME token because the view does not support that token.

⁷ USERMOD EQAUMODK is provided for updating EQAD3CXT. See "SMP/E USERMODs" in the *IBM z/OS Debugger Customization Guide* for an SMP/E USERMOD for this customization.

In some cases, the first character of a user ID is not valid for a name qualifier. A character can be concatenated before the &USERID token to serve as the prefix character for the user ID. For example, you can prefix the token with the character "P" to form P&USERID, which is a valid name qualifier after the current user ID is substituted for &USERID. For IMS, &USERID token might be substituted with one of the following values:

- IMS user ID, if users sign on to IMS.
- TSO user ID, if users do not sign on to IMS.

The default naming pattern is &USERID.DBGTOOL.EQAUOPTS. This is the pattern that is in the load module provided in *hlq.SEQAMOD*.

The following table shows examples of naming patterns and the corresponding data set names after z/OS Debugger substitutes the token with a value.

Naming pattern	User ID	Program name	Name after user ID substitution
&USERID.DBGTOOL.EQAUOPTS	USERIBM		USERIBM.DBGTOOL.EQAUOPTS
P&USERID.EQAUOPTS	123456		P123456.EQAUOPTS
DT.&USERID.TSTOPT	TESTID		DT.TESTID.TSTOPT
DT.&USERID.&PGMNAME.TSTOPT	TESTID	IVP1	DT.TESTID.IVP1.TSTOPT

To customize the naming pattern of the data set that has TEST runtime option, change the value of the DSNT DC statement in the sample user exit. For example:

```
* Modify the value in DSNT DC field below.
*
* Note: &USERID below has one additional '&', which is an escape
*       character.
*
DSNT_LN      DC  A(DSNT_SIZE) Length field of naming pattern
DSNT        DC  C'&&USERID.DBGTOOL.EQAUOPTS'
DSNT_SIZE   EQU *-DSNT      Size of data set naming pattern
*
```

Modifying the message display level

You can modify the message display level for CEEBXITA. The following values set WTO message display level:

X'00'

Do not display any messages.

X'01'

Display error and warning messages.

X'02'

Display error, warning, and diagnostic messages.

The default value, which is in the load module in *hlq.SEQAMOD*, is X'00'.

To customize the message display level, change the value of the MSGS_SW DC statement in the sample user exit. For example:

```
* The following switch is to control WTO message display level.
*
* x'00' - no messages
* x'01' - error and warning messages
* x'02' - error, warning, and diagnostic messages
*
MSGS_SW      DC  X'00'      message level
*
```

Modifying the call back routine registration

You can register a call back routine to the Language Environment. The Language Environment invokes the call back routine prior to calling a type SUB program using CALL_SUB API in the CEEPIPI environment. The call back routine performs a pattern match to determine if the type SUB program is to be debugged.

To customize the registration, change the value of the RRTN_SW DC statement.

x'00'

No registration of the call back routine.

x'01'

Registration of the call back routine.

Activate the cross reference function and modifying the cross reference table data set name

You can activate the cross reference function of the IMS Transaction and User ID Cross Reference Table and provide a cross reference table data set name. When an IMS transaction is initiated from the web or MQ gateway, it runs with a generic ID. If a user wants to debug the transaction, the cross reference function provides a way to associate the transaction with his or her user ID.

To customize the activation, change the value of the XRDSN_SW DC statement.

x'00'

Cross reference function is not activated.

x'01'

Cross reference function is activated.

To customize the cross reference table data set name, change the value of the XRDSN DC statement. You must provide a fully qualified MVS sequential data set name.

Comparing the two methods of linking CEEBXITA

You can link in the user exit CEEBXITA in the following ways:

- Link it into the application program.

Advantage

The user exit affects only the application program being debugged. This means you can control when z/OS Debugger is started for the application program. You might also not need to make any changes to your JCL to start z/OS Debugger.

Disadvantage

You must remember to remove the user exit for production or, if it isn't part of your normal build process, you must remember to relink it to the application program.

- Link it into a private copy of a Language Environment runtime load module (CEEINIT, CEEPIPI, or both)

Advantage

You do not have to change your application program to use the user exit. In addition, you do not have to link edit extra modules into your application program.

Disadvantage

You need to take extra steps in preparing and maintaining your runtime environment:

- Make a private copy of one or more Language Environment runtime routines
- Only for the modules you might debug, customize your runtime environment to place the private copies in front of the system Language Environment modules in CEE.SCEERUN in the load module search path
- When you apply maintenance to Language Environment, you might need to relink the routines.
- When you upgrade to a new version of Language Environment, you must relink the routines.

If you link the user exit into the application program and into a private copy of a Language Environment runtime load module, which is in the load module search path of your application execution, the copy of the user exit in the application load module is used.

Linking the CEEBXITA user exit into a private copy of a Language Environment runtime module

The following table shows the Language Environment runtime load module and the user exit needed for each environment.

Environment	User exit name	CEE load module
The following types of Db2 stored procedures that run in WLM-established address spaces: <ul style="list-style-type: none"> • type MAIN • type SUB¹ 	EQAD3CXT	CEEPIPI
IMS TM and BTS	EQAD3CXT	CEEBINIT
Batch	EQAD3CXT	CEEBINIT

Note:

1. EQAD3CXT supports Db2 stored procedures PROGRAM TYPE=SUB if you set the RRTN_SW flag as x'01'.

Edit and run sample *hlq.SEQASAMP(EQAWLCE3)* to create these updated Language Environment runtime modules. The sample creates the following load module data sets:

- *hlq.DB2SP.SCEERUN(CEEPIPI)*
- *hlq.IMSTM.SCEERUN(CEEBINIT)*
- *hlq.BATCH.SCEERUN(CEEBINIT)*

Inform your users that you created these data sets. When you apply service to Language Environment that affects either of these modules (CEEPIPI or CEEBINIT) or you move to a new level of Language Environment, you need to rebuild your private copy of these modules by running the sample again.

Creating and managing the TEST runtime options data set

The TEST runtime options data set is an MVS data set that contains the Language Environment runtime options. The z/OS Debugger Language Environment user exit EQAD3CXT constructs the name of this data set based on a naming pattern described in [“Modifying the naming pattern” on page 82](#) “Modifying the naming pattern” in the *IBM z/OS Debugger Customization Guide*.

If your site does not allow your users to create data sets, you must create the data sets manually with the following requirements:

- Sequential data set (DSORG=PS)
- Record format and length requirements:
 - RECFM(F) or RECFM(FB) and LRECL >=80
 - RECFM(V) or RECFM(VB) and LRECL >=84
- Not an HFS or zFS file
- Name the data set so it follows the naming pattern defined in [“Modifying the naming pattern” on page 82](#).

Your users can then use any of the following ways to create the data set:

- By using Terminal Interface Manager (TIM), as described in "Creating and managing the TEST runtime options data set by using Terminal Interface Manager (TIM) " in the *IBM z/OS Debugger User's Guide*.
- By using IBM z/OS Debugger Utilities option 6, "z/OS Debugger User Exit Data Set", as described in "Creating and managing the TEST runtime options data set by using z/OS Debugger Utilities" in the *IBM z/OS Debugger User's Guide*.
- By using the z/OS Debugger Profiles view in the Eclipse IDE or the z/OS Debugger Profiles view provided with Z Open Debug.
- In the Eclipse IDE, by specifying a non-CICS profile in the z/OS Batch Application with existing JCL launch configuration. For more information, see the "Launching a debug session using existing JCL" topic in [IBM Documentation](#).
- By configuring the **Remote Profile** tab from Remote IMS Application with Isolation debug configurations.

Chapter 9. Installing the browse mode RACF facility

z/OS Debugger browse mode can be controlled by either the browse mode RACF facility, through the EQAOPTS BROWSE command, or both. For an overview of browse mode and how to control it, see "Debugging in browse mode" in the *IBM z/OS Debugger User's Guide*.

If you want to use RACF to enforce one of the following situations, you must install the browse mode RACF facility:

- Debug programs in a production environment (or some other environment) where you want to control whether z/OS Debugger users can modify the contents of storage or alter program flow
- Restrict the use of z/OS Debugger to certain users

Note: If you have defined a generic Facility class profile (for example, *.*), you might have to install the browse mode RACF facilities described below, even if neither of the previous considerations apply. For example, if you have a generic Facility class profile of *.* with UACC (NONE) and you do not install the browse mode RACF facilities described below, no users would be allowed to use z/OS Debugger.

To install the browse mode RACF facility, your security administrator must do the following tasks:

1. Choose one or both RACF facilities associated with the browse mode facility to install, then install the chosen facilities.
2. Set up the default user access to the facility.
3. Authorize those users that need access other than the default access.

Refer to the following topics for more information related to the material discussed in this topic.

Related tasks

[“BROWSE” on page 156](#)

Choose and install appropriate RACF facility

The following RACF facilities are associated with the browse mode facility:

- EQADTOOL.BROWSE.MVS
- EQADTOOL.BROWSE.CICS

You can install either or both facilities. The first facility controls browse mode for non-CICS MVS jobs. The second controls browse mode access in CICS regions.

In most cases, if you install the browse mode RACF facility, then specify UACC(READ). However, assigning *fac_uacc* any of the following values creates the corresponding result:

NONE

Only users specifically authorized to the facility (through *usr_acc* of READ or higher) can use z/OS Debugger in any way.

READ

Only users specifically authorized to the facility (through *usr_acc* of UPDATE or higher) can use z/OS Debugger in the normal (non-browse mode) way.

UPDATE

Users specifically authorized to the facility can be limited to using z/OS Debugger in browse mode but all other users can use z/OS Debugger in either the normal (non-browse mode) way or in browse mode, depending on the option specified for the EQAOPTS BROWSE command.

The following instructions use EQADTOOL.BROWSE.xxx to represent either or both of facilities. If you choose to install both, you need to run the steps twice, once with each name.

Do the following steps to install the browse mode facility:

1. Establish a profile for the browse mode facility in the FACILITY class by entering the following RDEFINE command:

```
RDEFINE FACILITY EQADT00L.BROWSE.xxx UACC(fac_uacc)
```

2. Verify that generic profile checking is in effect for the class FACILITY by entering the following command:

```
SETROPTS GENERIC(FACILITY)
```

Set up user access to facility

When you assign *usr_acc* any of the following values to grant access to a specific user, you create the corresponding result:

NONE

The user cannot use z/OS Debugger in any way.

READ

The user can use z/OS Debugger only in browse mode.

UPDATE (or higher)

The user can use z/OS Debugger in the normal (non-browse) mode by default. He can also specify the EQAOPTS BROWSE command to specify that he wants the current invocation of z/OS Debugger to be in browse mode or normal mode.

Do the following steps to give individual users or user groups specific access to the browse mode facility:

1. Give a user permission to use the browse mode facility by entering the following command, where *DUSER1* is the name of a RACF-defined user or group profile:

```
PERMIT EQADT00L.BROWSE.xxx CLASS(FACILITY) ID(DUSER1) ACCESS(usr_acc)
```

Instead of connecting individual users, the security administrator can specify *DUSER1* to be a RACF group profile and then connect authorized users to the group.

2. If the FACILITY class is not active, activate the class by entering the SETROPTS command:

```
SETROPTS CLASSACT(FACILITY)
```

Issue the SETROPTS LIST command to verify that FACILITY class is active.

3. Refresh the FACILITY class by issuing the SETROPTS RACLIST command:

```
SETROPTS RACLIST(FACILITY) REFRESH
```

Chapter 10. Customizing IBM z/OS Debugger Utilities

Note: This chapter is not applicable to IBM Developer for z/OS (non-Enterprise Edition) or IBM Z and Cloud Modernization Stack (Wazi Code).

IBM z/OS Debugger Utilities is a group of ISPF applications that provide the following tools and functions:

- **Program Preparation** to help application programmers precompile, compile, and link their programs and then start z/OS Debugger. This includes using COBOL and CICS Command Level Conversion Aid (CCCA) to help application programmers convert older COBOL programs to Enterprise COBOL programs.
- **z/OS Debugger Setup File**, which manages setup files. Setup files help application programmers prepare programs to debug them interactively or in batch mode.
- **IMS TM Debugging** to help users edit the TEST runtime options that IMS programs use and to create private message regions for testing.

The functions include the IMS Transaction Isolation facility, which allows users to select IMS transactions to debug in a private message-processing region.

- **z/OS Debugger User Exit Data Set** to create and edit a data set that Language Environment user exits read to obtain the TEST runtime options string.
- **Other IBM Application Delivery Foundation for z/OS tools** to help users start IBM File Manager for z/OS.
- **JCL for Batch Debugging** to help users start a debug session when they run their application in a batch job.
- **IMS BTS Debugging** to help users start a debug session when they run their IMS BTS applications.
- **Delay Debug Profile** to create a delay debug profile data set that the z/OS Debugger delay debug pattern matching uses to start a debug session.
- **IMS Transaction and User ID Cross Reference Table** to create a cross reference table entry that z/OS Debugger uses to associate a user ID to an IMS transaction.
- **Non-CICS Debug Session Start and Stop Message Viewer** to browse debug session start and stop messages.
- **z/OS Debugger Code Coverage** to specify code coverage options, observation selections, and do viewing and reporting.
- **z/OS Debugger Deferred Breakpoints** to create and view a list of breakpoints prior to starting the debug session. It reduces the time spent on the debugging session and also the system resource usage.
- **z/OS Debugger JCL Wizard** is an ISPF edit macro (EQAJCL) that allows you to modify a JCL or procedure member and create statements to invoke z/OS Debugger in various environments.

The instructions in this section describe the following customization tasks:

- Choose a method to start IBM z/OS Debugger Utilities
- Customize the data set names in EQASTART.
- Add IBM z/OS Debugger Utilities to an ISPF menu so that your users can start IBM z/OS Debugger Utilities from an ISPF menu.
- Modify z/OS Debugger Setup Utility so that your users can access procedure libraries.
- Customize the JCL for Batch Debugging interface.
- Customize the Other IBM Application Delivery Foundation for z/OS tools interface.
- Customize Program Preparation so that users access the proper compilers and development utilities.
- If your users use the IMS TM Setup - Manage LE Runtime Options function in IBM z/OS Debugger Utilities, make changes so that users can access this function in an IMSplex environment.

- Customize IMS BTS Debugging with default values for the TEST runtime option and data set names for the z/OS Debugger load module, user exit module, debug information files, IMS subsystem IDs, and base JCLs.
- Customize the z/OS Debugger User Exit Data Set utility.
- Customize the Delay Debug Profile utility.
- Customize the IMS Transaction and User ID Cross Reference Table utility.
- Customize the Non-CICS Debug Session Start and Stop Message Viewer utility.
- Customize z/OS Debugger Code Coverage.
- Install and customize z/OS Debugger JCL Wizard.

Choosing a method to start IBM z/OS Debugger Utilities

Your users can start IBM z/OS Debugger Utilities by doing one of the following methods:

Method 1: Enter the EXEC 'hlq.SEQAEXEC(EQASTART)' command. This is the default method.

Method 2: Enter the EQASTART command. To use this method, you must do the following steps, which are described in this section:

1. Include or copy the IBM z/OS Debugger Utilities and Common Components data sets to your system's TSO logon data sets. To add the data sets, do one of the following alternatives:
 - Include the data sets listed in [Table 16 on page 90](#), [Table 17 on page 91](#), or [Table 18 on page 91](#) into the DD concatenations specified in the tables.
 - Copy⁶ the members of the data sets listed in [Table 16 on page 90](#), [Table 17 on page 91](#), or [Table 18 on page 91](#) to a data set allocated to the DD concatenation specified in the table.

For either alternative, the data sets you include into the DD concatenations must match the national language you chose in [“Changing the default and allowable values in EQACUIDF”](#) on page 145.

2. Edit the EQASTART⁸ member of the hlq.SEQAEXEC data set and set the *Inst_NATLANG_commonlib* variable to ENU, UEN, JPN, or KOR depending on the national language you chose in [“Changing the default and allowable values in EQACUIDF”](#) on page 145.
3. Inform your users how to specify a language other than the one selected in step “2” on page 90. If your users need to start z/OS Debugger in a language other than the default, they need to add the NATLANG(*xxx*) parameter to the EQASTART command.

DD concatenation	Data set names
SYSEXEC or SYSPROC	hlq.SEQAEXEC
ISPMLIB	hlq.SEQAMENU and hlq.SIPVMENU
ISPLLIB	hlq.SEQAMOD and hlq.SIPVMODA
ISPPLIB	hlq.SEQAPENU and hlq.SIPVPENU
ISPSLIB	hlq.SEQASENU
ISPTLIB	hlq.SEQATLIB and hlq.SIPVTENU

⁸ USERMOD EQAUMOD2 is provided for updating EQASTART. See "SMP/E USERMODs" in the *IBM z/OS Debugger Customization Guide* for an SMP/E USERMOD for this customization.

Table 17. For uppercase English, data sets that need to be included or copied into the specified DD concatenations

DD concatenation	Data set names
SYSEXEC or SYSPROC	hlq.SEQAEXEC
ISPMLIB	hlq.SEQAMENP and hlq.SIPVMENU
ISPLLIB	hlq.SEQAMOD and hlq.SIPVMODA
ISPPLIB	hlq.SEQAPENP and hlq.SIPVPENU
ISPSLIB	hlq.SEQASENP
ISPTLIB	hlq.SEQATLIB and hlq.SIPVTENU

Note: ADFz Common Components does not have an upper English set of ISPF data sets.

Table 18. For Japanese, data sets that need to be included or copied into the specified DD concatenations

DD concatenation	Data set names
SYSEXEC or SYSPROC	hlq.SEQAEXEC
ISPMLIB	hlq.SEQAMJPN and hlq.SIPVMJPN
ISPLLIB	hlq.SEQAMOD and hlq.SIPVMODA
ISPPLIB	hlq.SEQAPJPN and hlq.SIPVPJPN
ISPSLIB	hlq.SEQASJPN
ISPTLIB	hlq.SEQATLIB and hlq.SIPVTJPN

Table 19. For Korean, data sets that need to be included or copied into the specified DD concatenations

DD concatenation	Data set names
SYSEXEC or SYSPROC	hlq.SEQAEXEC
ISPMLIB	hlq.SEQAMKOR and hlq.SIPVMKOR
ISPLLIB	hlq.SEQAMOD and hlq.SIPVMODA
ISPPLIB	hlq.SEQAPKOR and hlq.SIPVPKOR
ISPSLIB	hlq.SEQASKOR
ISPTLIB	hlq.SEQATLIB and hlq.SIPVTKOR

Customizing the data set names in EQASTART

You must modify member EQASTART of the hlq.SEQAEXEC data set to specify the data set names that you chose at installation time. Edit the EQASTART⁹ member and follow the directions in the member's prologue for site customization of data set names.

⁹ USERMOD EQAUMOD2 is provided for updating EQASTART. See "SMP/E USERMODs" in the *IBM z/OS Debugger Customization Guide* for an SMP/E USERMOD for this customization.

Adding IBM z/OS Debugger Utilities to the ISPF menu

To add IBM z/OS Debugger Utilities to an ISPF panel, add code that calls EQASTART to an existing panel. For example, to add IBM z/OS Debugger Utilities to the ISPF Primary Option Menu panel (ISR@PRIM), insert the additional lines (**←New**) as shown below:

```
...
)BODY CMD(ZCMD)
...
9 IBM Products IBM program development products
10 SCLM SW Configuration Library Manager
11 Workplace ISPF Object/Action Workplace
F File Manager File Manager for z/OS
D z/OS Debugger JCL
Wizard - z/OS Debugger JCL
Wizard Utility functions ←New
...
)PROC
...
&ZSEL; = TRANS( TRUNC (&ZCMD;,'. '))
...
9, 'PANEL(ISRDIIS) ADDPOP '
10, 'PGM(ISRSCLM) SCRNAME(SCLM) NOCHECK '
11, 'PGM(ISRUDA) PARM(ISRWORK) SCRNAME(WORK) '
F, 'PANEL(FMNSTASK) SCRNAME(FILEMGR) NEWAPPL(FMN) ' /* File Manager */
D, 'CMD(EXEC 'h1q.SEQAEEXEC(EQASTART)')' /* z/OS Debugger JCL
Wizard Utilities */ ←1
...
```

If you copied IBM z/OS Debugger Utilities to system data sets or concatenated them to existing DD names (as described in [Method 2](#) in “Choosing a method to start IBM z/OS Debugger Utilities” on page 90), then change line **1** to the following:

```
          D, 'CMD(%EQASTART)' /* z/OS Debugger JCL
Wizard Utilities */
```

For more information about configuring your ISPF Primary Option Menu panel, see *z/OS ISPF Planning and Customizing*.

Customizing z/OS Debugger Setup Utility

z/OS Debugger Setup Utility provides a command called COPY, which copies a JCL stream into a setup file. The EQAZPROC member of the *h1q.SEQATLIB* data set includes a list of JCL procedure libraries that z/OS Debugger Setup Utility uses as a source for the COPY command. You can add your own procedure libraries to the list by editing EQAZPROC and adding the procedure library names, one name per line and without trailing commas, beginning on column 1. The order in which you list procedure libraries in EQAZPROC must match the order in which you list procedure libraries in the PROCLIB concatenation.

For example, to add the LOCAL.PROCLIB procedure library name, do the following steps:

1. Edit the EQAZPROC¹⁰ member of the *h1q.SEQATLIB* data set.
2. Add the LOCAL.PROCLIB procedure library name. The result looks like the following:

```
LOCAL.PROCLIB
SYS1.PROCLIB
```

3. Save and close the file.

Customizing for JCL for Batch Debugging utility

The JCL for Batch Debugging utility helps your users prepare JCL and start a debug session. You can supply your users with a number of default values.

¹⁰ USERMOD EQAUMOD8 is provided for updating EQAZPROC. See "SMP/E USERMODS" in the *IBM z/OS Debugger Customization Guide* for an SMP/E USERMOD for this customization.

To set the defaults, do the following steps:

1. Edit the EQAZDFLT¹¹ member of the *hlq*.SEQATLIB data set.
2. Modify the parameter values to match what you use at your site.
3. Add parameters required by your site. You can add parameters by doing one of the following alternatives:
 - Use the INCLUDE *'any.data.set.name'*; statement to include statements from a data set that you created.
 - Use the INCLUDE *membername*; statement to include parameters from other members in the data set *hlq*.SEQATLIB.

See the EQAZDSYS member of the *hlq*.SEQATLIB data set for the complete list of parameters and the syntax convention for these parameters.

If your users use terminals that cannot display mixed-case English text, enter all parameters in uppercase English.

Parameters you can set

The first 3 characters of each parameter are "yb1". The last five characters correspond to the parameter:

yb1dtmod

z/OS Debugger load module data set (SEQAMOD).

yb1dtflg

Flag to include z/OS Debugger load module data set in STEPLIB. Y for Yes, N for No.

If it is No, the installer must ensure that SEQAMOD can be found in the load module search path.

yb1dtdev

Debug session type: MFI, TIM, or GUI.

MFI

dedicated terminal identified by network and LU names.

TIM

terminal identified by user id.

GUI

Remote debugger identified by IP address.

yb1dtmtd

z/OS Debugger invocation method: C, E or A.

C

CEEOPPTS DD statement. This requires z/OS Version 1.7 or later.

E

User exit module EQAD3CXT in Language Environment CEEBINIT module. For instructions on how to implement this method, see Chapter 8, "[Specifying the TEST runtime options through the Language Environment user exit,](#)" on page 81.

A

User exit module EQAD3CXT in application module.

yb1dtprf

Data set that contains a z/OS Debugger preferences file.

yb1dtcmd

Data set that contains a z/OS Debugger commands file.

¹¹ USERMOD EQAUMOD5 is provided for updating EQAZDFLT. See "SMP/E USERMODS" in the *IBM z/OS Debugger Customization Guide* for an SMP/E USERMOD for this customization.

yb1dtbin

The name of the Language Environment SCEERUN(CEEBINIT) load module data set that contains the z/OS Debugger user exit module EQAD3CXT. To make sure you provide the correct name, see [Chapter 8, “Specifying the TEST runtime options through the Language Environment user exit,” on page 81.](#)

yb1dtnmp

Naming pattern that identifies the z/OS Debugger user's data set which contains the TEST runtime options and pattern matching information. The naming pattern must be the same as the one coded in the z/OS Debugger user exit module EQAD3CXT. To make sure you provide the correct naming pattern, see [Chapter 8, “Specifying the TEST runtime options through the Language Environment user exit,” on page 81.](#)

yb1dtdfl

Debug information file. It contains a list of data sets of debug information, source, and listing files.

Customizing JCL for Batch Debugging for multiple systems

You can customize JCL for Batch Debugging utility for multiple systems by doing one of the following alternatives:

- Modify EQASTART¹² to use a fully qualified data set name or member name other than EQAZDFLT to start IBM z/OS Debugger Utilities.
- Instruct your users to enter one of the following commands, depending on the customization they want to use:
 - EXEC 'hlq.SEQAEXEC(EQASTART)' 'PUMEMBER(''data.set.name'')
 - EXEC 'hlq.SEQAEXEC(EQASTART)' 'PUMEMBER(membername)'

Customizing for Other IBM Application Delivery Foundation for z/OS tools

Other IBM Application Delivery Foundation for z/OS tools allows your users to access other Application Delivery Foundation for z/OS tools. You can supply your users with parameter values needed for accessing the tools.

To give users access to the proper tools:

1. Edit the EQAZDFLT¹³ member of the hlq.SEQATLIB data set.
2. Modify the data set names to match what you use at your site.
3. Add parameters required by your site. You can add parameters by doing one of the following alternatives:
 - Use the INCLUDE 'any.data.set.name'; statement to include statements from a data set that you created.
 - Use the INCLUDE membername; statement to include parameters from other members in the data set hlq.SEQATLIB.

See the EQAZDSYS and EQAZDUSR members of the hlq.SEQATLIB data set for the complete list of parameters and the syntax convention for these parameters.

If your users use terminals that cannot display mixed-case English text, enter all parameters in uppercase English.

¹² USERMOD EQAUMOD2 is provided for updating EQASTART. See "SMP/E USERMODs" in the *IBM z/OS Debugger Customization Guide* for an SMP/E USERMOD for this customization.

¹³ USERMOD EQAUMOD5 is provided for updating EQAZDFLT. See "SMP/E USERMODs" in the *IBM z/OS Debugger Customization Guide* for an SMP/E USERMOD for this customization.

Parameters you can set

The first two characters of each parameter are always 'pt'. The third character corresponds to the tool:

1

IBM File Manager parameters

The last five characters correspond to the parameter:

flg1

Base function availability flag: Yes or No.

flg2

Db2 function availability flag: Yes or No.

flg3

IMS function availability flag: Yes or No.

tfl

Title for the tool.

elib

ISPF EXEC library data set.

mllb

ISPF message library data set.

pllb

ISPF panel library data set.

slib

ISPF skeleton library data set.

tlb

ISPF table library data set.

pnl1

ISPF panel name for the base function.

pnl2

ISPF panel name for the Db2 function.

pnl3

ISPF panel name for the IMS function.

Customizing Other IBM Application Delivery Foundation for z/OS tools for multiple systems

You can customize Other IBM Application Delivery Foundation for z/OS tools for multiple systems by doing one of the following alternatives:

- Modify EQASTART¹⁴ to use a fully qualified data set name or member name other than EQAZDFLT to start IBM z/OS Debugger Utilities.
- Instruct your users to enter one of the following commands, depending on the customization they want to use:

```
- EXEC 'hlq.SEQAEXEC(EQASTART)' 'PUMEMBER(''data.set.name'')
```

```
- EXEC 'hlq.SEQAEXEC(EQASTART)' 'PUMEMBER(membername)'
```

¹⁴ USERMOD EQAUMOD2 is provided for updating EQASTART. See "SMP/E USERMODs" in the *IBM z/OS Debugger Customization Guide* for an SMP/E USERMOD for this customization.

Customizing Program Preparation

Program Preparation helps your users access the proper compilers and development utilities that are installed at your site. You can supply your users with default values for data set naming patterns, data set allocation parameters, and compiler and utility option strings.

To give users access to the proper compilers and development utilities, do the following steps:

1. Edit the EQAZDFLT¹⁵ member of the `hlq.SEQATLIB` data set.
2. Modify the data set names to match what you use at your site.
3. Add parameters required by your site. You can add parameters by doing one of the following alternatives:
 - Use the `INCLUDE 'any.data.set.name'` ; statement to include statements from a data set that you created.
 - Use the `INCLUDE membername` ; statement to include parameters from other members in the data set `hlq.SEQATLIB`.

See the EQAZDSYS and EQAZDUSR members of the `hlq.SEQATLIB` data set for the complete list of parameters and the syntax convention for these parameters.

If your users use terminals that cannot display mixed-case English text, you must enter all parameters in uppercase English.

If your site uses CCCA and requires that you use the VOLUMES parameter when you define private data sets (for example, a cluster is not managed by SMS), you must include the VOLUMES parameter when you define private data sets. Modify the following variables to include the VOLUMES parameter:

- `yccctla1`
- `ycclcpa1`
- `yccchga1`
- `yccwrka1`
- `ycctkna1`

The following example illustrates how the variable `yccctla1` is modified to include the parameter `VOLUMES(SYS166)`:

```
yccctla1 =          ! CONTROL FILE KSDS
                   RECORDS(10000 1000)
                   FREESPACE(30 30)
                   INDEXED
                   SPEED
                   CISZ(4096)
                   UNIQUE
                   KEYS(15 0)
                   VOLUMES(SYS166)
                   RECORDSIZE(188 188);
```

Parameters you can set

The first two characters of each parameter are always 'yc'. The third character corresponds to the compiler or development utility parameters:

- 1** COBOL compiler parameters
- 3** PL/I compiler parameters

¹⁵ USERMOD EQAUMOD5 is provided for updating EQAZDFLT. See "SMP/E USERMODS" in the *IBM z/OS Debugger Customization Guide* for an SMP/E USERMOD for this customization.

4

C and C++ compiler parameters

5

Assembler parameters

6

Enterprise COBOL for z/OS Version 5 compiler parameters

L

Link Edit parameters

c

CCCA parameters

F

Fault Analyzer parameters

G

Fault Analyzer listing create parameters

Db2 and CICS parameters

The Db2 precompiler and CICS translator are listed by the compiler you use. You can specify a different Db2 precompiler or CICS translator for each compiler.

The last five characters correspond to the parameter:

ciclb

LINKLIST or load module data set name for CICS translator.

cicmd

Load module name for CICS translator.

cicps

CICS translator options.

clib

LINKLIST or load module data set name for the compiler.

cmod

Load module name for the compiler or utility.

cobv

Enterprise COBOL for z/OS Version 5 or later.

ctovr

TEST compiler option override flag. Use this flag to allow or disallow the TEST or DEBUG compiler option specified in the ctst, ctst1, ctst2, ctst3, ctst4, or ctst5 parameters to be overridden by the settings in the user profile. This parameter is valid for the COBOL compiler, PL/I compiler, and C and C++ compiler.

ctst

Use TEST, NOTEST, DEBUG, or NODEBUG as the main compiler debugging option. This parameter is valid for the COBOL compiler, PL/I compiler, and C and C++ compiler.

ctst1, ctst2, ctst3, ctst4, ctst5

TEST or DEBUG suboptions. These parameters are valid for the COBOL compiler, PL/I compiler, and C and C++ compiler.

cttl

Title for the compiler.

db2lb

LINKLIST or load module data set name for the Db2 precompiler.

db2md

Load module name for Db2 precompiler.

db2ps

Db2 precompiler options.

flg

Enable or disable the compiler or development utility.

lsta1

Parameters of the TSO ALLOCATE command to use when data sets for compiler listings are allocated.

lstat

Data set type for the compiler listing. The type can be one of these values: PDSE, PDS, or SEQ.

lstxx

Pattern to use to create a name for the compiler listing data set. The name is created by using the characters in the pattern. The special characters, which start with a slash (/), are replaced by the following values:

/1, /2, ..., /n

The nth qualifier of the fully qualified data set name that was used as input to the compiler.

/B

The second to (n-1) qualifier of the fully qualified data set name that was used as input to the compiler.

/L

The right-most qualifier of the fully qualified data set name that was used as input to the compiler.

/M

The member name of the data set name that was used as input to the compiler.

/U

Current TSO user ID.

/P

Current TSO profile prefix.

sds1

Shared data set prefix for CCCA.

svs1

Shared VSAM data set prefix for CCCA.

tmpa1

Parameters of the TSO ALLOCATE command to use when temporary data sets are allocated.

Customizing Program Preparation for multiple systems

You can customize Program Preparation for multiple systems by doing one of the following alternatives:

- Modify EQASTART¹⁶ to use a fully qualified data set name or member name other than EQAZDFLT to start IBM z/OS Debugger Utilities.
- Instruct your users to enter one of the following commands, depending on the customization they want to use:

```
- EXEC 'hlq.SEQAEXEC(EQASTART)' 'PUMEMBER('any.data.set.name')'
```

```
- EXEC 'hlq.SEQAEXEC(EQASTART)' 'PUMEMBER(membername)'
```

Configuring for IMSplex users

To determine if you need to do the steps described in this topic, read "Preparing IMS programs" in the *IBM z/OS Debugger User's Guide*. If your users use the **IMS TM Setup - Manage LE Runtime Options** function in z/OS Debugger Utilities, you must do the following tasks:

1. Install and configure IMS Version 8 or later as an IMSplex. See *IMS Version 8: Administration Guide: System* for information about configuring an IMSplex.

¹⁶ USERMOD EQAUMOD2 is provided for updating EQASTART. See "SMP/E USERMODs" in the *IBM z/OS Debugger Customization Guide* for an SMP/E USERMOD for this customization.

2. Include the IMS RESLIB load library, which is located in the *hlq*.SDFSRESL data set, in the standard search path for load modules used by your users. *hlq* is the high level qualifier of IMS installed on your system.

If you do not include the IMS load library in the search path, your users will see one or both of the following messages and they will not be able to use the **IMS TM Setup - Manage LE Runtime Options** function in IBM z/OS Debugger Utilities:

- EQAZ60E REXX IMS SPOC environment is not available. Return Code = nnn
- IKJ56500I COMMAND CSLULXSB NOT FOUND

Customizing z/OS Debugger User Exit Data Set

The z/OS Debugger User Exit Data Set utility creates a user exit data set that is used by the z/OS Debugger Language Environment user exit to start a debug session. You can set the default value of the data set naming pattern for the users by taking the following steps:

1. Review the parameter described in [Table 20 on page 99](#). Verify that you have all the information to specify the value for the parameter. See the EQAZDSYS member of the *hlq*.SEQATLIB data set for the parameter and the syntax convention.
2. Edit the EQAZDSYS¹⁷ member of the *hlq*.SEQATLIB data set. Modify the parameter required by your site. You can add parameters by doing one of the following alternatives:
 - Use the INCLUDE *'any.data.set.name'*; statement to include statements from a data set that you created.
 - Use the INCLUDE *membername*; statement to include parameters from other members in the *hlq*.SEQATLIB data set.

If your application programmers use terminals that cannot display text in mixed-case English, enter parameters and their values in uppercase English.

See [Chapter 8, "Specifying the TEST runtime options through the Language Environment user exit," on page 81](#) for how the user exit data set is used.

Name of parameter	Description
uepnmp	<p>The naming pattern of the user exit data set.</p> <p>The utility builds a data set name by using the naming pattern that is used when the option is selected for the first time. The data set name and modification (if user modifies it) are consistent across the IBM z/OS Debugger Utilities sessions.</p> <p>The following list describes the rules of using the token:</p> <ul style="list-style-type: none"> • The &USERID token is replaced with the value from the SYSPREF or SYSUID system variable. • The &PGMNAME token is not supported. • If the parameter does not exist, the default naming pattern is used: <pre>&USERID.DBGTOOL.EQUAOPTS</pre>

¹⁷ USERMOD EQAUMOD6 is provided for updating EQAZDSYS. See "SMP/E USERMODs" in the *IBM z/OS Debugger Customization Guide* for an SMP/E USERMOD for this customization.

Customizing IMS BTS Debugging

The IMS BTS Debugging utility of IBM z/OS Debugger Utilities helps your users prepare a BTS JCL and start a debug session in the foreground or in batch. You can supply your users with default values for the TEST runtime option and data set names for the z/OS Debugger load module, user exit module, debug information files, IMS subsystem IDs and base JCLs.

To set the defaults, do the following steps:

1. Review the parameters described in [Table 21 on page 100](#). Verify that you have all the information you need to specify values for each parameter. You can also view a complete list of parameters and the syntax convention for these parameters in the EQAZDSYS member of the *hlq*.SEQATLIB data set.
2. Edit the EQAZDSYS¹⁸ member of the *hlq*.SEQATLIB data set. Modify the parameters required by your site. You can add parameters by doing one of the following alternatives:
 - Use the INCLUDE 'any.data.set.name'; statement to include statements from a data set that you created.
 - Use the INCLUDE membername; statement to include parameters from other members in the data set *hlq*.SEQATLIB.

If your application programmers use terminals that cannot display text in mixed-case English, enter all parameters and their values in uppercase English.

Name of parameter	Description
yb2dtmod	The name of the data set that contains the z/OS Debugger load modules, SEQAMOD.
yb2dtce1	The name of the data set that contains Language Environment runtime library, SCEERUN1.
yb2dtce2	The name of the data set that contains Language Environment runtime library, SCEERUN2.
yb2dtbin	The name of the data set that contains the CEEBINIT load module.
yb2dtnmp	The naming pattern you stored in EQAD3CXT when you completed the instructions in “Modifying the naming pattern” on page 82. If you modify the naming pattern stored in EQAD3CXT, you must modify this parameter to match.
yb2dtdev	<p>The interface type that application programmers should use to debug IMS BTS programs. You can specify one of the following values:</p> <p>MFI Interact with z/OS Debugger in full-screen mode or full-screen mode using a dedicated terminal without Terminal Interface Manager (TIM). If application programmers are using full-screen mode using a dedicated terminal without Terminal Interface Manager, they identify the terminal by network and LU names, as described in Appendix B, “Enabling debugging in full-screen mode using a dedicated terminal,” on page 191.</p> <p>TIM Interact with z/OS Debugger in full-screen mode or full-screen mode using the Terminal Interface Manager (TIM). The application programmer identifies the terminal by user ID, as described in “How users start a full-screen mode debug session with the Terminal Interface Manager” on page 17. Make sure you complete the instructions in “Enabling full-screen mode using the Terminal Interface Manager” on page 19.</p> <p>GUI Interact with z/OS Debugger in remote debug mode, where the application programmer identifies the remote debugger by IP address.</p>

¹⁸ USERMOD EQAUMOD6 is provided for updating EQAZDSYS. See [“SMP/E USERMODs”](#) for an SMP/E USERMOD for this customization.

Table 21. Parameters you can define for the IMS BTS Debugging option of IBM z/OS Debugger Utilities. (continued)

Name of parameter	Description
yb2dtmtd	<p>The method that application programmers should use to start z/OS Debugger. You can specify one of the following values:</p> <p>C The application programmer specifies the CEEOPTS DD statement. You must run z/OS, Version 1.7, or later to use this option.</p> <p>E The application programmer specifies the EQAD3CXT user exit.</p>
yb2dtpfr	The name of the data set that contains the preferences file. If your site does not use a preferences files, you can leave this field blank.
yb2dtcmd	The name of the data set that contains the commands file. If your site does not use a commands files, you can leave this field blank.
yb2dtufl	The name of a data set containing a list of data set names to be allocated by EQADEBUG DD statements.
yb2dtued	The name of a data set containing the EQAUEDAT load module.
yb2imsnm	The number of IMS subsystems that the application programmers can use to run or debug IMS applications. The maximum value is 12.
yb2iidn	For each IMS subsystem, create a copy of this parameter and assign <i>n</i> a unique number between 1 and 12. For example, if your site has two IMS subsystems, you create yb2iid1 and yb2iid2 and assign each parameter a unique IMS system name.
yb2bmpn	For each IMS subsystem, create a copy of this parameter and assign <i>n</i> a unique number between 1 and 12 and specify the member name of a JCL that your site uses as a base or template JCL for batch message processing (BMP) programs. Edit the EQABMPSM ¹⁹ member of <i>h1q</i> . SEQATLIB, then copy it to a new name (for example, BMPJCL1). For example, if your site has two IMS subsystems, you create yb2bmp1 and yb2bmp2 and assign each parameter the member name.
yb2dbbn	For each IMS subsystem, create a copy of this parameter and assign <i>n</i> a unique number between 1 and 12 and the member name of a JCL that your site uses as a base or template JCL for Data Language/I (DL/I) programs. Edit the EQADBBSM ²⁰ member of <i>h1q</i> . SEQATLIB, then copy it to a new name (for example, DBBJCL1). For example, if your site has two IMS subsystems, you create yb2dbb1 and yb2dbb2 and assign each parameter the member name.
yb2dlin	For each IMS subsystem, create a copy of this parameter and assign <i>n</i> a unique number between 1 and 12 and the member name of a JCL that your site uses as a base or template JCL for Data Language/I (DL/I) programs. Edit the EQADLISM ²¹ member of <i>h1q</i> . SEQATLIB, then copy it to a new name (for example, DLIJCL1). For example, if your site has two IMS subsystems, you create yb2d1i1 and yb2d1i2 and assign each parameter the member name.

¹⁹ USERMOD EQAUMODG is provided for updating EQABMPSM. See "[SMP/E USERMODs](#)" for an SMP/E USERMOD for this customization.

²⁰ USERMOD EQAUMODH is provided for updating EQADBBSM. See "[SMP/E USERMODs](#)" for an SMP/E USERMOD for this customization.

²¹ USERMOD EQAUMODI is provided for updating EQADLISM. See "[SMP/E USERMODs](#)" for an SMP/E USERMOD for this customization.

Customizing Delay Debug Profile

The Delay Debug Profile utility creates a delay debug profile data set that is used by the z/OS Debugger delay debug pattern matching to start a debug session. You can set the default value of the data set naming pattern for the users by taking the following steps:

1. Review the parameter described in [Table 22 on page 102](#). Verify that you have all the information to specify the value for the parameter. See the EQAZDSYS member of the *hlq*.SEQATLIB data set for the parameter and the syntax convention.
2. Edit the EQAZDSYS²² member of the *hlq*.SEQATLIB data set. Modify the parameter required by your site. You can add parameters by doing one of the following alternatives:
 - Use the INCLUDE *'any.data.set.name'* ; statement to include statements from a data set that you created.
 - Use the INCLUDE *membername* ; statement to include parameters from other members in the *hlq*.SEQATLIB data set.

If your application programmers use terminals that cannot display text in mixed-case English, enter parameters and their values in uppercase English.

See "Using delay debug mode to delay starting of a debug session" in the *IBM z/OS Debugger User's Guide* for how to use the delay debug function.

Name of parameter	Description
ddpnmp	<p>The naming pattern of the delay debug profile data set.</p> <p>The utility builds a data set name by using the naming pattern that is used when the option is selected for the first time. The data set name and modification (if user modifies it) are consistent across IBM z/OS Debugger Utilities sessions.</p> <p>The following list describes the rules of using the token:</p> <ul style="list-style-type: none">• The &USERID token is replaced with the value from the SYSPREF or SYSUID system variable.• The &PGMNAME token is not supported.• If the parameter does not exist, the default naming pattern is used: <pre>&USERID.DLAYDBG.EQAUOPTS</pre>

Customizing IMS Transaction and User ID Cross Reference Table

The IMS transaction and user ID cross reference table contains the cross reference information between IMS transactions and user IDs. A web or MQ gateway initiated IMS transaction is run with a generic ID. When a user wants to debug such a transaction, he needs to add an entry in the cross reference table that contains the transaction name and his user ID. z/OS Debugger then uses the table to find the user ID of the user who wants to debug the transaction and to construct the name of the user's debug profile data set. You can set the values of parameters for the users by taking the following steps:

²² USERMOD EQAUMOD6 is provided for updating EQAZDSYS. See "SMP/E USERMODs" in the *IBM z/OS Debugger Customization Guide* for an SMP/E USERMOD for this customization.

1. Review the parameters described in [Table 23 on page 103](#). Verify that you have all the information to specify the value for the parameters. See the EQAZDSYS member of the *hlq.SEQATLIB* data set for the parameter and the syntax convention.
2. Edit the EQAZDSYS²³ member of the *hlq.SEQATLIB* data set. Modify the parameters that are required by your site. You can add parameters by doing one of the following alternatives:
 - Use the INCLUDE *'any.data.set.name'* ; statement to include statements from a data set that you created.
 - Use the INCLUDE *membername* ; statement to include parameters from other members in the *hlq.SEQATLIB* data set.

If your application programmers use terminals that cannot display text in mixed-case English, enter parameters and their values in uppercase English.

See [Chapter 8, “Specifying the TEST runtime options through the Language Environment user exit,” on page 81](#) for information on how to set this data set name in the exit.

See [“DLAYDBGXRF” on page 165](#) for information on how to specify this data set name for IMS users who are using delay debug mode.

<i>Table 23. Parameters for the IMS Transaction and User ID Cross Reference Table of IBM z/OS Debugger Utilities</i>	
Name of parameter	Description
TUXRFDSN	The data set name for the cross reference table in ISPF format. No default is provided. The data set is an MVS sequential data set with FB LRECL 80. It must be pre-allocated and accessible to the users using the utility.
TUGNRCID	One or more generic IDs separated by a blank. No default is provided. A generic ID is an ID that is used to run IMS transactions started using the MQ or web gateway. z/OS Debugger uses the cross reference table to identify the user who wants to debug the transaction.
TUACTPRD	Number of days that a cross reference table entry is retained from the last update date. The default is 30 days.
TUGIDMAX	Maximum number of generic IDs. The default value is 20.
TUENTMAX	Maximum number of cross reference table entries. The default value is 200.

Customizing Non-CICS Debug Session Start and Stop Message Viewer

The Non-CICS Debug Session Start and Stop Messages Viewer utility allows users to browse debug session start and stop messages. It helps you track debug sessions. You can set the value of parameters for the users by taking the following steps:

1. Review the parameters that are described in [Table 24 on page 104](#). Verify that you have all the information to specify the value for the parameters. See the EQAZDSYS member of the *hlq.SEQATLIB* data set for the parameter and the syntax convention.
2. Edit the EQAZDSYS²⁴ member of the *hlq.SEQATLIB* data set. Modify the parameters that are required by your site. You can add parameters by doing one of the following alternatives:

²³ USERMOD EQAUMOD6 is provided for updating EQAZDSYS. See "SMP/E USERMODs" in the *IBM z/OS Debugger Customization Guide* for an SMP/E USERMOD for this customization.

²⁴ USERMOD EQAUMOD6 is provided for updating EQAZDSYS. See "SMP/E USERMODs" in the *IBM z/OS Debugger Customization Guide* for an SMP/E USERMOD for this customization.

- Use the INCLUDE 'any.data.set.name'; statement to include statements from a data set that you created.
- Use the INCLUDE membername; statement to include parameters from other members in the hlq.SEQATLIB data set.

If your application programmers use terminals that cannot display text in mixed-case English, enter parameters and their values in uppercase English.

See “STARTSTOPMSGDSN” on page 181 for information on how to specify this data set name for debugger sessions.

Name of parameter	Description
SSMSGDSN	The data set name for the debug session start and stop messages. No default is provided. The data set is an MVS sequential data set with FB LRECL 80. It must be pre-allocated and accessible to the users using the utility.

Customizing z/OS Debugger Code Coverage

z/OS Debugger Code Coverage provides the following functions:

1. Observation viewer - browse code coverage observation data set.
2. z/OS Debugger options - create or modify the z/OS Debugger code coverage options data set.
3. Observation selection criteria - create or modify the observation selection criteria and source markers data set.
4. Observation extraction - extract code coverage observations by using selection criteria.
5. Report generation - create reports.

You can set the default values for the data set naming pattern for the first three functions for the users by taking the following steps:

1. Review the parameter described in the following table. Verify that you have all the information to specify the value for the parameter. See the EQAZDSYS member of the hlq.SEQATLIB data set for the parameter and the syntax convention.
2. Edit the EQAZDSYS²⁵ member of the hlq.SEQATLIB data set. Modify the parameter required by your site. You can add parameters by doing one of the following alternatives:
 - Use the INCLUDE 'any.data.set.name'; statement to include statements from a data set that you created.
 - Use the INCLUDE membername; statement to include parameters from other members in the hlq.SEQATLIB data set.

If your application programmers use terminals that cannot display text in mixed-case English, enter parameters and their values in uppercase English.

See "z/OS Debugger Code Coverage" in the IBM z/OS Debugger User's Guide for how to use the z/OS Debugger code coverage function.

²⁵ USERMOD EQAUMOD6 is provided for updating EQAZDSYS. See "SMP/E USERMODs" in the IBM z/OS Debugger Customization Guide for an SMP/E USERMOD for this customization.

Table 25. Parameters for z/OS Debugger Code Coverage

Name of parameter	Description
cconmp	<p>The naming pattern of the code coverage options data set.</p> <p>The utility builds a data set name by using the naming pattern that is used when the option is selected for the first time. The data set name and modification (if user modifies it) are persistent across IBM z/OS Debugger Utilities sessions.</p> <p>The following list describes the rules of using the token:</p> <ul style="list-style-type: none"> • The &USERID token is replaced with the value from the SYSPREF or SYSUID system variable. • If the parameter does not exist, the default naming pattern is used: &USERID . DBGTOOL . CCPRGSEL.
ccsnmp	<p>The naming pattern of the code coverage observation selection criteria data set.</p> <p>The utility builds a data set name by using the naming pattern that is used when the option is selected for the first time. The data set name and modification (if user modifies it) are persistent across IBM z/OS Debugger Utilities sessions.</p> <p>The following list describes the rules of using the token:</p> <ul style="list-style-type: none"> • The &USERID token is replaced with the value from the SYSPREF or SYSUID system variable. • If the parameter does not exist, the default naming pattern is used: &USERID . DBGTOOL . CCOBSSEL.
ccxnmp	<p>The naming pattern of the code coverage observations data set.</p> <p>The utility builds a data set name by using the naming pattern that is used when the option is selected for the first time. The data set name and modification (if user modifies it) are persistent across IBM z/OS Debugger Utilities sessions.</p> <p>The following list describes the rules of using the token:</p> <ul style="list-style-type: none"> • The &USERID token is replaced with the value from the SYSPREF or SYSUID system variable. • If the parameter does not exist, the default naming pattern is used: &USERID . DBGTOOL . CCOOUTPUT.

Installing and customizing z/OS Debugger JCL Wizard

The z/OS Debugger JCL Wizard is an ISPF edit macro, **EQAJCL**, that can be used by a user to modify a JCL or procedure member to create statements that will invoke z/OS Debugger in various environments.

Prerequisites

The z/OS Debugger library *hlq.SEQAMOD* is assumed to be in the z/OS link list where the batch job will run. If it is not in the link list, do one of the following actions:

- Add the library *hlq.SEQAMOD* to the link list of z/OS LPARs where the modified JCL or procedure will be run.
- Add the library *hlq.SEQAMOD* to the //STEPLIB or //JOB LIB statement of the step or job that will be debugged.

Installation of the EQAJCL ISPF macro and its ISPF panels

The z/OS Debugger JCL Wizard contains an ISPF edit macro and a set of ISPF panels.

Use one of the following methods to install the z/OS Debugger JCL Wizard :

- Installation to libraries allocated to the TSO Logon procedure.

Use one of these two methods:

- Use [Method 2](#) in “[Choosing a method to start IBM z/OS Debugger Utilities](#)” on page 90.
- Use a subset of [Method 2](#) in “[Choosing a method to start IBM z/OS Debugger Utilities](#)” on page 90 where you only include or copy *hlq*.SEQAEXEC into the SYSPROC or SYSEXEC DD.

- Installation by using a local REXX exec to point to the z/OS Debugger libraries.

Select a command name that you do not currently use (for example, DEBUG), and install a REXX exec by that name into an existing data set in your TSO Logon procedure's SYSEXEC or SYSPROC DDs. The REXX exec should look like this (with *hlq* being changed to the high level qualifier that you use for the z/OS Debugger libraries):

```
/* This REXX exec will invoke the z/OS Debugger EQAJCL ISPF macro */
"EXEC 'hlq.SEQAEXEC(EQAJCL)'"
EXIT
```

Customizing the data set names and other values in EQAJCL

You must modify member **EQAJCL** of the *hlq*.SEQAEXEC data set to specify the data set names that you chose at installation time. Edit the **EQAJCL**²⁶ member and follow the directions in the member's prologue for site customization of data set names.

Enabling Code Coverage

z/OS Debugger Code Coverage measures test case code coverage in application programs that are written in COBOL, PL/I and C and compiled with certain compilers and compiler options. You must define the code coverage libraries *xxxx.xxxx.CCPRGSEL* and *xxxx.xxxx.CCOUTPUT* in the EQAOPTS member residing in *hlq*.SEQAMOD, or dynamically using an EQAOPTS DD statement. If the variable `CODE_COVERAGE_SETUP` is set to **YES**, the z/OS Debugger JCL Wizard automatically adds these statements to your JCL. Therefore, system programmers do not need to change the EQAOPTS member in *hlq*.SEQAMOD.

If the variable `CODE_COVERAGE_SETUP` is set to **YES**, the following statements are generated:

```
//EQAOPTS DD *
EQAXOPT CCOUTPUTDSN, '&&USERID.DBGTOOL.CCOUTPUT'
EQAXOPT CCOUTPUTDSNALLOC, 'MGMTCLAS(STANDARD)          +
        STORCLAS(DEFAULT) LRECL(255) BLKSIZE(0) RECFM(V,B) +
        DSORG(PS) SPACE(2,2) CYL'
EQAXOPT CCPRGSELECTDSN, '&&USERID.DBGTOOL.CCPRGSEL'
EQAXOPT END
```

For more information about the compilation requirements for Code Coverage, refer to the *IBM z/OS Debugger User's Guide*.

The z/OS Debugger JCL Wizard creates Code Coverage commands to run either with or without an interactive debug session.

²⁶ USERMOD EQAUMODL is provided for updating EQAJCL. See "SMP/E USERMODS" in the *IBM z/OS Debugger Customization Guide* for an SMP/E USERMOD for this customization.

Chapter 11. Preparing your environment to debug Db2 stored procedures

The Db2 administrator must define the address space where the stored procedure runs. This can be a Db2 address space or a workload management (WLM) address space. This address space is assigned a name which is used to define the stored procedure to Db2. In the JCL for the Db2 or WLM address space, verify that the following data sets are defined in the STEPLIB concatenation and have the appropriate RACF Read authorization for programs to access them:

- LOADLIB for the stored procedure
- SEQAMOD²⁷ for z/OS Debugger
- SCEERUN²⁸ for Language Environment

After updating the JCL, the Db2 administrator must refresh the Db2 or WLM address space so that these updates take effect.

Refer to the following topics for more information related to the material discussed in this topic.

Related references

DB2[®] UDB for z/OS Application Programming and SQL Guide

²⁷ Add `h1q.SEQAMOD` to STEPLIB only if it is not already in the system search path (for example, link list). If you create a custom EQAOPTS (as described in [Chapter 16, “EQAOPTS commands,”](#) on page 147) that is not stored in `h1q.SEQAMOD`, then place the data set containing it in STEPLIB (ahead of `h1q.SEQAMOD` if it is in STEPLIB). `h1q.SEQAMOD` must be placed before any other library in the STEPLIB that contains CEEVDBG for z/OS Debugger to get control of a debug session.

²⁸ Add `CEE.SCEERUN` to STEPLIB only if it is not already in the system search path (for example, link list). If you create a private copy of the z/OS Debugger Language Environment user exit for Db2 that is linked into CEEPIPI (as described in [Chapter 8, “Specifying the TEST runtime options through the Language Environment user exit,”](#) on page 81), then place the data set containing it in STEPLIB (ahead of `CEE.SCEERUN` if it is in STEPLIB).

Chapter 12. Adding support for debugging under CICS

To debug applications that run in CICS, z/OS Debugger requires the following:

- Language Environment. Refer to the Language Environment installation and customization information for more information.
- Do the steps described in this chapter.

To add z/OS Debugger support for CICS applications:

1. Verify that the current z/OS Debugger resources are defined in the CICS CSD and installed in the CICS region. The CICS definitions are in the EQACCSO and EQACDCT members of the *hlq*.SEQASAMP data set.

- a. If your site policy is to define the Transient Data queues by using DCT macro definitions, add the definitions in the EQACDCT member to your DCT and reassemble it.

If your site uses COBOL or PL/I separate debug files, follow the instructions in EQACDCT to define the appropriate queues to CICS.

- b. Add the z/OS Debugger definitions to the CICS CSD. The following two members are provided in the *hlq*.SEQASAMP data set:

- EQACCSO, which contains the resource definitions for the group EQA.
- EQAWCCSO, which contains JCL to apply the definitions which are in EQACCSO.

Review the instructions in both members and run the batch job to add the definitions to your CICS CSD.

2. Update the JCL that starts CICS:

- a. Update the DFHRPL concatenation in the CICS region startup JCL to include the following libraries:

Library	Description
<i>hlq</i> .SEQAMOD	z/OS Debugger library In the DFHRPL concatenation, <i>hlq</i> .SEQAMOD must be placed before any other library that also contains CEEVDBG for z/OS Debugger to get control of a debug session. Defining the <i>hlq</i> .SEQAMOD data set as a CICS LIBRARY resource is not supported. It must be included in the DFHRPL concatenation.
SCEECICS	z/OS Language Environment runtime library
SCEERUN	z/OS Language Environment runtime library
SCEERUN2	z/OS Language Environment runtime library Specify this library if it is required by your application.

Table 26. Libraries to be included in DFHRPL (continued)	
Library	Description
MIGLIB SIEAMIGE	z/OS system libraries These libraries are needed to debug routines compiled with Enterprise COBOL for z/OS 5 and 6.1 TEST, Enterprise COBOL for z/OS 6.2 (and later) TEST or TEST (NOSEPARATE), and Enterprise PL/I for z/OS 6.1 (and later) TEST (SOURCE).

- b. Remove any data sets from the concatenation that refer to old releases of z/OS Debugger.
 - c. Include EQA00DYN and EQA00HFS from the debugger's *hlq*.SEQAMOD data set in the STEPLIB concatenation by either of the following ways:
 - Use the Authorized Program Facility (APF) to authorize the *hlq*.SEQAMOD data set and add the data set to the STEPLIB concatenation.
 - Copy⁶ the EQA00DYN and EQA00HFS modules from the *hlq*.SEQAMOD data set to a library that is already in the STEPLIB concatenation.
 - Place *hlq*.SEQAMOD in the system link list and use the Authorized Program Facility (APF) to authorize it. For more information, see [Chapter 5, “Setting up the link list data set \(SEQAMOD\),” on page 15](#).
 - d. Ensure that the JCL does not include DD statements for CINSPIN, CINSPLS, CINSPOP, IBMDBGIN, or IGZDBGIN.
 - e. See [“Storing DTCN debug profiles in a VSAM file” on page 114](#) to determine if you want to store DTCN debugging profiles in a VSAM data set. If you do, follow the instructions in that topic to add the EQADPFMB DD statement that refers to the VSAM data set.
3. If your CICS region is started with the RENTPGM parameter set to PROTECT (the default), your security administrator needs to complete the steps in [“Using the Authorized Debug facility for protected programs” on page 11](#).
 4. For any terminal that z/OS Debugger uses to display a debugging session, do the following tasks:
 - Verify that the CICS TYPETERM definition specifies a minimum value of 4096 for the RECEIVESIZE attribute and sets the BUILDCHAIN attribute to YES.
 - Enable either color or highlighting. For best usability, enable both and the ability to query the screen size. To enable these three functions, verify that the CICS TYPETERM definition specifies EXTENDEDSDS. For more information, refer to the *CICS Transaction Server for z/OS Resource Definition Guide*.
 - Under CICS, z/OS Debugger can use a screen as large as 10922 characters (for example, 68x160 can be used, but not 69x160), and provides automatic switching from the application's screen size to the physical screen size. Larger screens can enhance user productivity. CICS selects the TYPETERM to use from the BIND information given to it from VTAM. Ask your systems programmer to ensure that VTAM passes the screen sizes through to CICS.
 5. Verify that users can run the CDT# transaction without receiving any errors.
If the CDT# transaction runs successfully, no messages are displayed. You might see X-SYSTEM after you press Enter. This disappears when the transaction finishes and the keyboard unlocks.
 6. If you are running your CICS programs in a multi-region CICS environment:
 - a. Define the DTCN transaction name the same across all local and remote systems. If the DTCN transaction name is changed, or if a DTCN transaction is duplicated and given a different name, change the name on all systems.

- b. If a debugging session might run in a region that is different from the one where DTCN was used to save the debugging profile, use the PLTPI program EQAOCPLT with the CICS start up parameter INITPARM=(EQAOCPLT='NWP').
- c. If you are using DTCN, ensure that the region shares the debug profile repository. See [“Sharing DTCN debug profile repository among CICS systems”](#) on page 114 for more information about defining the region that owns the debug profile repository. The most common multi-region debugging scenario is where the debug profile repository is shared and DTCN runs in the TOR while the application to be debugged is transaction routed to an AOR.

One of two methods must be used in this case to start the debugger's new program support in the AOR. Either use EQAOCPLT to enable this support when the region starts (see step [“10”](#) on page [111](#) for information about EQAOCPLT), or use the z/OS Debugger DTCP transaction to start or stop this support as needed. In the AOR, enter DTCPO on a clear CICS screen to activate this support and enter DTCPF to deactivate it. You can activate and deactivate this support multiple times.

- 7. If users need to debug Enterprise PL/I for z/OS, Version 3 Release 4 (or later) applications under CICS, apply the PTF for APAR PK03264. Users can begin a debug session by using DTCN at either of the following points:
 - The entry to programs invoked by EXEC CICS LINK or XCTL.
 - The entry to any program, even if it is a nested program within a composite load module, invoked as a static or dynamic CALL.
- 8. If you are planning to debug command-level assembler application programs that do not run under or use Language Environment services, activate the CICS non-Language Environment exits as described in [“Activating CICS non-Language Environment exits”](#) on page 113.
- 9. If your CICS region is started with the SEC parameter set to YES and the XCMD parameter is set to YES to activate command security, review the access settings for the following resources:

EXITPROGRAM

Do one of the following options:

- Verify that z/OS Debugger users have UPDATE authority to the EXITPROGRAM resource so that they can run EXEC CICS ENABLE PROGRAM EXIT, DISABLE PROGRAM EXIT, and EXTRACT EXIT.
- Activate the debugger's single-terminal mode screen stacking user exits during CICS start up by doing the following:
 - a. Verify that the user ID that runs the CICS region has UPDATE access to the EXITPROGRAM resource.
 - b. Add the program EQAOCPLT to your Program List Table (PLTPI).
 - c. Add INITPARM=(EQAOCPLT='STK') to your CICS startup parameters.

See step [“10”](#) on page [111](#) for instructions on using EQAOCPLT.

TDQUEUE

Verify that all users have UPDATE authority to the TDQUEUE resource, so that they can run EXEC CICS INQUIRE and EXEC CICS SET TDQUEUE.

PROGRAM

Verify that all users have READ authority to the PROGRAM resource, so that they can run EXEC CICS INQUIRE PROGRAM.

For more information about the CICS security features, see *CICS RACF Security Guide*.

- 10. (Optional) Set up the CICS PLTPI program called EQAOCPLT:
 - a. Add the program EQAOCPLT to your Program List Table (PLTPI). EQAOCPLT initializes parts of z/OS Debugger during CICS startup as indicated by a CICS INITPARM system initialization

parameter. Run EQA0CPLT as a Stage 2 or Stage 3 PLTPI program. IBM recommends that you place EQA0CPLT after other PLT programs. The following sample PLT includes EQA0CPLT:

```
TITLE 'DFHPLTXX - IBM
z/OS Debugger CICS Sample PLT'
DFHPLT TYPE=INITIAL,SUFFIX=XX
*
DFHPLT TYPE=ENTRY,PROGRAM=DFHDELIM
DFHPLT TYPE=ENTRY,PROGRAM=EQA0CPLT
*
DFHPLT TYPE=FINAL END DFHPLTBA
```

- b. Add the INITPARM keyword to the CICS startup parameters. Multiple parameters can be passed to EQA0CPLT in the same INITPARM. The following common parameters can be used:

NLE

Non-Language Environment support. See [“Activating CICS non-Language Environment exits” on page 113](#).

STK

Screen stack exits. This parameter is required if you are using command security.

NWP

New Program detection. Use this parameter in AOR regions to request that DTCN pattern matching looks in the DTCN repository for profiles that were created in other regions.

STG

This parameter enables the protection of storage that was GETMAINED in the current task by a program that is not the active program. This protection is only provided when the user is using the remote debugger.

DNT

This parameter disables the generation of z/OS Debugger trace entries. By default, these trace entries are generated for IBM Software Support to diagnose problems with z/OS Debugger. You can specify this parameter to disable generation if z/OS Debugger trace entries are not needed.

For example, to activate the non-Language Environment support, screen stack exits, and new program support (multi-region) in a single INITPARM, add the following to your CICS startup parameters:

```
INITPARM=(EQA0CPLT='NLE,STK,NWP')
```

Any combination of these four can be coded on the same INITPARM.

11. If the users use COBOL or PL/I separate debug files, verify that the users specify the following attributes for the PDS or PDSE that contains the separate debug files:

- RECFM=FB
- LRECL=1024
- BLKSIZE set so that the system determines the optimal size

Important: Users must allocate files with the correct attributes to optimize the performance of z/OS Debugger.

12. (Optional) Increase the DSALIM and EDSALIM sizes in your CICS region so that z/OS Debugger functions properly with multiple concurrent users. The amount of increase is based on the current workload in the CICS region.

Recommendation: Increase the sizes of DSALIM and EDSALIM in increments of 5% or 10%. Monitor the storage in the region as z/OS Debugger users are debugging for the highest amount of storage that is used at any one point.

13. To enable users to start debug sessions for Enterprise COBOL or Enterprise PL/I application with DTCN, use one of the following methods:

- Use PLTPI program EQAOCPLT with the CICS start up parameter INITPARM=(EQAOCPLT='NWP'). For more information about EQAOCPLT, see Step “10” on page 111.
- Save a DTCN profile.
- Run DTCPO transaction after the region starts up.

See the *IBM z/OS Debugger User's Guide* for information about how to debug CICS programs.

Activating CICS non-Language Environment exits

To debug non-Language Environment assembler programs or non-Language Environment COBOL programs that run under CICS, you must start the required z/OS Debugger global user exits before you start the programs. z/OS Debugger provides the following global user exits to help you debug non-Language Environment applications: XPCFTCH, XEIIIN, XEIOU, XPCTA, and XPCHAIR. The exits can be started by using either the DTCX transaction (provided by z/OS Debugger), or using a PLTPI program that runs during CICS region startup

DTCX: You can turn the exits on and off by using the transaction DTCX. To activate all of the exits, from a clear CICS terminal screen enter DTCXXO. To deactivate all of the exits, enter DTCXXF. You need to activate the exits only once. If you deactivate the exits and then want to debug a non-Language Environment program, you need to enter DTCXXO from a clear CICS terminal screen to activate the exits.

After you enter DTCXXO, a series of messages are displayed on your screen. If all exits are activated successfully, the following messages are displayed:

```
EQA9972I - DT XPCFTCH CICS exit now ON.
EQA9972I - DT XEIIIN exit now ON.
EQA9972I - DT XEIOU exit now ON.
EQA9972I - DT XPCTA exit now ON.
EQA9972I - DT XPCHAIR exit now ON.
EQA9970I - CICS exit activation successful.
```

When you enter DTCXXF, the following messages are displayed:

```
EQA9973I - DT XPCFTCH CICS exit now OFF.
EQA9973I - DT XEIIIN exit now OFF.
EQA9973I - DT XEIOU exit now OFF.
EQA9973I - DT XPCTA exit now OFF.
EQA9973I - DT XPCHAIR exit now OFF.
EQA9971I - CICS exit deactivation successful.
```

If there is a problem starting or activating one of the exits, an error message like the following is displayed:

```
EQA9974I Error enabling XPCFTCH - EQANCFTC
```

If you see this error message, verify that the CICS CSD is properly updated to include the latest z/OS Debugger resource definitions, and that the z/OS Debugger SEQAMOD data is in the DFHRPL DD concatenation for the CICS region.

You can start the exits during region initialization by using a sequential terminal or any other mechanism that runs transactions during CICS startup. You are not required to shut down the exits before or during a region shutdown.

PLT: The non-Language Environment exits can also be activated during CICS region initialization by using the CICS Program List Table (PLTPI) program EQAOCPLT (supplied by z/OS Debugger). In addition to adding EQAOCPLT to your CICS region PLT, you must specify the CICS startup parameter INITPARM=(EQAOCPLT='NLE'). EQAOCPLT supersedes the function provided earlier by PLTPI program EQANCPLT. See step “10” on page 111 for instructions on using EQAOCPLT. For more information about PLT processing, see the *CICS Resource Definition Guide*.

Storing DTCN debug profiles in a VSAM file

By default, the CICS DTCN transaction stores its debugging profiles into a CICS temporary storage queue (TSQ) called EQADTCN2. Because CICS destroys temporary storage queues at region termination, any profiles stored in EQADTCN2 are deleted when a region is stopped. To save debugging profiles across region termination and restart or after the owning terminal is disconnected, store the profiles into a VSAM data set.

Do the following steps to instruct DTCN to store its debugging profiles in a VSAM data set:

1. Create the VSAM data set by following the instructions in the EQAWCRVS member of the *hlq*.SEQASAMP data set.
2. Modify the CICS region startup JCL so that the EQADPFMB DD statement identifies the VSAM data set you created in step 1.
3. Define the VSAM file to the CICS region by following the instructions in the EQACCSO member of the *hlq*.SEQASAMP data set. [“Sharing DTCN debug profile repository among CICS systems”](#) on page 114 also describes examples of CICS resource definitions.

Migrating a debug profiles VSAM file from an earlier release

z/OS Debugger 15.0 increases the record size of the DTCN profile records and adds some new fields.

If you are migrating from an earlier release of Debug Tool or z/OS Debugger, and you use an EQADPFMB VSAM file to store your profiles, you need to create a new file using the JCL sample in member EQAWCRVS in the *hlq*.SEQASAMP data set.

If you want to upgrade the records from an old DTCN VSAM file to the new record format, see the JCL sample in member EQADPCNV in the *hlq*.SEQASAMP data set.

Note: An earlier version of the EQADPCNV utility converted the DTCN VSAM file from its Debug Tool 11.1 record size (1304 bytes) and record format to the record size (2000 bytes) and record format required by Debug Tool 12.0 and later. The utility still supports this upgrade path.

If you want to upgrade from Debug Tool 11.1 or earlier to z/OS Debugger 15.0 or later, you need to first convert the file to a Debug Tool 12.0 file, and then convert the new file to a z/OS Debugger 15.0 file. Converting directly from the Debug Tool 11.1 format to the z/OS Debugger 15.0 format is not supported.

Sharing DTCN debug profile repository among CICS systems

The DTCN debug profile repository is either a CICS temporary storage queue called EQADTCN2 or a VSAM data set identified through the EQADPFMB DD statement. If you want to share the repository among CICS systems (for example, MRO), do one of the following options:

- If you are using a temporary storage queue, do the following steps:
 1. Designate a single CICS region as the *queue-owning region* and note the SYSID of that region. In [Figure 15](#) on page 115, the SYSID of the queue-owning region is P6.
 2. For all other regions that need to access the queue-owning region, create a TSMODEL resource definition and verify that you define the following attributes:
 - For the REMOTESystem attribute, specify the SYSID of the queue-owning region.
 - For PRefix and REMOTEPrefix attribute, specify EQADTCN2.
 - To optimize the performance of z/OS Debugger, define the Location attribute as MAIN.

```

CEDA View TSmodel( DTCN1 )
TSmodel      ==> DTCN1
Group        ==> DTCNREM
Description   ==> TEST DTCN TSQ REMOTE
PPrefix      ==> EQADTCN2
XPrefix      ==>
Location     ==> Main                Auxiliary | Main
RECOVERY ATTRIBUTES
REcovery     ==> No                   No | Yes
SECURITY ATTRIBUTES
Security     ==> No                   No | Yes
SHARED ATTRIBUTES
P0olname     ==>
REMOTE ATTRIBUTES
REMOTESystem ==> P6
REMOTEPrefix ==> EQADTCN2
XRemotepfx  ==>
Group        ==>

```

Figure 15. A sample TSMODEL resource definition that gives a region access to the queue-owning region called P6.

For instructions on how to create a TSMODEL resource definition, see *CICS Resource Definition Guide*.

- If you are using a VSAM data set and want to function-ship file operations to a file-owning region (FOR), do the following steps:
 1. Designate a single FOR.
 2. Define the EQADPFMB file as REMOTE in the CICS FILE definition on regions that need to access it remotely. To learn how to define a FILE resource, see *CICS Resource Definition Guide*. [Figure 16 on page 116](#) shows how to define the EQADPFMB file in a region that uses it remotely.
 3. For the region which owns the VSAM data set, omit the REMOTESYSTEM and REMOTENAME values in the EQADPFMB CICS FILE definition.
 4. Start the FOR before starting any AOR that needs to read the EQADPFMB file.

```

CEDA View File( EQADPFMB )
File      : EQADPFMB
Group     : DTCNREM
DEscription : DTCN PROFILE DATASET REMOTE
VSAM PARAMETERS
DSName    :
Password  : PASSWORD NOT SPECIFIED
RLSaccess : No           Yes | No
LSrpoolid : 1           1-8 | None
READInteg : Uncommitted Uncommitted | Consistent | Repeatable
DSNSharing : Allreqs    Allreqs | Modifyreqs
STRings   : 001        1-255
Nsrgroup  :
REMOTE ATTRIBUTES
REMOTESystem : P6
REMOTENAME   : EQADPFMB
REMOTE AND CFDATATABLE PARAMETERS
RECORDSize  : 1-32767
Keylength   : 1-255 (1-16 For CF Datatable)
INITIAL STATUS
STatus      : Enabled    Enabled | Disabled | Unenabled
Opentime    : Firstref   Firstref | Startup
DISposition : Share      Share | Old
BUFFERS
Databuffers : 00002      2-32767
Indexbuffers : 00001     1-32767
DATATABLE PARAMETERS
TABLE       : No         No | CICS | User | CF
Maxnumrecs  : Nolimit   Nolimit | 1-99999999
CFDATATABLE PARAMETERS
Cfdtpool    :
TABLEName   :
UPDATEModel : Locking    Contention | Locking
LOad        : No         No | Yes
DATA FORMAT
RECORDFormat : V         V | F
OPERATIONS
Add          ==> No       No | Yes
BRowse       ==> No       No | Yes
DElete       ==> No       No | Yes
READ         ==> Yes      Yes | No
UPDATE       ==> No       No | Yes
AUTO JOURNALLING
JOUrnal     ==> No       No | 1-99
JNLRead     ==> None     None | Updateonly | Readonly | All
JNLSYNCRoad ==> No       No | Yes
JNLUpdate   ==> No       No | Yes
JNLAdd      ==> None     None | Before | After | All
JNLSYNCRwrite ==> Yes    Yes | No
RECOVERY PARAMETERS
RECOVery    ==> None     None | Backoutonly | All
Fwdrecovlog ==> No       No | 1-99
BAckuptype  ==> Static   Static | Dynamic
SECURITY
RESsecnum   : 00         0-24 | Public

```

Figure 16. An example of how to define the EQADPFMB file as REMOTE in a CICS FILE definition.

- If you are using a VSAM data set and prefer to define the file locally to all CICS regions that use it, define the file on all such regions using record-level sharing (RLS). The following sample resource definition shows how to define the z/OS Debugger EQADPFMB file using RLS.

```

CEDA View File( EQADPFMB )
File      : EQADPFMB
Group     : DTCNRLS
DEscription : DTCN PROFILE DATASET
VSAM PARAMETERS
DSName    :
Password  : PASSWORD NOT SPECIFIED
RLSaccess : Yes         Yes | No
LSrpoolid : 1           1-8 | None
READInteg : Uncommitted Uncommitted | Consistent | Repeatable
DSNSharing : Allreqs    Allreqs | Modifyreqs
STRings   : 010        1-255
Nsrgroup  :
REMOTE ATTRIBUTES
REMOTESystem :
REMOTENAME   :
REMOTE AND CFDATATABLE PARAMETERS

```

userid

Deactivate the debug profile associated with a specific CICS user ID.

★

Deactivate debug profiles from the VSAM data set. This option requires specific RACF authority; therefore, reserve it for CICS administrators.

Refer to the following topics for more information related to the material discussed in this topic.

Related tasks

[“Authorizing DTCD and DTCI transactions to delete or deactivate debug profiles” on page 125](#)

Deleting DTCN profiles with the DTCN LINK service

z/OS Debugger provides a service that deletes unowned profiles from the DTCN repository.

If the DTCN repository is stored in CICS Temporary Storage (EQADTCN2), profiles are owned by the terminal that created them. The service scans the repository, looking for profiles that were created in the region running the service. If the service finds a profile owned by a terminal that is no longer defined and active in the region, the service deletes the profile.

If the DTCN repository is stored in VSAM (EQADPFMB), profiles are owned by the user ID that created them. The service scans the repository, looking for profiles that were created in the region running the service. If the service finds a profile owned by a user ID that is no longer active in the region, the service deletes the profile.

Invoke the service with the following command:

```
EXEC CICS LINK PROGRAM('EQADCDEL')
```

The service does not expect a commarea.

Invoke this service during DELETE processing in the program that controls autoinstall of terminals; however, you can invoke it from any EXEC-capable program. Figure 17 on page 118 and Figure 18 on page 118 show how to invoke the service in DFHZATDX, the supplied, user-replaceable autoinstall control program for terminals.

```
*****
* *           D E L E T E   P R O C E S S I N G           * *
* *           -----                                     * *
* *                                                                 * *
*****
DELETE_TERMINAL DS      0H
                    USING DELETE_EXIT_COMMAREA,R2 Address delete commarea
* ==> PUT DELETE CODE HERE
*
        EXEC CICS LINK PROGRAM('EQADCDEL')
*
        B      RETURN                EXIT PROGRAM
```

Figure 17. Example of invoking service in DFHZATDX

```
*****
* Function 8 and 10 - Common delete processing for shipped definitions*
*****
DELETE_SHIPPED_TERMINAL DS 0H                                @D2A
                    USING DELETE_SHIPPED_COMMAREA,R2 Address commarea @D2A
* ==> PUT DELETE CODE HERE                                @D2A
*
        EXEC CICS LINK PROGRAM('EQADCDEL') NOHANDLE
*
        B      RETURN                EXIT PROGRAM          @D2A
        DFHEJECT                                @D2A
```

Figure 18. Example of invoking service in DFHZATDX

Note: To use the the DTCN LINK service, ensure that the DTCNDELETEDEADPROF EQAOPTS command is set to YES.

See “[DTCNDELETEDEADPROF](#)” on page 166 for more information.

Requiring users to specify resource types

If your users use DTCN to specify debugging profiles, you can customize z/OS Debugger to require that your users specify some or all resource types. For example, if your users are debugging a heavily used CICS program, you can require that they specify a Terminal ID and a Transaction ID to avoid having z/OS Debugger started every time that CICS program is run. You can enforce these requirements by specifying the corresponding EQAOPTS DTCNFORCExxxx command, as described in “[DTCNFORCExxxx](#)” on page 167.

Direct QSAM access through a CICS task-related user exit

z/OS Debugger can use two methods to access the following types of files:

- Enterprise COBOL and Enterprise PL/I separate debug files (SYSDEBUG)
- C/C++ separate debug files (.dbg and .mdbg)
- assembler and LangX COBOL EQALANGX files
- listing and source files
- command and preference files
- save settings and save breakpoints and monitor specification files
- log files

The following list describes both access methods:

- CICS Extrapartition Transient Data (default method)
- Direct QSAM access through a CICS task-related user exit

If you want the access method to avoid using CICS SPI and API to access these files, enable the QSAM access method.

To enable the QSAM access method, use the following INITPARM in your CICS start up parameters:

```
INITPARM=(DFHLETRU='USEQSAM')
```

You also need to apply the following PTFs to the appropriate products:

- For CICS Transaction Server for z/OS, Version 3.1, apply the PTF for PK67329
- For CICS Transaction Server for z/OS, Version 3.2, apply the PTF for PK68401
- For Enterprise COBOL compilers, apply the PTF for PK71852 to Language Environment, Version 1.8 through 1.10
- For Enterprise PL/I compilers, apply the PTF for PK93564 to Language Environment, Version 1.8 through 1.11

Running multiple debuggers in a CICS region

Coexistence with other debuggers cannot be guaranteed since situations can occur where multiple debuggers might contend for use of storage, facilities and interfaces which are intended for only one requester.

It is suggested that if you must have multiple debuggers installed in a CICS region, then only one should be active at any given time. When another debugger is used, ensure that the z/OS Debugger CICS non-Language Environment user exits are deactivated and that there are no active DTCN profiles in the region. The user exits can be deactivated by issuing the DTCXXF transaction. To deactivate other debuggers, consult the documentation provided by the vendor of the other debuggers.

Running the installation verification programs in a CICS region

To help you verify that your CICS region has been customized properly for z/OS Debugger, the *hlq*.SEQASAMP data set contains installation verification programs (IVPs) in the following members. Run the IVPs that are appropriate for the tasks that your users will be performing.

IVP	Task
EQAWIVCI	Dynamic Debug facility and Enterprise PL/I TEST (ALL , SYM , NOHOOK , SEPARATE)
EQAWIVCP	Dynamic Debug facility and COBOL TEST (NONE , SYM , SEPARATE) or TEST (NOHOOK , SEPARATE)
EQAWIVCT	Dynamic Debug facility and Enterprise COBOL for z/OS Version 5 and later TEST
EQAWIVC2	C TEST (ALL)
EQAWIVCG	C DEBUG (FORMAT (DWARF) , HOOK (LINE , NOBLOCK , PATH) , SYMBOL)
EQAWIVC8	Enterprise PL/I TEST (ALL)
EQAWIVCC	Non-Language Environment Assembler
EQAWIVCJ	LangX Enterprise COBOL

Configuring z/OS Debugger to run in a CICSplex environment

In a CICSplex, the application-owning regions (AORs), terminal-owning regions (TORs), queue-owning regions (QORs), repositories, and terminals can be organized in an infinite number of ways. In the following topics, we explore a finite number of scenarios and let you know what you need to do to configure z/OS Debugger to work in each scenario. For all of these scenarios, we assume you are working in full screen mode.

- [“Terminal connects to an AOR that runs the application” on page 120](#)
- [“Terminal connects to a TOR which routes the application to an AOR; debugging profiles managed by DTCN” on page 121](#)
- [“Terminal connects to an AOR that runs an application that does not use a terminal” on page 122](#)
- [“Screen control mode terminal connects to a TOR and application runs in an AOR” on page 122](#)
- [“Separate terminal mode terminal connects to a TOR and application runs in an AOR” on page 123](#)

Terminal connects to an AOR that runs the application

In this scenario, your terminal (TRMC) connects to an AOR (CICSAOR2) that runs the application you want to debug. The debugging profiles can be managed by either DTCN and they are directly accessible by the AOR.

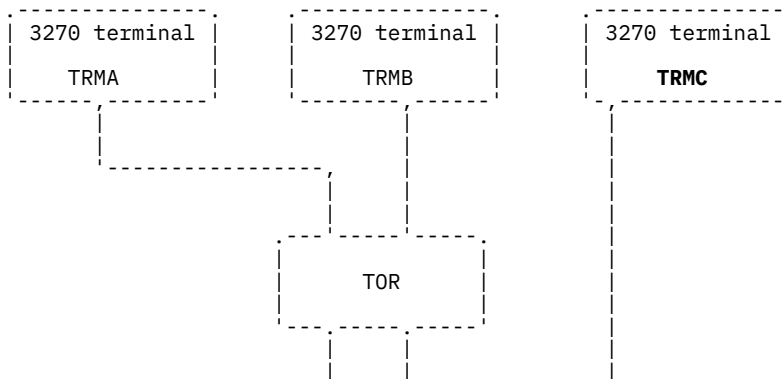

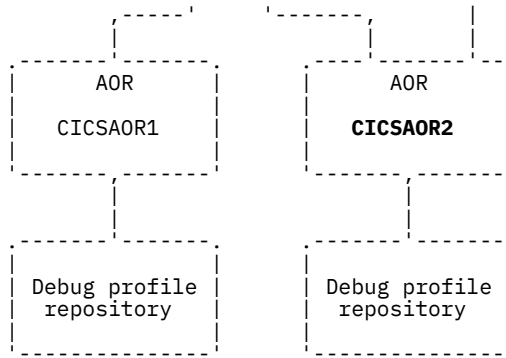

For this scenario to work, the CICS system administrator must complete the following tasks for the region CICSAOR2:

- Define z/OS Debugger resources in the CICS CSD and install them in the CICS region, as described in Chapter 12, “Adding support for debugging under CICS,” on page 109, step 1.
- Provide access to these resources, as described in Chapter 12, “Adding support for debugging under CICS,” on page 109, step “2.a” on page 109.

If you want to debug an application that runs in another AOR region, like CICSAOR1, you must log on to that region and verify that the system administrator completed the above tasks for that region.

Terminal connects to a TOR which routes the application to an AOR; debugging profiles managed by DTCN

In this scenario, your terminal (TRMC) connects to a TOR, which uses a CICS transaction to route the application you want to debug to an AOR. The debugging profiles are managed by DTCN and are stored in a temporary storage queue (EQADTCN2) located in a queue-owning region (QOR). You can run the DTCN transaction in any of the regions.

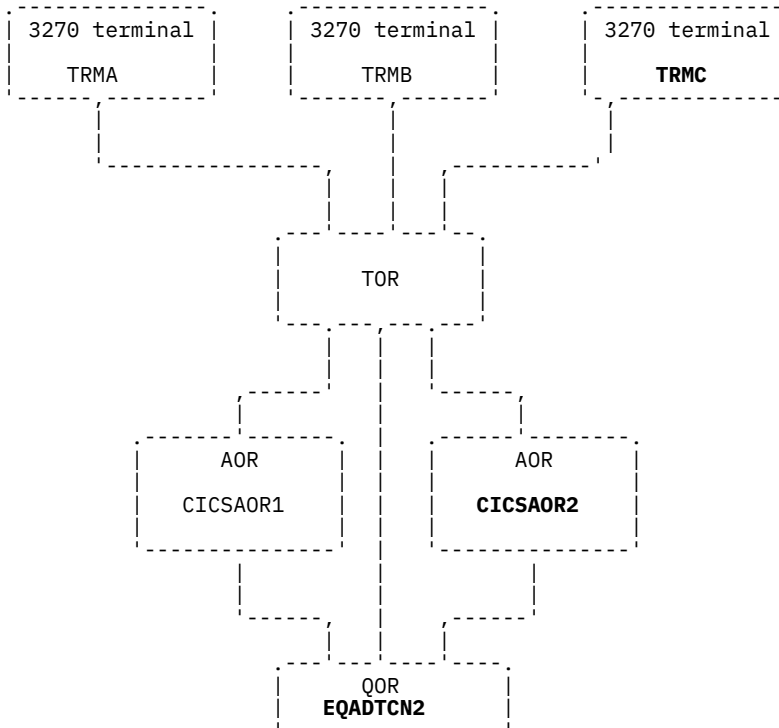

For this scenario to work, the CICS system administrator must complete the following tasks for both AORs and the TOR:

- Define z/OS Debugger resources in the CICS CSD and install them in the CICS region, as described in Chapter 12, “Adding support for debugging under CICS,” on page 109, step 1.
- Provide access to these resources, as described in Chapter 12, “Adding support for debugging under CICS,” on page 109, step “2.a” on page 109.
- Designate a single CICS region as the QOR and define the queue accessible remotely, as described in “Sharing DTCN debug profile repository among CICS systems” on page 114.

Variation on this scenario: The temporary storage queue (EQADTCN2) does not need to be located in a QOR. It can be located in the TOR, any of the AORs, or in the coupling facility. Wherever you put the temporary storage queue, keep the following considerations in mind:

- Place the queue where it can be accessed efficiently when the application programs begin, since it is referenced at that point to determine whether the program should be debugged.
- The temporary storage queue is accessed by Function Shipping, so allocate a sufficient number of connections between the regions to handle READQ requests.

Terminal connects to an AOR that runs an application that does not use a terminal

In this scenario, your terminal (TRMC) connects to an AOR, which you use to set up a debugging profile using DTCN. When the application starts, z/OS Debugger is started and issues an EXEC CICS START of its display transaction (CDT#) on your terminal (TRMC). Your terminal must be connected directly to the AOR. You cannot connect through CRTE because CICS does not support issuing an EXEC CICS START to a terminal connected through CRTE.

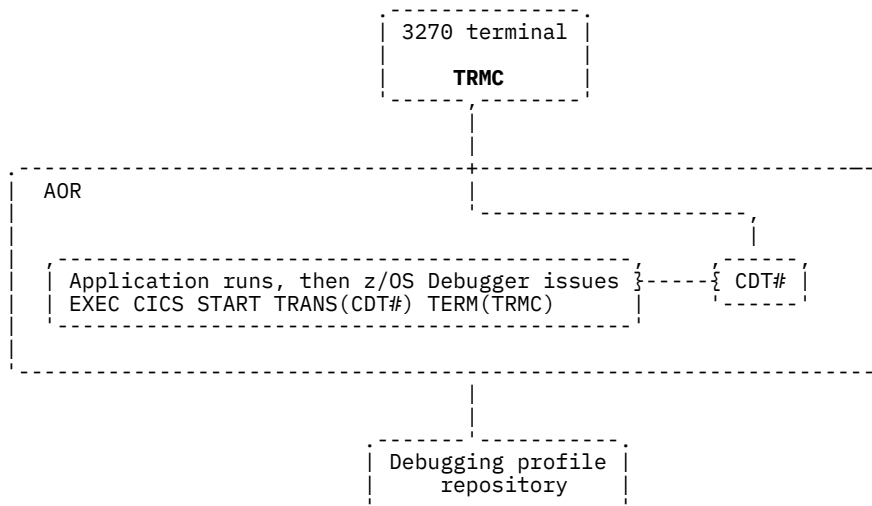

For this scenario to work, the CICS system administrator must complete the following tasks for the AOR:

- Define z/OS Debugger resources in the CICS CSD and install them in the CICS region, as described in Chapter 12, “Adding support for debugging under CICS,” on page 109, step “1” on page 109.
- Provide access to these resources, as described in Chapter 12, “Adding support for debugging under CICS,” on page 109, step “2.a” on page 109.

Screen control mode terminal connects to a TOR and application runs in an AOR

In this scenario, the user starts the DTSC transaction on the display terminal to display the debug session. DTSC must run in the same region as the application, but could run in any of the following situations:

- As a Transaction-Routed transaction
- On a CRTE terminal session which was started on the AOR

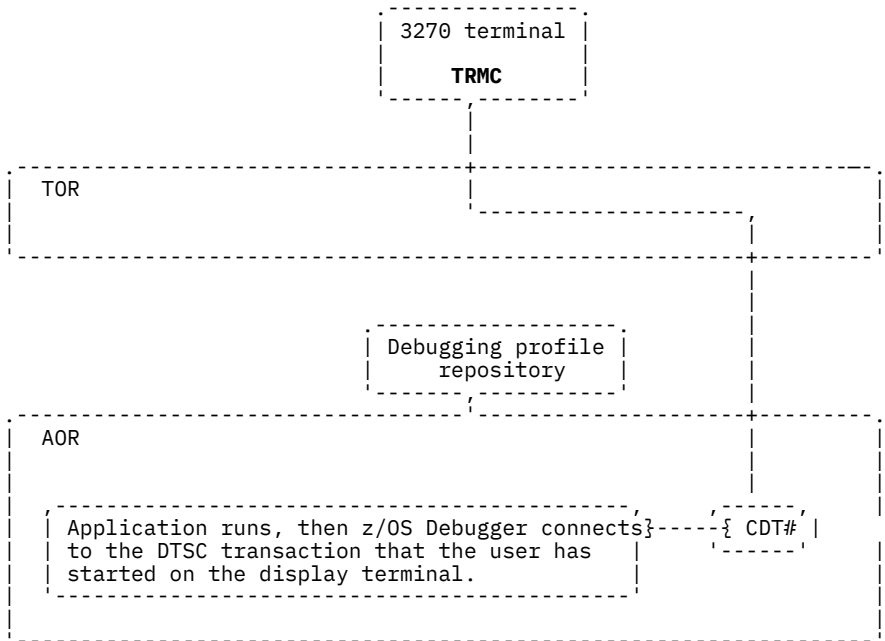

Separate terminal mode terminal connects to a TOR and application runs in an AOR

In this scenario, your terminal (TRMC) connects to a TOR and the following sequence of events occurs:

1. You store a debugging profile into a repository using DTCN.
2. The application starts. The profile matches the application so z/OS Debugger is started.
3. z/OS Debugger issues EXEC CICS START of its display transaction (CDT#) on your terminal (TRMC). However, your terminal is not found. XICTENF/XALTENF identifies the TOR as the owner of your terminal (TRMC).
4. CICS routes the START task to the TOR identified by XICTENF/XALTENF.
5. Interval Control in the TOR associates the START task with your terminal (TRMC) and then routes the START task back to the AOR.
6. CDT# establishes the communication between your terminal and the application through the TOR.

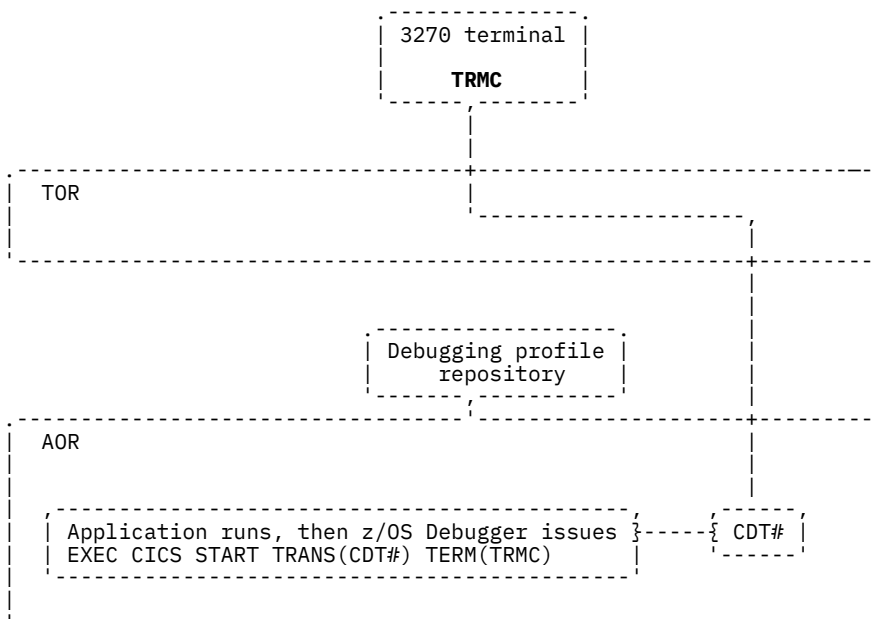

For this scenario to work, the CICS system administrator must complete the following tasks for the TOR:

- If you are using DTCN to manage debugging profiles, do the following tasks:
 - Define z/OS Debugger resources in the CICS CSD and install them in the CICS region, as described in [Chapter 12, “Adding support for debugging under CICS,” on page 109, step “1” on page 109.](#)
 - Provide access to these resources, as described in [Chapter 12, “Adding support for debugging under CICS,” on page 109, step “2.a” on page 109.](#)
- Enable routing of the terminal traffic to the correct terminal by configuring the z/OS Debugger transaction CDT# as DYNAMIC(YES).
- If your CICS region has a Temporary Storage Model (TSMODEL) that can make queues with a prefix of "CDT#" recoverable, you must create a TSMODEL that specifies PREFIX(CDT#) and RECOVERY(NO).

For this scenario to work, the CICS system administrator must complete the following tasks for the AOR:

- If you are using DTCN to manage debugging profiles, do the following tasks:
 - Define z/OS Debugger resources in the CICS CSD and install them in the CICS region, as described in [Chapter 12, “Adding support for debugging under CICS,” on page 109, step “1” on page 109.](#)
 - Provide access to these resources, as described in [Chapter 12, “Adding support for debugging under CICS,” on page 109, step “2.a” on page 109.](#)
- To locate the terminal, do the following steps:
 - Code the CICS exits XICTENF and XALTENF so that the TOR is identified as the owner of the display terminal. The *CICS Transaction Server for z/OS Customization Guide* describes these exits.
 - Run a PLT program that enables the CICS exits XICTENF and XALTENF. The *CICS Transaction Server for z/OS Customization Guide* describes how to write and run a PLT.
 - Enable routing of the terminal traffic to the correct terminal by configuring the z/OS Debugger transaction CDT# as DYNAMIC(YES).
 - If your CICS region has a Temporary Storage Model (TSMODEL) that can make queues with a prefix of "CDT#" recoverable, you must create a TSMODEL that specifies PREFIX(CDT#) and RECOVERY(NO).

Authorizing DTST transaction to modify storage

Note: This section is not applicable to IBM Developer for z/OS (non-Enterprise Edition) or IBM Z and Cloud Modernization Stack (Wazi Code).

This topic describes the steps you must take to authorize the DTST transaction to modify either USER-key storage, CICS-key storage, or both. DTST does not allow users to modify Key-0 storage.

The following resources control DTST authorizations:

- EQADTOOL.DTSTMUSERK, which controls the ability to modify USER-key storage.
- EQADTOOL.DTSTMDCICK, which controls the ability to modify CICS-key storage.

1. Establish profiles in the FACILITY class by entering the following RDEFINE commands:

```
RDEFINE FACILITY EQADTOOL.DTSTMUSERK UACC(NONE)
RDEFINE FACILITY EQADTOOL.DTSTMDCICK UACC(NONE)
```

2. Verify that generic profile checking is in effect for the class FACILITY by entering the following command:

```
SETRPTS GENERIC(FACILITY)
```

3. Give a user permission to modify USER-key, CICS-key storage, or both by entering one or both of the following commands, where DUSER1 is the name of a RACF-defined user or group profile:

```
PERMIT EQADTOOL.DTSTMUSERK CLASS(FACILITY) ID(DUSER1) ACCESS(UPDATE)
PERMIT EQADTOOL.DTSTMDCICK CLASS(FACILITY) ID(DUSER1) ACCESS(UPDATE)
```

Instead of connecting individual users, the security administrator can specify DUSER1 to be a RACF group profile and then connect authorized users to the group.

4. If the FACILITY class is not active, activate the class by entering the following SETROPTS command:

```
SETROPTS CLASSACT(FACILITY)
```

Enter the SETROPTS LIST command to verify that FACILITY class is active.

5. Refresh the FACILITY class by entering the following SETROPTS RACLIST command:

```
SETROPTS RACLIST(FACILITY) REFRESH
```

Authorizing DTCD and DTCI transactions to delete or deactivate debug profiles

This topic describes the steps you must take to authorize the DTCD and DTCI transactions to delete or deactivate debug profiles stored in a VSAM data set.

The EQADTOOL.DTCDDELETEALL resource controls DTCD authorizations.

The EQADTOOL.DTCIINACTALL resource controls DTCI authorizations.

To authorize DTCD and DTCI users so they can delete or deactivate debug profiles stored in a VSAM data set, do the following steps:

1. Establish profiles in the FACILITY class by entering the following RDEFINE commands:

```
RDEFINE FACILITY EQADTOOL.DTCDDELETEALL UACC(NONE)  
RDEFINE FACILITY EQADTOOL.DTCIINACTALL UACC(NONE)
```

2. Verify that generic profile checking is in effect for the class FACILITY by entering the following command:

```
SETROPTS GENERIC(FACILITY)
```

3. Give a user permission to delete or deactivate debug profiles stored in a VSAM data set by entering the following commands, where DUSER1 is the name of a RACF-defined user or group profile:

```
PERMIT EQADTOOL.DTCDDELETEALL CLASS(FACILITY) ID(DUSER1) ACCESS(UPDATE)  
PERMIT EQADTOOL.DTCIINACTALL CLASS(FACILITY) ID(DUSER1) ACCESS(UPDATE)
```

Instead of connecting individual users, the security administrator can specify DUSER1 to be a RACF group profile and then connect authorized users to the group.

4. If the FACILITY class is not active, activate the class by entering the following SETROPTS command:

```
SETROPTS CLASSACT(FACILITY)
```

Enter the SETROPTS LIST command to verify that FACILITY class is active.

5. Refresh the FACILITY class by entering the following SETROPTS RACLIST command:

```
SETROPTS RACLIST(FACILITY) REFRESH
```

Chapter 13. Adding support for debugging under IMS

To add support for debugging applications that run in IMS, you need to do the following steps:

1. Choose one of the following methods for specifying TEST runtime options:
 - Specifying the TEST runtime options in a data set, created by the application programmers, which is then extracted by a customized version of the Language Environment user exit routine CEEBXITA.
 - Specifying the TEST runtime options in one of the following assembler modules:
 - CEEUOPT, which is an assembler module that uses the CEEXOPT macro to set application level defaults, and is link-edited into an application program.
 - CEEROPT, which is an assembler module that uses the CEEXOPT macro to set region level defaults.
 - Specifying the TEST runtime options through the EQASET transaction. The transaction allows application programmers to specify a limited set of TEST runtime options.
 - Specifying the TEST runtime options in a private message region, created by the application programmer using IBM z/OS Debugger Utilities option 4.5, "IMS Transaction Isolation Facility".
2. Choose from the following scenarios that best matches your site's environment:

Scenario A

You run programs in IMS Transaction Manager, BTS, or DB and are managing TEST runtime options with a user exit. Do the steps described in [“Scenario A: Running IMS and managing TEST runtime options with a user exit”](#) on page 128 to enable this scenario.

Scenario B

You run programs in IMS Transaction Manager, BTS, or DB and are managing TEST runtime options with CEEUOPT or CEEROPT. Do the steps described in [“Scenario B: Running IMS and managing TEST runtime options with CEEUOPT or CEEROPT”](#) on page 128 to enable this scenario.

Scenario C

You run assembler programs without Language Environment in IMS Transaction Manager and you specify some TEST runtime options with the EQASET transaction. Do the steps described in [“Scenario C: Running assembler program without Language Environment in IMS TM and managing TEST runtime options with EQASET”](#) on page 129 to enable this scenario.

Scenario D

You run programs in an IMSplex environment and are managing TEST runtime options with either a user exit, CEEUOPT, or CEEROPT. Do the steps described in [“Scenario D: Running IMSplex environment”](#) on page 129 to enable this scenario.

Scenario F

You run Message Processing Programs (MPPs) in IMS Transaction Manager, running in Message Processing Regions (MPRs). You want to isolate application program debugging and to avoid scheduling delays or conflicts with programs which are not being debugged. Do the steps described in [“Scenario F: Enabling the Transaction Isolation Facility”](#) on page 130 to enable this scenario. The IMS Transaction Isolation Facility is not available in IBM Z and Cloud Modernization Stack (Wazi Code).

You can select more than one scenario. If you select more than one scenario, some steps are repeated. Perform those steps only once.

3. After you have selected the method that your site will use to manage TEST runtime options, notify your application programmers of the chosen method. Ensure that the application programmers follow the directions described in "Preparing an IMS program" in the *IBM z/OS Debugger User's Guide* and choose the correct method for specifying TEST runtime options. If your application programmers are using the EQASET transaction to specify TEST runtime options, ensure that they follow the directions described in "Running the EQASET transaction" in the *IBM z/OS Debugger User's Guide*.

Scenario A: Running IMS and managing TEST runtime options with a user exit

Do the following steps to enable this scenario:

1. Include the z/OS Debugger *h1q*.SEQAMOD²⁹ data set and the Language Environment CEE.SCEERUN³⁰ runtime library in the STEPLIB concatenation of your IMS region.
2. To give IMS users enough time to run and debug their applications, increase the time-out limit in the message-processing region (MPR) region to 1440.
3. If you need to change the naming pattern of the data set containing the user's TEST runtime options, see the following topics for details:

- [Chapter 8, “Specifying the TEST runtime options through the Language Environment user exit,” on page 81](#)
- [“Customizing z/OS Debugger User Exit Data Set” on page 99](#)

The user will use DTU option 'z/OS Debugger User Exit Data Set' to set the TEST runtime options they want.

4. If the IMS transaction is initiated from the web or MQ gateway, it is run with a generic ID. z/OS Debugger supports a cross reference table to tie such a transaction to a user's ID. To set the name of that cross reference table, see the following topics for details:

- [Chapter 8, “Specifying the TEST runtime options through the Language Environment user exit,” on page 81](#)
- [“Customizing IMS Transaction and User ID Cross Reference Table ” on page 102](#)

The user will use DTU option 'IMS Transaction and User ID Cross Reference Table' to specify the transaction name to user ID cross reference.

5. See [Chapter 8, “Specifying the TEST runtime options through the Language Environment user exit,” on page 81](#) and [“Customizing z/OS Debugger User Exit Data Set” on page 99](#) for information about customizing the user exit (if needed).
6. If the IMS transaction is initiated from the web or MQ gateway, it is run with a generic ID. If your site has this situation, see [“Activate the cross reference function and modifying the cross reference table data set name” on page 84](#) for information about customizing the user exit to enable a cross reference table and [“Customizing IMS Transaction and User ID Cross Reference Table ” on page 102](#) for setting up IBM z/OS Debugger Utilities so that the user can access the table.

Scenario B: Running IMS and managing TEST runtime options with CEEUOPT or CEEROPT

Do the following steps to enable this scenario:

1. Include the z/OS Debugger *h1q*.SEQAMOD³¹ data set and the Language Environment CEE.SCEERUN runtime library in the STEPLIB concatenation of the IMS MPR or MPP region running your program.

²⁹ Add *h1q*.SEQAMOD to STEPLIB only if it is not already in the system search path (for example, link list). If you create a custom EQAOPTS (as described in [Chapter 16, “EQAOPTS commands,” on page 147](#)) that is not stored in *h1q*.SEQAMOD, then place the data set containing it in STEPLIB (ahead of *h1q*.SEQAMOD if it is in STEPLIB). *h1q*.SEQAMOD must be placed before any other library in the STEPLIB that contains CEEVDBG for z/OS Debugger to get control of a debug session.

³⁰ Add CEE.SCEERUN to STEPLIB only if it is not already in the system search path (for example, link list). If you create a private copy of the z/OS Debugger Language Environment user exit for IMS that is linked into CEEBINIT (as described in [Chapter 8, “Specifying the TEST runtime options through the Language Environment user exit,” on page 81](#)), then place the data set containing it in STEPLIB (ahead of CEE.SCEERUN if it is in STEPLIB).

³¹ Add *h1q*.SEQAMOD to STEPLIB only if it is not already in the system search path (for example, link list). If you create a custom EQAOPTS (as described in [Chapter 16, “EQAOPTS commands,” on page 147](#)) that

- To give IMS users enough time to run and debug their applications, increase the time-out limit in the message-processing region (MPR) region to 1440.

Scenario C: Running assembler program without Language Environment in IMS TM and managing TEST runtime options with EQASET

Do the following steps to enable this scenario:

- Copy the load modules EQANIAFE and EQANISET from the *hlq*.SEQAMOD data set into the IMS.PGMLIB data set.
- Define the following IMS transaction:

```

APPLCTN  GPSB=EQANISET,PGMTPY=TP,LANG=ASSEM  HIDAM/OSAM
TRANSACT  CODE=EQASET,MODE=SNGL,              X
          DCLWA=NO,EDIT=UC,INQ=(YES,NORECOV),  X
MSGTYPE=(SNGLSEG,NONRESPONSE,1)

```

- Add the application front end parameter APPLFE=EQANIAFE to the MPR start up job.
- Assign the EQASET transaction to a class served by the MPR that is started with the APPLFE=EQANIAFE parameter.
- Include the z/OS Debugger *hlq*.SEQAMOD³² data set in the STEPLIB concatenation of the IMS MPR or MPP region running your program.
- To give IMS users enough time to run and debug their applications, increase the time-out limit in the message-processing region (MPR) region to 1440.

Scenario D: Running IMSplex environment

Do the following steps to enable this scenario:

- Include the z/OS Debugger *hlq*.SEQAMOD³³ data set and the Language Environment CEE.SCEERUN runtime library in the STEPLIB concatenation of the IMS MPR or MPP region running your program.
- To give IMS users enough time to run and debug their applications, increase the time-out limit in the message-processing region (MPR) region to 1440.
- If you are using a user exit and you need to change the naming pattern of the data set containing the user's TEST runtime options, see the following topics for details:
 - [Chapter 8, “Specifying the TEST runtime options through the Language Environment user exit,” on page 81](#)
 - [“Customizing z/OS Debugger User Exit Data Set” on page 99](#)

The user can use DTU option 'z/OS Debugger User Exit Data Set' to set the TEST runtime options they want.

is not stored in *hlq*.SEQAMOD, then place the data set containing it in STEPLIB (ahead of *hlq*.SEQAMOD if it is in STEPLIB). *hlq*.SEQAMOD must be placed before any other library in the STEPLIB that contains CEEVDBG for z/OS Debugger to get control of a debug session.

³² Add *hlq*.SEQAMOD to STEPLIB only if it is not already in the system search path (for example, link list). If you create a custom EQAOPTS (as described in [Chapter 16, “EQAOPTS commands,” on page 147](#)) that is not stored in *hlq*.SEQAMOD, then place the data set containing it in STEPLIB (ahead of *hlq*.SEQAMOD if it is in STEPLIB). *hlq*.SEQAMOD must be placed before any other library in the STEPLIB that contains CEEVDBG for z/OS Debugger to get control of a debug session.

³³ Add *hlq*.SEQAMOD to STEPLIB only if it is not already in the system search path (for example, link list). If you create a custom EQAOPTS (as described in [Chapter 16, “EQAOPTS commands,” on page 147](#)) that is not stored in *hlq*.SEQAMOD, then place the data set containing it in STEPLIB (ahead of *hlq*.SEQAMOD if it is in STEPLIB). *hlq*.SEQAMOD must be placed before any other library in the STEPLIB that contains CEEVDBG for z/OS Debugger to get control of a debug session.

Scenario F: Enabling the Transaction Isolation Facility

Note: The IMS Transaction Isolation Facility is not available in IBM Z and Cloud Modernization Stack (Wazi Code).

The IMS Transaction Isolation Facility of z/OS Debugger allows users to register to debug transactions in any IMS subsystem that is enabled for the facility. Each user may also launch a private message-processing region in which the selected message processing programs will run. The actions in this section will guide you through the setup of this facility.

The IMS Transaction Isolation Facility requires that the following resources be created or reserved for z/OS Debugger users:

1. A set of IMS message classes reserved for the private message-processing regions.
2. For each reserved message class, a set of IMS program resources with the name EQATccc*n*, where *ccc* is the three-digit class number, and *n* is an ordinal number from 1 to the maximum number of transactions a single user can register to debug.

Also, for each reserved message class, a set of IMS transaction resources must be defined. A set of non-conversational transactions with the names EQATccc*n* and a set of conversational transactions with the names EQACccc*n* must be defined, where *ccc* is the three-digit class number, and *n* is an ordinal number from 1 to the maximum number of transactions a single user can register to debug.

Do the following steps to enable this scenario:

1. Customize and run the EQAWTIVS sample member. A VSAM data set is created to be used as a repository to store the IMS Transaction Isolation information when the IMS system is stopped.
2. Customize and run the EQAWTIMS sample member to link-edit the z/OS Debugger exits into an IMS system control region load library data set. Note that this library must be a PDS, not a PDSE. z/OS Debugger implements the following exits for the IMS Transaction Isolation Facility:
 - DFSMSCE0 - TM and MSC Message Routing and Control User exit routine, as an alias of EQATIEXT
 - EQATIEDT - Transaction Code (Input) edit routine for EQA*ccc*n* transactions
3. Customize the EQAOPTS sample and create the EQAOPTS load module.

The EQAOPTS sample builds a set of EQAOPTS commands into a data-only load module. For more information, see Chapter 16, “EQAOPTS commands,” on page 147.

The following EQAOPTS command applies to the IMS Transaction Isolation Facility:

MAXTRANUSER

This command specifies the maximum number of transactions that a single user can register to debug. The default value is 15.

4. Modify the IMS system by performing the following actions:
 - a. Ensure that the following load libraries are in the search path for the IMS system control region:
 - The load library with the z/OS Debugger IMS exits link-edited in step 2
 - The library that contains the EQAOPTS load module generated in step 3
 - b. Add the VSAM data set created in step 1 to the IMS system control region by using DD name EQATIVSM.
 - c. If your IMS system uses the DFSMSCE0 exit, the following is needed for debugger's DFSMSCE0 exit, loaded from STEPLIB, to call your exit from DD EQAIMEXT:
 - i) Remove the load library that contains your DFSMSCE0 exit from the STEPLIB or JOBLIB concatenation of the IMS control region.

If you cannot remove the load library, ensure that the load library with the z/OS Debugger version of DFSMSCE0 appears before your DFSMSCE0 exit in the search path.
 - ii) Add the load library that contains your DFSMSCE0 exit to the IMS system control region by using DD name EQAIMEXT.

Note: EQAIMEXT DD is needed only for your site's DFSMSCE0 exit. It must not contain the debugger's DFSMSCE0.

If your IMS system uses a facility, such as the generic MSC exit of IMS Tools, to manage multiple DFSMSCE0 exits, use that facility rather than the steps i and ii above to add debugger's DFSMSCE0 exit to your system.

After you complete the actions, start or restart the IMS system.

5. Define the user EQANBSWT to RACF, and permit it READ access to the ASSIGN, DISPLAY, START, and STOP IMS commands:

```
ADDUSER EQANBSWT NOPASSWORD DFLTGRP(SYS1)
PE ASS CLASS(CIMS) ID(EQANBSWT) ACC(READ)
PE DIS CLASS(CIMS) ID(EQANBSWT) ACC(READ)
PE STA CLASS(CIMS) ID(EQANBSWT) ACC(READ)
PE STO CLASS(CIMS) ID(EQANBSWT) ACC(READ)
SETROPTS RACLIST(CIMS) REFRESH
```

6. Give the user ID for each IMS control region authority to modify the VSAM data set created in step 1.
7. If your site restricts access to the following type-1 IMS commands, and you have enabled the IMS Common Service Layer (CSL), you must enable users to issue the QUERY TRAN type-2 IMS command.

```
/DISPLAY PROG ALL
/DISPLAY TRAN *
```

To enable this access, permit the users READ access to the IMS.CSLppppp.QRY.TRAN resource in the OPERCMDS class, where *ppppp* is the name of the IMSplex that the IMS subsystem registers with. For example:

```
PE IMS.CSLPLEX1.QRY.TRAN CLASS(OPERCMDS) ID(RANCAM) ACC(READ)
SETROPTS RACLIST(OPERCMDS) REFRESH
```

8. In the shared-queue environment, permit the users UPDATE access to the IMS.CSLppppp.UPD.TRAN resource and READ access to the IMS.CSLppppp.QRY.TRAN resource in the OPERCMDS class, where *ppppp* is the name of the IMSplex that the IMS subsystem registers with. For example:

```
PE IMS.CSLPLEX1.QRY.TRAN CLASS(OPERCMDS) ID(RANCAM) ACC(READ)
PE IMS.CSLPLEX1.UPD.TRAN CLASS(OPERCMDS) ID(RANCAM) ACC(UPDATE)
SETROPTS RACLIST(OPERCMDS) REFRESH
```

9. In the shared-queue environment, if you want to allow debug user to stop their regions from remote LPARs, permit users UPDATE access to the IMS.CSLppppp.STO.REGION.

```
PE IMS.CSLPLEX1.STO.REGION CLASS(OPERCMDS) ID(RANCAM) ACC(UPDATE) SETROPTS
RACLIST(OPERCMDS) REFRESH
```

Otherwise, stopping the region must be done from the same LPAR where it was started.

10. Enable administrative users to configure the IMS Transaction Isolation Facility. Users that are authorized for this function use IBM z/OS Debugger Utilities option 4, suboption 6 "Administer IMS Transaction Isolation Environment", to reserve message classes for z/OS Debugger usage, and to generate other artifacts for the IMS Transaction Isolation Facility.

To control access to the Administer IMS Transaction Isolation Environment panel, create RACF FACILITY EQADTOOL.IMSTRANISOADMIN with UACC(NONE). Permit users who might access the panel ACC(READ) to the FACILITY.

11. Use IBM z/OS Debugger Utilities option 4, suboption 6 "Administer IMS Transaction Isolation Environment" to reserve message classes for use by the IMS Transaction Isolation Facility. Ensure that these classes are not in use for other dependent regions in your IMS system.

When multiple versions of IMS subsystems are installed on your system, you can use suboption 6 to provide a specific RESLIB used by this IMS subsystem. If no RESLIB is specified on suboption 6, the one from us5imrsl in EQAZDFLT is used as the default. If your IMSplex uses shared queues, changes to debug classes are broadcasted to other members of the IMSplex.

If you require the IMS Transaction Isolation Facility to use type-2 IMS commands to retrieve the transaction list (see step 7 above) or your IMSplex is configured to use shared queues, supply the IMSplex name on the suboption 6 panel.

12. Customize the *hlq*.SEQASAMP (EQAWICRT) sample job and submit the job to generate one or both of the following resource definitions:

- Stage-1 IMS system definition macros to create the necessary IMS resources for the classes you have selected. The macros are generated to the data set with the DD name EQARESDS.
- Type-2 IMS commands to create the necessary IMS resources for the classes you have selected. The commands are generated to the data set with the DD name EQATY2DS.

13. Use the resource definitions from step 11 to update the IMS system definition, preferably by using the Type 2 commands to update the system dynamically, if you are using Dynamic Resource Definition (DRD). Otherwise, add the Type 1 commands to the stage 1 input to your system definition process, and regenerate the IMS system definition.

Note: The EDIT parameter in the stage-1 input requires at least a CTLBLKS level of system definition. A MODBLKS definition cannot be used.

Restart the IMS system, if necessary, to pick up the changes.

14. Add any important IMS PROCLIBs to EQAZPROC in *hlq*.SEQATLIB. This action allows IBM z/OS Debugger Utilities to expand any IMS PROCs that are discovered when the execution environment of the selected transaction is cloned.
15. Additional customization parameters are available in member EQAZDFLT of *hlq*.SEQATLIB library. To set the value for any of these parameters, remove the preceding comment character (!) and specify the value, followed by a semicolon (;).

```

!*
! Default job name for dynamic IMS MPR creation
!*
! Up to 7 characters of the user's TSO user ID will be substituted
! for the string &&user&&.
!*
mprdebug =                ! Job name for debugging
    @&&user&& ;           1      ! IMS MPR
!*
! Specify the name of the main IMS RESLIB. This will be the first
! data set in the STEPLIB for the batch job that runs the EQANBSWT
! BMP program.
!*
!us5imrsl = ;             2
!us5dtmod = ;           3
!us5dtce1 = ;           4

!us5trnft = ;           5
!us5trnmx = ;           6

!us5adspc = ;           7      ! Override for JOB parm ADDRSPC
!us5bytes = ;           ! Override for JOB parm BYTES
!us5cards = ;           ! Override for JOB parm CARDS
!us5ccsid = ;           ! Override for JOB parm CCSID
!us5class = ;           ! Override for JOB parm CLASS
!us5cond = ;           ! Override for JOB parm COND
!us5group = ;           ! Override for JOB parm GROUP
!us5jeslg = ;           ! Override for JOB parm JESLOG
!us5lines = ;           ! Override for JOB parm LINES
!us5melim = ;           ! Override for JOB parm MEMLIMIT
!us5msgcl = ;           ! Override for JOB parm MSGCLASS
!us5msglv = ;           ! Override for JOB parm MSGLEVEL
!us5notify = ;          ! Override for JOB parm NOTIFY
!us5pages = ;           ! Override for JOB parm PAGES
!us5passwd = ;          ! Override for JOB parm PASSWORD
!us5perf = ;           ! Override for JOB parm PERFORM
!us5prty = ;           ! Override for JOB parm PRTY
!us5rd = ;             ! Override for JOB parm RD
!us5regn = ;           ! Override for JOB parm REGION
!us5rstrt = ;          ! Override for JOB parm RESTART
!us5seclb = ;          ! Override for JOB parm SECLABEL
!us5schen = ;          ! Override for JOB parm SCHENV
!us5sysaf = ;          8      ! Override for JOB parm SYSAFF
!us5system = ;         ! Override for JOB parm SYSTEM
!us5time = ;           ! Override for JOB parm TIME
!us5typrn = ;          ! Override for JOB parm TYPRUN
!us5user = ;           ! Override for JOB parm USER

```

1 mprdebug

Establishes the pattern that is used to create the job name for any private message regions started by users of the IMS Transaction Isolation Facility. The user's TSO ID is substituted in the string where &&user&& appears.

2 us5imrsl

Identifies the IMS RESLIB to use when tasks are performed for the IMS Transaction Isolation Facility. This parameter is necessary only when the proper IMS RESLIB is not in the link list concatenation.

This setting applies to IMS subsystems where the RESLIB is not specified with IBM z/OS Debugger Utilities option 4.6. If the client needs to use a specific RESLIB for a particular IMS subsystem, specify the RESLIB with option 4.6.

3 us5dtmod

Identifies the z/OS Debugger SEQAMOD library to use when tasks are performed for the IMS Transaction Isolation Facility. This parameter is necessary only when the proper z/OS Debugger SEQAMOD library is not in the link list concatenation.

4 us5dtce1

Identifies the z/OS MVS Language Environment runtime library (CEERUN) to use when tasks are performed for the IMS Transaction Isolation Facility. This parameter is necessary only when the proper Language Environment library is not in the link list concatenation.

5 us5trnft

Defines the default transaction name filter when a new user accesses the EQAPMPSL panel for the first time.

6 us5trnmX

Defines the default maximum number of transactions that is returned to the user on the EQAPMPSL panel. A value of 0 returns the entire list of transactions, which can have a significant performance impact if your IMS system has defined many transactions.

7 JOB parameter overrides

Use these parameters to specify or override any parameters on the JOB statement that is created based on the JOB statement of the “cloned” message region.

8 us5sysaf

User region affinity. In a Sysplex environment with shared JES spool, set this parameter to * to enable local affinity for user regions.

```
us5sysaf = *;
```

For more information about how application programmers use the IMS Transaction Isolation Facility, see the section "Using IMS Transaction Isolation to create a private message-processing region and select transactions to debug" in the *IBM z/OS Debugger User's Guide*.

Sample customization of the IMS Transaction Isolation Facility

Here is an example of the customization of IMS Transaction Isolation Facility at a typical client location. In this example, the system has the following features:

- The IMS sub system name is IMSA.
- The IMS product high-level qualifier is PROD.IMSV14.
- Dynamic Resource Definition (DRD) is active.
- The maximum number of transactions, which is defined by the MAXCLAS parameter of the IMSCTRL system definition macro, is 200.
- Dependent regions currently defined in the system serve classes in the range 21 - 100.
- The IBM z/OS Debugger data sets are installed under the high-level qualifier ZDEBUG.

The IMS administrator decides that 10 region classes are reserved for IMS Isolation users, which means that 10 users can debug in private message regions simultaneously.

As the class range 21 - 100 is used for normal development and test activity, the IMS Isolation classes must be in the range 1 - 20 and 101 - 200. The IMS administrator chooses classes 131-140 to reserve for IMS Isolation users.

Next, the IMS administrator performs the following steps to prepare the IMS control region to run with IMS Isolation:

1. Edit the ZDEBUG.SEQASAMP(EQAWTIVS) member and SUBMIT it to create the VSAM data set PROD.ZDEBUG.EQATITBL.

```

//EQAWTIVS JOB
//*****
//*          DELETE THE EXISTING FILE          *
//*****
//DELETE     EXEC PGM=IDCAMS,REGION=1M
//SYSPRINT  DD SYSOUT=*
//SYSIN     DD *
DELETE PROD.ZDEBUG.EQATITBL
SET MAXCC=0
/*
//*****
//*          DEFINE A NEW VSAM DEBUGGING PROFILE DATASET          *
//*****
//DEFINE     EXEC PGM=IDCAMS,REGION=1M
//SYSPRINT  DD SYSOUT=*
//SYSIN     DD *
/*          */
/* DEFINE IMS ISOLATION          */
/* TABLE INDEX AND PATH          */
/* DATA SETS          */
/*          */
DEFINE CLUSTER (RECORDS(999) -
NAME (PROD.ZDEBUG.EQATITBL) -
SHAREOPTIONS(2 3) -
LOG(NONE) -
INDEXED) -
DATA -
(RECSZ(200,200) -
NAME (PROD.ZDEBUG.EQATITBL.DATA) -
KEYS(11 0) -
FREESPACE(10 10) -
BUFFERSPACE (20000)) -
INDEX -
(NAME(PROD.ZDEBUG.EQATITBL.INDX))
/*

```

2. Edit the ZDEBUG.SEQASAMP(EQAWTIVS) member and submit it to link-edit the IMS Isolation exits by using the current level of IMS. The exits are placed in PROD.ZDEBUG.IMSISO.LOADLIB.

```

//EQAWTIMS JOB
// SET DTHLQ=ZDEBUG
// SET IMSHLQ=PROD.IMSV14
//*****
/* Link-edit the EQATIEDT user exit (transaction message edit)      *
//*****
//LINK1 EXEC PGM=IEWL,COND=(4,LE),REGION=17M,
// PARM=('OPTIONS=OPTIONS')
//SYSUT1 DD UNIT=SYSVIO,SPACE=(TRK,(10,80))
//SYSPRINT DD SYSOUT=*
//SYSLMOD DD DSN=PROD.ZDEBUG.IMSISO.LOADLIB,DISP=SHR
//SYSLIB DD DSN=&DTHLQ..SEQAMOD,DISP=SHR
// DD DSN=&IMSHLQ..SDFSRESL,DISP=SHR
//OPTIONS DD *
LIST,XREF,LET,MAP
//SYSLIN DD *
MODE AMODE(31),RMODE(ANY)
INCLUDE SYSLIB(DFSCSI00)
REPLACE DFSCSII0
INCLUDE SYSLIB(EQATIEDT)
ENTRY EQATIEDT
NAME EQATIEDT(R)
/*
//*****
/* Link-edit the DFSMSCE0 user exit (transaction routing)      *
//*****
//LINK2 EXEC PGM=IEWL,COND=(4,LE),REGION=17M,
// PARM=('OPTIONS=OPTIONS')
//SYSUT1 DD UNIT=SYSVIO,SPACE=(TRK,(10,80))
//SYSPRINT DD SYSOUT=*
//SYSLMOD DD DSN=PROD.ZDEBUG.IMSISO.LOADLIB,DISP=SHR
//SYSLIB DD DSN=&DTHLQ..SEQAMOD,DISP=SHR
// DD DSN=&IMSHLQ..SDFSRESL,DISP=SHR
//OPTIONS DD *
LIST,XREF,LET,MAP
//SYSLIN DD *
MODE AMODE(31),RMODE(ANY)
INCLUDE SYSLIB(DFSCSI00)
REPLACE DFSCSIF0
INCLUDE SYSLIB(EQATIEXT)
ENTRY EQATIEXT
ALIAS DFSMSCE0
NAME EQATIEXT(R)
/*

```

3. Edit the ZDEBUG.SEQASAMP(EQAOPTS) member and submit it to create the EQAOPTS load module:
 - a. Use Delay Debug in the private IMS message processing regions, with the naming pattern 'USR.<userid>.DLAYDBG.EQAUOPTS'.
 - b. Limit each IMS Isolation user to registering for four transactions.

```

//EQAOPTS JOB 5724-T07,MSGLEVEL=(1,1),MSGCLASS=A
/*PROC JCLLIB ORDER=(ASM.SASMSAM1)
// SET GPFLIB=ZDEBUG.SEQASAMP
// SET GPFLMOD=PROD.ZDEBUG.IMSISO.LOADLIB
//*
//ASMGL EXEC ASMACL,REGION=6M,PARM.L='MAP,LET,LIST,XREF,RENT'
//C.SYSLIB DD DSN=&GPFLIB.,DISP=SHR
// DD DSN=SYS1.MACLIB,DISP=SHR
//C.SYSIN DD *
EQAOPTS CSECT ,
EQAOPTS AMODE 31
EQAOPTS RMODE ANY
EQAXOPT DLAYDBGDSN,'USR.&&USERID.DLAYDBG.EQAUOPTS'
EQAXOPT MAXTRANUSER,4
EQAXOPT END
END ,
//L.SYSLMOD DD DISP=SHR,DSN=&GPFLMOD.
//L.SYSIN DD *
NAME EQAOPTS(R)
/*

```

4. Place the new data sets in the IMS control region JCL. The following customizations are required:

- a. APF-authorize the customized IMS exit and EQAOPTS load library (PROD.ZDEBUG.IMSISO.LOADLIB).
- b. Add the EQAOPTS load library to the STEPLIB concatenation. Ensure that the library is in the search path before the ZDEBUG.SEQAMOD data set.
- c. Add a new DD card called EQATIVSM for the VSAM data set created in Step 1 (PROD.ZDEBUG.EQATITBL).

```
//IMSACTAM PROC SOUT=A,DPTY='(14,15)',RGN=0M
//IEFPROC EXEC PGM=DFSMVRC0,DPRTY=&DPTY,REGION=&RGN,
// PARM='&CTL,&RGSUF,&PARM1,&PARM2'
...
//STEPLIB DD DISP=SHR,DSN=PROD.ZDEBUG.IMSISO.LOADLIB b
// DD DISP=SHR,DSN=PROD.ZDEBUG.SEQAMOD
// DD DISP=SHR,DSN=PROD.IMS.LOADLIB
...
//EQATIVSM DD DISP=SHR,DSN=PROD.ZDEBUG.EQATITBL c
...
```

5. As the client uses the DFSMSCEO IMS exit in the development and test environment, one other customization is required to ensure that DFSMSCEO of IBMz/OS Debugger takes the processing of the client exit into account. The client's DFSMSCEO is in PROD.IMSEXIT.LOADLIB.
 - a. Ensure that PROD.IMSEXIT.LOADLIB does not appear in STEPLIB or JOBLIB or that it appears in the search path after the data set containing IBM z/OS Debugger's DFSMSCEO exit, for example, PROD.ZDEBUG.IMSISO.LOADLIB.
 - b. Add a new DD card called EQAIMEXT to identify the client DFSMSCEO exit to IBM z/OS Debugger.

```
//IMSACTAM PROC SOUT=A,DPTY='(14,15)',RGN=0M
//IEFPROC EXEC PGM=DFSMVRC0,DPRTY=&DPTY,REGION=&RGN,
// PARM='&CTL,&RGSUF,&PARM1,&PARM2'
...
//EQATIVSM DD DISP=SHR,DSN=PROD.ZDEBUG.EQATITBL
//EQAIMEXT DD DISP=SHR,DSN=PROD.IMSEXIT.LOADLIB b
//*
```

6. Start the IMS control region by using the normal process.
7. A RACF administrator uses the following commands to create a new facility for administering IMS Isolation, and gives the IMS administrator, whose ID is ADMINA, READ access:

```
RDEFINE FACILITY EQADTOOL.IMSTRANISOADMIN UACC(NONE)
PERMIT EQADTOOL.IMSTRANISOADMIN CLASS(FACILITY) ID(ADMINA) ACC(READ)
SETROPTS RACLIST(FACILITY) REFRESH
```

Then, the RACF administrator uses the following commands to authorize the EQANBSWT Batch Messaging Program (BMP) to execute the ASSIGN, DISPLAY, START, and STOP IMS commands:

```
ADDUSER EQANBSWT NOPASSWORD DFLTGRP(SYS1)
PERMIT ASS CLASS(CIMS) ID(EQANBSWT) ACC(UPDATE)
PERMIT DIS CLASS(CIMS) ID(EQANBSWT) ACC(UPDATE)
PERMIT STA CLASS(CIMS) ID(EQANBSWT) ACC(UPDATE)
PERMIT STO CLASS(CIMS) ID(EQANBSWT) ACC(UPDATE)
SETROPTS RACLIST(CIMS) REFRESH
```

8. When the control region is started, the IMS administrator needs to access ISPF panel EQAPMPDF by using z/OS Debugger Utilities option 4.6. On this panel, the IMS administrator selects the classes to be reserved for debugging, 131 - 140:

```

+-----+-----+
| IMS debugging preferences                               Row 126 to 150 of 200 |
| Command ==>                                           Scroll ==> PAGE |
|
| IMS system . . . . . IMSA |
|
| Place a / next to the message classes that you would like to |
| reserve for the isolation of debug users in your IMS system. |
|
| Data set name for stage-1 resource definitions: |
|-----|
| Data set name for type-2 commands: |
|-----|
| Data set name for the IMS RESLIB: |
|-----|
|
| Sel Class number |
| - 126 |
| - 127 |
| - 128 |
| - 129 |
| / 130 |
| / 131 |
| / 132 |
| / 133 |
| / 134 |
| / 135 |
| / 136 |
| / 137 |
| / 138 |
| / 139 |
| / 140 |
| - 141 |
| - 142 |
| - 143 |
| - 144 |
| - 145 |
| - 146 |
| - 147 |
| - 148 |
| - 149 |
| - 150 |
|
| F1=Help   F3=Exit   F4=IMSIDlst  F7=Backward  F8=Forward  F12=Cancel |
+-----+-----+

```

- After selecting the classes for debug, the IMS administrator customizes ZDEBUG.SEQASAMP(EQAWICRT) and uses it to generate a data set that contains type-2 commands. These commands can be used to define resources for IMS Isolation.

```

//EQAWICRT JOB
//*
// SET DTHLQ=ZDEBUG
//DELETE EXEC PGM=IDCAMS,REGION=1M
//SYSPRINT DD SYSOUT=*
//SYSIN DD *
DELETE ADMINA.IMSISO.TYPE2
SET MAXCC=0
/*
//CREATE EXEC PGM=EQANICRT,REGION=0M,
// PARM=('READMASK IMSA')
//EQATY2DS DD DSN=ADMINA.IMSISO.TYPE2,
// DISP=(NEW,CATLG,DELETE),
// SPACE=(TRK,(20,20,0),RLSE),
// DCB=(RECFM=FB,LRECL=80,BLKSIZE=0)
//EQATISPT DD SYSOUT=*

```

- Define the following IMS batch message program:

```

APPLCTN  GPSB=EQANBSWT , LANG=ASSEM,PGMTYPE=(BATCH) ,           X
        SCHDTYP=PARALLEL
TRANSACT CODE=(EQANBSWT) ,AOI=TRAN,                             X
        MSGTYPE=(SNGLSEG, NONRESPONSE)

```

- The IMS administrator creates a JCL deck to run the batch IMS SPOC utility (CSLUSPOC) to create the resources needed by IMS Isolation.

```
//SPOCBCH JOB
//BATCH EXEC PGM=CSLUSPOC,PARM='IMSPLEX=PLEX2,F=BYCOL'
//STEPLIB DD DSN=PROD.IMSV14.SDFSRESL,DISP=SHR
//SYSPRINT DD SYSOUT=*
//SYSIN DD DSN=ADMINA.IMSISO.TYPE2,DISP=SHR
```

- The IMS administrator then makes the following ISPF customizations:

- The client keeps all PROCs that are used to create dependent IMS regions in a PROCEDURE library named PROD.IMSV14.PROCLIB. To allow the IMS Isolation Facility to access this library to generate private message regions, the IMS administrator updates ZDEBUG.SEQATLIB(EQAZPROC) to add PROD.IMSV14.PROCLIB:

```
PROD.IMSV14.PROCLIB
SYS1.PROCLIB
```

- The MVS system where IMSA executes has certain rules for jobs submitted to JES. To ensure that private message regions started by IMS Isolation conform to these rules, the IMS administrator updates PROD.ZDEBUG(EQAZDFLT) to specify overrides for various JOB parameters:

```
File Edit Edit_Settings Menu Utilities Compilers Test Help
-----
EDIT          PROD.ZDEBUG(EQAZDFLT)          - 01.06      Columns 000
Command ==>                                     Scroll =
000205 !us5adspc = ;                               ! Override for JOB parm ADDRSPC
000206 !us5bytes = ;                               ! Override for JOB parm BYTES
000207 !us5cards = ;                               ! Override for JOB parm CARDS
000208 !us5ccsid = ;                               ! Override for JOB parm CCSID
000209 !us5class = ;                               ! Override for JOB parm CLASS
000210 !us5cond = ;                                ! Override for JOB parm COND
000211 !us5group = ;                               ! Override for JOB parm GROUP
000212 !us5jeslg = ;                               ! Override for JOB parm JESLOG
000213 !us5lines = ;                              ! Override for JOB parm LINES
000214 !us5melim = ;                              ! Override for JOB parm MEMLIMIT
000215 us5msgcl = A ;                              ! Override for JOB parm MSGCLASS
000216 !us5msglv = ;                               ! Override for JOB parm MSGLEVEL
000217 us5notify = &SYSUID. ;                     ! Override for JOB parm NOTIFY
000218 !us5pages = ;                               ! Override for JOB parm PAGES
000219 !us5paswd = ;                               ! Override for JOB parm PASSWORD
000220 !us5perf = ;                                ! Override for JOB parm PERFORM
000221 !us5prty = ;                                ! Override for JOB parm PRTY
000222 !us5rd = ;                                  ! Override for JOB parm RD
000223 !us5regn = ;                                ! Override for JOB parm REGION
000224 !us5rstrt = ;                               ! Override for JOB parm RESTART
000225 !us5seclb = ;                               ! Override for JOB parm SECLABEL
000226 !us5schen = ;                               ! Override for JOB parm SCHENV
000227 !us5sysaf = ;                               ! Override for JOB parm SYSAFF
000228 !us5system = ;                              ! Override for JOB parm SYSTEM
000229 us5time = 1440 ;                             ! Override for JOB parm TIME
000230 !us5typrn = ;                               ! Override for JOB parm TYPRUN
000231 !us5user = ;                                ! Override for JOB parm USER
000232
000233
*****
```

Batch interface for the IMS Transaction Isolation Facility

There is also a batch interface that can be used to perform IMS Transaction Isolation functions. A sample of the batch interface is provided in *hlq.SEQASAMP(EQAWTBCH)*.

The batch interface invokes the program EQANIPSB and passes parameters in the PARM= string on the EXEC JCL statement. The syntax and description of each request is as follows:

REGISTER

Registers a user for a given transaction.

➤ REGISTER — tran-name — psb-name — ims-system — userid ➤

DEREGISTER

Deregisters a user for a given transaction. This request can also be used to deregister all transactions for the given user ID.

➤ DEREGISTER — tran-name — ims-system — userid ➤
ALL — ims-system — userid
*

Note: The asterisk (*) is a wild card that matches any user ID. The transactions for all the users are deregistered if the asterisk (*) is used.

START

Starts a private message region for the specified user. The message region is cloned from a message region that is designated to run the specified transaction.

➤ START — tran-name — psb-name — ims-system — userid ➤

STOP

Stops a private message region for the specified user. This request can also be used to stop all private message regions for the specified IMS system.

➤ STOP — region-name — ims-system — userid ➤
ALL — ims-system

FORCE

Stops a private message region for the specified user, even if the region is busy debugging a transaction. The region is marked as stopped in the IMS Isolation table, and is also set to “not busy”.

➤ FORCE — region-name — ims-system — userid ➤

QUERY

Dumps the contents of the in-memory IMS Transaction Isolation table. The classes reserved for IMS Transaction Isolation, the users that are assigned each class, and the transactions the users have registered for each class are displayed.

➤ QUERY — ims-system ➤

TRACE

Dumps the contents of the in-memory IMS Transaction Isolation trace.

➤ TRACE — ims-system ➤

Configuring the IMS Transaction Isolation Service API for Debug Profile Service

IMS Transaction Isolation Service API is a RESTful API supported by Debug Profile Service.

Before you begin

- Ensure that z/OS Explorer 3.2.0.13 or later and Debug Profile Service are installed and configured, and IMS Transaction Isolation Service API is installed. For more information, see [“Adding support for Debug Profile Service”](#) on page 58.
- IMS Transaction Isolation Service API has a dependency with IMS Transaction Isolation Facility, which must be enabled to operate the API. Both the IMS Transaction Isolation Service API and IMS Transaction Isolation Facility use the same in-memory IMS Transaction Isolation table to perform IMS Isolation functions. Ensure that the IMS Transaction Isolation Facility is enabled:

- [“Scenario F: Enabling the Transaction Isolation Facility” on page 130](#)
- [“Sample customization of the IMS Transaction Isolation Facility” on page 134](#)

Notes:

- The IMS Transaction Isolation Service API works by calling the EQANIPSB program to support IMS Isolation functions, and to interface with IMS subsystem. Both IMS Transaction Isolation Service API and EQANIPSB programs must be able to locate the same SEQAMOD driver in order to operate successfully.
The installation provides a sample job called `EQAW.SEQASAMP(EQAPROF)` that sets SEQAMOD in the STEPLIB of the job. Alternatively, SEQAMOD can be added in the system linked-list. Both options enable IMS Transaction Isolation Service API to locate the current EQANIPSB program. However, SEQAMOD must also be set in the `imso_dd_eqatipsb` property defined in `eqaprof.env`. This enables EQANIPSB to locate the current programs that interface with IMS. A discrepancy between SEQAMODs can cause internal errors.
- A private message processing region (MPR) may transition into a Terminated state if the in-memory IMS Transaction Isolation table expected the private region to be Started, but it discovered that it is Stopped. This can occur if the private MPR is stopped or stops unexpectedly by a process external from IMS Isolation, which causes the in-memory IMS Transaction Isolation table to be out-of-sync with the actual state of the private region. A stop request is required to re-sync the in-memory IMS Transaction Isolation table.

Procedure

1. Ensure that the protected user ID (STCEQA) that starts Debug Profile Service (EQAPROF) has READ authority to BPX.DAEMON.HFSCTL:

```
RDEFINE FACILITY BPX.DAEMON.HFSCTL UACC(NONE)
PERMIT BPX.DAEMON.HFSCTL CLASS(FACILITY) ID(STCEQA) ACCESS(READ)
SETROPTS RACLIST(FACILITY) REFRESH
```

2. Customize the following attributes in the [Debug Profile Service configuration file eqaprof.env](#):
 - `imsiso_dd_eqatipsb`
 - `imsiso_dd_syslib`
 - `imsiso_dd_sysproc`
 - `imsiso_dd_jcllib`
3. Replace the z/OS Debugger data set names, SEQAMOD, SEQAEXEC, and SEQATLIB with the installed z/OS Debugger data set names, and replace IMS.SDFSRESL with the IMS RESLIB load library for your IMS subsystem.

Installing and configuring the IMS transaction isolation extension for the ADFz Common Components server

About this task

Note: Debug Profile Service with IMS Isolation support is available since z/OS Debugger 16.0.0. This task is required only when your Eclipse IDE users cannot access IMS Isolation with Debug Profile Service to create IMS Isolation Debug Profiles. The IMS transaction isolation extension is only available in IBM Developer for z/OS Enterprise Edition.

You must create a configuration file for the IMS transaction isolation extensions for the ADFz Common Components server, and then specify the location of the configuration file to the server. You can find step-by-step procedures to run the ADFz Common Components server in the *IBM Application Delivery Foundation for z/OS Common Components Customization Guide and User Guide*.

Procedure

To configure the IMS transaction isolation extension for the ADFz Common Components server, complete the following steps:

1. Create a sequential MVS data set (FB, LRECL 80) that contains the following records:
 - a) Replace the z/OS Debugger data set names, SEQAMOD, SEQAEXEC, and SEQATLIB with the installed z/OS Debugger data set names.
 - b) Replace the ISPF data set name SISpload with the installed ISPF data set name.
 - c) Replace the IMS data set name SDFSRESL with the installed IMS data set name.

Note: Do not change other statements.

```
* IMS transaction isolation view
CONFIG=II
SPAWN_PROGRAM=EQAIINT
SPAWN_STEPLIB=EQAW.SEQAMOD:
CEE.SCEERUN:
ISP.SISPLOAD:
IMS.SDFSRESL
SPAWN_PARMS_SECTION
SPAWN_DD=EQATIPSB=EQAW.SEQAMOD:
IMS.SDFSRESL:
CEE.SCEERUN
SPAWN_DD=SYSLIB=SYS1.MACLIB
SPAWN_DD=SYSPROC=EQAW.SEQAEXEC
SPAWN_DD=JCLLIB=EQAW.SEQATLIB(EQAZPROC)
```

2. Modify the ADFz Common Components server started proc IPVSRV1.
 - a) Add the configuration data set to the CONFIG DD statement concatenation.
 - b) Set the region size parameter to 200M or 0M. For example, //RUN EXEC PGM=IPVSRV, REGION=200M.
 - c) Stop and restart the ADFz Common Components server.
3. Ensure the user ID (*ownerID*) that owns and starts the proc IPVSRV1 has the following capabilities:
 - An OMVS segment. You can use the following command to create the segment:

```
altuser ownerID omvs(home(/u/ownerID) program(/bin/sh))
```
 - Read access to BPX.SERVER. You can use the following command to add permission:

```
PE BPX.SERVER CL(FACILITY) ID(ownerID) ACC(READ)
```
4. Inform your users of remote IMS Application with Isolation launch configuration of the following information:
 - They need to choose the same encoding scheme as the character encoding scheme of your host system when they add a host connection to IMS transaction isolation extension.

Chapter 14. Enabling the EQAUEDAT user exit

The EQAUEDAT user exit enables the library administrator or system programmer to direct z/OS Debugger to the location where source, listing, or separate debug files are stored. If your site policy is to control the location of these files, this user exit supports this policy by allowing your application programmers to debug their programs without knowing where these files are located.

The provided samples are designed to operate only under Language Environment. If you require an exit to run at any time in a non-Language Environment environment, you must write the exit in assembler and replace the CEEENTRY and CEETERM macro invocations with the proper prologue and epilogue code for your environments. If z/OS Debugger detects a Language Environment-enabled EQAUEDAT when Language Environment is not active, the exit will not be started.

z/OS Debugger provides two samples: EQAUEDAT, which is written in Language Environment-enabled assembler, and EQAUEDAC, which is written in Enterprise COBOL for z/OS and OS/390. Both samples generate a load module named EQAUEDAT.

To enable this user exit, do the following steps:

1. Copy either the EQAUEDAT³⁴ or EQAUEDAC³⁵ member from the *hlq.SEQASAMP* library to a private library.
2. Edit the copy, as instructed in the member. Write the logic required to implement your site policy.

The address of the load library data set name and the length of the load library data set name cannot be provided as input to the EQAUEDAT user exit when the loading service (provider) that loaded the module is LPA, LLA, AOS loader, or an unknown provider because this information is not available when using these loading services.

3. Submit the JCL.
4. Add the private library where the generated EQAUEDAT load module is located to the load module search path for the application that you are debugging and for which you want this site policy enabled, in front of *hlq.SEQAMOD*.

³⁴ USERMOD EQAUMODF is provided for updating EQAUEDAT. See "SMP/E USERMODs" in the *IBM z/OS Debugger Customization Guide* for an SMP/E USERMOD for this customization.

³⁵ USERMOD EQAUMODJ is provided for updating EQAUEDAC. See "SMP/E USERMODs" in the *IBM z/OS Debugger Customization Guide* for an SMP/E USERMOD for this customization.

Chapter 15. Using EQACUIDF to specify values for NATLANG, LOCALE, and LINECOUNT

Note: This chapter is not applicable to IBM Developer for z/OS (non-Enterprise Edition) or IBM Z and Cloud Modernization Stack (Wazi Code).

The EQACUIDF member of *hlq*.SEQABMOD contains the default and allowable values for the parameters NATLANG, LOCALE, and LINECOUNT. These values are used by the following z/OS Debugger components:

- IBM z/OS Debugger Utilities ISPF dialogs: NATLANG
- EQANMDBG (non-CICS non-Language Environment support): NATLANG
- z/OS Debugger Code Coverage: NATLANG, LOCALE, and LINECOUNT

This topic describes the allowable values for these parameters, how to change the default values, and how to enable additional languages for some z/OS Debugger components.

Changing the default and allowable values in EQACUIDF

The default and allowable values for NATLANG, LOCALE, and LINECOUNT are as follows:

- NATLANG. The national language, which can be one of the following:
 - Mixed-case English (ENU)
 - Uppercase English (UEN)
 - Japanese (JPN)
 - Korean (KOR)

See “Enabling additional languages for some z/OS Debugger components through EQACUIDF” on page 146 for more information about changing the language for these z/OS Debugger components.

- LOCALE. The format of date, time, and numeric values. You can also create date, time, and numeric formats. The default values are as follows:
 - Date format: MM/DD/YYYY
 - Time format: HH:MM:SS
 - Numeric format: 1,234,567.89
- LINECOUNT. The number of lines (including headings) that print on a page. The default is 66 lines.

If the default values for these parameters are the values that you want to use, you can skip this section.

To change the default values:

1. Copy the EQACUIDF³⁶ member in the *hlq*.SEQASAMP data set into another data set.
2. Follow the instructions that are in the comment sections of the code to modify the copy that you made.
3. Assemble the modified copy by using the IBM High Level Assembler and specifying *hlq*.SEQASAMP as a SYSLIB.
4. Link edit the resulting object into the *private*.SEQABMOD data set.
5. Copy the output load module to *hlq*.SEQABMOD.

Sample JCL is provided in the EQACUIID member of the *hlq*.SEQASAMP data set to perform steps “3” on page 145 and “4” on page 145.

³⁶ USERMOD EQAUMOD9 is provided for updating EQACUIDF. See “SMP/E USERMODs” in the *IBM z/OS Debugger Customization Guide* for an SMP/E USERMOD for this customization.

The SEQABMOD from this version of z/OS Debugger is compatible with earlier versions of z/OS Debugger. If you have multiple versions of z/OS Debugger installed on your system, you need only the SEQABMOD from this version installed in your system link list concatenation.

Enabling additional languages for some z/OS Debugger components through EQACUIDF

If you use these components, and have installed either of the additional language features (Japanese or Korean), you must do the following steps to enable the user to specify the additional language feature with the NATLANG parameter.

To change the language to Japanese or Korean:

1. Create a private SEQASAMP data set like *hlq.SEQASAMP*.
2. Create a private SEQABMOD data set like *hlq.SEQABMOD*.
3. Copy members EQACUIDF³⁷, EQACUIDM³⁸, and EQACUIID from *hlq.SEQASAMP* to your private SEQASAMP. Any edits that are described in this section are to be done in the private SEQASAMP copies of these members.
4. Edit the EQACUIDM member and add each additional installed language feature to the line starting with &ValLang(1), using JPN for Japanese, and KOR for Korean. For example, adding Japanese would be done as follows:

```
&ValLang(1) SetC 'ENU','UEN','JPN' Set valid languages
```

5. Edit the EQACUIDF member and add each additional installed language feature after the following line:

```
UEN Language UEN
```

For example:

```
UEN Language UEN  
JPN Language JPN
```

6. If you want to change the default value for NATLANG, edit the EQACUIDF member and change the DflLang value. For example, making JPN the default for NATLANG would be as follows:

```
EQACUIDF InstDflt DflLang=JPN, +
```

7. Assemble and link a new copy of EQACUIDF into the private SEQABMOD by editing and submitting the JCL that is supplied in member EQACUIID.
8. Copy the EQACUIDF member from the private SEQABMOD into *hlq.SEQABMOD*.

For more information, see [“Changing the default and allowable values in EQACUIDF” on page 145](#).

³⁷ USERMOD EQAUMOD9 is provided for updating EQACUIDF. See "SMP/E USERMODs" in the *IBM z/OS Debugger Customization Guide* for an SMP/E USERMOD for this customization.

³⁸ USERMOD EQAUMODA is provided for updating EQACUIDM. See "SMP/E USERMODs" in the *IBM z/OS Debugger Customization Guide* for an SMP/E USERMOD for this customization.

Chapter 16. EQAOPTS commands

EQAOPTS commands are commands that alter some of the basic behavior of z/OS Debugger. These commands must be processed before normal z/OS Debugger command processing is available. You can specify most EQAOPTS commands in the following ways:

- Add dynamically at run time, as described in [“Providing EQAOPTS commands at run time”](#) on page 155, a text data set that contains the commands.
- Add to the search sequence, before the copy of EQAOPTS distributed by z/OS Debugger, a customized version of the EQAOPTS load module.

If you want the commands to apply to only a few debugging sessions, it might be easier to supply the EQAOPTS command dynamically at run time. If you want the commands to apply to a group of debugging sessions, it might be better to supply the EQAOPTS commands through the EQAOPTS load module.

Except for commands that can be validly specified more than once (for example, the NAMES commands), if z/OS Debugger finds a command more than once, it uses the first specification of the command. z/OS Debugger processes EQAOPTS commands specified at run time before those specified through the EQAOPTS load module. This means that commands specified at run time override duplicate commands specified in the EQAOPTS load module.

Any or all of the following people can create EQAOPTS specifications:

- The system programmer that installs z/OS Debugger.
- Specific groups in the organization.
- An individual user.

If you are the system programmer or you are creating EQAOPTS specifications for specific groups, you might change the EQAOPTS specifications less frequently, so specifying them by generating a new EQAOPTS load module might be more efficient. If you are an individual user, you might change the EQAOPTS specifications more frequently, so specifying them dynamically at run time might be more efficient.

Table 28 on page 147 summarizes the available EQAOPTS commands and indicates whether a system programmer (S), a specific group (G), or an individual user (U) most commonly uses a command.

Table 28. A brief description of each EQAOPTS command and the type of user most likely to use that command

Command	Description	Commonly used by
ALTDISP	Controls whether to add a character indicator to the MFI screen to indicate a breakpoint, the current line, or the line with found text.	S, U
BROWSE	Allows users with the authority to use z/OS Debugger in normal mode to restrict their access to Browse Mode.	U
CACHENUM	Controls the size of the z/OS Debugger cache to minimize rereading the debug information.	U, G
CCOUTPUTDSN	Specifies the default naming pattern that z/OS Debugger uses to name the Code Coverage Observation file.	U, G, S
CCOUTPUTDSNALLOC	Specifies the allocation parameters that z/OS Debugger uses when it creates the Code Coverage Observation file.	U, G, S
CCPROGSELECTDSN	Specifies the default naming pattern that z/OS Debugger uses to name the Code Coverage Options file.	U, G, S

Table 28. A brief description of each EQAOPTS command and the type of user most likely to use that command (continued)

Command	Description	Commonly used by
CEEREACTAFTERQDBG	Restarts z/OS Debugger if a CEETEST call is encountered after you use QUIT DEBUG to end a debug session.	S
CICSASMPGMND	Allows users to debug assembler programs on CICS when the language is not defined.	S
CODEPAGE	Controls the codepage used by z/OS Debugger.	U, G, S
COMMANDSDSN	Specifies the default naming pattern that z/OS Debugger uses to name the user's commands file.	U, G, S
DEFAULTVIEW	Controls the default view of assembler programs.	U, G
DISABLERLIM	Disables Omegamon resource limiting (RLIM) during debug sessions.	S
DLAYDBG	Allows users to use delay debug mode.	U, G, S
DLAYDBGEND	Specifies monitoring condition events in the delay debug mode.	U, G, S
DLAYDBGDSN	Specifies delay debug profile data set naming pattern.	U, G, S
DLAYDBGTRC	Specifies delay debug pattern match trace message level.	U, G, S
DLAYDBGXRF	Specifies that z/OS Debugger uses a cross reference to find the user ID when z/OS Debugger constructs the delay debug profile data set name. This is used when an IMS transaction or DB/2 stored procedure is initiated from the web or MQ gateway, and thus the transaction is run with a generic ID. z/OS Debugger uses either the cross reference file or the Terminal Interface Manager repository to find the ID of the user who wants to debug the transaction or stored procedure.	U, G, S
DTCNDELETEDEADPROF	Controls the deletion of dead DTCN profiles.	S
DTCNFORCExxxx	Controls whether to require certain fields in DTCN.	S
DYNDEBUG	Controls the initial (default) value of SET DYNDEBUG.	U, G, S
EQAQPP	Enables z/OS Debugger to debug MasterCraft Q++ programs.	U, G, S
EXPLICITDEBUG	Enables explicit debug mode.	U
GPFDNS	Specifies that z/OS Debugger process a global preferences file.	U, G, S
HOSTPORTS	Specifies a host port or range of ports to use for a TCP/IP connection to the workstation for the remote debugger.	S
IGNOREODOLIMIT	Specifies that z/OS Debugger can display COBOL table data items even when an ODO value is out of range.	U, G, S
LDDAUTOLANGX	Controls whether LDD is automatically run on LangX COBOL compile units.	U
LOGDSN	Specifies the default naming pattern that z/OS Debugger uses to name the user's log file.	U, G, S

Table 28. A brief description of each EQAOPTS command and the type of user most likely to use that command (continued)

Command	Description	Commonly used by
LOGDSNALLOC	Specifies the allocation parameters that z/OS Debugger uses when it creates the log file.	U, G, S
MAXTRANUSER	Specifies the maximum number of IMS transactions that a single user may register to debug using the IMS Transaction Isolation Facility.	S
MDBG	Allows users of programs compiled with z/OS XL C/C++ Version 1.10, or later, to indicate whether z/OS Debugger searches for .mdbg files.	U, G
MULTIPROCESS	Controls the behavior of z/OS Debugger when a new POSIX process is created by fork() or exec().	U, G, S
NAMES	Controls whether z/OS Debugger processes or ignores certain load module or compile unit names.	U, G
NODISPLAY	Controls the z/OS Debugger behavior when the display requested by the z/OS Debugger user is not available.	U, G, S
PREFERENCESDSN	Specifies the default naming pattern that z/OS Debugger uses to name the preferences file.	U, G, S
SAVEBPDSN, SAVESETDSN	Specifies the default naming pattern for the data sets used to save and restore the breakpoints and monitors (SAVEBPS) and the settings (SAVESETS).	U, G, S
SAVEBPDSNALLOC, SAVESETDSNALLOC	Specifies the allocation parameters that z/OS Debugger uses when it creates the SAVEBPS and SAVESETS data sets.	U, G, S
SESSIONTIMEOUT	Establishes a timeout for idle z/OS Debugger sessions that use the Terminal Interface Manager. Timed out sessions are canceled after a specified period of no user activity.	S
STARTSTOPMSG	Controls whether to issue a message when each debugging session is initiated or terminated.	S
STARTSTOPMSGDSN	Specifies a message file for start and stop debug session messages.	S
SUBSYS	Specifies a subsystem used by certain library systems.	G, S
SVCSCREEN	Controls whether and how z/OS Debugger uses SVC screening to intercept LOAD and LINK SVC's. This is necessary for debugging non-Language Environment assembler and LangX COBOL programs.	S
TCPIPDATAADS	Instructs z/OS Debugger to dynamically allocate the specified file-name to the DDNAME SYSTCPD for the TCP/IP connection to the workstation for the remote debugger.	S
THREADTERMCOND	Controls whether z/OS Debugger prompts the user when it encounters a FINISH, enclave termination, or thread termination condition.	U, G
TIMACB	Specifies that the z/OS Debugger Terminal Interface Manager (TIM) use a name other than EQASESSM.	S

Table 28. A brief description of each EQAOPTS command and the type of user most likely to use that command (continued)

Command	Description	Commonly used by
END	Specifies the end of a list of EQAOPTS commands. You must specify END.	U, G, S

Use the following list to help you record the commands and value you want to implement:

- EQAXOPT ALTDISP, then select one of the following options:
 - ON
 - OFF
- EQAXOPT BROWSE, then select one of the following options:
 - RACF
 - ON
 - OFF
- EQAXOPT CACHENUM, *number*:_____
- EQAXOPT CCOUPTUTDSN, '*file_name_pattern*:_____ '

Append , LOUD if you want z/OS Debugger to display WTO messages, which helps you debug processing done by this command.
- EQAXOPT CCOUPTUTDSNALLOC, *allocation_parameters*:_____

Append , LOUD if you want z/OS Debugger to display WTO messages, which helps you debug processing done by this command.
- EQAXOPT CCPRGSELECTDSN, '*file_name_pattern*:_____ '

Append , LOUD if you want z/OS Debugger to display WTO messages, which helps you debug processing done by this command.
- EQAOPTS CEEREAFTERQDBG, then select one of the following options:
 - YES
 - NO
- EQAOPTS CICSASMPGMND, then select one of the following options:
 - YES
 - NO
- EQAXOPT CODEPAGE, *code_page_number*:_____
- EQAXOPT COMMANDSDSN, '*file_name_pattern*:_____ '

Append , LOUD if you want z/OS Debugger to display WTO messages, which helps you debug processing done by this command.
- EQAXOPT DEFAULTVIEW, then select one of the following options:
 - STANDARD
 - NOMACGEN
- EQAXOPT DISABLERLIM, then select one of the following options:
 - YES
 - NO
- EQAXOPT DLAYDBG, then select one of the following options:
 - YES
 - NO
- EQAXOPT DLAYDBGEND, then select one of the following options:

- YES
- NO
- EQAXOPT DLAYDBGDSN, 'file_name_pattern:_____ '
- EQAXOPT DLAYDBGTRC, pattern_match_trace_level:_____
- EQAXOPT DLAYDBGXRF, then select one of the following options:
 - DSN, 'file_name:_____ '
 - REPOSITORY
- EQAXOPT DTCNDELETEDEADPROF, then select one of the following options:
 - YES
 - NO
- EQAXOPT DTCNFORCECUID, then select one of the following options:
 - YES
 - NO

This option performs the same function as DTCNFORCEPROGID. If you select YES for DTCNFORCEPROGID, you do not need to specify this option.
- EQAXOPT DTCNFORCEIP, then select one of the following options:
 - YES
 - NO
- EQAXOPT DTCNFORCELOADMODID, then select one of the following options:
 - YES
 - NO
- EQAXOPT DTCNFORCENETNAME, then select one of the following options:
 - YES
 - NO
- EQAXOPT DTCNFORCEPROGID, then select one of the following options:
 - YES
 - NO
- EQAXOPT DTCNFORCETERMID, then select one of the following options:
 - YES
 - NO
- EQAXOPT DTCNFORCETRANID, then select one of the following options:
 - YES
 - NO
- EQAXOPT DTCNFORCEUSERID, then select one of the following options:
 - YES
 - NO
- EQAXOPT DYNDEBUG, then select one of the following options:
 - ON
 - OFF
- EQAXOPT EQAQPP, then select one of the following options:
 - ON
 - OFF
- EQAXOPT EXPLICITDEBUG, then select one of the following options:
 - ON

- OFF
- EQAXOPT GPFDSN, '*file_name*:_____'
- EQAXOPT HOSTPORTS, *range_of_ports*:_____
- EQAXOPT IGNOREODOLIMIT, then select one of the following options:
 - YES
 - NO
- EQAXOPT LDDAUTOLANGX, then select one of the following options:
 - COBOL
 - OFF
- EQAXOPT LOGDSN, '*file_name_pattern*:_____'
- Append ,LOUD if you want z/OS Debugger to display WTO messages, which helps you debug processing done by this command.
- EQAXOPT LOGDSNALLOC, *allocation_parameters*:_____
- Append ,LOUD if you want z/OS Debugger to display WTO messages, which helps you debug processing done by this command.
- EQAXOPT MAXTRANUSER, *number*:_____
- EQAXOPT MDBG, then select one of the following options:
 - YES
 - NO
- EQAXOPT MULTIPROCESS, then select one of the following options:
 - PARENT
 - CHILD
 - PROMPT
- Select one of the following options to indicate what you want z/OS Debugger to do with a process that executes itself:
 - EXEC=ANY
 - EXEC=NONE
- EQAXOPT NAMES, then select one of the following options:
 - EXCLUDE, LOADMOD, *pattern*:_____
 - EXCLUDE, CU, *pattern*:_____
 - INCLUDE, LOADMOD, *name*:_____
 - INCLUDE, CU, *name*:_____
- EQAXOPT NODISPLAY, then select one of the following options:
 - DEFAULT
 - QUITDEBUG
- EQAXOPT PREFERENCESDSN, '*file_name_pattern*:_____'
- Append ,LOUD if you want z/OS Debugger to display WTO messages, which helps you debug processing done by this command.
- EQAXOPT SAVEBPDSN, '*file_name_pattern*:_____'
- EQAXOPT SAVESETDSN, '*file_name_pattern*:_____'
- EQAXOPT SAVEBPDSNALLOC, *allocation_parameters*:_____
- Append ,LOUD if you want z/OS Debugger to display WTO messages, which helps you debug processing done by this command.
- EQAXOPT SAVESETDSNALLOC, *allocation_parameters*:_____

Append , LOUD if you want z/OS Debugger to display WTO messages, which helps you debug processing done by this command.

- EQAXOPT SESSIONTIMEOUT, then select one of the following options:

NEVER
QUITDEBUG, *hhmmssnn*
QUIT, *hhmmssnn*

- EQAXOPT STARTSTOPMSG, then select one of the following options:

NONE
ALL
CICS
TSO
BATCHTSO
IMS
OTHER

or any of CICS, TSO, BATCHTSO, IMS, and OTHER, or all of them enclosed in parenthesis and separated by commas.

Append , WTO if you want z/OS Debugger to display the messages via WTO.

- EQAXOPT STARTSTOPMSGDSN, '*file_name*: _____'

Append , LOUD if you want z/OS Debugger to display WTO messages, which helps you debug processing done by this command.

- EQAXOPT SUBSYS, *subsystem_name*: _____

- EQAXOPT SVCSCREEN, then select one of the following options:

ON
OFF
(OFF, QUIET)

Select one of the following options to indicate what you want z/OS Debugger to do if there is an existing SVC screening environment:

CONFLICT=OVERRIDE
CONFLICT=NOOVERRIDE

Select one of the following options to indicate whether you want z/OS Debugger to temporarily replace the existing SVC screening environment:

NOMERGE
MERGE=(COPE)

- TCPIPDATADSN, '*file_name*: _____'

- EQAXOPT THREADTERMCOND, then select one of the following options:

PROMPT
NOPROMPT

- EQAXOPT TIMACB, *ACB_name*: _____

- EQAXOPT END Always specify this command.

After you have made all of your selections, define the options as described in [“Creating EQAOPTS load module”](#) on page 155.

Format of the EQAOPTS command

When you specify EQAOPTS commands through the EQAOPTS load module, you create them as assembler macro invocations and you must subsequently assemble and link-edit them into the EQAOPTS load module. To provide a consistent format for all forms of EQAOPTS commands, when you specify the

EQAOPTS commands at run time, you must use the assembler macro invocation format. The following format rules apply to all EQAOPTS commands:

- EQAOPTS commands must be contained in fixed-length, eighty-byte records.
- The commands must be contained between columns one and seventy-one, with column seventy-two reserved for a continuation indicator. z/OS Debugger ignores columns seventy-three through eighty.
- Specify an asterisk (*) in column one to indicate a comment. z/OS Debugger ignores comments. Column one must be blank for all non-comment statements.
- The op-code for each EQAOPTS statement must be EQAXOPT and must begin in or after column two and followed by at least one blank.
- A list of one or more operands must follow the EQAXOPT op-code. Separate these operands by a comma and do not embed blanks.
- If a command exceeds the length of one line, you can continue the command in one of the following ways:
 - You can end at the comma following an operand and place a non-blank character in column seventy-two.
 - You can use all of the columns through column seventy-one and place a non-blank character in column seventy-two.

In either case, the statement that follows must be blank in columns one through fifteen and begin in column sixteen.

EQAOPTS commands that have equivalent z/OS Debugger commands

Some EQAOPTS commands have equivalent z/OS Debugger commands. [Table 29 on page 154](#) shows a few examples.

EQAOPTS command	z/OS Debugger command
DEFAULTVIEW	SET DEFAULTVIEW
DYNDEBUG	SET DYNDEBUG
EXPLICITDEBUG	SET EXPLICITDEBUG
NAMES	NAMES

For these commands, specifying them as EQAOPTS commands or z/OS Debugger commands produces the same action. The timing (when these commands take effect) differs between EQAOPTS commands and z/OS Debugger commands.

z/OS Debugger processes z/OS Debugger commands after it processes the initial load module and creates the compile units contained in the initial load modules. z/OS Debugger processes EQAOPTS commands during z/OS Debugger initialization, prior to processing the initial load module. This means that when z/OS Debugger processes the initial load module, z/OS Debugger commands like NAMES are not in effect but the corresponding EQAOPTS commands are in effect and are applied to the initial load module.

EQAOPTS commands like DEFAULTVIEW provide a way of specifying a site- or group-wide default for the corresponding z/OS Debugger command. However, a better way to specify a site- or group-wide default for these types of commands is by putting the z/OS Debugger command in a global preferences file.

Providing EQAOPTS commands at run time

You can provide EQAOPTS commands to z/OS Debugger at run time. You must save the commands in a data set with 80-byte, fixed-length records. The following list describes the methods of specifying this data set to z/OS Debugger:

- In CICS, include the EQAOPTS commands through DTCN.
- In UNIX System Services, specify the name of the data set containing the EQAOPTS commands through the EQA_OPTS_DSN environment variable.
- In IMS and Db2, specify the name of the data set containing the EQAOPTS commands in the Language Environment user exit or debug profile by using DTU option 6 or B, Terminal Interface Manager, or the z/OS Debugger Profiles view in the Eclipse IDE or the z/OS Debugger Profiles view provided with Z Open Debug.
- In other environments, specify the name of the data set containing the commands through the EQAOPTS DD statement.

The following example shows what the data set might contain:

```
EQAXOPT  MDBG,YES
EQAXOPT  NODISPLAY,QUITDEBUG
EQAXOPT  NAMES,EXCLUDE,LOADMOD,USERMOD1
EQAXOPT  NAMES,EXCLUDE,LOADMOD,USERMOD7
EQAXOPT  END
```

The instructions in “Creating EQAOPTS load module” on page 155 contain examples with specifications for CSECT, AMODE, RMODE, and END (without EQAXOPTS) statements. Do not include these specifications if you provide EQAOPTS command at run time.

Creating EQAOPTS load module

If you have chosen to use the EQAOPTS load module to specify your EQAOPTS commands, do the following steps:

1. Copy the EQAOPTS³⁹ member from the *hlq*.SEQASAMP library to a private library.
2. Edit this copy of EQAOPTS and code the EQAOPTS command or commands you want. To this minimum source, add each EQAXOPT option you want to include. The following example describes the minimum assembler source required to generate the EQAOPTS load module:

```
EQAOPTS  CSECT ,
EQAOPTS  AMODE 31
EQAOPTS  RMODE ANY
          Add your customized EQAXOPT statements here. For example:
EQAXOPT  MDBG,YES
EQAXOPT  NODISPLAY,QUITDEBUG
EQAXOPT  NAMES,EXCLUDE,LOADMOD,USERMOD1
EQAXOPT  NAMES,EXCLUDE,LOADMOD,USERMOD7
EQAXOPT  END
END ,
```

Note: You can specify AMODE 64. However, AMODE 64 does not support Delay Debug for 64-bit applications. For more information, see the "Limitations of 64-bit support in remote debug mode" topic in *IBM z/OS Debugger User's Guide* or *IBM z/OS Debugger Reference and Messages*.

3. Follow the directions in the EQAOPTS sample to generate a new EQAOPTS load module. These directions describe how to assemble the source and link-edit the generated object into a load module named EQAOPTS.
4. Place the EQAOPTS load module in a private data set that is in the load module search path and appears before *hlq*.SEQAMOD.

³⁹ USERMOD EQAUMODE is provided for updating EQAOPTS. See "SMP/E USERMODs" in the *IBM z/OS Debugger Customization Guide* for an SMP/E USERMOD for this customization.

Descriptions of EQAOPTS commands

To learn how EQAOPTS commands work and how to specify them, see [Chapter 16, “EQAOPTS commands,”](#) on page 147.

ALTDISP

You can use the EQAOPTS ALTDISP command to add a character indicator to the MFI screen to indicate a breakpoint, the current line, or the line with found text. By default, z/OS Debugger uses coloring to indicate these situations.

Use this command only if your 3270 color configuration and attributes make it difficult to detect the coloring in the line. It is valid only when you are using interactive MFI mode.

The following diagram describes the syntax of the ALTDISP command:

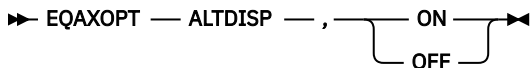

The following list describes the parameters of the EQAOPTS ALTDISP command:

ON

Indicates to add a character indicator to indicate a breakpoint, the current line, or the line with found text.

OFF

Indicates not to add a character indicator to indicate a breakpoint, the current line, or the line with found text. This is the default value.

Example

```
EQAXOPT ALTDISP,ON
```

BROWSE

z/OS Debugger browse mode can be controlled by either the browse mode RACF facility, through the EQAOPTS BROWSE command, or both. For a description of how to control browse mode through RACF, see "Debugging in browse mode" in the *IBM z/OS Debugger User's Guide*.

Users who have sufficient RACF authority can specify the EQAOPTS BROWSE command to indicate that the current invocation of z/OS Debugger be in browse mode.

The following diagram describes the syntax of the BROWSE command:

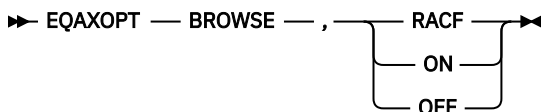

The following list describes the parameters of the EQAOPTS BROWSE command:

RACF

Indicates that you want z/OS Debugger to use the browse mode access as determined by the current user's RACF access to the applicable RACF profile. If you do not specify the BROWSE command, z/OS Debugger defaults to RACF.

ON

Indicates that unless the user's RACF access is NONE, set BROWSE MODE to ON.

OFF

Indicates that if no RACF profile exists or if the user has UPDATE access or higher, set BROWSE MODE to OFF.

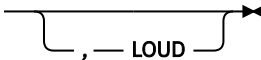
►► EQAXOPT — CCOUPTUTDSNALLOC — , — ' — *allocation_parms* — ' — 

allocation_parms

Specifies the allocation parameters you want z/OS Debugger to use when it creates the data set. You can specify only the keys in the following list:

- BLKSIZE
- BLOCK
- CYL
- DATACLAS
- DSNTYPE
- DSORG
- LRECL
- MGMTCLAS
- RECFM
- SPACE
- STORCLAS
- TRACKS
- UNIT
- VOL

Separate the keys by one or more blanks. z/OS Debugger does not provide defaults for any of the keys.

For information about the format of the keys, see the chapter "BPXWDYN: a text interface to dynamic allocation and dynamic output" in the *z/OS Using REXX and z/OS UNIX System Services* manual.

Specify that the data set be sequential. To learn about other formatting rules for the log file, see "Data sets used by z/OS Debugger" of the IBM z/OS Debugger User's Guide.

LOUD

Specifies that z/OS Debugger displays WTO messages, which helps you debug processing done by this command. z/OS Debugger normally does not display any messages when it creates this data set. If you are trying to determine why this file was not created, specify LOUD to view any messages.

CCPROGSELECTDSN

This option provides the data set name that contains the Code Coverage Options file (which specifies the Group IDs and the PROGRAM IDs of the COBOL routines that are to be processed). Specify NULLFILE if no Code Coverage Options file is to be read.

This dataset must be preallocated as a sequential dataset. RECFM=VB, LRECL=255 is suggested.

The following diagram describes the syntax of the CCPROGSELECTDSN command:

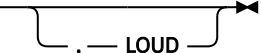
►► EQAXOPT — CCPROGSELECTDSN — , — ' — *file_name_pattern* — ' — 

file_name_pattern

Specifies a naming pattern that determines the name of the data set that contains this file. Follow these guidelines when you create the naming pattern:

- Create a data set name that includes &&USERID. as one of the qualifiers. z/OS Debugger substitutes the user ID of the current user for this qualifier when it determines the name of the data set.
- Specify NULLFILE to indicate you do not want z/OS Debugger to process this file.

CODEPAGE

The default code page used by z/OS Debugger and the remote debuggers is 037. For any of the following situations, you need to use a different code page:

- Application programmers are debugging in remote debug mode and the source or compiler use a code page other than 037.

If your C/C++ source contains square brackets or other special characters, you might need to specify an EQAOPTS CODEPAGE command to override the z/OS Debugger default code page (037). Check the code page specified when you compiled your source. The C/C++ compiler uses a default code page of 1047 if you do not explicitly specify one. If the code page used is 1047 or a code page other than 037, you need to specify an EQAOPTS CODEPAGE command specifying that code page.

- Application programmers are debugging in full screen mode and encounter one of the following situations:

- They use the STORAGE command to update COBOL NATIONAL variables.
- The source is coded in a code page other than 037.

- Application programmers use the XML(CODEPAGE(ccsid)) parameter on a LIST CONTAINER or LIST STORAGE command to specify an alternate code page.

z/OS Debugger uses the z/OS Unicode Services to process characters that need code page conversion.

The following diagram describes the syntax of the CODEPAGE command:

►► EQAXOPT — CODEPAGE — , — nnnn ◄◄

nnnn

A positive integer indicating the code page to use.

After implementing the EQAOPTS CODEPAGE command, if application programmers using full-screen mode still cannot display some characters correctly, have them verify that their emulator's code page matches the code page of the characters they need to display.

You might need to create your own conversion images as described in [“Creating a conversion image for z/OS Debugger”](#) on page 160.

Example

```
EQAXOPT CODEPAGE,121
```

Creating a conversion image for z/OS Debugger

You might need to create a conversion image so that z/OS Debugger can properly transmit characters in a code page other than 037 between the remote debugger and the host. A conversion image contains the following information:

- The conversion table that specifies the source CCSID (Coded Character Set Identifiers) and target CCSID. For z/OS Debugger, specify a pair of conversion images between the host code page and Unicode code page (UTF-8). You can specify the host code page in the CODEPAGE command in the EQAOPTS data set. The following table shows the images required for CCSIDs 930, 939 (Japanese EBCDIC), 933 (Korean EBCDIC), 1141 (Germany EBCDIC), and 1047 (Latin 1/Open Systems, EBCDIC).

CODEPAGE command	Source CCSID	Target CCSID
CODEPAGE,930	1390 ¹	1208 (UTF-8)
	1208	1390 ¹

Table 30. Source and target CCSID to specify, depending on the code page command used (continued)

CODEPAGE command	Source CCSID	Target CCSID
CODEPAGE,939	1399 ¹	1208 (UTF-8)
	1208	1399 ¹
CODEPAGE,933	933	1208 (UTF-8)
	1208	933
CODEPAGE,1141	1141	1208 (UTF-8)
	1208	1141
CODEPAGE,1047	1047	1208 (UTF-8)
	1208	1047
Note:		
1. For compatibility with earlier versions, 1390 and 1399 are used.		

For each suboption, a pair of conversion images are needed for bidirectional conversion.

- The conversion technique, also called the technique search order. z/OS Debugger uses the technique search order RECLM, which means roundtrip, enforced subset, customized, Language Environment-behavior, and modified language. RECLM is the default technique search order, so you do not have to specify the technique search order in the JCL.

You might need to create a conversion image so that users debugging COBOL programs in full screen or batch mode can modify NATIONAL or UTF-8 variables with the STORAGE command or to properly display C/C++ variables that contain characters in a code page other than 037. To create the conversion image, you need to do the following steps:

1. Ask your system programmer for the host's CCSID.
2. Submit a JCL job that specifies the conversion image between the host CCSID, which you obtained in step “1” on page 161, and CCSID 1200 (UTF-16).

“Example: JCL for generating conversion images” on page 161 describes how one JCL creates the conversion images for both situations.

Example: JCL for generating conversion images

The following JCL generates the conversions images required for z/OS Debugger.

This JCL is a variation of the JCL located at *h1q*. SCUNJCL (CUNJIUTL), which is provided by the Unicode conversion services package.

```
//CUNMIUTL EXEC PGM=CUNMIUTL
//SYSPRINT DD SYSOUT=*
//SYSUDUMP DD SYSOUT=*
//SYSIMG DD DSN=UNI.IMAGES(CUNIMG01),DISP=SHR
//TABIN DD DSN=UNI.SCUNTB1,DISP=SHR
//SYSIN DD *
/*****
/* Conversion image input for z/OS Debugger in Remote          */
/* debug mode                                                  */
/*****
CONVERSION 1390,1208; /* IBM-930 to UTF-8,RECLM */
CONVERSION 1208,1390; /* UTF-8 to IBM-930,RECLM */
CONVERSION 1399,1208; /* IBM-939 to UTF-8,RECLM */
CONVERSION 1208,1399; /* UTF-8 to IBM-939,RECLM */
CONVERSION 933,1208; /* IBM-933 to UTF-8,RECLM */
CONVERSION 1208,933; /* UTF-8 to IBM-933,RECLM */
CONVERSION 1141,1208; /* IBM-1141 to UTF-8,RECLM */
CONVERSION 1208,1141; /* UTF-8 to IBM-1141,RECLM */
CONVERSION 1047,1208; /* IBM-1047 to UTF-8,RECLM */
CONVERSION 1208,1141; /* UTF-8 to IBM-1141,RECLM */
```

```

/*****
/* Conversion image input for z/OS Debugger to modify COBOL NATIONAL*/
/* variables with the STORAGE command while in full screen mode */
/*****
CONVERSION 0037,1200; /*IBM-37 to UTF-16,RECLM */
/*

```

z/OS Debugger uses the character conversion services but not the case conversion or the normalization services of Unicode conversion services. You do not need to include CASE or NORMALIZE control statements unless other applications require them.

COMMANDSDSN

Indicates that you want z/OS Debugger to read a user's commands file (with the name of the data set containing the commands file determined by the specified naming pattern) each time it starts. This works in the following situation:

- You do not specify a data set name or DD name for the user's commands file using any other method; for example, the TEST runtime option.
- You or your site specifies the EQAOPTS COMMANDSDSN command.
- The data set specified by the EQAOPTS COMMANDSDSN command exists and contains a member whose name matches the initial load module name in the first enclave.

The following diagram describes the syntax of the COMMANDSDSN command:

```

▶▶ EQAXOPT — COMMANDSDSN — , — ' — file_name_pattern — ' — LOUD

```

file_name_pattern

Specifies a naming pattern that determines the name of the data set that contains the user's commands file. Follow these guidelines when you create the naming pattern:

- Create a data set name that includes &&USERID. as one of the qualifiers. z/OS Debugger substitutes the user ID of the current user for this qualifier when it determines the name of the data set.
- Specify NULLFILE to indicate you do not want z/OS Debugger to process a commands file.

LOUD

Specifies that z/OS Debugger display WTO messages, which helps you debug processing done by this command. z/OS Debugger normally does not display any messages if it does not find the data set or data set member. If you are trying to determine why z/OS Debugger is not processing a user's commands file, specify LOUD to see if it displays a message that it cannot find the data set or the member.

If you choose to implement this option, users who want to use this function must create the commands file as a PDS or PDSE with the allocation parameters that are described in "Data sets used by z/OS Debugger" in the *IBM z/OS Debugger User's Guide*. Then, users create a member for each program that they want to debug, with the name of the member matching the initial load module name in the first enclave.

Example

```
EQAXOPT  COMMANDSDSN, '&&USERID.DBGTOOL.COMMANDS'
```

If you log in with user ID USERIBM, z/OS Debugger determines the name of the data set to be USERIBM.DBGTOOL.COMMANDS.

DEFAULTVIEW

A user can control whether to display the statements of an assembler macro in the Source window by entering the SET DEFAULT VIEW command. Every time a LOADDEBUGDATA command is run for an assembler compile unit, z/OS Debugger uses the setting of this command to determine whether to display

YES

Indicates that you want delay debug enabled.

If you choose to implement this option, users who want to use this option must create the delay debug profile as a physical sequential data set by using the option B of the IBM z/OS Debugger Utilities: Delay Debug Profile.

Usage notes

- This command does not support 64-bit programs.

Example

```
EQAXOPT DLAYDBG,NO  
EQAXOPT DLAYDBG,YES
```

DLAYDBGEND

You can specify this command only in the EQAOPTS load module. It cannot be specified at run time.

You can use this command to indicate whether you want z/OS Debugger to monitor condition events in the delay debug mode.

This command can be used only in the non-CICS environments.

The following diagram describes the syntax of the DLAYDBGEND command:



The following list describes the parameters of the DLAYDBGEND command:

ALL

Indicates that you want z/OS Debugger to monitor all condition events. This is the default option.

NONE

Indicates that you do not want z/OS Debugger to monitor condition events.

Usage notes

- This command does not support 64-bit programs.

Example

```
EQAXOPT DLAYDBGEND,NONE
```

DLAYDBGDSN

You can specify this command only in the EQAOPTS load module. The only exception to this rule is a transaction executing in a private message region under the IMS Transaction Isolation Facility, which accepts this command in EQAOPTS DD as well.

You can specify this command to indicate that you want z/OS Debugger to use the specified naming pattern when it constructs the delay debug profile data set name.

This command can be used only in the non-CICS environments.

The following diagram describes the syntax of the DLAYDBGDSN command:

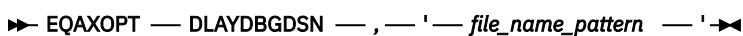

file_name_pattern

Specifies a naming pattern that determines the name of the data set that contains the delay debug profile. Follow this guideline when you create the naming pattern:

- Create a data set name that includes &&USERID . as one of the qualifiers. z/OS Debugger substitutes the user ID of the current user for this qualifier when it determines the name of the data set.

The default naming pattern is &&USERID . DLAYDBG . EQAUOPTS.

Usage notes

- This command does not support 64-bit programs.

Example

```
EQAXOPT DLAYDBGDSN, '&&USERID .DLAYDBG .EQAUOPTS' ;
```

DLAYDBGTRC

You can specify this command only in the EQAOPTS load module. The only exception to this rule is a transaction executing in a private message region under the IMS Transaction Isolation Facility, which accepts this command in EQAOPTS DD as well.

You can specify this command to indicate that you want z/OS Debugger to generate trace during the pattern match process in the delay debug mode. z/OS Debugger uses the WTO (write to operator) command to output the trace.

This command can be used only in the non-CICS environments.

The following diagram describes the syntax of the DLAYDBGTRC command:

```
➤ EQAXOPT — DLAYDBGTRC — , — trace_level ➤
```

trace_level

Specifies a trace level that determines the level of traces that z/OS Debugger generates. Valid levels are:

- 0 - no trace message; this is the default value.
- 1 - error and warning messages
- 2 - error, warning, and diagnostic messages
- 3 - error, warning, diagnostic, and internal diagnostic messages

Usage notes

- This command does not support 64-bit programs.

Example

```
EQAXOPT DLAYDBGTRC,2
```

DLAYDBGXRF

You can specify this command only in the EQAOPTS load module. The only exception to this rule is a transaction executing in a private message region under the IMS Transaction Isolation Facility, which accepts this command in EQAOPTS DD as well.

In this section, the term generic ID refers to a user ID that executes a task but is not the ID that debugs the task. Common examples include the user ID associated with a WebSphere® MQ for z/OS trigger monitor, or the user ID that runs a web services-initiated program.

You can use the DLAYDBGXRF command to map a generic ID to a user ID that is obtained from one of the following sources:

- The Delay Debug cross reference file
- Users logged on to Terminal Interface Manager

The user ID that is obtained by this method is used in place of the current user ID when the delay debug profile data set name is constructed.

The generic ID-to-user ID mapping can occur in the following environments:

- In the IMS environment when an IMS transaction is started with a generic ID.
- In the DB/2 stored procedures environment. This environment is supported by the REPOSITORY and CLIENTID options.

The following diagram describes the syntax of the DLAYDBGXRF command:

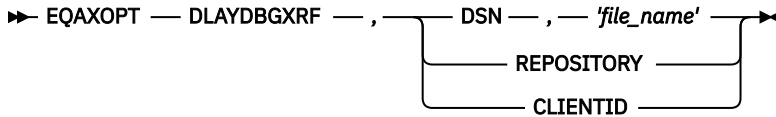

DSN

Specifies that the generic ID cross reference file *'file_name'* should be used to map the generic ID to the user ID of the z/OS Debugger user.

REPOSITORY

Specifies that z/OS Debugger communicates with Terminal Interface Manager (TIM) to determine whether a user has logged on to TIM and requested to debug the current IMS transaction or DB/2 stored procedure.

The REPOSITORY option requires that the debugging user ID be granted RACF authority to debug tasks initiated by the generic ID. This is done via the EQADTOOL.GENERICID.*generic_user_ID* facility. To set this up, use the following RACF commands:

```
RDEFINE EQADTOOL.GENERICID.generic_user_ID CLASS(FACILITY) UACC(NONE)
PERMIT EQADTOOL.GENERICID.generic_user_ID ID(user) ACC(READ)
```

The *generic_user_ID* can be a pattern.

The REPOSITORY option also requires that you start the Terminal Interface Manager started task with the REPOSITORY option. See "Starting the Terminal Interface Manager" in IBM z/OS Debugger Customization Guide for more information.

CLIENTID

Specifies that z/OS Debugger uses the DB/2 client user ID for a stored procedure call to determine whether a remote debug user has requested to debug DB/2 stored procedures that execute with that client user ID. If such a user exists, their user ID will be used to locate the delay debug profile data set.

'file_name'

Specifies an MVS sequential data set with FB LRECL 80 characteristics.

Usage notes

- This command does not support 64-bit programs.

Example

```
EQAXOPT DLAYDBGXRF,DSN,'EQAW.TRNUSRID.XREF'
EQAXOPT DLAYDBGXRF,REPOSITORY
```

Refer to the following topics for more information related to the material discussed in this topic.

Related references

Debugging tasks running under a generic user ID in the *IBM z/OS Debugger User's Guide*

DTCNDELETEDEADPROF

You can specify this command only in the EQAOPTS load module. It cannot be specified at run time.

This command controls the deletion of DTCN profiles. A dead profile is a profile whose owner has logged off or disconnected from the CICS region.

DTCN scans its repository for dead profiles from time to time, and on demand when EQADCDEL is called. When a dead profile is found, it deactivates the profile by default. You can specify DTCNDELETEDEADPROF to delete the profile instead. The dead profile is deactivated or deleted by the INACTIVATE or DELETE DTCN function.

The following diagram describes the syntax of the DTCNDELETEDEADPROF command:



NO

Indicates that you want DTCN not to delete the profile. NO is the default option.

YES

Indicates that you want DTCN to delete the profile.

Example

```
EQAXOPT DTCNDELETEDEADPROF , YES
```

DTCNFORCExxxx

You can specify these commands only in the EQAOPTS load module. You cannot specify them at run time.

If your users create debugging profiles with DTCN, you can use the DTCNFORCExxxx commands to require that certain DTCN fields are not left blank. The following list describes each resource type you can require each user to specify:

- DTCNFORCECUID or DTCNFORCEPROGID, which requires the user to specify the name of a compile unit or compile units.
- DTCNFORCEIP, which requires the user to specify the IP name or address.
- DTCNFORCELOADMODID, which requires the user to specify the name of a load module or load modules.
- DTCNFORCENETNAME, which requires the user to specify the four character name of a CICS terminal or a CICS system.
- DTCNFORCETERMID, which requires the user to specify the CICS terminal.
- DTCNFORCETRANID, which requires the user to specify a transaction ID.
- DTCNFORCEUSERID, which requires the user to specify a user ID.

If any of the statements are not included, the statement defaults to NO.

The following diagram describes the syntax of the DTCNFORCExxxx command:

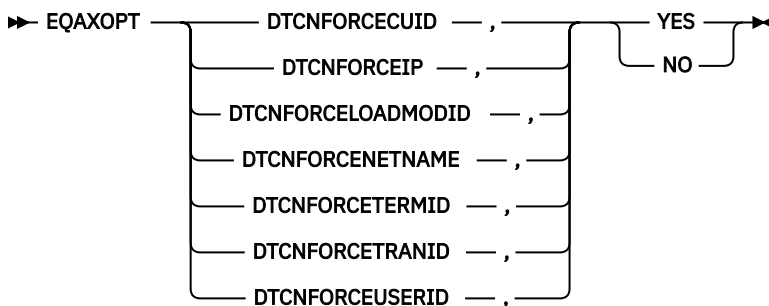

YES

Indicates that the specified field is required.

NO

Indicates that the specified field is not required.

Examples

```
EQAXOPT DTCNFORCEUSERID,YES  
EQAXOPT DTCNFORCETRANID,NO
```

DYNDEBUG

z/OS Debugger Reference and Messages describes how you use the SET DYNDEBUG command to enable or disable dynamic debug mode in z/OS Debugger.

The initial default setting is DYNDEBUG ON. If you want to change the initial default setting, use the EQAOPTS DYNDEBUG command.

The following diagram describes the syntax of the DYNDEBUG command:

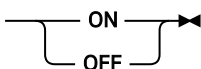
►► EQAXOPT — DYNDEBUG — , — 

ON

Sets the initial default to DYNDEBUG ON.

OFF

Sets the initial default to DYNDEBUG OFF.

Usage notes

- This command does not support 64-bit programs.

Example

```
EQAXOPT DYNDEBUG,OFF
```

EQAQPP

You must specify this command to enable z/OS Debugger to debug MasterCraft Q++ programs, provided by Tata Consultancy Services Ltd. For more information about how to enable z/OS Debugger to support MasterCraft Q++, contact Tata Consultancy Services Ltd.

The following diagram describes the syntax of the EQAQPP command:

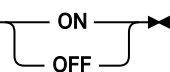
►► EQAXOPT — EQAQPP — , — 

ON

Indicates z/OS Debugger supports Q++ debugging.

OFF

Indicates z/OS Debugger does not support Q++ debugging. If you do not specify the EQAQPP command, OFF is the default.

Usage notes

- This command does not support 64-bit programs.

Example

```
EQAXOPT EQAQPP,ON
```

EXPLICITDEBUG

The *IBM z/OS Debugger Reference and Messages* describes how you use the SET EXPLICITDEBUG command to enable explicit debug mode in z/OS Debugger. However, before you can enter the SET EXPLICITDEBUG command, z/OS Debugger has already processed the initial load module and loaded the debug data for the compile units it contains. If you want to enable explicit debug mode prior to processing the initial load module, use the EQAOPTS EXPLICITDEBUG command.

The following diagram describes the syntax of the EXPLICITDEBUG command:

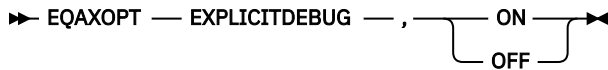

ON

Enables explicit debug mode.

OFF

Disables explicit debug mode. This is the default.

Example

```
EQAXOPT EXPLICITDEBUG,ON
```

GPFDSN

You can create a *global preferences file* that runs a set of z/OS Debugger commands at the start of all z/OS Debugger sessions. For example, a global preferences file can have a command that sets PF keys to specific values. If your site uses the PF6 key as the program exit key, you can specify the SET PF6 "EXIT" = QUIT; command, which assigns the z/OS Debugger QUIT command to the PF6 key, in the global preferences file. (See "Customizing your full-screen session" in the *IBM z/OS Debugger User's Guide* for a description of the interface features you can change.)

Whenever a user starts z/OS Debugger, z/OS Debugger processes the commands in the global preferences file first. The user can also create his or her own preferences file and a commands file. In this situation, z/OS Debugger processes the files in the following order:

1. Global preferences file
2. User preferences file
3. Commands file

To create a global preferences file, do the following steps:

1. Create a preferences file that is stored as a sequential file or a PDS member. Refer to *IBM z/OS Debugger User's Guide* for a description of preferences files.

The rules for the preferences file are dependant on the programming language of the first program z/OS Debugger encounters. Because you might not know what programming language z/OS Debugger will encounter first, use the following rules when you create the preferences file:

- Put the commands in columns 8 - 72.
- Do not put line numbers in the file.
- Use COMMENT or /* */ to delimit comments.

2. Specify the GPFDSN command to indicate the name of the global preferences file.

For '*file_name*', specify the name of the data set where the global preferences file will be stored.

The following diagram describes the syntax of the GPFDSN command:

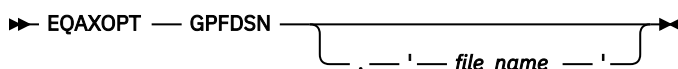

'file_name'

The name of the data set where you stored the global preferences file.

Examples

```
EQAXOPT  GPFDNS , 'GROUP1.COMMON.DTOOL.PREFS'  
EQAXOPT  GPFDNS
```

HOSTPORTS

You can specify this command only in the EQAOPTS load module. It cannot be specified at run time. To use this command in the CICS environment, you must be using the TCP/IP Socket Interface for CICS. For instructions on activating the TCP/IP Socket Interface for CICS, see the z/OS Communications Server *IP CICS Sockets Guide*.

You can use this command to specify a host port or range of ports for a TCP/IP connection from the host to a workstation when using remote debug mode.

The following diagram describes the syntax of the HOSTPORTS command:

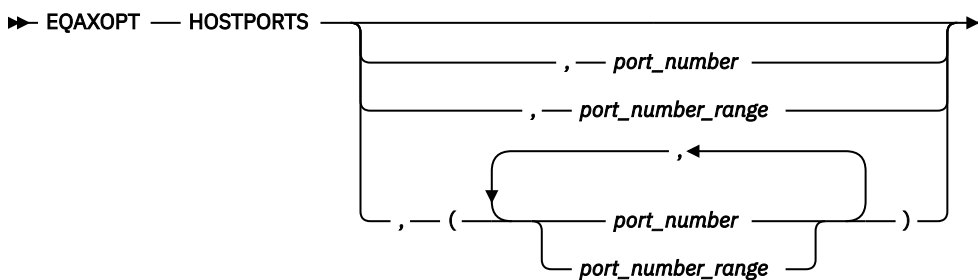

port_number

A positive integer (1-32767) identifying a TCP/IP port number.

port_number_range

The first and last *port_number* identifying a range of port numbers, separated by a hyphen (-).

Examples

```
EQAXOPT  HOSTPORTS , 29500-30499  
EQAXOPT  HOSTPORTS , (29500-30499 , 31500-32499)
```

IGNOREODOLIMIT

This command tells z/OS Debugger to display COBOL table data items even when an ODO value is out of range, and to suppress the following messages:

MFI and batch:

EQA1471E Incorrect value for ODO variable data item

Remote:

EQA2377E Invalid data.

The following diagram describes the syntax of the IGNOREODOLIMIT command:

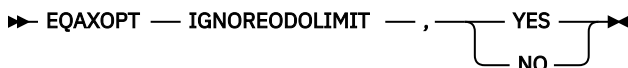

YES

Indicates that z/OS Debugger should display the requested table data item even when an ODO value is out of range, and to suppress issuing EQA1471E or EQA2377E.

NO

Indicates that z/OS Debugger should not display the requested table data item when an ODO value is out of range, and to issue EQA1471E or EQA2377E.

Examples

```
EQAXOPT IGNOREODOLIMIT,YES
EQAXOPT IGNOREODOLIMIT,NO
```

Notes:

- The default setting is NO.
- IGNOREODOLIMIT only affects the behaviour of z/OS Debugger if the compilation unit was compiled with one of the following compilers:
 - COBOL for OS/390 & VM Version 2 (5648-A25)
 - Enterprise COBOL for z/OS and OS/390 Version 3 (5655-G53)
 - Enterprise COBOL for z/OS Version 4 (5655-S71)
- IGNOREODOLIMIT is ignored for LangX COBOL.

IMSISOORIGPSB

Note: This command is deprecated. It is accepted for compatibility but has no effect. The original PSB is always preserved.

You can specify this command only in the EQAOPTS load module. It cannot be specified at run time. For the command to take effect, the EQAOPTS load module that contains it must be in the search path of the IMS control region.

This command instructs the IMS Transaction Isolation Facility to preserve the original PSB of the transaction when a message is routed to a private message processing region.

For example, if you register to debug conversational transaction IVTCB, and the private message class 121 is assigned to you, a message routed to your private message processing region will be sent to transaction EQAC1211. Ordinarily, the PSB name for EQAC1211 is EQAT1211. With IMSISOORIGPSB in effect, EQAC1211 is changed to associate the PSB name with IVTCB, DFSIVP34.

The following diagram describes the syntax of the IMSISOORIGPSB command:



YES

Indicates that you want IMS Isolation to preserve the original PSB of the transaction when a message is routed to a private message. IMS Transaction Isolation bypasses its normal operations for bringing up the transaction under the control of the debugger. Therefore, the debugger starts only for Language Environment-enabled programs.

NO

Indicates that you want IMS Isolation not to preserve the original PSB of the transaction when a message is routed to a private message. **NO** is the default setting.

LDDAUTOLANGX

This command controls whether LDD is automatically run on LangX COBOL compile units. The default setting is OFF. The LDDAUTOLANGX command is incompatible with the EXPLICITDEBUG command and is ignored if EXPLICITDEBUG is set to ON.

If there are many LangX COBOL compile units, or if the debug data is large for some of the LangX COBOL compile units, LDDAUTOLANGX might slow down the performance or cause the debugger to run out of storage. To mitigate this, the EQAOPTS NAMES command can be used to control which compile units

to load the debug data for. For CICS programs, the SET IGNORELINK command can be used to avoid loading debug data for programs in new enclaves.

The following diagram describes the syntax:



The following list describes the parameters:

COBOL

Indicates that the LDD command is automatically run on all LangX COBOL compile units.

OFF

Indicates that the LDD command is not automatically run on LangX COBOL compile units. This parameter is the default setting.

Example

```
EQAXOPT LDDAUTOLANGX, COBOL
```

```
EQAXOPT LDDAUTOLANGX, OFF
```

LOGDSN

By default, z/OS Debugger handles the log file data set in one of the following ways:

- In a non-CICS environment, when z/OS Debugger starts in batch mode or full-screen mode, and you allocate the INSPLOG DD name, z/OS Debugger runs the command SET LOG ON FILE INSPLOG OLD and starts writing the log to INSPLOG.
- In a CICS environment, when z/OS Debugger starts in full-screen mode, it runs the command SET LOG OFF. If you want a log file, you run the command SET LONG ON FILE *fileid* OLD and z/OS Debugger starts writing the log to *fileid*.

LOGDSN allows a site or a user to specify the default data set name for the log file. If you specify the LOGDSN command, z/OS Debugger handles the log file in the following way:

- In a non-CICS environment, when z/OS Debugger starts in batch mode or full-screen mode, and you allocate the INSPLOG DD name, z/OS Debugger runs the command SET LOG ON FILE INSPLOG OLD and starts writing the log to INSPLOG . This behavior remains the same.
- In a non-CICS environment, when z/OS Debugger starts in full-screen mode, if you do not allocate the INSPLOG DD name, z/OS Debugger runs the command SET LOG ON FILE *fileid* OLD and starts writing the log to the data set specified in the LOGDSN command.
- In CICS, when z/OS Debugger starts in full-screen mode, it runs the command SET LOG ON FILE *fileid* OLD and starts writing the log to the data set specified in the LOGDSN command.

This allows a user to always write the log file to a data set, whether in CICS or not, and without having to pre-allocate the log file data set.

For instructions on how to specify the allocation parameters for automatically creating the data set, see “LOGDSNALLOC” on page 173. Use the EQAOPTS LOGDSN and LOGDSNALLOC commands to help a new z/OS Debugger user automatically create and write to the log file.

If you are an existing z/OS Debugger user that uses a SAVESETS data set, and you or your site specify the EQAOPTS commands LOGDSN and LOGDSNALLOC, then the SAVESETS data set contains a SET LOG command that overrides the EQAOPTS command LOGDSN.

The following diagram describes the syntax of the LOGDSN command:

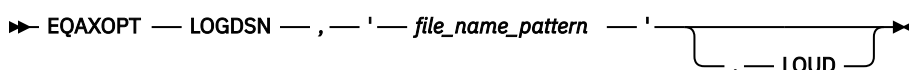

file_name_pattern

Specifies a naming pattern that determines the name of the data set that contains the log file. Follow these guidelines when you create the naming pattern:

- Create a data set name that includes `&&USERID.` as one of the qualifiers. z/OS Debugger substitutes the user ID of the current user for this qualifier when it determines the name of the data set.
- Specify `NULLFILE` to indicate you do not want z/OS Debugger to write to a log file.

LOUD

Specifies that z/OS Debugger display WTO messages, which helps you debug processing done by this command. z/OS Debugger normally does not display any messages if it does not find the data set. If you are trying to determine why z/OS Debugger is not writing to this log file, specify `LOUD` to see if it displays any messages.

If you choose to implement this option, users who want to use the `EQAOPTS LOGDSN` command must create a log file in one of the following ways:

- Instruct z/OS Debugger to create the log file by specifying the `EQAOPTS LOGDSNALLOC` command, as described in “[LOGDSNALLOC](#)” on page 173.
- Create the log file manually with the allocation parameters that are described in “Data sets used by z/OS Debugger” in the *IBM z/OS Debugger User's Guide*.

Example

```
EQALOPT LOGDSN, '&&USERID.DBGTOOL.LOG'
```

If you log in with user ID `USERIBM`, z/OS Debugger determines the name of the data set to be `USERIBM.DBGTOOL.LOG`.

LOGDSNALLOC

Indicates that you want z/OS Debugger to create the log file data set specified by `EQAOPTS LOGDSN` command if it does not exist. You specify the `EQAOPTS LOGDSNALLOC` command with the corresponding allocation parameters for the data set, which z/OS Debugger uses when it creates the data set.

The following diagram describes the syntax of the `LOGDSNALLOC` command:

►► EQALOPT — LOGDSNALLOC — , — ' — *allocation_parms* — ' — *LOUD* —

allocation_parms

Specifies the allocation parameters you want z/OS Debugger to use when it creates the data set. You can specify only the keys in the following list:

- `BLKSIZE`
- `BLOCK`
- `CYL`
- `DATACLAS`
- `DIR`
- `DSNTYPE`
- `DSORG`
- `LRECL`
- `MGMTCLAS`
- `RECFM`
- `SPACE`
- `STORCLAS`

Example

```
EQAXOPT MDBG, YES
```

MULTIPROCESS

Controls the behavior of z/OS Debugger when a new POSIX process is created by a `fork()` or `exec()` function in the application.

With the `MULTIPROCESS` command, you can instruct z/OS Debugger to perform any of the following tasks when a new POSIX process is created:

- Continue debugging the current process. The current process is also referred to as the PARENT process.
- Stop debugging the current process and start debugging the newly created process. The newly created process is also referred to as the CHILD process.
- Prompt you to decide whether to follow the PARENT or CHILD process.

Note: The `MULTIPROCESS` command applies only to remote debug mode.

The following diagram describes the syntax of the `MULTIPROCESS` command:

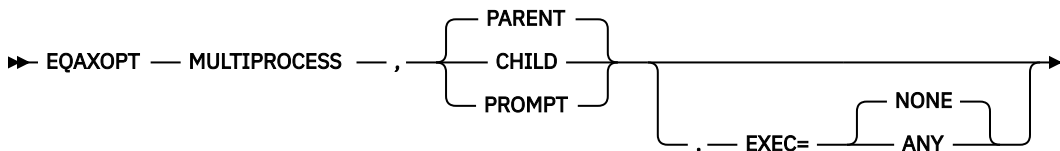

The following list describes the parameters of the `MULTIPROCESS` command:

PARENT

Indicates that z/OS Debugger continues with the current debug session; that is, z/OS Debugger follows the PARENT process.

CHILD

Indicates that z/OS Debugger stops debugging the current process and starts debugging the newly created process; that is, z/OS Debugger follows the CHILD process.

PROMPT

Indicates that the remote debug GUI prompts you to decide whether to follow the PARENT or CHILD process.

EXEC=ANY

Indicates that z/OS Debugger debugs any process that is reinitialized by the `exec()` function.

EXEC=NONE

Indicates that z/OS Debugger does not debug a process that is reinitialized by the `exec()` function. If you do not specify the `EXEC` option, the default setting is `EXEC=NONE`.

Examples

- Specify that z/OS Debugger follows the PARENT process and debugs the new process that is created by the `exec()` function.

```
EQAXOPT MULTIPROCESS, PARENT, EXEC=ANY
```

- Specify that z/OS Debugger follows the CHILD process and does not debug the new process that is created by the `exec()` function.

```
EQAXOPT MULTIPROCESS, CHILD, EXEC=NONE
```

- Specify that you are prompted to choose whether to follow the PARENT or CHILD process and z/OS Debugger does not debug the new process that is created by the `exec()` function.

```
EQAXOPT MULTIPROCESS, PROMPT
```

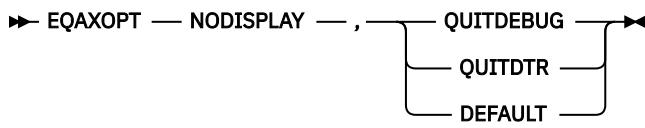
DEFAULT

z/OS Debugger follows the default behavior.

QUITDEBUG

z/OS Debugger displays a message that indicates that z/OS Debugger will quit, and that the user interface could not be used. z/OS Debugger processing continues as if the user entered a QUIT DEBUG command. IBM Dynamic Test Engine will not do any recording or replay.

QUITDTR

IBM Dynamic Test Engine will not do any recording or replay. z/OS Debugger follows the remaining default behavior.

Example

```
EQAXOPT NODISPLAY,QUITDEBUG
```

PREFERENCESDSN

Indicates that you want z/OS Debugger to read a user's preferences file (with the name of the data set containing the preferences file determined by the specified naming pattern) each time it starts. This works in the following situation:

- You do not specify a data set name or DD name for the user's preferences file using any other method; for example, the TEST runtime option.
- In a non-CICS environment, you do not allocate ISPPREF DD.
- You or your site specifies the PREFERENCESDSN command.
- The data set specified by the PREFERENCESDSN command exists.

The following diagram describes the syntax of the PREFERENCESDSN command:

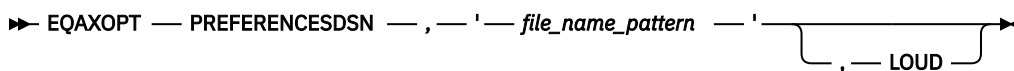

file_name_pattern

Specifies a naming pattern that determines the name of the data set that contains the preferences file. Follow these guidelines when you create the naming pattern:

- Create a data set name that includes &&USERID. as one of the qualifiers. z/OS Debugger substitutes the user ID of the current user for this qualifier when it determines the name of the data set.
- Specify NULLFILE to indicate you do not want z/OS Debugger to process a preferences file.

LOUD

Specifies that z/OS Debugger display WTO messages, which helps you debug processing done by this command. z/OS Debugger normally does not display any messages if it does not find the data set. If you are trying to determine why z/OS Debugger is not processing your preferences file, specify LOUD to see if it displays any messages about not finding the data set.

If you choose to implement this option, users who want to use this function must create the preferences file as a sequential data set with the allocation parameters that are described in "Data sets used by z/OS Debugger" in the *IBM z/OS Debugger User's Guide*.

Example

```
EQAXOPT PREFERENCESDSN, '&&USERID.DBGTOOL.PREFS'
```

If you log in with user ID USERIBM, z/OS Debugger determines the name of the data set to be USERIBM.DBGTOOL.PREFS.

SAVEBPDSN, SAVESETDSN

You can modify the default names of the data sets used to save and restore settings and breakpoints, monitor values, and LOADDEBUGDATA (LDD) specifications. The following list describes the initial default names:

- For settings: *userid*.DBGTOOL.SAVESETS
- For breakpoints, monitor values, and LOADDEBUGDATA (LDD) specifications: *userid*.DBGTOOL.SAVEBPS

To change the default name for either or both of these data sets, you need to specify the EQAOPTS SAVESETDSN and SAVEBPDSN commands, along with a corresponding naming pattern for the data set.

The following diagram describes the syntax of the SAVESETDSN and SAVEBPDSN commands:



file_name_pattern

Specifies a naming pattern for the data set that stores this information.

In most environments, you should choose one of the following rules for the naming pattern:

- Any data set name that includes &&USERID. as one of the qualifiers. z/OS Debugger substitutes the user ID of the current user for this qualifier when it creates the data set.
- A DD name (Reminder: DD names are not supported under CICS)
- The string NULLFILE to indicate that saving and restoring this information is not supported

Examples

```
EQAXOPT SAVESETDSN, 'CICS.DTDATA.&&USERID.SAVSET'
EQAXOPT SAVEBPDSN, '&&USERID.USERDATA.DTOOL.SAVBPMON';
```

SAVESETDSNALLOC, SAVEBPDSNALLOC

Indicates that you want z/OS Debugger to create the data sets for SAVESETS, SAVEBPS, or both (specified by EQAOPTS SAVESETDSN or SAVEBPDSN commands) if they do not exist. You specify the EQAOPTS SAVESETDSNALLOC and SAVEBPDSNALLOC commands with the corresponding allocation parameters for the data sets, which z/OS Debugger uses when it creates the data sets. After creating each data set, z/OS Debugger runs commands that save the information (settings, breakpoints, monitors, preferences, and LDD specifications) in the corresponding data set.

The following diagram describes the syntax of the SAVEBPDSNALLOC and SAVESETDSNALLOC commands:

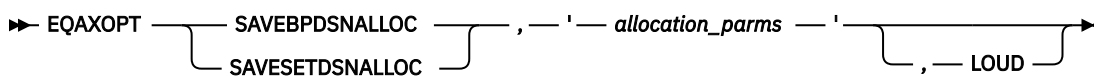

allocation_parms

Specifies the allocation parameters you want z/OS Debugger to use when it creates the data set. You can specify only the keys in the following list:

- BLKSIZE
- BLOCK
- CYL
- DATACLAS

- DIR
- DSNTYPE
- DSORG
- LRECL
- MGMTCLAS
- RECFM
- SPACE
- STORCLAS
- TRACKS
- UNIT
- VOL

Separate the keys by one or more blanks. z/OS Debugger does not provide defaults for any of the keys.

For information on the format of the keys, see the chapter "BPXWDYN: a text interface to dynamic allocation and dynamic output" in the *z/OS Using REXX and z/OS UNIX System Services* manual. Specify that the data set be sequential for SAVESETS; a PDS or PDSE for SAVEBPS. To learn about other formatting rules for these files, see "Data sets used by z/OS Debugger" of the *IBM z/OS Debugger User's Guide*.

LOUD

Specifies that z/OS Debugger display WTO messages, which helps you debug processing done by this command. z/OS Debugger normally does not display any messages when it creates these data sets. If you are trying to determine why the data sets were not created, specify LOUD to view any messages.

z/OS Debugger does the following tasks when you specify these commands:

1. If you specified the SAVESETDSNALLOC command, it creates the SAVESETS data set.
2. If it creates the SAVESETS data set successfully, it runs the following commands:

```
SET SAVE SETTINGS AUTO;
SET RESTORES SETTINGS AUTO;
```

If it did not create the SAVESETS data set successfully, it skips the rest of these steps and does the next processing task.

3. If you specified the SAVEBPDSNALLOC command, it creates the SAVEBPS data set.
4. If it creates the SAVEBPS data set successfully, it runs the following commands:

```
SET SAVE BPS AUTO;
SET SAVE MONITORS AUTO;
SET RESTORE BPS AUTO;
SET RESTORE MONITORS AUTO;
```

In a CICS environment, review the performance implications discussed in the "Performance considerations in multi-enclave environments" section of the "Using full-screen mode: overview" topic in the *IBM z/OS Debugger User's Guide* before choosing to implement the SAVEBPDSNALLOC command. If you think the performance implications might adversely affect your site, do not implement the SAVEBPDSNALLOC command in the EQAOPTS for CICS.

Example

```
EQAXOPT SAVESETDSNALLOC,'MGMTCLAS(STANDARD) STORCLAS(DEFAULT) +
LRECL(3204) BLKSIZE(0) RECFM(V,B) DSORG(PS) SPACE(2,2) +
TRACKS'
EQAXOPT SAVEBPDSNALLOC,'MGMTCLAS(STANDARD) STORCLAS(DEFAULT) +
LRECL(3204) BLKSIZE(0) RECFM(V,B) DSORG(PO) +
DSNTYPE(LIBRARY) SPACE(1,3) CYL'
```

SESSIOETIMEOUT

You can specify this command only in the EQAOPTS load module. It cannot be specified at run time.

You can establish a timeout for idle z/OS Debugger sessions that use the Terminal Interface Manager. Timed out sessions are canceled after a specified period of no user activity.

The following diagram describes the syntax of the SESSIOETIMEOUT command:

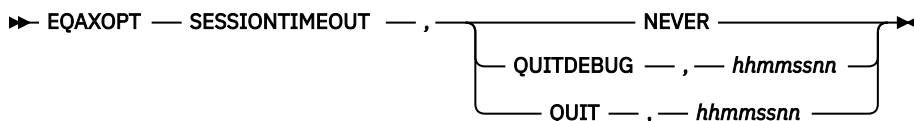

NEVER

No timeout is enforced. Unattended sessions will not be canceled.

QUITDEBUG, *hhmssnn*

Sessions left unattended for the specified time interval will be canceled, and the process being debugged will proceed as though the QUIT DEBUG command had been entered.

The time interval is expressed as *hhmssnn*, where

- *hh* is the number of hours,
- *mm* is the number of minutes,
- *ss* is the number of seconds,
- *nn* is the number of hundredths of seconds.

QUIT, *hhmssnn*

Sessions left unattended for the specified time interval will be canceled, and the process being debugged will be terminated with a U4038 abend, as though the QUIT ABEND command had been entered.

The time interval is expressed as *hhmssnn*, where

- *hh* is the number of hours,
- *mm* is the number of minutes,
- *ss* is the number of seconds,
- *nn* is the number of hundredths of seconds.

If the command is not specified in the EQAOPTS load module, the default behavior is "NEVER", which means that any full-screen mode session using Terminal Interface Manager left unattended will not be canceled.

Example

To specify a timeout interval of 1 hour and allow the debugged process to proceed after the debug session is canceled, enter the following EQAOPTS command:

```
EQAXOPT SESSIOETIMEOUT,QUITDEBUG,01000000
```

STARTSTOPMSG

This command controls whether to issue a message when each debugging session is initiated or terminated. By default, these messages are not issued.

The following diagram describes the syntax of the STARTSTOPMSG command:

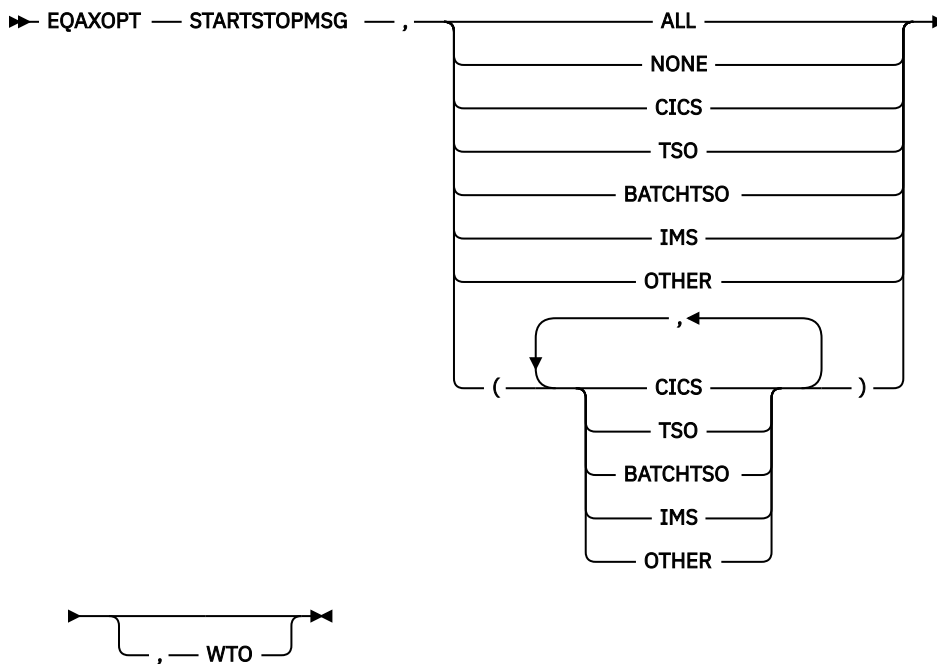

The following list describes the parameters of the STARTSTOPMSG command:

ALL

Indicates that the start/stop messages should be written in all environments.

NONE

Indicates that no start/stop messages should be written. If you do not specify EQAOPTS STARTSTOPMSG, the default option is NONE.

CICS

Indicates that the start/stop messages should be written in the CICS environment.

TSO

Indicates that the start/stop messages should be written in the TSO environment.

BATCHTSO

Indicates that the start/stop messages should be written in the BATCH TSO environment.

IMS

Indicates that the start/stop messages should be written when running under IMS. In addition, an informational message that contains the IMS system ID, region ID, and transaction ID is written.

OTHER

Indicates that the start/stop messages should be written in all other environments, such as MVS batch.

WTO

Indicates that the start/stop messages should be written to the system log using a WTO.

Examples

```
EQAXOPT STARTSTOPMSG,ALL,WTO
EQAXOPT STARTSTOPMSG,(TSO,OTHER),WTO
```

STARTSTOPMSGDSN

You can specify this command only in the EQAOPTS load module. It cannot be specified at run time.

You can use this command to indicate that you want z/OS Debugger to write a message in the message file when the debug session is started and stopped.

The following diagram describes the syntax of the STARTSTOPMSGDSN command:

- Run z/OS Debugger when debugging LangX COBOL programs.
- Run z/OS Debugger when you need to detect services such as MVS LINK, LOAD and DELETE.
- Run z/OS Debugger when you debug subtasks within a multi-tasked application, where subtasks are started by using the ATTACH assembler macro.
- Run z/OS Debugger in a situation that requires SVC screening and SVC screening is already in use by a program with which z/OS Debugger supports MERGE SVC screening as described by the MERGE operand that follows.

The following diagram describes the syntax of the SVCSCREEN command:

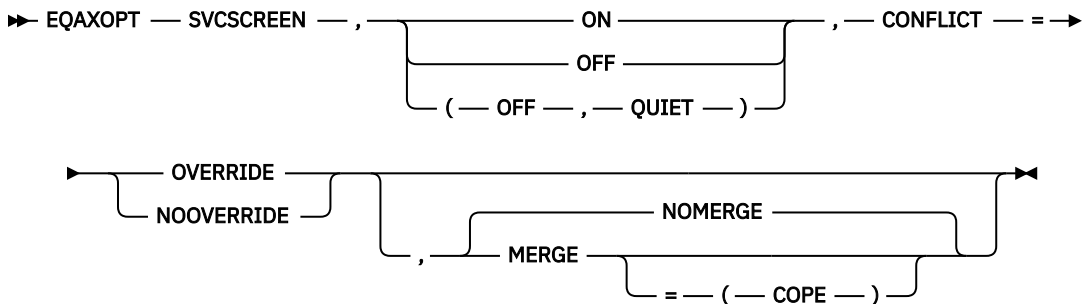

ON

Indicates that you want z/OS Debugger to use SVC screening in order to support MVS LOAD, DELETE, and LINK SVCs.

OFF

Indicates that you want z/OS Debugger to not use SVC screening. z/OS Debugger will not know about programs started through MVS LOAD, DELETE, and LINK SVCs. If you start z/OS Debugger by using the EQANMDBG program, the OFF setting is ignored.

QUIET

Suppresses message EQA2458I, which is written to the z/OS Debugger log when SVC screening is disabled by default.

CONFLICT=

Specifies what you want z/OS Debugger to do when ON is specified or defaulted and SVC screening is already used by another program.

OVERRIDE

Indicates that you want z/OS Debugger to override the current SVC screening and take control of SVC screening.

NOOVERRIDE

Indicates that if SVC screening is already in use, z/OS Debugger does not initiate SVC screening and proceeds as if OFF were specified.

NOMERGE

Indicates that SVC screening is not to be merged with SVC screening used by any other product. NOMERGE is the default.

MERGE

Indicates that when SVC screening is already being used by another program when z/OS Debugger starts, z/OS Debugger saves the current SVC screening environment, then enables SVC screening for both z/OS Debugger and the other program. When z/OS Debugger terminates, it restores the original SVC screening environment.

Currently, z/OS Debugger supports the MERGE command with only one other program: COPE.

If you specify the MERGE command and z/OS Debugger does not recognize the program that is using the SVC screening, the MERGE command is ignored and z/OS Debugger starts based on the value of the CONFLICT option.

MERGE=(COPE)

If COPE is active, z/OS Debugger saves the current SVC screening environment, then enables SVC screening for both z/OS Debugger and COPE. When z/OS Debugger terminates, it restores COPE's SVC screening environment.

If COPE is not active, z/OS Debugger starts based on the value of the CONFLICT option.

The default parameters for the EQAOPTS SVCSCREEN command is one of the following situations:

- If z/OS Debugger is started by using the EQANMDBG program:
SVCSCREEN, ON, CONFLICT=NOOVERRIDE, NOMERGE
- If z/OS Debugger is started by any other method:
SVCSCREEN, OFF, CONFLICT=NOOVERRIDE, NOMERGE

Use [Table 31 on page 184](#) as a guide to select the appropriate suboptions.

Usage notes

- This command does not support 64-bit programs.

Example

```
EQAXOPT SVCSCREEN,ON,CONFLICT=OVERRIDE,NOMERGE
EQAXOPT SVCSCREEN,OFF,CONFLICT=NOOVERRIDE,NOMERGE
```

Combinations of suboptions for the EQAOPTS SVCSCREEN command

The following table shows examples of combinations of suboptions for the EQAOPTS SVCSCREEN command:

SVSCREEN options	Type of z/OS Debugger session	Action
OFF, CONFLICT=NOOVERRIDE (default)	z/OS Debugger started by using EQANMDBG	Same as for ON, CONFLICT=NOOVERRIDE.
	z/OS Debugger started by any other method	<ul style="list-style-type: none">• z/OS Debugger does not enable its SVC screening.• You cannot debug programs that do not run in Language Environment which were started by programs that do run in Language Environment.• z/OS Debugger does not detect the MVS services LINK, LOAD and DELETE.• The CONFLICT setting is ignored when the OFF setting is specified.
OFF, CONFLICT=OVERRIDE	z/OS Debugger started by using EQANMDBG	Same as for ON, CONFLICT=OVERRIDE.
	z/OS Debugger started by any other method	Same as for OFF, CONFLICT=NOOVERRIDE. The CONFLICT setting is ignored when the OFF setting is specified.

Table 31. Combination of SVSCREEN options and their effects (continued)

SVSCREEN options	Type of z/OS Debugger session	Action
ON, CONFLICT=NOOVERRIDE	z/OS Debugger started by using EQANMDBG	If SVC screening is active, z/OS Debugger terminates. If SVC screening is not active, z/OS Debugger enables its SVC screening, runs the debugging session, and disables its SVC screening after the debugging session ends.
	z/OS Debugger started by any other method	If SVC screening is active, z/OS Debugger does not enable its SVC screening. You cannot debug programs that do not run in Language Environment which were started by programs that do run in Language Environment. z/OS Debugger does not detect the MVS services LINK, LOAD and DELETE. If SVC screening is not active, z/OS Debugger enables its SVC screening, runs the debugging session, and disables its SVC screening after the debugging session ends.
ON, CONFLICT=OVERRIDE	z/OS Debugger started by using EQANMDBG	If any SVC screening is active and the NOMERGE option is in effect, z/OS Debugger overrides the existing SVC screening. This is also the default behavior. z/OS Debugger enables its SVC screening, runs the debugging session, and disables its SVC screening after the debugging session ends. If any SVC screening was active, z/OS Debugger restores the previous SVC screening. If you specify the MERGE option, see the following information about MERGE.
	z/OS Debugger started by any other method	

TCPIP DATASN

You can specify this command only in the EQAOPTS load module. It cannot be specified at run time.

You can use this command to instruct z/OS Debugger to dynamically allocate the specified *'file_name'* to DDNAME SYSTCPD (if SYSTCPD is not already allocated). This provides the data set name for TCPIP.DATA when no GLOBALTCPIPDATA statement is configured in the system TCP/IP options.

The following diagram describes the syntax of the TCPIP DATASN command:

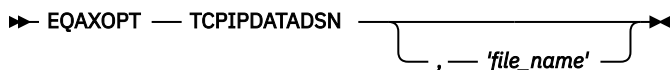

Examples

```
EQAXOPT TCPIP DATASD, 'SYS2.TCPIP.DATA'
```

```
EQAXOPT TCPIP DATASD, 'SYS2.TCPIP.PARMLIB(TCPDATA)'
```

If you want to use an alternative TCP/IP stack, you can add an entry to the specified TCPIP . DATA dataset with a TCPIPJOBNAME statement.

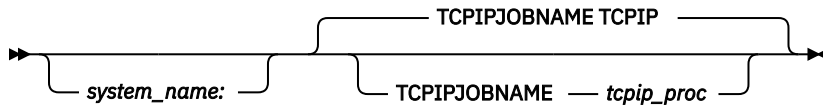

Example

To specify TCPIPA as the name of the procedure that was used to start the TCP/IP address space, add the following code to the specified TCPIP . DATA dataset:

```
TCPIPJOBNAME TCPIPA
```

THREADTERMCOND

You can indicate that z/OS Debugger should not prompt the user when a FINISH, CEE066, or CEE067 thread termination condition is raised by Language Environment, regardless of the suboptions used in the TEST runtime option. These conditions are raised by statements like STOP RUN, GOBACK, or EXEC CICS RETURN, which can occur frequently in an application program. Suppressing the display of these prompts can reduce the number of times your users are interrupted by this prompt during a debugging session.

The following diagram describes the syntax of the THREADTERMCOND command:

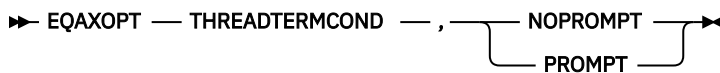

NOPROMPT

Suppress the display of termination prompts.

PROMPT

Prompts the user at termination. If you do not specify the THREADTERMCOND command, the default PROMPT is used.

Example

```
EQAXOPT THREADTERMCOND, NOPROMPT
```

TIMACB

You can include this command only in the EQAOPTS load module. You cannot specify it at run time.

TIMACB identifies the name of an ACB, other than EQASESSM, that z/OS Debugger uses to make full-screen mode using the Terminal Interface Manager work in an environment where you want to run the Terminal Interface Manager on more than one LPAR in the same VTAM network. You specify TIMACB as the last step in "Example: Defining the VTAM EQAMVnnn and Terminal Interface Manager APPL definition statements when z/OS Debugger runs on four LPARs" in the IBM z/OS Debugger Customization Guide.

The following diagram describes the syntax of the TIMACB command:



ACB_name

The new ACB name you want used. The default name is EQASESSM.

Example

```
EQAXOPT TIMACB,EQASESS2
```

END

The END command identifies the last EQAOPTS command. You must always specify it and it must be the last command in the input stream.

The following diagram describes the syntax of the END command:

▶▶ EQAXOPT — END ◀◀

Example

```
EQAXOPT END
```

Appendix A. SMP/E USERMODs

SMP/E USERMODs are available for a number of the customizations listed in the *IBM z/OS Debugger Customization Guide* and *IBM z/OS Debugger User's Guide*. The following table shows the available USERMODs and the associated names.

<i>hlq</i> .SEQAEXEC	<i>hlq</i> .SEQATLIB	<i>hlq</i> .SEQASAMP	<i>hlq</i> .SEQAMOD	SMP/E USERMOD in <i>hlq</i> .SEQASAMP
EQASTART				EQAUMOD2
	EQAZDFLT			EQAUMOD5
	EQAZDSYS			EQAUMOD6
	EQAZDUSR			EQAUMOD7
	EQAZPROC			EQAUMOD8
		EQACUIDF ¹	EQACUIDF ²	EQAUMOD9
		EQACUIDM		EQAUMODA
		EQAOPTS ¹	EQAOPTS ²	EQAUMODE
		EQAUEDAT ¹	EQAUEDAT ²	EQAUMODF
	EQABMPSP			EQAUMODG
	EQADBBSP			EQAUMODH
	EQADLISM			EQAUMODI
		EQAUEDAC ¹	EQAUEDAT ²	EQAUMODJ
		EQAD3CXT ^{1,3}	EQAD3CXT ²	EQAUMODK
EQAJCL				EQAUMODL

Note:

1. The source for these parts is in *hlq*.SEQASAMP. The executable (the part updated by the USERMOD) is in SEQAMOD.
2. The *IBM z/OS Debugger User's Guide* and *IBM z/OS Debugger Customization Guide* discussion of these parts typically shows generating a private copy of these load modules. If you want to update *hlq*.SEQAMOD so that all users see these customizations, you should use the SMP/E USERMOD method.
3. z/OS Debugger SMP/E USERMODs for these parts are only available if you choose the method that updates *hlq*.SEQAMOD. They are not available if you choose to update CEE.SCEERUN.

Appendix B. Enabling debugging in full-screen mode using a dedicated terminal

Note: This chapter is not applicable to IBM Developer for z/OS (non-Enterprise Edition) or IBM Z and Cloud Modernization Stack (Wazi Code).

This is a copy of Chapter 6 from the Debug Tool V10.1 Customization Guide. It documents the setup for 'full-screen mode using a dedicated terminal without/with Terminal Interface Manager' (indicated via the TEST runtime sub-options %MFI and %VTAM). It should be used

- by sites that want to continue to use the TEST %MFI option to specify a dedicated terminal
- as a reference for sites that are moving from an older release of Debug Tool to Debug Tool V11 (or later).

To enable users to debug the following types of programs while using a 3270-type terminal, you need to enable full-screen mode using a dedicated terminal:

- Batch programs
- TSO programs (using a separate terminal for debugging)
- Programs running under UNIX System Services
- Db2 stored procedures
- IMS programs

A dedicated terminal has specific set up requirements so that it can interact with z/OS Debugger in these environments. Thus, the terminal is dedicated for use by z/OS Debugger. Users do not typically use it to access other services.

How z/OS Debugger uses full-screen mode using a dedicated terminal

The following steps describe how a user would start a debugging session for a batch job using full-screen mode using a dedicated terminal. Study these steps to understand how z/OS Debugger uses full-screen mode using a dedicated terminal and to understand why you need to do the configuration steps described in [“Enabling full-screen mode using a dedicated terminal”](#) on page 192.

1. Start two terminal emulator sessions. Connect the second session to a terminal LU that can handle a full-screen mode using a dedicated terminal.
2. On the first terminal emulator session, log on to TSO.
3. Note the LU name (LU_name) to which the second terminal emulator session is connected.
4. Make following changes to the PARM string in the batch job that starts your debugging session:
 - Specify the TEST runtime option in the following format:

```
TEST(, , MFI%LU_name:*)
```

LU_name is the LU name you noted in step “3” on page 191.

If your site requires that you specify the VTAM network identifier (NETID), specify the TEST runtime option in the following format:

```
TEST(, , MFI%NETID.LU_name:*)
```

NETID identifies the network in which the second terminal emulator resides. For example, in the string NETA.LU001, NETA is the *NETID*.

5. Submit the batch job. z/OS Debugger completes the following tasks:

- a. z/OS Debugger allocates a VTAM ACB (EQAMVnnn) for its end of a VTAM session.
- b. z/OS Debugger uses VTAM to initiate a session with the terminal LU to which the second terminal emulator is connected.
- c. A VTAM session is then conducted between z/OS Debugger and the terminal LU.

The user does not log on to any host application through the second terminal emulator. z/OS Debugger initiates the connection between itself and that second terminal LU.

6. On the second terminal emulator, the emulator displays a full-screen mode debugging session. Interact with it in the same way you would with any other full-screen mode debugging session.

This technique requires you to define and configure a number of items in the z/OS Communications Server. Section “[Enabling full-screen mode using a dedicated terminal](#)” on page 192 describes these definitions and configuration.

Enabling full-screen mode using a dedicated terminal

To enable full-screen mode using a dedicated terminal, do the following steps:

1. Define the VTAM APPL definition statements that z/OS Debugger uses for its end of the session, as described in “[Defining the VTAM EQAMVnnn APPL definition statements](#)” on page 192.
2. Define the terminal LUs used by z/OS Debugger, as described in “[Defining terminal LUs used by z/OS Debugger](#)” on page 194.
3. If your terminals are connected through a SNA network, you are done. If your terminals are connected through a TN3270 network, you must continue.
4. If a TN3270 server manages the terminal, configure the TN3270 Telnet Server, as described in “[Configuring the TN3270 Telnet Server to access the terminal LUs](#)” on page 195.
5. Verify the installation of the facility to debug programs in full-screen mode using a dedicated terminal, as described in “[Verifying the customization of the facility to debug full-screen mode using a dedicated terminal](#)” on page 199.

Defining the VTAM EQAMVnnn APPL definition statements

You must define the APPL definition statements that z/OS Debugger uses for its end of the VTAM session with the terminal LU. You can define up to 999 APPLs for z/OS Debugger. You can define an APPL by using one of the following naming conventions:

- Define each APPL with the following naming convention: the first five characters of the APPL name must be EQAMV and the last three characters must be consecutive three digit numbers, starting with 001. Do not code an ACBNAME operand on the APPL definition statements for this method.
- Define each APPL name with the naming convention you use at your site. Code an ACBNAME operand on the APPL definition statement that uses EQAMV as the first five characters, and three numeric digits (starting with 001) as the last three characters.

Tip: The EQAMVnnn names are used internally by z/OS Debugger. Do not confuse these names with the terminal LU names. The user needs to know only the terminal LU name, which he specifies with the MFI% suboption of the TEST runtime option.

The number of APPL names you define must be sufficient to allow for the maximum number of concurrent z/OS Debugger full-screen mode using a dedicated terminal sessions. (z/OS Debugger uses one of these APPL names for its end of each VTAM session that is initiated with a terminal LU.)

The descriptions and examples used in this book assume you defined APPL names by using the EQAMVnnn naming convention. z/OS Debugger uses the EQAMVnnn names for internal processing.

The EQAWAPPL member in the *hlq*.SEQASAMP data set predefines 50 APPL names, EQAMV001 to EQAMV050. You can do one of the following tasks to add this member to the VTAM definitions library (VTAMLST).

- Copy EQAWAPPL into a new member:

1. Create a new member in the VTAM definitions library (VTAMLST). The VTAM definitions library is often stored in the data set SYS1.VTAMLST.
 2. Copy the contents of the EQAWAPPL member into the new member.
 3. Add the new member's name to the VTAM start options configuration file, ATCCON xxx , so that VTAM activates the z/OS Debugger APPL definitions at initialization.
- Copy EQAWAPPL into an existing member that is already defined in VTAMLST:
 1. Select a member in the VTAM definitions library (VTAMLST) that contains the major node definitions.
 2. Copy the APPL definition statements for z/OS Debugger from the EQAWAPPL member into the selected member.

Tip: The existing member has the VBUILD TYPE=APPL statement, so do not copy this statement from EQAWAPPL.

If you are running VTAM in a multi-domain environment and you require the ability to debug full-screen mode using a dedicated terminal on more than one host, edit the copy of EQAWAPPL on each system to make the names for z/OS Debugger major and minor nodes unique for each system.

For example, if you have hosts SYSA, SYSB, and SYSC, and need to provide definitions for up to 50 concurrent users debugging programs in full-screen mode using a dedicated terminal on each system, you can code the following entries:

- SYSA VTAMLST EQAWAPPL entry:

```
EQAAPPLA VBUILD TYPE=APPL
EQAMV001 APPL AUTH=(PASS,ACQ),PARSESS=NO
EQAMV002 APPL AUTH=(PASS,ACQ),PARSESS=NO
...
EQAMV050 APPL AUTH=(PASS,ACQ),PARSESS=NO
```

- SYSB VTAMLST EQAWAPPL entry:

```
EQAAPPLB VBUILD TYPE=APPL
EQAMV051 APPL AUTH=(PASS,ACQ),PARSESS=NO
EQAMV052 APPL AUTH=(PASS,ACQ),PARSESS=NO
...
EQAMV100 APPL AUTH=(PASS,ACQ),PARSESS=NO
```

- SYSC VTAMLST EQAWAPPL entry:

```
EQAAPPLC VBUILD TYPE=APPL
EQAMV101 APPL AUTH=(PASS,ACQ),PARSESS=NO
EQAMV102 APPL AUTH=(PASS,ACQ),PARSESS=NO
...
EQAMV150 APPL AUTH=(PASS,ACQ),PARSESS=NO
```

You can have up to 999 unique APPL names for full-screen mode using a dedicated terminal spread across your network.

As an alternative to coding each minor node name, you can use the Model Application Names function. With this function, VTAM dynamically creates the minor nodes. Use one of the following ways (alter these examples, if needed, to maintain unique names per system as discussed in [“Defining the VTAM EQAMVnnn APPL definition statements”](#) on page 192):

- EQAMV??? APPL AUTH=(PASS,ACQ),PARSESS=NO
- ABCDE??? APPL AUTH=(PASS,ACQ),PARSESS=NO,ACBNAME=EQAMV???

Activating the VTAM EQAMVnnn APPLs

Activate the VTAM APPLs by entering the following command from the console, where *member-name* is the member name in the VTAM library (VTAMLST):

```
VARY NET,ACT,ID=member-name
```

Defining terminal LUs used by z/OS Debugger

The terminal LUs used by z/OS Debugger in full-screen mode using a dedicated terminal must meet the requirements specified in the following sections:

[“Terminal LU specifications” on page 194](#)

[“Terminal LU state requirements” on page 194](#)

Terminal LU specifications

All terminal LUs that are used to debug programs in full-screen mode using a dedicated terminal must have a default log mode specified in the corresponding VTAM definitions. This log mode must match the characteristics of the terminal emulator session that is attached to this terminal LU. Use the DLOGMOD= operand on the APPL definition for the terminal logical unit (LU) to specify the default log mode.

To support the widest range of terminal characteristics, we recommend you use a DLOGMOD specification of D4C32XX3, in the IBM supplied MODETAB of ISTINCLM. If you use a DLOGMOD specification of D4C32XX3, you must use a TN3270E emulator that responds to a VTAM query with terminal characteristics, such as size, color, and extended graphics.

If your terminal emulator session cannot provide this information, select a log mode that matches your terminal emulator session characteristics. For example, if you have a TN3270 emulator that does not respond to a query, select one of the following log modes that matches the terminal size that the user will be using:

- D4C32782 24x80
- D4C32783 32x80
- D4C32784 43x80
- D4C32785 27x132

When you specify these types of log modes, the user must select a terminal size that matches your DLOGMOD specification.

An example of a set of terminal LU definitions for the terminal side of the VTAM session is *h7q*. SEQASAMP (EQAWTRML). See the log mode definitions in the *IBM Communications Server SNA Resource Definition Reference* for further information about log modes. The MODETAB log mode table load module that contains the DLOGMOD default log mode specification must be available to VTAM via the VTAMLIB DD statement.

You need to VARY on these new terminal LU definitions, similar to the way it was done in [“Activating the VTAM EQAMVnnn APPLs” on page 193](#).

Terminal LU state requirements

When z/OS Debugger accesses the terminal LU, the terminal LU must be in the following state:

- It must be known to the z/OS Communications Server on the system which z/OS Debugger runs.
- It must be marked secondary logical unit (SLU) enabled.
- It must not be in session with any application.

You can determine whether a particular terminal LU meets these criteria by using the DISPLAY VTAM operator command:

1. Access the desired LU using your terminal emulator, and exit any session manager.
2. On your system console, enter the following command, where *name* is the LU name:

```
DISPLAY NET, ID=name, SCOPE=ALL
```

3. Inspect the output of the command for the following information:

- The IST486I message indicates STATUS=ACTIV and DESIRED STATE=ACTIV, and an IST172I NO SESSIONS EXIST message is displayed.

- The IST597I message indicates SLU ENABLED.
- The IST934I message indicates that a DLOGMOD was specified.

Configuring the TN3270 Telnet Server to access the terminal LUs

If you use the IBM Communications Server for z/OS TN3270 Telnet Server to manage your terminals, you must configure TN3270 Telnet Server to support terminals with the following characters:

- Terminal LUs that have a proper DLOGMOD specified must be accessed.
- The LUMAP KEEPOPEN statement needs to be specified, so that VTAM allocates the ACB for the terminal LU when a terminal emulator session is connected to it, rather than only when an application is started.
- The terminal LU name must be available to the user of the terminal emulator session.

One way to enable this support is to set up a new TN3270 telnet port. The following instructions guide you through setting up a new port and the changes you must make to the PROFILE.TCPIP data set. The examples in [“Configuring the TN3270 Telnet Server” on page 197](#) show several variations of this support.

1. Select an unused port, such as 2023. If you have a firewall installed, ensure that this port is allowed through the firewall.
2. Do one of the following steps:
 - If you are running the TN3270 Telnet Server in a separate address space (optional on z/OS Communications Server Version 1.6 through 1.8, required on Version 1.9 or later), specify a `PORT num TCP jobname NOAUTOLOG` statement to reserve the new port for the TN3270 Telnet Server.
 - If you are running the TN3270 Telnet Server in the TCP/IP address space, specify a `PORT num TCP INTCLIEN` statement to reserve the new port for the TN3270 Telnet Server.
3. Create a new set of TELNETPARMS and BEGINVTAM blocks for the new port by copying the existing TELNETPARMS and BEGINVTAM blocks for port 23.
4. Customize the new TELNETPARMS and BEGINVTAM blocks to use this new port number. Ensure that the previous TELNETPARMS and BEGINVTAM blocks also specify a port number (typically 23).
5. Make the following changes to your new BEGINVTAM block:
 - a. If you intend to use this new port for only z/OS Debugger in full-screen mode using a dedicated terminal, you can remove all the statements from the BEGINVTAM block that you created in step 3, except the PORT statement. Go to step 5c.
 - b. Remove any copied DEFAULTLUS, DEFAULTLUSSPEC, DEFAULTAPPL and LUMAP statements.
 - c. Specify a new LUGROUP specification that indicates which terminal LUs that will be used as dedicated terminals for debugging in full-screen mode using a dedicated terminal. These terminal LUs must have a DLOGMOD specification in their APPL definition statement.
 - d. Specify some client_identification statements (such as HNGROUP and IPGROUP).
 - e. Specify a new LUMAP statement with KEEPOPEN (along with the proper LU group operand and client_identification operand).

The KEEPOPEN operand forces the TN3270 Telnet Server to keep the access control block (ACB) for the LU open at all times (for those LUs affected by this LUMAP statement). With the ACB open, z/OS Debugger can acquire the LU if the LU is connected to a client terminal emulator session but is not in session.
 - f. Specify a new ALLOWAPPL EQAMV* statement (or ALLOWAPPL * if site policies allow it) in the BEGINVTAM block to let z/OS Debugger start a session with the terminal LU.

If you defined the name that z/OS Debugger uses for its side of the VTAM session with a name other than EQAMVnnn, then you should specify that name on the ALLOWAPPL statement, rather than EQAMVnnn. (Or just use * if your site policies allow it.)
 - g. Specify whether the terminal is to display a session manager panel, a USSMSG10 panel, or a Telnet Solicitor Logon panel.

The user must know what terminal LU they have acquired when they connect their terminal emulator session to this new port. If you normally use a session manager that displays the terminal LU, then you can continue to use that method. Otherwise, use one of the following panels:

- A modified USSMSG10 panel that displays the terminal LU name
- The Telnet Solicitor Logon panel, if the terminal emulator itself shows the terminal LU name

To specify which panel is to be displayed, do the following steps:

- To display a session manager panel, specify the `FIRSTONLY` operand on a `DEFAULTAPPL` statement that defines the session manager to run. To use the LU to debug a program in full-screen mode using a dedicated terminal, the user must first exit the session manager panel and return to the Telnet Solicitor Logon panel.
- To display a USSMSG10 panel, specify a `USSTCP` statement. If your terminal emulator session supports the TN3270E protocol, the USSMSG10 panel can be customized to display the terminal LU name. See the *IBM Communication Server IP Configuration Reference* manual for information about how to create a new USS table load module that contains a USSMSG10 panel which includes the `@@LUNAME` parameter.
- To display a Telnet Solicitor Logon panel, code no additional statements.

If you want to restrict access for a terminal connected to this new port so that no one can use it to start any application and that no application other than z/OS Debugger can acquire it, then do the following steps:

1. Remove any statements from the port's `BEGINVTAM` block other than those recommended above.
2. Write only one `ALLOWAPPL` statement, specifying `EQAMVnnn` or, if you didn't use `EQAMVnnn`, the minor node name that z/OS Debugger uses for its side of the VTAM session.
3. Use the USSMSG10 panel or Telnet Solicitor Logon Panel display method.

After you make these changes to the TCP/IP configuration data set, you must instruct TCP/IP to use this updated definition and start the new port. The Telnet server uses the `VARY` command to change Telnet functions. One of the following commands can help you change Telnet functions:

VARY TCPIP, ,OBEYFILE

To start, restart or change a port by updating the Telnet profile. If you are running a TN3270 Telnet Server in a separate address space, you need to include the TN3270 Telnet Server *jobname* in the command. For example, `VARY TCPIP, ,jobname, OBEYFILE`.

VARY TCPIP, ,TELNET, STOP and VARY TCPIP, ,OBEYFILE

To stop a Telnet port, and then restart that port or a new port without stopping the TCP/IP stack.

See *IBM Communication Server IP Configuration Reference* for more information about the `VARY TCPIP` command.

After making these changes, your users can set up a unique terminal emulator session that connects to this new port, and debug programs that require the use of full-screen mode using a dedicated terminal.

Example: Activating full-screen mode using a dedicated terminal when using TCP/IP TN3270 Telnet Server

The examples below describe how to define the z/OS Debugger minor node names, define the terminal LUs for use by z/OS Debugger, and three ways to define Telnet ports that the TN3270 Telnet server can use.

After you code these definitions, you need activate these changes by using the `VARY NET` and `VARY TCPIP` commands as described previously.

Defining z/OS Debugger to VTAM

These are the z/OS Debugger minor node names defined to VTAM through VTAMLST:

```
EQAAPPL  VBUILD TYPE=APPL
EQAMV001 APPL  AUTH=(PASS,ACQ), PARSESS=NO
EQAMV002 APPL  AUTH=(PASS,ACQ), PARSESS=NO
EQAMV003 APPL  AUTH=(PASS,ACQ), PARSESS=NO
EQAMV004 APPL  AUTH=(PASS,ACQ), PARSESS=NO
EQAMV005 APPL  AUTH=(PASS,ACQ), PARSESS=NO
...
EQAMV050 APPL  AUTH=(PASS,ACQ), PARSESS=NO
```

See *hlq*.SEQASAMP (EQAWAPPL) for a sample of these definitions.

Defining the terminals used by z/OS Debugger

These are the terminal LUs defined to VTAM through VTAMLST:

```
EQATRML  VBUILD TYPE=APPL
TRMLU001 APPL  AUTH=NVPACE, EAS=1, PARSESS=NO, MODETAB=ISTINCLM, *
              SESSLIM=YES, DLOGMOD=D4C32XX3
TRMLU002 APPL  AUTH=NVPACE, EAS=1, PARSESS=NO, MODETAB=ISTINCLM, *
              SESSLIM=YES, DLOGMOD=D4C32XX3
TRMLU003 APPL  AUTH=NVPACE, EAS=1, PARSESS=NO, MODETAB=ISTINCLM, *
              SESSLIM=YES, DLOGMOD=D4C32XX3
TRMLU004 APPL  AUTH=NVPACE, EAS=1, PARSESS=NO, MODETAB=ISTINCLM, *
              SESSLIM=YES, DLOGMOD=D4C32XX3
TRMLU005 APPL  AUTH=NVPACE, EAS=1, PARSESS=NO, MODETAB=ISTINCLM, *
              SESSLIM=YES, DLOGMOD=D4C32XX3
...
TRMLU050 APPL  AUTH=NVPACE, EAS=1, PARSESS=NO, MODETAB=ISTINCLM, *
              SESSLIM=YES, DLOGMOD=D4C32XX3
```

See *hlq*.SEQASAMP (EQAWTRML) for a sample of these definitions.

Note that the DLOGMOD operand is specified. Change the TRMLU nnn names on the terminal LU APPL definition statements to names that meet your site convention for terminal LU names. These names must match the entries in the LUGROUP statements in the BEGINVTAM blocks shown in [“Example 1” on page 197](#), [“Example 2” on page 198](#), and [“Example 3” on page 198](#).

Configuring the TN3270 Telnet Server

The examples below highlight the changes made to the TCP/IP TN3270 server's configuration file.

Example 1

The example defines a new port (2023). When a user connects a terminal emulator session to this port, the Netview Access Services (NVAS) menu appears when the LU is created. The user copies the LU name that appears on the NVAS screen and specifies it as the value for the MFI%LU_name suboption of the TEST run-time option. After the user copies the LU name, the user exits NVAS and returns to the Telnet Solicitor Logon panel to make the terminal LU available to z/OS Debugger.

Each change is highlighted with a number in **reverse highlighting**. This number corresponds to the step number in the list of instructions in [“Configuring the TN3270 Telnet Server to access the terminal LUs” on page 195](#).

```
PORT
...
2 2023 TCP jobname NOAUTOLOG           ; Telnet Server - z/OS Debugger
...
;
; Define Telnet pool for z/OS Debugger
;
TELNETPARMS
4 PORT 2023
... the rest of this should be a copy of port 23
```

```

ENDTELNETPARMS

BEGINVTAM
4  PORT 2023

LUGROUP DBGTOOL
5c  TRMLU001..TRMLU050
  ENDLUGROUP

IPGROUP EVERYONE
5d  0.0.0.0:0.0.0.0
  ENDIPGROUP

5g1 DEFAULTAPPL NVAS FIRSTONLY
5e  LUMAP DBGTOOL EVERYONE KEEPOPEN
5f  ALLOWAPPL  EQAMV*
ENDVTAM

```

See *hlq*.SEQASAMP (EQAWTTS1) for a sample of these definitions.

Example 2

The example defines a new port (2023). When a user connects a terminal emulator session to this port, a USSMSG10 panel is displayed. The USSTCP statement is coded to point to a customized USSMSG10 panel that you defined that displays the LU name. The user copies this LU name and assigns it to the MFI%LU_ name suboption of the TEST runtime option. When the USSMSG10 panel is displayed, the terminal LU is available to z/OS Debugger.

Each change is highlighted with a number in **reverse highlighting**. This number corresponds to the step number in the list of instructions in [“Configuring the TN3270 Telnet Server to access the terminal LUs” on page 195](#).

```

PORT
2  ... 2023 TCP jobname NOAUTOLOG           ; Telnet Server - z/OS Debugger
  ...

;
; Define Telnet pool for z/OS Debugger
;
TELNETPARMS
4  PORT 2023
  ... the rest of this should be a copy of port 23
ENDTELNETPARMS

BEGINVTAM
4  PORT 2023

LUGROUP DBGTOOL
5c  TRMLU001..TRMLU050
  ENDLUGROUP

IPGROUP EVERYONE
5d  0.0.0.0:0.0.0.0
  ENDIPGROUP

5g2 USSTCP USS$EQAW EVERYONE
5e  LUMAP DBGTOOL EVERYONE KEEPOPEN
5f  ALLOWAPPL  EQAMV*
ENDVTAM

```

See *hlq*.SEQASAMP (EQAWTTS2) for a sample of these definitions.

Example 3

The example defines a new port (2023). When the user connects a terminal emulator session to this port, the Telnet Solicitor Logon panel is displayed, and the terminal LU is available to z/OS Debugger. The user copies the LU name from the terminal emulator session's information area and assigns it to the MFI%LU_ name suboption of the TEST runtime option.

Each change is highlighted with a number in **reverse highlighting**. This number corresponds to the step number in the list of instructions in [“Configuring the TN3270 Telnet Server to access the terminal LUs” on page 195](#).

```
PORT
 2 2023 TCP jobname NOAUTOLOG          ; Telnet Server - z/OS Debugger
  ...
;
; Define Telnet pool for z/OS Debugger
;
TELNETPARMS
 4  PORT 2023
  ... the rest of this should be a copy of port 23
ENDTELNETPARMS

BEGINVTAM
 4  PORT 2023

LUGROUP DBGTOOL
 5c TRMLU001..TRMLU050
ENDLUGROUP

IPGROUP EVERYONE
 5d 0.0.0.0:0.0.0.0
ENDIPGROUP

 5e LUMAP DBGTOOL EVERYONE KEEPOPEN
 5f ALLOWAPPL EQAMV*
ENDVTAM
```

See *h1q*.SEQASAMP (EQAWTTS3) for a sample of these definitions.

Verifying the customization of the facility to debug full-screen mode using a dedicated terminal

Connect a terminal emulator session to one of the terminal LUs setup as described previously in this chapter. Issue the DISPLAY command from your system console as shown in [“Terminal LU state requirements” on page 194](#). Verify that the output of the DISPLAY command is correct. If the output of the DISPLAY command is not correct, you must review every step in [“Enabling full-screen mode using a dedicated terminal” on page 192](#) and verify that you completed each step correctly. Then run one of the install verification jobs described below.

To help you verify the installation of the facility to debug full-screen mode using a dedicated terminal, the *h1q*.SEQASAMP data set contains the following installation verification program (IVP) jobs:

- EQAWIVP5 (COBOL)
- EQAWIVP6 (C)
- EQAWIVP7 (PL/I)
- EQAWIVP9 (Enterprise PL/I)
- EQAWIVPB (Language Environment assembler)
- EQAWIVPD (non-Language Environment assembler)
- EQAWIVPW (OS/VS COBOL)
- EQAWIVPY (non-Language Environment VS COBOL II)

Before you run a sample, customize it for your installation as described in the sample.

Using z/OS Debugger Terminal Interface Manager as a dedicated terminal

The z/OS Debugger Terminal Interface Manager enables a user to debug in full-screen mode using a dedicated terminal without having to know the LU name of the dedicated terminal. Use the z/OS Debugger Terminal Interface Manager because it makes it easier for users to identify the terminals to use for their debugging sessions.

Complete the steps in “[Enabling full-screen mode using a dedicated terminal](#)” on page 192 before you do the instructions in this section to ensure that the basic full-screen mode using a dedicated terminal function works at your site.

Example: a debugging session using the z/OS Debugger Terminal Interface Manager

Compare the following steps with the steps shown in “[How z/OS Debugger uses full-screen mode using a dedicated terminal](#)” on page 191 to understand how using the Terminal Interface Manager affects the flow of work.

1. Start two terminal emulator sessions. These sessions can be either of the following situations:

- Two separate terminal emulator sessions.
- If you use IBM Session Manager, two sessions selected from the IBM Session Manager menu.

In either situation, ensure that the second session connects to a terminal that can handle a full-screen mode debugging session through a dedicated terminal and that starts z/OS Debugger Terminal Interface Manager.

2. On the first terminal emulator session, log on to TSO.

3. On the second terminal emulator session, provide your login credentials to the Terminal Interface Manager and press Enter. The login credentials can be your TSO user ID and password, PassTicket, password phrase, or MFA token.

Notes:

- a. You are not logging on TSO. You are indicating that you want your user ID associated with this terminal LU.
- b. When the number of characters entered into the password field, including blanks, exceeds 8, the input is passed to the security system as a password phrase.
- c. To use PassTickets with Terminal Interface Manager, define the PTKTDATA profile by following the rules for MVS batch jobs. For more information, see [Defining profiles in the PTKTDATA class](#) in the z/OS documentation.

A panel similar to the following panel is then displayed on the second terminal emulator session:

z/OS Debugger TERMINAL INTERFACE MANAGER

```
EQAY001I Terminal TRMLU001 connected for user USER1
EQAY001I Ready for z/OS Debugger
```

```
PF12=LOGOFF          PF3=EXIT  PF10=Edit LE options data set
```

The terminal is now ready to receive a z/OS Debugger full-screen mode using a dedicated terminal session.

4. Edit the PARM string of your batch job so that you specify the TEST runtime parameter as follows:

```
TEST(,,VTAM%userid:*)
```

5. Submit the batch job.

The tasks completed are similar to the tasks described in step “5” on page 191 except that first the batch job communicates with the Terminal Interface Manager to correlate the user ID to the terminal LU of the second terminal emulator session. The remaining steps are the same as described in step “5” on page 191.

6. On the second terminal emulator session, a full-screen mode debugging session is displayed. Interact with it the same way you would with any other full-screen mode debugging session.
7. After you exit z/OS Debugger, the second terminal emulator session displays the panel and messages you saw in step “3” on page 200. This indicates that z/OS Debugger can use this session again. (this will happen each time you exit from z/OS Debugger).
8. If you want to start another debugging session, return to step “5” on page 201. If you are finished debugging, you can do one of the following tasks:
 - Close the second terminal emulator session.
 - Exit the Terminal Interface Manager by choosing one of the following options:
 - Press PF12 to display the Terminal Interface Manager logon panel. You can log in with the same ID or a different user ID.
 - Press PF3 to exit the Terminal Interface Manager.

Enabling full-screen mode using a dedicated terminal with z/OS Debugger Terminal Interface Manager

To enable full-screen mode using a dedicated terminal with z/OS Debugger Terminal Interface Manager, do the following steps:

1. Define the VTAM APPL definition statements as described in [“Defining the Terminal Interface Manager APPL definition statements” on page 202](#).
2. Start the z/OS Debugger Terminal Interface Manager as described in [“Starting the z/OS Debugger Terminal Interface Manager as a dedicated terminal” on page 202](#).

3. Configure the Telnet Server as described in [“Configuring the TN3270 Telnet Server to access the Terminal Interface Manager”](#) on page 203.
4. Verify that the customizations are completed correctly by following the steps in [“Verifying the customization of the Terminal Interface Manager”](#) on page 206.

Defining the Terminal Interface Manager APPL definition statements

You must define the APPL definition statements that the Terminal Interface Manager will use for its sessions. To define the APPL definition statements, do the following steps:

1. Define the APPL definition statements as shown in the EQAWSESS member in the *hlq.SEQASAMP* data set by doing one of the following tasks:
 - Copy EQAWSESS into a new member:
 - a. Create a new member in the VTAM definitions library (VTAMLST). The VTAM definitions library is often stored in the data set SYS1.VTAMLST.
 - b. Copy the contents of the EQAWSESS member into the new member.
 - c. Add the new member's name to the VTAM start options configuration file, ATCCONxx.
 - Copy EQAWSESS into an existing member:
 - a. Select a member in the VTAM definitions library (VTAMLST) that contains the major node definitions.
 - b. Copy the APPL definition statements for z/OS Debugger from the EQAWSESS member into the selected member.

To activate the new definitions, enter the following command from the console:

```
VARY NET,ACT,ID=member-name
```

member-name is the member name in the VTAM definitions library.

Starting the z/OS Debugger Terminal Interface Manager as a dedicated terminal

The z/OS Debugger Terminal Interface Manager is a VTAM application that must be started (following the start of VTAM itself) before users can access it. Follow these steps to start it:

1. Copy the EQAYSESM member of the data set *hlq.SEQASAMP* to the SYS1.PROCLIB data set, making any changes required by your installation.
2. Make sure that the z/OS Debugger Terminal Interface Manager load modules, EQAYSESM and EQAYTRMM, resides in an APF authorized library (this module can be found in the *hlq.SEQAAUTH* data set). This is required to allow access to functions to validate users by login credentials.
3. Start the z/OS Debugger Terminal Interface Manager using the START command from the console. The START command can be added to the COMMNDxx member of SYS1.PARMLIB to start the z/OS Debugger Terminal Interface Manager when the system is IPLed.

The z/OS Debugger Terminal Interface Manager load module accepts three parameters, which you can provide by using the OPTS substitution variable on the START command or in the EQAYSESM PROC definition. You can code the parameters in any sequence and all of them are optional. The following list describes the parameters:

-a *acbname*

Specifies an alternate VTAM ACB name for Terminal Interface Manager to open. For more information about this parameter, see [“Running the Terminal Interface Manager on more than one LPAR on the same VTAM network”](#) on page 204.

-s

Instructs Terminal Interface Manager to supply an additional entry field on each Terminal Interface Manager panel, in which the user can enter an IBM Session Manager escape sequence. For more

information about this parameter, see [“Configuring Terminal Interface Manager as an IBM Session Manager application”](#) on page 205.

+T

Turns on internal tracing for Terminal Interface Manager. Do not use this parameter unless instructed by IBM support personnel.

The following example starts the z/OS Debugger Terminal Interface Manager for alternate ACB EQASESS2 and instructs it to provide an extra entry field for use with IBM Session Manager:

```
START EQAYSESM,OPTS='-a EQASESS2 -s'
```

Configuring the TN3270 Telnet Server to access the Terminal Interface Manager

Select an additional unused port (for example, 2024) and then implement [“Example 1”](#) on page 197 with the following changes:

- Specify port 2024 instead of 2023 (3 times)
- Specify the following value for the DEFAULTAPPL statement:

```
DEFAULTAPPL EQASESSM FIRSTONLY
```

- Make the following change on the ALLOWAPPL statement:

```
ALLOWAPPL EQA*
```

Example 4

The example below shows the modified [“Example 1”](#) on page 197, with the changes highlighted with an asterisk (*).

```
PORT
...
* 2024 TCP jobname NOAUTOLOG           ; Telnet Server - z/OS Debugger
...

; Add a TELNETPARMS block for the new port

TELNETPARMS
* PORT 2024                           ; z/OS Debugger
... the rest of this should be a copy of the existing Port 23
ENDTELNETPARMS

; Add a BEGINVTAM block for the new port

BEGINVTAM
* PORT 2024

; Define the VTAM terminal LUs to use for this port (see EQAWTRML)

LUGROUP DBGTOOL
      TRMLU001..TRMLU050
ENDLUGROUP

; Allow anyone with access to this system to use the LUs above

IPGROUP EVERYONE
      0.0.0.0:0.0.0.0
ENDIPGROUP

; The z/OS Debugger Terminal Interface
Manager will be displayed
; when an emulator connects

* DEFAULTAPPL EQASESSM FIRSTONLY

; Indicate that the ACBs always be allocated

LUMAP DBGTOOL EVERYONE KEEPOPEN

; Allow only z/OS Debugger to use this port
```

```
* ALLOWAPPL EQA*
```

```
ENDVTAM
```

See `hlq.SEQASAMP (EQAWTTS4)` for a sample of these definitions.

Instruct TCP/IP to use this additional definition, as described on page [“Configuring the TN3270 Telnet Server to access the terminal LUs”](#) on page 195.

After you make these changes, your users can set up a unique terminal emulator session that connects to this new port, and debug programs that require the use of full-screen mode using a dedicated terminal with the z/OS Debugger Terminal Interface Manager. The user does the following steps:

1. Starts a terminal emulator session that connects to this new port. The z/OS Debugger Terminal Interface Manager is displayed.
2. The user enters his user ID and password and then presses Enter. The terminal is now ready to receive a z/OS Debugger full-screen mode using a dedicated terminal session.
3. On another terminal emulator session, the user starts his program with the TEST run-time option and specifies the `VTAM%userid` suboption. The terminal emulator session connected to this new port displays a full-screen mode using a dedicated terminal session.

Example: Connecting a VTAM network with multiple LPARs with one Terminal Interface Manager

This example describes the connections that need to be made in a VTAM network that has four LPARs that run z/OS Debugger jobs with one of the LPARs managing the terminals.

- LPAR 1 runs a TN3270E server and the Terminal Interface Manager with the default ACB name. Its VTAM also owns all the terminal LUs. Users connect their TN3270E emulator to this LPAR for the Terminal Interface Manager session. Users use the Terminal Interface Manager to create the connection between z/OS Debugger and the terminal LU used for their full-screen mode using a dedicated terminal debugging session.
- VTAM on LPAR1 defines the terminal LU APPL definition statements and the EQASESSM APPL definition statement for the Terminal Interface Manager.
- VTAM on LPAR 1 needs visibility to the EQAMVnnn APPL definition statements on LPARs 2, 3 and 4. This enables communication between the Terminal Interface Manager and z/OS Debugger.
- Each VTAM on LPAR 1, 2, 3 and 4 has a unique set of EQAMVnnn APPL definition statements. For example, LPAR 1 has APPL definition statements 001-050, LPAR 2 has APPL definition statements 051-100, LPAR 3 has APPL definition statements 101-150, and LPAR 4 has APPL definition statements 151-200.
- Each VTAM on LPAR 2, 3 and 4 needs visibility to the EQASESSM APPL definition statement on LPAR 1. This enables communication between z/OS Debugger and the Terminal Interface Manager.
- Each VTAM on LPAR 2, 3 and 4 needs visibility to the terminal LU APPL definition statements on LPAR 1.

Running the Terminal Interface Manager on more than one LPAR on the same VTAM network

This topic describes the modifications you need to make to the steps described in [“Defining the Terminal Interface Manager APPL definition statements”](#) on page 202, [“Starting the z/OS Debugger Terminal Interface Manager as a dedicated terminal”](#) on page 202, and [“Configuring the TN3270 Telnet Server to access the Terminal Interface Manager”](#) on page 203 in order to make full-screen mode using a dedicated terminal with Terminal Interface Manager work in an environment where you want to run the Terminal Interface Manager on more than one LPAR in the same VTAM network.

Do the following steps for each additional instance of the Terminal Interface Manager:

1. In [“Defining the Terminal Interface Manager APPL definition statements”](#) on page 202, after you have copied EQAWSESS into a new or existing member, modify it so that you specify an ACB name other than the default EQASESSM.

By default, z/OS Debugger assumes you work in an environment where you use only one instance of Terminal Interface Manager and the default ACB name used by this instance of Terminal Interface Manager and z/OS Debugger is EQASESSM. By specifying the ACB name used by the Terminal Interface Manager (instead of using the default name), you can create a unique ACB name for each instance of the Terminal Interface Manager.

2. In [“Starting the z/OS Debugger Terminal Interface Manager as a dedicated terminal”](#) on page 202, after you copy the EQAYSESM member to the SYS1.PROCLIB data set, modify it to specify the new ACB name you created in step [“1”](#) on page 205 by specifying OPTS= ' -a XXXXXXXX', where XXXXXXXX is the new ACB name.
3. In [“Configuring the TN3270 Telnet Server to access the Terminal Interface Manager”](#) on page 203, when you modify the TCP/IP TN3270 server's configuration file, modify the DEFAULTAPPL statement to specify the ACB name you created in step [“1”](#) on page 205, instead of EQASESSM.
4. Specify the EQAOPTS TIMACB command, as described in [“TIMACB”](#) on page 186, using the new ACB name you created in step [“1”](#) on page 205 for *ACB-name*.

Configuring Terminal Interface Manager as an IBM Session Manager application

To define z/OS Debugger Terminal Interface Manager as an application within IBM Session Manager, do the following steps:

1. Define a TN3270 port and a group of terminal LUs which start Terminal Interface Manager as described in [“Configuring the TN3270 Telnet Server to access the Terminal Interface Manager”](#) on page 203.
2. Enable the IBM Session Manager TCP/IP support, as described in *IBM Session Manager for z/OS: Installation and Getting Started*.
3. Define Terminal Interface Manager to IBM Session Manager as a TCP/IP application. To do this, create an APPL statement in the IBM Session Manager configuration, similar to the following statement:

```
APPL applname      APPLID TCP_1
                   DESC 'description'
                   DATA 'protocol://host-addr:port'
```

The following list describes the variables used in this statement:

applname

Your choice for the application name. This is the name used when referring to the application in other IBM Session Manager definitions.

description

The descriptive text you want displayed on any session menus.

protocol

One of the following values: TELNET, TN3270 or TN3270E. For a description of these protocols, see [“Session Manager and TCP/IP”](#) in *IBM Session Manager: Facilities Reference*.

host-addr

The hostname or IP address of the server that hosts Terminal Interface Manager.

port

The port number that was configured for Terminal Interface Manager in step [“1”](#) on page 205.

For a complete description of the IBM Session Manager APPL configuration statement, see *IBM Session Manager: Technical Reference*.

The following example shows an APPL statement:

```
APPL DTTIM
    APPLID TCP_1
```

```
DESC 'z/OS Debugger Terminal Interface  
Manager'  
DATA 'TN3270E://mvsa.ibm.com:2024'
```

4. Start the Terminal Interface Manager started task with the -s parameter. This causes the Terminal Interface Manager panels to display an extra field where you can enter the IBM Session Manager escape key.

Verifying the customization of the Terminal Interface Manager

Do the following steps to verify the installation and customization:

1. Start a terminal emulator session that starts the Terminal Interface Manager. Enter your user ID and password and then press Enter.
2. On your other terminal emulator session, select the same IVP as you used above, change the run time parameter string from `MFI%VTAM_LU_id:*` to `VTAM%userid:*`, submit the job and then follow the rest of the instructions in the IVP.
3. On your other terminal emulator session, select the same IVP as you used above, change the runtime parameter string from `MFI%LU_name:*` to `VTAM%userid:*`, submit the job and then follow the rest of the instructions in the IVP.

Appendix C. Applying maintenance

Support resources and problem solving information describes all the resources available to obtain technical support information. Follow the steps in this section to apply a service APAR or PTF.

Applying Service APAR or PTF

This chapter describes how to apply service updates to z/OS Debugger. To use the maintenance procedures effectively, you must install the product or products by using SMP/E before doing the maintenance procedures below.

What you receive

If you report a problem with z/OS Debugger to your IBM Support Center, you may receive a tape containing one or more Authorized Program Analysis Reports (APARs) or Program Temporary Fixes (PTFs) that were created to solve your problem.

You may also receive a list of prerequisite APARs or PTFs, which you must apply to your system before applying the current APAR. These prerequisite APARs or PTFs might relate to z/OS Debugger or any other licensed product you have installed, including z/OS.

Checklist for applying an APAR or PTF

The following checklist describes the steps and associated SMP/E commands to install the APAR or PTF:

1. Prepare to install the APAR or PTF.
2. Receive the APAR or PTF. (SMP/E RECEIVE)
3. Review the HOLDDATA.
4. Accept previously applied APARs or PTFs (optional). (SMP/E ACCEPT)
5. Apply APAR or PTF. (SMP/E APPLY)
6. Run REPORT CROSSZONE and apply any missing requisites.
7. Test APAR or PTF.
8. Accept APAR or PTF. (SMP/E ACCEPT)

Step 1. Prepare to install APAR or PTF

Before you start to install an APAR or PTF, do the following:

1. Create a backup copy of the current z/OS Debugger libraries. Save this copy of z/OS Debugger until you have completed installing the APAR or PTF, and you are confident that the service runs correctly.
2. Research each service tape through the IBM Support Center for any errors or additional information. Note all errors on the tape that were reported by APARs or PTFs and apply the relevant fixes. You should also review the current Preventive Service Planning (PSP) information.

Step 2. Receive the APAR or PTF

Receive the service using the SMP/E RECEIVE command from either the SMP/E dialogs in ISPF, or using a batch job similar to EQAWRECV in *hlq*.SEQASAMP.

Step 3. Review the HOLDDATA

Review the HOLDDATA summary reports for the APAR or PTF. Follow any instructions described in the summary reports.

Step 4. Accept previously applied APAR or PTF (optional)

If there is any APAR or PTF which you applied earlier but did not accept, and the earlier APAR or PTF is not causing problems in your installation, accept the applied service from either the SMP/E dialogs in ISPF, or using a batch job similar to EQAWACPT in *hlq*.SEQASAMP.

Accepting the earlier service allows you to use the SMP/E RESTORE command to return to your current level if you encounter a problem with the service you are currently applying. You can do this either from the SMP/E dialogs in ISPF, or using a batch job.

Step 5. Apply the APAR or PTF

We recommend you first use the SMP/E APPLY command with the CHECK operand. Check the output; if it shows no conflict, rerun the APPLY command without the CHECK operand. This can be done from the SMP/E dialogs in ISPF or using a batch job similar to EQAWAPLY in *hlq*.SEQASAMP.

Step 6. Run REPORT CROSSZONE and apply any missing requisites

Run an SMP/E REPORT CROSSZONE by using the SMP/E dialogs or by using a batch job similar to EQAWRPXZ in *hlq*.SEQASAMP. Apply any missing requisites found by SMP/E.

Step 7. Test the APAR or PTF

Thoroughly test your updated z/OS Debugger. Do not accept an APAR or PTF until you are confident that it runs correctly.

Step 8. Accept the APAR or PTF

We recommend you first use the SMP/E ACCEPT command with the CHECK operand. Check the output; if it shows no conflict, rerun the ACCEPT command without the CHECK operand. You can do this either from the SMP/E dialogs in ISPF, or using a batch job similar to EQAWACPT in *hlq*.SEQASAMP.

Appendix D. Support resources and problem solving information

This section shows you how to quickly locate information to help answer your questions and solve your problems. If you have to call IBM support, this section provides information that you need to provide to the IBM service representative to help diagnose and resolve the problem.

Accessing the IBM Support portal

You must be a registered user on the IBM Support portal to download fixes and to submit a problem online to the IBM Support community.

If you need to look beyond [IBM Documentation](#) to answer your question or resolve your problem, you can use one or more of the following approaches:

- Open the [IBM Support portal](#).
- Click  to log in using your IBM.com username.
- On the IBM Support portal, you can do the following tasks:
 - Search for known issues, documentation, and support forums.
 - Open a case or view cases you opened.
 - Open a chat window with a Support representative.
 - Open Fix Central to view product downloads and updates.
 - Access product documentation and support forums.
 - Manage your support account, including notifications, invoices, orders, contracts, and warranties. For more information about notifications, see [“Subscribing to support updates”](#) on page 209.

Getting fixes

A product fix might be available to resolve your problem. To determine what fixes and other updates are available, select a link from the following list:

- [Latest PTFs for z/OS Debugger](#)
- [Latest PTFs for IBM Developer for z/OS Enterprise Edition](#)
- [Latest PTFs for ADFz Common Components](#)

When you find a fix that you are interested in, click the name of the fix to read its description and to optionally download the fix.

Subscribe to receive e-mail notifications about fixes and other IBM Support information as described in [Subscribing to Support updates](#).

Subscribing to support updates

To receive automatic updates when IBM publishes new support content for your products, subscribe to weekly email updates or RSS feeds. Support content might include information about new releases, fixes, technotes, APARs, and support flashes.

To sign up for email updates, you must be a registered user on the IBM Support community website.

To subscribe to Support updates, follow the steps below.

1. Open the [IBM Support portal website](#).
2. Click  to log in using your IBM.com username.

3. Click **Manage support account > Notifications** to view your notifications.
4. Type the product name in the search field or click **Browse for a product**.
5. Type the product name in the **Product lookup** field, or click **Browse for a product**.
6. Click **Subscribe** beside your product, and in the **Select document types** window, select the types of documents for which you want to receive information. Click **Submit**.
7. Optionally, you can click the RSS/Atom feed by clicking **Links**. Then, copy and paste the link into your feeder.
8. To see any notifications that were sent to you, click **View**.

Contacting IBM Support

To submit your problem to IBM Support, you must have an active Passport Advantage® software maintenance agreement. Passport Advantage is the IBM comprehensive software licensing and software maintenance (product upgrades and technical support) offering. You can enroll online on the [Passport Advantage](#) website.

- To learn more about Passport Advantage, see the [Passport Advantage FAQs](#).
- For further assistance, contact your IBM representative.

To submit your problem online (from the IBM website) to IBM Support:

- Be a registered user on the IBM Support website. For details about registering, see [Registering on the IBM Support website](#).
- Be listed as an authorized caller in the service request tool.

Determine the business impact of your problem

When you report a problem to IBM, you are asked to supply a severity level. Therefore, you must understand and assess the business impact of the problem that you are reporting.

Severity 1

The problem has a *critical* business impact: You are unable to use the program, resulting in a critical impact on operations. This condition requires an immediate solution.

Severity 2

This problem has a *significant* business impact: The program is usable, but it is severely limited.

Severity 3

The problem has *some* business impact: The program is usable, but less significant features (not critical to operations) are unavailable.

Severity 4

The problem has *minimal* business impact: The problem causes little impact on operations or a reasonable circumvention to the problem was implemented.

Gather diagnostic information

To save time, if there is a MustGather document available for the product, refer to the MustGather document and gather the information specified. MustGather documents contain specific instructions for submitting your problem to IBM and gathering information needed by the IBM support team to resolve your problem. To determine if there is a MustGather document for this product, go to the product support page and search on the term MustGather. At the time of this publication, the following MustGather documents are available:

- MustGather: Read first for problems encountered with z/OS Debugger: <https://www.ibm.com/support/pages/node/89125>
- MustGather: Read first for problems encountered with code coverage: <https://www.ibm.com/support/pages/node/6561317>

If the product does not have a MustGather document, provide answers to the following questions:

- What software versions were you running when the problem occurred?
- Do you have logs, traces, and messages that are related to the problem symptoms? IBM Software Support is likely to ask for this information.
- Can you re-create the problem? If so, what steps were performed to re-create the problem?
- Did you make any changes to the system? For example, did you make changes to the hardware, operating system, networking software, and so on.
- Are you currently using a workaround for the problem? If so, be prepared to explain the workaround when you report the problem.

Submit the problem to IBM Support

You can submit your problem to IBM Support in the following ways:

- Online: Open the [IBM Support community website](#). Click **Open a case** to open a service request and describe the problem in detail.
- By phone: For the phone number to call in your country or region, see the [IBM Directory of worldwide contacts](#) and click the name of your country or geographic region.
- Through your IBM Representative: If you cannot access IBM Support online or by phone, contact your IBM Representative. If necessary, your IBM Representative can open a service request for you. You can find complete contact information for each country at [IBM Directory of worldwide contacts](#).

If the problem you submit is for a software defect or for missing or inaccurate documentation, IBM Support creates an Authorized Program Analysis Report (APAR). The APAR describes the problem in detail. Whenever possible, IBM Support provides a workaround that you can implement until the APAR is resolved and a fix is delivered. IBM publishes resolved APARs on the IBM Support website daily, so that other users who experience the same problem can benefit from the same resolution.

Appendix E. Accessibility

Accessibility features help a user who has a physical disability, such as restricted mobility or limited vision, to use software products successfully. The accessibility features in z/OS provide accessibility for z/OS Debugger.

The major accessibility features in z/OS enable users to:

- Use assistive technology products such as screen readers and screen magnifier software
- Operate specific or equivalent features by using only the keyboard
- Customize display attributes such as color, contrast, and font size

IBM Documentation, and its related publications, are accessibility-enabled. The accessibility features of the information center are described at <https://www.ibm.com/docs>.

Using assistive technologies

Assistive technology products work with the user interfaces that are found in z/OS. For specific guidance information, consult the documentation for the assistive technology product that you use to access z/OS interfaces.

Keyboard navigation of the user interface

Users can access z/OS user interfaces by using TSO/E or ISPF. Refer to *z/OS TSO/E Primer*, *z/OS TSO/E User's Guide*, and *z/OS ISPF User's Guide Volume 1* for information about accessing TSO/E and ISPF interfaces. These guides describe how to use TSO/E and ISPF, including the use of keyboard shortcuts or function keys (PF keys). Each guide includes the default settings for the PF keys and explains how to modify their functions.

Accessibility of this document

Information in the following format of this document is accessible to visually impaired individuals who use a screen reader:

- HTML format when viewed from IBM Documentation
- PDF format

Syntax diagrams start with the word Format or the word Fragments. Each diagram is preceded by two images. For the first image, the screen reader will say "Read syntax diagram". The associated link leads to an accessible text diagram. When you return to the document at the second image, the screen reader will say "Skip visual syntax diagram" and has a link to skip around the visible diagram.

Notices

This information was developed for products and services offered in the U.S.A. IBM might not offer the products, services, or features discussed in this document in other countries. Consult your local IBM representative for information on the products and services currently available in your area. Any reference to an IBM product, program, or service is not intended to state or imply that only that IBM product, program, or service may be used. Any functionally equivalent product, program, or service that does not infringe any IBM intellectual property right may be used instead. However, it is the user's responsibility to evaluate and verify the operation of any non-IBM product, program, or service.

IBM may have patents or pending patent applications covering subject matter in this document. The furnishing of this document does not give you any license to these patents. You can send license inquiries, in writing, to:

IBM Corporation
J46A/G4
555 Bailey Avenue
San Jose, CA 95141-1003
U.S.A.

For license inquiries regarding double-byte (DBCS) information, contact the IBM Intellectual Property Department in your country or send inquiries, in writing, to:

Intellectual Property Licensing
Legal and Intellectual Property Law
IBM Japan, Ltd.
3-2-12, Roppongi, Minato-ku, Tokyo 106-8711

The following paragraph does not apply to the United Kingdom or any other country where such provisions are inconsistent with the local law:

INTERNATIONAL BUSINESS MACHINES CORPORATION PROVIDES THIS PUBLICATION "AS IS" WITHOUT WARRANTY OF ANY KIND, EITHER EXPRESS OR IMPLIED, INCLUDING, BUT NOT LIMITED TO, THE IMPLIED WARRANTIES OF NON-INFRINGEMENT, MERCHANTABILITY OR FITNESS FOR A PARTICULAR PURPOSE.

Some states do not allow disclaimer of express or implied warranties in certain transactions; therefore, this statement might not apply to you.

This information could include technical inaccuracies or typographical errors. Changes are periodically made to the information herein; these changes will be incorporated in new editions of the publication. IBM may make improvements and/or changes in the product(s) and/or the program(s) described in this publication at any time without notice.

Trademarks and service marks

IBM, the IBM logo, and ibm.com are trademarks or registered trademarks of International Business Machines Corp., registered in many jurisdictions worldwide. Other product and service names might be trademarks of IBM or other companies. A current list of IBM trademarks is available on the web at "Copyright and trademark information" at www.ibm.com/legal/copytrade.shtml.

Other company, product, or service names may be trademarks or service marks of others.

Glossary

This glossary defines technical terms and abbreviations used in *IBM z/OS Debugger Customization Guide* documentation. If you do not find the term you are looking for, refer to the *IBM Glossary of Computing Terms*, located at the IBM Terminology web site:

<http://www.ibm.com/ibm/terminology>

B

batch

Pertaining to a predefined series of actions performed with little or no interaction between the user and the system. Contrast with *interactive*.

batch job

A job submitted for batch processing. See *batch*. Contrast with *interactive*.

C

compile

To translate a program written in a high level language into a machine-language program.

compile unit

A sequence of HLL statements that make a portion of a program complete enough to compile correctly. Each HLL product has different rules for what comprises a compile unit.

compiler

A program that translates instructions written in a high level programming language into machine language.

D

data set

The major unit of data storage and retrieval, consisting of a collection of data in one of several prescribed arrangements and described by control information to which the system has access.

debug

To detect, diagnose, and eliminate errors in programs.

DTCN

z/OS Debugger Control utility, a CICS transaction that enables the user to identify which CICS programs to debug.

debugging profile

Data that specifies a set of application programs which are to be debugged together.

E

eXtra Performance LINKage (XPLINK)

A new call linkage between functions that has the potential for a significant performance increase when used in an environment of frequent calls between small functions. XPLINK makes subroutine calls more efficient by removing nonessential instructions from the main path. When all functions are compiled with the XPLINK option, pointers can be used without restriction, which makes it easier to port new applications to z/OS.

F

full-screen mode

An interface mode for use with a nonprogrammable terminal that displays a variety of information about the program you are debugging.

H

hook

An instruction inserted into a program by a compiler when you specify the TEST compile option. Using a hook, you can set breakpoints to instruct z/OS Debugger to gain control of the program at selected points during its execution.

I

index

A computer storage position or register, the contents of which identify a particular element in a table.

L

link-edit

To create a loadable computer program using a linkage editor.

load module

A program in a form suitable for loading into main storage for execution. In this document this term is also used to refer to a Dynamic Load Library (DLL).

logical window

A group of related debugging information (for example, variables) that is formatted so that it can be displayed in a physical window.

LU

See [logical unit](#).

logical unit

A type of network accessible unit that enables users to gain access to network resources and communicate with each other.

A name used by VTAM to identify a terminal or other resource.

M

minor node

In VTAM, a uniquely defined resource within a major node.

multitasking

A mode of operation that provides for concurrent performance, or interleaved execution of two or more tasks.

N

network identifier

In TCP/IP, that part of the IP address that defines a network. The length of the network ID depends on the type of network class (A, B, or C).

node name

The name assigned to a node during network definition. The format for the node name is *netid.cpname*.

O

offset

The number of measuring units from an arbitrary starting point to some other point.

P

parameter

Data passed between programs or procedures.

partitioned data set (PDS)

A data set in direct access storage that is divided into partitions, called members, each of which can contain a program, part of a program, or data.

PDS

See *partitioned data set*.

physical window

A section of the screen dedicated to the display of one of the four logical windows: Monitor window, Source window, Log window, or Memory window.

PLU

See *primary logical unit*.

primary logical unit

In SNA, the logical unit that contains the primary half-session for a particular logical unit-to-logical unit (LU-to-LU) session.

In SNA, the logical unit (LU) that sends the BIND to activate a session with its partner LU.

profile

A group of customizable settings that govern how the user's session appears and operates.

program

A sequence of instructions suitable for processing by a computer. Processing can include the use of an assembler, a compiler, an interpreter, or a translator to prepare the program for execution, as well as to execute it.

S

secondary logical unit

In SNA, the logical unit (LU) that contains the secondary half-session for a particular LU-LU session. An LU may contain secondary and primary half-sessions for different active LU-LU sessions.

A VTAM Secondary Logical Unit (i.e., terminal).

session

The events that take place between the time the user starts an application and the time the user exits the application.

SIMLOGON

A VTAM macro instruction that initiates a session in which the application program acts as the PLU.

Single Point of Control

The control interface that sends commands to one or more members of an IMSplex and receives command responses.

SLU

See [secondary logical unit](#).

SPOC

See [Single Point of Control](#).

statement

An instruction in a program or procedure.

In programming languages, a language construct that represents a step in a sequence of actions or a set of declarations.

U

utility

A computer program in general support of computer processes; for example, a diagnostic program, a trace program, or a sort program.

V

VTAM

See [Virtual Telecommunications Access Method](#).

Virtual Telecommunications Access Method (VTAM)

IBM software that controls communication and the flow of data in an SNA network by providing the SNA application programming interfaces and SNA networking functions. An SNA network includes subarea networking, Advanced Peer-to-Peer Networking (APPN), and High-Performance Routing (HPR). Beginning with Release 5 of the OS/390 operating system, the VTAM for MVS/ESA function was included in Communications Server for OS/390; this function is called Communications Server for OS/390 - SNA Services.

An access method commonly used by MVS to communicate with terminals and other communications devices.

X

XPLINK

See [eXtra Performance LINKage \(XPLINK\)](#).

IBM z/OS Debugger publications

You can access the IBM z/OS Debugger publications by visiting any of the following pages:

- IBM Debug for z/OS:
 - IBM Documentation: https://www.ibm.com/docs/SSVSZX_16.0.0/com.ibm.debug.z.doc/topics/pdf.html
 - Library page: <https://www.ibm.com/support/pages/node/713283>
- IBM Developer for z/OS:
 - IBM Documentation: https://www.ibm.com/docs/SSQ2R2_16.0.0/com.ibm.debug.z.doc/topics/pdf.html
 - Library page: <https://www.ibm.com/support/pages/node/713179>
- IBM Z and Cloud Modernization Stack:
 - IBM Documentation: https://www.ibm.com/docs/SSV97FN_latest/com.ibm.debug.z.doc/topics/pdf.html

Index

Special Characters

[./E, BTS Environment command 81](#)
[&PGMNAME 81](#)
[&USERID 81](#)

A

accessing
 another language by using NATLANG [90](#)
activating
 SVCs without using a system IPL [9](#)
 z/OS Debugger definitions to VTAM [20](#),
 [193](#)
Address space count [48](#)
ALLOWAPPL EQAMV*
 specifying, statement [195](#)
AOR example [120](#)
AOR example, application does not use terminal [122](#)
APPL definition statements [19](#), [192](#)
assembler, definition of [xi](#)
assigning
 values to NATLANG, LOCALE, and LINECOUNT [145](#)
AT-TLS configuration, PROFILE.TCPIP [36](#)
AT-TLS policy [37](#)
AT-TLS policy activation [42](#)
AT-TLS security updates [39](#)
AT-TLS setup [35](#)
authentication, Debug Manager [42](#)
authorizing
 Dynamic Debug facility to access programs in protected
 storage [11](#)

B

browse mode
 controlled by EQAOPTS [156](#)
 controlled by RACF [87](#)
 setting up facility access [87](#)
 setting up user access [88](#)
BTS Environment command (./E), when to use [81](#)

C

CCSID [160](#)
CEEBXITA
 description of how it works [81](#)
CEEBXITA, comparing two methods of linking [84](#)
CEEBXITA, specifying message display level in [83](#)
CEEBXITA, specifying naming pattern in [82](#)
CEEREACTAFTERQDBG command
 syntax of EQAXOPT macro for [159](#)
CEETEST [159](#)
checklist [1](#)
CICS
 adding support for [109](#)

CICS (*continued*)
 AOR example [120](#)
 AOR example, application does not use terminal [122](#)
 CSD [109](#)
 DFHRPL [109](#)
 EQAOCPLT [111](#)
 EQACCSO [109](#)
 EQACDCT [109](#)
 INITPARM [112](#)
 IVPs [120](#)
 JCL, updating [109](#)
 SEQAMOD [109](#)
 SEQAMOD must be APF-authorized [15](#)
 Terminal to TOR then routes to AOR example, with DTCN
 [121](#)
 Terminal to TOR, application on AOR example [122](#), [123](#)
CICS EXCI [71](#)
CICS translator
 specifying a different [97](#)
CICS, changes to make to [68](#)
code pages
 creating conversion images for [160](#)
command
 syntax diagrams [xii](#)
commands, Start (S) [51](#)
commands, Stop (P) [52](#)
COMMANDSDSN command
 syntax of EQAXOPT macro for [157](#), [158](#), [162](#)
COMMNDxx, add started tasks [26](#)
communication, External [43](#)
communication, Internal [44](#)
configure Debug Profile Service [60](#)
controlled libraries for RSE, Define MVS [32](#)
copying
 data sets to specified DD concatenation [90](#)
CSD [109](#)
customer support [210](#)
customizing
 Delay Debug Profile [102](#)
 IBM z/OS Debugger Utilities [92](#)
 IMS Transaction and User ID Cross Reference Table [102](#)
 Non-CICS Debug Session Start and Stop Message
 Viewer [103](#), [104](#)
 Other IBM Application Delivery Foundation for z/OS
 tools [94](#)
 Program Preparation [96](#)
 z/OS Debugger User Exit Data Set [99](#)

D

data sets
 copying into DD concatenation [90](#)
Db2 precompiler
 specifying a different [97](#)
DBGMGR [26–29](#)
DBGMGR, debug manager [32](#)
debug manager [26–29](#), [34](#)

- Debug Manager authentication [42](#)
- Debug Manager logging [50](#)
- Debug Manager started tasks, Define [31](#)
- debug manager, DBGMGR [32](#)
- Debug Profile Service [58–60](#), [63](#), [64](#), [67](#), [71](#), [73](#), [75](#)
- Debug Tool DTCN and DTSP Profile Manager [67](#)
- debugger, manager [34](#)
- DEFAULTVIEW command
 - syntax of EQAXOPT macro for [162](#)
- Define MVS program controlled libraries for RSE [32](#)
- Define RSE server as a secure z/OS UNIX [31](#)
- defining
 - DTCN transaction name [110](#)
 - names [19](#), [192](#)
 - TCP/IP terminals [195](#)
- defining Transient Data queues [109](#)
- DELETE, detecting [182](#)
- deleting debug profiles from VSAM or temporary storage queue [118](#)
- DFHLETRU [119](#)
- DLAYDBG command
 - description of [163](#)
 - syntax of EQAXOPT macro for [163](#)
- DLAYDBGDSN command
 - syntax of EQAXOPT macro for [164](#)
- DLAYDBGTRC command
 - syntax of EQAXOPT macro for [165](#)
- DLOGMOD operand, specifying [194](#)
- documents, licensed [ix](#)
- DSALIM [112](#)
- DTCX transaction [113](#)
- Dynamic Debug
 - accessing programs in unprotected storage [11](#)
- dynamic installation [9](#)

E

- editing
 - EQAZPROC to add other procedure libraries [92](#)
- EDSALIM [112](#)
- Enterprise PL/I, definition of [xi](#)
- EQA00SVC
 - checking level of [10](#)
 - description of [9](#)
- EQA01SVC
 - checking level of [10](#)
 - description of [9](#)
- EQA0CPLT
 - INITPARM
 - example [112](#)
 - parameters [112](#)
 - PLT, adding [111](#)
 - set up [111](#)
- EQA9974I [113](#)
- EQACCSA [109](#)
- EQACDCT [109](#)
- EQAD3CXT
 - comparing Db2 RUNOPTS to [81](#)
- EQADCDEL [118](#)
- EQADTCN2, where to define [114](#)
- EQADTOOL.BROWSE.CICS [87](#)
- EQADTOOL.BROWSE.MVS [87](#)
- EQADTOOL.DTCDELETEALL [125](#)
- EQADTOOL.DTCIINACTALL [125](#)

- EQADTOOL.DTCNCHNGEANY [71](#)
- EQADTOOL.DTSTMODCICK [124](#)
- EQADTOOL.DTSTMODUSERK [124](#)
- EQANCPLT [113](#)
- EQAOPST, using to set global preferences [169](#)
- EQAOPST, using to set SVC screening option [183](#)
- EQARMTSU [53](#)
- EQASET
 - when to run [81](#)
- EQASTART
 - modifying, to customize data set names [91](#)
- EQAUEDAT [143](#)
- EQAWAPPL
 - modifying [19](#), [192](#)
- EQAYSESM PROC definition [21](#), [202](#)
- EQAZDFLT
 - example of, showing parameters to set [94](#), [96](#)
- EQAZDSYS [100](#)
- EQAZPCM [42](#)
- EQAZPROC [92](#)
- example
 - activating z/OS Debugger definitions to VTAM [196](#)
 - full-screen mode using a dedicated terminal [191](#)
 - full-screen mode using the Terminal Interface Manager [17](#)
 - JCL that generates conversion images [161](#)
 - VTAM in a sysplex environment [19](#), [193](#)
- External communication [43](#)

F

- FEJCNFG [44](#)
- FIRSTONLY operand
 - specifying, to display a session manager panel [196](#)
- fixes, getting [209](#)
- full-screen mode using a dedicated terminal with z/OS Debugger Terminal Interface Manager,
 - overview of steps to enable [201](#)
- full-screen mode using a dedicated terminal,
 - overview of steps to enable [192](#)
- full-screen mode using a dedicated terminal, how users start [191](#)
- full-screen mode using the Terminal Interface Manager,
 - overview of steps to enable [19](#)

G

- global preferences file [169](#)
- goals, setting in WLM [48](#)

H

- HOSTPORTS [170](#)

I

- IBM Support Assistant, searching for problem resolution [209](#)
- IGNOREODOLIMIT [170](#)
- IMS
 - adding support for [127](#)
 - program that do not run in Language Environment [129](#)
- IMSISOORIGPSB [171](#)
- IMSplex

IMSplex (*continued*)
 configuring for [98](#)
 initial default data set names
 LDD specifications file [178](#)
 saved breakpoints file [178](#)
 saved monitor values file [178](#)
 saved settings file [178](#)
 INITPARM
 example [112](#)
 NLE [112](#)
 NWP [112](#)
 STK [112](#)
 installation verification programs
 CICS [120](#)
 Internal communication [44](#)
 Internet
 searching for problem resolution [209](#)
 IPL
 to install z/OS Debugger SVC
 [9](#)
 IVP
 running for z/OS Debugger facility
 [10](#)
 IVPs [120](#)

J

Japanese
 adding data sets to DD concatenation [90](#)
 Customizing z/OS Debugger [146](#)
 data sets [91](#)
 JES Job Monitor tracing [50](#)

K

Korean
 data sets [91](#)

L

Language Environment
 user exit, link, into private copy of Language
 Environment runtime module [85](#)
 user exits, methods to modify sample assembler [82](#)
 Language Environment user exit, create and manage data set
 used by [85](#)
 Language Environment user exit, requirements for data set
 used by [85](#)
 libraries for RSE , Define MVS [32](#)
 licensed documents [ix](#)
 LINK, detecting [182](#)
 LOAD, detecting [182](#)
 log mode [194](#)
 LOGDSN command
 syntax of EQAXOPT macro for [172](#), [173](#)
 logging, Debug Manager [50](#)
 LPAR, multiple, with multiple Terminal Interface Manager (on
 same VTAM network) [204](#)
 LPAR, multiple, with one Terminal Interface Manager [23](#), [204](#)

M

Management (*continued*)
 z/OS Debugger Profile
 [75](#)
 message display level, how to specify, in Language
 Environment user exit [83](#)
 MFI VTAM [17](#), [191](#)
 Model Application Names [20](#), [193](#)
 modifying
 EQASTART [91](#)
 EQAWAPPL [19](#), [192](#)
 moving to new level of Language Environment [85](#)
 multi-domain environment
 modifying EQAWAPPL [19](#), [193](#)
 multiple instances, Running [50](#)
 multiple systems, customizing Preparation Utilities for [95](#), [98](#)
 MULTIPROCESS
 MULTIPROCESS CHILD [175](#)
 MULTIPROCESS PARENT [175](#)
 MULTIPROCESS PROMPT [175](#)
 MVS program controlled libraries for RSE , Define [32](#)

N

NAMES command
 description of [176](#)
 naming pattern, how to specify, in Language Environment
 user exit [83](#)
 NATLANG [90](#)
 NLE [112](#)
 NWP [112](#)

O

optimizing z/OS Debugger's performance [112](#)
 order in which commands and preferences files are
 processed [169](#)

P

parameters
 setting, using EQAZDFLT example [94](#), [96](#)
 specifying, for Db2 and CICS [97](#)
 PARMLIB [58](#), [75](#)
 performance
 optimizing for CICS [112](#)
 PL/I, definition of [xi](#)
 plug-ins [67](#)
 Policy Agent configuration [37](#)
 Policy Agent started task [36](#)
 port reservation, TCP/IP [44](#)
 ports, TCP/IP [42](#)
 preferences file, setting global [169](#)
 PREFERENCESDSN command
 syntax of EQAXOPT macro for [177](#)
 preparing
 to customize z/OS Debugger
 [1](#)
 problem determination
 describing problems [210](#)
 determining business impact [210](#)
 submitting problems [211](#)
 Process count [48](#)
 PROCLIB [55](#), [73](#)

PROCLIB changes [26–29](#)
PROFILE.TCPIP data set [195](#)
PROFILE.TCPIP, AT-TLS configuration [36](#)
PROGxx, APF authorizations [26](#)

R

RACF profiles
 as option for BROWSE [156](#)
 Authorizing DTCD and DTCI transactions to delete or deactivate debug profiles [125](#)
 Authorizing DTST transaction to modify storage [124](#)
 browse mode [87](#)
 data sets that require READ authorization, Db2 stored procedures [107](#)
 reserve for CICS administrator [117](#)
 reserve for CICS administrators [118](#)
remote debug mode [67](#)
Remote Debug Service [52](#), [53](#), [55–58](#)
reservation, TCPIP port [44](#)
resource usage, overview [48](#)
resource usage, tuning [48](#)
RSE , Define MVS program controlled libraries for [32](#)
RSE daemon [43](#)
RSE server [43](#)
RSE, Define as a secure z/OS UNIX server [31](#)
Running multiple instances [50](#)
RUNOPTS (Db2)
 comparing EQAD3CXT to [81](#)

S

SAVEBPDSN command
 syntax of EQAXOPT macro for [178](#)
SAVESETDSN command
 syntax of EQAXOPT macro for [178](#)
screen control mode [122](#)
screening, setting SVC [182](#)
secure communication [57](#), [64](#)
secure z/OS UNIX server, Define RSE as a [31](#)
security definitions [56](#)
security settings and classes, Activate [31](#)
security settings, verify [32](#)
separate debug file, attributes to use for [112](#)
separate terminal mode [123](#)
SEQABMOD [13](#)
SEQAEXEC
 modifying [91](#)
SEQATLIB [90](#), [91](#), [94](#), [96](#)
service, when you apply to Language Environment [85](#)
session manager panel
 displaying [196](#)
SESSIONTIMEOUT [180](#)
SET DEFAULT VIEW command
 description of [162](#)
setting global preferences file [169](#)
setting goals, WLM [48](#)
settings and classes, Activate security [31](#)
Software Support
 contacting [210](#)
 describing problems [210](#)
 determining business impact [210](#)
 receiving updates [209](#)

Software Support (*continued*)
 submitting problems [211](#)
Start (S) command [51](#)
started task [56](#), [63](#)
started task, Policy Agent [36](#)
started tasks, Define for Debug Manager
 JMON started tasks [31](#)
 RSED started tasks [31](#)
started tasks, verifying [32](#)
starting
 IBM z/OS Debugger Utilities from an ISPF panel [92](#)
STARTSTOPMSG [180](#)
STK [112](#)
Stop (P) command [52](#)
SVC
 installing, without using a system IPL [9](#)
 setting screening option [182](#)
SVC screening [182](#)
syntax diagrams
 how to read [xii](#)
syslogd setup [35](#)
sysplex
 modifying EQAWAPPL [19](#), [193](#)

T

TCP/IP
 defining terminals to TN3270 [195](#)
 VARY NET command [20](#), [193](#)
 VARY TCPIP command [196](#)
TCP/IP port reservation [44](#)
TCP/IP ports [42](#)
TCP/IP ports, graphical representation [42](#)
TCP/IP updates [29](#)
TCP/IP, using with CICS [25](#)
TCPIP DATASN [185](#)
temporary storage queue
 setting up to share among CICS systems [114](#)
Terminal Interface Manager
 as IBM Session Manager application [205](#)
 Configuring telnet server for [203](#)
 description of [200](#)
 example of use [200](#)
 how to start [21](#), [202](#)
 multiple LPARs on same VTAM network [204](#)
 multiple LPARs with one Terminal Interface Manager [23](#), [204](#)
 Verifying customization of [206](#)
Terminal to TOR then routes to AOR example, with DTCN [121](#)
Terminal to TOR, application on AOR example [122](#), [123](#)
terminology, z/OS Debugger [x](#)
Thread count [48](#)
TIM [205](#)
TOR [121–123](#)
tracing, JES Job Monitor [50](#)
TSQ [118](#)
tuning considerations [48](#)

U

UNIX server, Define RSE as [31](#)
USEQSAM [119](#)

- user exit
 - [EQUAEDAT 143](#)
 - [XEIIN 113](#)
 - [XEIOUT 113](#)
 - [XPCFTCH 113](#)
 - [XPCHAIR 113](#)
 - [XPCTA 113](#)
- USSMSG10 panel
 - [displaying 196](#)

V

- [Verify security settings 32](#)
- verifying
 - [installation of z/OS Debugger SVCs 10](#)
- [Visual Studio Code 52](#)
- [VS Code 52](#)
- VSAM
 - [defining file locally to all CICS regions 116](#)
 - [deleting or deactivating debug profiles 117](#)
 - [migrating debug profiles from a previous release 114](#)
 - [setting up to function-ship file operations to a FOR 115](#)
 - [setting up to share among CICS systems 114](#)
 - [setting up, to store DTCN profiles 114](#)
- VTAM
 - [activating z/OS Debugger definitions to, example 196](#)
 - [allowing users to debug using 17, 191](#)
 - [DLOGMOD operand 194](#)
 - [in a multi-domain environment 19, 193](#)
 - [in a sysplex environment 19, 193](#)
 - [LU characteristics 194](#)
 - [verifying installation of the z/OS Debugger definitions to 22, 199](#)
- [VTAM definitions library 19, 192](#)
- VTAM minor node
 - [defining for Terminal Interface Manager 202](#)
 - [defining for the Terminal Interface Manager 20](#)
- [VTAMLST 19, 192](#)

Y

- [yb2* parameters 100, 101](#)

Z

- z/OS Debugger
 - parameters
 - [assigning values to 145](#)
 - [terminology x](#)
- z/OS Debugger SVCs
 - [Dynamic Debug Facility 9](#)
- z/OS UNIX server, Define RSE as [31](#)



Product Number: 5724-T07