

IBM z/OS Debugger
14.2.6

Customization Guide



Note!

Before using this information and the product it supports, be sure to read the general information under [“Notices” on page 199](#).

Seventh Edition (December 2021)

This edition applies to IBM® z/OS® Debugger, Version 14.2.6 (Program Number 5724-T07 with the PTF for PH35865), which supports the following compilers:

- AD/Cycle C/370 Version 1 Release 2 (Program Number 5688-216)
- C/C++ for MVS/ESA Version 3 (Program Number 5655-121)
- C/C++ feature of OS/390® (Program Number 5647-A01)
- C/C++ feature of z/OS Version 1 (Program Number 5694-A01)
- C/C++ feature of z/OS Version 2 (Program Number 5650-ZOS)
- OS/VS COBOL, Version 1 Release 2.4 (5740-CB1) - with limitations
- VS COBOL II Version 1 Release 3 and Version 1 Release 4 (Program Numbers 5668-958, 5688-023) - with limitations
- COBOL/370 Version 1 Release 1 (Program Number 5688-197)
- COBOL for MVS™ & VM Version 1 Release 2 (Program Number 5688-197)
- COBOL for OS/390 & VM Version 2 (Program Number 5648-A25)
- Enterprise COBOL for z/OS and OS/390 Version 3 (Program Number 5655-G53)
- Enterprise COBOL for z/OS Version 4 (Program Number 5655-S71)
- Enterprise COBOL for z/OS Version 5 (Program Number 5655-W32)
- Enterprise COBOL for z/OS Version 6 Release 1, Release 2, and Release 3 (Program Number 5655-EC6)
- High Level Assembler for MVS & VM & VSE Version 1 Release 4, Version 1 Release 5, Version 1 Release 6 (Program Number 5696-234)
- OS PL/I Version 2 Release 1, Version 2 Release 2, Version 2 Release 3 (Program Numbers 5668-909, 5668-910) - with limitations
- PL/I for MVS & VM Version 1 Release 1 (Program Number 5688-235)
- VisualAge® PL/I for OS/390 Version 2 Release 2 (Program Number 5655-B22)
- Enterprise PL/I for z/OS and OS/390 Version 3 (Program Number 5655-H31)
- Enterprise PL/I for z/OS Version 4 (Program Number 5655-W67)
- Enterprise PL/I for z/OS Version 5 Release 1, Release 2, and Release 3 (Program Number 5655-PL5)

This edition also applies to all subsequent releases and modifications until otherwise indicated in new editions or technical newsletters.

You can access publications online at www.ibm.com/e-business/linkweb/publications/servlet/pbi.wss

You can find out more about IBM z/OS Debugger by visiting the following IBM Web sites:

- IBM Debug for z/OS: <https://www.ibm.com/us-en/marketplace/debug-for-z-systems>
- IBM Developer for z/OS: <https://www.ibm.com/us-en/marketplace/developer-for-z-systems>
- IBM Wazi Developer for Red Hat CodeReady Workspaces: <https://www.ibm.com/products/wazi-for-red-hat-codeready-workspaces>

© **Copyright International Business Machines Corporation 1992, 2021.**

US Government Users Restricted Rights – Use, duplication or disclosure restricted by GSA ADP Schedule Contract with IBM Corp.

Contents

About this document.....	xiii
Who might use this document.....	xiii
Accessing z/OS licensed documents on the Internet.....	xiii
How this document is organized.....	xiv
Terms used in this document.....	xiv
How to read syntax diagrams.....	xvi
Symbols.....	xvi
Syntax items.....	xvi
Syntax examples.....	xvii
How to provide your comments.....	xviii
Summary of changes.....	xix
Overview of IBM z/OS Debugger.....	xxiii
Chapter 1. Customizing z/OS Debugger: checklist.....	1
Chapter 2. Product Registration.....	7
Registering z/OS Debugger.....	7
Removing old registrations.....	8
Chapter 3. Installing the z/OS Debugger SVCs.....	9
Installing the SVCs without using a system IPL.....	9
Verifying the installation of the SVCs.....	10
Checking the level of the z/OS Debugger SVCs.....	10
Running the installation verification programs for SVCs.....	10
Using the Authorized Debug facility for protected programs.....	11
Chapter 4. Setting up the APF-authorized system link list data set (SEQABMOD)...	13
Chapter 5. Setting up the link list data set (SEQAMOD).....	15
Chapter 6. Enabling debugging in full-screen mode using the Terminal Interface Manager.....	17
How users start a full-screen mode debug session with the Terminal Interface Manager.....	17
Enabling full-screen mode using the Terminal Interface Manager.....	19
Defining the VTAM EQAMVnnn APPL definition statements.....	19
Defining the Terminal Interface Manager APPL definition statements.....	20
Starting the Terminal Interface Manager.....	21
Verifying the enablement of full-screen mode using the Terminal Interface Manager.....	22
Example: Defining the VTAM EQAMVnnn and Terminal Interface Manager APPL definition statements when z/OS Debugger runs on four LPARs.....	23
Chapter 7. Adding support for remote debug users.....	25
Activating the TCP/IP Socket Interface for CICS.....	25
Enabling communication with Debug Manager.....	26
Debug Manager configuration.....	26
Debug Manager configuration reference.....	30
Adding support for Remote Debug Service.....	45

Installing Remote Debug Service.....	45
Customizing with the sample job EQARMTSU.....	45
Customizing the system PROCLIB.....	46
Remote Debug Service security definitions.....	47
Updating PARMLIB to start Remote Debug Service during IPL.....	48
Starting and stopping Remote Debug Service dynamically.....	48
Adding support for Debug Profile Service and APIs.....	48
Installing Debug Profile Service.....	48
Customizing with the sample job EQAPRFSU.....	49
Customizing the system PROCLIB.....	49
Debug Profile Service security definitions.....	50
Updating PARMLIB to start Debug Profile Service during IPL.....	52
Starting and stopping Debug Profile Service dynamically.....	52
Adding support for the DTCN profiles APIs and views.....	53
Defining the CICS TCPIP SERVICE resource.....	53
Establishing secure communication between the profile view and your z/OS system for CICS.....	55
Defining who can create, modify, or delete DTCN profiles.....	56
Adding support for the DTSP Profile, code coverage, and load module analyzer views.....	57
Installing the ADFz Common Components Server.....	57
Installing and configuring the z/OS Debugger extensions for the Common Components Server.....	58
Running the Common Components Server.....	58
Enabling secure communication between z/OS Debugger and the remote debugger for incoming debug sessions.....	58

Chapter 8. Specifying the TEST runtime options through the Language

Environment user exit.....	61
Editing the source code of CEEBXITA.....	62
Modifying the naming pattern.....	62
Modifying the message display level.....	63
Modifying the call back routine registration.....	64
Activate the cross reference function and modifying the cross reference table data set name.....	64
Comparing the two methods of linking CEEBXITA.....	64
Linking the CEEBXITA user exit into a private copy of a Language Environment runtime module.....	65
Creating and managing the TEST runtime options data set.....	65

Chapter 9. Installing the browse mode RACF facility.....67

Choose and install appropriate RACF facility.....	67
Set up user access to facility.....	68

Chapter 10. Customizing IBM z/OS Debugger Utilities.....69

Choosing a method to start IBM z/OS Debugger Utilities.....	70
Customizing the data set names in EQASTART.....	71
Adding IBM z/OS Debugger Utilities to the ISPF menu.....	72
Customizing z/OS Debugger Setup Utility.....	72
Customizing for JCL for Batch Debugging utility.....	72
Parameters you can set.....	73
Customizing JCL for Batch Debugging for multiple systems.....	74
Customizing for Other IBM Application Delivery Foundation for z/OS tools.....	74
Parameters you can set.....	75
Customizing Other IBM Application Delivery Foundation for z/OS tools for multiple systems.....	75
Customizing Program Preparation.....	76
Parameters you can set.....	76
Customizing Program Preparation for multiple systems.....	78
Configuring for IMSplex users.....	78
Customizing debugging by using IMS message region templates.....	79
Customizing z/OS Debugger User Exit Data Set.....	80
Customizing IMS BTS Debugging.....	81

Customizing Delay Debug Profile.....	83
Customizing IMS Transaction and User ID Cross Reference Table	83
Customizing Non-CICS Debug Session Start and Stop Message Viewer	84
Customizing z/OS Debugger Code Coverage.....	85
Installing and customizing z/OS Debugger JCL Wizard.....	86
Chapter 11. Preparing your environment to debug Db2 stored procedures.....	89
Chapter 12. Adding support for debugging under CICS.....	91
Activating CICS non-Language Environment exits.....	95
Storing DTCN debug profiles in a VSAM file.....	96
Migrating a debug profiles VSAM file from an earlier release.....	96
Sharing DTCN debug profile repository among CICS systems.....	96
Deleting or deactivating debug profiles stored in a VSAM data set.....	99
Deleting DTCN profiles with the DTCN LINK service.....	100
Requiring users to specify resource types.....	101
Direct QSAM access through a CICS task-related user exit.....	101
Enabling the CADP transaction.....	101
Running multiple debuggers in a CICS region.....	102
Running the installation verification programs in a CICS region.....	102
Configuring z/OS Debugger to run in a CICSplex environment.....	103
Terminal connects to an AOR that runs the application.....	103
Terminal connects to a TOR which routes the application to an AOR; debugging profiles managed by CADP.....	104
Terminal connects to a TOR which routes the application to an AOR; debugging profiles managed by DTCN.....	104
Terminal connects to an AOR that runs an application that does not use a terminal.....	105
Screen control mode terminal connects to a TOR and application runs in an AOR.....	106
Separate terminal mode terminal connects to a TOR and application runs in an AOR.....	106
Authorizing DTST transaction to modify storage.....	108
Authorizing DTCD and DTCI transactions to delete or deactivate debug profiles.....	108
Chapter 13. Adding support for debugging under IMS.....	111
Scenario A: Running IMS and managing TEST runtime options with a user exit.....	112
Scenario B: Running IMS and managing TEST runtime options with CEEUOPT or CEEROPT.....	113
Scenario C: Running assembler program without Language Environment in IMS TM and managing TEST runtime options with EQASET.....	113
Scenario D: Running IMSplex environment.....	113
Scenario E: Enabling users to launch private message regions and to assign transactions to private message regions.....	114
Scenario F: Enabling the Transaction Isolation Facility.....	115
Sample customization of the IMS Transaction Isolation Facility.....	118
Batch interface for the IMS Transaction Isolation Facility.....	124
Installing and configuring the IMS transaction isolation extension for the ADFz Common Components server.....	125
Chapter 14. Enabling the EQAUEDAT user exit.....	127
Chapter 15. Using EQACUIDF to specify values for NATLANG, LOCALE, and LINECOUNT.....	129
Changing the default and allowable values in EQACUIDF.....	129
Enabling additional languages for some z/OS Debugger components through EQACUIDF.....	130
Chapter 16. EQAOPTS commands.....	131
Format of the EQAOPTS command.....	138
EQAOPTS commands that have equivalent z/OS Debugger commands.....	139

Providing EQAOPTS commands at run time.....	139
Creating EQAOPTS load module.....	140
Descriptions of EQAOPTS commands.....	140
ALTDISP.....	140
BROWSE.....	141
CACHENUM.....	141
CCOUTPUTDSN.....	141
CCOUTPUTDSNALLOC.....	142
CCPROGSELECTDSN.....	143
CEEREACTAFTERQDBG.....	143
CODEPAGE.....	144
COMMANDSDSN.....	146
DEFAULTVIEW.....	147
DISABLERLIM.....	147
DLAYDBG.....	147
DOPTACBDSN.....	150
DTCNDELETEDEADPROF.....	151
DTCNFORCExxxx.....	151
DYNDEBUG.....	152
EQAQPP.....	152
EXPLICITDEBUG.....	152
GPFDSN.....	153
HOSTPORTS.....	154
IGNOREEODOLIMIT.....	154
IMSISOORIGPSB.....	155
LOGDSN.....	155
LOGDSNALLOC.....	156
MAXTRANUSER.....	157
MDBG.....	158
MULTIPROCESS.....	158
NAMES.....	159
NODISPLAY.....	160
PREFERENCESDSN.....	160
SAVEBPDSN, SAVESETDSN.....	161
SAVESETDSNALLOC, SAVEBPDSNALLOC.....	161
SESSIONTIMEOUT.....	163
STARTSTOPMSG.....	164
SUBSYS.....	165
SVCSCREEN.....	165
TCPIPDATADSN.....	168
THREADTERMCOND.....	169
TIMACB.....	169
END.....	170

Appendix A. SMP/E USERMODs..... 171

Appendix B. Enabling debugging in full-screen mode using a dedicated terminal. 173

How z/OS Debugger uses full-screen mode using a dedicated terminal.....	173
Enabling full-screen mode using a dedicated terminal.....	174
Defining the VTAM EQAMVnnn APPL definition statements.....	174
Defining terminal LUs used by z/OS Debugger.....	176
Configuring the TN3270 Telnet Server to access the terminal LUs.....	177
Example: Activating full-screen mode using a dedicated terminal when using TCP/IP TN3270	
Telnet Server.....	178
Defining z/OS Debugger to VTAM.....	179
Defining the terminals used by z/OS Debugger.....	179
Configuring the TN3270 Telnet Server.....	179

Verifying the customization of the facility to debug full-screen mode using a dedicated terminal.....	181
Using z/OS Debugger Terminal Interface Manager as a dedicated terminal.....	182
Example: a debugging session using the z/OS Debugger Terminal Interface Manager.....	182
Enabling full-screen mode using a dedicated terminal with z/OS Debugger Terminal Interface Manager.....	183
Defining the Terminal Interface Manager APPL definition statements.....	184
Starting the z/OS Debugger Terminal Interface Manager as a dedicated terminal.....	184
Configuring the TN3270 Telnet Server to access the Terminal Interface Manager.....	185
Example: Connecting a VTAM network with multiple LPARs with one Terminal Interface Manager.....	186
Running the Terminal Interface Manager on more than one LPAR on the same VTAM network.....	186
Configuring Terminal Interface Manager as an IBM Session Manager application.....	187
Verifying the customization of the Terminal Interface Manager.....	188
Appendix C. Applying maintenance.....	189
Applying Service APAR or PTF.....	189
What you receive.....	189
Checklist for applying an APAR or PTF.....	189
Appendix D. Support resources and problem solving information.....	191
Searching knowledge bases.....	191
Searching IBM Knowledge Center.....	191
Searching product support documents.....	191
Getting fixes.....	192
Subscribing to support updates.....	192
RSS feeds and social media subscriptions.....	192
My Notifications.....	193
Contacting IBM Support.....	193
Define the problem and determine the severity of the problem.....	194
Gather diagnostic information.....	194
Submit the problem to IBM Support.....	195
Appendix E. Accessibility.....	197
Using assistive technologies.....	197
Keyboard navigation of the user interface.....	197
Accessibility of this document.....	197
Notices.....	199
Trademarks and service marks.....	199
Glossary.....	201
Bibliography.....	205
IBM z/OS Debugger publications.....	205
High level language publications.....	205
Related publications.....	207
Index.....	209

Programming interface information

This book is intended to help you debug application programs. This publication documents intended Programming Interfaces that allow you to write programs to obtain the services of z/OS Debugger.

Copyright license

This information contains sample application programs in source language, which illustrates programming techniques on various operating platforms. You may copy, modify, and distribute these sample programs in any form without payment to IBM, for the purposes of developing, using, marketing or distributing application programs conforming to the application programming interface for the operating platform for which the sample programs are written. These examples have not been thoroughly tested under all conditions. IBM, therefore, cannot guarantee or imply reliability, serviceability, or functions of these programs.

About this document

z/OS Debugger combines the richness of the z/OS environment with the power of Language Environment® to provide a debugger for programmers to isolate and fix their program bugs and test their applications. z/OS Debugger gives you the capability of testing programs in batch, using a nonprogrammable terminal in full-screen mode, or using a workstation interface to remotely debug your programs.

This document describes the tasks you must do to customize z/OS Debugger. You can use [Host Configuration Assistant for Z Development \(HCA\)](#) to generate a customized checklist for z/OS Debugger, and then refer to this guide for more details. HCA is a cloud-based wizard that is designed to simplify planning and configuring of Z development products. Besides z/OS Debugger, you can also find the configuration information for other host components like z/OS Explorer and z/OS Source Code Analysis.

Who might use this document

This document is intended for system administrators who need to customize z/OS Debugger.

z/OS Debugger runs on the z/OS operating system and supports the following subsystems:

- CICS®
- Db2®
- IMS
- JES batch
- TSO
- UNIX System Services in remote debug mode or full-screen mode using the Terminal Interface Manager only

Accessing z/OS licensed documents on the Internet

z/OS licensed documentation is available on the Internet in PDF format at the IBM Resource Link® Web site at:

<http://www.ibm.com/servers/resourcelink>

Licensed documents are available only to customers with a z/OS license. Access to these documents requires an IBM Resource Link user ID and password, and a key code. With your z/OS order you received a Memo to Licensees, (GI10-8928), that includes this key code.

To obtain your IBM Resource Link user ID and password, log on to:

<http://www.ibm.com/servers/resourcelink>

To register for access to the z/OS licensed documents:

1. Sign in to Resource Link using your Resource Link user ID and password.
2. Select **User Profiles** located on the left-hand navigation bar.

Note: You cannot access the z/OS licensed documents unless you have registered for access to them and received an e-mail confirmation informing you that your request has been processed.

Printed licensed documents are not available from IBM.

You can use the PDF format on either **z/OS Licensed Product Library CD-ROM** or IBM Resource Link to print licensed documents.

How this document is organized

Note: Chapter 4, 6, 10, 15, and Appendix B are not applicable to IBM Developer for z/OS (non-Enterprise Edition), IBM Wazi Developer for Red Hat® CodeReady Workspaces.

This document is divided into areas of similar information for easy retrieval of appropriate information.

- Chapter 1. Customizing z/OS Debugger: checklist
- Chapter 2. Product Registration
- Chapter 3. Installing the z/OS Debugger SVCs
- Chapter 4. Setting up the APF-authorized system link list data set (SEQABMOD)
- Chapter 5. Setting up the link list data set (SEQAMOD)
- Chapter 6. Enabling debugging in full-screen mode using the Terminal Interface Manager
- Chapter 7. Adding support for remote debug users
- Chapter 8. Specifying the TEST runtime options through the Language Environment user exit
- Chapter 9. Installing the browse mode RACF® facility
- Chapter 10. Customizing IBM z/OS Debugger Utilities
- Chapter 11. Preparing your environment to debug Db2 stored procedures
- Chapter 12. Adding support for debugging under CICS
- Chapter 13. Adding support for debugging under IMS
- Chapter 14. Enabling the EQAUEDAT user exit
- Chapter 15. Using EQACUIDF to specify values for NATLANG, LOCALE, and LINECOUNT
- Chapter 16. EQAOPTS commands
- Appendix A. SMP/E USERMODs
- Appendix B. Enabling debugging in full-screen mode using a dedicated terminal
- Appendix C. Applying maintenance
- Appendix D. Support resources and problem solving information
- Appendix E. Accessibility

The last several topics list notices, bibliography, and glossary of terms.

Terms used in this document

Because of differing terminology among the various programming languages supported by z/OS Debugger, as well as differing terminology between platforms, a group of common terms has been established. The table below lists these terms and their equivalency in each language.

z/OS Debugger term	C and C++ equivalent	COBOL or LangX COBOL equivalent	PL/I equivalent	assembler
Compile unit	C and C++ source file	Program	<ul style="list-style-type: none">• Program• PL/I source file for Enterprise PL/I• A package statement or the name of the main procedure for Enterprise PL/I¹	CSECT

z/OS Debugger term	C and C++ equivalent	COBOL or LangX COBOL equivalent	PL/I equivalent	assembler
Block	Function or compound statement	Program, nested program, method or PERFORM group of statements	Block	CSECT
Label	Label	Paragraph name or section name	Label	Label

Note:

1. The PL/I program must be compiled with and run in one of the following environments:
 - Compiled with Enterprise PL/I for z/OS, Version 3.6 or later, and run with the following versions of Language Environment:
 - Language Environment Version 1.9, or later
 - Language Environment Version 1.6, Version 1.7, or Version 1.8, with the PTF for APAR PK33738 applied
 - Compiled with Enterprise PL/I for z/OS, Version 3.5, with the PTFs for APARs PK35230 and PK35489 applied and run with the following versions of Language Environment:
 - Language Environment Version 1.9, or later
 - Language Environment Version 1.6, Version 1.7, or Version 1.8, with the PTF for APAR PK33738 applied

z/OS Debugger provides facilities that apply only to programs compiled with specific levels of compilers. Because of this, *IBM z/OS Debugger Customization Guide* uses the following terms:

assembler

Refers to assembler programs with debug information assembled by using the High Level Assembler (HLASM).

COBOL

Refers to the all COBOL compilers supported by z/OS Debugger except the COBOL compilers described in the term *LangX COBOL*.

disassembly or disassembled

Refers to high-level language programs compiled without debug information or assembler programs without debug information. The debugging support z/OS Debugger provides for these programs is through the disassembly view.

Enterprise PL/I

Refers to the Enterprise PL/I for z/OS and OS/390 and the VisualAge PL/I for OS/390 compilers.

LangX COBOL

Refers to any of the following COBOL programs supported through use of the EQALANGX (or IDILANGX) debug file:

- Programs compiled using the IBM OS/VS COBOL compiler.
- Programs compiled using the VS COBOL II compiler with the NOTEST compiler option.
- Programs compiled using the Enterprise COBOL compiler with the NOTEST compiler option.

As you read through the information in this document, remember that OS/VS COBOL programs are non-Language Environment programs, even though you might have used Language Environment libraries to link and run your program.

VS COBOL II programs are non-Language Environment programs when you link them with the non-Language Environment library. VS COBOL II programs are Language Environment programs when you link them with the Language Environment library.

Enterprise COBOL programs are always Language Environment programs. Note that COBOL DLL's cannot be debugged as LangX COBOL programs.

Read the information regarding non-Language Environment programs for instructions on how to start z/OS Debugger and debug non-Language Environment COBOL programs, unless information specific to LangX COBOL is provided.

PL/I

Refers to all levels of PL/I compilers. Exceptions will be noted in the text that describe which specific PL/I compiler is being referenced.

How to read syntax diagrams

This section describes how to read syntax diagrams. It defines syntax diagram symbols, items that may be contained within the diagrams (keywords, variables, delimiters, operators, fragment references, operands) and provides syntax examples that contain these items.

Syntax diagrams pictorially display the order and parts (options and arguments) that comprise a command statement. They are read from left to right and from top to bottom, following the main path of the horizontal line.

Symbols

The following symbols may be displayed in syntax diagrams:

Symbol

Definition

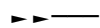

Indicates the beginning of the syntax diagram.



Indicates that the syntax diagram is continued to the next line.



Indicates that the syntax is continued from the previous line.



Indicates the end of the syntax diagram.

Syntax items

Syntax diagrams contain many different items. Syntax items include:

- Keywords - a command name or any other literal information.
- Variables - variables are italicized, appear in lowercase and represent the name of values you can supply.
- Delimiters - delimiters indicate the start or end of keywords, variables, or operators. For example, a left parenthesis is a delimiter.
- Operators - operators include add (+), subtract (-), multiply (*), divide (/), equal (=), and other mathematical operations that may need to be performed.
- Fragment references - a part of a syntax diagram, separated from the diagram to show greater detail.
- Separators - a separator separates keywords, variables or operators. For example, a comma (,) is a separator.

Keywords, variables, and operators may be displayed as required, optional, or default. Fragments, separators, and delimiters may be displayed as required or optional.

Item type

Definition

Required

Required items are displayed on the main path of the horizontal line.

Optional

Optional items are displayed below the main path of the horizontal line.

Default

Default items are displayed above the main path of the horizontal line.

Syntax examples

The following table provides syntax examples.

Item	Syntax example
Required item. Required items appear on the main path of the horizontal line. You must specify these items.	►► KEYWORD — required_item ◄◄
Required choice. A required choice (two or more items) appears in a vertical stack on the main path of the horizontal line. You must choose one of the items in the stack.	►► KEYWORD —  ◄◄
Optional item. Optional items appear below the main path of the horizontal line.	►► KEYWORD —  ◄◄
Optional choice. An optional choice (two or more items) appears in a vertical stack below the main path of the horizontal line. You may choose one of the items in the stack.	►► KEYWORD —  ◄◄
Default. Default items appear above the main path of the horizontal line. The remaining items (required or optional) appear on (required) or below (optional) the main path of the horizontal line. The following example displays a default with optional items.	►► KEYWORD —  ◄◄
Variable. Variables appear in lowercase italics. They represent names or values.	►► KEYWORD — <i>variable</i> ◄◄
Repeatable item. An arrow returning to the left above the main path of the horizontal line indicates an item that can be repeated. A character within the arrow means you must separate repeated items with that character. An arrow returning to the left above a group of repeatable items indicates that one of the items can be selected, or a single item can be repeated.	►► KEYWORD —  ◄◄ ►► KEYWORD —  ◄◄

Table 1. Syntax examples (continued)

Item	Syntax example
<p>Fragment.</p> <p>The — fragment — symbol indicates that a labelled group is described below the main syntax diagram. Syntax is occasionally broken into fragments if the inclusion of the fragment would overly complicate the main syntax diagram.</p>	 <p>The diagram illustrates a fragment symbol and a complex choice structure. The fragment symbol is shown as a box labeled 'fragment' with a double-headed arrow pointing to it from the left, and the text 'KEYWORD' to its left. Below this, the word 'fragment' is written. The main diagram shows a horizontal line with a double-headed arrow at the right end. A vertical line branches off downwards from the main line, labeled ', — required_choice2'. This vertical line leads to a bracketed group containing two options: ', — default_choice' and ', — optional_choice'. Another vertical line branches off downwards from the main line, labeled ', — required_choice1', which also leads to a bracketed group containing the same two options. The main line continues to the right end arrow.</p>

How to provide your comments

Your feedback is important in helping us to provide accurate, high-quality information. If you have comments about this document or any other z/OS Debugger documentation, you can leave a comment in [IBM Knowledge Center](#):

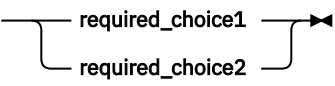
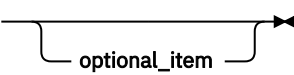
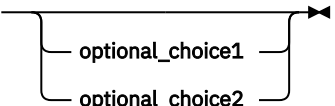
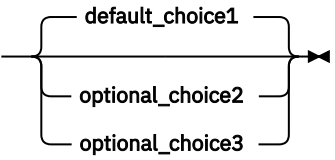
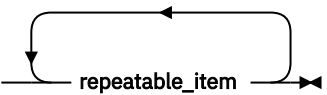
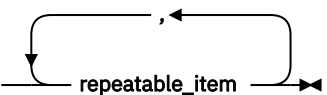
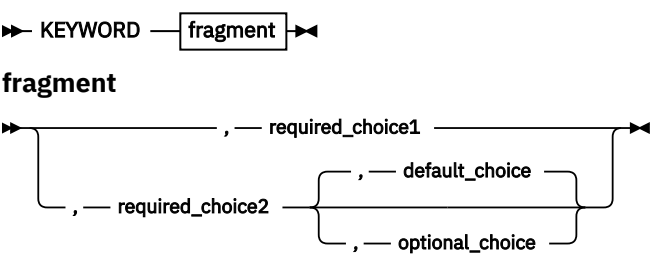
- IBM Developer for z/OS, IBM Debug for z/OS, and IBM Developer for z/OS Enterprise Edition: <https://www.ibm.com/support/knowledgecenter/SSQ2R2>
- IBM Wazi Developer for Red Hat CodeReady Workspaces: <https://www.ibm.com/support/knowledgecenter/SSCH39>

When you send information to IBM, you grant IBM a nonexclusive right to use or distribute the information in any way it believes appropriate without incurring any obligation to you.

Summary of changes

14.2.6

• Debug Profile Service

- You now only need to expose one port to use Debug Profile Service. A new configuration switch is added to `eqaprof.env` to select whether to use secure HTTP protocol. For more information, see [“Customizing with the sample job EQAPRFSU” on page 49](#).

14.2.5

• Debug Profile Service

- As an alternative of a keystore file, you can now use a RACF managed key ring to enable secure communication with Debug Profile Service. For more information, see [Enabling secure communication with a RACF managed key ring](#).
- A new optional HOST attribute is added to the CICS region configuration. For more information, see the instructions in the `/etc/debug/dtcn.ports` sample configuration file.
- The Debug Profile Service API now provides more detailed diagnostic messages when authentication fails.

• IBM Z® Open Debug

- Log files can now be found in the user's home directory.

14.2.4

• Code coverage

- You can now also use Remote Debug Service to collect code coverage results similar to the headless code coverage collector for IBM Wazi Developer for Red Hat CodeReady Workspaces or IBM Developer for z/OS Enterprise Edition. For more information, see the "Generating code coverage in headless mode using Remote Debug Service" topic in [IBM Documentation](#).

• Host configuration

- Remote Debug Service can now be configured to collect headless code coverage. For more information, see [Adding support for Remote Debug Service](#).

14.2.3

• [IBM Wazi for Red Hat CodeReady Workspaces](#)

- z/OS Debugger is included as part of the new product IBM Wazi for Red Hat CodeReady Workspaces and provides debug functions with the following clients:
 - IBM Z Open Development Eclipse client
 - Wazi Development, a set of Visual Studio Code extensions including IBM Z Open Debug

• [IBM Developer for z/OS Enterprise Edition](#)

- Starting from V14.2.3, IBM Developer for z/OS Enterprise Edition also offers Wazi Development, a set of Visual Studio Code extensions including IBM Z Open Debug.

For a comparison of features provided in different products and clients, see [Overview of IBM z/OS Debugger](#).

The following updates are delivered with the Eclipse interface:

• z/OS Debugger Profiles view

- You can now export debug profiles in an export file, and import from a debug profile export file or a workspace that was created with an older version of the product.
- A search field is added to display only the profiles that match your search text.
- More columns are now available. You can hide or display a column, modify the width of a column, and reorder the columns.
- You can now return to the default order of the profiles by clicking the column header.
- You can now activate a non-CICS debug profile for code coverage.
- If Debug Manager is not available and the debug daemon is configured with a secured port, when you activate a profile, the secured port is automatically detected.

For more information, see the "Managing debug profiles with the z/OS Debugger Profiles view" section in [IBM Documentation](#).

- **z/OS batch applications launches**

- You can now view the batch job in the Remote Systems view.
- You can now select more than one step in the existing JCL to be augmented with debug or code coverage options.

For more information, see the "Launching a debug session for z/OS Batch applications" section in [IBM Documentation](#).

- **Debug preferences**

- **IBM z/OS Debugger preferences:** You can now specify to inactivate the remote profiles when the Remote System Explorer connection associated with the profiles disconnects so that the debugger will not be triggered accidentally when you run applications that match the active profiles.
- **Debug Daemon preferences:** Instructions are added to set up a secure daemon connection.

For more information, see the "Setting debug preferences" topic in [IBM Documentation](#).

The following features are delivered with the z/OS Debugger host component:

- **CICS support**

- Support is added for CICS Transaction Server for z/OS Version 5 Release 6.

- **Compiler support**

- In Debug Tool compatibility mode, support is added for TEST (SEPARATE (DSNAME) , SOURCE) in Enterprise COBOL for z/OS Version 6 Release 2 with APAR PH04485 installed or later. Specify TEST (SEPARATE (DSNAME) , SOURCE) to store the separate debug file name, which is the SYSDEBUG DD data set name, in the program object. You will not need to specify the separate debug file location if it is not moved after compilation. For more information, see the "Choosing TEST or NOTEST compiler suboptions for COBOL programs" topic in *IBM z/OS Debugger User's Guide*.

14.2.2

The following changes were added for IBM z/OS Debugger Version 14.2.2.

The following updates are delivered with the Eclipse interface:

- **z/OS Debugger Profiles view**

- The **z/OS Debugger Profiles** view is added to create and manage CICS and non-CICS debug profiles. The following profiles and launch configurations are migrated to this new view:
 - DTCN profiles from the DTCN Local Profile view. The DTCN profiles are now called CICS profiles in the client.
 - DTSP profiles from the DTSP Local Profile view. The DTSP profiles are now called non-CICS profiles in the client.
 - Remote CICS Application launch configurations
 - Remote Db2 Application launch configurations

- Remote IMS Application launch configurations

Edit the profiles to provide additional information that is required before you activate any profiles. For more information, see the following topics in IBM Documentation: Working with the z/OS Debugger Profiles view, Creating a debug profile for a CICS application, and Creating a debug profile for a non-CICS application.

To use this view, system programmers need to configure the following services:

- Remote System Explorer from z/OS Explorer is required for z/OS connections.
- To enable all the features in the view for the best user experience, see [“Adding support for Debug Profile Service and APIs”](#) on page 48. Use z/OS Explorer host V3.1.1.23 or later with Debug Profile Service.
- For CICS users, also see [“Adding support for the DTCN profiles APIs and views”](#) on page 53.
- The DTCN and DTSP plug-ins are deprecated and will be removed in a future release.
- **z/OS batch applications launches**
 - MVS Batch Application launch configurations are replaced with z/OS Batch Application using property groups and z/OS Batch Application using existing JCL launch configurations to simplify debugging and running code coverage on batch applications on IBM Z. Any MVS Batch Application launch configurations are automatically migrated to the appropriate new configuration types. You can use debug profiles with z/OS Batch Application using existing JCL launch configurations.

For more information, see the "Launching a debug session for z/OS Batch applications" topic in [IBM Documentation](#).

z/OS Batch Application launch configurations require the Remote System Explorer from z/OS Explorer.

The following features are delivered with the z/OS Debugger host component:

- **TEST runtime option**
 - A simple TEST runtime option now starts z/OS Debugger in delay debug mode under most conditions for non-CICS tasks if the Debug Profile Service API is started. This option simplifies the debug setup for batch jobs, IMS MPP regions, and WLM address spaces for Db2 stored procedures. For more information, see the "Simple TEST options" topic in *IBM z/OS Debugger User's Guide*.
- **Compiler support**
 - In Debug Tool compatibility mode, support is added for debugging COBOL programs that contain dynamic length elementary items and compiled with Enterprise COBOL for z/OS Version 6 Release 3. Dynamic length elementary items are not supported in standard mode.
- **Documentation only updates**
 - Instructions are added for debugging non-Language Environment programs under IMS Batch Terminal Simulator. For more information, see the "Debugging non-Language Environment IMS BTS programs" topic in *IBM z/OS Debugger User's Guide*.
 - Chapter 7, "Debug Manager (DBGMGR)" and Chapter 17, "Adding support for remote debug users" are combined into Chapter 7, [“Adding support for remote debug users,”](#) on page 25 in *IBM z/OS Debugger Customization Guide*.

14.2.1

The following changes were added for IBM z/OS Debugger Version 14.2.1.

- **Compiler support**
 - In Debug Tool compatibility mode, support is added for debugging COBOL programs that contain fixed-length UTF-8 data items and compiled with Enterprise COBOL for z/OS Version 6 Release 3. UTF-8 data items are not supported in standard mode.
- **Debug Manager**

- Debug Manager and Remote System Explorer can use different chain certificates. If the different certificates are of the same CA root, the Debug Manager certificate is regarded as trusted and automatically accepted. Otherwise, the certificate is not regarded as trusted. In Debug Tool compatibility mode, a window appears to ask you to import the certificate for Debug Manager.

- **Terminal Interface Manager**

- Terminal Interface Manager now supports MFA-generated tokens and password phrases.

14.2.0

The following changes were added for IBM z/OS Debugger Version 14.2.0.

- **New support**

- z/OS Version 2 Release 4
- Enterprise COBOL for z/OS Version 6 Release 3
- Enterprise PL/I for z/OS Version 5 Release 3

- **Product renaming**

- IBM Application Delivery Foundation for z Systems® is renamed as Application Delivery Foundation for z/OS.
- IBM Developer for z Systems Enterprise Edition is renamed as IBM Developer for z/OS Enterprise Edition.
- IBM Developer for z Systems is renamed as IBM Developer for z/OS.
- IBM Debug for Systems is renamed as IBM Debug for z/OS.

- **IBM Debug for z/OS client installation**

- In addition to using IBM Installation Manager, you can now install the IBM Debug for z/OS client with Eclipse p2. For more information, see the "Installing the IBM Debug for z/OS client" topic in [IBM Documentation](#).

- **Debug Profile Service**

- Debug Profile Service is a REST API that uses the HTTP protocol to provide RESTful access to a set of resources related to debug profiles. You can use this service to create, retrieve, update and delete debug profiles.

For more information about host configuration, see [Adding support for Debug Profile Service and APIs](#).

For more details about the API, see the "z/OS Debug Profile Service API" documentation in [IBM Documentation](#).

- **Section breakpoint support**

- When you edit COBOL with the COBOL Editor or the z Systems LPEX Editor, a Toggle Section Breakpoint action is available in the left ruler context menu of the editor and the context menu for sections in the outline view. For more information, see the "Source entry breakpoints" topic in [IBM Documentation](#).

- **IMS Transaction Isolation facility**

- IMS Transaction Isolation facility no longer accesses IMS ACB libraries. It has a simplified setup and is compatible with ACB management by IMS Catalog. The setting of IMSISOORIGPSB in EQAOPTS no longer has any effect and the original PSB is always preserved. For more information, see [Scenario F: Enabling the Transaction Isolation Facility](#).
- Instructions for using the IMS PSTOP command are added to end the wait state of the IMS region when PWFI is used, so that you can continue with the program. For more information, see the "Using IMS pseudo wait-for-input (PWFI) with IMS Transaction Isolation" topic in *IBM z/OS Debugger User's Guide*.

Overview of IBM z/OS Debugger

IBM z/OS Debugger is the next iteration of IBM debug technology on IBM Z and consolidates the IBM Integrated Debugger and IBM Debug Tool engines into one unified technology. IBM z/OS Debugger is progressing towards one remote debug mode based on Debug Tool compatibility mode. In support of this direction, Debug Tool compatibility mode, when available in the user interface, is selected by default for V14.1.2 or later.

IBM z/OS Debugger is a host component that supports various debug interfaces, like the Eclipse and Visual Studio Code IDEs. z/OS Debugger and the supported debug interfaces are provided with the following products:

IBM Developer for z/OS Enterprise Edition

This product is included in [IBM Application Delivery Foundation for z/OS](#). IBM Developer for z/OS Enterprise Edition provides all the debug features.

IBM Developer for z/OS Enterprise Edition currently provides debug functions in the following IDEs:

- IBM Developer for z/OS Eclipse
- Wazi Developer for VS Code, through IBM Z Open Debug

See [Table 3 on page xxv](#) for the debug features supported in different IDEs.

IBM Developer for z/OS

IBM Developer for z/OS is a subset of IBM Developer for z/OS Enterprise Edition. IBM Developer for z/OS, previously known as IBM Developer for z Systems or IBM Rational® Developer for z Systems, is an Eclipse-based integrated development environment for creating and maintaining z/OS applications efficiently.

IBM Developer for z/OS includes all enhancements in IBM Developer for z/OS Enterprise Edition except for the debug features noted in [Table 2 on page xxiv](#).

IBM Debug for z/OS

IBM Debug for z/OS is a subset of IBM Developer for z/OS Enterprise Edition. IBM Debug for z/OS focuses on debugging solutions for z/OS application developers. See [Table 2 on page xxiv](#) for the debug features supported.

IBM Debug for z/OS does not provide advanced developer features that are available in IBM Developer for z/OS Enterprise Edition.

For information about how to install the IBM Debug for z/OS Eclipse IDE, see [Installation of IBM Developer for z Systems and IBM Debug for z Systems \(https://developer.ibm.com/mainframe/2016/12/02/installation-of-ibm-developer-for-z-systems-and-ibm-debug-for-z-systems/\)](#).

IBM Wazi Developer for Red Hat CodeReady Workspaces

IBM Wazi Developer for Red Hat CodeReady Workspaces is a single integrated solution, which delivers a cloud-native developer experience for z/OS. It enables application developers to develop and test z/OS application components in a virtual z/OS environment on an OpenShift-powered hybrid multicloud platform, and to use an industry standard integrated development environment (IDE) of their choice.

IBM Wazi Developer for Red Hat CodeReady Workspaces currently provides debug functions in the following IDEs:

- Wazi Developer for Workspaces, through IBM Z Open Debug
- Wazi Developer for VS Code, through IBM Z Open Debug
- Wazi Developer for Eclipse

See [Table 2 on page xxiv](#) and [Table 3 on page xxv](#) for the debug features supported in the product and different IDEs.

[Table 2 on page xxiv](#) maps out the features that differ in products. Not all the available features are listed. To find the features available in different remote IDEs, see [Table 3 on page xxv](#).

Table 2. Debug feature comparison

	IBM Debug for z/OS	IBM Developer for z/OS	IBM Developer for z/OS Enterprise Edition	IBM Wazi Developer for Red Hat CodeReady Workspaces
Main features				
3270 interface, including z/OS Debugger Utilities	√		√	
Eclipse IDE, see Table 3 on page xxv for feature details. ¹	√	√	√	√
IBM Z Open Debug provided with the Wazi Developer for Workspaces IDE, see Table 3 on page xxv for feature details.				√
IBM Z Open Debug provided with the Wazi Developer for VS Code IDE, see Table 3 on page xxv for feature details.			√	√
Code Coverage features				
Compiled Language Code Coverage	√	√ ²	√	
Headless Code Coverage		√	√	
Java™ Code Coverage		√	√	
ZUnit Code Coverage ³		√	√	
z/OS Debugger Code Coverage (3270 and remote interfaces) ⁴	√		√	
3270 features				
z/OS Debugger full screen, batch or line mode	√		√	
IMS Isolation support	√		√	
Compiler support features				

Table 2. Debug feature comparison (continued)

	IBM Debug for z/OS	IBM Developer for z/OS	IBM Developer for z/OS Enterprise Edition	IBM Wazi Developer for Red Hat CodeReady Workspaces
Assembler support: Create EQALANGX files	√	√	√	
Assembler support: Debugging ⁵	√	√	√ ⁶	√ ⁶
LANGX COBOL support ⁷	√	√	√	
Support for Automatic Binary Optimizer (ABO)	√	√	√	
Load Module Analyzer	√		√	

Notes:

1. The following features are supported only in the standard mode of a remote Eclipse IDE:

- Support for 64 bit Enterprise PL/I for z/OS Version 5
- Support for 64 bit C/C++ feature of z/OS
- Source view for COBOL V6.2 and later

2. IBM Developer for z/OS includes z/OS Debugger remote debug and compiled code coverage Eclipse interface, but does not include z/OS Debugger Code Coverage.

3. ZUnit Code Coverage is only supported in Debug Tool compatibility mode.

4. z/OS Debugger Code Coverage can only be enabled in the 3270 interface.

5. Debugging assembler requires that you have EQALANGX files that have been created via ADFz Common Components or a product that ships the ADFz Common Components.

6. This feature is only available with the Eclipse IDE.

7. LANGX COBOL refers to any of the following programs:

- A program compiled with the IBM OS/VS COBOL compiler.
- A program compiled with the IBM VS COBOL II compiler with the NOTEST compiler option.
- A program compiled with the IBM Enterprise COBOL for z/OS Version 3 or Version 4 compiler with the NOTEST compiler option.

Table 3. Remote IDE debug feature comparison

Feature	Eclipse-based debug interface	IBM Z Open Debug ¹
Debug Tool compatibility mode ²	√	√
Standard mode ³	√ ⁴	
Integration with Language Editors	<ul style="list-style-type: none"> • COBOL Editor⁵ • PL/I Editor⁵ • Remote C/C++ Editor^{4,5} • System z LPEX Editor^{4,5} 	<ul style="list-style-type: none"> • Z Open Editor

Table 3. Remote IDE debug feature comparison (continued)

Feature	Eclipse-based debug interface	IBM Z Open Debug ¹
Visual Debug	√ ⁵	
Debugging ZUnit tests	√ ⁶	
Debug profile management	√ ⁴	√
IMS Isolation UI	√ ⁷	
Integration with CICS Explorer views	√ ^{4,5}	
Integration with property groups	√ ⁵	
Team Debug support	√ ^{4,5}	
Integrated launch	<ul style="list-style-type: none"> • z/OS UNIX Application launch configuration • z/OS Batch Application using existing JCL • z/OS Batch Application using a property group⁵ 	
Debug Tool Plug-ins	√ ^{4, 8}	
Modules	√	
Memory	√	
Program navigation		
Step over/Next	√	√
Step into/Step in	√	√
Step return/Step out	√	√
Jump to location	√	
Run to location/Run to cursor	√	√
Resume/Continue	√	√
Terminate	√	√
Animated step	√	
Playback	√	
Breakpoints		
Line/statement breakpoints	√	√
Entry breakpoints	√	
Source entry breakpoints	√	
Event breakpoint	√	
Address breakpoint	√	
Watch breakpoint	√	
Variables & Registers		
Variables	√	√

Table 3. Remote IDE debug feature comparison (continued)

Feature	Eclipse-based debug interface	IBM Z Open Debug ¹
Registers	√	√ ⁹
Modifying variable and register values	√	√
Setting variable filter	√	
Changing variable representation	√	
Dereferencing variables	√	
Displaying in memory view	√	
Monitors		
Displaying monitor	√	√
Modifying monitor value	√	
Changing variable representation	√	
Dereferencing variables	√	
Debug Console		
Evaluating variables and expressions		√
z/OS Debugger commands	√	

Notes:

1. IBM Z Open Debug is provided with Wazi Developer for Workspaces and Wazi Developer for VS Code.
2. Debug Tool compatibility mode does not support 64-bit programs.
3. The following features are supported only in standard mode:
 - Support for 64 bit Enterprise PL/I for z/OS Version 5
 - Support for 64 bit C/C++ feature of z/OS
 - Source view for COBOL V6.2 and later
4. This feature is not available in Wazi Developer for Eclipse.
5. This feature is not available in IBM Debug for z/OS.
6. Debugging ZUnit tests is only supported in Debug Tool compatibility mode.
7. This feature is only available in IBM Developer for z/OS Enterprise Edition.
8. IBM Developer for z/OS includes Debug Tool plug-ins, but does not include Load Module Analyzer and z/OS Debugger Code Coverage 3270 interfaces.
9. Registers are available in the **Variables** view.

Chapter 1. Customizing z/OS Debugger: checklist

Note: You can also use [Host Configuration Assistant for Z Development \(HCA\)](https://ibm-host-configuration-assistant-for-z-development.au-syd.mybluemix.net/#/) (https://ibm-host-configuration-assistant-for-z-development.au-syd.mybluemix.net/#/) to generate a customized checklist for z/OS Debugger. HCA is a free cloud-based wizard that is designed to simplify planning and configuring of Z development products. Besides z/OS Debugger, you can also find the configuration information for other host components like z/OS Explorer and z/OS Source Code Analysis.

This topic helps you identify which customization tasks you must do. Begin by reviewing the topic "Planning your debug session" in the *IBM z/OS Debugger User's Guide* with your application programmers and library system administrator. Reviewing that topic helps you gather the following information, which you need to identify which customization tasks you must do:

- Which version of compilers you are using
- Whether you are debugging Db2, Db2 stored procedures, CICS, and IMS programs
- Whether you are using full-screen mode, full-screen mode using the Terminal Interface Manager, batch mode, or remote debug mode
- How your programs will call z/OS Debugger
- Whether you will be using IBM z/OS Debugger Utilities, ADFz Common Components, or Application Delivery Foundation for z/OS tools
- Whether you will need to modify some of the debugger's behavior

After you gather this information, review the following checklists. As you read each item on the checklist, you use the information you gathered to determine if you need to do that customization task. If the task is not applicable to your site, you can skip that task.

You must do all of the following compulsory customization tasks:

- [Chapter 2, "Product Registration," on page 7](#)
- [Chapter 3, "Installing the z/OS Debugger SVCs," on page 9.](#)
- [Chapter 4, "Setting up the APF-authorized system link list data set \(SEQABMOD\)," on page 13](#)
- [Chapter 5, "Setting up the link list data set \(SEQAMOD\)," on page 15](#)
- [Chapter 6, "Enabling debugging in full-screen mode using the Terminal Interface Manager," on page 17.](#)
- If your application programmers debug in remote debug mode, review [Chapter 7, "Adding support for remote debug users," on page 25.](#)
- Read [Chapter 8, "Specifying the TEST runtime options through the Language Environment user exit," on page 61](#) and review with your users to see if they need you to do this customization.

If you previously installed any of these Language Environment user exits: EQADDCXT, EQADICXT, EQADBCXT, switch to the EQAD3CXT user exit.

If you previously installed the Language Environment user exit EQAD3CXT, rebuild this exit. z/OS Debugger has updated the sample assembler user exits and the load modules.

- Read [Chapter 9, "Installing the browse mode RACF facility," on page 67](#) if you want to control which users have access to z/OS Debugger, or control which users can access z/OS Debugger only through browse mode.

Note: If you have defined a generic Facility class profile (for example, **), you might have to install the browse mode RACF facilities, even if neither of the previous considerations applies. For example, if you have a generic Facility class profile of ** with UACC(NONE) and you do not install the browse mode RACF facilities, no users would be allowed to use z/OS Debugger.

If you are using IBM z/OS Debugger Utilities, you must do the required customization tasks described in the following topics:

- [“Choosing a method to start IBM z/OS Debugger Utilities” on page 70.](#)
- [“Customizing the data set names in EQASTART” on page 71.](#)
- [“Adding IBM z/OS Debugger Utilities to the ISPF menu” on page 72.](#)
- For the JCL for Batch Debugging utility, you must specify default values for the yb1dtmod and yb1dtbin parameters. See [“Customizing for JCL for Batch Debugging utility” on page 72.](#)

If you are using any of the following utilities in IBM z/OS Debugger Utilities, you must do an additional customization task:

- If you are using z/OS Debugger Setup Utility, see [“Customizing z/OS Debugger Setup Utility” on page 72.](#)
- If you are using other IBM Application Delivery Foundation for z/OS tools, such as File Manager for z/OS, see [“Customizing Other IBM Application Delivery Foundation for z/OS tools for multiple systems” on page 75.](#)
- If you are using Program Preparation, see [“Customizing Program Preparation” on page 76.](#)
- For the IMS BTS Debugging option, you must specify default values for yb2* parameters. See [“Customizing IMS BTS Debugging” on page 81.](#)

If you are debugging Db2 stored procedures, CICS program, or IMS programs, you must do the following required customization tasks:

- If your site debugs Db2 stored procedures, see [Chapter 11, “Preparing your environment to debug Db2 stored procedures,” on page 89.](#)
- If your site debugs CICS programs, see [Chapter 12, “Adding support for debugging under CICS,” on page 91.](#)
- If your site debugs IMS programs, see [Chapter 13, “Adding support for debugging under IMS,” on page 111](#) and implement scenario A.
- If your site debugs non-Language Environment IMS programs, see [Chapter 13, “Adding support for debugging under IMS,” on page 111](#) and implement scenario C.

In Debug Tool Version 13.1, the EQALANGP and EQALANGX modules were moved from Debug Tool's EQAW.SEQAMOD library to Common Component's IPV.SIPVMODA library, where they will be aliases of IPVLANGP and IPVLANGX respectively. This removes duplication between the two tools. If you have library build processes or other tools that reference either of these routines, and IPV.SIPVMODA is not in link list, then you will need to update your processes to point to the new location for these routines. See *Preparing a LANGX COBOL program* and *Preparing an assembler program* in the *IBM z/OS Debugger Customization Guide* for more information about EQALANGX.

Note: Debug Tool for z/OS is now named as z/OS Debugger, and Problem Determination Tools for z/OS Common Component is now named IBM Application Delivery Foundation for z/OS Common Components.

As you review the rest of the checklist, if you need to do an item that requires that you specify an EQAOPTS command, you can print a copy of [Table 29 on page 134](#) and use it to record the commands you need to specify and the values for any options. When you are done reviewing the checklist, you can specify all the EQAOPTS commands at one time as described in [“Creating EQAOPTS load module” on page 140.](#)

For any of the following situations, see [“CODEPAGE” on page 144:](#)

- Application programmers are debugging in remote debug mode and the source or compiler use a code page other than 037. If your C/C++ source contains square brackets or other special characters, you might need to specify an EQAOPTS CODEPAGE command to override the z/OS Debugger default code page (037). Check the code page specified when you compiled your source. The C/C++ compiler uses a default code page of 1047 if you do not explicitly specify one. If the code page used is 1047 or a code page other than 037, you need to specify an EQAOPTS CODEPAGE command specifying that code page.
- Application programmers are debugging in full screen mode and encounter one of the following situations:
 - They use the STORAGE command to update COBOL NATIONAL variables.

- The source is coded in a code page other than 037.
- Application programmers use the XML (CODEPAGE(ccsid)) parameter on a LIST CONTAINER or LIST STORAGE command to specify an alternate code page.

Do the customization tasks in the following list only if your site needs the features described:

- These EQAOPTS commands enable certain z/OS Debugger functions:
 - [“ALTDISP” on page 140](#)
You want z/OS Debugger to display the at sign (@) in the prefix area of a line to indicate that the line contains a breakpoint, instead of using a colored line.
 - [“BROWSE” on page 141](#)
You want to restrict access to z/OS Debugger or control which users¹ must debug in browse mode.
 - [“CCOUTPUTDSN” on page 141](#)
You want to use Code Coverage and need to specify the name of the Observation data set.
 - [“CCOUTPUTDSNALLOC” on page 142](#)
You want to use Code Coverage and need to specify the allocation parameters for the Observation data set.
 - [“CCPROGSELECTDSN” on page 143](#)
You want to use Code Coverage and need to specify the name of the Options data set.
 - [“DLAYDBG” on page 147](#)
You want to allow users to use the delay debug mode.
 - [“DOPTACBDSN” on page 150](#)
You want to use the IMS Transaction Isolation Facility described in [Chapter 13, “Adding support for debugging under IMS,” on page 111](#).
 - [“EQAQPP” on page 152](#)
Your site needs to debug Q++ programs.
 - [“IGNOREODOLIMIT” on page 154](#)
You want to tell z/OS Debugger to display COBOL table items even when an ODO value is out of range.
 - [“LOGDSNALLOC” on page 156](#)
You want z/OS Debugger to automatically create a LOG data set for each user.
 - [“MDBG” on page 158](#)
Your site uses z/OS XL C/C++, Version 1.10, or later, and you want z/OS Debugger to retrieve source and debug information from .mdbg files.
 - [“SAVESETDSNALLOC, SAVEBPDSNALLOC” on page 161](#)
You want z/OS Debugger to automatically create either of the following data sets:
 - A data set to save and restore settings
 - A data set to save and restore breakpoints, monitor values and LOADDEBUGDATA (LDD) specifications
 - [“STARTSTOPMSG” on page 164](#)
You want z/OS Debugger to issue a message when each debugging session is initiated or terminated.
 - [“SUBSYS” on page 165](#)
If your site uses a library system that uses the SUBSYS allocation parameter and your application programmers debug C, C++, or Enterprise PL/I programs, review this command to determine if you need to change the SUBSYS parameter.
 - [“SVCSCREEN” on page 165](#)
You need to debug non-Language Environment programs that start under Language Environment, Language Environment programs that use the MVS LINK, LOAD or DELETE services, LangX COBOL

¹ If you want to enforce browse mode restrictions, you must use the RACF Facility Class Profile as described in [Chapter 9, “Installing the browse mode RACF facility,” on page 67](#). You can learn how the EQAOPTS BROWSE command works with the RACF profiles by reviewing the table in the topic "Controlling browse mode" of the *IBM z/OS Debugger User's Guide*.

programs, or your site has any host products that might use SVC screening when z/OS Debugger is started.

- If your site uses any of the following functions in a Japanese or Korean environment, see [“Enabling additional languages for some z/OS Debugger components through EQACUIDF”](#) on page 130:
 - IBM z/OS Debugger Utilities ISPF panels
 - z/OS Debugger Code Coverage
 - EQANMDBG (non-CICS non-Language Environment support)

Do the customization tasks in the following list only if you want to modify the behavior described:

- These EQAOPTS commands modify the behavior of certain z/OS Debugger functions:
 - [“CACHENUM”](#) on page 141
You want to reduce z/OS Debugger's CPU consumption in certain cases.
 - [“CEEREAFTERQDBG”](#) on page 143
You want to restart z/OS Debugger with CEETEST after you use QUIT DEBUG.
 - [“COMMANDSDSN”](#) on page 146
You want to change the default data set name for the user's commands file.
 - [“DEFAULTVIEW”](#) on page 147
You want to change the default setting for SET DEFAULT VIEW so that assembler macro-generated statements are not displayed in the Source window.
 - [“DLAYDBGEND”](#) on page 148
You want to change the default delay debug setting for monitoring condition events.
 - [“DLAYDBGDSN”](#) on page 148
You want to change the default name of the delay debug profile data set.
 - [“DLAYDBGTRC”](#) on page 149
You want to change the default delay debug pattern match trace message level.
 - [“DLAYDBGXRF”](#) on page 149
You want to instruct delay debug to use the cross reference file to find the user ID when it constructs the delay debug profile data set name.
 - [“DTCNDELETEDEADPROF”](#) on page 151
You want to change the default setting for controlling the deletion of dead DTCN profiles.
 - [“DTCNFORCExxxx”](#) on page 151
You want to change the default DTCN behavior for certain resource types.
 - [“DYNDEBUG”](#) on page 152
You want to change the initial or default value of SET DYNDEBUG.
 - [“GPFDSN”](#) on page 153
Your site wants to control the appearance or settings, through z/OS Debugger commands, of all debugging sessions, create a global preferences file. The global preferences file is a file that is processed at the beginning of every debugging session and contains z/OS Debugger commands. See this command for instructions on how to create a global preferences file.
 - [“HOSTPORTS”](#) on page 154
Your users are using the remote debugger and you need to specify a host port or range of ports for a TCP/IP connection from the host to the workstation.
 - [“LOGDSN”](#) on page 155
You want to change the default data set name for the LOG data set.
 - [“MAXTRANUSER”](#) on page 157
You want to use the IMS Transaction Isolation Facility described in [Chapter 13, “Adding support for debugging under IMS,”](#) on page 111, and you need to set the maximum number of transactions that a single user can debug to something less than 15.
 - [“MULTIPROCESS”](#) on page 158
You want to change the default behavior of z/OS Debugger when a new POSIX process is created by a fork() or exec() function.

- [“NAMES” on page 159](#)
Your site needs to issue a NAMES command for the initial load module or any of its compile units.
- [“NODISPLAY” on page 160](#)
To modify the debugger's behavior when a full-screen mode using the Terminal Interface Manager or a remote debugger is not available.
- [“PREFERENCESDSN” on page 160](#)
You want to change the default data set name for the user's preferences file.
- [“SAVEBPDSN, SAVESETDSN” on page 161](#)
Your site wants to change the default names, which are *userid*.DBGTOOL.SAVESETS and *userid*.DBGTOOL.SAVEBPS, of the data sets that store settings, breakpoints, and monitor values.
- [“SESSIONTIMEOUT” on page 163](#)
You want to specify an idle session timeout for users who are using the Terminal Interface Manager.
- [“STARTSTOPMSGDSN” on page 165](#)
You want z/OS Debugger to write information to a log data set when each non-CICS debugging session is initiated or terminated.
- [“TCPIPDATA” on page 168](#)
Your users are using the remote debugger and your host TCP/IP does not have a specification for GLOBALTCPIPDATA.
- [“THREADTERMCOND” on page 169](#)
Your site wants z/OS Debugger to suppress the prompt that Language Environment displays every time when the statements like STOP RUN, GOBACK, or EXEC CICS RETURN are run. These statements can occur frequently in an application program, creating unnecessary interruptions for a user trying to debug the application program.
- [“TIMACB” on page 169](#)
You want to change the default ACB name for the Terminal Interface Monitor.
- If your site is using the EQAUEDAT user exit to direct z/OS Debugger to the location of source, listing, or separate debug files, see [Chapter 14, “Enabling the EQAUEDAT user exit,” on page 127](#).
- If your site needs to change the defaults for NATLANG, LOCALE, or LINECOUNT, see [“Changing the default and allowable values in EQACUIDF” on page 129](#).

Chapter 2. Product Registration

You must set up product registration for z/OS Debugger.

Registering z/OS Debugger

z/OS Debugger is available as a component of multiple products. Different functions of z/OS Debugger are enabled according to the product you purchased.

- IBM Developer for z/OS Enterprise Edition V14.2.0, program number 5655-AC5 (Shopz orderable)
- IBM Debug for z/OS V14.2.0, program number 5655-Q50 (Shopz orderable)
- IBM Developer for z/OS V14.2.0, program number 5724-T07 (web download)
- IBM Wazi Developer for Red Hat CodeReady Workspaces V1.0.0, program number 5900-A8N (web download)

In turn, IBM Developer for z/OS Enterprise Edition is a part of IBM Application Delivery Foundation for z/OS V3.2, program number 5655-AC6 (Shopz orderable).

You must set up z/OS product registration for z/OS Debugger to enable its functions. Products to be enabled on z/OS are defined in the IFAPRDxx parmlib member that is used for IPL.

If you already defined the product using FEATURENAME(' * ') for another component of the product, you do not need to repeat the definition. Otherwise, you must specify **one** of the following IFAPRDxx entries, depending on how you purchased z/OS Debugger:

- If you acquired z/OS Debugger as a part of IBM Application Delivery Foundation for z/OS (product code 5655-AC6), specify the following definition in IFAPRDxx. Sample member EQAWIFAA, which contains the next statements, is provided in the SEQASAMP sample library.

```
PRODUCT OWNER(' IBM CORP' )
        NAME(' IBM APP DLIV FND' )
        ID(5655-AC6)
        VERSION(*) RELEASE(*) MOD(*)
        FEATURENAME(*)
        STATE(ENABLED)
```

- If you acquired z/OS Debugger as a part of IBM Developer for z/OS Enterprise Edition (product code 5655-AC5), specify the following definition in IFAPRDxx. Sample member EQAWIFAE, which contains the next statements, is provided in the SEQASAMP sample library.

```
PRODUCT OWNER(' IBM CORP' )
        NAME(' IBM IDz EE' )
        ID(5655-AC5)
        VERSION(*) RELEASE(*) MOD(*)
        FEATURENAME(*)
        STATE(ENABLED)
```

- If you acquired z/OS Debugger as a part of IBM Debug for z/OS (product code 5655-Q50), specify the following definition in IFAPRDxx. Sample member EQAWIFAD, which contains the next statements, is provided in the SEQASAMP sample library.

```
PRODUCT OWNER(' IBM CORP' )
        NAME(' IBM Debug for z' )
        ID(5655-Q50)
        VERSION(*) RELEASE(*) MOD(*)
        FEATURENAME(*)
        STATE(ENABLED)
```

- If you acquired z/OS Debugger as a part of IBM Developer for z/OS (product code 5724-T07), specify the following definition in IFAPRDxx. Sample member EQAWIFAZ, which contains the next statements, is provided in the SEQASAMP sample library.

```
PRODUCT OWNER('IBM CORP')
        NAME('IBM IDz')
        ID(5724-T07)
        VERSION(*) RELEASE(*) MOD(*)
        FEATURENAME(*)
        STATE(ENABLED)
```

- If you acquired z/OS Debugger as a part of IBM Wazi Developer for Red Hat CodeReady Workspaces (product code 5900-A8N), specify the following definition in IFAPRDxx. Sample member EQAWIFAW, which contains the next statements, is provided in the SEQASAMP sample library.

```
PRODUCT OWNER('IBM CORP')
        NAME('IBM Wazi Code')
        ID(5900-A8N)
        VERSION(*) RELEASE(*) MOD(*)
        FEATURENAME(*)
        STATE(ENABLED)
```

Notes:

- These sample definitions enable all features of the selected product. To register each feature individually, create a PRODUCT block for each feature and specify FEATURENAME('IDz-DEBUGGER') to register the z/OS Debugger feature.
- If you do not register any of the listed products in the IFAPRDxx parmlib member, z/OS Debugger will assume that you purchased IBM Developer for z/OS (product code 5724-T07) and enable only the related functions.

After you update IFAPRDxx, issue the **SET PROD=xx** operator command to dynamically activate the definitions. z/OS Debugger will then be enabled in your z/OS environment.

IBM advises against defining IFAPRDxx entries that have NAME(*) or ID(*) fields, as this will result in all z/OS applications that utilize product registration to find a match on the first test, and adhere to the related STATE() definition. For z/OS Debugger with STATE(ENABLED), this means that the application will register as Application Delivery Foundation for z/OS (product code 5655-AC6).

If your site has coded a generic entry in IFAPRDxx, complete the following steps:

1. Code an entry for each item that you did not purchase STATE(NOTDEFINED).
2. Code an entry for the item you did purchase as shown in the previous text.
3. Issue a **SET PROD=xx** operator command.

Removing old registrations

Remove all old registration entries that belonged to z/OS Debugger. Older versions of z/OS Debugger were known as Debug Tool, or Debug Tool Utilities and Advanced Functions.

To remove old registration entries, complete the following steps:

1. Change the STATE(ENABLED) parameter for the old entries in the IFAPRDxx parmlib member to STATE(NOTDEFINED).
2. Issue a **SET PROD=xx** operator command to activate your changes.
3. Remove the old entries from IFAPRDxx. This update will become active at next IPL.

Chapter 3. Installing the z/OS Debugger SVCs

z/OS Debugger requires the installation of the z/OS Debugger SVC programs EQA00SVC (IGC0014E) and EQA01SVC (IGX00051):

- EQA00SVC is a type 3 SVC with a reserved number of 145 (x'91').
- EQA01SVC is a type 3 using SVC number 109 (X'6D') with function code 51.

The z/OS Debugger SVCs are compatible with z/OS Debugger Version 14 Release 1 (Program Number 5724-T07), z/OS Debugger Version 14 Release 0 (Program Number 5724-T07), Debug Tool Version 13 Release 1 (Program Number 5655-Q10), and Version 12 Release 1 (Program Number 5655-W70).

The z/OS Debugger SVCs support the Dynamic Debug facility and other necessary z/OS Debugger functions.

To install the SVCs, do the following steps on each of the LPARs that z/OS Debugger will be used on:

1. Select one or both of the following alternatives:

- Install the SVCs through a system IPL. The SMP/E APPLY operation, which you run when you install z/OS Debugger or apply a PTF, updates the library *h1q*.SEQALPA with the SVCs. To place *h1q*.SEQALPA in the LPA list, add it to an LPALSTxx member of parmlib that is used for IPL. If you have earlier releases of z/OS Debugger installed at your site, remove any other SEQALPA data sets. The next time you IPL your system, the SVCs are automatically installed.

Check SYS1.LPALIB for the following members and, if you find them, remove them:

- EQA00SVC
- EQA01SVC
- IGC0014E (ALIAS of EQA00SVC)
- IGX00051 (ALIAS of EQA01SVC)

These members might have been placed there by previous installations of z/OS Debugger. Because SYS1.LPALIB is always searched before the data sets in LPALSTxx, these older members would be found before the newer members in LPALSTxx.

- Install the SVCs without a system IPL. The SMP/E APPLY operation, which you run when you install z/OS Debugger or apply a PTF, updates the library *h1q*.SEQAAUTH with the SVCs and the dynamic SVC installer. See [“Installing the SVCs without using a system IPL”](#) on page 9 for information about how to immediately install or update the SVCs.

2. Follow the instructions in [“Using the Authorized Debug facility for protected programs”](#) on page 11.

Installing the SVCs without using a system IPL

To install the SVCs without using a system IPL (referred to as a dynamic installation), perform the following steps:

1. Mark the *h1q*.SEQAAUTH data set as APF-authorized². This data set contains SVC installation programs; therefore, access to it must be limited to system programmers.
2. Update both places in the SVC dynamic install job EQAWISVC (shipped as a member of the data set *h1q*.SEQASAMP) with the fully qualified name for the z/OS Debugger *h1q*.SEQAAUTH data set. Eye-catchers (<<<<<) in the job highlight the statements that require changing. You might also need to update the job card.

² To APF-authorize a data set, add an APF ADD statement for the data set to a PROGxx member of parmlib that is used for IPL. To immediately APF-authorize the data set, use the SETPROG APF MVS command.

3. Submit the job. The job installs both SVCs. After the job is completed, verify that the return code is 00 (RC=00).
4. Any CICS or IMS regions that are running when these SVCs are installed, and that may have had z/OS Debugger sessions, should be stopped and restarted.

Verifying the installation of the SVCs

To verify the installation of the SVCs, you need to check the level of the z/OS Debugger SVCs, then run the installation verification programs.

Checking the level of the z/OS Debugger SVCs

Display the level of the z/OS Debugger SVCs installed by entering the following command:

```
EXEC 'hlq.SEQAEXEC(EQADTSVC)'
```

Information about EQA00SVC that is similar to the following is displayed. Verify that the version and compile date that are displayed are the same or higher than what is shown here.

Note: The string `Debug Tool` in the output of EQADTSVC is expected. The string was preserved for downward compatibility with Debug Tool. The 5724-T07 denotes that the SVC is from z/OS Debugger.

```
...EQA00SVC 2021.295Licensed Materials - Property of IBM 5724-T07 Debug Tool Version 05
EQA00SVC-82684Copyright Copyright IBM Corp. US Government Users
***> EQA00SVC is Version 05 with compile date 22 Oct 2021
```

Information about EQA01SVC that is similar to the following is displayed. Verify that the version and compile date that are displayed are the same or higher than what is shown here.

```
...EQA01SVC 2021.295Licensed Materials - Property of IBM 5724-T07 Debug Tool Version 19
EQA01SVC-r84160Copyright Copyright IBM Corp. US Government Users
***> EQA01SVC is Version 19 with compile date 22 Oct 2021
```

```
...EQA01SV2 2021.295Licensed Materials - Property of IBM 5724-T07 Debug Tool Version 05
EQA01SV2-R87185Copyright Copyright IBM Corp. US Government Users
***> EQA01SV2 is Version 05 with compile date 22 Oct 2021
```

```
...EQA01TSR 2021.295Licensed Materials - Property of IBM 5724-T07 Debug Tool Version 00
EQA01TSR-f8730eCopyright Copyright IBM Corp. US Government Users
***> EQA01TSR is Version 00 with compile date 22 Oct 2021
```

Running the installation verification programs for SVCs

To help you verify the installation of the z/OS Debugger SVCs (that the SVCs are installed and working correctly), the `hlq.SEQASAMP` data set contains installation verification programs (IVPs) in the following members. Run the IVPs that are appropriate for the tasks that your users will be performing. Before you run any IVP, customize it for your installation as described in the member.

<i>Table 4. Name of the installation verification program and the programming language corresponding to that installation verification program.</i>	
IVP	Task
EQAWIVP4	COBOL TEST (NONE, SYM) or TEST (NOHOOK)
EQAWIVPF	PL/I TEST (ALL, SYM, NOHOOK)
EQAWIVPI	Enterprise PL/I TEST (ALL, SYM, NOHOOK, SEPARATE)
EQAWIVPJ	LangX Enterprise COBOL
EQAWIVPP	COBOL TEST (NONE, SYM, SEPARATE) or TEST (NOHOOK, SEPARATE)

Table 4. Name of the installation verification program and the programming language corresponding to that installation verification program. (continued)

IVP	Task
EQAWIVPT	Enterprise COBOL for z/OS Version 5 TEST
EQAWIVPS	disassembly
EQAWIVPA	Language Environment assembler
EQAWIVPB ³	Language Environment assembler - interactive
EQAWIVPC	non-Language Environment assembler
EQAWIVPV	OS/VS COBOL
EQAWIVPX	non-Language Environment VS COBOL II

Table 5. Name of the installation verification program for standard mode and the programming language corresponding to that installation verification program.

IVP	Task
EQAZIVPF	Language Environment High Level Assembler Version 1 Release 6 ADATA
EQAZIVPI	Enterprise PL/I for z/OS Version 4 or Version 5 31-bit TEST (NOHOOK, SEPARATE)
EQAZIVPP	Enterprise PL/I for z/OS Version 5 64-bit TEST
EQAZIVPT	Enterprise COBOL for z/OS Version 5 or Version 6 TEST
EQAZIVP5	Enterprise COBOL for z/OS Version 3 Release 4 or Version 4 NOTEST
EQAZIVP6	z/OS XL C DEBUG (FORMAT (DWARF) , NOHOOK)

Notes:

- For more information about standard mode, see "Remote debug mode" in "Chapter 1: z/OS Debugger: overview" in the *IBM z/OS Debugger User's Guide*.
- There are no installation verification programs for SVCs written specifically for IBM Wazi Developer for Red Hat CodeReady Workspaces. You can though, modify EQAWIVP4, EQAWIVPF, EQAWIVPI, EQAWIVPP or EQAWIVPT to run interactively with the workstation GUI for IBM Wazi Developer for Red Hat CodeReady Workspaces.

Using the Authorized Debug facility for protected programs

If your users need to use the Dynamic Debug facility to debug programs that are loaded into protected storage (located in subpool 251 or 252), your security administrator must authorize those users to use the Authorized Debug facility. Examples of reentrant programs that are loaded into protected storage are:

- Re-entrant programs loaded from an APF authorized library by MVS
- Programs loaded by CICS into RDSA or ERDSA because RENTPGM=PROTECT

Important: Before you do this task, you must have installed and verified the SVCs.

To authorize users to use the Authorized Debug facility:

³ This IVP is provided for customers that purchased z/OS Debugger via IBM Developer for z/OS - non-Enterprise Edition. In this case, z/OS Debugger only runs with the IBM Developer for z/OS remote debugger. This IVP has instructions that describe how to run the IVP with the IBM Developer for z/OS remote debugger in Debug Tool compatibility mode. The other IVPs in this table do not.

1. Establish a profile for the Authorized Debug Facility in the FACILITY class by entering the RDEFINE command:

```
RDEFINE FACILITY EQADTOOL.AUTHDEBUG UACC(NONE)
```

2. Verify that generic profile checking is in effect for the class FACILITY by entering the following command:

```
SETROPTS GENERIC(FACILITY)
```

3. Give a user permission to use the Authorized Debug Facility by entering the following command, where *DUSER1* is the name of a RACF-defined user or group profile:

```
PERMIT EQADTOOL.AUTHDEBUG CLASS(FACILITY) ID(DUSER1) ACCESS(READ)
```

Instead of connecting individual users, the security administrator can specify *DUSER1* to be a RACF group profile and then connect authorized users to the group.

In CICS, z/OS Debugger checks that the region user ID is authorized instead of an individual CICS user ID.

4. If the FACILITY class is not active, activate the class by entering the SETROPTS command:

```
SETROPTS CLASSACT(FACILITY)
```

Issue the SETROPTS LIST command to verify that FACILITY class is active.

5. Refresh the FACILITY class by issuing the SETROPTS RACLIST command:

```
SETROPTS RACLIST(FACILITY) REFRESH
```

Chapter 4. Setting up the APF-authorized system link list data set (SEQABMOD)

Note: This chapter is not applicable to IBM Developer for z/OS (non-Enterprise Edition) or IBM Wazi Developer for Red Hat CodeReady Workspaces.

You must make certain z/OS Debugger load modules available in an APF-authorized data set that is in the system link list concatenation. You can do this in one of the following ways, depending on your site policy:

- Mark and add the load modules by doing the following steps:
 1. Mark the *hlq*.SEQABMOD data set as APF-authorized.²
 2. Add the data set to the system link list concatenation.⁴
 3. If you have earlier releases of z/OS Debugger installed, remove any other SEQABMOD data sets.
 4. Do an LLA refresh to make the members in *hlq*.SEQABMOD available to z/OS Debugger.
- Copy the load modules and refresh the members by doing the following steps:
 1. Copy⁵ all the members of the *hlq*.SEQABMOD data set into an existing APF-authorized system link list data set.
 2. Do an LLA refresh to make these members available to z/OS Debugger.

⁴ To add a data set to the link list, add a LNKLST ADD statement for the data set to a PROGxx member of parmlib that is used for IPL. To immediately add a data set to the link list, use the SETPROG LNKLST MVS command. Then, if the link list data set is managed by LLA, enter a F LLA, REFRESH MVS command to refresh the Library Lookaside Directories.

⁵ If you do this copy, you must repeat this copy after you apply any service to z/OS Debugger. SMP/E does not do this copy for you.

Chapter 5. Setting up the link list data set (SEQAMOD)

The *hlq*.SEQAMOD data set must be in the load module search path whenever you debug a program with z/OS Debugger. Except for two cases, it will be convenient for your users if you put *hlq*.SEQAMOD in the system link list concatenation. The exceptions are:

- CICS, where *hlq*.SEQAMOD must be placed in the DFHRPL concatenation. See [Chapter 12, “Adding support for debugging under CICS,”](#) on page 91.
- When the z/OS Debugger Setup Utility component of the IBM z/OS Debugger Utilities ISPF function is used to start the debugging session (where DTSU accesses *hlq*.SEQAMOD for you).

In all other cases, unless you put *hlq*.SEQAMOD in the system link list concatenation, the user will have to alter the execution environment of any program being debugged so that *hlq*.SEQAMOD is in the load module search path (such as placing it in JOBLIB, STEPLIB, ISPLLIB or via use of TSOLIB). Therefore, it is recommended that you add the *hlq*.SEQAMOD data set to the system link list concatenation⁴. For CICS, you also need to mark *hlq*.SEQAMOD as APF-authorized².

hlq.SEQAMOD must be placed before any other library in the load module search path that contains CEEVDBG for z/OS Debugger to get control of a debug session.

Chapter 6. Enabling debugging in full-screen mode using the Terminal Interface Manager

Note: This chapter is not applicable to IBM Developer for z/OS (non-Enterprise Edition) or IBM Wazi Developer for Red Hat CodeReady Workspaces.

To enable users to debug the following types of programs while using a 3270-type terminal, you need to enable full-screen mode using the Terminal Interface Manager:

- Batch programs
- TSO programs (using a separate terminal for debugging)
- Programs running under UNIX System Services
- Db2 stored procedures
- IMS programs

This topic focuses on setting up the Terminal Interface Manager to enable a terminal session that can be used to debug these types of programs in full-screen mode. To set up a dedicated terminal without using Terminal Interface Manager, see [Appendix B, “Enabling debugging in full-screen mode using a dedicated terminal,”](#) on page 173.

To understand how a user and z/OS Debugger interact with the Terminal Interface Manager, see [“How users start a full-screen mode debug session with the Terminal Interface Manager”](#) on page 17.

To enable debugging in full-screen mode using the Terminal Interface Manager, see [“Enabling full-screen mode using the Terminal Interface Manager”](#) on page 19. If you are running the Terminal Interface Manager on a VTAM® network with multiple LPARs, see [“Example: Defining the VTAM EQAMVnnn and Terminal Interface Manager APPL definition statements when z/OS Debugger runs on four LPARs”](#) on page 23 for variations on the instructions.

How users start a full-screen mode debug session with the Terminal Interface Manager

The following steps describe how a user would start a full-screen mode debugging session for a batch job with the Terminal Interface Manager. Study these steps to understand how z/OS Debugger uses the Terminal Interface Manager to display a full-screen mode debugging session and to understand why you need to do the configuration steps described in [“Enabling full-screen mode using the Terminal Interface Manager”](#) on page 19.

1. Start two terminal sessions. These sessions can be either of the following situations:
 - Two separate terminal emulator sessions.
 - If you use a session manager, two sessions selected from the session manager menu.In either situation, ensure that the second session connects to the Terminal Interface Manager.
2. On the first terminal session, log on to TSO.
3. On the second terminal session, provide your login credentials to the Terminal Interface Manager and press Enter. The login credentials can be your TSO user ID and password, PassTicket, password phrase, or MFA token.

Notes:

- a. You are not logging on TSO. You are indicating that you want your user ID associated with this terminal LU.
- b. When the number of characters entered into the password field, including blanks, exceeds 8, the input is passed to the security system as a password phrase.

- c. To use PassTickets with Terminal Interface Manager, define the PTKTDATA profile by following the rules for MVS batch jobs. For more information, see [Defining profiles in the PTKTDATA class in the z/OS documentation](#).

A panel similar to the following panel is then displayed on the second terminal session:

```
z/OS Debugger Terminal Interface
Manager
EQAY001I Terminal TRMLU001 connected for user USER1
EQAY001I Ready for z/OS Debugger

PF3=EXIT PF10=Edit LE options data set
PF12=LOGOFF
```

The terminal is now ready to receive a full-screen mode debugging session.

4. Edit the PARM string of your batch job so that you specify the TEST runtime parameter as follows:

```
TEST(,,,VTAM%userid:*)
```

5. Submit the batch job. The following tasks are done:
 - a. z/OS Debugger allocates a VTAM ACB (EQAMVnnn) for its end of a VTAM session.
 - b. z/OS Debugger communicates with the Terminal Interface Manager to request a session with the terminal LU on which it is running.
 - c. The Terminal Interface Manager releases the terminal LU and passes control of it to z/OS Debugger.
6. On the second terminal session, a full-screen mode debugging session is displayed. Interact with it the same way you would with any other full-screen mode debugging session.
7. After you exit z/OS Debugger, the second terminal session displays the panel and messages you saw in step “3” on page 17. This indicates that z/OS Debugger can use this session again. (This happens each time you exit z/OS Debugger.)
8. If you want to start another debugging session, return to step “5” on page 18. If you are finished debugging, you can do one of the following tasks:
 - Close the second terminal session.
 - Exit the Terminal Interface Manager by choosing one of the following options:
 - Press PF12 to display the Terminal Interface Manager logon panel. You can log in with the same ID or a different user ID.
 - Press PF3 to exit the Terminal Interface Manager.

This technique requires you to define and configure a number of items in the z/OS Communications Server. Section “[Enabling full-screen mode using the Terminal Interface Manager](#)” on page 19 describes these definitions and configuration.

Enabling full-screen mode using the Terminal Interface Manager

To enable full-screen mode using the Terminal Interface Manager, do the following steps:

1. Define the VTAM APPL definition statements that z/OS Debugger uses for its end of the session, as described in [“Defining the VTAM EQAMVnnn APPL definition statements”](#) on page 19.
2. Define the VTAM APPL definition statements that the Terminal Interface Manager uses, as described in [“Defining the Terminal Interface Manager APPL definition statements”](#) on page 20.
3. Start the Terminal Interface Manager, as described in [“Starting the Terminal Interface Manager”](#) on page 21.
4. Verify that full-screen mode using the Terminal Interface Manager is enabled, as described in [“Verifying the enablement of full-screen mode using the Terminal Interface Manager”](#) on page 22.

Defining the VTAM EQAMVnnn APPL definition statements

You must define the APPL definition statements that z/OS Debugger uses for its end of the VTAM session with the terminal LU. You can define up to 999 APPLs for z/OS Debugger. You can define an APPL by using one of the following naming conventions:

- Define each APPL with the following naming convention: the first five characters of the APPL name must be EQAMV and the last three characters must be consecutive three digit numbers, starting with 001. Do not code an ACBNAME operand on the APPL definition statements for this method.
- Define each APPL name with the naming convention you use at your site. Code an ACBNAME operand on the APPL definition statement that uses EQAMV as the first five characters, and three numeric digits (starting with 001) as the last three characters.

The number of APPL names you define must be sufficient to allow for the maximum number of concurrent z/OS Debugger full-screen mode using the Terminal Interface Manager sessions. (z/OS Debugger uses one of these APPL names for its end of each VTAM session that is initiated with a terminal LU.)

The descriptions and examples used in this book assume you defined APPL names by using the EQAMVnnn naming convention. z/OS Debugger uses the EQAMVnnn names for internal processing.

The EQAWAPPL member in the *hlq*.SEQASAMP data set predefines 50 APPL names, EQAMV001 to EQAMV050. You can do one of the following tasks to add this member to the VTAM definitions library (VTAMLST).

- Copy EQAWAPPL into a new member:
 1. Create a new member in the VTAM definitions library (VTAMLST). The VTAM definitions library is often stored in the data set SYS1.VTAMLST.
 2. Copy the contents of the EQAWAPPL member into the new member.
 3. Add the new member's name to the VTAM start options configuration file, ATCCONxx, so that VTAM activates the z/OS Debugger APPL definitions at initialization.
- Copy EQAWAPPL into an existing member that is already defined in VTAMLST:
 1. Select a member in the VTAM definitions library (VTAMLST) that contains the major node definitions.
 2. Copy the APPL definition statements for z/OS Debugger from the EQAWAPPL member into the selected member.

Tip: The existing member has the VBUILD TYPE=APPL statement, so do not copy this statement from EQAWAPPL.

If you are running VTAM in a multi-domain environment and you require the ability to debug full-screen mode using the Terminal Interface Manager on more than one host, edit the copy of EQAWAPPL on each system to make the names for z/OS Debugger major and minor nodes unique for each system.

For example, if you have hosts SYSA, SYSB, and SYSC, and need to provide definitions for up to 50 concurrent users debugging programs in full-screen mode using the Terminal Interface Manager on each system, you can code the following entries:

- SYSA VTAMLST EQAWAPPL entry:

```
EQAAPPLA VBUILD TYPE=APPL
EQAMV001 APPL AUTH=(PASS,ACQ),PARSESS=NO
EQAMV002 APPL AUTH=(PASS,ACQ),PARSESS=NO
...
EQAMV050 APPL AUTH=(PASS,ACQ),PARSESS=NO
```

- SYSB VTAMLST EQAWAPPL entry:

```
EQAAPPLB VBUILD TYPE=APPL
EQAMV051 APPL AUTH=(PASS,ACQ),PARSESS=NO
EQAMV052 APPL AUTH=(PASS,ACQ),PARSESS=NO
...
EQAMV100 APPL AUTH=(PASS,ACQ),PARSESS=NO
```

- SYSC VTAMLST EQAWAPPL entry:

```
EQAAPPLC VBUILD TYPE=APPL
EQAMV101 APPL AUTH=(PASS,ACQ),PARSESS=NO
EQAMV102 APPL AUTH=(PASS,ACQ),PARSESS=NO
...
EQAMV150 APPL AUTH=(PASS,ACQ),PARSESS=NO
```

You can have up to 999 unique APPL names for full-screen mode using the Terminal Interface Manager spread across your network. For an example on how to configure many APPL names in a network with multiple LPARs, see [“Example: Defining the VTAM EQAMVnnn and Terminal Interface Manager APPL definition statements when z/OS Debugger runs on four LPARs”](#) on page 23.

As an alternative to coding each minor node name, you can use the Model Application Names function. With this function, VTAM dynamically creates the minor nodes. Use one of the following ways (alter these examples, if needed, to maintain unique names per system as discussed in [“Defining the VTAM EQAMVnnn APPL definition statements”](#) on page 19):

- EQAMV??? APPL AUTH=(PASS,ACQ),PARSESS=NO
- ABCDE??? APPL AUTH=(PASS,ACQ),PARSESS=NO,ACBNAME=EQAMV???

Activating the VTAM EQAMVnnn APPLs

Activate the VTAM APPLs by entering the following command from the console, where *member-name* is the member name in the VTAM library (VTAMLST):

```
VARY NET,ACT,ID=member-name
```

Defining the Terminal Interface Manager APPL definition statements

You must define the APPL definition statements that the Terminal Interface Manager will use for its sessions. To define the APPL definition statements, do the following steps:

1. Define the APPL definition statements as shown in the EQAWSESS member in the *hlq.SEQASAMP* data set by doing one of the following tasks:
 - Copy EQAWSESS into a new member:
 - a. Create a new member in the VTAM definitions library (VTAMLST). The VTAM definitions library is often stored in the data set SYS1.VTAMLST.
 - b. Copy the contents of the EQAWSESS member into the new member.
 - c. Add the new member's name to the VTAM start options configuration file, ATCCONxxx.
 - Copy EQAWSESS into an existing member:
 - a. Select a member in the VTAM definitions library (VTAMLST) that contains the major node definitions.

- b. Copy the APPL definition statements for z/OS Debugger from the EQAWSESS member into the selected member.

To activate the new definitions, enter the following command from the console:

```
VARY NET,ACT,ID=member-name
```

member-name is the member name in the VTAM definitions library.

Starting the Terminal Interface Manager

The Terminal Interface Manager is a VTAM application that must be started (following the start of VTAM itself) before users can access it. Follow these steps to start it:

1. Copy the EQAYSESM member of the data set *hlq*.SEQASAMP to the SYS1.PROCLIB data set, making any changes required by your installation.
2. Make sure that the Terminal Interface Manager load modules, EQAYSESM and EQAYTRMM, reside in an APF authorized library (these module can be found in the *hlq*.SEQAAUTH data set). This is required to allow access to functions to validate users by login credentials.
3. Start the Terminal Interface Manager using the START command from the console. The START command can be added to the COMMNDxx member of SYS1.PARMLIB to start the Terminal Interface Manager when the system is IPLed.

The user ID associated with the STARTED class entry in RACF for the Terminal Interface Manager started task must have an OMVS segment defined. This enables the started task to use the POSIX thread functions.

The Terminal Interface Manager load module accepts six parameters, which you can provide by using the OPTS substitution variable on the START command or in the EQAYSESM PROC definition. You can code the parameters in any sequence and all of them are optional. The following list describes the parameters:

-a *acbname*

Specifies an alternate VTAM ACB name for the Terminal Interface Manager to open. For more information about this parameter, see [“Example: Defining the VTAM EQAMVnnn and Terminal Interface Manager APPL definition statements when z/OS Debugger runs on four LPARs” on page 23.](#)

-m

Instructs the Terminal Interface Manager not to fold passwords to upper case. If your security product is set up to use mixed-case passwords, and Terminal Interface Manager does not accept them, code this parameter.

-p *pattern-string*

Specifies a naming pattern for the TEST runtime options data set. You can use this parameter to override the default naming pattern. *pattern-string* must contain the string &USERID for substitution purposes. Otherwise, an error will be recognized and the default naming pattern &USERID.DBGTOOL.EQAUOPTS will be used.

-s

Instructs the Terminal Interface Manager to provide an entry field on each Terminal Interface Manager panel, in which the user can enter a session manager escape sequence.

+T

Display detailed trace messages for the Terminal Interface Manager. Do not use this parameter unless instructed by IBM support personnel.

-r

Start Terminal Interface Manager in repository mode. This enables users to register to debug IMS transactions or DB/2 stored procedures that are started by a generic user ID.

See [“DLAYDBGXRF” on page 149](#) for additional customization required when using this option.

The following example starts the Terminal Interface Manager for alternate ACB EQASESS2 and instructs it to provide an extra entry field for use with a session manager:

```
START EQAYSESM,OPTS='-a EQASESS2 -s'
```

Using the MODIFY operator command to display a list of Terminal Interface Manager users

Console operators can list the users who are currently logged on to the Terminal Interface Manager by using the z/OS MVS system MODIFY command. The list of users contains the user ID, the terminal LU that each user requests, and the job information if the user is currently in a z/OS Debugger session.

The syntax of the MODIFY command is:

```
►► MODIFY — tim-stc-name — , — APPL=LIST —
```

```
┌── ALL ──┐
├── SESS ─┘
└── IMS ─┘
```

The following list describes the parameters of the MODIFY APPL=LIST command:

tim-stc-name

Is the name of the started task or job that is running the Terminal Interface Manager.

ALL

Lists all users who are logged on to the Terminal Interface Manager.

SESS

Only lists users who are logged on to the Terminal Interface Manager and are currently in a z/OS Debugger session.

IMS

Only lists users who are logged on to the Terminal Interface Manager and are currently in a z/OS Debugger session for an IMS message processing program.

Example

```
MODIFY EQAYSESM,APPL=LIST ALL
```

Example output

```
EQA9896I z/OS Debugger TIM USERS
  USER ID   FLAGS   TERMINAL  JOBNAME
  -----
  USRT002   I         TRMLU006  MPRCI10X
  USRT001   B         T1302     USRT001A
  USRT003   L         TRMLU004  **NONE**
  -----
L=LOGGED ON, NOT IN SESSION
I=IN SESSION; IMS JOB
B=IN SESSION; BATCH OR DB/2 JOB
```

Verifying the enablement of full-screen mode using the Terminal Interface Manager

To help you verify the enablement of full-screen mode using the Terminal Interface Manager, do the following steps:

1. Select which of the following installation verification jobs you want to run:
 - EQAWIVP5 (COBOL)
 - EQAWIVP6 (C)
 - EQAWIVP7 (PL/I)

- EQAWIVP9 (Enterprise PL/I)
 - EQAWIVPB (Language Environment assembler)
 - EQAWIVPD (non-Language Environment assembler)
 - EQAWIVPK (LangX Enterprise COBOL)
 - EQAWIVPW (OS/VS COBOL)
 - EQAWIVPY (non-Language Environment VS COBOL II)
2. Copy the job from the *hlq*.SEQASAMP data set to your own private data set and customize it for your installation as described in the sample.
 3. Connect a terminal session to the Terminal Interface Manager and log on to the Terminal Interface Manager with your TSO user ID.
 4. Run the customized installation verification jobs.

Example: Defining the VTAM EQAMVnnn and Terminal Interface Manager APPL definition statements when z/OS Debugger runs on four LPARs

The instructions in Chapter 6, “Enabling debugging in full-screen mode using the Terminal Interface Manager,” on page 17 assume that you create all the definitions and start the Terminal Interface Manager on one LPAR. This example describes the connections that need to be made in a VTAM network that has four LPARs that run z/OS Debugger jobs with one of the LPARs managing the terminals.

- LPAR 1 runs a TN3270E server and the Terminal Interface Manager with the default ACB name. Its VTAM also owns all the terminal LUs. Users connect their TN3270E emulator to this LPAR for the Terminal Interface Manager session. Users use the Terminal Interface Manager to create the connection between z/OS Debugger and the terminal LU used for their full-screen mode using the Terminal Interface Manager debugging session.
- VTAM on LPAR 1 defines the terminal LU APPL definition statements and the EQASESSM APPL definition statement for the Terminal Interface Manager.
- VTAM on LPAR 1 needs visibility to the EQAMVnnn APPL definition statements on LPARs 2, 3 and 4. This enables communication between the Terminal Interface Manager and z/OS Debugger.
- Each VTAM on LPAR 1, 2, 3 and 4 has a unique set of EQAMVnnn APPL definition statements. For example, LPAR 1 has APPL definition statements 001-050, LPAR 2 has APPL definition statements 051-100, LPAR 3 has APPL definition statements 101-150, and LPAR 4 has APPL definition statements 151-200.
- Each VTAM on LPAR 2, 3 and 4 needs visibility to the EQASESSM APPL definition statement on LPAR 1. This enables communication between z/OS Debugger and the Terminal Interface Manager.
- Each VTAM on LPAR 2, 3 and 4 needs visibility to the terminal LU APPL definition statements on LPAR 1.

Chapter 7. Adding support for remote debug users

If you have users running z/OS Debugger in remote debug mode, review the following list and complete the applicable tasks:

- If your TCP/IP stack name is not TCPIP, you can use the TCPIP DATASN EQAOPTS command to instruct z/OS Debugger to dynamically allocate the correct SYSTCPD DD.
- If the source or compiler uses a code page other than 037, see [“CODEPAGE” on page 144](#).
- If you want z/OS Debugger to switch to full-screen mode or batch mode if the remote debugger is not available, see [“NODISPLAY” on page 160](#).
- For your CICS users, see [“Activating the TCP/IP Socket Interface for CICS” on page 25](#).
- With Debug Manager, remote Eclipse users do not need to open an outgoing port for the debug daemon on the z/OS system, or supply an IP address and port for debugging. For the differences between using Debug Manager and Debug Daemon port 8001, see [“TCP/IP ports” on page 38](#). For more information, see [“Enabling communication with Debug Manager” on page 26](#) and [“Understanding Debug Manager” on page 30](#).
- To enable interactive debugging in IBM Z Open Debug, see [“Adding support for Remote Debug Service” on page 45](#).
- If your users create and manage debug profiles in the **z/OS Debugger Profiles** view with Eclipse or **Z Open Debug Profiles** view with IBM Z Open Debug, see [“Adding support for the DTCN profiles APIs and views” on page 53](#) for your CICS users and [“Adding support for Debug Profile Service and APIs” on page 48](#) to enable all the features in this view for best user experience.
- For users that install the Debug Tool DTCN and DTSP Profile Manager plug-ins to the remote Eclipse debugger, do the following tasks:
 - If users want to use the DTCN Profiles view, see [“Adding support for the DTCN profiles APIs and views” on page 53](#).
 - If users want to use the DTSP Profiles, code coverage, and load module analyzer views, see [“Adding support for the DTSP Profile, code coverage, and load module analyzer views” on page 57](#).

Notes:

- Review the introduction to "Appendix K. Using the IBM Debug Tool plug-ins" in the *IBM z/OS Debugger User's Guide* before you do any customization for the Debug Tool plug-ins. The same functionality, in general, is now available in the remote IDE with other methods. The Debug Tool plug-ins are not available in IBM Wazi Developer for Red Hat CodeReady Workspaces.
- All the Debug Tool plug-ins are deprecated and will be removed in a future release.
 - The DTCN and DTSP views are replaced by the **z/OS Debugger Profiles** view.
 - The Debug Tool Code Coverage views are replaced by the **Code Coverage Results** view.
- To enable secure communication for incoming debug and code coverage sessions in the remote Eclipse IDE, see [“Enabling secure communication between z/OS Debugger and the remote debugger for incoming debug sessions” on page 58](#).

Refer to the following topics for more information related to the material discussed in this topic.

Related references

"Remote debug mode" in the *IBM z/OS Debugger User's Guide*

Activating the TCP/IP Socket Interface for CICS

You need to activate the appropriate TCP/IP socket interface to manage communication between your CICS region and the remote debugger. z/OS Debugger supports only the TCP/IP Socket Interface for CICS.

Activate the TCP/IP Socket Interface for CICS to enable the following functions:

- Communication between your CICS region and the remote debugger.
- Use of the IPv6 protocol in remote debug mode.

For instructions on activating the TCP/IP Socket Interface for CICS, see the *z/OS Communications Server IP CICS Sockets Guide*.

Enabling communication with Debug Manager

Debug Manager (DBGMGR) provides communication-related services to z/OS Debugger and the remote Eclipse client.

To use Debug Manager, apart from the host debugger, you also need to install the following components or products:

- IBM z/OS Explorer host.
- An Eclipse client of the following products:
 - IBM Debug for z/OS
 - IBM Developer for z/OS
 - IBM Wazi Developer for Red Hat CodeReady Workspaces

Specifically, if the DBM or DBMDT TEST runtime parameters are used, Debug Manager is used with z/OS Explorer's Remote System Explorer daemon (RSED) to allow z/OS Debugger to resolve the client's workstation address.

This chapter describes how to set up the Debug Manager's started task, encryption, and security definitions.

To learn more about Debug Manager, see [“Understanding Debug Manager” on page 30](#). For the differences between using Debug Manager and Debug Daemon port 8001, see [“TCP/IP ports” on page 38](#).

Debug Manager configuration

PARMLIB changes

Adding the started task to COMMNDxx

Add a start command for the Debug Manager server to SYS1.PARMLIB(COMMNDxx) to start it automatically at the next system IPL. Define CMD=xx in the IEASYSxx parmlib member to specify the COMMNDxx parmlib member that is used during IPL.

After the server is defined and configured, it can be started dynamically (until the next IPL) with the following console command:

```
S DBGMGR
```

Note: There is no specific startup order for the server. The only requirement is that the server is up and running before the first user tries to connect. Note that the Debug Manager server depends on the z/OS Explorer's Remote System Explorer daemon server (RSED) to also be running.

APF authorization in PROGxx

For Debug Manager to work, the modules in the EQAW.SEQAAUTH load library must be APF-authorized.

APF authorizations are defined in SYS1.PARMLIB(PROGxx) by default. Define PROG=xx in the IEASYSxx parmlib member to specify the PROGxx parmlib member that is used during IPL.

APF authorization can be set dynamically (until the next IPL) with the following console command, where volser is the volume on which the data set resides if it is not SMS-managed:

- SETPROG APF,ADD,DSN=EQAW.SEQAAUTH,SMS
- SETPROG APF,ADD,DSN=EQAW.SEQAAUTH,VOL=volser

Note: Some of the prerequisite and co-requisite products, such as z/OS Explorer, also require APF authorization. For more information, see the related product customization guides.

Adding the Debug Manager started task to the system PROCLIB

Customize the EQAW.SEQASAMP (EQAZPCM) sample started task member, as described within the member, and copy it to SYS1.PROCLIB as member DBGMGR. As shown in the following code sample, provide the following information:

- The time-zone offset, default EST5DST
- The port used for external (client-host) communication, default 5335
- The port used for internal (host-confined) communication, default 5336
- The high-level qualifier of the load library, default EQAW

```

/*
/* z/OS Debugger Debug Manager
/*
//DBGMGR  PROC PRM=,                * PRM=DEBUG TO START TRACING
//          LEPRM='RPTOPTS(ON)',
//          TZ='EST5EDT',
//          CLIENT=5335,
//          HOST=5336,
//          HLQ=EQAW
/*
//DBGMGR  EXEC PGM=EQAZPCM,REGION=0M,TIME=NOLIMIT,
//          PARM=('&LEPRM ENVAR("TZ=&TZ")/&HOST &CLIENT &PRM')
//STEPLIB DD DISP=SHR,DSN=&HLQ..SEQAAUTH
//SYSPRINT DD SYSOUT=*
//SYSOUT  DD SYSOUT=*
//          PEND
/*

```

Figure 1. DBGMGR: Debug Manager started task

Note:

- This is an optional started task. It is used by z/OS Debugger if the DBM or DBMDT TEST runtime parm is used.
- For the recommended Workload Manager (WLM) goals for this task, see [“WLM considerations” on page 40](#).

Network configuration

Debug Manager TCP/IP updates

The Debug Manager uses 2 TCP/IP ports.

- Port for client-host communication (default 5335). Communication on this port can be encrypted.
- Port for host-confined communication (default 5336).

Encrypted communication

If the debug client uses encryption to communicate with the Remote System Explorer (RSE) daemon, by default, the client also uses encryption to communicate with the host-based Debug Manager.

The following table shows whether a debug session can be started successfully with encrypted communication disabled or enabled for RSE and Debug Manager.

Table 6. Encrypted communication combinations for RSE and Debug Manager

	DBGMGR encrypted communication enabled¹	DBGMGR encrypted communication disabled
RSE encrypted communication enabled	The debug session starts in secured mode. ²	Ask the user to confirm unsecured connection and then proceed as normal.
RSE encrypted communication disabled	The debug session cannot be started.	The debug session starts in unsecured mode.

Notes:

1. Unlike RSE daemon, Debug Manager does not have native support for encrypted communication. To enable encryption, [create an AT-TLS policy for the port used by Debug Manager](#).
2. Users can start debug sessions without prompts only when the same certificates as RSE, or different chained certificates of the same CA root are used for Debug Manager. Certificates of different CA roots are considered as untrusted, and users need to take actions before they establish debug connection.

Creating an AT-TLS policy for the port used by Debug Manager

The Debug Manager relies on a TCP/IP service called Application Transparent Transport Layer Security (AT-TLS) for encrypted communication. For a step-by-step setup guide, see [“Setting up AT-TLS” on page 31](#).

To enable encryption, create an AT-TLS policy for the port used by Debug Manager for external communication, by default 5335. See the following sample policy.

```

TTLSSRule                zOS_Debugger_Debug_Manager
{
  LocalPortRange         5335
  Direction               Inbound
  TTLSSGroupActionRef    grp_Production
  TLSEnvironmentActionRef act_zOS_Debugger_Debug_Manager
}
TLSEnvironmentAction     act_zOS_Debugger_Debug_Manager
{
  HandshakeRole          Server
  TLSKeyRingParms
  {
    Keyring dbgmgr.racf    # Keyring must be owned by the Debug Manager
  }
}
TTLSSGroupAction         grp_Production
{
  TLSEnabled              On
  Trace                   2
}

```

Debug Manager security definitions

The following list is an overview of the actions that are required to complete the basic security setup of Debug Manager. As documented in the following sections, different methods can be used to fulfill these requirements, depending on the required security level.

For more information about the sample RACF commands, see *RACF Command Language Reference (SA22-7687)*.

Activating the security settings and classes

Debug Manager uses a variety of security mechanisms to ensure a secure and controlled host system environment for the client. To do so, several classes and security settings must be active, as shown with the following sample RACF commands:

- Display current settings

- SETROPTS LIST
- Activate facility class for Debug Manager
 - SETROPTS GENERIC(FACILITY)
 - SETROPTS CLASSACT(FACILITY) RACLIST(FACILITY)
- Activate started task definitions for Debug Manager
 - SETROPTS GENERIC(STARTED)
 - RDEFINE STARTED ** STDATA(USER(=MEMBER) GROUP(STCGROUP) TRACE(YES))
 - SETROPTS CLASSACT(STARTED) RACLIST(STARTED)

Defining the Debug Manager started task

The following sample RACF commands create the DBGMGR started task, with protected user ID (STCDBM) and the STCGROUP group assigned to it.

- ```
ADDGROUP STCGROUP OMVS(AUTOGID)
 DATA('GROUP WITH OMVS SEGMENT FOR STARTED TASKS')
```
- ```
ADDUSER STCDBM DFLTGRP(STCGROUP) NOPASSWORD NAME('DEBUG MANAGER')
  OMVS(AUTOUID HOME(/tmp) PROGRAM(/bin/sh) )
  DATA('IBM z/OS Debugger')
```
- ```
RDEFINE STARTED DBGMGR.* DATA('DEBUG MANAGER')
 STDATA(USER(STCDBM) GROUP(STCGROUP) TRUSTED(NO))
```
- ```
SETROPTS RACLIST(STARTED) REFRESH
```

Note:

- Ensure that the started task user ID is protected by specifying the NOPASSWORD keyword.
- The Debug Manager started task (DBGMGR) is used only by z/OS Debugger when the DBM or DBMDT TEST runtime parm is used.

Defining Debug Manager as a secure z/OS UNIX server

Debug Manager requires UPDATE access to the BPX.SERVER profile to create or delete the security environment for the debug thread.

Note: Using UID(0) to bypass this requirement is not supported.

This permit is required only when the Debug Manager feature is used.

- ```
RDEFINE FACILITY BPX.SERVER UACC(NONE)
```
- ```
PERMIT BPX.SERVER CLASS(FACILITY) ACCESS(UPDATE) ID(STCDBM)
```
- ```
SETROPTS RACLIST(FACILITY) REFRESH
```



**Attention:** Defining the BPX.SERVER profile makes z/OS UNIX as a whole switch from UNIX level security to z/OS UNIX level security, which is more secure. This switch might impact other z/OS UNIX applications and operations. Test the security before activating it on a production system. For more information about the different security levels, see *UNIX System Services Planning* (GA22-7800).

### **Defining the MVS program controlled libraries for Debug Manager**

Servers with authority to BPX.SERVER must run in a clean, program-controlled environment. This requirement implies that all programs called by Debug Manager must also be program controlled. For MVS load libraries, program control is managed by your security software.

Debug Manager uses system libraries, Language Environment's runtime, and the z/OS Debugger (EQAW.SEQAAUTH) load library.

- RALTER PROGRAM \*\* UACC(READ) ADDMEM('SYS1.LINKLIB' //NOPADCHK)
- RALTER PROGRAM \*\* UACC(READ) ADDMEM('SYS1.CSSLIB' //NOPADCHK)
- RALTER PROGRAM \*\* UACC(READ) ADDMEM('CEE.SCEERUN' //NOPADCHK)
- RALTER PROGRAM \*\* UACC(READ) ADDMEM('CEE.SCEERUN2' //NOPADCHK)
- RALTER PROGRAM \*\* UACC(READ) ADDMEM('EQAW.SEQAAUTH' //NOPADCHK)
- SETROPTS WHEN(PROGRAM) REFRESH

**Note:** Do not use the \*\* profile if you already have a \* profile in the PROGRAM class. The profile obscures and complicates the search path used by your security software. In this case, you must merge the existing \* and the new \*\* definitions. Use the \*\* profile, as documented in *Security Server RACF Security Administrator's Guide* (SA22-7683).

### Verifying the security settings

- Security setting and classes
  - SETROPTS LIST
- Started tasks
  - LISTGRP STCGROUP OMVS
  - LISTUSER STCDBM OMVS
  - RLIST STARTED DBGMGR.\* ALL STDATA
- Debug Manager as a secure z/OS UNIX server
  - RLIST FACILITY BPX.SERVER ALL
- MVS program controlled libraries for Debug Manager
  - RLIST PROGRAM \*\* ALL

### Verifying the DBGMGR started task

Start the DBGMGR started task or user job. The server issues the following console message upon successful startup, where `clientport` is the number of the port used for external (client-host) communication, and `hostport` is the port number used for internal (host-confined) communication.

```
EQACM001I Debug Manager startup complete (clientport/hostport)
```

If the job ends with return code 66, then EQAW.SEQAAUTH is not APF-authorized.

### Running the installation verification programs for Debug Manager

The following installation verification programs are available for Debug Manager:

- Batch. For more information, see [“Running the installation verification programs for SVCs” on page 10](#).
- CICS. For more information, see [“Running the installation verification programs in a CICS region” on page 102](#).

## Debug Manager configuration reference

### Understanding Debug Manager

Debug Manager provides communication-related services to z/OS Debugger and the remote Eclipse IDE. It circumvents the need to open outbound ports from z/OS and for users to track their IP address. For

differences between usages with and without Debug Manager, see the figures in [“TCP/IP ports”](#) on page 38.

Figure 2 on page 31 shows a schematic overview of how an Eclipse client uses Debug Manager when you debug an application.

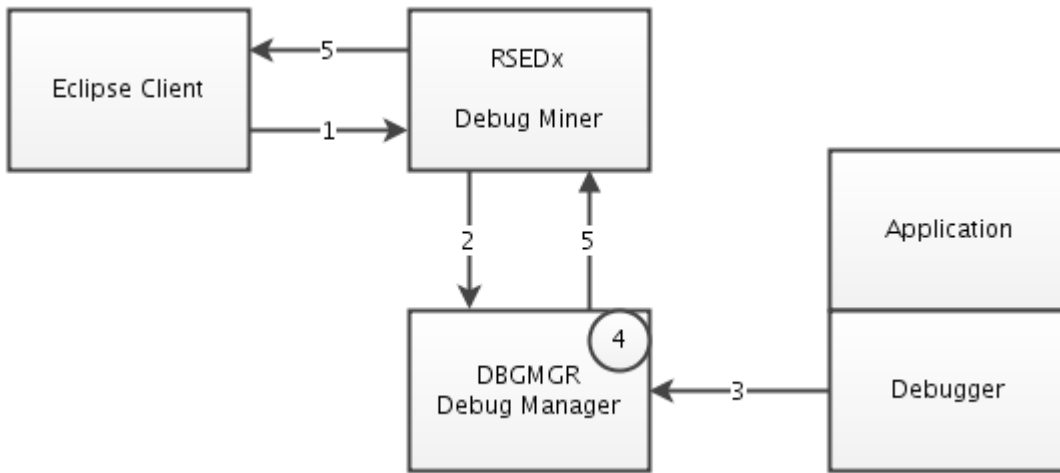

Figure 2. Debug Manager

1. The client connects to the host by using a z/OS connection in the **Remote Systems** view.
2. As part of the logon, Debug Miner registers the user with Debug Manager, which is active within the DBGMGR started task.
3. When the program to be debugged starts, z/OS Debugger sends the debug request to Debug Manager.
4. Debug Manager checks whether the debug session user is registered. If the user is not registered at this moment, the debug session goes dormant. z/OS Debugger will wait up to 300 seconds in standard mode, and up to two times of *\$VALUE* in Debug Tool compatibility mode. If the user still has not signed on to the z/OS connection in the **Remote Systems** view and is not registered with Debug Manager, the debug session will time out.
5. If the user is registered, Debug Manager routes the initial debug request back to the Eclipse client using Debug Manager. The remote debug session is then started in the Eclipse client.

For more information about TCPIP/DIRECT and DBM/DBMDT options and the *user\_id* option for DBM/DBMDT, see "Syntax of the TEST runtime option" in *IBM z/OS Debugger Reference and Messages*.

## Setting up AT-TLS

This section is provided to assist you with some common problems that you might encounter when setting up Application Transparent Transport Layer Security (AT-TLS), or during checking or modifying an existing setup.

The Transport Layer Security (TLS) protocol defined in RFC 2246 provides communications privacy over the internet. Similar to its predecessor Secure Socket Layer (SSL), the protocol enables client and server applications to communicate in a way that is designed to prevent eavesdropping, tampering, and message forgery. Application Transparent Transport Layer Security (AT-TLS) consolidates TLS implementation for z/OS-based applications in one location, allowing all applications to support TLS-based encryption without knowledge of the TLS protocol. For more information on AT-TLS, See *Communications Server IP Configuration Guide* (SC31-8775).

The information in this section shows how to set up the TCP/IP Policy Agent that manages AT-TLS and define a policy for usage by DBGMGR on a z/OS 1.13 system, with support for TLS v1.2.

1. [“Setting up syslogd”](#) on page 32
2. [“AT-TLS configuration in PROFILE.TCPIP”](#) on page 32
3. [“Policy Agent started task”](#) on page 33
4. [“Policy Agent configuration”](#) on page 33

5. [“AT-TLS policy” on page 33](#)
6. [“AT-TLS security updates” on page 35](#)
7. [“AT-TLS policy activation” on page 37](#)

Throughout this section, a uniform naming convention is used:

- Debug Manager port for external communication: 5335
- Debug Manager user ID: stcdbm
- Policy agent user ID: pagent
- Certificate: dbgmgr
- Key and certificate storage: dbgmgr.racf

Some tasks described in the following sections expect you to be active in z/OS UNIX. This can be done by issuing the TSO command **OMVS**. Use the **oedit** command to edit files in z/OS UNIX. Use the **exit** command to return to TSO.

### Setting up syslogd

The TCP/IP documentation recommends writing Policy Agent messages to the z/OS UNIX syslog instead of using the default log file. AT-TLS always writes messages to the z/OS UNIX syslog.

In order to do so, the z/OS UNIX syslog daemon, `syslogd`, must be configured and active. You also need a mechanism to control the size of the log files created by `syslogd`.

The following sample configuration file updates can be used to configure and start `syslogd`, with a simple log file management mechanism (erase existing logs when z/OS UNIX starts and create new ones upon `syslogd` startup).

- `/etc/services`

```
syslog 514/udp
```

- `/etc/syslog.conf`

```
/etc/syslog.conf - control output of syslogd
1. all files with will be printed to /tmp/syslog.auth.log
auth.* /tmp/syslog.auth.log
2. all error messages printed to /tmp/syslog.error.log
*.err /tmp/syslog.error.log
3. all debug and above messages printed to /tmp/syslog.debug.log
*.debug /tmp/syslog.debug.log
The files named must exist before the syslog daemon is started,
unless -c startup option is used
```

- `/etc/rc`

```
Start the SYSLOGD daemon for logging
(clean up old logs)
sed -n '/^#!s/. * \(.*)/1/p' /etc/syslog.conf | xargs -i rm {}
(create new logs and add userid of message sender)
_BPX_JOBNAME='SYSLOGD' /usr/sbin/syslogd -cuf /etc/syslog.conf &
sleep 5
```

### AT-TLS configuration in PROFILE.TCPIP

AT-TLS support is activated by the TTLS parameter on the TCPCONFIG statement in the PROFILE.TCPIP data set. AT-TLS is managed by the Policy Agent, which must be active to be able to enforce the AT-TLS policy. Since the Policy Agent must wait for TCP/IP to be active, the AUTOSTART statement in PROFILE.TCPIP is a good place to trigger startup of this server.

These requirements result in the following changes to PROFILE.TCPIP, often named TCPIP.TCPPARMS(TCPPROF).

```
TCPCONFIG TTLS ; Required for AT-TLS
AUTOLOG
```

```
PAGENT ; POLICY AGENT, required for AT-TLS
ENDAUTOLOG
```

## Policy Agent started task

As mentioned in the previous text, AT-TLS is managed by the Policy Agent, which can be started as a started task. Use the following JCL to create SYS1.PROCLIB(PAGENT), using the default configuration file and the recommended log location (SYSLOGD). The necessary definitions in your security software are covered later.

```
//PAGENT PROC PRM='-L SYSLOGD' * '' or '-L SYSLOGD'
//*
//* TCP/IP POLICY AGENT
//* (PARM) (envar)
//* default cfg file: /etc/pagent.conf (-C) (PAGENT_CONFIG_FILE)
//* default log file: /tmp/pagent.log (-L) (PAGENT_LOG_FILE)
//* default log size: 300,3 (3x 300KB files) (PAGENT_LOG_FILE_CONTROL)
//*
//PAGENT EXEC PGM=PAGENT,REGION=0M,TIME=NOLIMIT,
// PARM='ENVAR("TZ=EST5DST")&PRM'
//SYSPRINT DD SYSOUT=*
//SYSOUT DD SYSOUT=*
//*
```

## Policy Agent configuration

The Policy Agent enforces TCP/IP related policies created by the TCP/IP administrator. It manages policies for AT-TLS, called TTLS, but also for other services such as IPSec. The Policy Agent uses a configuration file to know which policies must be enforced, and where they can be found. The default configuration file is /etc/pagent.conf, but a different location can be specified in the Policy Agent started task JCL.

```
#
TCP/IP Policy Agent configuration information.
#
TTLSConfig /etc/pagent.ttls.conf
Specifies the path of a TTLS policy file holding stack specific
statements.
#
#TcpImage TCPIP /etc/pagent.conf
If no TcpImage statement is specified, all policies will be installed
to the default TCP/IP stack.
#
#LogLevel 31
The sum of the following values that represent log levels:
LOGL_SYSERR 1
LOGL_OBJERR 2
LOGL_PROTERR 4
LOGL_WARNING 8
LOGL_EVENT 16
LOGL_ACTION 32
LOGL_INFO 64
LOGL_ACNTING 128
LOGL_TRACE 256
Log Level 31 is the default log loglevel.
#
#Codepage IBM-1047
Specify the EBCDIC code page to be used for reading all configuration
files and policy definition files. IBM-1047 is the default code page.
```

This sample configuration file specifies where the Policy Agent can find the TTLS policy. It uses Policy Agent default values for other statements.

## AT-TLS policy

A TTLS policy describes the desired AT-TLS rules. As defined in the Policy Agent configuration file, the TTLS policy is located in /etc/pagent.ttls.conf. The necessary definitions in your security software are covered later.

This example shows a fairly simple, two-rule policy that disables SSL v3 and enables TLS v1, TLS v1.1, and TLS v1.2 support for both communication paths supported by the z/OS RSE connection, Debug

Manager, and Probe-Client. As defined in the Policy Agent configuration file, the TTLS policy is located in `/etc/pagent.ttls.conf`.

```
###
TCP/IP Policy Agent AT-TLS configuration information.
###
###-----
TTLSRule zOS_Debugger_Debug_Manager
{
 LocalPortRange 5335
 Direction Inbound
 TTLSGroupActionRef grp_Production
 TTLSEnvironmentActionRef act_zOS_Debugger_Debug_Manager
}
###-----
TTLSEnvironmentAction act_zOS_Debugger_Debug_Manager
{
 HandshakeRole Server
 TTLSKeyRingParms
 {
 Keyring dbgmgr.racf # Keyring must be owned by the Debug Manager
 }
 TTLSEnvironmentAdvancedParms
 {
 ApplicationControlled Off
 }
 ### TLSv1.2 only for z/OS 2.1 and higher
 # TLSV1.2 On # TLSv1 & TLSv1.1 are on by default
 SSLV3 Off # disable SSLv3
}
###-----
TTLSGroupAction grp_Production
{
 TTLSEnabled On
 ### TLSv1.2zOS1.13 only for z/OS 1.13
 TTLSGroupAdvancedParmsRef TLSv1.2zOS1.13
 Trace 3 # Log Errors to syslogd & IP joblog
#Trace 254 # Log everything to syslogd
}
###-----
TTLSGroupAdvancedParms TLSv1.2zOS1.13
{
 Envfile /etc/pagent.ttls.TLS1.2zOS1.13.env
}
}
```

A TTLS policy allows for a wide range of filters to specify when a rule applies.

Debug Manager is a server that listens on port 5335 for incoming connections from Debug Engine. This information is captured in the `zOS_Debugger_Debug_Manager` rule.

Since encrypted communication requires the usage of a server certificate, you specify that the Policy Manager must use the certificates on the `dbgmgr.racf` key ring, which is owned by the Debug Manager started task user ID. By default, TLS v1.2 support is disabled, so this policy explicitly enables it. SSLv3.0 is explicitly disabled due to known vulnerabilities in this protocol.

With the host being a TCP/IP client, the Policy Manager will need a way to validate the server certificate presented by the Debug UI. Instead of using a uniformly named key ring for all users that might require an encrypted debug session, we are using RACF's CERTAUTH virtual key ring (`*AUTH*/*`). This virtual key ring holds the public certificates of Certificate Authorities (CAs), and can be used if the Debug UI presents a server certificate that is signed by one of the trusted CAs.

**Note:** For more complex policies, you should use the IBM Configuration Assistant for z/OS Communications Server. This is a GUI-based tool that provides a guided interface for configuring TCP/IP policy-based networking functions and is available as a task in IBM z/OS Management Facility (z/OSMF), and as a stand-alone workstation application.

#### *TLS v1.2 considerations*

TLS v1.2 support became available in z/OS 2.1, and is disabled by default. This policy shows the command (`TLSV1.2 On`) to explicitly enable it, but has it commented out as the target system is using z/OS 1.13.

By applying the following two APARs, TLS v1.2 support is added to z/OS 1.13:

- System SSL APAR OA39422
- Communications Server (AT-TLS) APAR PM62905

z/OS 1.13 System SSL, which is used by AT-TLS to implement TLS encrypted communication, requires some additional parameters for TLS v1.2 support. These are supplied through the AT-TLS policy using a file with System SSL environment variables, /etc/pagent.ttls.TLS1.2zOS1.13.env.

```
#
Add TLSv1.2 support to AT-TLS
requires z/OS 1.13 with OA39422 and PM62905
#
GSK_RENEGOTIATION=ALL
GSK_PROTOCOL_TLSV1_2=ON
```

## AT-TLS security updates

There are several updates required to your security setup for AT-TLS to work properly. This section has sample RACF commands to do the required setup.

As mentioned in “Policy Agent started task” on page 33, you use a started task to run the Policy Agent. This requires the definition of a started task user ID and a profile in the STARTED class.

```
define started task user ID
BPX.DAEMON permit is required for non-zero UID
ADDUSER PAGENT DFLTGRP(SYS1) OMVS(UID(0) SHARED HOME('/')) +
 NAME('TCP/IP POLICY AGENT') NOPASSWORD

define started task
RDEFINE STARTED PAGENT.* STDATA(USER(PAGENT) GROUP(SYS1)) +
 DATA('TCP/IP POLICY AGENT')

refresh to make the changes visible
SETROPTS RACLIST(STARTED) REFRESH
```

Define a profile named MVS.SERVMMGR.PAGENT in the OPERCMDS class and give user ID PAGENT CONTROL access to it. The profile restricts who can start the Policy Agent. If the profile is not defined, and access to it is prevented through a generic profile, PAGENT will not be able to start the Policy Agent, which will prevent TCP/IP stack initialization.

```
restrict startup of policy agent
RDEFINE OPERCMDS MVS.SERVMMGR.PAGENT UACC(NONE) +
 DATA('restrict startup of policy agent')
PERMIT MVS.SERVMMGR.PAGENT CLASS(OPERCMDS) ACCESS(CONTROL) ID(PAGENT)

refresh to make the changes visible
SETROPTS RACLIST(OPERCMDS) REFRESH
```

As mentioned in “AT-TLS configuration in PROFILE.TCPIP” on page 32, the Policy Agent is started after TCP/IP is initialized. This means there is a (small) window where applications can use the TCP/IP stack without the TTLS policy being enforced. Define the EZB.INITSTACK.\*\* profile in the SERVAUTH class to prevent access to the stack during this time window, except for applications with READ access to the profile. You must permit a limited set of administrative applications to the profile to ensure full initialization of the stack, as documented in “TCP/IP stack initialization access control” in *Communications Server IP Configuration Guide (SC31-8775)*.

**Note:** The Policy Agent issues message EZD1586I when all policies are active.

```
block stack access between stack and AT-TLS availability
SETROPTS GENERIC(SERVAUTH)
SETROPTS CLASSACT(SERVAUTH) RACLIST(SERVAUTH)
RDEFINE SERVAUTH EZB.INITSTACK.** UACC(NONE)
Policy Agent
PERMIT EZB.INITSTACK.** CLASS(SERVAUTH) ACCESS(READ) ID(PAGENT)
OMROUTE daemon
PERMIT EZB.INITSTACK.** CLASS(SERVAUTH) ACCESS(READ) ID(OMROUTE)
SNMP agent and subagents
PERMIT EZB.INITSTACK.** CLASS(SERVAUTH) ACCESS(READ) ID(OSNMPPD)
PERMIT EZB.INITSTACK.** CLASS(SERVAUTH) ACCESS(READ) ID(IOBSNMP)
NAME daemon
PERMIT EZB.INITSTACK.** CLASS(SERVAUTH) ACCESS(READ) ID(NAMED)
```

```
refresh to make the changes visible
SETROPTS RACLIST(SERVAUTH) REFRESH
```

(Optional) The z/OS UNIX **pasearch** command displays active policy definitions. Define profile EZB.PAGENT.\*\* in the SERVAUTH class to restrict access to the **pasearch** command.

```
restrict access to pasearch command
RDEFINE SERVAUTH EZB.PAGENT.** UACC(NONE) +
DATA('restrict access to pasearch command')
PERMIT EZB.PAGENT.** CLASS(SERVAUTH) ACCESS(READ) ID(tcpadmin)

refresh to make the changes visible
SETROPTS RACLIST(SERVAUTH) REFRESH
```

As mentioned in [“AT-TLS policy”](#) on page 33, Debug Manger needs a certificate so that AT-TLS can set up encrypted communication on Debug Manager’s behalf. These sample commands create a new certificate labeled `dbgmgr`, which is stored in a RACF key ring named `dbgmgr.racf`. Both the certificate and the key ring are owned by STCDBM, the Debug Manager started task user ID.

```
permit Debug Manager to access certificates
#RDEFINE FACILITY IRR.DIGTCERT.LIST UACC(NONE)
#RDEFINE FACILITY IRR.DIGTCERT.LISTRING UACC(NONE)
PERMIT IRR.DIGTCERT.LIST CLASS(FACILITY) ACCESS(READ) ID(stcdbm)
PERMIT IRR.DIGTCERT.LISTRING CLASS(FACILITY) ACCESS(READ) ID(stcdbm)

refresh to make the changes visible
SETROPTS RACLIST(FACILITY) REFRESH

create self-signed certificate
RACDCERT ID(stcdbm) GENCERT SUBJECTSDN(CN('Debug Manager') +
OU('RTP labs') O('IBM') L('Raleigh') SP('NC') C('US')) +
NOTAFTER(2015-12-31)) KEYUSAGE(HANDSHAKE) WITHLABEL('dbgmgr')

(optional) additional steps required to use a signed certificate
1. create a signing request for the self-signed certificate
The signing request will be placed in 'dsn'.
Do NOT delete the self-signed certificate before replacing it.
If you do, you lose the private key that goes with the
certificate, which makes the certificate useless.
RACDCERT ID(stcdbm) GENREQ (LABEL('dbgmgr')) DSN(dsn)
2. send the signing request to your CA of choice
3. check if the CA credentials (also a certificate) are already known
RACDCERT CERTAUTH LIST
4. mark the CA certificate used to sign your certificate as trusted
RACDCERT CERTAUTH ALTER(LABEL('CA cert')) TRUST
or add the CA certificate used to sign yours to the database
RACDCERT CERTAUTH ADD(dsn) WITHLABEL('CA cert') TRUST
5. add the signed certificate to the database;
this will replace the self-signed one
RACDCERT ID(stcdbm) ADD(dsn) WITHLABEL('dbgmgr') TRUST
6. add the CA certificate to the key ring
RACDCERT ID(stcdbm) CONNECT(CERTAUTH LABEL('CA cert') +
RING(dbgmgr.racf))

refresh to make the changes visible
SETROPTS RACLIST(DIGTCERT) REFRESH
```

AT-TLS policy also documents the use of the CERTAUTH virtual key ring for validation of the server certificate presented by the Debug UI in the Probe-Client scenario. This implies that the CA certificate used by the Debug UI is trusted by your z/OS host.

```
check if the CA credentials (also a certificate) are already known
RACDCERT CERTAUTH LIST
mark the CA certificate as trusted
RACDCERT CERTAUTH ALTER(LABEL('CA cert')) TRUST
or add the CA certificate to the database
RACDCERT CERTAUTH ADD(dsn) WITHLABEL('CA cert') TRUST

refresh to make the changes visible
SETROPTS RACLIST(DIGTCERT) REFRESH
```

Use the following commands to verify your setup:



```
verify started task setup
LISTGRP SYS1 OMVS
LISTUSER PAGENT OMVS
RLIST STARTED PAGENT.* ALL STDATA

verify Policy Agent startup permission
RLIST OPERCMDS MVS.SERVMMGR.PAGENT ALL

verify initstack protection
RLIST SERVAUTH EZB.INITSTACK.** ALL

verify pasearch protection
RLIST SERVAUTH EZB.PAGENT.** ALL

verify certificate setup
RACDCERT CERTAUTH LIST(LABEL('CA cert'))
RACDCERT ID(stcdbm) LIST(LABEL('dbgmgr'))
RACDCERT ID(stcdbm) LISTRING(dbgmgr.racf)
```

## AT-TLS policy activation

AT-TLS setup is now complete, and the policy will be activated at next IPL of the system. Follow these steps to start using the policy without an IPL:

### 1. Activate AT-TLS support in the TCP/IP stack.

- Create a TCP/IP obey file, for example, TCPIP.TCPPARMS(OBEY), with the following content:

```
TCPCONFIG TTLS
```

- Activate it with this operator command:

```
V TCPIP, ,OBEY,TCPIP.TCPPARMS(OBEY)
```

- Verify the result by checking for this console message:

```
EZZ4249I stackname INSTALLED TTLS POLICY HAS NO RULES
```

### 2. Start the Policy Agent.

- Issue operator command:

```
S PAGENT
```

- Verify the result by checking for console message:

```
EZD1586I PAGENT HAS INSTALLED ALL LOCAL POLICIES FOR stackname
```

### 3. Restart Debug Manager.

- Issue operator commands:

```
P DBGMGR
S DBBMGR
```

**Note:** Restarting Debug Manager interrupts all active debug sessions that are in pass-thru mode.

## Debug Manager authentication

Client authentication is done by RSE daemon as part of the client's connection request. After the user is authenticated, self-generated Passtickets are used for all future authentication requests, including the automatic logon to Debug Manager.

In order for Debug Manager to validate the user ID and Passticket presented by RSE, Debug Manager must be allowed to evaluate the Passticket. This implies that load module EQAZPCM, by default located in load library EQAW.SEQAAUTH, must be APF-authorized.

When a client-based Debug Engine connects to the Debug Manager, it must present a valid security token for authentication.

## TCP/IP considerations

### TCP/IP ports

Figure 3 on page 38 shows the TCP/IP ports that can be used by z/OS Explorer, z/OS Debugger and if installed, IBM Developer for z/OS. The arrows show the party that does the bind (arrowhead side) and the one that connects.

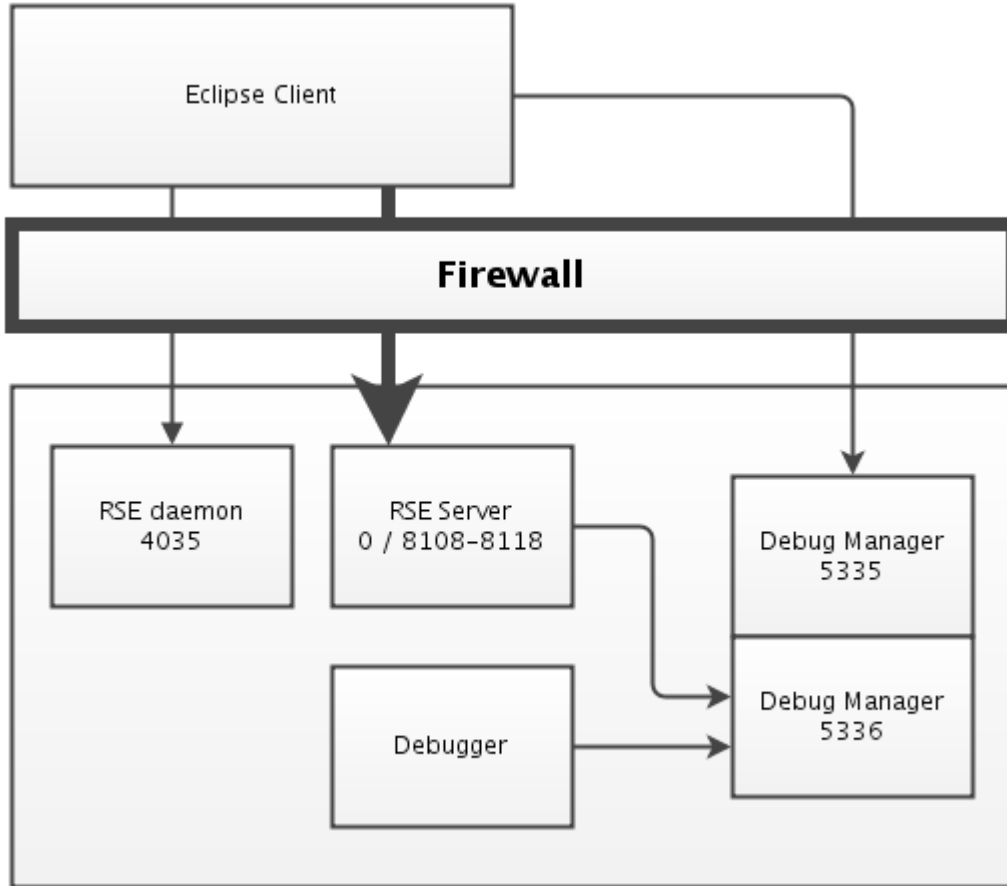

Figure 3. TCP/IP ports for the usage of z/OS Debugger with Debug Manager

Figure 4 on page 39 shows how the TCP/IP port works without Debug Manager.

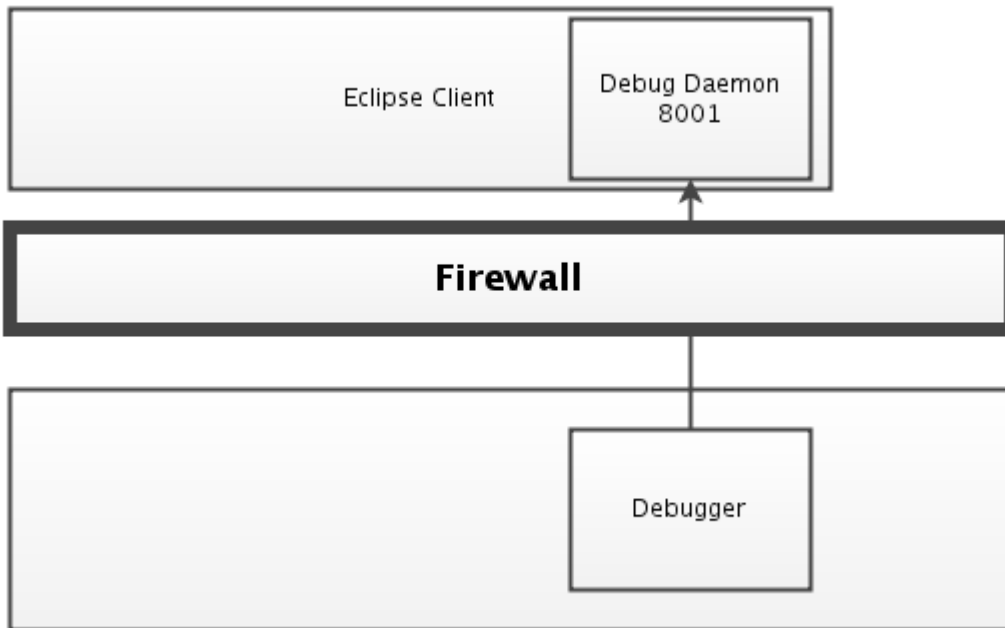

Figure 4. TCP/IP port for the usage of z/OS Debugger without Debug Manager

For more information on RSE ports, see the "External Communication" topic in the *IBM Developer for z/OS Host Configuration Reference*.

#### External communication

Define the following ports to your firewall that protect the z/OS host, as they are used for client-host communication (using the tcp protocol):

- Debug manager services, default port 5335. The port can be set in the DBGMGR started task JCL. Communication on this port can be encrypted.
- When z/OS Debugger is started with Language Environment (LE) option TEST(, , , TCPIP&&ipaddress%8001:\*) or TEST(, , , DIRECT&&ipaddress%8001:\*), it is instructed not to use Debug Manager but contact the Eclipse client directly at port 8001. This implies, from a TCP/IP perspective, that z/OS Debugger is a client that contacts a server (the Debug UI) in the Eclipse IDE.

#### Internal communication

Several z/OS Debugger host services run in separate threads or address spaces and are using TCP/IP sockets as communication mechanism, using your system's loopback address, making their data stream confined to the host only. For some services any available port will be used, for others the system programmer can choose the port or port range that will be used:

- (Optional) Debug Manager for debug related services, default port 5336. The port can be set in the DBGMGR started task JCL.

#### TCP/IP port reservation

If you use the PORT or PORTRANGE statement in PROFILE . TCPIP to reserve the ports used by z/OS Explorer, z/OS Debugger, and optionally IBM Developer for z/OS, note that many binds are done by threads active in an RSE thread pool. The job name of the RSE thread pool is RSEDx, where RSED is the name of the RSE started task, and x is a random single digit number, so wildcards are required in the definition.

|      |      |                                            |
|------|------|--------------------------------------------|
| PORT | 5335 | TCP DBGMGR ; z/OS Debugger - debug manager |
| PORT | 5336 | TCP DBGMGR ; z/OS Debugger - debug manager |

## Loopback localhost

IBM Developer for z/OS and z/OS Debugger use the TCP/IP loopback and TCP/IP localhost definitions. Communication will fail if these definitions are set up using different TCP/IP addresses. To avoid address resolution issues, define one of the following lines in the local host table, as described in section "Configuring the local host table" of the *Communications Server: IP Configuration Guide* (SC31-8775).

- 127.0.0.1 loopback localhost # for IPv4 only
- ::1 loopback localhost # for IPv6 only

**Note:** Ensure that the definition is valid for both the MVS and z/OS UNIX search orders.

Refer to *Communications Server: IP Configuration Guide* (SC31-8775) and *Communications Server: IP Configuration Reference* (SC31-8776) for additional information on TCP/IP configuration. The *IBM Explorer for z/OS Host Reference Guide* (SC27-8438) also provides related information in the "Setting up TCP/IP" chapter.

## Multi-stack (CINET)

z/OS Communication Server allows you to have multiple TCP/IP stacks concurrently active on a single system. This is referred to as a CINET setup.

When multiple TCP/IP stacks are active on a host system, it is important that Debug Manager and Debug Probe are using the same TCP/IP stack in order for them to communicate. Debug Engine (on the client) must also be able to communicate with Debug Manager. By default, Debug Manager binds to every stack available on the host to simplify matching Debug Probe and Debug Client setup.

If this is not desired, then stack affinity can be used to instruct Debug Manager to bind to a single specified TCP/IP stack. Stack affinity is set with the `_BPXK_SETIBMOPT_TRANSPORT` environment variable, which must be passed on to Language Environment. You can set stack affinity by adjusting the startup command in the started task JCL:

```
//DBGMGR PROC PRM=,
//* LEPRM='RPTOPTS(ON) ',
// LEPRM='RPTOPTS(ON) ENVAR("_BPXK_SETIBMOPT_TRANSPORT=TCPIP") ',
// TZ='EST5EDT',
// CLIENT=5335,
// HOST=5336,
// HLQ=EQAW
```

### Notes:

- `BPXK_SETIBMOPT_TRANSPORT` specifies the name of the TCP/IP stack to be used, as defined in the `TCPIPJOBNAME` statement in the related `TCPIP.DATA`.
- Coding a `SYSTCPD DD` statement does not set the requested stack affinity.

## WLM considerations

### Setting goals

z/OS Explorer, z/OS Debugger, and IBM Developer for z/OS create different types of workloads on your system. These different tasks communicate with each other, which implies that the actual elapse time becomes important to avoid time-out issues for the connections between the tasks. As a result, these tasks should be placed in high-performance service classes, or in moderate-performance service classes with a high priority.

A revision, and possibly an update, of your current WLM goals is therefore advised. This is especially true for traditional MVS shops new to time-critical OMVS workloads.

### Note:

- The goal information in this section is deliberately kept at a descriptive level, because actual performance goals are very site-specific.

- To help understand the impact of a specific task on your system, terms like minimal, moderate, and substantial resource usage are used. These are all relative to the total resource usage of IBM Developer for z/OS or z/OS Debugger, not the whole system.

All z/OS Debugger started tasks are servicing real-time client requests.

| <i>Table 7. WLM workloads - STC</i> |           |          |
|-------------------------------------|-----------|----------|
| Description                         | Task name | Workload |
| Debug Manager                       | DBGMGR    | STC      |

- Debug Manager

Debug Manager provides services to connect programs being debugged to clients debugging them. You should specify a high-performance, one-period velocity goal, because the task does not report individual transactions to WLM. Resource usage depends heavily on user actions, and will therefore fluctuate, but is expected to be minimal.

## Tuning considerations

### ***Debug Manager resource usage***

Use the information in this section to estimate the normal and maximum resource usage by Debug Manager, so you can plan your system configuration accordingly.

- [“Overview” on page 41](#)
- [“Address space count” on page 41](#)
- [“Process count” on page 42](#)
- [“Thread count” on page 42](#)

For more information about resource usage, see the topic about resource usage in *IBM Explorer for z/OS Host Configuration Reference Guide (SC27-8438)*.

## Overview

Table 8 on page 41 gives an overview of the number of address spaces, processes, and threads used by DBGMGR.

| <i>Table 8. Common resource usage</i> |                |           |         |
|---------------------------------------|----------------|-----------|---------|
| Started task                          | Address spaces | Processes | Threads |
| DBGMGR                                | 1              | 1         | 4       |

For more information about the number of address spaces, processes, and threads used by z/OS Explorer, see the overview topic in *IBM Explorer for z/OS Host Configuration Reference Guide (SC27-8438)*.

## Address space count

Table 9 on page 41 lists the address spaces that are used by Debug Manager.

| <i>Table 9. Address space count</i> |               |           |        |            |
|-------------------------------------|---------------|-----------|--------|------------|
| Count                               | Description   | Task name | Shared | Ends after |
| 1                                   | Debug Manager | DBGMGR    | Yes    | Never      |

For more information about the address spaces that are used by z/OS Explorer, see the topic about address space count in *IBM Explorer for z/OS Host Configuration Reference Guide (SC27-8438)*.

## Process count

Table 10 on page 42 lists the number of processes per address space that is used by Debug Manager.

| Processes | Address spaces | Description   | User ID |
|-----------|----------------|---------------|---------|
| 1         | 1              | Debug Manager | STCDBM  |

For more information about the number of processes per address space that is used by z/OS Explorer, see the topic about process count in *IBM Explorer for z/OS Host Configuration Reference Guide* (SC27-8438).

## Thread count

Table 11 on page 42 lists the number of threads used by Debug Manager. The thread count is listed per process, as limits are set at this level.

- RSEDx: These threads are created in the RSE thread pool, which is shared by multiple clients. All threads ending up in the same thread pool must be added together to get the total count.
- Active: These threads are part of the process that actually does the requested function. Each process is a stand-alone unit, so there is no need to sum the thread counts, even if they are assigned to same user ID, unless noted otherwise.
- Bootstrap: Bootstrap processes are needed to start the actual process. Each has 1 thread, and there can be multiple consecutive bootstraps. There is no need to sum the thread counts.

| Threads |        |           | User ID | Description   |
|---------|--------|-----------|---------|---------------|
| RSEDx   | Active | Bootstrap |         |               |
| -       | 4      | -         | STCDBM  | Debug Manager |

For more information about the number of threads, see *IBM Explorer for z/OS Host Configuration Reference Guide* (SC27-8438).

## Running multiple instances

- The Debug Manager started task is backwards compatible, and thus the most recent version can be shared across releases.
- Only one Debug Manager (DBM) is allowed on a given LPAR.

## Troubleshooting configuration problems

### Debug Manager logging

#### • SYSPRINT DD

Trace logging and logging of normal operations. The default value in the sample JCL `EQAW.SEQASAMP(EQAZPCM)` is `SYSOUT=*`.

### Debug Manager tracing

Debug Manager tracing is controlled by the system operator, as described in [“Operator commands” on page 43](#).

- Starting the `DBGMGR` started task with the `PRM=DEBUG` parameter activates tracing.
- The **modify loglevel** operator command let you select the desired detail level for log messages.

## SYSPLEX

IBM Developer for z/OS, z/OS Explorer, and z/OS Debugger are not SYSPLEX aware, and therefore requires that user-specific components that are started as JCL and are active on the same system the z/OS Debugger client UI is connected to.

## Operator commands

The following operator or console commands are available for Debug Manager.

### Start (S)

Use the **START** command to dynamically start a started task (STC). The abbreviated version of the command is the letter S.

#### START DBGMGR operator command

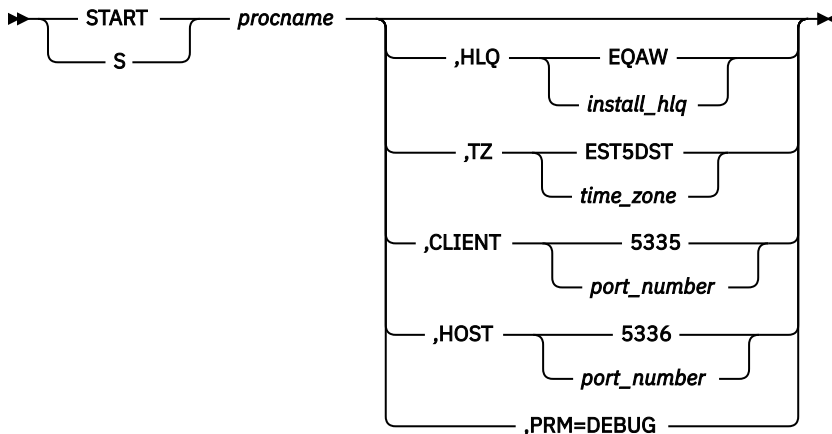

#### *procname*

The name of the member in a procedure library that is used to start the server. The default name used during the host system configuration is DBGMGR.

#### **HLQ=***install\_hlq*

High-level qualifier used to install z/OS Debugger. The default is EQAW.

#### **TZ=***time\_zone*

Time zone offset. The default is EST5DST.

#### **CLIENT=***port\_number*

The port used for external (client-host) communication, default 5335.

#### **HOST=***port\_number*

The port used for internal (host-confined) communication, default 5336.

#### **PRM=DEBUG**

Enable verbose (trace) mode. Tracing will cause performance degradations and should only be done under the direction of the IBM support center.

## Modify (F)

The **MODIFY** command can be used to dynamically query and change the characteristics of an active task. The abbreviated version of the command is the letter F.

### MODIFY DBGMGR operator command

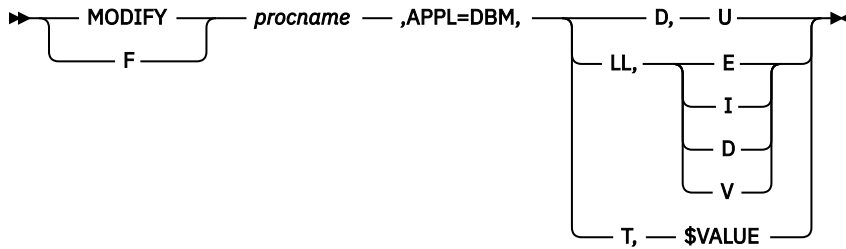

**Note:** The comma is the only delimiter. There is no space before or after a comma.

#### procname

The name of the member in a procedure library that is used to start the server. The default name used during the host system configuration is DBGMGR.

#### D, U

Display the active users with a single, multi-line, EQACM104I console message. Message EQACM103I is issued if there are no active users. The user list shows the state of that user in the server.

```
EQACM104I
User:IBMUSER RegisterSocket(2)
User:IBMUSR2 18354752 ProbeSocket(3) waits for register connection
User:IBMUSR3 25387329 ProbeSocket(5) waits for engine connection
User:IBMUSR4 24113603 Engine(4) connected to Probe(8)
Module(EQATST)
EQACM103I There is no active user
```

The first message (for IBMUSER) indicates that the user is registered, but there is no debug activity. The second message (for IBMUSR2) indicates that a debug session is waiting for the user to register. The third message (for IBMUSR3) indicates that a debug session is being set up. The fourth message (for IBMUSR4) shows an active debug session for module EQATST.

#### LL,{E | I | D | V}

Control the detail level of the Debug Manager message log (DD SYSPRINT). The default is E. A message "LOGLEVEL command processed normally" is written to the console with message ID EQACM101I.

|   |                                                      |
|---|------------------------------------------------------|
| E | Error messages only (default)                        |
| I | Error and informational messages                     |
| D | Error, informational, and debug/dump messages        |
| V | Debug level and hex value of all packets of interest |

Detailed tracing will cause performance degradations and should only be done under the direction of the IBM support center.

#### T,\$VALUE

The DBM check cycle value. The observed timeout is between \$VALUE and 2 times of \$VALUE. The value can be in the range 15 - 150 seconds and is integer only. The default value is 15.

This setting applies to pending debugging requests only. Established sessions that are already shown on the UI are not affected.



## Stop (P)

Use the **STOP** command to stop an active task. The abbreviated version of the command is the letter P.

### STOP operator command



### procname

The name of the member in a procedure library that was used to start the server. The default name used during the host system configuration is DBGMGR for Debug Manager.

## Adding support for Remote Debug Service

---

Remote Debug Service acts as a proxy between the Debug Engine and Debug Adapter Protocol (DAP) clients, like the Visual Studio Code (VS Code) extensions. Remote Debug Service enables interactive debugging of COBOL and PL/I applications in these remote debuggers. Remote Debug Service can also be configured to collect headless code coverage.

### Installing Remote Debug Service

Remote Debug Service is an Eclipse Rich Client Platform (RCP) application. The files are installed as z/OS UNIX files in the default location `/usr/lpp/IBM/debug` by using SMP/E during product installation. You can change the installation location to a directory of your choice.

**Note:** The user ID used for the SMP/E installation must have at least READ access to the BPX.FILEATTR.PROGCTL resource in the FACILITY class to preserve the extended attributes in the extracted z/OS UNIX files.

### Customizing with the sample job EQARMTSU

You need to create directories in z/OS® UNIX and copy sample configuration files from the installation directory to these directories for customization. The sample job EQAW.SEQASAMP (EQARMTSU) is provided to help you complete these tasks.

Follow the instructions within the EQARMTSU member and submit the job to customize your installation. The job performs the following tasks:

- Create `/etc/debug/*` and populate it with sample configuration files.
- Create `/var/debug/*` as work directories required to run the service.
- Set the proper z/OS UNIX file permissions on the files and directories.

The following sample files are copied to `/etc/debug` by the sample job:

#### eqarmtd.env

Environment variables that control, for example:

- Which internal and external ports to use for the service.
- Where to locate the security keystore file for SSL encryption. You can use the sample keystore file from Debug Profile Service located in the `/etc/debug` directory.
- Whether to allow headless code coverage collection.

#### eqahcc.env

Properties that control headless code coverage collection, for example:

- Where code coverage results are stored. By default, the results are output to `$HOME/CC/user_ID`, where `$HOME` is the home directory of the user running Remote Debug Service. You can specify a different root location than `$HOME/CC/`. Ensure that the code coverage users know the path to this directory to access results and have the following authority:

- A minimum of read access to the parent directory to read their user ID subdirectory *root\_location/user\_ID*. The subdirectory and the results within inherit the permissions of the parent directory. You can add users access through group or public permission.
- Enough authority to change the ownership of z/OS UNIX files. Remote Debug Service changes the owner of both the subdirectory and code coverage results to the user ID. When users do not have authority, results can still be created, but users can only manage any results based on file permissions.
- Whether to support only connections from the local host.

For more details on headless code coverage options, see the "Starting and stopping the headless code coverage daemon" topic in [IBM Knowledge Center](#).

Edit the files `/etc/debug/eqarmtd.env` and `/etc/debug/eqahcc.env`, and customize them to match your system environment.

You can run the sample job EQARMTSU more than once. If a file exists in the configuration directory, a backup is created for the existing file before a new one is copied over.

## Customizing the system PROCLIB

Customize the EQAW.SEQASAMP (EQARMTD) sample started task member, as described within the member, and copy it to SYS1.PROCLIB.

As shown in the code sample, provide the following information:

- The home directory where Remote Debug Service is installed. The default directory is `/usr/lpp/IBM/debug`.
- The location of the configuration files. The default location is `/etc/debug`.
- The name of the environment configuration file. The default name is `eqarmtd.env`.

Figure 5. Remote Debug Service started task

```

//*****
//* Licensed Materials - Property of IBM *
// * *
//* 5724-T07: IBM z/OS Debugger *
//* Copyright IBM Corp. 2020, 2020 All Rights Reserved *
// * *
//* US Government Users Restricted Rights - Use, duplication or *
//* disclosure restricted by GSA ADP Schedule Contract with IBM Corp. *
// * *
//* This JCL procedure is used to start the Remote Debug Service. *
// * *
//* You will have to make the following modifications: *
// * *
//* 1) If you installed the product in a different directory than *
//* the default /usr/lpp/IBM/debug, change SVRPATH to refer to *
//* the correct directory. *
// * *
//* 2) If you customized the configuration files in a different *
//* directory than the default /etc/debug, change CFGDIR to *
//* refer to the correct directory. *
// * *
//* 3) If you want the server to use a different work directory *
//* then the default /var/debug, change WRKDIR to refer to the *
//* desired directory. *
// * *
//* 4) If you customized the environment variables file in CFGDIR *
//* to a different file name than the default eqarmtd.env, change *
//* ENVFILE to refer to the correct name. *
// * *
//* Note(s): *
// * *
//* 1. This procedure contains case sensitive path statements. *
// * *
//* 2. Add a job card on line 1 and '//EQARMTD EXEC EQARMTD' at the *
//* bottom to submit this procedure as a user job. *
// * *
//*****
// *

```

```

/* Remote Debug Service
/*
//EQARMTD PROC SVRPATH='/usr/lpp/IBM/debug',
// CFGDIR='/etc/debug',
// WRKDIR='/var/debug',
// ENVFILE='eqarmtd.env'
// SET QUOTE='''
//EXPORTS EXPORT SYMLIST=*
// SET SVRPATH="E&SVRPATH"E
// SET CFGDIR="E&CFGDIR"E
// SET WRKDIR="E&WRKDIR"E
// SET ENVFILE="E&ENVFILE"E
/*-----
/* Start the Remote Debug Service
/*-----
//EQARMTD EXEC PGM=BPXBATSL,REGION=0M,TIME=NOLIMIT,
// PARM='PGM /bin/sh &SVRPATH/remote-debug-service/eqarmtd.sh'
//STDOUT DD SYSOUT=*
//STDERR DD SYSOUT=*
//STDENV DD *,SYMBOLS=JCLONLY
EQARMTD_CFG_DIR=&CFGDIR
EQARMTD_WRK_DIR=&WRKDIR
EQARMTD_ENVFILE=&CFGDIR/&ENVFILE
EQARMTD_BASE=&SVRPATH/remote-debug-service
_BPXK_AUTOCVT=ON
/*
// PEND
/*

```

## Remote Debug Service security definitions

Perform the following tasks to complete the basic security setup to run Remote Debug Service.

### Defining the Remote Debug Service started task

The following sample RACF commands create the EQARMTD started task, with protected user ID (STCEQA2) and the STCGROUP group assigned to it:

1. 

```
ADDGROUP STCGROUP OMVS(AUTOUID) -
DATA('GROUP WITH OMVS SEGMENT FOR STARTED TASKS')
```
2. 

```
ADDUSER STCEQA2 DFLTGRP(STCGROUP) NOPASSWORD -
NAME('REMOTE DEBUG SERVICE') -
OMVS(AUTOUID HOME('/tmp') PROGRAM('/bin/sh'))
- DATA('IBM z/OS Debugger')
```
3. 

```
RDEFINE STARTED EQARMTD.* -
STDATA(USER(STCEQA2) GROUP(STCGROUP) TRUSTED(NO)) -
DATA('REMOTE DEBUG SERVICE')
```
4. 

```
SETROPTS RACLIST(STARTED) REFRESH
```

**Note:** Ensure that the started task user ID is protected by specifying the NOPASSWORD keyword.

### Enabling secure communication

You can enable Remote Debug Service to communicate via Secure Sockets Layer (SSL) with a private key and self-signed certificate stored in a keystore file.

1. Create a JKS keystore file by using the Java runtime utility keytool:

```
keytool -genkey -alias rmtd -keyalg RSA -storetype JKS -keystore keystore.jks
```

2. Edit `/etc/debug/eqarmtd.env` and update the keystore variables to use the new keystore file.
3. To ensure that the keystore file is only readable by the protected user ID STCEQA2, change the owner and permission of the file with:

```
chown STCEQA2:STCGROUP keystore.jks
chmod 640 keystore.jks
```

4. Export the SSL certificate with:

```
keytool -export -keystore keystore.jks -alias rmttd -storetype JKS -file rmttd.cer -rfc
```

The SSL certificate can be distributed to remote users to be imported into the client keystore.

## Updating PARMLIB to start Remote Debug Service during IPL

Add a start command for Remote Debug Service to SYS1.PARMLIB(COMMNDxx) to start it automatically at the next system IPL. Define CMD=xx in the IEASYSxx parmlib member to specify the COMMNDxx parmlib member that is used during IPL.

## Starting and stopping Remote Debug Service dynamically

To start the service, use the following console command:

```
S EQARMTD
```

To stop the server, use the following console command:

```
P EQARMTD
```

## Adding support for Debug Profile Service and APIs

Debug Profile Service is a REST API that uses the HTTP protocol to provide RESTful access to a set of resources related to debug profiles. It provides POST/GET/PUT/DELETE methods to handle the creation, retrieval, updating, and deleting of debug profiles.

To enable all the features in the **z/OS Debugger Profiles** view with Eclipse, you need to install, configure and start z/OS Explorer V3.1.1.23 or later and Debug Profile Service.

For CICS, also see the instructions in [“Activating the TCP/IP Socket Interface for CICS” on page 25](#) and [“Adding support for the DTCN profiles APIs and views” on page 53](#).

The Debug Profile Service API is similar to the DTCN API, except that it also handles batch, IMS, and Db2 stored procedure profiles stored in EQAUOPTS data sets.

The Debug Profile Service API handles accessing profiles differently between CICS and non-CICS.

For CICS, user debug profiles are stored in a repository that is owned by the region. The repository can either be a CICS temporary storage queue (TSQ), or a VSAM data set allocated to DD:EQADPFMB. In either case, the Debug Profile Service API acts as a client, relaying the HTTP request to the DTCN API to handle.

For non-CICS, debug profiles are stored in EQAUOPTS data sets. The Debug Profile Service API manipulates the data sets directly, and therefore needs to be running on the z/OS host. Also, proper RACF setup is required during the API installation to allow for authentication and data set authorization that use SAF/RACF.

For the API details, see the "z/OS Debug Profile Service API" documentation in [IBM Documentation](#).

## Installing Debug Profile Service

Debug Profile Service uses Apache Tomcat on z/OS as the web server. The files are installed as z/OS UNIX files in the default location /usr/lpp/IBM/debug by using SMP/E during product installation. You can change the installation location to a directory of your choice.

**Note:** The user ID used for the SMP/E installation must have at least READ access to the BPX.FILEATTR.PROGCTL resource in the FACILITY class to preserve the extended attributes in the extracted z/OS UNIX files.

## Customizing with the sample job EQAPRFSU

You need to create directories in z/OS UNIX and copy sample configuration files from the installation directory to these directories for customization. The sample job EQAW.SEQASAMP (EQAPRFSU) is provided to help you complete these tasks.

Follow the instructions within the EQAPRFSU member and submit the job to customize your installation. The job performs the following tasks:

- Create /etc/debug/\* and populate it with sample configuration files.
- Create /var/debug/\* as work directories required to run the service.
- Set the proper z/OS UNIX file permissions on the files and directories.

The following sample files are copied to /etc/debug by the sample job:

### eqaprof.env

Environment variables that control, for example:

- Which port to use for the service.
- Where to locate the security keystore file for SSL encryption.
- The default data set name to be used for EQUOPTS data set.

### dctn.ports

A list of CICS region names, and their associated TCPIP SERVICE ports that run the DTCN API.

For more information on how to set up the CICS TCPIP SERVICE resource for the DTCN API, see [“Defining the CICS TCPIP SERVICE resource” on page 53](#). The resource must be defined with SSL(NO).

### keystore.p12

A sample keystore file that contains a self-signed SSL certificate

Edit the files /etc/debug/eqaprof.env and /etc/debug/dctn.ports, and customize them to match your system environment.

You can run the sample job EQAPRFSU more than once. If a file exists in the configuration directory, a backup is created for the existing file before a new one is copied over.

## Customizing the system PROCLIB

Customize the EQAW.SEQASAMP (EQAPROF) sample started task member, as described within the member, and copy it to SYS1.PROCLIB.

As shown in the code sample, provide the following information:

- The home directory where Debug Profile Service is installed. The default directory is /usr/lpp/IBM/debug.
- The location of the configuration files. The default location is /etc/debug.
- The name of the environment configuration file. The default name is eqaprof.env.

Figure 6. Debug Profile Service started task

```
//*
//* Debug Profile Service
//*
//EQAPROF PROC SVRPATH='/usr/lpp/IBM/debug',
// CFGDIR='/etc/debug',
// WRKDIR='/var/debug',
// ENVFILE='eqaprof.env',
// TZ='EST5EDT'
// SET QUOTE=''''
//EXPORTS EXPORT SYMLIST=*
// SET SVRPATH="E&SVRPATH"E
// SET CFGDIR="E&CFGDIR"E
// SET WRKDIR="E&WRKDIR"E
// SET ENVFILE="E&ENVFILE"E
// SET TZ="E&TZ"E
```

```

/*-----
/* Start the Debug Profile Service
/*-----
//EQAPROF EXEC PGM=BPXBATSL,REGION=0M,TIME=NOLIMIT,
// PARM='PGM /bin/sh &SVRPATH/eqaProfile/bin/start.sh'
//STDOUT DD SYSOUT=*
//STDERR DD SYSOUT=*
//STDENV DD *,SYMBOLS=JCLONLY
TZ=&TZ
EQAPROF_CFG_DIR=&CFGDIR
EQAPROF_WRK_DIR=&WRKDIR
EQAPROF_ENVFILE=&CFGDIR/&ENVFILE
CATALINA_BASE=&SVRPATH/eqaProfile
_BPXX_AUTOCVT=ON
/*
// PEND
/*

```

## Debug Profile Service security definitions

Perform the following tasks to complete the basic security setup to run Debug Profile Service.

For more information about the sample RACF commands, see *RACF Command Language Reference* (SA22-7687).

### Activating the security settings and classes

Debug Profile Service uses various security mechanisms to ensure a secure and controlled host system environment for the client. To do so, several classes and security settings must be active, as shown in the following sample RACF commands:

1. Display current settings:
  - a. SETROPTS LIST
2. Activate facility class:
  - a. SETROPTS GENERIC(FACILITY)
  - b. SETROPTS CLASSACT(FACILITY) RACLIST(FACILITY)
3. Activate started task definitions:
  - a. SETROPTS GENERIC(STARTED)
  - b. RDEFINE STARTED \*\* STDATA(USER(=MEMBER) GROUP(STCGROUP) TRACE(YES))
  - c. SETROPTS CLASSACT(STARTED) RACLIST(STARTED)

### Defining the Debug Profile Service started task

The following sample RACF commands create the EQAPROF started task, with protected user ID (STCEQA) and the STCGROUP group assigned to it:

1. ADDGROUP STCGROUP OMVS(AUTOGID) -  
DATA('GROUP WITH OMVS SEGMENT FOR STARTED TASKS')
2. ADDUSER STCEQA DFLTGRP(STCGROUP) NOPASSWORD -  
NAME('DEBUG PROFILE SERVER') -  
OMVS(AUTOUID HOME('/tmp') PROGRAM('/bin/sh'))  
- DATA('IBM z/OS Debugger')
3. RDEFINE STARTED EQAPROF.\* -  
STDATA(USER(STCEQA) GROUP(STCGROUP) TRUSTED(NO)) -  
DATA('DEBUG PROFILE SERVICE')
4. SETROPTS RACLIST(STARTED) REFRESH

**Note:** Ensure that the started task user ID is protected by specifying the NOPASSWORD keyword.

## Enabling secure communication

You can enable Debug Profile Service to communicate via a [Secure Sockets Layer \(SSL\) certificate with a private key and self-signed certificate stored in a keystore file](#) or via a [Certificate Authority \(CA\) certificate with a RACF managed key ring](#).

### Enabling secure communication with a keystore file

You can use the sample keystore file installed in `/etc/debug/keystore.p12`, or create a new one with the following steps:

1. Create a keystore file by using the Java runtime utility `keytool`:

```
keytool -genkey -alias tomcat -keyalg RSA -storetype PKCS12 -keystore keystore.p12
```

2. Edit `/etc/debug/eqaprof.env` and update the keystore variables to use the new keystore file.
3. To ensure that the keystore file is only readable by the protected user ID `STCEQA`, change the owner and permission of the file with:

```
chown STCEQA:STCGROUP keystore.p12
chmod 640 keystore.p12
```

4. Export the SSL certificate with:

```
keytool -export -keystore keystore.p12 -alias tomcat -storetype PKCS12 -file tomcat.cer -rfc
```

The SSL certificate can be distributed to remote users to be imported into the client keystore.

For Eclipse users, manually importing the certificate for **z/OS Debugger Profiles** view users is not required because users will be prompted to accept the certificate if it is not already in the keystore the first time the view connects to Debug Profile Service.

Z Open Debug users still need to manually import the self-signed certificate.

### Enabling secure communication with a RACF managed key ring

Instead of a keystore file, you can use a RACF managed key ring to enable secure communication with Debug Profile Service. To create a RACF key ring and certificates, you must have authorization to issue `RACDCERT` commands. For more information about the `RACDCERT` commands and authorizations that are required, see "RACDCERT (Manage RACF digital certificates)" in the *z/OS Security Server RACF Command Language Reference*.

1. Create a RACF key ring for Debug Profile Service to use as its keystore:

```
RACDCERT ADDRING(EQAPROF.Keyring) ID(STCEQA)
```

2. Create a CA certificate and add it to the key ring:

```
RACDCERT GENCERT CERTAUTH SUBJECTSDN(CN('CA for Debugger Services') O('IBM') OU('IBM z/OS Debugger') C('US')) SIZE(2048) WITHLABEL('zosDebuggerCA') NOTAFTER(DATE(2030-12-31))
RACDCERT CONNECT(CERTAUTH RING(EQAPROF.Keyring) LABEL('zosDebuggerCA')) ID(STCEQA)
```

3. Create a signed personal certificate and add to the key ring:

```
RACDCERT GENCERT SUBJECTSDN(CN('Debug Profile Service') O('IBM') OU('IBM z/OS Debugger') C('US')) SIZE(2048) SIGNWITH(CERTAUTH LABEL('zosDebuggerCA')) WITHLABEL('EQAPROF')
NOTAFTER(DATE(2030-12-31)) ID(STCEQA)
RACDCERT CONNECT(RING(EQAPROF.Keyring) LABEL('EQAPROF')) ID(STCEQA)
```

4. Confirm that the key ring and certificates were created correctly:

```
RACDCERT LISTRING(EQAPROF.Keyring) ID(STCEQA)
RACDCERT CERTAUTH LIST(LABEL('zosDebuggerCA'))
RACDCERT LIST(LABEL('EQAPROF')) ID(STCEQA)
```

5. Enable the protected user ID `STCEQA` authority to access the key ring:

```
PERMIT IRR.DIGTCERT.LIST CLASS(FACILITY) ID(STCEQA) ACC(READ)
PERMIT IRR.DIGTCERT.LISTRING CLASS(FACILITY) ID(STCEQA) ACC(READ)
SETROPTS RACLIST(FACILITY) REFRESH
```

6. Edit `/etc/debug/eqaprof.env` and update the keystore variables to use the key ring:

```
keystoreFile="safkeyring://STCEQA/EQAPROF.Keyring"
keystorePass="password"
keystoreType="JCERACFKS"
```

7. Export the CA certificate that contains the public key to a z/OS sequential file:

```
RACDCERT CERTAUTH EXPORT(LABEL('zosDebuggerCA')) DSN('<sequential data set>') FORMAT(CERTDER)
```

The CA certificate can be distributed to remote users to be imported into the client keystore manually if necessary.

For Eclipse users, manually importing the certificate for **z/OS Debugger Profiles** view users is not required because users will be prompted to accept the certificate if it is not already in the keystore the first time the view connects to Debug Profile Service.

Z Open Debug users still need to manually import the self-signed certificate.

## Defining Debug Profile Service as a secure z/OS UNIX server

Debug Profile Service requires UPDATE access to the BPX.SERVER resource in the FACILITY class to create or delete the security environment for the client thread:

1. RDEFINE FACILITY BPX.SERVER UACC(NONE)
2. PERMIT BPX.SERVER CLASS(FACILITY) ID(STCEQA) ACCESS(UPDATE)
3. SETROPTS RACLIST(FACILITY) REFRESH



**Attention:** Defining the BPX.SERVER resource makes z/OS UNIX as a whole switch from UNIX level security to z/OS UNIX level security, which is more secure. This switch might impact other z/OS UNIX applications and operations. Test the security before activating it on a production system. For more information about the different security levels, see *UNIX System Services Planning* (GA22-7800).

## Enabling Debug Profile Service to switch user context

Debug Profile Service must be able to switch to the client user ID to perform I/O operations on EQAUOPTS data sets. Define specific BPX.SRV profiles in the SURROGAT class in RACF, or specify a general profile to allow the API to switch to any user ID:

1. RDEFINE SURROGAT BPX.SRV.\*\* UACC(NONE)
2. PERMIT BPX.SRV.\*\* CLASS(SURROGAT) ID(STCEQA) ACCESS(READ)
3. SETROPTS RACLIST(SURROGAT) REFRESH

**Note:** Ensure that the started task user ID is protected by specifying the NOPASSWORD keyword.

## Updating PARMLIB to start Debug Profile Service during IPL

Add a start command for Debug Profile Service to SYS1.PARMLIB(COMMNDxx) to start it automatically at the next system IPL. Define CMD=xx in the IEASYSxx parmlib member to specify the COMMNDxx parmlib member that is used during IPL.

## Starting and stopping Debug Profile Service dynamically

To start the server, use the following console command:

```
S EQAPROF
```



To stop the server, use the following console command:

```
P EQAPROF
```

## Adding support for the DTCN profiles APIs and views

In a DTCN profile, or a CICS profile, users can specify, for example, the program they want to debug on CICS. Remote users can create, delete, or modify a profile in the following ways:

- Use the **z/OS Debugger Profiles** view to create and manage CICS profiles.
- Add the Debug Tool DTCN Profile Manager plug-in to IBM Developer for z/OS or IBM Debug for z/OS and use its **DTCN Profiles** view.

**Note:** The **DTCN Profiles** view is replaced by the **z/OS Debugger Profiles** view. The DTCN plug-in is deprecated and will be removed in a future release.

- Write their own application that uses the APIs described in *IBM z/OS Debugger API User's Guide and Reference*.
- Use the DTCN transaction in a 3270 session.

For the first three cases, you need to enable TCP/IP communication between the remote application and an HTTP server running in a CICS region on the z/OS system, as described in [“Defining the CICS TCPIP SERVICE resource”](#) on page 53. Then inform your users that you have enabled this support.

For the first case, to enable all the features in the **z/OS Debugger Profiles** view, configure Debug Profile Service for best user experience. For more information, see [“Adding support for Debug Profile Service and APIs”](#) on page 48.

For the second case, your users can find instructions for installing the Debug Tool DTCN Profile Manager plug-in in "Appendix K: Using the IBM Debug Tool plug-ins" in the IBM z/OS Debugger User's Guide. The Debug Tool plug-ins are not available in IBM Wazi Developer for Red Hat CodeReady Workspaces.

For all cases, if you want users other than the profile owners to modify or delete DTCN profiles, see [“Defining who can create, modify, or delete DTCN profiles”](#) on page 56.

## Defining the CICS TCPIP SERVICE resource

Before your users can use the profile view or develop applications that use the APIs, you must define the CICS TCPIP SERVICE resource for every CICS region that users access.

For every region that users access, do these steps:

1. Define the TCP/IP address and host name for the z/OS system. By default, they are defined in the PROFILE.TCPIP and TCPIP.DATA data sets.
2. Add a TCP/IP listener to CICS. Use the following CEDA command to define a TCPIP SERVICE in a group:

```
CEDA DEF TCPIP SERVICE(service-name) GROUP(group-name)
```

Ensure that the group in which you define the service is in the startup GRPLIST, so that the listener starts when CICS starts. The following list explains what values to use for some of the key fields:

### **TCpipservice(*service-name*)**

Create a name that is eight characters or less.

### **GRoup(*group-name*)**

Create a name that is eight characters or less.

### **Urm**

Specify EQADCAN0.

### **PORTnumber**

Specify an unused port number that the DTCN Profile Manager plug-in uses for the API's communication.

**Status**

Specify Open.

**PROtocol**

Specify Http.

**TRansaction**

Specify CWXN.

**Backlog**

The number of TCP/IP requests that are queued before TCP/IP starts to reject incoming requests. For example, 30.

**SOcketclose**

Specify No.

**Maxdatalen**

Specify the maximum size, in bytes, of the body (the XML document) of the HTTP request or response. For example, 032768 represents 32K bytes.

**SSI**

Specify Yes if you are using SSL encryption with the HTTPS protocol.

**AUthenticate**

Specify Basic.

**GRPcritical**

Specify No.

3. Add a URIMAP definition to match the URLs of the incoming HTTP requests:

```
CEDA DEF URIMAP(map-name) GROUP(group-name)
```

The following list explains what values to use for the key fields:

**URIMAP(*map-name*)**

Create a name that is eight characters or less.

**GROUP(*group-name*)**

Specify the same *group-name* as used in the TCPIP SERVICE resource definition.

**STATUS**

Specify Enabled.

**USAGE**

Specify Server.

**SCHEME**

Specify HTTP.

**HOST**

Specify \*.

**PATH**

Specify /dtcn/\*.

**ANALYZER**

Specify Yes.

4. Enter the following commands to install the TCPIP SERVICE and URIMAP definitions:

```
CEDA INS TCPIP SERVICE(service-name) GROUP(group-name)
```

```
CEDA INS URIMAP(map-name) GROUP(group-name)
```

5. If you encounter problems with the connection from the workstation to the HTTP server in the CICS region, issue the command `CENT INQUIRE TCPIP SERVICE(service-name)` on the server region to verify if your settings are correct. Your settings must be as follows:

- Port(*nnnn*), where *nnnn* is the port that the workstation connects to.
- Authentication(Basic)

- MaxdataLen(032000)
  - Urm(EQADCAN0)
6. Ask your system administrator to provide access to transactions CWBA and CWXN because they are used in the HTTP request processing.

## Establishing secure communication between the profile view and your z/OS system for CICS

These steps help you enable secure communication via Secure Sockets Layer (SSL) between the view and your z/OS system. The communication between the client and server uses the HTTP protocol.

### Server-side setup

To enable SSL communication, do the following tasks for the server side:

- Generate key pair and self-signed certificate.
  1. Use the RACF GENCERT command to create a key entry for the CICS region owner. The key entry contains the key pair and self-signed certificate.

**Note:** The following example shows the RACF commands as they would be coded in a REXX exec. This is recommended because of the length of the commands.

Example (Create a key entry for user USERID with label: USERID-DTCNPLG-CERT):

```
/* generate key entry */
"RACDCERT ID(USERID) GENCERT",
" SUBJECTSDN(CN('your_host_name.com')",
" T ('USERID-DTCNPLG-CERT') ",
" OU('IBM') ",
" O ('IBM') ",
" L ('San Jose') ",
" SP('CA') ",
" C ('US')",
" NOTBEFORE (DATE(2011-02-28) TIME(20:00:00))",
" NOTAFTER (DATE(2031-12-31) TIME(19:59:59))",
" WITHLABEL('USERID-DTCNPLG-CERT')",
" SIZE (1024)"
```

The common name of the subject DSN must be the host name of the server that the client uses to connect to host.

2. Connect the key entry to a key ring that belongs to the CICS region owner ID.

Example (Connect it to a key ring named USERID):

```
/* connect key entry to key ring */
"RACDCERT ID(USERID)",
"CONNECT(RING(USERID) ",
" LABEL('USERID-DTCNPLG-CERT'))"
```

3. Export the certificate and store it in a data set using the printable encoding format defined by the internet RFC 1421 standard.

Example (Export the certificate to a data set: USERID.DTCNPLG.CERT):

```
/* export certificate to a data set */
"RACDCERT EXPORT(LABEL('USERID-DTCNPLG-CERT') ",
" ID(USERID) ",
" DSN('USERID.DTCNPLG.CERT') ",
" FORMAT(CERTB64)"
```

- Update system initialization parameters in CICS region.
  1. Add a KEYRING system initialization parameter to the CICS region job and point it to the key ring created for the region owner ID.

2. The following example adds KEYRING to the CICS region's system initialization parameters:

```
SIT=6$,
START=INITIAL,
RENTPGM=PROTECT,
...
TRANISO=YES,
KEYRING=key-ring-name,
EDSALIM=132M,
...
```

- Modify the TCIPSERVICE you defined above to set these two attributes:
  - SSL : Yes Yes | No | Clientauth
  - Certificate : USERID-DTCNPLG-CERT

## Client-side setup

To enable SSL communication, do the following tasks for the client side. For the **z/OS Debugger Profiles** view users, the following tasks are not required because users will be prompted to accept or decline any certificates that are not installed when using the view.

- Install client certificate.

Because the server certificate generated is not from an authorized CA, you need to install the certificate into the keystore that IBM Developer for z/OS uses.

1. Get a client certificate by downloading a copy of the exported server certificate (using text mode) that is created in step 3 of Server-side setup above to your workstation.
2. Import the client certificate into the keystore. The following is an example how to import the certificate into keystore using keytool provided by Java.

For Java version 1.7: `keytool -importcert -alias myprivateroot -keystore`

```
C:\YOUR_WORKSPACE_DIRECTORY\.metadata\.plugins\com.ibm.cics.core.comm\explorer_keystore.jks -file dtcnplg.cer
```

`dtcnplg.cer` is the client certificate. The initial password for the keystore is `changeit`.

### Notes:

- For Java version 1.7, the default keystore is:  
`C:\YOUR_WORKSPACE_DIRECTORY\.metadata\.plugins\com.ibm.cics.core.comm\explorer_keystore.jks`
- For IBM Developer for z/OS, the keytool utility can be found in this Java installation bin directory,  
`C:\DEVELOPER_FOR_Z_SYSTEMS\jdk\jre\bin`.

## Defining who can create, modify, or delete DTCN profiles

Profile owners can always create, modify or delete their own profiles. However, you can define, through RACF profiles, other users that can modify or delete any profiles. This might be useful, for example, if you want a system administrator to delete unused or obsolete profiles owned by a user that no longer has access to those profiles.

Only the security administrator of the z/OS system can add or remove IDs to the RACF profiles. After you identify the IDs of the users you want to have this access, do these steps:

1. Establish the profile in the FACILITY class by entering the following RDEFINE command:

```
RDEFINE FACILITY EQADTOOL.DTCNCHNGEANY UACC(NONE)
```

2. Verify that generic profile checking is in effect for the class FACILITY by entering the following command:

```
SETROPTS GENERIC(FACILITY)
```

3. Give a user (for example, user DUSER1) permission to modify another user's profiles by entering the following command:

```
PERMIT EQADTOOL.DTCNCHNGEANY CLASS(FACILITY) ID(DUSER1) ACCESS(UPDATE)
```

Instead of connecting individual users, you can specify that DUSER1 be a RACF group profile and then connect authorized users to that group.

4. If the FACILITY class is not active, activate the class by entering the following command:

```
SETROPTS CLASSACT(FACILITY)
```

Enter the SETROPTS LIST command to verify that the FACILITY class is active.

5. Refresh the FACILITY class by entering the following command:

```
SETROPTS RACLIST(FACILITY) REFRESH
```

## Adding support for the DTSP Profile, code coverage, and load module analyzer views

---

### Notes:

- This section is not applicable to IBM Wazi Developer for Red Hat CodeReady Workspaces.
- The DTSP plug-in is deprecated and will be removed in a future release. The DTSP views are replaced by the **z/OS Debugger Profiles** view. To enable all the features in the **z/OS Debugger Profiles** view, see [“Adding support for Debug Profile Service and APIs”](#) on page 48 instead.

Your users can add these 3 views to the Debug perspective of IBM Developer for z/OS and IBM Debug for z/OS.

- The DTSP Profile view helps users update the TEST runtime options data set from the remote debugger.
- The code coverage view helps users generate code coverage reports.
- The load module analyzer view helps users analyze the contents of a load module.

Before your users can use these views, you must do the following tasks:

- Install the ADFz Common Components Server.
- Install and configure the z/OS Debugger extensions for the ADFz Common Components.
- Run the ADFz Common Components Server.
- Inform your users that you have installed this software and now they can use these views. They can find instructions for installing it in "Appendix K: Installing the IBM Debug Tool plug-ins" in the *IBM z/OS Debugger User's Guide*.

Before you begin, verify that you have the following software installed:

- UNIX System Services
- ADFz Common Components, as described throughout *Program Directory for IBM Application Delivery Foundation for z/OS Common Components* and *IBM Application Delivery Foundation for z/OS Common Components Customization Guide and User Guide*.

Refer to the following topics for more information related to the material discussed in this topic.

### Related tasks

[“Creating and managing the TEST runtime options data set”](#) on page 65

## Installing the ADFz Common Components Server

IBM ADFz Common Components Server is referred to as ADFz Common Components server in this document.

You can find step-by-step procedures to run the Common Components Server in the *IBM Application Delivery Foundation for z/OS Common Components Customization Guide and User Guide*.

## Installing and configuring the z/OS Debugger extensions for the Common Components Server

You must create a configuration file for the z/OS Debugger extensions for the Common Components Server, and then specify the location of the configuration file to the server to enable communication between the views and your z/OS system.

To configure the z/OS Debugger extensions for the Common Components Server, do the following steps:

1. Create a sequential MVS data set (FB, LRECL 80) that contains the following records. Replace the z/OS Debugger SEQAMOD data set name in SPAWN\_STEPLIB=EQAW.SEQAMOD statement with the installed z/OS Debugger SEQAMOD data set name.

**Note:** Do not change other statements.

```
* DTSP profile view
CONFIG=DT
SPAWN_PROGRAM=EQACMINT
SPAWN_STEPLIB=EQAW.SEQAMOD
SPAWN_PARMS_SECTION
* code coverage view
CONFIG=CC
SPAWN_PROGRAM=EQACCINT
SPAWN_STEPLIB=EQAW.SEQAMOD
SPAWN_PARMS_SECTION
* load module analyzer view
CONFIG=LM
SPAWN_PROGRAM=EQALMINT
SPAWN_STEPLIB=EQAW.SEQAMOD
SPAWN_PARMS_SECTION
SPAWN_DD=EQASYSPF=EQAW.SEQATLIB(EQALMPFX)
SPAWN_DD=EQAPGMNM=EQAW.SEQATLIB(EQALMPGM)
```

A sample job that creates and updates the configuration data set is provided in the `h1q.SEQASAMP(EQAWCCFG)` data set.

2. Modify the Common Components Server started proc IPVSRV1.
  - a. Add the configuration data set to the CONFIG DD statement concatenation.
  - b. Set the region size parameter to 200M or 0M. For example, `//RUN EXEC PGM=IPVSRV,REGION=200M`.
  - c. Stop and restart the Common Components Server.
3. When adding a host connection for ADFz Common Components Server, consult with your host administrator and choose an encoding of character set that matches what your host system uses.

## Running the Common Components Server

You can find step-by-step procedures to run the Common Components Server in the *IBM Application Delivery Foundation for z/OS Common Components Customization Guide and User Guide*.

## Enabling secure communication between z/OS Debugger and the remote debugger for incoming debug sessions

This section assists you in setting up a secure communication by using the z/OS Communications Server: IP Application Transparent – Transport Layer Security (AT-TLS) service when you use the TCPIP or DIRECT suboption in the TEST runtime option. By exploiting the Secure Sockets Layer (SSL) functions of AT-TLS, z/OS Debugger provides a secure (encrypted) communication with the remote Eclipse debugger.

The setup assumes that the remote debugger is the TCP/IP server and z/OS Debugger is the TCP/IP client.

Carry out the following steps:

- Add a client certificate.

Export a copy of a client certificate from the keystore that the remote debugger uses. This client certificate is used by AT-TLS to authenticate the TCP/IP server (remote debugger) during SSL handshaking. If the remote debugger does not have a certificate, you can use the following Java runtime utility to create a keystore and certificate and to export a client certificate.

#### Create a keystore and certificate

```
keytool -genkeypair
```

#### Export a client certificate

```
keytool -exportcert
```

Each Eclipse client user must configure the debug daemon to start on a secured port with the location and password of the keystore created previously. These settings can be found on **Preferences > Run/Debug > Debug Daemon** preference page. For more information about the Debug Daemon preference page, see the "Setting debug preferences" topic in [IBM Knowledge Center](#).

Upload the certificate to z/OS in binary mode and store it as a SITE or CERTAUTH certificate in RACF or other equivalent security facility. The following examples use the **RACDCERT** command to add a certificate:

```
RACDCERT SITE
ADD('USERID1.DTPDT.CERT1') WITHLABEL('DTPDT-CERT1') TRUST

RACDCERT CERTAUTH
ADD('USERID1.DTPDT.CERT1') WITHLABEL('DTPDT-CERT1') TRUST
```

where USERID1.DTPDT.CERT1 is a file that contains the uploaded certificate and DTPDT-CERT1 is a label of the certificate in RACF.

The following information is used in the previous examples:

#### USERID1.DTPDT.CERT1

A file that contains the uploaded certificate.

#### DTPDT-CERT1

A label of the certificate in RACF.

**Note:** Both SITE and CERTAUTH certificates work with the key ring **\*SITE\*/\*** parameter in TTLSKeyRingParms definition below. If you use a CERTAUTH certificate, also define the **\*AUTH\*/\*** parameter.

- Add an AT-TLS rule.

The rule allows AT-TLS to enable SSL when z/OS Debugger connects to the remote debugger on a specified port. The following example shows that the remote debugger listens to the secure port 9101. In your development environment, you must determine which secure port the remote debugger listens to and use it in the RemotePortRange statement.

```
TTLSRule DTPDTRL1
{
 RemotePortRange 9101 <=== secure port
 Direction Outbound <=== outbound direction
 TTLSGroupActionRef DTPDTRL1GrpAct
 TTLSEnvironmentActionRef DTPDTRL1EnvAct
}
TTLSGroupAction DTPDTRL1GrpAct
{
 TTLSEnabled On <=== enable rule
 Trace 30
}
TTLSEnvironmentAction DTPDTRL1EnvAct
{
 TTLSKeyRingParms
 {
 Keyring *SITE*/* <=== virtual key ring
 }
 HandShakeRole Client
}
```

## AT-TLS currency

A TLS v1.2 protocol is available that uses more secured algorithms during SSL handshake operations. To use the protocol, take the following steps.

### For z/OS Version 1 Release 13

1. Two APARs OA39422 and PM62905 are required to enable TLS v1.2 in z/OS v1.13.
2. AT-TLS rule update. The following code is an example for secure port 9102:

```
TTLRule DTPDTRL2
{
 RemotePortRange 9102
 Direction Outbound
 TTLGroupActionRef DTPDT2GrpAct
 TTLEnvironmentActionRef DTPDT2EnvAct
}
TTLGroupAction DTPDT2GrpAct
{
 TTLEnabled On
 Trace 30
 TTLGroupAdvancedParms
 {
 Envfile /etc/pagent/DTPDT2grp.env <== DTPDT2grp.env contains
 GSK_PROTOCOL_TLSV1_2=ON
 }
 <== system SSL environment variable.
}
TTLEnvironmentAction DTPDT2EnvAct
{
 TTLKeyRingParms
 {
 Keyring *SITE*/*
 }
 HandShakeRole Client
}
```

### For z/OS Version 2 Release 1

1. TLS v1.2 support is included in z/OS v2.1 base.
2. AT-TLS rule update. The following code is an example for secure port 9102:

```
TTLRule DTPDTRL2
{
 RemotePortRange 9102
 Direction Outbound
 TTLGroupActionRef DTPDT2GrpAct
 TTLEnvironmentActionRef DTPDT2EnvAct
}
TTLGroupAction DTPDT2GrpAct
{
 TTLEnabled On
 Trace 30
}
TTLEnvironmentAction DTPDT2EnvAct
{
 TTLKeyRingParms
 {
 Keyring *SITE*/*
 }
 HandShakeRole Client
 TTLEnvironmentAdvancedParms
 {
 TLSv1.2 On
 }
}
```



# Chapter 8. Specifying the TEST runtime options through the Language Environment user exit

z/OS Debugger provides a customized version of the Language Environment user exit (CEEEXITA). The user exit returns a TEST runtime option when called by the Language Environment initialization logic. z/OS Debugger provides a user exit that supports three different environments. This topic is also described in *IBM z/OS Debugger User's Guide* with information specific to application programmers.

The user exit extracts the TEST runtime option from a user controlled data set with a name that is constructed from a naming pattern. The naming pattern can include the following tokens:

### &USERID

z/OS Debugger replaces the &USERID token with the user ID of the current user. Each user can specify an individual TEST runtime option when debugging an application. This token is optional.

### &PGMNAME

z/OS Debugger replaces the &PGMNAME token with the name of the main program (load module). Each program can have its own TEST runtime options. This token is optional.

z/OS Debugger provides the user exit in two forms:

- A load module. The load modules for the three environments are in the *hlq.SEQAMOD* data set. Use this load module if you want the default naming patterns and message display level. The default naming pattern is &USERID.DBGTOOL.EQAUOPTS and the default message display level is X'00'.
- Sample assembler user exit that you can edit. The assembler user exits for the three environments are in the *hlq.SEQASAMP* data set. You can also merge this source with an existing version of CEEEXITA. Use this source code if you want naming patterns or message display levels that are different than the default values.

z/OS Debugger provides a customized version of the Language Environment user exit named EQAD3CXT. The following table shows the environments in which this user exit can be used. The EQAD3CXT user exit determines the runtime environment internally and can be used in multiple environments.

| Table 12. Language Environment user exits for various environments                                                                                                                                 |                |
|----------------------------------------------------------------------------------------------------------------------------------------------------------------------------------------------------|----------------|
| Environment                                                                                                                                                                                        | User exit name |
| The following types of Db2 stored procedures that run in WLM-established address spaces: <ul style="list-style-type: none"> <li>• type MAIN<sup>1</sup></li> <li>• type SUB<sup>2</sup></li> </ul> | EQAD3CXT       |
| IMS TM <sup>3</sup> and BTS <sup>4</sup>                                                                                                                                                           | EQAD3CXT       |
| Batch                                                                                                                                                                                              | EQAD3CXT       |

### Note:

1. EQAD3CXT is supported for DB2 version 7 or later. If Db2 RUNOPTS is specified, EQAD3CXT takes precedence over Db2 RUNOPTS.
2. If you have installed the PTF for APAR PM15192 for Language Environment Version 1.10 to Version 1.12, or have Language Environment Version 1.13 or higher, the type SUB stored procedure is invoked by the `call_sub` function and EQAD3CXT is not needed.
3. For IMS TM, if you do not sign on to the IMS terminal, you might need to run the EQASET transaction with the TS0ID option. For instructions on how to run the EQASET transaction, see "Debugging Language Environment IMS MPPs without issuing /SIGN ON" in the *IBM z/OS Debugger User's Guide*.

4. For BTS, you need to specify Environment command (./E) with the user ID of the IO PCB. For example, if the user ID is ECSVT2, then the Environment command is ./E USERID=ECSVT2.

Your users can use the user exit in the following ways:

- The user can link the user exit into his application program.
- The user can link the user exit into a private copy of a Language Environment module (CEEINIT, CEEPIPI, or both), and then, only for the modules the user might debug, place the SCEERUN data set containing this module in front of the system Language Environment modules in CEE.SCEERUN in the load module search path.

To learn about the advantages and disadvantages of each method, see [“Comparing the two methods of linking CEEBXITA”](#) on page 64.

To prepare your site to use the Language Environment user exit, do the following tasks:

1. [“Editing the source code of CEEBXITA”](#) on page 62.
2. [“Linking the CEEBXITA user exit into a private copy of a Language Environment runtime module”](#) on page 65.

To do the instructions in [“Customizing for JCL for Batch Debugging utility”](#) on page 72, you need the following information:

- If you change the naming pattern of the TEST runtime options data set, you need the new naming pattern you set in [“Modifying the naming pattern”](#) on page 62.
- The name of the *hlq*.*BATCH.SCEERUN* data set you create when you do the instructions in [“Linking the CEEBXITA user exit into a private copy of a Language Environment runtime module”](#) on page 65.

To do the instructions in [“Customizing z/OS Debugger User Exit Data Set”](#) on page 80, you need the following information:

- If you change the naming pattern of the TEST runtime options data set, you need the new naming pattern you set in [“Modifying the naming pattern”](#) on page 62.

To do the instructions in [“Customizing IMS Transaction and User ID Cross Reference Table ”](#) on page 83, you need the following information:

- If you change the name of the cross reference table data set, you need the data set name you set in [“Activate the cross reference function and modifying the cross reference table data set name”](#) on page 64.

## Editing the source code of CEEBXITA

---

You can edit the sample assembler user exit that is provided in *hlq*.*SEQASAMP* to customize the naming patterns or message display level by doing one of the following tasks:

- Use SMP/E USERMOD EQAUMODK to update the copy of the exit in the *hlq*.*SEQAMOD* data set. The USERMOD is in *hlq*.*SEQASAMP*.
- Create a private load module for the customized exit. Copy the assembler user exit that has the same name as the user exit from *hlq*.*SEQASAMP* to a local data set. Edit the patterns or message display level. Customize and run the JCL to generate a load module.

## Modifying the naming pattern

The naming pattern of the data set that has the TEST runtime option is in the form of a sequential data set name. You can optionally specify a &USERID token, which z/OS Debugger substitutes with the user ID of the current user. You can also add a &PGMNAME token, which z/OS Debugger substitutes with the name of the main program (load module). However, if users create and manage the TEST runtime option data set with the **DTSP Profile** view in the remote debugger, do not specify the &PGMNAME token because the view does not support that token.

In some cases, the first character of a user ID is not valid for a name qualifier. A character can be concatenated before the &USERID token to serve as the prefix character for the user ID. For example, you

can prefix the token with the character "P" to form P&USERID, which is a valid name qualifier after the current user ID is substituted for &USERID. For IMS, &USERID token might be substituted with one of the following values:

- IMS user ID, if users sign on to IMS.
- TSO user ID, if users do not sign on to IMS.

The default naming pattern is &USERID.DBGTOOL.EQAUOPTS. This is the pattern that is in the load module provided in *hlq.SEQAMOD*.

The following table shows examples of naming patterns and the corresponding data set names after z/OS Debugger substitutes the token with a value.

| Naming pattern             | User ID | Program name | Name after user ID substitution |
|----------------------------|---------|--------------|---------------------------------|
| &USERID.DBGTOOL.EQAUOPTS   | JOHNDOE |              | JOHNDOE.DBGTOOL.EQAUOPTS        |
| P&USERID.EQAUOPTS          | 123456  |              | P123456.EQAUOPTS                |
| DT.&USERID.TSTOPT          | TESTID  |              | DT.TESTID.TSTOPT                |
| DT.&USERID.&PGMNAME.TSTOPT | TESTID  | IVP1         | DT.TESTID.IVP1.TSTOPT           |

To customize the naming pattern of the data set that has TEST runtime option, change the value of the DSNT DC statement in the sample user exit. For example:

```
* Modify the value in DSNT DC field below.
*
* Note: &USERID below has one additional '&', which is an escape
* character.
*
DSNT_LN DC A(DSNT_SIZE) Length field of naming pattern
DSNT DC C'&&USERID.DBGTOOL.EQAUOPTS'
DSNT_SIZE EQU *-DSNT Size of data set naming pattern
*
```

## Modifying the message display level

You can modify the message display level for CEEBXITA. The following values set WTO message display level:

### **X'00'**

Do not display any messages.

### **X'01'**

Display error and warning messages.

### **X'02'**

Display error, warning, and diagnostic messages.

The default value, which is in the load module in *hlq.SEQAMOD*, is X'00'.

To customize the message display level, change the value of the MSGS\_SW DC statement in the sample user exit. For example:

```
* The following switch is to control WTO message display level.
*
* x'00' - no messages
* x'01' - error and warning messages
* x'02' - error, warning, and diagnostic messages
*
MSGS_SW DC X'00' message level
*
```

## Modifying the call back routine registration

You can register a call back routine to the Language Environment. The Language Environment invokes the call back routine prior to calling a type SUB program using CALL\_SUB API in the CEEPIPI environment. The call back routine performs a pattern match to determine if the type SUB program is to be debugged.

To customize the registration, change the value of the RRTN\_SW DC statement.

**x'00'**

No registration of the call back routine.

**x'01'**

Registration of the call back routine.

## Activate the cross reference function and modifying the cross reference table data set name

You can activate the cross reference function of the IMS Transaction and User ID Cross Reference Table and provide a cross reference table data set name. When an IMS transaction is initiated from the web or MQ gateway, it runs with a generic ID. If a user wants to debug the transaction, the cross reference function provides a way to associate the transaction with his or her user ID.

To customize the activation, change the value of the XRDSN\_SW DC statement.

**x'00'**

Cross reference function is not activated.

**x'01'**

Cross reference function is activated.

To customize the cross reference table data set name, change the value of the XRDSN DC statement. You must provide a fully qualified MVS sequential data set name.

## Comparing the two methods of linking CEEBXITA

---

You can link in the user exit CEEBXITA in the following ways:

- Link it into the application program.

### Advantage

The user exit affects only the application program being debugged. This means you can control when z/OS Debugger is started for the application program. You might also not need to make any changes to your JCL to start z/OS Debugger.

### Disadvantage

You must remember to remove the user exit for production or, if it isn't part of your normal build process, you must remember to relink it to the application program.

- Link it into a private copy of a Language Environment runtime load module (CEEBINIT, CEEPIPI, or both)

### Advantage

You do not have to change your application program to use the user exit. In addition, you do not have to link edit extra modules into your application program.

### Disadvantage

You need to take extra steps in preparing and maintaining your runtime environment:

- Make a private copy of one or more Language Environment runtime routines
- Only for the modules you might debug, customize your runtime environment to place the private copies in front of the system Language Environment modules in CEE.SCEERUN in the load module search path
- When you apply maintenance to Language Environment, you might need to relink the routines.
- When you upgrade to a new version of Language Environment, you must relink the routines.

If you link the user exit into the application program and into a private copy of a Language Environment runtime load module, which is in the load module search path of your application execution, the copy of the user exit in the application load module is used.

## Linking the CEEBXITA user exit into a private copy of a Language Environment runtime module

The following table shows the Language Environment runtime load module and the user exit needed for each environment.

| Environment                                                                                                                                                                            | User exit name | CEE load module |
|----------------------------------------------------------------------------------------------------------------------------------------------------------------------------------------|----------------|-----------------|
| The following types of Db2 stored procedures that run in WLM-established address spaces: <ul style="list-style-type: none"> <li>• type MAIN</li> <li>• type SUB<sup>1</sup></li> </ul> | EQAD3CXT       | CEEPIPI         |
| IMS TM and BTS                                                                                                                                                                         | EQAD3CXT       | CEEBINIT        |
| Batch                                                                                                                                                                                  | EQAD3CXT       | CEEBINIT        |

### Note:

1. If you have installed the PTF for APAR PM15192 for Language Environment Version 1.10 to Version 1.12, or have Language Environment Version 1.13 or higher, the type SUB stored procedure is invoked by the `call_sub` function and EQAD3CXT is not needed.

Edit and run sample `hlq.SEQASAMP(EQAWLCE3)` to create these updated Language Environment runtime modules. The sample creates the following load module data sets:

- `hlq.DB2SP.SCEERUN(CEEPIPI)`
- `hlq.IMSTM.SCEERUN(CEEBINIT)`
- `hlq.BATCH.SCEERUN(CEEBINIT)`

Inform your users that you created these data sets. When you apply service to Language Environment that affects either of these modules (CEEPIPI or CEEBINIT) or you move to a new level of Language Environment, you need to rebuild your private copy of these modules by running the sample again.

## Creating and managing the TEST runtime options data set

The TEST runtime options data set is an MVS data set that contains the Language Environment runtime options. The z/OS Debugger Language Environment user exit EQAD3CXT constructs the name of this data set based on a naming pattern described in [“Modifying the naming pattern” on page 62](#) “Modifying the naming pattern” in the *IBM z/OS Debugger Customization Guide*.

If your site does not allow your users to create data sets, you must create the data sets manually with the following requirements:

- Sequential data set (DSORG=PS)
- Record format and length requirements:
  - RECFM(F) or RECFM(FB) and LRECL >=80
  - RECFM(V) or RECFM(VB) and LRECL >=84
- Not an HFS or zFS file
- Name the data set so it follows the naming pattern defined in [“Modifying the naming pattern” on page 62](#).

Your users can then use any of the following ways to create the data set:

- By using Terminal Interface Manager (TIM), as described in "Creating and managing the TEST runtime options data set by using Terminal Interface Manager (TIM) " in the *IBM z/OS Debugger User's Guide*.
- By using IBM z/OS Debugger Utilities option 6, "z/OS Debugger User Exit Data Set", as described in "Creating and managing the TEST runtime options data set by using z/OS Debugger Utilities" in the *IBM z/OS Debugger User's Guide*.
- By using the **z/OS Debugger Profiles** view. For more information, see the "Working with the z/OS Debugger Profiles view" topic in [IBM Documentation](#).
- By specifying a non-CICS profile in the z/OS Batch Application with existing JCL launch configuration. For more information, see the "Launching a debug session using existing JCL" topic in [IBM Documentation](#).
- By configuring the **Remote Profile** tab from Remote IMS Application with Isolation debug configurations.

---

## Chapter 9. Installing the browse mode RACF facility

z/OS Debugger browse mode can be controlled by either the browse mode RACF facility, through the EQAOPTS BROWSE command, or both. For an overview of browse mode and how to control it, see "Debugging in browse mode" in the *IBM z/OS Debugger User's Guide*.

If you want to use RACF to enforce one of the following situations, you must install the browse mode RACF facility:

- Debug programs in a production environment (or some other environment) where you want to control whether z/OS Debugger users can modify the contents of storage or alter program flow
- Restrict the use of z/OS Debugger to certain users

**Note:** If you have defined a generic Facility class profile (for example, \*.\*), you might have to install the browse mode RACF facilities described below, even if neither of the previous considerations apply. For example, if you have a generic Facility class profile of \*.\* with UACC (NONE) and you do not install the browse mode RACF facilities described below, no users would be allowed to use z/OS Debugger.

To install the browse mode RACF facility, your security administrator must do the following tasks:

1. Choose one or both RACF facilities associated with the browse mode facility to install, then install the chosen facilities.
2. Set up the default user access to the facility.
3. Authorize those users that need access other than the default access.

Refer to the following topics for more information related to the material discussed in this topic.

### Related tasks

["BROWSE" on page 141](#)

---

## Choose and install appropriate RACF facility

The following RACF facilities are associated with the browse mode facility:

- EQADTOOL.BROWSE.MVS
- EQADTOOL.BROWSE.CICS

You can install either or both facilities. The first facility controls browse mode for non-CICS MVS jobs. The second controls browse mode access in CICS regions.

In most cases, if you install the browse mode RACF facility, then specify UACC(READ). However, assigning *fac\_uacc* any of the following values creates the corresponding result:

### NONE

Only users specifically authorized to the facility (through *usr\_acc* of READ or higher) can use z/OS Debugger in any way.

### READ

Only users specifically authorized to the facility (through *usr\_acc* of UPDATE or higher) can use z/OS Debugger in the normal (non-browse mode) way.

### UPDATE

Users specifically authorized to the facility can be limited to using z/OS Debugger in browse mode but all other users can use z/OS Debugger in either the normal (non-browse mode) way or in browse mode, depending on the option specified for the EQAOPTS BROWSE command.

The following instructions use EQADTOOL.BROWSE.xxx to represent either or both of facilities. If you choose to install both, you need to run the steps twice, once with each name.

Do the following steps to install the browse mode facility:

1. Establish a profile for the browse mode facility in the FACILITY class by entering the following RDEFINE command:

```
RDEFINE FACILITY EQADT00L.BROWSE.xxx UACC(fac_uacc)
```

2. Verify that generic profile checking is in effect for the class FACILITY by entering the following command:

```
SETROPTS GENERIC(FACILITY)
```

## Set up user access to facility

---

When you assign *usr\_acc* any of the following values to grant access to a specific user, you create the corresponding result:

### **NONE**

The user cannot use z/OS Debugger in any way.

### **READ**

The user can use z/OS Debugger only in browse mode.

### **UPDATE (or higher)**

The user can use z/OS Debugger in the normal (non-browse) mode by default. He can also specify the EQAOPTS BROWSE command to specify that he wants the current invocation of z/OS Debugger to be in browse mode or normal mode.

Do the following steps to give individual users or user groups specific access to the browse mode facility:

1. Give a user permission to use the browse mode facility by entering the following command, where *DUSER1* is the name of a RACF-defined user or group profile:

```
PERMIT EQADT00L.BROWSE.xxx CLASS(FACILITY) ID(DUSER1) ACCESS(usr_acc)
```

Instead of connecting individual users, the security administrator can specify *DUSER1* to be a RACF group profile and then connect authorized users to the group.

2. If the FACILITY class is not active, activate the class by entering the SETROPTS command:

```
SETROPTS CLASSACT(FACILITY)
```

Issue the SETROPTS LIST command to verify that FACILITY class is active.

3. Refresh the FACILITY class by issuing the SETROPTS RACLIST command:

```
SETROPTS RACLIST(FACILITY) REFRESH
```



---

## Chapter 10. Customizing IBM z/OS Debugger Utilities

**Note:** This chapter is not applicable to IBM Developer for z/OS (non-Enterprise Edition) or IBM Wazi Developer for Red Hat CodeReady Workspaces.

IBM z/OS Debugger Utilities is a group of ISPF applications that provide the following tools and functions:

- **Program Preparation** to help application programmers precompile, compile, and link their programs and then start z/OS Debugger. This includes using COBOL and CICS Command Level Conversion Aid (CCCA) to help application programmers convert older COBOL programs to Enterprise COBOL programs.
- **z/OS Debugger Setup File**, which manages setup files. Setup files help application programmers prepare programs to debug them interactively or in batch mode.
- **IMS TM Debugging** to help users edit the TEST runtime options that IMS programs use and to create private message regions for testing.

The functions include the IMS Transaction Isolation facility, which allows users to select IMS transactions to debug in a private message-processing region.

These functions also allow users to manage IMS message region templates. Message region templates are superseded by the IMS Transaction Isolation facility, and will be removed in a future release of z/OS Debugger.

- **Load Module Analyzer** to help users analyze load modules to determine the language translator that was used to compile or assemble each CSECT in the load module.
- **z/OS Debugger User Exit Data Set** to create and edit a data set that Language Environment user exits read to obtain the TEST runtime options string.
- **Other IBM Application Delivery Foundation for z/OS tools** to help users start IBM File Manager for z/OS.
- **JCL for Batch Debugging** to help users start a debug session when they run their application in a batch job.
- **IMS BTS Debugging** to help users start a debug session when they run their IMS BTS applications.
- **Delay Debug Profile** to create a delay debug profile data set that the z/OS Debugger delay debug pattern matching uses to start a debug session.
- **IMS Transaction and User ID Cross Reference Table** to create a cross reference table entry that z/OS Debugger uses to associate a user ID to an IMS transaction.
- **Non-CICS Debug Session Start and Stop Message Viewer** to browse debug session start and stop messages.
- **z/OS Debugger Code Coverage** to specify code coverage options, observation selections, and do viewing and reporting.
- **z/OS Debugger Deferred Breakpoints** to create and view a list of breakpoints prior to starting the debug session. It reduces the time spent on the debugging session and also the system resource usage.
- **z/OS Debugger JCL Wizard** is an ISPF edit macro (EQAJCL) that allows you to modify a JCL or procedure member and create statements to invoke z/OS Debugger in various environments.

The instructions in this section describe the following customization tasks:

- Choose a method to start IBM z/OS Debugger Utilities
- Customize the data set names in EQASTART.
- Add IBM z/OS Debugger Utilities to an ISPF menu so that your users can start IBM z/OS Debugger Utilities from an ISPF menu.
- Modify z/OS Debugger Setup Utility so that your users can access procedure libraries.
- Customize the JCL for Batch Debugging interface.
- Customize the Other IBM Application Delivery Foundation for z/OS tools interface.

- Customize Program Preparation so that users access the proper compilers and development utilities.
- If your users use the IMS TM Setup - Manage LE Runtime Options function in IBM z/OS Debugger Utilities, make changes so that users can access this function in an IMSplex environment.
- If your users use IMS message region templates to dynamically swap transaction class and debug in a private message region, customize the IMS message region templates.
- Customize IMS BTS Debugging with default values for the TEST runtime option and data set names for the z/OS Debugger load module, user exit module, debug information files, IMS subsystem IDs, and base JCLs.
- Customize the z/OS Debugger User Exit Data Set utility.
- Customize the Delay Debug Profile utility.
- Customize the IMS Transaction and User ID Cross Reference Table utility.
- Customize the Non-CICS Debug Session Start and Stop Message Viewer utility.
- Customize z/OS Debugger Code Coverage.
- Install and customize z/OS Debugger JCL Wizard.

## Choosing a method to start IBM z/OS Debugger Utilities

Your users can start IBM z/OS Debugger Utilities by doing one of the following methods:

**Method 1:** Enter the EXEC 'hlq.SEAEXEC(EQASTART)' command. This is the default method.

**Method 2:** Enter the EQASTART command. To use this method, you must do the following steps, which are described in this section:

1. Include or copy the IBM z/OS Debugger Utilities and Common Components data sets to your system's TSO logon data sets. To add the data sets, do one of the following alternatives:
  - Include the data sets listed in [Table 15 on page 70](#), [Table 16 on page 71](#), or [Table 17 on page 71](#) into the DD concatenations specified in the tables.
  - Copy<sup>5</sup> the members of the data sets listed in [Table 15 on page 70](#), [Table 16 on page 71](#), or [Table 17 on page 71](#) to a data set allocated to the DD concatenation specified in the table.

For either alternative, the data sets you include into the DD concatenations must match the national language you chose in [“Changing the default and allowable values in EQACUIDF” on page 129](#).
2. Edit the EQASTART<sup>6</sup> member of the hlq.SEAEXEC data set and set the *Inst\_NATLANG\_commonlib* variable to ENU, UEN, JPN, or KOR depending on the national language you chose in [“Changing the default and allowable values in EQACUIDF” on page 129](#).
3. Inform your users how to specify a language other than the one selected in step “2” on page 70. If your users need to start z/OS Debugger in a language other than the default, they need to add the NATLANG(*xxx*) parameter to the EQASTART command.

| DD concatenation   | Data set names               |
|--------------------|------------------------------|
| SYSEXEC or SYSPROC | hlq.SEAEXEC                  |
| ISPMLIB            | hlq.SEAMENU and hlq.SIPVMENU |
| ISPLLIB            | hlq.SEAMOD and hlq.SIPVMODA  |
| ISPPLIB            | hlq.SEAPENU and hlq.SIPVPENU |
| ISPSLIB            | hlq.SEASENU                  |
| ISPTLIB            | hlq.SEATLIB and hlq.SIPVTENU |

<sup>6</sup> See "SMP/E USERMODs" in the *IBM z/OS Debugger Customization Guide* for an SMP/E USERMOD for this customization.

Table 16. For uppercase English, data sets that need to be included or copied into the specified DD concatenations

| DD concatenation   | Data set names                                |
|--------------------|-----------------------------------------------|
| SYSEXEC or SYSPROC | <i>hlq</i> .SEQAEXEC                          |
| ISPMLIB            | <i>hlq</i> .SEQAMENP and <i>hlq</i> .SIPVMENU |
| ISPLLIB            | <i>hlq</i> .SEQAMOD and <i>hlq</i> .SIPVMODA  |
| ISPPLIB            | <i>hlq</i> .SEQAPENP and <i>hlq</i> .SIPVPENU |
| ISPSLIB            | <i>hlq</i> .SEQASENP                          |
| ISPTLIB            | <i>hlq</i> .SEQATLIB and <i>hlq</i> .SIPVTENU |

**Note:** ADFz Common Components does not have an upper English set of ISPF data sets.

Table 17. For Japanese, data sets that need to be included or copied into the specified DD concatenations

| DD concatenation   | Data set names                                |
|--------------------|-----------------------------------------------|
| SYSEXEC or SYSPROC | <i>hlq</i> .SEQAEXEC                          |
| ISPMLIB            | <i>hlq</i> .SEQAMJPN and <i>hlq</i> .SIPVMJPN |
| ISPLLIB            | <i>hlq</i> .SEQAMOD and <i>hlq</i> .SIPVMODA  |
| ISPPLIB            | <i>hlq</i> .SEQAPJPN and <i>hlq</i> .SIPVPJPN |
| ISPSLIB            | <i>hlq</i> .SEQASJPN                          |
| ISPTLIB            | <i>hlq</i> .SEQATLIB and <i>hlq</i> .SIPVTJPN |

Table 18. For Korean, data sets that need to be included or copied into the specified DD concatenations

| DD concatenation   | Data set names                                |
|--------------------|-----------------------------------------------|
| SYSEXEC or SYSPROC | <i>hlq</i> .SEQAEXEC                          |
| ISPMLIB            | <i>hlq</i> .SEQAMKOR and <i>hlq</i> .SIPVMKOR |
| ISPLLIB            | <i>hlq</i> .SEQAMOD and <i>hlq</i> .SIPVMODA  |
| ISPPLIB            | <i>hlq</i> .SEQAPKOR and <i>hlq</i> .SIPVPKOR |
| ISPSLIB            | <i>hlq</i> .SEQASKOR                          |
| ISPTLIB            | <i>hlq</i> .SEQATLIB and <i>hlq</i> .SIPVTKOR |

## Customizing the data set names in EQASTART

You must modify member EQASTART of the *hlq*.SEQAEXEC data set to specify the data set names that you chose at installation time. Edit the EQASTART<sup>7</sup> member and follow the directions in the member's prologue for site customization of data set names.

<sup>7</sup> See "SMP/E USERMODs" in the *IBM z/OS Debugger Customization Guide* for an SMP/E USERMOD for this customization.

## Adding IBM z/OS Debugger Utilities to the ISPF menu

To add IBM z/OS Debugger Utilities to an ISPF panel, add code that calls EQASTART to an existing panel. For example, to add IBM z/OS Debugger Utilities to the ISPF Primary Option Menu panel (ISR@PRIM), insert the additional lines (**←New**) as shown below:

```
...
)BODY CMD(ZCMD)
...
9 IBM Products IBM program development products
10 SCLM SW Configuration Library Manager
11 Workplace ISPF Object/Action Workplace
F File Manager File Manager for z/OS
D z/OS Debugger JCL
Wizard - z/OS Debugger JCL
Wizard Utility functions ←New
...
)PROC
...
&ZSEL; = TRANS(TRUNC (&ZCMD;,'. '))
...
9, 'PANEL(ISRDIIS) ADDPOP '
10, 'PGM(ISRSCLM) SCRNAME(SCLM) NOCHECK '
11, 'PGM(ISRUDA) PARM(ISRWORK) SCRNAME(WORK) '
F, 'PANEL(FMNSTASK) SCRNAME(FILEMGR) NEWAPPL(FMN) ' /* File Manager */
D, 'CMD(EXEC 'h1q.SEQAEEXEC(EQASTART)')' /* z/OS Debugger JCL
Wizard Utilities */ ←1
...
```

If you copied IBM z/OS Debugger Utilities to system data sets or concatenated them to existing DD names (as described in [Method 2](#) in “Choosing a method to start IBM z/OS Debugger Utilities” on page 70), then change line **1** to the following:

```
 D, 'CMD(%EQASTART)' /* z/OS Debugger JCL
Wizard Utilities */
```

For more information about configuring your ISPF Primary Option Menu panel, see *z/OS ISPF Planning and Customizing*.

## Customizing z/OS Debugger Setup Utility

z/OS Debugger Setup Utility provides a command called COPY, which copies a JCL stream into a setup file. The EQAZPROC member of the *h1q.SEQATLIB* data set includes a list of JCL procedure libraries that z/OS Debugger Setup Utility uses as a source for the COPY command. You can add your own procedure libraries to the list by editing EQAZPROC and adding the procedure library names, one name per line and without trailing commas, beginning on column 1. The order in which you list procedure libraries in EQAZPROC must match the order in which you list procedure libraries in the PROCLIB concatenation.

For example, to add the LOCAL.PROCLIB procedure library name, do the following steps:

1. Edit the EQAZPROC<sup>8</sup> member of the *h1q.SEQATLIB* data set.
2. Add the LOCAL.PROCLIB procedure library name. The result looks like the following:

```
LOCAL.PROCLIB
SYS1.PROCLIB
```

3. Save and close the file.

## Customizing for JCL for Batch Debugging utility

The JCL for Batch Debugging utility helps your users prepare JCL and start a debug session. You can supply your users with a number of default values.

<sup>8</sup> See "SMP/E USERMODS" in the *IBM z/OS Debugger Customization Guide* for an SMP/E USERMOD for this customization.

To set the defaults, do the following steps:

1. Edit the EQAZDFLT<sup>9</sup> member of the *hlq*.SEQATLIB data set.
2. Modify the parameter values to match what you use at your site.
3. Add parameters required by your site. You can add parameters by doing one of the following alternatives:
  - Use the INCLUDE *'any.data.set.name'*; statement to include statements from a data set that you created.
  - Use the INCLUDE *membername*; statement to include parameters from other members in the data set *hlq*.SEQATLIB.

See the EQAZDSYS member of the *hlq*.SEQATLIB data set for the complete list of parameters and the syntax convention for these parameters.

If your users use terminals that cannot display mixed-case English text, enter all parameters in uppercase English.

## Parameters you can set

The first 3 characters of each parameter are "yb1". The last five characters correspond to the parameter:

### **yb1dtmod**

z/OS Debugger load module data set (SEQAMOD).

### **yb1dtflg**

Flag to include z/OS Debugger load module data set in STEPLIB. Y for Yes, N for No.

If it is No, the installer must ensure that SEQAMOD can be found in the load module search path.

### **yb1dtdev**

Debug session type: MFI, TIM, or GUI.

#### **MFI**

dedicated terminal identified by network and LU names.

#### **TIM**

terminal identified by user id.

#### **GUI**

Remote debugger identified by IP address.

### **yb1dtmtd**

z/OS Debugger invocation method: C, E or A.

#### **C**

CEEOPTS DD statement. This requires z/OS Version 1.7 or later.

#### **E**

User exit module EQAD3CXT in Language Environment CEEBINIT module. For instructions on how to implement this method, see Chapter 8, "[Specifying the TEST runtime options through the Language Environment user exit,](#)" on page 61.

#### **A**

User exit module EQAD3CXT in application module.

### **yb1dtprf**

Data set that contains a z/OS Debugger preferences file.

### **yb1dtcmd**

Data set that contains a z/OS Debugger commands file.

---

<sup>9</sup> See "SMP/E USERMODS" in the *IBM z/OS Debugger Customization Guide* for an SMP/E USERMOD for this customization.

### **yb1dtbin**

The name of the Language Environment SCEERUN(CEEBINIT) load module data set that contains the z/OS Debugger user exit module EQAD3CXT. To make sure you provide the correct name, see [Chapter 8, “Specifying the TEST runtime options through the Language Environment user exit,” on page 61.](#)

### **yb1dtnmp**

Naming pattern that identifies the z/OS Debugger user's data set which contains the TEST runtime options and pattern matching information. The naming pattern must be the same as the one coded in the z/OS Debugger user exit module EQAD3CXT. To make sure you provide the correct naming pattern, see [Chapter 8, “Specifying the TEST runtime options through the Language Environment user exit,” on page 61.](#)

### **yb1dtdfl**

Debug information file. It contains a list of data sets of debug information, source, and listing files.

## **Customizing JCL for Batch Debugging for multiple systems**

You can customize JCL for Batch Debugging utility for multiple systems by doing one of the following alternatives:

- Modify EQASTART<sup>10</sup> to use a fully qualified data set name or member name other than EQAZDFLT to start IBM z/OS Debugger Utilities.
- Instruct your users to enter one of the following commands, depending on the customization they want to use:
  - EXEC 'hlq.SEQAEXEC(EQASTART)' 'PUMEMBER(''data.set.name'')
  - EXEC 'hlq.SEQAEXEC(EQASTART)' 'PUMEMBER(membername)'

## **Customizing for Other IBM Application Delivery Foundation for z/OS tools**

Other IBM Application Delivery Foundation for z/OS tools allows your users to access other Application Delivery Foundation for z/OS tools. You can supply your users with parameter values needed for accessing the tools.

To give users access to the proper tools:

1. Edit the EQAZDFLT<sup>11</sup> member of the hlq.SEQATLIB data set.
2. Modify the data set names to match what you use at your site.
3. Add parameters required by your site. You can add parameters by doing one of the following alternatives:
  - Use the INCLUDE 'any.data.set.name'; statement to include statements from a data set that you created.
  - Use the INCLUDE membername; statement to include parameters from other members in the data set hlq.SEQATLIB.

See the EQAZDSYS and EQAZDUSR members of the hlq.SEQATLIB data set for the complete list of parameters and the syntax convention for these parameters.

If your users use terminals that cannot display mixed-case English text, enter all parameters in uppercase English.

<sup>10</sup> See "SMP/E USERMODS" in the *IBM z/OS Debugger Customization Guide* for an SMP/E USERMOD for this customization.

<sup>11</sup> See "SMP/E USERMODS" in the *IBM z/OS Debugger Customization Guide* for an SMP/E USERMOD for this customization.

## Parameters you can set

The first two characters of each parameter are always 'pt'. The third character corresponds to the tool:

### 1

IBM File Manager parameters

The last five characters correspond to the parameter:

### flg1

Base function availability flag: Yes or No.

### flg2

Db2 function availability flag: Yes or No.

### flg3

IMS function availability flag: Yes or No.

### tfl

Title for the tool.

### elib

ISPF EXEC library data set.

### mllb

ISPF message library data set.

### pllb

ISPF panel library data set.

### slib

ISPF skeleton library data set.

### tlb

ISPF table library data set.

### pnl1

ISPF panel name for the base function.

### pnl2

ISPF panel name for the Db2 function.

### pnl3

ISPF panel name for the IMS function.

## Customizing Other IBM Application Delivery Foundation for z/OS tools for multiple systems

You can customize Other IBM Application Delivery Foundation for z/OS tools for multiple systems by doing one of the following alternatives:

- Modify EQASTART<sup>12</sup> to use a fully qualified data set name or member name other than EQAZDFLT to start IBM z/OS Debugger Utilities.
- Instruct your users to enter one of the following commands, depending on the customization they want to use:

```
- EXEC 'hlq.SEQAEXEC(EQASTART)' 'PUMEMBER(''data.set.name'')
```

```
- EXEC 'hlq.SEQAEXEC(EQASTART)' 'PUMEMBER(membername)'
```

<sup>12</sup> See "SMP/E USERMODS" in the *IBM z/OS Debugger Customization Guide* for an SMP/E USERMOD for this customization.

## Customizing Program Preparation

Program Preparation helps your users access the proper compilers and development utilities that are installed at your site. You can supply your users with default values for data set naming patterns, data set allocation parameters, and compiler and utility option strings.

To give users access to the proper compilers and development utilities, do the following steps:

1. Edit the EQAZDFLT<sup>13</sup> member of the `hlq.SEQATLIB` data set.
2. Modify the data set names to match what you use at your site.
3. Add parameters required by your site. You can add parameters by doing one of the following alternatives:
  - Use the `INCLUDE 'any.data.set.name'` ; statement to include statements from a data set that you created.
  - Use the `INCLUDE membername` ; statement to include parameters from other members in the data set `hlq.SEQATLIB`.

See the EQAZDSYS and EQAZDUSR members of the `hlq.SEQATLIB` data set for the complete list of parameters and the syntax convention for these parameters.

If your users use terminals that cannot display mixed-case English text, you must enter all parameters in uppercase English.

If your site uses CCCA and requires that you use the VOLUMES parameter when you define private data sets (for example, a cluster is not managed by SMS), you must include the VOLUMES parameter when you define private data sets. Modify the following variables to include the VOLUMES parameter:

- `yccctl1`
- `ycclcpa1`
- `yccchga1`
- `ycclrka1`
- `ycctkna1`

The following example illustrates how the variable `yccctl1` is modified to include the parameter `VOLUMES(SYS166)`:

```
yccctl1 = ! CONTROL FILE KSDS
 RECORDS(10000 1000)
 FREESPACE(30 30)
 INDEXED
 SPEED
 CISZ(4096)
 UNIQUE
 KEYS(15 0)
 VOLUMES(SYS166)
 RECORDSIZE(188 188);
```

### Parameters you can set

The first two characters of each parameter are always 'yc'. The third character corresponds to the compiler or development utility parameters:

- 1** COBOL compiler parameters
- 3** PL/I compiler parameters

<sup>13</sup> See "SMP/E USERMODS" in the *IBM z/OS Debugger Customization Guide* for an SMP/E USERMOD for this customization.



**4**

C and C++ compiler parameters

**5**

Assembler parameters

**6**

Enterprise COBOL for z/OS Version 5 compiler parameters

**L**

Link Edit parameters

**c**

CCCA parameters

**F**

Fault Analyzer parameters

**G**

Fault Analyzer listing create parameters

### **Db2 and CICS parameters**

The Db2 precompiler and CICS translator are listed by the compiler you use. You can specify a different Db2 precompiler or CICS translator for each compiler.

The last five characters correspond to the parameter:

#### **ciclb**

LINKLIST or load module data set name for CICS translator.

#### **cicmd**

Load module name for CICS translator.

#### **cicps**

CICS translator options.

#### **clib**

LINKLIST or load module data set name for the compiler.

#### **cmod**

Load module name for the compiler or utility.

#### **cobv**

Enterprise COBOL for z/OS Version 5 or later.

#### **ctovr**

TEST compiler option override flag. Use this flag to allow or disallow the TEST or DEBUG compiler option specified in the ctst, ctst1, ctst2, ctst3, ctst4, or ctst5 parameters to be overridden by the settings in the user profile. This parameter is valid for the COBOL compiler, PL/I compiler, and C and C++ compiler.

#### **ctst**

Use TEST, NOTEST, DEBUG, or NODEBUG as the main compiler debugging option. This parameter is valid for the COBOL compiler, PL/I compiler, and C and C++ compiler.

#### **ctst1, ctst2, ctst3, ctst4, ctst5**

TEST or DEBUG suboptions. These parameters are valid for the COBOL compiler, PL/I compiler, and C and C++ compiler.

#### **cttl**

Title for the compiler.

#### **db2lb**

LINKLIST or load module data set name for the Db2 precompiler.

#### **db2md**

Load module name for Db2 precompiler.

#### **db2ps**

Db2 precompiler options.

**flg**

Enable or disable the compiler or development utility.

**lsta1**

Parameters of the TSO ALLOCATE command to use when data sets for compiler listings are allocated.

**lstat**

Data set type for the compiler listing. The type can be one of these values: PDSE, PDS, or SEQ.

**lstxx**

Pattern to use to create a name for the compiler listing data set. The name is created by using the characters in the pattern. The special characters, which start with a slash (/), are replaced by the following values:

**/1, /2, ..., /n**

The nth qualifier of the fully qualified data set name that was used as input to the compiler.

**/B**

The second to (n-1) qualifier of the fully qualified data set name that was used as input to the compiler.

**/L**

The right-most qualifier of the fully qualified data set name that was used as input to the compiler.

**/M**

The member name of the data set name that was used as input to the compiler.

**/U**

Current TSO user ID.

**/P**

Current TSO profile prefix.

**sds1**

Shared data set prefix for CCCA.

**svs1**

Shared VSAM data set prefix for CCCA.

**tmpa1**

Parameters of the TSO ALLOCATE command to use when temporary data sets are allocated.

## Customizing Program Preparation for multiple systems

You can customize Program Preparation for multiple systems by doing one of the following alternatives:

- Modify EQASTART<sup>14</sup> to use a fully qualified data set name or member name other than EQAZDFLT to start IBM z/OS Debugger Utilities.
- Instruct your users to enter one of the following commands, depending on the customization they want to use:

```
- EXEC 'hlq.SEQAEXEC(EQASTART)' 'PUMEMBER('any.data.set.name')'
```

```
- EXEC 'hlq.SEQAEXEC(EQASTART)' 'PUMEMBER(membername)'
```

## Configuring for IMSplex users

To determine if you need to do the steps described in this topic, read "Preparing IMS programs" in the *IBM z/OS Debugger User's Guide*. If your users use the **IMS TM Setup - Manage LE Runtime Options** function in z/OS Debugger Utilities, you must do the following tasks:

1. Install and configure IMS Version 8 or later as an IMSplex. See *IMS Version 8: Administration Guide: System* for information about configuring an IMSplex.

<sup>14</sup> See "SMP/E USERMODS" in the *IBM z/OS Debugger Customization Guide* for an SMP/E USERMOD for this customization.

2. Include the IMS RESLIB load library, which is located in the *hlq*.SDFSRESL data set, in the standard search path for load modules used by your users. *hlq* is the high level qualifier of IMS installed on your system.

If you do not include the IMS load library in the search path, your users will see one or both of the following messages and they will not be able to use the **IMS TM Setup - Manage LE Runtime Options** function in IBM z/OS Debugger Utilities:

- EQAZ60E REXX IMS SPOC environment is not available. Return Code = nnn
- IKJ56500I COMMAND CSLULXSB NOT FOUND

## Customizing debugging by using IMS message region templates

To determine whether you need to complete the steps described in this topic, read *Using IMS message region templates to dynamically swap transaction class and debug in a private message region* in the *IBM z/OS Debugger User's Guide*. If you use the IMS TM Setup - Swap IMS Transaction Class and Run Transaction function in IBM z/OS Debugger Utilities, you must complete the following tasks:

1. Edit the EQAZDFLT<sup>15</sup> member of the *hlq*.SEQATLIB data set.
2. Specify a default data set name to store IMS message region templates by setting the *imstmpds* parameter value. If the data set does not exist, allocate it with the following attributes:
  - Data set type LIBRARY (PDSE).
  - RECFM=VB, LRECL=1280, and BLKSIZE=27998.
  - Not an HFS or zFS file.
3. Specify default job names for the three jobs that the Dynamically Swap IMS Transaction Class and Run Transaction function will start, by setting the following parameter values. The string `&&user&&` is replaced with up to the first 7 characters of the IBM z/OS Debugger Utilities user's TSO ID.

### **mprdebug**

Job name for the private message region that is started to debug the user's transaction. The default value for this parameter is `@&&user&&`.

### **mprnodbg**

Job name for the private message region that is started with the debug private message region with the NOTEST parameter. This region processes all messages for the selected transaction that are scheduled, when the initial message to the transaction is being debugged at the same time. This enables users to interrupt debugging to continue running the transaction.

The default value for this parameter is `#&&user&&`.

### **mprbmp**

Job name for the batch job that is submitted to run the EQANBSWT Batch Message Processing (BMP) program. The default value for this parameter is `$&&user&&`.

4. Customize the data sets that the EQANBSWT program will use by setting the appropriate parameters. For a list of all of the parameters that you can specify, see section *Option 4: IMS TM Debugging* in the EQAZDSYS member of *hlq*.SEQATLIB. You can set the following parameters:

### **us5imrsl**

Specify the IMS RESLIB load library when you start EQANBSWT. This is the first data set in the STEPLIB concatenation for the BMP. This parameter is required. The default value is IMS.SDFSRESL.

### **us5dtmod**

Specify the z/OS Debugger SEQAMOD load library when you start EQANBSWT. This is in the STEPLIB concatenation for the BMP. This parameter is optional.

---

<sup>15</sup> See "SMP/E USERMODS" in the *IBM z/OS Debugger Customization Guide* for an SMP/E USERMOD for this customization.

### us5dtce1

Specify the Language Environment SCEERUN load library when you start EQANBSWT. This is the STEPLIB concatenation for the BMP. This parameter is optional.

### us5slbnn

Add DD cards to the STEPLIB concatenation for the EQANBSWT BMP job. The cards must be complete lines of JCL and will be displayed in the STEPLIB after the IMS RESLIB specification and before the z/OS Debugger load library and Language Environment load library, if specified.

*nn* is a number in the range 01 - 09.

5. Complete the steps for “Scenario E: Enabling users to launch private message regions and to assign transactions to private message regions” on page 114.

## Customizing z/OS Debugger User Exit Data Set

The z/OS Debugger User Exit Data Set utility creates a user exit data set that is used by the z/OS Debugger Language Environment user exit to start a debug session. You can set the default value of the data set naming pattern for the users by taking the following steps:

1. Review the parameter described in [Table 19 on page 80](#). Verify that you have all the information to specify the value for the parameter. See the EQAZDSYS member of the *h1q*.SEQATLIB data set for the parameter and the syntax convention.
2. Edit the EQAZDSYS<sup>16</sup> member of the *h1q*.SEQATLIB data set. Modify the parameter required by your site. You can add parameters by doing one of the following alternatives:
  - Use the INCLUDE *'any.data.set.name'*; statement to include statements from a data set that you created.
  - Use the INCLUDE *membername*; statement to include parameters from other members in the *h1q*.SEQATLIB data set.

If your application programmers use terminals that cannot display text in mixed-case English, enter parameters and their values in uppercase English.

See Chapter 8, “Specifying the TEST runtime options through the Language Environment user exit,” on page 61 for how the user exit data set is used.

| Name of parameter | Description                                                                                                                                                                                                                                                                                                                                                                                                                                                                                                                                                                                                                                                                                                 |
|-------------------|-------------------------------------------------------------------------------------------------------------------------------------------------------------------------------------------------------------------------------------------------------------------------------------------------------------------------------------------------------------------------------------------------------------------------------------------------------------------------------------------------------------------------------------------------------------------------------------------------------------------------------------------------------------------------------------------------------------|
| uepnmp            | <p>The naming pattern of the user exit data set.</p> <p>The utility builds a data set name by using the naming pattern that is used when the option is selected for the first time. The data set name and modification (if user modifies it) are consistent across the IBM z/OS Debugger Utilities sessions.</p> <p>The following list describes the rules of using the token:</p> <ul style="list-style-type: none"><li>• The &amp;USERID token is replaced with the value from the SYSPREF or SYSUID system variable.</li><li>• The &amp;PGMNAME token is not supported.</li><li>• If the parameter does not exist, the default naming pattern is used:</li></ul> <pre>&amp;USERID.DBGTOOL.EQAUOPTS</pre> |

<sup>16</sup> See "SMP/E USERMODS" in the *IBM z/OS Debugger Customization Guide* for an SMP/E USERMOD for this customization.

## Customizing IMS BTS Debugging

The IMS BTS Debugging utility of IBM z/OS Debugger Utilities helps your users prepare a BTS JCL and start a debug session in the foreground or in batch. You can supply your users with default values for the TEST runtime option and data set names for the z/OS Debugger load module, user exit module, debug information files, IMS subsystem IDs and base JCLs.

To set the defaults, do the following steps:

1. Review the parameters described in [Table 20 on page 81](#). Verify that you have all the information you need to specify values for each parameter. You can also view a complete list of parameters and the syntax convention for these parameters in the EQAZDSYS member of the *hlq*.SEQATLIB data set.
2. Edit the EQAZDSYS<sup>17</sup> member of the *hlq*.SEQATLIB data set. Modify the parameters required by your site. You can add parameters by doing one of the following alternatives:
  - Use the INCLUDE 'any.data.set.name'; statement to include statements from a data set that you created.
  - Use the INCLUDE membername; statement to include parameters from other members in the data set *hlq*.SEQATLIB.

If your application programmers use terminals that cannot display text in mixed-case English, enter all parameters and their values in uppercase English.

Table 20. Parameters you can define for the IMS BTS Debugging option of IBM z/OS Debugger Utilities.

| Name of parameter | Description                                                                                                                                                                                                                                                                                                                                                                                                                                                                                                                                                                                                                                                                                                                                                                                                                                                                                                                                                                                                                                                                                                                                                                                                                                            |
|-------------------|--------------------------------------------------------------------------------------------------------------------------------------------------------------------------------------------------------------------------------------------------------------------------------------------------------------------------------------------------------------------------------------------------------------------------------------------------------------------------------------------------------------------------------------------------------------------------------------------------------------------------------------------------------------------------------------------------------------------------------------------------------------------------------------------------------------------------------------------------------------------------------------------------------------------------------------------------------------------------------------------------------------------------------------------------------------------------------------------------------------------------------------------------------------------------------------------------------------------------------------------------------|
| yb2dtmod          | The name of the data set that contains the z/OS Debugger load modules, SEQAMOD.                                                                                                                                                                                                                                                                                                                                                                                                                                                                                                                                                                                                                                                                                                                                                                                                                                                                                                                                                                                                                                                                                                                                                                        |
| yb2dtce1          | The name of the data set that contains Language Environment runtime library, SCEERUN1.                                                                                                                                                                                                                                                                                                                                                                                                                                                                                                                                                                                                                                                                                                                                                                                                                                                                                                                                                                                                                                                                                                                                                                 |
| yb2dtce2          | The name of the data set that contains Language Environment runtime library, SCEERUN2.                                                                                                                                                                                                                                                                                                                                                                                                                                                                                                                                                                                                                                                                                                                                                                                                                                                                                                                                                                                                                                                                                                                                                                 |
| yb2dtbin          | The name of the data set that contains the CEEBINIT load module.                                                                                                                                                                                                                                                                                                                                                                                                                                                                                                                                                                                                                                                                                                                                                                                                                                                                                                                                                                                                                                                                                                                                                                                       |
| yb2dtnmp          | The naming pattern you stored in EQAD3CXT when you completed the instructions in “Modifying the naming pattern” on page 62. If you modify the naming pattern stored in EQAD3CXT, you must modify this parameter to match.                                                                                                                                                                                                                                                                                                                                                                                                                                                                                                                                                                                                                                                                                                                                                                                                                                                                                                                                                                                                                              |
| yb2dtdev          | <p>The interface type that application programmers should use to debug IMS BTS programs. You can specify one of the following values:</p> <p><b>MFI</b><br/>Interact with z/OS Debugger in full-screen mode or full-screen mode using a dedicated terminal without Terminal Interface Manager (TIM). If application programmers are using full-screen mode using a dedicated terminal without Terminal Interface Manager, they identify the terminal by network and LU names, as described in <a href="#">Appendix B, “Enabling debugging in full-screen mode using a dedicated terminal,”</a> on page 173.</p> <p><b>TIM</b><br/>Interact with z/OS Debugger in full-screen mode or full-screen mode using the Terminal Interface Manager (TIM). The application programmer identifies the terminal by user ID, as described in <a href="#">“How users start a full-screen mode debug session with the Terminal Interface Manager”</a> on page 17. Make sure you complete the instructions in <a href="#">“Enabling full-screen mode using the Terminal Interface Manager”</a> on page 19.</p> <p><b>GUI</b><br/>Interact with z/OS Debugger in remote debug mode, where the application programmer identifies the remote debugger by IP address.</p> |

<sup>17</sup> See “SMP/E USERMODS” in the *IBM z/OS Debugger Customization Guide* for an SMP/E USERMOD for this customization.

Table 20. Parameters you can define for the IMS BTS Debugging option of IBM z/OS Debugger Utilities. (continued)

| Name of parameter | Description                                                                                                                                                                                                                                                                                                                                                                                                                                                                                      |
|-------------------|--------------------------------------------------------------------------------------------------------------------------------------------------------------------------------------------------------------------------------------------------------------------------------------------------------------------------------------------------------------------------------------------------------------------------------------------------------------------------------------------------|
| yb2dtmtd          | <p>The method that application programmers should use to start z/OS Debugger. You can specify one of the following values:</p> <p><b>C</b><br/>The application programmer specifies the CEEOPTS DD statement. You must run z/OS, Version 1.7, or later to use this option.</p> <p><b>E</b><br/>The application programmer specifies the EQAD3CXT user exit.</p>                                                                                                                                  |
| yb2dtpfrf         | <p>The name of the data set that contains the preferences file. If your site does not use a preferences files, you can leave this field blank.</p>                                                                                                                                                                                                                                                                                                                                               |
| yb2dtcmd          | <p>The name of the data set that contains the commands file. If your site does not use a commands files, you can leave this field blank.</p>                                                                                                                                                                                                                                                                                                                                                     |
| yb2dtufl          | <p>The name of a data set containing a list of data set names to be allocated by EQADEBUG DD statements.</p>                                                                                                                                                                                                                                                                                                                                                                                     |
| yb2dtued          | <p>The name of a data set containing the EQAUEDAT load module.</p>                                                                                                                                                                                                                                                                                                                                                                                                                               |
| yb2imsnm          | <p>The number of IMS subsystems that the application programmers can use to run or debug IMS applications. The maximum value is 12.</p>                                                                                                                                                                                                                                                                                                                                                          |
| yb2iidn           | <p>For each IMS subsystem, create a copy of this parameter and assign <i>n</i> a unique number between 1 and 12. For example, if your site has two IMS subsystems, you create yb2iid1 and yb2iid2 and assign each parameter a unique IMS system name.</p>                                                                                                                                                                                                                                        |
| yb2bmpn           | <p>For each IMS subsystem, create a copy of this parameter and assign <i>n</i> a unique number between 1 and 12 and specify the member name of a JCL that your site uses as a base or template JCL for batch message processing (BMP) programs. Edit the EQABMPSM<sup>1</sup> member of <i>hlg</i>. SEQATLIB, then copy it to a new name (for example, BMPJCL1). For example, if your site has two IMS subsystems, you create yb2bmp1 and yb2bmp2 and assign each parameter the member name.</p> |
| yb2dbbn           | <p>For each IMS subsystem, create a copy of this parameter and assign <i>n</i> a unique number between 1 and 12 and the member name of a JCL that your site uses as a base or template JCL for Data Language/I (DL/I) programs. Edit the EQADBBSM<sup>1</sup> member of <i>hlg</i>. SEQATLIB, then copy it to a new name (for example, DBBJCL1). For example, if your site has two IMS subsystems, you create yb2dbb1 and yb2dbb2 and assign each parameter the member name.</p>                 |
| yb2dlin           | <p>For each IMS subsystem, create a copy of this parameter and assign <i>n</i> a unique number between 1 and 12 and the member name of a JCL that your site uses as a base or template JCL for Data Language/I (DL/I) programs. Edit the EQADLISM<sup>1</sup> member of <i>hlg</i>. SEQATLIB, then copy it to a new name (for example, DLIJCL1). For example, if your site has two IMS subsystems, you create yb2dli1 and yb2dli2 and assign each parameter the member name.</p>                 |

**Note:**

1. See "[SMP/E USERMODs](#)" for an SMP/E USERMOD for this customization.

## Customizing Delay Debug Profile

The Delay Debug Profile utility creates a delay debug profile data set that is used by the z/OS Debugger delay debug pattern matching to start a debug session. You can set the default value of the data set naming pattern for the users by taking the following steps:

1. Review the parameter described in [Table 21 on page 83](#). Verify that you have all the information to specify the value for the parameter. See the EQAZDSYS member of the *hlq*.SEQATLIB data set for the parameter and the syntax convention.
2. Edit the EQAZDSYS<sup>18</sup> member of the *hlq*.SEQATLIB data set. Modify the parameter required by your site. You can add parameters by doing one of the following alternatives:
  - Use the INCLUDE *'any.data.set.name'* ; statement to include statements from a data set that you created.
  - Use the INCLUDE *membername* ; statement to include parameters from other members in the *hlq*.SEQATLIB data set.

If your application programmers use terminals that cannot display text in mixed-case English, enter parameters and their values in uppercase English.

See "Using delay debug mode to delay starting of a debug session" in the *IBM z/OS Debugger User's Guide* for how to use the delay debug function.

| Name of parameter | Description                                                                                                                                                                                                                                                                                                                                                                                                                                                                                                                                                                                                                                                                                                       |
|-------------------|-------------------------------------------------------------------------------------------------------------------------------------------------------------------------------------------------------------------------------------------------------------------------------------------------------------------------------------------------------------------------------------------------------------------------------------------------------------------------------------------------------------------------------------------------------------------------------------------------------------------------------------------------------------------------------------------------------------------|
| ddpnmp            | <p>The naming pattern of the delay debug profile data set.</p> <p>The utility builds a data set name by using the naming pattern that is used when the option is selected for the first time. The data set name and modification (if user modifies it) are consistent across IBM z/OS Debugger Utilities sessions.</p> <p>The following list describes the rules of using the token:</p> <ul style="list-style-type: none"><li>• The &amp;USERID token is replaced with the value from the SYSPREF or SYSUID system variable.</li><li>• The &amp;PGMNAME token is not supported.</li><li>• If the parameter does not exist, the default naming pattern is used:</li></ul> <pre>&amp;USERID.DLAYDBG.EQAUOPTS</pre> |

## Customizing IMS Transaction and User ID Cross Reference Table

The IMS transaction and user ID cross reference table contains the cross reference information between IMS transactions and user IDs. A web or MQ gateway initiated IMS transaction is run with a generic ID. When a user wants to debug such a transaction, he needs to add an entry in the cross reference table that contains the transaction name and his user ID. z/OS Debugger then uses the table to find the user ID of the user who wants to debug the transaction and to construct the name of the user's debug profile data set. You can set the values of parameters for the users by taking the following steps:

<sup>18</sup> See "SMP/E USERMODS" in the *IBM z/OS Debugger Customization Guide* for an SMP/E USERMOD for this customization.

1. Review the parameters described in [Table 22 on page 84](#). Verify that you have all the information to specify the value for the parameters. See the EQAZDSYS member of the *hlq.SEQATLIB* data set for the parameter and the syntax convention.
2. Edit the EQAZDSYS<sup>19</sup> member of the *hlq.SEQATLIB* data set. Modify the parameters that are required by your site. You can add parameters by doing one of the following alternatives:
  - Use the INCLUDE *'any.data.set.name'* ; statement to include statements from a data set that you created.
  - Use the INCLUDE *membername* ; statement to include parameters from other members in the *hlq.SEQATLIB* data set.

If your application programmers use terminals that cannot display text in mixed-case English, enter parameters and their values in uppercase English.

See [Chapter 8, “Specifying the TEST runtime options through the Language Environment user exit,” on page 61](#) for information on how to set this data set name in the exit.

See [“DLAYDBGXRF” on page 149](#) for information on how to specify this data set name for IMS users who are using delay debug mode.

| <i>Table 22. Parameters for the IMS Transaction and User ID Cross Reference Table of IBM z/OS Debugger Utilities</i> |                                                                                                                                                                                                                                                                             |
|----------------------------------------------------------------------------------------------------------------------|-----------------------------------------------------------------------------------------------------------------------------------------------------------------------------------------------------------------------------------------------------------------------------|
| <b>Name of parameter</b>                                                                                             | <b>Description</b>                                                                                                                                                                                                                                                          |
| TUXRFDSN                                                                                                             | The data set name for the cross reference table in ISPF format. No default is provided. The data set is an MVS sequential data set with FB LRECL 80. It must be pre-allocated and accessible to the users using the utility.                                                |
| TUGNRCID                                                                                                             | One or more generic IDs separated by a blank. No default is provided. A generic ID is an ID that is used to run IMS transactions started using the MQ or web gateway. z/OS Debugger uses the cross reference table to identify the user who wants to debug the transaction. |
| TUACTPRD                                                                                                             | Number of days that a cross reference table entry is retained from the last update date. The default is 30 days.                                                                                                                                                            |
| TUGIDMAX                                                                                                             | Maximum number of generic IDs. The default value is 20.                                                                                                                                                                                                                     |
| TUENTMAX                                                                                                             | Maximum number of cross reference table entries. The default value is 200.                                                                                                                                                                                                  |

## Customizing Non-CICS Debug Session Start and Stop Message Viewer

The Non-CICS Debug Session Start and Stop Messages Viewer utility allows users to browse debug session start and stop messages. It helps you track debug sessions. You can set the value of parameters for the users by taking the following steps:

1. Review the parameters that are described in [Table 23 on page 85](#). Verify that you have all the information to specify the value for the parameters. See the EQAZDSYS member of the *hlq.SEQATLIB* data set for the parameter and the syntax convention.
2. Edit the EQAZDSYS<sup>20</sup> member of the *hlq.SEQATLIB* data set. Modify the parameters that are required by your site. You can add parameters by doing one of the following alternatives:

<sup>19</sup> See "SMP/E USERMODs" in the *IBM z/OS Debugger Customization Guide* for an SMP/E USERMOD for this customization.

<sup>20</sup> See "SMP/E USERMODs" in the *IBM z/OS Debugger Customization Guide* for an SMP/E USERMOD for this customization.



- Use the INCLUDE `'any.data.set.name'`; statement to include statements from a data set that you created.
- Use the INCLUDE `membername`; statement to include parameters from other members in the `hlq.SEQATLIB` data set.

If your application programmers use terminals that cannot display text in mixed-case English, enter parameters and their values in uppercase English.

See “STARTSTOPMSGDSN” on page 165 for information on how to specify this data set name for debugger sessions.

| <i>Table 23. Parameters for the Non-CICS Debug Session Start and Stop Message Viewer of z/OS Debugger utilities</i> |                                                                                                                                                                                                                               |
|---------------------------------------------------------------------------------------------------------------------|-------------------------------------------------------------------------------------------------------------------------------------------------------------------------------------------------------------------------------|
| <b>Name of parameter</b>                                                                                            | <b>Description</b>                                                                                                                                                                                                            |
| SSMSGDSN                                                                                                            | The data set name for the debug session start and stop messages. No default is provided. The data set is an MVS sequential data set with FB LRECL 80. It must be pre-allocated and accessible to the users using the utility. |

## Customizing z/OS Debugger Code Coverage

z/OS Debugger Code Coverage provides the following functions:

1. Observation viewer - browse code coverage observation data set.
2. z/OS Debugger options - create or modify the z/OS Debugger code coverage options data set.
3. Observation selection criteria - create or modify the observation selection criteria and source markers data set.
4. Observation extraction - extract code coverage observations by using selection criteria.
5. Report generation - create reports.

You can set the default values for the data set naming pattern for the first three functions for the users by taking the following steps:

1. Review the parameter described in the following table. Verify that you have all the information to specify the value for the parameter. See the EQAZDSYS member of the `hlq.SEQATLIB` data set for the parameter and the syntax convention.
2. Edit the EQAZDSYS<sup>21</sup> member of the `hlq.SEQATLIB` data set. Modify the parameter required by your site. You can add parameters by doing one of the following alternatives:
  - Use the INCLUDE `'any.data.set.name'`; statement to include statements from a data set that you created.
  - Use the INCLUDE `membername`; statement to include parameters from other members in the `hlq.SEQATLIB` data set.

If your application programmers use terminals that cannot display text in mixed-case English, enter parameters and their values in uppercase English.

See "z/OS Debugger Code Coverage" in the IBM z/OS Debugger User's Guide for how to use the z/OS Debugger code coverage function.

<sup>21</sup> See "SMP/E USERMODS" in the *IBM z/OS Debugger Customization Guide* for an SMP/E USERMOD for this customization.

Table 24. Parameters for z/OS Debugger Code Coverage

| Name of parameter | Description                                                                                                                                                                                                                                                                                                                                                                                                                                                                                                                                                                                                                                                                          |
|-------------------|--------------------------------------------------------------------------------------------------------------------------------------------------------------------------------------------------------------------------------------------------------------------------------------------------------------------------------------------------------------------------------------------------------------------------------------------------------------------------------------------------------------------------------------------------------------------------------------------------------------------------------------------------------------------------------------|
| cconmp            | <p>The naming pattern of the code coverage options data set.</p> <p>The utility builds a data set name by using the naming pattern that is used when the option is selected for the first time. The data set name and modification (if user modifies it) are persistent across IBM z/OS Debugger Utilities sessions.</p> <p>The following list describes the rules of using the token:</p> <ul style="list-style-type: none"> <li>• The &amp;USERID token is replaced with the value from the SYSPREF or SYSUID system variable.</li> <li>• If the parameter does not exist, the default naming pattern is used: &amp;USERID . DBGTOOL . CCPRGSEL.</li> </ul>                        |
| ccsnmp            | <p>The naming pattern of the code coverage observation selection criteria data set.</p> <p>The utility builds a data set name by using the naming pattern that is used when the option is selected for the first time. The data set name and modification (if user modifies it) are persistent across IBM z/OS Debugger Utilities sessions.</p> <p>The following list describes the rules of using the token:</p> <ul style="list-style-type: none"> <li>• The &amp;USERID token is replaced with the value from the SYSPREF or SYSUID system variable.</li> <li>• If the parameter does not exist, the default naming pattern is used: &amp;USERID . DBGTOOL . CCOBSSEL.</li> </ul> |
| ccxnmp            | <p>The naming pattern of the code coverage observations data set.</p> <p>The utility builds a data set name by using the naming pattern that is used when the option is selected for the first time. The data set name and modification (if user modifies it) are persistent across IBM z/OS Debugger Utilities sessions.</p> <p>The following list describes the rules of using the token:</p> <ul style="list-style-type: none"> <li>• The &amp;USERID token is replaced with the value from the SYSPREF or SYSUID system variable.</li> <li>• If the parameter does not exist, the default naming pattern is used: &amp;USERID . DBGTOOL . CCOOUTPUT.</li> </ul>                  |

## Installing and customizing z/OS Debugger JCL Wizard

The z/OS Debugger JCL Wizard is an ISPF edit macro, **EQAJCL**, that can be used by a user to modify a JCL or procedure member to create statements that will invoke z/OS Debugger in various environments.

### Prerequisites

The z/OS Debugger library *hlq.SEQAMOD* is assumed to be in the z/OS link list where the batch job will run. If it is not in the link list, do one of the following actions:

- Add the library *hlq.SEQAMOD* to the link list of z/OS LPARs where the modified JCL or procedure will be run.
- Add the library *hlq.SEQAMOD* to the //STEPLIB or //JOB LIB statement of the step or job that will be debugged.

## Installation of the EQAJCL ISPF macro and its ISPF panels

The z/OS Debugger JCL Wizard contains an ISPF edit macro and a set of ISPF panels.

Use one of the following methods to install the z/OS Debugger JCL Wizard :

- Installation to libraries allocated to the TSO Logon procedure.

Use one of these two methods:

- Use [Method 2](#) in “[Choosing a method to start IBM z/OS Debugger Utilities](#)” on page 70.
- Use a subset of [Method 2](#) in “[Choosing a method to start IBM z/OS Debugger Utilities](#)” on page 70 where you only include or copy *hlq*.SEQAEXEC into the SYSPROC or SYSEXEC DD.

- Installation by using a local REXX exec to point to the z/OS Debugger libraries.

Select a command name that you do not currently use (for example, DEBUG), and install a REXX exec by that name into an existing data set in your TSO Logon procedure's SYSEXEC or SYSPROC DDs. The REXX exec should look like this (with *hlq* being changed to the high level qualifier that you use for the z/OS Debugger libraries):

```
/* This REXX exec will invoke the z/OS Debugger EQAJCL ISPF macro */
"EXEC 'hlq.SEQAEXEC(EQAJCL)'"
EXIT
```

## Customizing the data set names and other values in EQAJCL

You must modify member **EQAJCL** of the *hlq*.SEQAEXEC data set to specify the data set names that you chose at installation time. Edit the **EQAJCL** member and follow the directions in the member's prologue for site customization of data set names.<sup>22</sup>

## Enabling Code Coverage

z/OS Debugger Code Coverage measures test case code coverage in application programs that are written in COBOL, PL/I and C and compiled with certain compilers and compiler options. You must define the code coverage libraries *xxxx.xxxx.CCPRGSEL* and *xxxx.xxxx.CCOUTPUT* in the EQAOPTS member residing in *hlq*.SEQAMOD, or dynamically using an EQAOPTS DD statement. If the variable `CODE_COVERAGE_SETUP` is set to **YES**, the z/OS Debugger JCL Wizard automatically adds these statements to your JCL. Therefore, system programmers do not need to change the EQAOPTS member in *hlq*.SEQAMOD.

If the variable `CODE_COVERAGE_SETUP` is set to **YES**, the following statements are generated:

```
//EQAOPTS DD *
EQAXOPT CCOUTPUTDSN, '&&USERID.DBGTOOL.CCOUTPUT'
EQAXOPT CCOUTPUTDSNALLOC, 'MGMTCLAS(STANDARD) +
 STORCLAS(DEFAULT) LRECL(255) BLKSIZE(0) RECFM(V,B) +
 DSORG(PS) SPACE(2,2) CYL'
EQAXOPT CCPRGSELECTDSN, '&&USERID.DBGTOOL.CCPRGSEL'
EQAXOPT END
```

For more information about the compilation requirements for Code Coverage, refer to the *IBM z/OS Debugger User's Guide*.

The z/OS Debugger JCL Wizard creates Code Coverage commands to run either with or without an interactive debug session.

<sup>22</sup> See "SMP/E USERMODs" in the *IBM z/OS Debugger Customization Guide* for an SMP/E USERMOD for this customization.



---

## Chapter 11. Preparing your environment to debug Db2 stored procedures

The Db2 administrator must define the address space where the stored procedure runs. This can be a Db2 address space or a workload management (WLM) address space. This address space is assigned a name which is used to define the stored procedure to Db2. In the JCL for the Db2 or WLM address space, verify that the following data sets are defined in the STEPLIB concatenation and have the appropriate RACF Read authorization for programs to access them:

- LOADLIB for the stored procedure
- SEQAMOD<sup>23</sup> for z/OS Debugger
- SCEERUN<sup>24</sup> for Language Environment

After updating the JCL, the Db2 administrator must refresh the Db2 or WLM address space so that these updates take effect.

Refer to the following topics for more information related to the material discussed in this topic.

### **Related references**

*DB2® UDB for z/OS Application Programming and SQL Guide*

---

<sup>23</sup> Add `h1q.SEQAMOD` to STEPLIB only if it is not already in the system search path (for example, link list). If you create a custom EQAOPTS (as described in [Chapter 16, “EQAOPTS commands,”](#) on page 131) that is not stored in `h1q.SEQAMOD`, then place the data set containing it in STEPLIB (ahead of `h1q.SEQAMOD` if it is in STEPLIB). `h1q.SEQAMOD` must be placed before any other library in the STEPLIB that contains CEEVDBG for z/OS Debugger to get control of a debug session.

<sup>24</sup> Add `CEE.SCEERUN` to STEPLIB only if it is not already in the system search path (for example, link list). If you create a private copy of the z/OS Debugger Language Environment user exit for Db2 that is linked into CEEPIPI (as described in [Chapter 8, “Specifying the TEST runtime options through the Language Environment user exit,”](#) on page 61), then place the data set containing it in STEPLIB (ahead of `CEE.SCEERUN` if it is in STEPLIB).



# Chapter 12. Adding support for debugging under CICS

To debug applications that run in CICS, z/OS Debugger requires the following:

- Language Environment. Refer to the Language Environment installation and customization information for more information.
- Do the steps described in this chapter.

**Note:** You can use DTCN or CADP to add support for debugging, depending on the version of CICS:

- CICS version 2.2 or earlier: you must use DTCN.
- CICS version 2.3 or later: either DTCN or CADP. If you choose to use CADP, read the following topics for information on additional installation and setup tasks:
  - "The application debugging profile manager" in *Supplied Transaction*
  - "Preparing to use debuggers with CICS applications" in *Application Programming Guide*
  - "Setting up the debugging profiles data sets" in *System Definition Guide*

To add z/OS Debugger support for CICS applications:

1. Verify that the current z/OS Debugger resources are defined in the CICS CSD and installed in the CICS region. The CICS definitions are in the EQACCS and EQACDCT members of the *hlq.SEQASAMP* data set.
  - a. If your site policy is to define the Transient Data queues by using DCT macro definitions, add the definitions in the EQACDCT member to your DCT and reassemble it.  
  
If your site uses COBOL or PL/I separate debug files, follow the instructions in EQACDCT to define the appropriate queues to CICS.
  - b. Add the z/OS Debugger definitions to the CICS CSD. The following two members are provided in the *hlq.SEQASAMP* data set:
    - EQACCS, which contains the resource definitions for the group EQA.
    - EQAWCCS, which contains JCL to apply the definitions which are in EQACCS.
 Review the instructions in both members and run the batch job to add the definitions to your CICS CSD.
2. Update the JCL that starts CICS:
  - a. Update the DFHRPL concatenation in the CICS region startup JCL to include the following libraries:

| Library            | Description                                                                                                                                                                                                                                                                                                                                        |
|--------------------|----------------------------------------------------------------------------------------------------------------------------------------------------------------------------------------------------------------------------------------------------------------------------------------------------------------------------------------------------|
| <i>hlq.SEQAMOD</i> | z/OS Debugger library<br><br>In the DFHRPL concatenation, <i>hlq.SEQAMOD</i> must be placed before any other library that also contains CEEVDBG for z/OS Debugger to get control of a debug session.<br><br>Defining the <i>hlq.SEQAMOD</i> data set as a CICS LIBRARY resource is not supported. It must be included in the DFHRPL concatenation. |
| SCEECICS           | z/OS Language Environment runtime library                                                                                                                                                                                                                                                                                                          |

| Table 25. Libraries to be included in DFHRPL (continued) |                                                                                                                                                                                       |
|----------------------------------------------------------|---------------------------------------------------------------------------------------------------------------------------------------------------------------------------------------|
| Library                                                  | Description                                                                                                                                                                           |
| SCEERUN                                                  | z/OS Language Environment runtime library                                                                                                                                             |
| SCEERUN2                                                 | z/OS Language Environment runtime library<br>Specify this library if it is required by your application.                                                                              |
| MIGLIB<br>SIEAMIGE                                       | z/OS system libraries<br>These libraries are needed to debug routines compiled with Enterprise COBOL V5 and V6.1 TEST and Enterprise COBOL V6.2 (and later) TEST or TEST(NOSEPARATE). |

- b. Remove any data sets from the concatenation that refer to old releases of z/OS Debugger.
  - c. Include EQA00DYN and EQA00HFS from the debugger's *hlq*.SEQAMOD data set in the STEPLIB concatenation by either of the following ways:
    - Use the Authorized Program Facility (APF) to authorize<sup>2</sup> the *hlq*.SEQAMOD data set and add the data set to the STEPLIB concatenation.
    - Copy<sup>5</sup> the EQA00DYN and EQA00HFS modules from the *hlq*.SEQAMOD data set to a library that is already in the STEPLIB concatenation.
    - Place *hlq*.SEQAMOD in the system link list and use the Authorized Program Facility (APF) to authorize it<sup>2</sup>. For more information, see [Chapter 5, “Setting up the link list data set \(SEQAMOD\),” on page 15.](#)
  - d. Ensure that the JCL does not include DD statements for CINSPLN, CINSPLS, CINSPOP, IBMDBGIN, or IGZDBGIN.
  - e. See [“Storing DTCN debug profiles in a VSAM file” on page 96](#) to determine if you want to store DTCN debugging profiles in a VSAM data set. If you do, follow the instructions in that topic to add the EQADPFMB DD statement that refers to the VSAM data set.
3. For any terminal that z/OS Debugger uses to display a debugging session, do the following tasks:
    - Verify that the CICS TYPETERM definition specifies a minimum value of 4096 for the RECEIVESIZE attribute and sets the BUILDCHAIN attribute to YES.
    - Enable either color or highlighting. For best usability, enable both and the ability to query the screen size. To enable these three functions, verify that the CICS TYPETERM definition specifies EXTENDEDDES. For more information, refer to the *CICS Transaction Server for z/OS Resource Definition Guide*.
    - Under CICS, z/OS Debugger can use a screen as large as 10922 characters (for example, 68x160 can be used, but not 69x160), and provides automatic switching from the application's screen size to the physical screen size. Larger screens can enhance user productivity. CICS selects the TYPETERM to use from the BIND information given to it from VTAM. Ask your systems programmer to ensure that VTAM passes the screen sizes through to CICS.
  4. Verify that users can run the CDT# transaction without receiving any errors.
 

If the CDT# transaction runs successfully, no messages are displayed. You might see X-SYSTEM after you press Enter. This disappears when the transaction finishes and the keyboard unlocks.
  5. If you are running your CICS programs in a multi-region CICS environment:
    - a. Define the DTCN transaction name the same across all local and remote systems. If the DTCN transaction name is changed, or if a DTCN transaction is duplicated and given a different name, change the name on all systems.



- b. If a debugging session might run in a region that is different from the one where DTCN or CADP was used to save the debugging profile, use the PLTPI program EQA0CPLT with the CICS start up parameter INITPARM=(EQA0CPLT='NWP').
  - c. If you are using DTCN, ensure that the region shares the debug profile repository. See [“Sharing DTCN debug profile repository among CICS systems”](#) on page 96 for more information about defining the region that owns the debug profile repository. The most common multi-region debugging scenario is where the debug profile repository is shared and DTCN runs in the TOR while the application to be debugged is transaction routed to an AOR.  
  
One of two methods must be used in this case to start the debugger's new program support in the AOR. Either use EQA0CPLT to enable this support when the region starts (see step [“9”](#) on page 94 for information about EQA0CPLT), or use the z/OS Debugger DTCP transaction to start or stop this support as needed. In the AOR, enter DTCPO on a clear CICS screen to activate this support and enter DTCPF to deactivate it. You can activate and deactivate this support multiple times.
  - d. If you are using CADP for debugging profiles, set the startup parameter DEBUGTOOL=YES for any region where a z/OS Debugger session might start. This parameter activates the z/OS Debugger new program support.
6. If users need to debug Enterprise PL/I for z/OS, Version 3 Release 4 (or later), applications under CICS:

a. Install the following corequisite:

- If you are running z/OS Version 1 Release 6, you need to apply the PTF for Language Environment APAR PK03093.
- If you are compiling with Enterprise PL/I for z/OS, Version 3 Release 4, apply the PTF for APAR PK03264.

Users can begin a debug session by using DTCN or CADP at either of the following points:

- The entry to programs invoked by EXEC CICS LINK or XCTL.
- The entry to any program, even if it is a nested program within a composite load module, invoked as a static or dynamic CALL.

b. To enable users to start debug sessions with CADP, use PLTPI program EQA0CPLT with the CICS start up parameter INITPARM=(EQA0CPLT='NWP'). See step [“9”](#) on page 94 for information about EQA0CPLT.

7. If you are planning to debug command-level assembler application programs that do not run under or use Language Environment services, activate the CICS non-Language Environment exits as described in [“Activating CICS non-Language Environment exits”](#) on page 95.
8. If your CICS region is started with the SEC parameter set to YES and the XCMD parameter is set to YES to activate command security, review the access settings for the following resources:

#### **EXITPROGRAM**

Do one of the following options:

- Verify that z/OS Debugger users have UPDATE authority to the EXITPROGRAM resource so that they can run EXEC CICS ENABLE PROGRAM EXIT, DISABLE PROGRAM EXIT, and EXTRACT EXIT.
- Activate the debugger's single-terminal mode screen stacking user exits during CICS start up by doing the following:
  - a. Verify that the user ID that runs the CICS region has UPDATE access to the EXITPROGRAM resource.
  - b. Add the program EQA0CPLT to your Program List Table (PLTPI).
  - c. Add INITPARM=(EQA0CPLT='STK') to your CICS startup parameters.

See step [“9”](#) on page 94 for instructions on using EQA0CPLT.

## TDQUEUE

Verify that all users have UPDATE authority to the TDQUEUE resource, so that they can run EXEC CICS INQUIRE and EXEC CICS SET TDQUEUE.

## PROGRAM

Verify that all users have READ authority to the PROGRAM resource, so that they can run EXEC CICS INQUIRE PROGRAM.

For more information about the CICS security features, see *CICS RACF Security Guide*.

### 9. (Optional) Set up the CICS PLTPI program called EQA0CPLT:

- a. Add the program EQA0CPLT to your Program List Table (PLTPI). EQA0CPLT initializes parts of z/OS Debugger during CICS startup as indicated by a CICS INITPARM system initialization parameter. Run EQA0CPLT as a Stage 2 or Stage 3 PLTPI program. IBM recommends that you place EQA0CPLT after other PLT programs. The following sample PLT includes EQA0CPLT:

```
TITLE 'DFHPLTXX - IBM
z/OS Debugger CICS Sample PLT'
DFHPLT TYPE=INITIAL,SUFFIX=XX
*
DFHPLT TYPE=ENTRY,PROGRAM=DFHDELIM
DFHPLT TYPE=ENTRY,PROGRAM=EQA0CPLT
*
DFHPLT TYPE=FINAL END DFHPLTBA
```

- b. Add the INITPARM keyword to the CICS startup parameters. Multiple parameters can be passed to EQA0CPLT in the same INITPARM. The following common parameters can be used:

### NLE

Non-Language Environment support. See [“Activating CICS non-Language Environment exits” on page 95](#).

### STK

Screen stack exits. This parameter is required if you are using command security.

### NWP

New program support. This parameter is required if you are using multi-regions or Enterprise PL/I Version 3 Release 4 (or later) with CADP.

### STG

This parameter enables the protection of storage that was GETMAINed in the current task by a program that is not the active program. This protection is only provided when the user is using the remote debugger.

For example, to activate the non-Language Environment support, screen stack exits, and new program support (multi-region and Enterprise PL/I Version 3 Release 4 with CADP) in a single INITPARM, add the following to your CICS startup parameters:

```
INITPARM=(EQA0CPLT='NLE,STK,NWP')
```

Any combination of these four can be coded on the same INITPARM.

### 10. If the users use COBOL or PL/I separate debug files, verify that the users specify the following attributes for the PDS or PDSE that contains the separate debug files:

- RECFM=FB
- LRECL=1024
- BLKSIZE set so that the system determines the optimal size

**Important:** Users must allocate files with the correct attributes to optimize the performance of z/OS Debugger.

### 11. (Optional) Increase the DSALIM and EDSALIM sizes in your CICS region so that z/OS Debugger functions properly with multiple concurrent users. The amount of increase is based on the current workload in the CICS region.

**Recommendation:** Increase the sizes of DSALIM and EDSALIM in increments of 5% or 10%. Monitor the storage in the region as z/OS Debugger users are debugging for the highest amount of storage that is used at any one point.

12. To enable users to start debug sessions for Enterprise COBOL or Enterprise PL/I application with DTCN, use one of the following methods:

- Use PLTPI program EQAOCPLT with the CICS start up parameter INITPARM=(EQAOCPLT=' NWP ' ). For more information about EQAOCPLT, see Step “9” on page 94.
- Save a DTCN profile.
- Run DTCPO transaction after the region starts up.

See the *IBM z/OS Debugger User's Guide* for information about how to debug CICS programs.

## Activating CICS non-Language Environment exits

To debug non-Language Environment assembler programs or non-Language Environment COBOL programs that run under CICS, you must start the required z/OS Debugger global user exits before you start the programs. z/OS Debugger provides the following global user exits to help you debug non-Language Environment applications: XPCFTCH, XEIIIN, XEIIOUT, XPCTA, and XPCHAIR. The exits can be started by using either the DTCX transaction (provided by z/OS Debugger), or using a PLTPI program that runs during CICS region startup

**DTCX:** You can turn the exits on and off by using the transaction DTCX. To activate all of the exits, from a clear CICS terminal screen enter DTCXXO. To deactivate all of the exits, enter DTCXXF. You need to activate the exits only once. If you deactivate the exits and then want to debug a non-Language Environment program, you need to enter DTCXXO from a clear CICS terminal screen to activate the exits.

After you enter DTCXXO, a series of messages are displayed on your screen. If all exits are activated successfully, the following messages are displayed:

```
EQA9972I - DT XPCFTCH CICS exit now ON.
EQA9972I - DT XEIIIN exit now ON.
EQA9972I - DT XEIIOUT exit now ON.
EQA9972I - DT XPCTA exit now ON.
EQA9972I - DT XPCHAIR exit now ON.
EQA9970I - CICS exit activation successful.
```

When you enter DTCXXF, the following messages are displayed:

```
EQA9973I - DT XPCFTCH CICS exit now OFF.
EQA9973I - DT XEIIIN exit now OFF.
EQA9973I - DT XEIIOUT exit now OFF.
EQA9973I - DT XPCTA exit now OFF.
EQA9973I - DT XPCHAIR exit now OFF.
EQA9971I - CICS exit deactivation successful.
```

If there is a problem starting or activating one of the exits, an error message like the following is displayed:

```
EQA9974I Error enabling XPCFTCH - EQANCFTC
```

If you see this error message, verify that the CICS CSD is properly updated to include the latest z/OS Debugger resource definitions, and that the z/OS Debugger SEQAMOD data is in the DFHRPL DD concatenation for the CICS region.

You can start the exits during region initialization by using a sequential terminal or any other mechanism that runs transactions during CICS startup. You are not required to shut down the exits before or during a region shutdown.

**PLT:** The non-Language Environment exits can also be activated during CICS region initialization by using the CICS Program List Table (PLTPI) program EQAOCPLT (supplied by z/OS Debugger). In addition to adding EQAOCPLT to your CICS region PLT, you must specify the CICS startup parameter INITPARM=(EQAOCPLT=' NLE ' ). EQAOCPLT supersedes the function provided earlier by PLTPI program

EQANCPLT. See step “9” on page 94 for instructions on using EQA0CPLT. For more information about PLT processing, see the *CICS Resource Definition Guide*.

## Storing DTCN debug profiles in a VSAM file

---

By default, the CICS DTCN transaction stores its debugging profiles into a CICS temporary storage queue (TSQ) called EQADTCN2. Because CICS destroys temporary storage queues at region termination, any profiles stored in EQADTCN2 are deleted when a region is stopped. To save debugging profiles across region termination and restart or after the owning terminal is disconnected, store the profiles into a VSAM data set.

Do the following steps to instruct DTCN to store its debugging profiles in a VSAM data set:

1. Create the VSAM data set by following the instructions in the EQAWCRVS member of the *hlq*.SEQASAMP data set.
2. Modify the CICS region startup JCL so that the EQADPFMB DD statement identifies the VSAM data set you created in step 1.
3. Define the VSAM file to the CICS region by following the instructions in the EQACCSO member of the *hlq*.SEQASAMP data set. “[Sharing DTCN debug profile repository among CICS systems](#)” on page 96 also describes examples of CICS resource definitions.

## Migrating a debug profiles VSAM file from an earlier release

---

z/OS Debugger Version 12 increased the record size, and changes the format of the DTCN profile records.

If you are migrating from an earlier release of z/OS Debugger, and you use an EQADPFMB VSAM file to store your profiles, you need to create a new file using the JCL sample in member EQAWCRVS in the *hlq*.SEQASAMP data set.

If you want to upgrade the records from an old DTCN VSAM file to the new record format, see the JCL sample in member EQADPCNV in the *hlq*.SEQASAMP data set.

## Sharing DTCN debug profile repository among CICS systems

---

The DTCN debug profile repository is either a CICS temporary storage queue called EQADTCN2 or a VSAM data set identified through the EQADPFMB DD statement. If you want to share the repository among CICS systems (for example, MRO), do one of the following options:

- If you are using a temporary storage queue, do the following steps:
  1. Designate a single CICS region as the *queue-owning region* and note the SYSID of that region. In [Figure 7 on page 97](#), the SYSID of the queue-owning region is P6.
  2. For all other regions that need to access the queue-owning region, create a TSMODEL resource definition and verify that you define the following attributes:
    - For the REMOTESystem attribute, specify the SYSID of the queue-owning region.
    - For PRefix and REMOTEPrefix attribute, specify EQADTCN2.
    - To optimize the performance of z/OS Debugger, define the Location attribute as MAIN.

```

CEDA View TSmodel(DTCN1)
TSmodel ==> DTCN1
Group ==> DTCNREM
Description ==> TEST DTCN TSQ REMOTE
PPrefix ==> EQADTCN2
XPrefix ==>
Location ==> Main Auxiliary | Main
RECOVERY ATTRIBUTES
REcovery ==> No No | Yes
SECURITY ATTRIBUTES
Security ==> No No | Yes
SHARED ATTRIBUTES
POolname ==>
REMOTE ATTRIBUTES
REMOTESystem ==> P6
REMOTEPrefix ==> EQADTCN2
XRemotepfx ==>
Group ==>

```

Figure 7. A sample TSMODEL resource definition that gives a region access to the queue-owning region called P6.

For instructions on how to create a TSMODEL resource definition, see *CICS Resource Definition Guide*.

- If you are using a VSAM data set and want to function-ship file operations to a file-owning region (FOR), do the following steps:
  1. Designate a single FOR.
  2. Define the EQADPFMB file as REMOTE in the CICS FILE definition on regions that need to access it remotely. To learn how to define a FILE resource, see *CICS Resource Definition Guide*. [Figure 8 on page 98](#) shows how to define the EQADPFMB file in a region that uses it remotely.
  3. For the region which owns the VSAM data set, omit the REMOTESYSTEM and REMOTENAME values in the EQADPFMB CICS FILE definition.
  4. Start the FOR before starting any AOR that needs to read the EQADPFMB file.

```

CEDA View File(EQADPFMB)
File : EQADPFMB
Group : DTCNREM
DEscription : DTCN PROFILE DATASET REMOTE
VSAM PARAMETERS
DSName :
Password : PASSWORD NOT SPECIFIED
RLSaccess : No Yes | No
LSrpoolid : 1 1-8 | None
READInteg : Uncommitted Uncommitted | Consistent | Repeatable
DSNSharing : Allreqs Allreqs | Modifyreqs
STRings : 001 1-255
Nsrgroup :
REMOTE ATTRIBUTES
REMOTESystem : P6
REMOTENAME : EQADPFMB
REMOTE AND CFDATATABLE PARAMETERS
RECORDSize : 1-32767
Keylength : 1-255 (1-16 For CF Datatable)
INITIAL STATUS
Status : Enabled Enabled | Disabled | Unenabled
Opentime : Firstref Firstref | Startup
DISposition : Share Share | Old
BUFFERS
Databuffers : 00002 2-32767
Indexbuffers : 00001 1-32767
DATATABLE PARAMETERS
TABLE : No No | CICS | User | CF
Maxnumrecs : Nolimit Nolimit | 1-99999999
CFDATATABLE PARAMETERS
Cfdtpool :
TABLEName :
UPDATEModel : Locking Contention | Locking
LOad : No No | Yes
DATA FORMAT
RECORDFormat : V V | F
OPERATIONS
Add ==> No No | Yes
BRowse ==> No No | Yes
DElete ==> No No | Yes
READ ==> Yes Yes | No
UPDATE ==> No No | Yes
AUTO JOURNALLING
JOUrnal ==> No No | 1-99
JNLRead ==> None None | Updateonly | Readonly | All
JNLSYNCRRead ==> No No | Yes
JNLUpdate ==> No No | Yes
JNLAdd ==> None None | Before | After | All
JNLSYNCRWrite ==> Yes Yes | No
RECOVERY PARAMETERS
RECOVery ==> None None | Backoutonly | All
Fwdrecovlog ==> No No | 1-99
BAckuptype ==> Static Static | Dynamic
SECURITY
RESsecnum : 00 0-24 | Public

```

Figure 8. An example of how to define the EQADPFMB file as REMOTE in a CICS FILE definition.

- If you are using a VSAM data set and prefer to define the file locally to all CICS regions that use it, define the file on all such regions using record-level sharing (RLS). The following sample resource definition shows how to define the z/OS Debugger EQADPFMB file using RLS.

```

CEDA View File(EQADPFMB)
File : EQADPFMB
Group : DTCNRLS
DEscription : DTCN PROFILE DATASET
VSAM PARAMETERS
DSName :
Password : PASSWORD NOT SPECIFIED
RLSaccess : Yes Yes | No
LSrpoolid : 1 1-8 | None
READInteg : Uncommitted Uncommitted | Consistent | Repeatable
DSNSharing : Allreqs Allreqs | Modifyreqs
STRings : 010 1-255
Nsrgroup :
REMOTE ATTRIBUTES
REMOTESystem :
REMOTENAME :
REMOTE AND CFDATATABLE PARAMETERS

```

|                        |   |                                    |
|------------------------|---|------------------------------------|
| RECORDSize             | : | 1-32767                            |
| Keylength              | : | 1-255 (1-16 For CF Datatable)      |
| INITIAL STATUS         |   |                                    |
| STATUS                 | : | Enabled   Disabled   Unenabled     |
| Opentime               | : | Firstref   Startup                 |
| DIsposition            | : | Share   Old                        |
| BUFFERS                |   |                                    |
| Databuffers            | : | 2-32767                            |
| Indexbuffers           | : | 1-32767                            |
| DATATABLE PARAMETERS   |   |                                    |
| TABLE                  | : | No   CICS   User   CF              |
| Maxnumrecs             | : | Nolimit   1-9999999                |
| CFDATATABLE PARAMETERS |   |                                    |
| Cfdtpool               | : |                                    |
| TABLEName              | : |                                    |
| UPDATEModel            | : | Locking   Contention   Locking     |
| LOAD                   | : | No   Yes                           |
| DATA FORMAT            |   |                                    |
| RECORDFormat           | : | V   F                              |
| OPERATIONS             |   |                                    |
| Add                    | : | No   Yes                           |
| BRowse                 | : | No   Yes                           |
| DElete                 | : | No   Yes                           |
| READ                   | : | Yes   No                           |
| UPDATE                 | : | No   Yes                           |
| AUTO JOURNALLING       |   |                                    |
| JOURNAL                | : | No   1-99                          |
| JNLRead                | : | None   Updateonly   Readonly   All |
| JNLSYNRead             | : | No   Yes                           |
| JNLUpdate              | : | No   Yes                           |
| JNLAdd                 | : | None   Before   After   All        |
| JNLSYNWrite            | : | Yes   No                           |
| RECOVERY PARAMETERS    |   |                                    |
| RECOVery               | : | None   Backoutonly   All           |
| Fwdrecovlog            | : | No   1-99                          |
| BACKuptype             | : | Static   Dynamic                   |
| SECURITY               |   |                                    |
| RESsecnum              | : | 0-24   Public                      |

For details on defining a FILE resource, see *CICS Resource Definition Guide*.

## Deleting or deactivating debug profiles stored in a VSAM data set

If you are storing debug profiles in a VSAM data set, as described in “Storing DTCN debug profiles in a VSAM file” on page 96, the number of profiles no longer in use might become large, because the debug profiles persist across region restarts and after the terminal from which a profile was created has been disconnected. z/OS Debugger provides two transactions, DTCD and DTCI, to delete or deactivate debug profiles stored in a region's VSAM data set.

To delete debug profiles in the VSAM data set identified by the EQADPFMB DD statement on your region, use the DTCD transaction. The following diagram describes the syntax of the DTCD transaction:



### **userid**

Delete the debug profile associated with a specific CICS user ID.

**\***

Deletes debug profiles from the VSAM data set. This option requires specific RACF authority; therefore, reserve it for CICS administrators.

To deactivate all debugging profiles in the VSAM data set, use the DTCI transaction. The following diagram describes the syntax of the DTCI transaction:

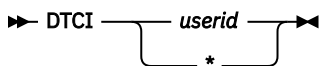

The following list describes the parameters:

### **userid**

Deactivate the debug profile associated with a specific CICS user ID.

★

Deactivate debug profiles from the VSAM data set. This option requires specific RACF authority; therefore, reserve it for CICS administrators.

Refer to the following topics for more information related to the material discussed in this topic.

### **Related tasks**

[“Authorizing DTCD and DTCI transactions to delete or deactivate debug profiles” on page 108](#)

## **Deleting DTCN profiles with the DTCN LINK service**

z/OS Debugger provides a service that deletes unowned profiles from the DTCN repository.

If the DTCN repository is stored in CICS Temporary Storage (EQADTCN2), profiles are owned by the terminal that created them. The service scans the repository, looking for profiles that were created in the region running the service. If the service finds a profile owned by a terminal that is no longer defined and active in the region, the service deletes the profile.

If the DTCN repository is stored in VSAM (EQADPFMB), profiles are owned by the user ID that created them. The service scans the repository, looking for profiles that were created in the region running the service. If the service finds a profile owned by a user ID that is no longer active in the region, the service deletes the profile.

Invoke the service with the following command:

```
EXEC CICS LINK PROGRAM('EQADCDEL')
```

The service does not expect a commarea.

Invoke this service during DELETE processing in the program that controls autoinstall of terminals; however, you can invoke it from any EXEC-capable program. [Figure 9 on page 100](#) and [Figure 10 on page 100](#) show how to invoke the service in DFHZATDX, the supplied, user-replaceable autoinstall control program for terminals.

```

* * D E L E T E P R O C E S S I N G * *
* * ----- * *
* * * *

DELETE_TERMINAL DS 0H
 USING DELETE_EXIT_COMMAREA,R2 Address delete commarea
* ==> PUT DELETE CODE HERE
*
 EXEC CICS LINK PROGRAM('EQADCDEL')
*
 B RETURN EXIT PROGRAM
```

*Figure 9. Example of invoking service in DFHZATDX*

```

* Function 8 and 10 - Common delete processing for shipped definitions*

DELETE_SHIPPED_TERMINAL DS 0H @D2A
 USING DELETE_SHIPPED_COMMAREA,R2 Address commarea @D2A
* ==> PUT DELETE CODE HERE @D2A
*
 EXEC CICS LINK PROGRAM('EQADCDEL') NOHANDLE
*
 B RETURN EXIT PROGRAM @D2A
 DFHEJECT @D2A
```

*Figure 10. Example of invoking service in DFHZATDX*

**Note:** To use the the DTCN LINK service, ensure that the DTCNDELETEDEADPROF EQAOPTS command is set to YES.



See “[DTCNDELETEDEADPROF](#)” on page 151 for more information.

## Requiring users to specify resource types

---

If your users use DTCN to specify debugging profiles, you can customize z/OS Debugger to require that your users specify some or all resource types. For example, if your users are debugging a heavily used CICS program, you can require that they specify a Terminal ID and a Transaction ID to avoid having z/OS Debugger started every time that CICS program is run. You can enforce these requirements by specifying the corresponding EQAOPTS DTCNFORCE~~xxxx~~ command, as described in “[DTCNFORCExxxx](#)” on page 151.

## Direct QSAM access through a CICS task-related user exit

---

z/OS Debugger can use two methods to access the following types of files:

- Enterprise COBOL and Enterprise PL/I separate debug files (SYSDEBUG)
- C/C++ separate debug files (.dbg and .mdbg)
- assembler and LangX COBOL EQALANGX files
- listing and source files
- command and preference files
- save settings and save breakpoints and monitor specification files
- log files

The following list describes both access methods:

- CICS Extrapartition Transient Data (default method)
- Direct QSAM access through a CICS task-related user exit

If you want the access method to avoid using CICS SPI and API to access these files, enable the QSAM access method.

To enable the QSAM access method, use the following INITPARM in your CICS start up parameters:

```
INITPARM=(DFHLETRU='USEQSAM')
```

You also need to apply the following PTFs to the appropriate products:

- For CICS Transaction Server for z/OS, Version 3.1, apply the PTF for PK67329
- For CICS Transaction Server for z/OS, Version 3.2, apply the PTF for PK68401
- For Enterprise COBOL compilers, apply the PTF for PK71852 to Language Environment, Version 1.8 through 1.10
- For Enterprise PL/I compilers, apply the PTF for PK93564 to Language Environment, Version 1.8 through 1.11

## Enabling the CADP transaction

---

Beginning with CICS Transaction Server for z/OS Version 2 Release 3, you can use the debugging profiles created by the application debugging profile manager (CADP transaction) with z/OS Debugger. Set the DEBUGTOOL system initialization parameter to YES to indicate that z/OS Debugger must use debugging profiles created by the CADP transaction. With the DEBUGTOOL system initialization parameter set to YES, you cannot use DTCN to define debugging profiles.

The default setting of DEBUGTOOL=NO indicates that z/OS Debugger will not use CADP profiles and will use DTCN-defined profiles. With DEBUGTOOL=NO, you can use CADP to update or add debugging profiles, but these profiles will not be used by z/OS Debugger.

You can dynamically switch between the CADP and DTCN debug profiles that are used by z/OS Debugger. After the CICS region is started, enter CEMT SET DEBUG to have CADP profiles used and CEMT SET NODEBUG to have DTCN profiles used.

## Running multiple debuggers in a CICS region

Coexistence with other debuggers cannot be guaranteed since situations can occur where multiple debuggers might contend for use of storage, facilities and interfaces which are intended for only one requester.

It is suggested that if you must have multiple debuggers installed in a CICS region, then only one should be active at any given time. When another debugger is used, ensure that the z/OS Debugger CICS non-Language Environment user exits are deactivated and that there are no active CADP or DTCN profiles in the region. The user exits can be deactivated by issuing the DTCXXF transaction. To deactivate other debuggers, consult the documentation provided by the vendor of the other debuggers.

## Running the installation verification programs in a CICS region

To help you verify that your CICS region has been customized properly for z/OS Debugger, the *h7q*.SEQASAMP data set contains installation verification programs (IVPs) in the following members. Run the IVPs that are appropriate for the tasks that your users will be performing.

*Table 26. Full-screen mode*

| IVP      | Task                                                                                   |
|----------|----------------------------------------------------------------------------------------|
| EQAWIVCI | Dynamic Debug facility and Enterprise PL/I TEST (ALL, SYM, NOHOOK, SEPARATE)           |
| EQAWIVCP | Dynamic Debug facility and COBOL TEST (NONE, SYM, SEPARATE) or TEST (NOHOOK, SEPARATE) |
| EQAWIVCT | Dynamic Debug facility and Enterprise COBOL for z/OS Version 5 TEST                    |
| EQAWIVC2 | C TEST (ALL)                                                                           |
| EQAWIVCG | C DEBUG (FORMAT (DWARF), HOOK (LINE, NOBLOCK, PATH), SYMBOL)                           |
| EQAWIVC8 | Enterprise PL/I TEST (ALL)                                                             |
| EQAWIVCC | Non-Language Environment Assembler                                                     |
| EQAWIVCJ | LangX Enterprise COBOL                                                                 |

*Table 27. Standard mode*

| IVP      | Task                                                                           |
|----------|--------------------------------------------------------------------------------|
| EQAZIZCG | z/OS XL C DEBUG (FORMAT (DWARF), NOHOOK)                                       |
| EQAZIZCI | Enterprise PL/I for z/OS Version 4 or Version 5 31-bit TEST (NOHOOK, SEPARATE) |
| EQAZIZCT | Enterprise COBOL for z/OS Version 5 or Version 6 TEST                          |
| EQAZIZC4 | Enterprise COBOL for z/OS Version 3 Release 4 or Version 4 NOTEST              |

**Note:** For more information about standard mode, see Remote debug mode in "Chapter 1: z/OS Debugger: overview" in *IBM z/OS Debugger User's Guide*.

## Configuring z/OS Debugger to run in a CICSplex environment

In a CICSplex, the application-owning regions (AORs), terminal-owning regions (TORs), queue-owning regions (QORs), repositories, and terminals can be organized in an infinite number of ways. In the following topics, we explore a finite number of scenarios and let you know what you need to do to configure z/OS Debugger to work in each scenario. For all of these scenarios, we assume you are working in full screen mode.

- [“Terminal connects to an AOR that runs the application” on page 103](#)
- [“Terminal connects to a TOR which routes the application to an AOR; debugging profiles managed by CADP” on page 104](#)
- [“Terminal connects to a TOR which routes the application to an AOR; debugging profiles managed by DTCN” on page 104](#)
- [“Terminal connects to an AOR that runs an application that does not use a terminal” on page 105](#)
- [“Screen control mode terminal connects to a TOR and application runs in an AOR” on page 106](#)
- [“Separate terminal mode terminal connects to a TOR and application runs in an AOR” on page 106](#)

### Terminal connects to an AOR that runs the application

In this scenario, your terminal (TRMC) connects to an AOR (CICSAOR2) that runs the application you want to debug. The debugging profiles can be managed by either CADP or DTCN and they are directly accessible by the AOR.

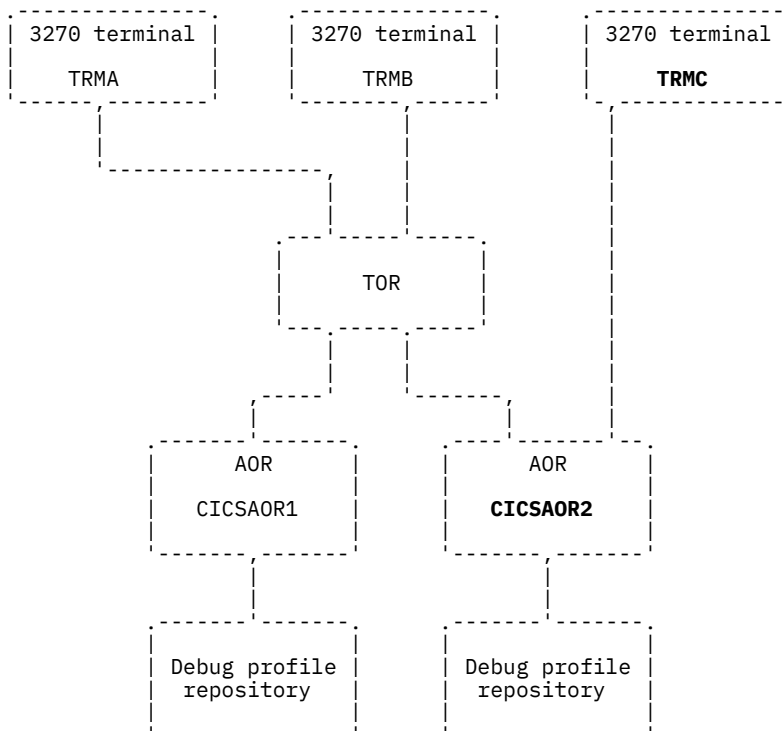

For this scenario to work, the CICS system administrator must complete the following tasks for the region CICSAOR2:

- Define z/OS Debugger resources in the CICS CSD and install them in the CICS region, as described in [Chapter 12, “Adding support for debugging under CICS,” on page 91, step 1.](#)
- Provide access to these resources, as described in [Chapter 12, “Adding support for debugging under CICS,” on page 91, step “2.a” on page 91.](#)

If you want to debug an application that runs in another AOR region, like CICSAOR1, you must log on to that region and verify that the system administrator completed the above tasks for that region.

## Terminal connects to a TOR which routes the application to an AOR; debugging profiles managed by CADP

In this scenario, your terminal (TRMC) connects to a TOR, which uses a CICS transaction to route the application you want to debug to an AOR. The debugging profiles can be managed by either CADP or DTCN and they are directly accessible by the AOR. The CADP repository is a VSAM data set which is shared between all of the regions. You can run the CADP transaction in any of the regions.

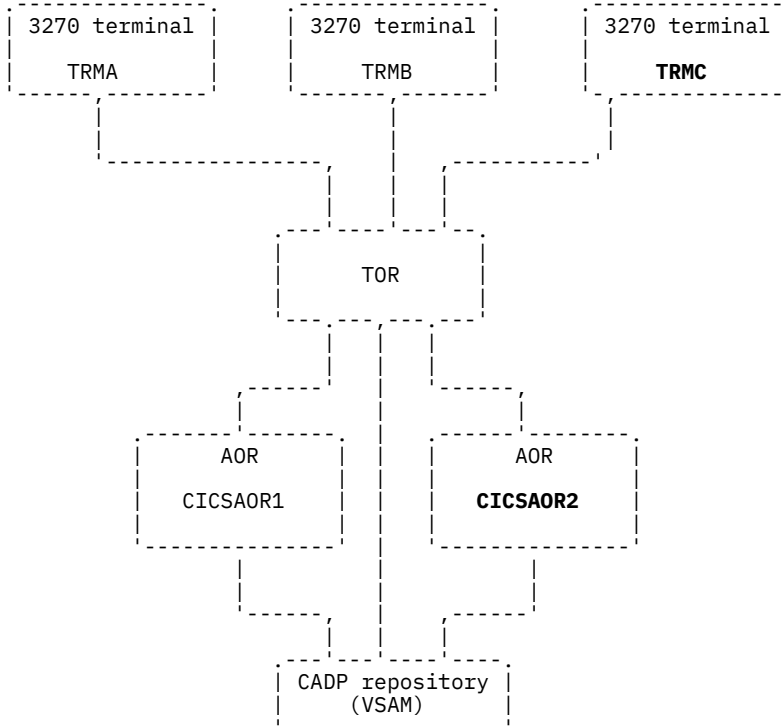

For this scenario to work, the CICS system administrator must complete the following tasks for both AORs:

- Define z/OS Debugger resources in the CICS CSD and install them in the CICS region, as described in Chapter 12, “Adding support for debugging under CICS,” on page 91, step 1.
- Provide access to these resources, as described in Chapter 12, “Adding support for debugging under CICS,” on page 91, step “2.a” on page 91.
- Run the correct programs and use the correct CICS start up parameters for each type of profile, as described in the following steps:

### CADP

Chapter 12, “Adding support for debugging under CICS,” on page 91, step “5.d” on page 93, “6.b” on page 93, “9.b” on page 94, and “Enabling the CADP transaction” on page 101.

### DTCN

Chapter 12, “Adding support for debugging under CICS,” on page 91, step “5.a” on page 92 and “9.b” on page 94.

## Terminal connects to a TOR which routes the application to an AOR; debugging profiles managed by DTCN

In this scenario, your terminal (TRMC) connects to a TOR, which uses a CICS transaction to route the application you want to debug to an AOR. The debugging profiles are managed by DTCN and are stored in a temporary storage queue (EQADTCN2) located in a queue-owning region (QOR). You can run the DTCN transaction in any of the regions.

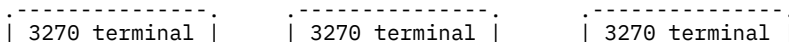

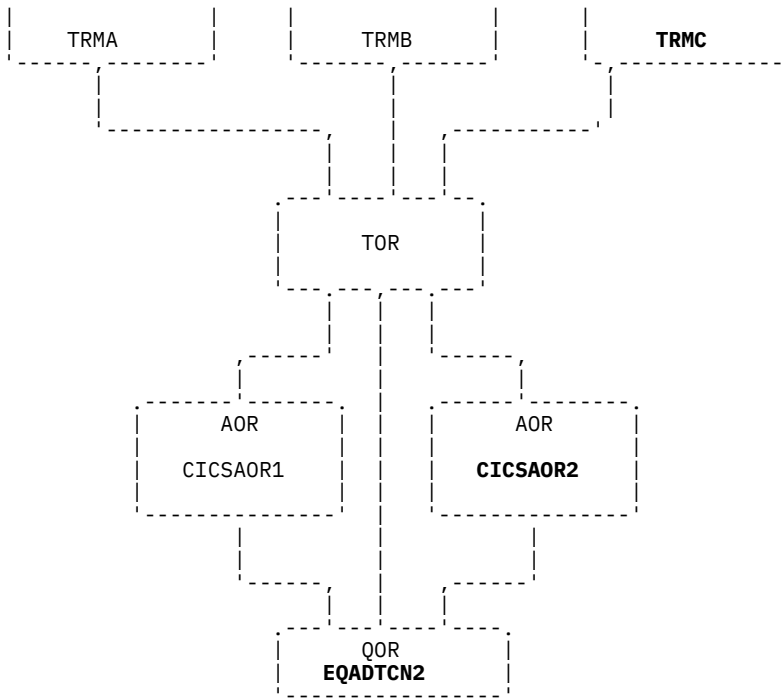

For this scenario to work, the CICS system administrator must complete the following tasks for both AORs and the TOR:

- Define z/OS Debugger resources in the CICS CSD and install them in the CICS region, as described in [Chapter 12, “Adding support for debugging under CICS,” on page 91, step 1.](#)
- Provide access to these resources, as described in [Chapter 12, “Adding support for debugging under CICS,” on page 91, step “2.a” on page 91.](#)
- Designate a single CICS region as the QOR and define the queue accessible remotely, as described in [“Sharing DTCN debug profile repository among CICS systems” on page 96.](#)

**Variation on this scenario:** The temporary storage queue (EQADTCN2) does not need to be located in a QOR. It can be located in the TOR, any of the AORs, or in the coupling facility. Wherever you put the temporary storage queue, keep the following considerations in mind:

- Place the queue where it can be accessed efficiently when the application programs begin, since it is referenced at that point to determine whether the program should be debugged.
- The temporary storage queue is accessed by Function Shipping, so allocate a sufficient number of connections between the regions to handle READQ requests.

## Terminal connects to an AOR that runs an application that does not use a terminal

In this scenario, your terminal (TRMC) connects to an AOR, which you use to set up a debugging profile using either CADP or DTCN. When the application starts, z/OS Debugger is started and issues and EXEC CICS START of its display transaction (CDT#) on your terminal (TRMC). Your terminal must be connected directly to the AOR. You cannot connect through CRTE because CICS does not support issuing an EXEC CICS START to a terminal connected through CRTE.

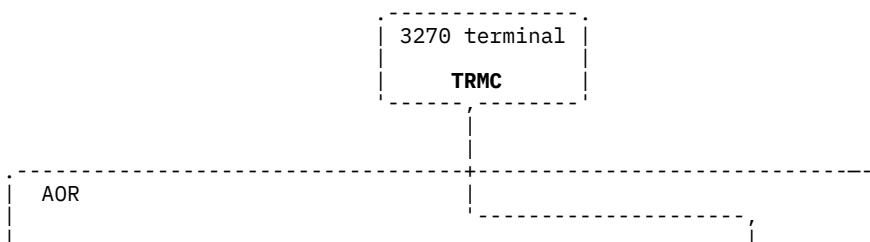

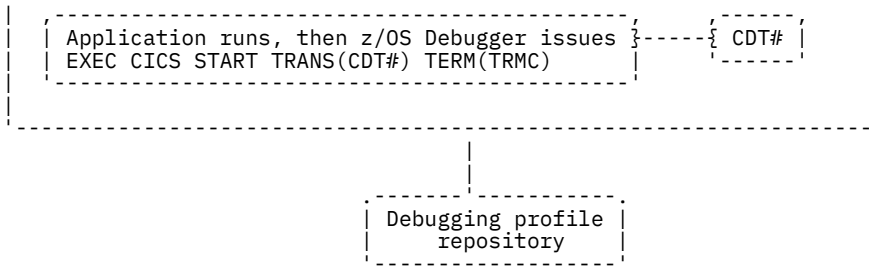

For this scenario to work, the CICS system administrator must complete the following tasks for the AOR:

- Define z/OS Debugger resources in the CICS CSD and install them in the CICS region, as described in Chapter 12, “Adding support for debugging under CICS,” on page 91, step “1” on page 91.
- Provide access to these resources, as described in Chapter 12, “Adding support for debugging under CICS,” on page 91, step “2.a” on page 91.
- If you are using CADP to manage debugging profiles, then run the correct programs and use the correct CICS start up parameters, as described in Chapter 12, “Adding support for debugging under CICS,” on page 91, Chapter 12, “Adding support for debugging under CICS,” on page 91, step “5.d” on page 93, “6.b” on page 93, “9.b” on page 94, and “Enabling the CADP transaction” on page 101.

## Screen control mode terminal connects to a TOR and application runs in an AOR

In this scenario, the user starts the DTSC transaction on the display terminal to display the debug session. DTSC must run in the same region as the application, but could run in any of the following situations:

- As a Transaction-Routed transaction
- On a CRTE terminal session which was started on the AOR

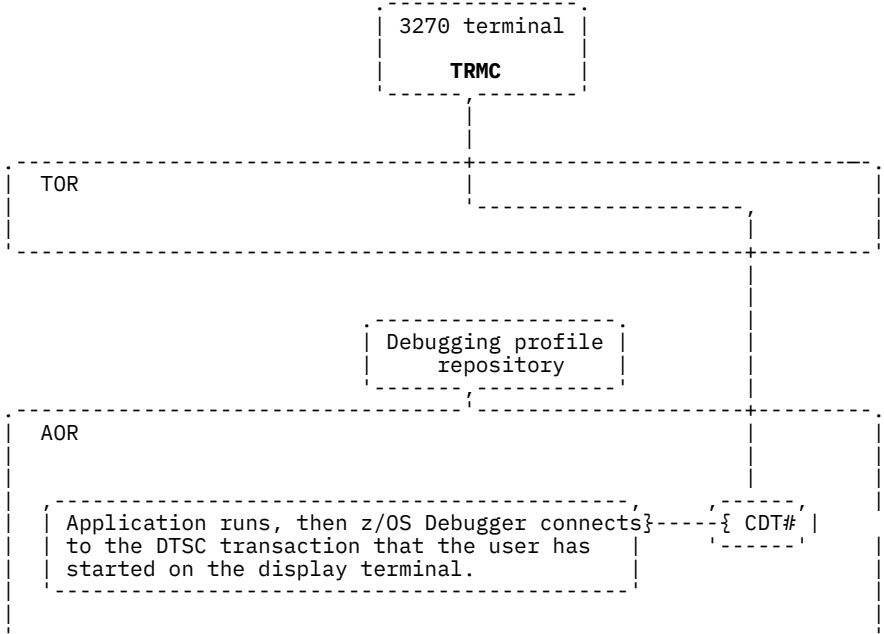

## Separate terminal mode terminal connects to a TOR and application runs in an AOR

In this scenario, your terminal (TRMC) connects to a TOR and the following sequence of events occurs:

1. You store a debugging profile into a repository using either DTCN or CADP.
2. The application starts. The profile matches the application so z/OS Debugger is started.

3. z/OS Debugger issues EXEC CICS START of its display transaction (CDT#) on your terminal (TRMC). However, your terminal is not found. XICTENF/XALTENF identifies the TOR as the owner of your terminal (TRMC).
4. CICS routes the START task to the TOR identified by XICTENF/XALTENF.
5. Interval Control in the TOR associates the START task with your terminal (TRMC) and then routes the START task back to the AOR.
6. CDT# establishes the communication between your terminal and the application through the TOR.

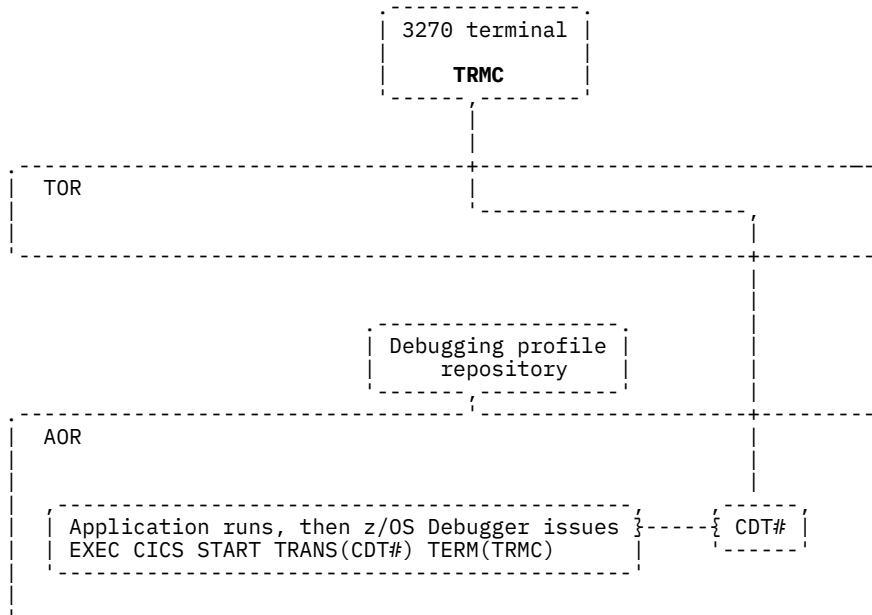

For this scenario to work, the CICS system administrator must complete the following tasks for the TOR:

- If you are using DTCN to manage debugging profiles, do the following tasks:
  - Define z/OS Debugger resources in the CICS CSD and install them in the CICS region, as described in [Chapter 12, “Adding support for debugging under CICS,” on page 91, step “1” on page 91.](#)
  - Provide access to these resources, as described in [Chapter 12, “Adding support for debugging under CICS,” on page 91, step “2.a” on page 91.](#)
- If you are using CADP to manage debugging profiles, then run the correct programs and use the correct CICS start up parameters, as described in [Chapter 12, “Adding support for debugging under CICS,” on page 91, Chapter 12, “Adding support for debugging under CICS,” on page 91, step “5.d” on page 93, “6.b” on page 93, “9.b” on page 94, and “Enabling the CADP transaction” on page 101.](#)
- Enable routing of the terminal traffic to the correct terminal by configuring the z/OS Debugger transaction CDT# as DYNAMIC(YES).
- If your CICS region has a Temporary Storage Model (TSMODEL) that can make queues with a prefix of "CDT#" recoverable, you must create a TSMODEL that specifies PREFIX(CDT#) and RECOVERY(NO).

For this scenario to work, the CICS system administrator must complete the following tasks for the AOR:

- If you are using DTCN to manage debugging profiles, do the following tasks:
  - Define z/OS Debugger resources in the CICS CSD and install them in the CICS region, as described in [Chapter 12, “Adding support for debugging under CICS,” on page 91, step “1” on page 91.](#)
  - Provide access to these resources, as described in [Chapter 12, “Adding support for debugging under CICS,” on page 91, step “2.a” on page 91.](#)
- If you are using CADP to manage debugging profiles, then run the correct programs and use the correct CICS start up parameters, as described in [Chapter 12, “Adding support for debugging under CICS,” on page 91, Chapter 12, “Adding support for debugging under CICS,” on page 91, step “5.d” on page 93, “6.b” on page 93, “9.b” on page 94, and “Enabling the CADP transaction” on page 101.](#)

- To locate the terminal, do the following steps:
  - Code the CICS exits XICTENF and XALTENF so that the TOR is identified as the owner of the display terminal. The *CICS Transaction Server for z/OS Customization Guide* describes these exits.
  - Run a PLT program that enables the CICS exits XICTENF and XALTENF. The *CICS Transaction Server for z/OS Customization Guide* describes how to write and run a PLT.
  - Enable routing of the terminal traffic to the correct terminal by configuring the z/OS Debugger transaction CDT# as DYNAMIC(YES).
  - If your CICS region has a Temporary Storage Model (TSMODEL) that can make queues with a prefix of "CDT#" recoverable, you must create a TSMODEL that specifies PREFIX(CDT#) and RECOVERY(NO).

## Authorizing DTST transaction to modify storage

**Note:** This section is not applicable to IBM Developer for z/OS (non-Enterprise Edition) or IBM Wazi Developer for Red Hat CodeReady Workspaces.

This topic describes the steps you must take to authorize the DTST transaction to modify either USER-key storage, CICS-key storage, or both. DTST does not allow users to modify Key-0 storage.

The following resources control DTST authorizations:

- EQADTOOL.DTSTMUSERK, which controls the ability to modify USER-key storage.
- EQADTOOL.DTSTMDCICSK, which controls the ability to modify CICS-key storage.

1. Establish profiles in the FACILITY class by entering the following RDEFINE commands:

```
RDEFINE FACILITY EQADTOOL.DTSTMUSERK UACC(NONE)
RDEFINE FACILITY EQADTOOL.DTSTMDCICSK UACC(NONE)
```

2. Verify that generic profile checking is in effect for the class FACILITY by entering the following command:

```
SETROPTS GENERIC(FACILITY)
```

3. Give a user permission to modify USER-key, CICS-key storage, or both by entering one or both of the following commands, where DUSER1 is the name of a RACF-defined user or group profile:

```
PERMIT EQADTOOL.DTSTMUSERK CLASS(FACILITY) ID(DUSER1) ACCESS(UPDATE)
PERMIT EQADTOOL.DTSTMDCICSK CLASS(FACILITY) ID(DUSER1) ACCESS(UPDATE)
```

Instead of connecting individual users, the security administrator can specify DUSER1 to be a RACF group profile and then connect authorized users to the group.

4. If the FACILITY class is not active, activate the class by entering the following SETROPTS command:

```
SETROPTS CLASSACT(FACILITY)
```

Enter the SETROPTS LIST command to verify that FACILITY class is active.

5. Refresh the FACILITY class by entering the following SETROPTS RACLIST command:

```
SETROPTS RACLIST(FACILITY) REFRESH
```

## Authorizing DTCD and DTCI transactions to delete or deactivate debug profiles

This topic describes the steps you must take to authorize the DTCD and DTCI transactions to delete or deactivate debug profiles stored in a VSAM data set.

The EQADTOOL.DTCDDELETEALL resource controls DTCD authorizations.

The EQADTOOL.DTCIINACTALL resource controls DTCI authorizations.



To authorize DTCD and DTCI users so they can delete or deactivate debug profiles stored in a VSAM data set, do the following steps:

1. Establish profiles in the FACILITY class by entering the following RDEFINE commands:

```
RDEFINE FACILITY EQADTOOL.DTCDDELETEALL UACC(NONE)
RDEFINE FACILITY EQADTOOL.DTCIINACTALL UACC(NONE)
```

2. Verify that generic profile checking is in effect for the class FACILITY by entering the following command:

```
SETROPTS GENERIC(FACILITY)
```

3. Give a user permission to delete or deactivate debug profiles stored in a VSAM data set by entering the following commands, where DUSER1 is the name of a RACF-defined user or group profile:

```
PERMIT EQADTOOL.DTCDDELETEALL CLASS(FACILITY) ID(DUSER1) ACCESS(UPDATE)
PERMIT EQADTOOL.DTCIINACTALL CLASS(FACILITY) ID(DUSER1) ACCESS(UPDATE)
```

Instead of connecting individual users, the security administrator can specify DUSER1 to be a RACF group profile and then connect authorized users to the group.

4. If the FACILITY class is not active, activate the class by entering the following SETROPTS command:

```
SETROPTS CLASSACT(FACILITY)
```

Enter the SETROPTS LIST command to verify that FACILITY class is active.

5. Refresh the FACILITY class by entering the following SETROPTS RACLIST command:

```
SETROPTS RACLIST(FACILITY) REFRESH
```



---

# Chapter 13. Adding support for debugging under IMS

To add support for debugging applications that run in IMS, you need to do the following steps:

1. Choose one of the following methods for specifying TEST runtime options:

- Specifying the TEST runtime options in a data set, created by the application programmers, which is then extracted by a customized version of the Language Environment user exit routine CEEBXITA.
- Specifying the TEST runtime options in one of the following assembler modules:
  - CEEUOPT, which is an assembler module that uses the CEEXOPT macro to set application level defaults, and is link-edited into an application program.
  - CEEROPT, which is an assembler module that uses the CEEXOPT macro to set region level defaults.
- Specifying the TEST runtime options through the EQASET transaction. The transaction allows application programmers to specify a limited set of TEST runtime options.
- Specifying the TEST runtime options in a private message region, created by the application programmer using IBM z/OS Debugger Utilities option 4.3, "Swap IMS Transaction Class and Run Transaction".
- Specifying the TEST runtime options in a private message region, created by the application programmer using IBM z/OS Debugger Utilities option 4.5, "IMS Transaction Isolation Facility".

2. Choose from the following scenarios that best matches your site's environment:

## **Scenario A**

You run programs in IMS Transaction Manager, BTS, or DB and are managing TEST runtime options with a user exit. Do the steps described in [“Scenario A: Running IMS and managing TEST runtime options with a user exit”](#) on page 112 to enable this scenario.

## **Scenario B**

You run programs in IMS Transaction Manager, BTS, or DB and are managing TEST runtime options with CEEUOPT or CEEROPT. Do the steps described in [“Scenario B: Running IMS and managing TEST runtime options with CEEUOPT or CEEROPT”](#) on page 113 to enable this scenario.

## **Scenario C**

You run assembler programs without Language Environment in IMS Transaction Manager and you specify some TEST runtime options with the EQASET transaction. Do the steps described in [“Scenario C: Running assembler program without Language Environment in IMS TM and managing TEST runtime options with EQASET”](#) on page 113 to enable this scenario.

## **Scenario D**

You run programs in an IMSplex environment and are managing TEST runtime options with either a user exit, CEEUOPT, or CEEROPT. Do the steps described in [“Scenario D: Running IMSplex environment”](#) on page 113 to enable this scenario.

## **Scenario E**

You run Message Processing Programs (MPPs) in IMS Transaction Manager, running in Message Processing Regions (MPRs). You want to isolate application program debugging and to avoid scheduling delays or conflicts with programs which are not being debugged. Do the steps described in [“Scenario E: Enabling users to launch private message regions and to assign transactions to private message regions”](#) on page 114 to enable this scenario.

## **Scenario F**

You run Message Processing Programs (MPPs) in IMS Transaction Manager, running in Message Processing Regions (MPRs). You want to isolate application program debugging and to avoid scheduling delays or conflicts with programs which are not being debugged. Do the steps described in [“Scenario F: Enabling the Transaction Isolation Facility”](#) on page 115 to enable this scenario. The IMS Transaction Isolation Facility is not available in IBM Wazi Developer for Red Hat CodeReady Workspaces.

You can select more than one scenario. If you select more than one scenario, some steps are repeated. Perform those steps only once.

3. After you have selected the method that your site will use to manage TEST runtime options, notify your application programmers of the chosen method. Ensure that the application programmers follow the directions described in "Preparing an IMS program" in the *IBM z/OS Debugger User's Guide* and choose the correct method for specifying TEST runtime options. If your application programmers are using the EQASET transaction to specify TEST runtime options, ensure that they follow the directions described in "Running the EQASET transaction" in the *IBM z/OS Debugger User's Guide*.

## Scenario A: Running IMS and managing TEST runtime options with a user exit

---

Do the following steps to enable this scenario:

1. Include the z/OS Debugger *h1q*.SEQAMOD<sup>25</sup> data set and the Language Environment CEE.SCEERUN<sup>26</sup> runtime library in the STEPLIB concatenation of your IMS region.
2. To give IMS users enough time to run and debug their applications, increase the time-out limit in the message-processing region (MPR) region to 1440.
3. If you need to change the naming pattern of the data set containing the user's TEST runtime options, see the following topics for details:

- [Chapter 8, "Specifying the TEST runtime options through the Language Environment user exit," on page 61](#)
- ["Customizing z/OS Debugger User Exit Data Set" on page 80](#)

The user will use DTU option 'z/OS Debugger User Exit Data Set' to set the TEST runtime options they want.

4. If the IMS transaction is initiated from the web or MQ gateway, it is run with a generic ID. z/OS Debugger supports a cross reference table to tie such a transaction to a user's ID. To set the name of that cross reference table, see the following topics for details:

- [Chapter 8, "Specifying the TEST runtime options through the Language Environment user exit," on page 61](#)
- ["Customizing IMS Transaction and User ID Cross Reference Table" on page 83](#)

The user will use DTU option 'IMS Transaction and User ID Cross Reference Table' to specify the transaction name to user ID cross reference.

5. See [Chapter 8, "Specifying the TEST runtime options through the Language Environment user exit," on page 61](#) and ["Customizing z/OS Debugger User Exit Data Set" on page 80](#) for information about customizing the user exit (if needed).
6. If the IMS transaction is initiated from the web or MQ gateway, it is run with a generic ID. If your site has this situation, see ["Activate the cross reference function and modifying the cross reference table data set name" on page 64](#) for information about customizing the user exit to enable a cross reference table and ["Customizing IMS Transaction and User ID Cross Reference Table" on page 83](#) for setting up IBM z/OS Debugger Utilities so that the user can access the table.

---

<sup>25</sup> Add *h1q*.SEQAMOD to STEPLIB only if it is not already in the system search path (for example, link list). If you create a custom EQAOPTS (as described in [Chapter 16, "EQAOPTS commands," on page 131](#)) that is not stored in *h1q*.SEQAMOD, then place the data set containing it in STEPLIB (ahead of *h1q*.SEQAMOD if it is in STEPLIB). *h1q*.SEQAMOD must be placed before any other library in the STEPLIB that contains CEEVDBG for z/OS Debugger to get control of a debug session.

<sup>26</sup> Add CEE.SCEERUN to STEPLIB only if it is not already in the system search path (for example, link list). If you create a private copy of the z/OS Debugger Language Environment user exit for IMS that is linked into CEEBINIT (as described in [Chapter 8, "Specifying the TEST runtime options through the Language Environment user exit," on page 61](#)), then place the data set containing it in STEPLIB (ahead of CEE.SCEERUN if it is in STEPLIB).

## Scenario B: Running IMS and managing TEST runtime options with CEEUOPT or CEEROPT

---

Do the following steps to enable this scenario:

1. Include the z/OS Debugger *h1q*.SEQAMOD<sup>27</sup> data set and the Language Environment CEE.SCEERUN runtime library in the STEPLIB concatenation of the IMS MPR or MPP region running your program.
2. To give IMS users enough time to run and debug their applications, increase the time-out limit in the message-processing region (MPR) region to 1440.

## Scenario C: Running assembler program without Language Environment in IMS TM and managing TEST runtime options with EQASET

---

Do the following steps to enable this scenario:

1. Copy the load modules EQANIAFE and EQANISSET from the *h1q*.SEQAMOD data set into the IMS.PGMLIB data set.
2. Define the following IMS transaction:

```
APPLCTN GPSB=EQANISSET,PGMTPY=TP,LANG=ASSEM HIDAM/OSAM
TRANSACTION CODE=EQASET,MODE=SNGL,
 DCLWA=NO,EDIT=UC,INQ=(YES,NORECOV),
MSGTYPE=(SNGLSEG,NONRESPONSE,1) X
 X
```

3. Add the application front end parameter APPLFE=EQANIAFE to the MPR start up job.
4. Assign the EQASET transaction to a class served by the MPR that is started with the APPLFE=EQANIAFE parameter.
5. Include the z/OS Debugger *h1q*.SEQAMOD<sup>28</sup> data set in the STEPLIB concatenation of the IMS MPR or MPP region running your program.
6. To give IMS users enough time to run and debug their applications, increase the time-out limit in the message-processing region (MPR) region to 1440.

## Scenario D: Running IMSplex environment

---

Do the following steps to enable this scenario:

1. Include the z/OS Debugger *h1q*.SEQAMOD<sup>29</sup> data set and the Language Environment CEE.SCEERUN runtime library in the STEPLIB concatenation of the IMS MPR or MPP region running your program.

---

<sup>27</sup> Add *h1q*.SEQAMOD to STEPLIB only if it is not already in the system search path (for example, link list). If you create a custom EQAOPTS (as described in [Chapter 16, “EQAOPTS commands,”](#) on page 131) that is not stored in *h1q*.SEQAMOD, then place the data set containing it in STEPLIB (ahead of *h1q*.SEQAMOD if it is in STEPLIB). *h1q*.SEQAMOD must be placed before any other library in the STEPLIB that contains CEEVDBG for z/OS Debugger to get control of a debug session.

<sup>28</sup> Add *h1q*.SEQAMOD to STEPLIB only if it is not already in the system search path (for example, link list). If you create a custom EQAOPTS (as described in [Chapter 16, “EQAOPTS commands,”](#) on page 131) that is not stored in *h1q*.SEQAMOD, then place the data set containing it in STEPLIB (ahead of *h1q*.SEQAMOD if it is in STEPLIB). *h1q*.SEQAMOD must be placed before any other library in the STEPLIB that contains CEEVDBG for z/OS Debugger to get control of a debug session.

<sup>29</sup> Add *h1q*.SEQAMOD to STEPLIB only if it is not already in the system search path (for example, link list). If you create a custom EQAOPTS (as described in [Chapter 16, “EQAOPTS commands,”](#) on page 131) that is not stored in *h1q*.SEQAMOD, then place the data set containing it in STEPLIB (ahead of *h1q*.SEQAMOD if it is in STEPLIB). *h1q*.SEQAMOD must be placed before any other library in the STEPLIB that contains CEEVDBG for z/OS Debugger to get control of a debug session.

2. To give IMS users enough time to run and debug their applications, increase the time-out limit in the message-processing region (MPR) region to 1440.
3. If you are using a user exit and you need to change the naming pattern of the data set containing the user's TEST runtime options, see the following topics for details:
  - [Chapter 8, “Specifying the TEST runtime options through the Language Environment user exit,” on page 61](#)
  - [“Customizing z/OS Debugger User Exit Data Set” on page 80](#)

The user can use DTU option 'z/OS Debugger User Exit Data Set' to set the TEST runtime options they want.

## Scenario E: Enabling users to launch private message regions and to assign transactions to private message regions

Do the following steps to enable this scenario:

1. Define the following IMS batch message program:

```
APPLCTN GPSPB=EQANBSWT , LANG=ASSEM , PGMTYPE=(BATCH) , X
 SCHDTYP=PARALLEL
TRANSACT CODE=(EQANBSWT) , AOI=TRAN , X
 MSGTYPE=(SNGLSEG , NONRESPONSE)
```

2. Define the user EQANBSWT to RACF, and permit it READ access to the ASSIGN, DISPLAY, START and STOP IMS commands:

```
ADDUSER EQANBSWT NOPASSWORD DFLTGRP(SYS1)
PE ASS CLASS(CIMS) ID(EQANBSWT) ACC(UPDATE)
PE DIS CLASS(CIMS) ID(EQANBSWT) ACC(UPDATE)
PE STA CLASS(CIMS) ID(EQANBSWT) ACC(UPDATE)
PE STO CLASS(CIMS) ID(EQANBSWT) ACC(UPDATE)
SETROPTS RACLIST(CIMS) REFRESH
```

3. Enable users to create private message region templates. Users that are authorized for this function use IBM z/OS Debugger Utilities option 4.4, "Manage IMS Transaction Templates" to create and edit the templates. The templates are stored in one or more z/OS Debugger Setup Utility data sets.

To control access to the Manage IMS Transaction Templates panel, create RACF FACILITY EQADTOOL.IMSTEMPCREATE with UACC(NONE). Then, PERMIT users who might access the panel ACC(READ) to the FACILITY.

An alternative approach is to grant UACC(READ) for EQADTOOL.IMSTEMPCREATE FACILITY. Then, access to the common IMS message region template data sets can be controlled by using RACF data set security.

4. Customize the IBM z/OS Debugger Utilities ISPF interface for IMS TM Debugging. See [“Customizing debugging by using IMS message region templates” on page 79](#) for more information about this task.

After the above steps are completed, users who are authorized to EQADTOOL.IMSTEMPCREATE FACILITY can create one or more z/OS Debugger Setup Utility data sets that contain IMS message region templates. Application programmers use the message region templates to schedule individual transactions in private message regions. See section "Using IMS message region templates to dynamically swap transaction class and debug in a private message region" in the *IBM z/OS Debugger User's Guide* for more information about how application programmers use the message region templates.

To create message region templates, complete the following steps:

1. Start IBM z/OS Debugger Utilities. See "Starting IBM z/OS Debugger Utilities" in the *IBM z/OS Debugger User's Guide* for detailed information.
2. In the IBM z/OS Debugger Utilities panel (EQA@PRIM), type 4 in the Option line and press Enter.
3. In the Manage IMS Programs panel (EQAPRIS), type 4 in the Option line and press Enter.

4. In the Create IMS MPR Templates panel (EQAPMPXS), type the name of the z/OS Debugger Setup Utility data set that you want to use in the Template Data Set field. Then, type an I in the Sel column of the table at the bottom of the panel, and press Enter.
5. In the Manage Message Regions - Edit Setup File panel (EQAPFORA), the Data Set Name is pre-filled from the data set name that was entered on the EQAPMPXS panel. Complete the data set name by entering a member name in parentheses, and press Enter.
6. In the Edit Setup File panel (EQAPMPRX), enter a description of the template in the Comment field. Then, type COPY on the command line and press Enter.
7. In the z/OS Debugger Foreground - Copy from Setup File or JCL panel (EQAPCPY), type the name of a data set that contains one of the following information:
  - Job Control Language (JCL) decks for IMS Message Processing Regions
  - z/OS Debugger Setup Utility (DTSU) files

If you do not specify a member for a PDS, you can select from a member list on the ISRUDSM panel.
8. If you selected to copy from a JCL data set, the z/OS Debugger Foreground - Copy from JCL Dataset panel (EQAPCJ) is displayed. Select the job cards that you want to copy into the message region template, and press Enter.
9. After the JCL has been imported to your message region template, type a forward slash (/) beside Enter / to modify parameters, and press Enter.
10. In the Parameters for IMS Procedures panel (EQAPRIP1), change the Classes fields to specify a class that is reserved for application programmers by using z/OS Debugger. Then press PF3 to exit.
11. Adjust the data set list as needed and then press PF3 to exit. The message region template is saved.

## Scenario F: Enabling the Transaction Isolation Facility

---

**Note:** The IMS Transaction Isolation Facility is not available in IBM Wazi Developer for Red Hat CodeReady Workspaces.

The IMS Transaction Isolation Facility of z/OS Debugger allows users to register to debug transactions in any IMS subsystem that is enabled for the facility. Each user may also launch a private message-processing region in which the selected message processing programs will run. The actions in this section will guide you through the setup of this facility.

The IMS Transaction Isolation Facility requires that the following resources be created or reserved for z/OS Debugger users:

1. A set of IMS message classes reserved for the private message-processing regions.
2. For each reserved message class, a set of IMS program resources with the name EQATccc*n*, where *ccc* is the three-digit class number, and *n* is an ordinal number from 1 to the maximum number of transactions a single user can register to debug.

Also, for each reserved message class, a set of IMS transaction resources must be defined. A set of non-conversational transactions with the names EQATccc*n* and a set of conversational transactions with the names EQACccc*n* must be defined, where *ccc* is the three-digit class number, and *n* is an ordinal number from 1 to the maximum number of transactions a single user can register to debug.

Do the following steps to enable this scenario:

1. Customize and run the EQAWTIVS sample member. A VSAM data set is created to be used as a repository to store the IMS Transaction Isolation information when the IMS system is stopped.
2. Customize and run the EQAWTIMS sample member to link-edit the z/OS Debugger exits into an IMS system control region load library data set. Note that this library must be a PDS, not a PDSE. z/OS Debugger implements the following exits for the IMS Transaction Isolation Facility:
  - DFSMSCE0 - TM and MSC Message Routing and Control User exit routine, as an alias of EQATIEXT
  - EQATIEDT - Transaction Code (Input) edit routine for EQA\*ccc*n* transactions
3. Customize the EQAOPTS sample and create the EQAOPTS load module.

The EQAOPTS sample builds a set of EQAOPTS commands into a data-only load module. For more information about the EQAOPTS commands, see [Chapter 16, “EQAOPTS commands,”](#) on page 131.

The following EQAOPTS command applies to the IMS Transaction Isolation Facility:

### MAXTRANUSER

This command specifies the maximum number of transactions that a single user can register to debug. The default value is 15.

4. Modify the IMS system by performing the following actions:
  - a. Ensure that the following load libraries are in the search path for the IMS system control region:
    - The load library with the z/OS Debugger IMS exits link-edited in step 2
    - The library that contains the EQAOPTS load module generated in step 3
  - b. Add the VSAM data set created in step 1 to the IMS system control region by using DD name EQATIVSM.
  - c. If your IMS system uses the DFSMSCEO exit to route transaction messages, perform the following actions:
    - i) Remove the load library that contains your DFSMSCEO exit from the STEPLIB or JOBLIB concatenation of the IMS control region.

If you cannot remove the load library, ensure that the load library with the z/OS Debugger version of DFSMSCEO appears before your DFSMSCEO exit in the search path.
    - ii) Identify your DFSMSCEO exit location to z/OS Debugger by adding the load library that contains your DFSMSCEO exit to the IMS system control region by using DD name EQAIMEXT.

After you complete the actions, start or restart the IMS system.

5. Define the user EQANBSWT to RACF, and permit it READ access to the ASSIGN, DISPLAY, START, and STOP IMS commands:

```
ADDUSER EQANBSWT NOPASSWORD DFLTGRP(SYS1)
PE ASS CLASS(CIMS) ID(EQANBSWT) ACC(UPDATE)
PE DIS CLASS(CIMS) ID(EQANBSWT) ACC(UPDATE)
PE STA CLASS(CIMS) ID(EQANBSWT) ACC(UPDATE)
PE STO CLASS(CIMS) ID(EQANBSWT) ACC(UPDATE)
SETROPTS RACLIST(CIMS) REFRESH
```

6. Give the user ID for each IMS control region authority to modify the VSAM data set created in step 1.
7. Enable administrative users to configure the IMS Transaction Isolation Facility. Users that are authorized for this function use IBM z/OS Debugger Utilities option 4, suboption 6 "Administer IMS Transaction Isolation Environment", to reserve message classes for z/OS Debugger usage, and to generate other artifacts for the IMS Transaction Isolation Facility.

To control access to the Administer IMS Transaction Isolation Environment panel, create RACF FACILITY EQADTOOL.IMSTRANISOADMIN with UACC(NONE). Permit users who might access the panel ACC(READ) to the FACILITY.

8. Use IBM z/OS Debugger Utilities option 4, suboption 6 "Administer IMS Transaction Isolation Environment" to reserve message classes for use by the IMS Transaction Isolation Facility. Ensure that these classes are not in use for other dependent regions in your IMS system.

When multiple versions of IMS subsystems are installed on your system, you can use suboption 6 to provide a specific RESLIB used by this IMS subsystem. If no RESLIB is specified on suboption 6, the one from us5imrsl in EQAZDFLT is used as the default.

9. Customize the *hlq*.SEQASAMP (EQAWICRT) sample job and submit the job to generate one or both of the following resource definitions:
  - Stage-1 IMS system definition macros to create the necessary IMS resources for the classes you have selected. The macros are generated to the data set with the DD name EQARESDS.
  - Type-2 IMS commands to create the necessary IMS resources for the classes you have selected. The commands are generated to the data set with the DD name EQATY2DS.



10. Use the resource definitions from step 9 to update the IMS system definition, preferably by using the Type 2 commands to update the system dynamically, if you are using Dynamic Resource Definition (DRD). Otherwise, add the Type 1 commands to the stage 1 input to your system definition process, and regenerate the IMS system definition. Restart the IMS system, if necessary, to pick up the changes.
11. Add any important IMS PROCLIBs to EQAZPROC in *hlq*.SEQATLIB. This action allows IBM z/OS Debugger Utilities to expand any IMS PROCs that are discovered when the execution environment of the selected transaction is cloned.
12. Additional customization parameters are available in member EQAZDFLT of *hlq*.SEQATLIB library. To set the value for any of these parameters, remove the preceding comment character (!) and specify the value, followed by a semicolon (;).

```

!*
! Default job name for dynamic IMS MPR creation
!*
! Up to 7 characters of the user's TSO user ID will be substituted
! for the string &&user&&.
!*
mprdebug = ! Job name for debugging
 &&user&& ; 1 ! IMS MPR
!*
! Specify the name of the main IMS RESLIB. This will be the first
! data set in the STEPLIB for the batch job that runs the EQANBSWT
! BMP program.
!*
!us5imrsl = ; 2
!us5dtmod = ; 3
!us5dtce1 = ; 4

!us5trnft = ; 5
!us5trnmx = ; 6

!us5adspc = ; 7 ! Override for JOB parm ADDRSPC
!us5bytes = ; ! Override for JOB parm BYTES
!us5cards = ; ! Override for JOB parm CARDS
!us5ccsid = ; ! Override for JOB parm CCSID
!us5class = ; ! Override for JOB parm CLASS
!us5cond = ; ! Override for JOB parm COND
!us5group = ; ! Override for JOB parm GROUP
!us5jeslg = ; ! Override for JOB parm JESLOG
!us5lines = ; ! Override for JOB parm LINES
!us5melim = ; ! Override for JOB parm MEMLIMIT
!us5msgcl = ; ! Override for JOB parm MSGCLASS
!us5msglv = ; ! Override for JOB parm MSGLEVEL
!us5notify = ; ! Override for JOB parm NOTIFY
!us5pages = ; ! Override for JOB parm PAGES
!us5passwd = ; ! Override for JOB parm PASSWORD
!us5perf = ; ! Override for JOB parm PERFORM
!us5prty = ; ! Override for JOB parm PRTY
!us5rd = ; ! Override for JOB parm RD
!us5regn = ; ! Override for JOB parm REGION
!us5rstrt = ; ! Override for JOB parm RESTART
!us5seclb = ; ! Override for JOB parm SECLABEL
!us5schen = ; ! Override for JOB parm SCHENV
!us5time = ; ! Override for JOB parm TIME
!us5typrn = ; ! Override for JOB parm TYPRUN
!us5user = ; ! Override for JOB parm USER

```

### **1** mprdebug

Establishes the pattern that is used to create the job name for any private message regions started by users of the IMS Transaction Isolation Facility. The user's TSO ID is substituted in the string where &&user&& appears.

### **2** us5imrsl

Identifies the IMS RESLIB to use when tasks are performed for the IMS Transaction Isolation Facility. This parameter is necessary only when the proper IMS RESLIB is not in the link list concatenation.

This setting applies to IMS subsystems where the RESLIB is not specified with IBM z/OS Debugger Utilities option 4.6. If the client needs to use a specific RESLIB for a particular IMS subsystem, specify the RESLIB with option 4.6.

**3 us5dtmod**

Identifies the z/OS Debugger SEQAMOD library to use when tasks are performed for the IMS Transaction Isolation Facility. This parameter is necessary only when the proper z/OS Debugger SEQAMOD library is not in the link list concatenation.

**4 us5dtce1**

Identifies the z/OS MVS Language Environment runtime library (CEERUN) to use when tasks are performed for the IMS Transaction Isolation Facility. This parameter is necessary only when the proper Language Environment library is not in the link list concatenation.

**5 us5trnft**

Defines the default transaction name filter when a new user accesses the EQAPMPSL panel for the first time.

**6 us5trnmX**

Defines the default maximum number of transactions that is returned to the user on the EQAPMPSL panel. A value of 0 returns the entire list of transactions, which can have a significant performance impact if your IMS system has defined many transactions.

**7 JOB parameter overrides**

Use these parameters to specify or override any parameters on the JOB statement that is created based on the JOB statement of the “cloned” message region.

For more information about how application programmers use the IMS Transaction Isolation Facility, see the section "Using IMS Transaction Isolation to create a private message-processing region and select transactions to debug" in the *IBM z/OS Debugger User's Guide*.

## Sample customization of the IMS Transaction Isolation Facility

Here is an example of the customization of IMS Transaction Isolation Facility at a typical client location. In this example, the system has the following features:

- The IMS sub system name is IMSA.
- The IMS product high-level qualifier is PROD.IMSV14.
- Dynamic Resource Definition (DRD) is active.
- The maximum number of transactions, which is defined by the MAXCLAS parameter of the IMSCTRL system definition macro, is 200.
- Dependent regions currently defined in the system serve classes in the range 21 - 100.
- The IBM z/OS Debugger data sets are installed under the high-level qualifier ZDEBUG.

The IMS administrator decides that 10 region classes are reserved for IMS Isolation users, which means that 10 users can debug in private message regions simultaneously.

As the class range 21 - 100 is used for normal development and test activity, the IMS Isolation classes must be in the range 1 - 20 and 101 - 200. The IMS administrator chooses classes 131-140 to reserve for IMS Isolation users.

Next, the IMS administrator performs the following steps to prepare the IMS control region to run with IMS Isolation:

1. Edit the ZDEBUG.SEQASAMP(EQAWTIVS) member and SUBMIT it to create the VSAM data set PROD.ZDEBUG.EQATITBL.

```

//EQAWTIVS JOB
//*****
//* DELETE THE EXISTING FILE *
//*****
//DELETE EXEC PGM=IDCAMS,REGION=1M
//SYSPRINT DD SYSOUT=*
//SYSIN DD *
DELETE PROD.ZDEBUG.EQATITBL
SET MAXCC=0
/*
//*****
//* DEFINE A NEW VSAM DEBUGGING PROFILE DATASET *
//*****
//DEFINE EXEC PGM=IDCAMS,REGION=1M
//SYSPRINT DD SYSOUT=*
//SYSIN DD *
/* */
/* DEFINE IMS ISOLATION */
/* TABLE INDEX AND PATH */
/* DATA SETS */
/* */
DEFINE CLUSTER (RECORDS(999) -
NAME (PROD.ZDEBUG.EQATITBL) -
SHAREOPTIONS(2 3) -
LOG(NONE) -
INDEXED) -
DATA -
(RECSZ(200,200) -
NAME (PROD.ZDEBUG.EQATITBL.DATA) -
KEYS(11 0) -
FREESPACE(10 10) -
BUFFERSPACE (20000)) -
INDEX -
(NAME(PROD.ZDEBUG.EQATITBL.INDX))
/*

```

2. Edit the ZDEBUG.SEQASAMP(EQAWTIVS) member and submit it to link-edit the IMS Isolation exits by using the current level of IMS. The exits are placed in PROD.ZDEBUG.IMSISO.LOADLIB.

```

//EQAWTIMS JOB
// SET DTHLQ=ZDEBUG
// SET IMSHLQ=PROD.IMSV14
//*****
/* Link-edit the EQATIEDT user exit (transaction message edit) *
//*****
//LINK1 EXEC PGM=IEWL,COND=(4,LE),REGION=17M,
// PARM=('OPTIONS=OPTIONS')
//SYSUT1 DD UNIT=SYSVIO,SPACE=(TRK,(10,80))
//SYSPRINT DD SYSOUT=*
//SYSLMOD DD DSN=PROD.ZDEBUG.IMSISO.LOADLIB,DISP=SHR
//SYSLIB DD DSN=&DTHLQ..SEQAMOD,DISP=SHR
// DD DSN=&IMSHLQ..SDFSRESL,DISP=SHR
//OPTIONS DD *
LIST,XREF,LET,MAP
//SYSLIN DD *
MODE AMODE(31),RMODE(ANY)
INCLUDE SYSLIB(DFSCSI00)
REPLACE DFSCSII0
INCLUDE SYSLIB(EQATIEDT)
ENTRY EQATIEDT
NAME EQATIEDT(R)
/*
//*****
/* Link-edit the DFSMSCE0 user exit (transaction routing) *
//*****
//LINK2 EXEC PGM=IEWL,COND=(4,LE),REGION=17M,
// PARM=('OPTIONS=OPTIONS')
//SYSUT1 DD UNIT=SYSVIO,SPACE=(TRK,(10,80))
//SYSPRINT DD SYSOUT=*
//SYSLMOD DD DSN=PROD.ZDEBUG.IMSISO.LOADLIB,DISP=SHR
//SYSLIB DD DSN=&DTHLQ..SEQAMOD,DISP=SHR
// DD DSN=&IMSHLQ..SDFSRESL,DISP=SHR
//OPTIONS DD *
LIST,XREF,LET,MAP
//SYSLIN DD *
MODE AMODE(31),RMODE(ANY)
INCLUDE SYSLIB(DFSCSI00)
REPLACE DFSCSIF0
INCLUDE SYSLIB(EQATIEXT)
ENTRY EQATIEXT
ALIAS DFSMSCE0
NAME EQATIEXT(R)
/*

```

3. Edit the ZDEBUG.SEQASAMP(EQAOPTS) member and submit it to create the EQAOPTS load module:
  - a. Use Delay Debug in the private IMS message processing regions, with the naming pattern 'USR.<userid>.DLAYDBG.EQAUOPTS'.
  - b. Limit each IMS Isolation user to registering for four transactions.

```

//EQAOPTS JOB 5724-T07,MSGLEVEL=(1,1),MSGCLASS=A
/*PROC JCLLIB ORDER=(ASM.SASMSAM1)
// SET GPFLIB=ZDEBUG.SEQASAMP
// SET GPFLMOD=PROD.ZDEBUG.IMSISO.LOADLIB
//*
//ASMGL EXEC ASMACL,REGION=6M,PARM.L='MAP,LET,LIST,XREF,RENT'
//C.SYSLIB DD DSN=&GPFLIB.,DISP=SHR
// DD DSN=SYS1.MACLIB,DISP=SHR
//C.SYSIN DD *
EQAOPTS CSECT ,
EQAOPTS AMODE 31
EQAOPTS RMODE ANY
EQAXOPT DLAYDBGDSN,'USR.&&USERID.DLAYDBG.EQAUOPTS'
EQAXOPT MAXTRANUSER,4
EQAXOPT END
END ,
//L.SYSLMOD DD DISP=SHR,DSN=&GPFLMOD.
//L.SYSIN DD *
NAME EQAOPTS(R)
/*

```

4. Place the new data sets in the IMS control region JCL. The following customizations are required:

- a. APF-authorize the customized IMS exit and EQAOPTS load library (PROD.ZDEBUG.IMSISO.LOADLIB).
- b. Add the EQAOPTS load library to the STEPLIB concatenation. Ensure that the library is in the search path before the ZDEBUG.SEQAMOD data set.
- c. Add a new DD card called EQATIVSM for the VSAM data set created in Step 1 (PROD.ZDEBUG.EQATITBL).

```
//IMSACTAM PROC SOUT=A,DPTY='(14,15)',RGN=0M
//IEFPROC EXEC PGM=DFSMVRC0,DPRTY=&DPTY,REGION=&RGN,
// PARM='&CTL,&RGSUF,&PARM1,&PARM2'
...
//STEPLIB DD DSN=PROD.ZDEBUG.IMSISO.LOADLIB,DISP=SHR b
// DD DSN=PROD.ZDEBUG.SEQAMOD,DISP=SHR
// DD DSN=PROD.IMS.LOADLIB,DISP=SHR
// DD DSN=PROD.IMSEXIT.LOADLIB,DISP=SHR c
...
//QBLKS DD DSN=PROD.IMS01.QBLKS,DISP=OLD
//SHMSG DD DSN=PROD.IMS01.SHMSG,DISP=OLD
//LGMSG DD DSN=PROD.IMS01.LGMSG,DISP=OLD
...
//***** FAST PATH DD CARDS *****
//*
//MSDBCP1 DD DSN=PROD.IMS01.MSDBCP1,DISP=SHR
//MSDBCP2 DD DSN=PROD.IMS01.MSDBCP2,DISP=SHR
//MSDBDUMP DD DSN=PROD.IMS01.MSDBDMP,DISP=SHR
//MSDBINIT DD DSN=PROD.IMS01.MSDBINIT,DISP=SHR
//*
```

5. As the client uses the DFSMSCEO IMS exit in the development and test environment, one other customization is required to ensure that DFSMSCEO of IBMz/OS Debugger takes the processing of the client exit into account. The client's DFSMSCEO is in PROD.IMSEXIT.LOADLIB.
  - a. Ensure that PROD.IMSEXIT.LOADLIB does not appear in STEPLIB or JOBLIB or that it appears in the search path after the data set containing IBM z/OS Debugger's DFSMSCEO exit, for example, PROD.ZDEBUG.IMSISO.LOADLIB.
  - b. Add a new DD card called EQAIMEXT to identify the client DFSMSCEO exit to IBM z/OS Debugger.

```
//IMSACTAM PROC SOUT=A,DPTY='(14,15)',RGN=0M
//IEFPROC EXEC PGM=DFSMVRC0,DPRTY=&DPTY,REGION=&RGN,
// PARM='&CTL,&RGSUF,&PARM1,&PARM2'
...
//***** MFS DD CARDS *****
//*
//FORMATA DD DSN=PROD.MFS.FORMAT,DISP=SHR
//FORMATB DD DSN=PROD.MFS.FORMAT,DISP=SHR
//IMSTFMTA DD DSN=PROD.IMSQA.FMT1,DISP=SHR
//IMSTFMTB DD DSN=PROD.IMSQA.FMT1,DISP=SHR
...
//EQATIVSM DD DSN=PROD.ZDEBUG.EQATITBL,DISP=SHR
//EQAIMEXT DD DSN=PROD.IMSEXIT.LOADLIB,DISP=SHR a
//* b
```

6. Start the IMS control region by using the normal process.
7. A RACF administrator uses the following commands to create a new facility for administering IMS Isolation, and gives the IMS administrator, whose ID is ADMINA, READ access:

```
RDEFINE FACILITY EQADTOOL.IMSTRANISOADMIN UACC(NONE)
PERMIT EQADTOOL.IMSTRANISOADMIN CLASS(FACILITY) ID(ADMINA) ACC(READ)
SETROPTS RACLIST(FACILITY) REFRESH
```

Then, the RACF administrator uses the following commands to authorize the EQANBSWT Batch Messaging Program (BMP) to execute the ASSIGN, DISPLAY, START, and STOP IMS commands:

```

ADDUSER EQANBSWT NOPASSWORD DFLTGRP(SYS1)
PERMIT ASS CLASS(CIMS) ID(EQANBSWT) ACC(UPDATE)
PERMIT DIS CLASS(CIMS) ID(EQANBSWT) ACC(UPDATE)
PERMIT STA CLASS(CIMS) ID(EQANBSWT) ACC(UPDATE)
PERMIT STO CLASS(CIMS) ID(EQANBSWT) ACC(UPDATE)
SETROPTS RACLIST(CIMS) REFRESH

```

- When the control region is started, the IMS administrator needs to access ISPF panel EQAPMPDF by using z/OS Debugger Utilities option 4.6. On this panel, the IMS administrator selects the classes to be reserved for debugging, 131 - 140:

```

+-----+
| IMS debugging preferences Row 126 to 150 of 200 |
| Command ==> Scroll ==> PAGE |
|
| IMS system IMSA |
|
| Place a / next to the message classes that you would like to |
| reserve for the isolation of debug users in your IMS system. |
|
Data set name for program stubs:
Data set name for stage-1 resource definitions:

Data set name for type-2 commands:

Data set name for the IMS RESLIB:

Sel Class number
- 126
- 127
- 128
- 129
- 130
/ 131
/ 132
/ 133
/ 134
/ 135
/ 136
/ 137
/ 138
/ 139
/ 140
- 141
- 142
- 143
- 144
- 145
- 146
- 147
- 148
- 149
- 150
F1=Help F3=Exit F4=IMSIDLst F7=Backward F8=Forward F12=Cancel
+-----+

```

- After selecting the classes for debug, the IMS administrator customizes ZDEBUG.SEQASAMP(EQAWICRT) and uses it to generate a data set that contains type-2 commands. These commands can be used to define resources for IMS Isolation.

```

//EQAWICRT JOB
//*
// SET DTHLQ=ZDEBUG
// SET IMSHLQ=PROD.IMSV14
//DELETE EXEC PGM=IDCAMS,REGION=1M
//SYSPRINT DD SYSOUT=*
//SYSIN DD *
DELETE ADMINA.IMSISO.TYPE2
SET MAXCC=0
/*
//CREATE EXEC PGM=EQANICRT,REGION=0M,
// PARM=('READMASK IMSA')
//EQATY2DS DD DSN=ADMINA.IMSISO.TYPE2,
// DISP=(NEW,CATLG,DELETE),
// SPACE=(TRK,(20,20,0),RLSE),
// DCB=(RECFM=FB,LRECL=80,BLKSIZE=0)
//EQATISPT DD SYSOUT=*
//RESLIB DD DSN=&IMSHLQ..SDFSRESL,DISP=SHR

```

10. Define the following IMS batch message program:

```

APPLCTN GPSB=EQANBSWT, LANG=ASSEM, PGMTYPE=(BATCH), X
 SCHDTYP=PARALLEL
TRANSACT CODE=(EQANBSWT), AOI=TRAN, X
 MSGTYPE=(SNGLSEG, NONRESPONSE)

```

11. The IMS administrator creates a JCL deck to run the batch IMS SPOC utility (CSLUSPOC) to create the resources needed by IMS Isolation.

```

//SPOCBCH JOB
//BATCH EXEC PGM=CSLUSPOC, PARM='IMSPLEX=PLEX2,F=BYCOL'
//STEPLIB DD DSN=PROD.IMSV14.SDFSRESL,DISP=SHR
//SYSPRINT DD SYSOUT=*
//SYSIN DD DSN=ADMINA.IMSISO.TYPE2,DISP=SHR

```

12. The IMS administrator then makes the following ISPF customizations:

- The client keeps all PROCs that are used to create dependent IMS regions in a PROCEDURE library named PROD.IMSV14.PROCLIB. To allow the IMS Isolation Facility to access this library to generate private message regions, the IMS administrator updates ZDEBUG.SEQATLIB(EQAZPROC) to add PROD.IMSV14.PROCLIB:

```

PROD.IMSV14.PROCLIB
SYS1.PROCLIB

```

- The MVS system where IMSA executes has certain rules for jobs submitted to JES. To ensure that private message regions started by IMS Isolation conform to these rules, the IMS administrator updates PROD.ZDEBUG(EQAZDFLT) to specify overrides for various JOB parameters:

```

File Edit Edit_Settings Menu Utilities Compilers Test Help

EDIT PROD.ZDEBUG(EQAZDFLT) - 01.06 Columns 000
Command ==> Scroll =
000205 !us5adspc = ; ! Override for JOB parm ADDRSPC
000206 !us5bytes = ; ! Override for JOB parm BYTES
000207 !us5cards = ; ! Override for JOB parm CARDS
000208 !us5ccsid = ; ! Override for JOB parm CCSID
000209 !us5class = ; ! Override for JOB parm CLASS
000210 !us5cond = ; ! Override for JOB parm COND
000211 !us5group = ; ! Override for JOB parm GROUP
000212 !us5jeslg = ; ! Override for JOB parm JESLOG
000213 !us5lines = ; ! Override for JOB parm LINES
000214 !us5melim = ; ! Override for JOB parm MEMLIMIT
000215 us5msgcl = A ; ! Override for JOB parm MSGCLASS
000216 !us5msglv = ; ! Override for JOB parm MSGLEVEL
000217 us5notify = &SYSUID. ; ! Override for JOB parm NOTIFY
000218 !us5pages = ; ! Override for JOB parm PAGES
000219 !us5passwd = ; ! Override for JOB parm PASSWORD
000220 !us5perf = ; ! Override for JOB parm PERFORM
000221 !us5prty = ; ! Override for JOB parm PRTY
000222 !us5rd = ; ! Override for JOB parm RD
000223 !us5regn = ; ! Override for JOB parm REGION
000224 !us5rstrt = ; ! Override for JOB parm RESTART
000225 !us5seclb = ; ! Override for JOB parm SECLABEL
000226 !us5schen = ; ! Override for JOB parm SCHENV
000227 us5time = 1440 ; ! Override for JOB parm TIME
000228 !us5typrn = ; ! Override for JOB parm TYPRUN
000229 !us5user = ; ! Override for JOB parm USER
000230
000231

```

## Batch interface for the IMS Transaction Isolation Facility

There is also a batch interface that can be used to perform IMS Transaction Isolation functions. A sample of the batch interface is provided in *hlq.SEQASAMP(EQAWTBCH)*.

The batch interface invokes the program EQANIPSB and passes parameters in the PARM= string on the EXEC JCL statement. The syntax and description of each request is as follows:

### REGISTER

Registers a user for a given transaction.

► REGISTER — tran-name — psb-name — ims-system — userid ►

### DEREGISTER

Deregisters a user for a given transaction. This request can also be used to deregister all transactions for the given user ID.

► DEREGISTER — tran-name — ims-system — userid ►  
 ALL — ims-system — userid  
 \*

**Note:** The asterisk (\*) is a wild card that matches any user ID. The transactions for all the users are deregistered if the asterisk (\*) is used.

### START

Starts a private message region for the specified user. The message region is cloned from a message region that is designated to run the specified transaction.

► START — tran-name — psb-name — ims-system — userid ►

### STOP

Stops a private message region for the specified user. This request can also be used to stop all private message regions for the specified IMS system.



```

▶▶ STOP — region-name — ims-system — userid —▶▶
 └──┬──┘
 ALL — ims-system —▶▶

```

### FORCE

Stops a private message region for the specified user, even if the region is busy debugging a transaction. The region is marked as stopped in the IMS Isolation table, and is also set to “not busy”.

```
▶▶ FORCE — region-name — ims-system — userid —▶▶
```

### QUERY

Dumps the contents of the in-memory IMS Transaction Isolation table. The classes reserved for IMS Transaction Isolation, the users that are assigned each class, and the transactions the users have registered for each class are displayed.

```
▶▶ QUERY — ims-system —▶▶
```

### TRACE

Dumps the contents of the in-memory IMS Transaction Isolation trace.

```
▶▶ TRACE — ims-system —▶▶
```

## Installing and configuring the IMS transaction isolation extension for the ADFz Common Components server

### About this task

**Note:** This task is required if your Eclipse IDE users want to use IMS Application with isolation debug configurations. The IMS transaction isolation extension is only available in IBM Developer for z/OS Enterprise Edition.

You must create a configuration file for the IMS transaction isolation extensions for the ADFz Common Components server, and then specify the location of the configuration file to the server.

### Procedure

To configure the IMS transaction isolation extension for the ADFz Common Components server, complete the following steps:

1. Create a sequential MVS data set (FB, LRECL 80) that contains the following records:
  - a) Replace the z/OS Debugger data set names, SEQAMOD, SEQAEXEC, and SEQATLIB with the installed z/OS Debugger data set names.
  - b) Replace the ISPF data set name SISPLOAD with the installed ISPF data set name.
  - c) Replace the IMS data set name SDFSRESL with the installed IMS data set name.

**Note:** Do not change other statements.

```

* IMS transaction isolation view
CONFIG=II
SPAWN_PROGRAM=EQAIIINT
SPAWN_STEPLIB=EQAW.SEQAMOD:
CEE.SCEERUN:
ISP.SISPLOAD:
IMS.SDFSRESL
SPAWN_PARMS_SECTION
SPAWN_DD=EQATIPSB=EQAW.SEQAMOD:
IMS.SDFSRESL:
CEE.SCEERUN
SPAWN_DD=SYSLIB=SYS1.MACLIB
SPAWN_DD=SYSPROC=EQAW.SEQAEXEC
SPAWN_DD=JCLLIB=EQAW.SEQATLIB(EQAZPROC)

```

2. Modify the ADFz Common Components server started proc IPVSRV1.
  - a) Add the configuration data set to the CONFIG DD statement concatenation.
  - b) Set the region size parameter to 200M or 0M. For example, //RUN EXEC PGM=IPVSRV , REGION=200M.
  - c) Stop and restart the ADFz Common Components server.

3. Ensure the user ID (*ownerID*) that owns and starts the proc IPVSRV1 has the following capabilities:

- An OMVS segment. You can use the following command to create the segment:

```
altuser ownerID omvs(home(/u/ownerID) program(/bin/sh))
```

- Read access to BPX.SERVER. You can use the following command to add permission:

```
PE BPX.SERVER CL(FACILITY) ID(ownerID) ACC(READ)
```

4. Inform your users of remote IMS Application with Isolation launch configuration of the following information:

- They need to create a sequential MVS data set (FB, LRECL 80) with the name *userID*.EQATIOUT. The data set is used by the IMS transaction isolation extension as a working data set.
- They need to choose the same encoding scheme as the character encoding scheme of your host system when they add a host connection to IMS transaction isolation extension.

---

## Chapter 14. Enabling the EQAUEDAT user exit

The EQAUEDAT user exit enables the library administrator or system programmer to direct z/OS Debugger to the location where source, listing, or separate debug files are stored. If your site policy is to control the location of these files, this user exit supports this policy by allowing your application programmers to debug their programs without knowing where these files are located.

The provided samples are designed to operate only under Language Environment. If you require an exit to run at any time in a non-Language Environment environment, you must write the exit in assembler and replace the CEEENTRY and CEETERM macro invocations with the proper prologue and epilogue code for your environments. If z/OS Debugger detects a Language Environment-enabled EQAUEDAT when Language Environment is not active, the exit will not be started.

z/OS Debugger provides two samples: EQAUEDAT, which is written in Language Environment-enabled assembler, and EQAUEDAC, which is written in Enterprise COBOL for z/OS and OS/390. Both samples generate a load module named EQAUEDAT.

To enable this user exit, do the following steps:

1. Copy either the EQAUEDAT<sup>30</sup> or EQAUEDAC<sup>31</sup> member from the *hlq.SEQASAMP* library to a private library.
2. Edit the copy, as instructed in the member. Write the logic required to implement your site policy.

The address of the load library data set name and the length of the load library data set name cannot be provided as input to the EQAUEDAT user exit when the loading service (provider) that loaded the module is LPA, LLA, AOS loader, or an unknown provider because this information is not available when using these loading services.

3. Submit the JCL.
4. Add the private library where the generated EQAUEDAT load module is located to the load module search path for the application that you are debugging and for which you want this site policy enabled, in front of *hlq.SEQAMOD*.

---

<sup>30</sup> See "SMP/E USERMODs" in the *IBM z/OS Debugger Customization Guide* for an SMP/E USERMOD for this customization.

<sup>31</sup> See "SMP/E USERMODs" in the *IBM z/OS Debugger Customization Guide* for an SMP/E USERMOD for this customization.



---

# Chapter 15. Using EQACUIDF to specify values for NATLANG, LOCALE, and LINECOUNT

**Note:** This chapter is not applicable to IBM Developer for z/OS (non-Enterprise Edition) or IBM Wazi Developer for Red Hat CodeReady Workspaces.

The EQACUIDF member of *hlq*.SEQABMOD contains the default and allowable values for the parameters NATLANG, LOCALE, and LINECOUNT. These values are used by the following z/OS Debugger components:

- IBM z/OS Debugger Utilities ISPF dialogs: NATLANG
- EQANMDBG (non-CICS non-Language Environment support): NATLANG
- z/OS Debugger Code Coverage: NATLANG, LOCALE, and LINECOUNT

This topic describes the allowable values for these parameters, how to change the default values, and how to enable additional languages for some z/OS Debugger components.

---

## Changing the default and allowable values in EQACUIDF

The default and allowable values for NATLANG, LOCALE, and LINECOUNT are as follows:

- NATLANG. The national language, which can be one of the following:
  - Mixed-case English (ENU)
  - Uppercase English (UEN)
  - Japanese (JPN)
  - Korean (KOR)

See “Enabling additional languages for some z/OS Debugger components through EQACUIDF” on page 130 for more information about changing the language for these z/OS Debugger components.

- LOCALE. The format of date, time, and numeric values. You can also create date, time, and numeric formats. The default values are as follows:
  - Date format: MM/DD/YYYY
  - Time format: HH:MM:SS
  - Numeric format: 1,234,567.89
- LINECOUNT. The number of lines (including headings) that print on a page. The default is 66 lines.

If the default values for these parameters are the values that you want to use, you can skip this section.

To change the default values:

1. Copy the EQACUIDF<sup>32</sup> member in the *hlq*.SEQASAMP data set into another data set.
2. Follow the instructions that are in the comment sections of the code to modify the copy that you made.
3. Assemble the modified copy by using the IBM High Level Assembler and specifying *hlq*.SEQASAMP as a SYSLIB.
4. Link edit the resulting object into the *private*.SEQABMOD data set.
5. Copy the output load module to *hlq*.SEQABMOD.

Sample JCL is provided in the EQACUIID member of the *hlq*.SEQASAMP data set to perform steps “3” on page 129 and “4” on page 129.

---

<sup>32</sup> See “SMP/E USERMODS” in the *IBM z/OS Debugger Customization Guide* for an SMP/E USERMOD for this customization.

The SEQABMOD from this version of z/OS Debugger is compatible with earlier versions of z/OS Debugger. If you have multiple versions of z/OS Debugger installed on your system, you need only the SEQABMOD from this version installed in your system link list concatenation.

## Enabling additional languages for some z/OS Debugger components through EQACUIDF

If you use these components, and have installed either of the additional language features (Japanese or Korean), you must do the following steps to enable the user to specify the additional language feature with the NATLANG parameter.

To change the language to Japanese or Korean:

1. Create a private SEQASAMP data set like *hlq.SEQASAMP*.
2. Create a private SEQABMOD data set like *hlq.SEQABMOD*.
3. Copy members EQACUIDF<sup>33</sup>, EQACUIDM<sup>34</sup>, and EQACUIID from *hlq.SEQASAMP* to your private SEQASAMP. Any edits that are described in this section are to be done in the private SEQASAMP copies of these members.
4. Edit the EQACUIDM member and add each additional installed language feature to the line starting with &ValLang(1), using JPN for Japanese, and KOR for Korean. For example, adding Japanese would be done as follows:

```
&ValLang(1) SetC 'ENU','UEN','JPN' Set valid languages
```

5. Edit the EQACUIDF member and add each additional installed language feature after the following line:

```
UEN Language UEN
```

For example:

```
UEN Language UEN
JPN Language JPN
```

6. If you want to change the default value for NATLANG, edit the EQACUIDF member and change the DfltLang value. For example, making JPN the default for NATLANG would be as follows:

```
EQACUIDF InstDflt DfltLang=JPN, +
```

7. Assemble and link a new copy of EQACUIDF into the private SEQABMOD by editing and submitting the JCL that is supplied in member EQACUIID.
8. Copy the EQACUIDF member from the private SEQABMOD into *hlq.SEQABMOD*.

For more information, see [“Changing the default and allowable values in EQACUIDF”](#) on page 129.

<sup>33</sup> See "SMP/E USERMODs" in the *IBM z/OS Debugger Customization Guide* for an SMP/E USERMOD for this customization.

<sup>34</sup> See "SMP/E USERMODs" in the *IBM z/OS Debugger Customization Guide* for an SMP/E USERMOD for this customization.

## Chapter 16. EQAOPTS commands

EQAOPTS commands are commands that alter some of the basic behavior of z/OS Debugger. These commands must be processed before normal z/OS Debugger command processing is available. You can specify most EQAOPTS commands in the following ways:

- Add dynamically at run time, as described in “Providing EQAOPTS commands at run time” on page 139, a text data set that contains the commands.
- Add to the search sequence, before the copy of EQAOPTS distributed by z/OS Debugger, a customized version of the EQAOPTS load module.

If you want the commands to apply to only a few debugging sessions, it might be easier to supply the EQAOPTS command dynamically at run time. If you want the commands to apply to a group of debugging sessions, it might be better to supply the EQAOPTS commands through the EQAOPTS load module.

Except for commands that can be validly specified more than once (for example, the NAMES commands), if z/OS Debugger finds a command more than once, it uses the first specification of the command. z/OS Debugger processes EQAOPTS commands specified at run time before those specified through the EQAOPTS load module. This means that commands specified at run time override duplicate commands specified in the EQAOPTS load module.

Any or all of the following people can create EQAOPTS specifications:

- The system programmer that installs z/OS Debugger.
- Specific groups in the organization.
- An individual user.

If you are the system programmer or you are creating EQAOPTS specifications for specific groups, you might change the EQAOPTS specifications less frequently, so specifying them by generating a new EQAOPTS load module might be more efficient. If you are an individual user, you might change the EQAOPTS specifications more frequently, so specifying them dynamically at run time might be more efficient.

Table 28 on page 131 summarizes the available EQAOPTS commands and indicates whether a system programmer (S), a specific group (G), or an individual user (U) most commonly uses a command.

| Command          | Description                                                                                                                              | Commonly used by |
|------------------|------------------------------------------------------------------------------------------------------------------------------------------|------------------|
| ALTDISP          | Controls whether to add a character indicator to the MFI screen to indicate a breakpoint, the current line, or the line with found text. | S, U             |
| BROWSE           | Allows users with the authority to use z/OS Debugger in normal mode to restrict their access to Browse Mode.                             | U                |
| CACHENUM         | Controls the size of the z/OS Debugger cache to minimize rereading the debug information.                                                | U, G             |
| CCOUTPUTDSN      | Specifies the default naming pattern that z/OS Debugger uses to name the Code Coverage Observation file.                                 | U, G, S          |
| CCOUTPUTDSNALLOC | Specifies the allocation parameters that z/OS Debugger uses when it creates the Code Coverage Observation file.                          | U, G, S          |
| CCPROGSELECTDSN  | Specifies the default naming pattern that z/OS Debugger uses to name the Code Coverage Options file.                                     | U, G, S          |

Table 28. A brief description of each EQAOPTS command and the type of user most likely to use that command (continued)

| Command            | Description                                                                                                                                                                                                                                                                                                                                                                                                                                                                                             | Commonly used by |
|--------------------|---------------------------------------------------------------------------------------------------------------------------------------------------------------------------------------------------------------------------------------------------------------------------------------------------------------------------------------------------------------------------------------------------------------------------------------------------------------------------------------------------------|------------------|
| CEEREAFTERQDBG     | Restarts z/OS Debugger if a CEETEST call is encountered after you use QUIT DEBUG to end a debug session.                                                                                                                                                                                                                                                                                                                                                                                                | S                |
| CODEPAGE           | Controls the codepage used by z/OS Debugger.                                                                                                                                                                                                                                                                                                                                                                                                                                                            | U, G, S          |
| COMMANDSDSN        | Specifies the default naming pattern that z/OS Debugger uses to name the user's commands file.                                                                                                                                                                                                                                                                                                                                                                                                          | U, G, S          |
| DEFAULTVIEW        | Controls the default view of assembler programs.                                                                                                                                                                                                                                                                                                                                                                                                                                                        | U, G             |
| DISABLERLIM        | Disables Omegamon resource limiting (RLIM) during debug sessions.                                                                                                                                                                                                                                                                                                                                                                                                                                       | S                |
| DLAYDBG            | Allows users to use delay debug mode.                                                                                                                                                                                                                                                                                                                                                                                                                                                                   | U, G, S          |
| DLAYDBGEND         | Specifies monitoring condition events in the delay debug mode.                                                                                                                                                                                                                                                                                                                                                                                                                                          | U, G, S          |
| DLAYDBGDSN         | Specifies delay debug profile data set naming pattern.                                                                                                                                                                                                                                                                                                                                                                                                                                                  | U, G, S          |
| DLAYDBGTRC         | Specifies delay debug pattern match trace message level.                                                                                                                                                                                                                                                                                                                                                                                                                                                | U, G, S          |
| DLAYDBGXRF         | Specifies that z/OS Debugger uses a cross reference to find the user ID when z/OS Debugger constructs the delay debug profile data set name.<br><br>This is used when an IMS transaction or DB/2 stored procedure is initiated from the web or MQ gateway, and thus the transaction is run with a generic ID.<br><br>z/OS Debugger uses either the cross reference file or the Terminal Interface Manager repository to find the ID of the user who wants to debug the transaction or stored procedure. | U, G, S          |
| DOPTACBDSN         | Specifies the data set which will contain DOPT PSBs generated by the IMS Transaction Isolation Facility.                                                                                                                                                                                                                                                                                                                                                                                                | S                |
| DTCNDELETEDEADPROF | Controls the deletion of dead DTCN profiles.                                                                                                                                                                                                                                                                                                                                                                                                                                                            | S                |
| DTCNFORCExxxx      | Controls whether to require certain fields in DTCN.                                                                                                                                                                                                                                                                                                                                                                                                                                                     | S                |
| DYNDEBUG           | Controls the initial (default) value of SET DYNDEBUG.                                                                                                                                                                                                                                                                                                                                                                                                                                                   | U, G, S          |
| EQAQPP             | Enables z/OS Debugger to debug MasterCraft Q++ programs.                                                                                                                                                                                                                                                                                                                                                                                                                                                | U, G, S          |
| EXPLICITDEBUG      | Enables explicit debug mode.                                                                                                                                                                                                                                                                                                                                                                                                                                                                            | U                |
| GPFDSN             | Specifies that z/OS Debugger process a global preferences file.                                                                                                                                                                                                                                                                                                                                                                                                                                         | U, G, S          |
| HOSTPORTS          | Specifies a host port or range of ports to use for a TCP/IP connection to the workstation for the remote debugger.                                                                                                                                                                                                                                                                                                                                                                                      | S                |
| IGNOREODOLIMIT     | Specifies that z/OS Debugger can display COBOL table data items even when an ODO value is out of range.                                                                                                                                                                                                                                                                                                                                                                                                 | U, G, S          |
| LOGDSN             | Specifies the default naming pattern that z/OS Debugger uses to name the user's log file.                                                                                                                                                                                                                                                                                                                                                                                                               | U, G, S          |
| LOGDSNALLOC        | Specifies the allocation parameters that z/OS Debugger uses when it creates the log file.                                                                                                                                                                                                                                                                                                                                                                                                               | U, G, S          |



Table 28. A brief description of each EQAOPTS command and the type of user most likely to use that command (continued)

| Command                         | Description                                                                                                                                                                              | Commonly used by |
|---------------------------------|------------------------------------------------------------------------------------------------------------------------------------------------------------------------------------------|------------------|
| MAXTRANUSER                     | Specifies the maximum number of IMS transactions that a single user may register to debug using the IMS Transaction Isolation Facility.                                                  | S                |
| MDBG                            | Allows users of programs compiled with z/OS XL C/C++ Version 1.10, or later, to indicate whether z/OS Debugger searches for .mdbg files.                                                 | U, G             |
| MULTIPROCESS                    | Controls the behavior of z/OS Debugger when a new POSIX process is created by fork() or exec().                                                                                          | U, G, S          |
| NAMES                           | Controls whether z/OS Debugger processes or ignores certain load module or compile unit names.                                                                                           | U, G             |
| NODISPLAY                       | Controls the z/OS Debugger behavior when the display requested by the z/OS Debugger user is not available.                                                                               | U, G, S          |
| PREFERENCESDSN                  | Specifies the default naming pattern that z/OS Debugger uses to name the preferences file.                                                                                               | U, G, S          |
| SAVEBPDSN, SAVESETDSN           | Specifies the default naming pattern for the data sets used to save and restore the breakpoints and monitors (SAVEBPS) and the settings (SAVESETS).                                      | U, G, S          |
| SAVEBPDSNALLOC, SAVESETDSNALLOC | Specifies the allocation parameters that z/OS Debugger uses when it creates the SAVEBPS and SAVESETS data sets.                                                                          | U, G, S          |
| SESSIONTIMEOUT                  | Establishes a timeout for idle z/OS Debugger sessions that use the Terminal Interface Manager. Timed out sessions are canceled after a specified period of no user activity.             | S                |
| STARTSTOPMSG                    | Controls whether to issue a message when each debugging session is initiated or terminated.                                                                                              | S                |
| STARTSTOPMSGDSN                 | Specifies a message file for start and stop debug session messages.                                                                                                                      | S                |
| SUBSYS                          | Specifies a subsystem used by certain library systems.                                                                                                                                   | G, S             |
| SVCSCREEN                       | Controls whether and how z/OS Debugger uses SVC screening to intercept LOAD and LINK SVC's. This is necessary for debugging non-Language Environment assembler and LangX COBOL programs. | S                |
| TCPIPDATADSN                    | Instructs z/OS Debugger to dynamically allocate the specified file-name to the DDNAME SYSTCPD for the TCP/IP connection to the workstation for the remote debugger.                      | S                |
| THREADTERMCOND                  | Controls whether z/OS Debugger prompts the user when it encounters a FINISH, enclave termination, or thread termination condition.                                                       | U, G             |
| TIMACB                          | Specifies that the z/OS Debugger Terminal Interface Manager (TIM) use a name other than EQASESSM.                                                                                        | S                |
| END                             | Specifies the end of a list of EQAOPTS commands. You must specify END.                                                                                                                   | U, G, S          |

Use the following list to help you record the commands and value you want to implement:

Table 29. Checklist you can print to record which EQAOPTS commands you selected and the values to use for each command.

- 
- EQAXOPT ALTDISP, then select one of the following options:
    - ON
    - OFF
  - EQAXOPT BROWSE, then select one of the following options:
    - RACF
    - ON
    - OFF
  - EQAXOPT CACHENUM, *number*: \_\_\_\_\_
  - EQAXOPT CCOUTPUTDSN, '*file\_name\_pattern*: \_\_\_\_\_ '
 

Append ,LOUD if you want z/OS Debugger to display WTO messages, which helps you debug processing done by this command.
  - EQAXOPT CCOUTPUTDSNALLOC, *allocation\_parameters*: \_\_\_\_\_
 

Append ,LOUD if you want z/OS Debugger to display WTO messages, which helps you debug processing done by this command.
  - EQAXOPT CCPROGSELECTDSN, '*file\_name\_pattern*: \_\_\_\_\_ '
 

Append ,LOUD if you want z/OS Debugger to display WTO messages, which helps you debug processing done by this command.
  - EQAOPTS CEEREAFTERQDBG, then select one of the following options:
    - YES
    - NO
  - EQAXOPT CODEPAGE, *code\_page\_number*: \_\_\_\_\_
  - EQAXOPT COMMANDSDSN, '*file\_name\_pattern*: \_\_\_\_\_ '
 

Append ,LOUD if you want z/OS Debugger to display WTO messages, which helps you debug processing done by this command.
  - EQAXOPT DEFAULTVIEW, then select one of the following options:
    - STANDARD
    - NOMACGEN
  - EQAXOPT DISABLERLIM, then select one of the following options:
    - YES
    - NO
  - EQAXOPT DLAYDBG, then select one of the following options:
    - YES
    - NO
  - EQAXOPT DLAYDBGEND, then select one of the following options:
    - YES
    - NO

Table 29. Checklist you can print to record which EQAOPTS commands you selected and the values to use for each command. (continued)

---

- EQAXOPT DLAYDBGDSN, 'file\_name\_pattern:\_\_\_\_\_ '

- EQAXOPT DLAYDBGTRC, pattern\_match\_trace\_level:\_\_\_\_\_

- EQAXOPT DLAYDBGXRF, then select one of the following options:

  - DSN, 'file\_name:\_\_\_\_\_ '
  - REPOSITORY

- EQAXOPT DOPTACBDSN, 'file\_name:\_\_\_\_\_ '

- EQAXOPT DTCNDELETEDEADPROF, then select one of the following options:

  - YES
  - NO

- EQAXOPT DTCNFORCECUID, then select one of the following options:

  - YES
  - NO

This option performs the same function as DTCNFORCEPROGID. If you select YES for DTCNFORCEPROGID, you do not need to specify this option.

- EQAXOPT DTCNFORCEIP, then select one of the following options:

  - YES
  - NO

- EQAXOPT DTCNFORCELOADMODID, then select one of the following options:

  - YES
  - NO

- EQAXOPT DTCNFORCENETNAME, then select one of the following options:

  - YES
  - NO

- EQAXOPT DTCNFORCEPROGID, then select one of the following options:

  - YES
  - NO

- EQAXOPT DTCNFORCETERMID, then select one of the following options:

  - YES
  - NO

- EQAXOPT DTCNFORCETRANID, then select one of the following options:

  - YES
  - NO

- EQAXOPT DTCNFORCEUSERID, then select one of the following options:

  - YES
  - NO

Table 29. Checklist you can print to record which EQAOPTS commands you selected and the values to use for each command. (continued)

- 
- EQAXOPT DYNDEBUG, then select one of the following options:
    - ON
    - OFF
  - EQAXOPT EQAQPP, then select one of the following options:
    - ON
    - OFF
  - EQAXOPT EXPLICITDEBUG, then select one of the following options:
    - ON
    - OFF
  - EQAXOPT GPFDSN, 'file\_name:\_\_\_\_\_'
  - EQAXOPT HOSTPORTS, range\_of\_ports:\_\_\_\_\_
  - EQAXOPT IGNOREODOLIMIT, then select one of the following options:
    - YES
    - NO
  - EQAXOPT LOGDSN, 'file\_name\_pattern:\_\_\_\_\_'  
 Append ,LOUD if you want z/OS Debugger to display WTO messages, which helps you debug processing done by this command.
  - EQAXOPT LOGDSNALLOC, allocation\_parameters:\_\_\_\_\_
    - Append ,LOUD if you want z/OS Debugger to display WTO messages, which helps you debug processing done by this command.
  - EQAXOPT MAXTRANUSER, number:\_\_\_\_\_
  - EQAXOPT MDBG, then select one of the following options:
    - YES
    - NO
  - EQAXOPT MULTIPROCESS, then select one of the following options:
    - PARENT
    - CHILD
    - PROMPT

Select one of the following options to indicate what you want z/OS Debugger to do with a process that executes itself:

    - EXEC=ANY
    - EXEC=NONE
  - EQAXOPT NAMES, then select one of the following options:
    - EXCLUDE, LOADMOD, pattern:\_\_\_\_\_
    - EXCLUDE, CU, pattern:\_\_\_\_\_
    - INCLUDE, LOADMOD, name:\_\_\_\_\_
    - INCLUDE, CU, name:\_\_\_\_\_

Table 29. Checklist you can print to record which EQAOPTS commands you selected and the values to use for each command. (continued)

- 
- EQAXOPT NODISPLAY, then select one of the following options:
    - DEFAULT
    - QUITDEBUG
  
  - EQAXOPT PREFERENCESDSN, 'file\_name\_pattern:\_\_\_\_\_ '
 

Append ,LOUD if you want z/OS Debugger to display WTO messages, which helps you debug processing done by this command.
  - EQAXOPT SAVEBPDSN, 'file\_name\_pattern:\_\_\_\_\_ '
 

Append ,LOUD if you want z/OS Debugger to display WTO messages, which helps you debug processing done by this command.
  - EQAXOPT SAVESETDSN, 'file\_name\_pattern:\_\_\_\_\_ '
 

Append ,LOUD if you want z/OS Debugger to display WTO messages, which helps you debug processing done by this command.
  
  - EQAXOPT SAVEBPDSNALLOC, allocation\_parameters:\_\_\_\_\_
 

Append ,LOUD if you want z/OS Debugger to display WTO messages, which helps you debug processing done by this command.
  - EQAXOPT SAVESETDSNALLOC, allocation\_parameters:\_\_\_\_\_
 

Append ,LOUD if you want z/OS Debugger to display WTO messages, which helps you debug processing done by this command.
  
  - EQAXOPT SESSIONTIMEOUT, then select one of the following options:
    - NEVER
    - QUITDEBUG,hhmmssnn
    - QUIT,hhmmssnn
  
  - EQAXOPT STARTSTOPMSG, then select one of the following options:
    - NONE
    - ALL
    - CICS
    - TSO
    - BATCHTSO
    - IMS
    - OTHER

or any of CICS, TSO, BATCHTSO, IMS, and OTHER, or all of them enclosed in parenthesis and separated by commas.

Append ,WTO if you want z/OS Debugger to display the messages via WTO.
  
  - EQAXOPT STARTSTOPMSGDSN, 'file\_name:\_\_\_\_\_ '
 

Append ,LOUD if you want z/OS Debugger to display WTO messages, which helps you debug processing done by this command.
  
  - EQAXOPT SUBSYS, subsystem\_name:\_\_\_\_\_
 

Append ,LOUD if you want z/OS Debugger to display WTO messages, which helps you debug processing done by this command.

Table 29. Checklist you can print to record which EQAOPTS commands you selected and the values to use for each command. (continued)

- EQAXOPT SVCSCREEN, then select one of the following options:

ON  
OFF  
(OFF, QUIET)

Select one of the following options to indicate what you want z/OS Debugger to do if there is an existing SVC screening environment:

CONFLICT=OVERRIDE  
CONFLICT=NOOVERRIDE

Select one of the following options to indicate whether you want z/OS Debugger to temporarily replace the existing SVC screening environment:

NOMERGE  
MERGE=(COPE)

- TCPIP DATADSN, 'file\_name: \_\_\_\_\_'

- EQAXOPT THREADTERMCOND, then select one of the following options:

PROMPT  
NOPROMPT

EQAXOPT TIMACB, ACB\_name: \_\_\_\_\_

EQAXOPT END Always specify this command.

After you have made all of your selections, define the options as described in [“Creating EQAOPTS load module”](#) on page 140.

## Format of the EQAOPTS command

When you specify EQAOPTS commands through the EQAOPTS load module, you create them as assembler macro invocations and you must subsequently assemble and link-edit them into the EQAOPTS load module. To provide a consistent format for all forms of EQAOPTS commands, when you specify the EQAOPTS commands at run time, you must use the assembler macro invocation format. The following format rules apply to all EQAOPTS commands:

- EQAOPTS commands must be contained in fixed-length, eighty-byte records.
- The commands must be contained between columns one and seventy-one, with column seventy-two reserved for a continuation indicator. z/OS Debugger ignores columns seventy-three through eighty.
- Specify an asterisk (\*) in column one to indicate a comment. z/OS Debugger ignores comments. Column one must be blank for all non-comment statements.
- The op-code for each EQAOPTS statement must be EQAXOPT and must begin in or after column two and followed by at least one blank.
- A list of one or more operands must follow the EQAXOPT op-code. Separate these operands by a comma and do not embed blanks.
- If a command exceeds the length of one line, you can continue the command in one of the following ways:
  - You can end at the comma following an operand and place a non-blank character in column seventy-two.
  - You can use all of the columns through column seventy-one and place a non-blank character in column seventy-two.

In either case, the statement that follows must be blank in columns one through fifteen and begin in column sixteen.

## EQAOPTS commands that have equivalent z/OS Debugger commands

Some EQAOPTS commands have equivalent z/OS Debugger commands. [Table 30 on page 139](#) shows a few examples.

| EQAOPTS command | z/OS Debugger command |
|-----------------|-----------------------|
| DEFAULTVIEW     | SET DEFAULTVIEW       |
| DYNDEBUG        | SET DYNDEBUG          |
| EXPLICITDEBUG   | SET EXPLICITDEBUG     |
| NAMES           | NAMES                 |

For these commands, specifying them as EQAOPTS commands or z/OS Debugger commands produces the same action. The timing (when these commands take effect) differs between EQAOPTS commands and z/OS Debugger commands.

z/OS Debugger processes z/OS Debugger commands after it processes the initial load module and creates the compile units contained in the initial load modules. z/OS Debugger processes EQAOPTS commands during z/OS Debugger initialization, prior to processing the initial load module. This means that when z/OS Debugger processes the initial load module, z/OS Debugger commands like NAMES are not in effect but the corresponding EQAOPTS commands are in effect and are applied to the initial load module.

EQAOPTS commands like DEFAULTVIEW provide a way of specifying a site- or group-wide default for the corresponding z/OS Debugger command. However, a better way to specify a site- or group-wide default for these types of commands is by putting the z/OS Debugger command in a global preferences file.

## Providing EQAOPTS commands at run time

You can provide EQAOPTS commands to z/OS Debugger at run time. You must save the commands in a data set with 80-byte, fixed-length records. The following list describes the methods of specifying this data set to z/OS Debugger:

- In CICS, include the EQAOPTS commands through DTCN.
- In UNIX System Services, specify the name of the data set containing the EQAOPTS commands through the EQA\_OPTS\_DSN environment variable.
- In IMS and Db2, specify the name of the data set containing the EQAOPTS commands in the Language Environment user exit or debug profile by using DTU option 6 or B, Terminal Interface Manager, or the **z/OS Debugger Profiles** view.
- In other environments, specify the name of the data set containing the commands through the EQAOPTS DD statement.

The following example shows what the data set might contain:

```
EQAXOPT MDBG,YES
EQAXOPT NODISPLAY,QUITDEBUG
EQAXOPT NAMES,EXCLUDE,LOADMOD,USERMOD1
EQAXOPT NAMES,EXCLUDE,LOADMOD,USERMOD7
EQAXOPT END
```

The instructions in [“Creating EQAOPTS load module” on page 140](#) contain examples with specifications for CSECT, AMODE, RMODE, and END (without EQAXOPTS) statements. Do not include these specifications if you provide EQAOPTS command at run time.

## Creating EQAOPTS load module

If you have chosen to use the EQAOPTS load module to specify your EQAOPTS commands, do the following steps:

1. Copy the EQAOPTS<sup>35</sup> member from the *hlq*.SEQASAMP library to a private library.
2. Edit this copy of EQAOPTS and code the EQAOPTS command or commands you want. To this minimum source, add each EQAXOPT option you want to include. The following example describes the minimum assembler source required to generate the EQAOPTS load module:

```
EQAOPTS CSECT ,
EQAOPTS AMODE 31
EQAOPTS RMODE ANY
 Add your customized EQAXOPT statements here. For example:
EQAXOPT MDBG,YES
EQAXOPT NODISPLAY,QUITDEBUG
EQAXOPT NAMES,EXCLUDE,LOADMOD,USERMOD1
EQAXOPT NAMES,EXCLUDE,LOADMOD,USERMOD7
EQAXOPT END
END ,
```

3. Follow the directions in the EQAOPTS sample to generate a new EQAOPTS load module. These directions describe how to assemble the source and link-edit the generated object into a load module named EQAOPTS.
4. Place the EQAOPTS load module in a private data set that is in the load module search path and appears before *hlq*.SEQAMOD.

## Descriptions of EQAOPTS commands

To learn how EQAOPTS commands work and how to specify them, see [Chapter 16, “EQAOPTS commands,”](#) on page 131.

### ALTDISP

You can use the EQAOPTS ALTDISP command to add a character indicator to the MFI screen to indicate a breakpoint, the current line, or the line with found text. By default, z/OS Debugger uses coloring to indicate these situations.

Use this command only if your 3270 color configuration and attributes make it difficult to detect the coloring in the line. It is valid only when you are using interactive MFI mode.

The following diagram describes the syntax of the ALTDISP command:

►► EQAXOPT — ALTDISP — , — ON —►►  
                                          └── OFF ─┘

The following list describes the parameters of the EQAOPTS ALTDISP command:

#### ON

Indicates to add a character indicator to indicate a breakpoint, the current line, or the line with found text.

#### OFF

Indicates not to add a character indicator to indicate a breakpoint, the current line, or the line with found text. This is the default value.

#### Example

```
EQAXOPT ALTDISP,ON
```

<sup>35</sup> See "SMP/E USERMODs" in the *IBM z/OS Debugger Customization Guide* for an SMP/E USERMOD for this customization.



## BROWSE

z/OS Debugger browse mode can be controlled by either the browse mode RACF facility, through the EQAOPTS BROWSE command, or both. For a description of how to control browse mode through RACF, see "Debugging in browse mode" in the *IBM z/OS Debugger User's Guide*.

Users who have sufficient RACF authority can specify the EQAOPTS BROWSE command to indicate that the current invocation of z/OS Debugger be in browse mode.

The following diagram describes the syntax of the BROWSE command:

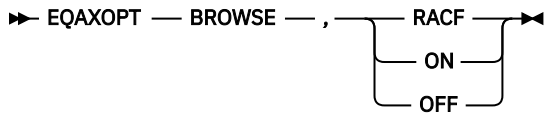

The following list describes the parameters of the EQAOPTS BROWSE command:

### RACF

Indicates that you want z/OS Debugger to use the browse mode access as determined by the current user's RACF access to the applicable RACF profile. If you do not specify the BROWSE command, z/OS Debugger defaults to RACF.

### ON

Indicates that unless the user's RACF access is NONE, set BROWSE MODE to ON.

### OFF

Indicates that if no RACF profile exists or if the user has UPDATE access or higher, set BROWSE MODE to OFF.

### Examples

```
EQAXOPT BROWSE,ON
EQAXOPT BROWSE,RACF
```

## CACHENUM

To reduce CPU consumption, z/OS Debugger stores information about the application programs being debugged in a cache. By default, for each debug session, z/OS Debugger stores the information for a maximum of 10 programs. Application programs that do a LINK, LOAD, or XCTL to more than 10 programs can degrade the debugger's CPU performance. You can enhance the debugger's CPU performance for these application programs by specifying an increased CACHENUM value in EQAOPTS. An increased value causes z/OS Debugger to use more storage for each debugging session.

The following diagram describes the syntax of the CACHENUM command:



### cache\_value

Specifies the size of the z/OS Debugger cache. It must be no smaller than 10 and no larger than 999.

### Example

```
EQAXOPT CACHENUM,40
```

## CCOUTPUTDSN

This option provides the data set name to be used for the Code Coverage Observation file. Specify NULLFILE if no Observation file is to be written to.

This data set must be preallocated as a sequential data set if CCOUTPUTDSNALLOC is not specified. RECFM=VB, LRECL=255 is suggested.

The following diagram describes the syntax of the CCOUTPUTDSN command:

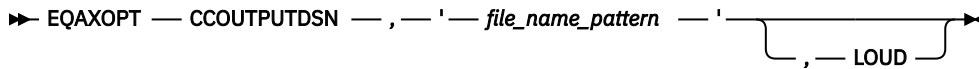

### ***file\_name\_pattern***

Specifies a naming pattern that determines the name of the data set that contains this file. Follow these guidelines when you create the naming pattern:

- Create a data set name that includes &&USERID. as one of the qualifiers. z/OS Debugger substitutes the user ID of the current user for this qualifier when it determines the name of the data set.
- Specify NULLFILE to indicate that you do not want z/OS Debugger to process this file.

### **LOUD**

Specifies that z/OS Debugger displays WTO messages, which helps you debug processing done by this command. z/OS Debugger normally does not display any messages if it does not find the data set. If you are trying to determine why z/OS Debugger is not processing this file, specify LOUD to see if it displays a message that it can not find the data set.

## **CCOUTPUTDSNALLOC**

This option is used to create the CCOUTPUTDSN data set for a new user and provides the allocation parameters (in BPXWDYN format).

The following diagram describes the syntax of the CCOUTPUTDSNALLOC command:

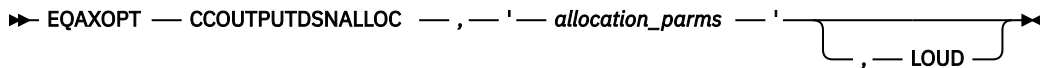

### ***allocation\_parms***

Specifies the allocation parameters you want z/OS Debugger to use when it creates the data set. You can specify only the keys in the following list:

- BLKSIZE
- BLOCK
- CYL
- DATACLAS
- DSNTYPE
- DSORG
- LRECL
- MGMTCLAS
- RECFM
- SPACE
- STORCLAS
- TRACKS
- UNIT
- VOL

Separate the keys by one or more blanks. z/OS Debugger does not provide defaults for any of the keys.

For information about the format of the keys, see the chapter "BPXWDYN: a text interface to dynamic allocation and dynamic output" in the *z/OS Using REXX and z/OS UNIX System Services* manual. Specify that the data set be sequential. To learn about other formatting rules for the log file, see "Data sets used by z/OS Debugger" of the *IBM z/OS Debugger User's Guide*.

## LOUD

Specifies that z/OS Debugger displays WTO messages, which helps you debug processing done by this command. z/OS Debugger normally does not display any messages when it creates this data set. If you are trying to determine why this file was not created, specify LOUD to view any messages.

## CCPROGSELECTDSN

This option provides the data set name that contains the Code Coverage Options file (which specifies the Group IDs and the PROGRAM IDs of the COBOL routines that are to be processed). Specify NULLFILE if no Code Coverage Options file is to be read.

This dataset must be preallocated as a sequential dataset. RECFM=VB, LRECL=255 is suggested.

The following diagram describes the syntax of the CCPROGSELECTDSN command:

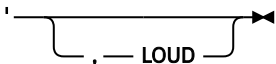
►► EQAXOPT — CCPROGSELECTDSN — , — ' — *file\_name\_pattern* — ' — 

### *file\_name\_pattern*

Specifies a naming pattern that determines the name of the data set that contains this file. Follow these guidelines when you create the naming pattern:

- Create a data set name that includes &&USERID. as one of the qualifiers. z/OS Debugger substitutes the user ID of the current user for this qualifier when it determines the name of the data set.
- Specify NULLFILE to indicate you do not want z/OS Debugger to process this file.

## LOUD

Specifies that z/OS Debugger displays WTO messages, which helps you debug processing done by this command. z/OS Debugger normally does not display any messages if it does not find the data set or data set member. If you are trying to determine why z/OS Debugger is not processing this file, specify LOUD to see if it displays a message that it can not find the data set.

## CEEREACTAFTERQDBG

You can specify this command to restart z/OS Debugger with CEETEST after you use QUIT DEBUG to end a debug session. You can specify this command only in an EQAOPTS load module.

**Note:** You cannot use this command in standard mode for remote debugging.

The following diagram describes the syntax of the CEEREACTAFTERQDBG command:

►► EQAXOPT — CEEREACTAFTERQDBG — , — 

The following list describes the parameters of the EQAOPTS CEEREACTAFTERQDBG command:

### NO

Indicates that you do not want to restart z/OS Debugger if a CEETEST call is encountered after you use QUIT DEBUG to end a debug session. This parameter is the default setting.

### YES

Indicates that you want to restart z/OS Debugger if a CEETEST call is encountered after you use QUIT DEBUG to end a debug session.

### Example

```
EQAXOPT CEEREACTAFTERQDBG,NO
```

```
EQAXOPT CEEREACTAFTERQDBG,YES
```

## CODEPAGE

The default code page used by z/OS Debugger and the remote debuggers is 037. For any of the following situations, you need to use a different code page:

- Application programmers are debugging in remote debug mode and the source or compiler use a code page other than 037.

If your C/C++ source contains square brackets or other special characters, you might need to specify an EQAOPTS CODEPAGE command to override the z/OS Debugger default code page (037). Check the code page specified when you compiled your source. The C/C++ compiler uses a default code page of 1047 if you do not explicitly specify one. If the code page used is 1047 or a code page other than 037, you need to specify an EQAOPTS CODEPAGE command specifying that code page.

- Application programmers are debugging in full screen mode and encounter one of the following situations:

- They use the STORAGE command to update COBOL NATIONAL variables.
- The source is coded in a code page other than 037.

- Application programmers use the XML(CODEPAGE(ccsid)) parameter on a LIST CONTAINER or LIST STORAGE command to specify an alternate code page.

z/OS Debugger uses the z/OS Unicode Services to process characters that need code page conversion.

The following diagram describes the syntax of the CODEPAGE command:

►► EQAXOPT — CODEPAGE — , — *nnnn* ◄◄

### *nnnn*

A positive integer indicating the code page to use.

After implementing the EQAOPTS CODEPAGE command, if application programmers using full-screen mode still cannot display some characters correctly, have them verify that their emulator's code page matches the code page of the characters they need to display.

You might need to create your own conversion images as described in [“Creating a conversion image for z/OS Debugger”](#) on page 144.

### Example

```
EQAXOPT CODEPAGE,121
```

## Creating a conversion image for z/OS Debugger

You might need to create a conversion image so that z/OS Debugger can properly transmit characters in a code page other than 037 between the remote debugger and the host. A conversion image contains the following information:

- The conversion table that specifies the source CCSID (Coded Character Set Identifiers) and target CCSID. For z/OS Debugger, specify a pair of conversion images between the host code page and Unicode code page (UTF-8). You can specify the host code page in the VADSCP*nnnnn* suboption of TEST runtime option or with the CODEPAGE command in the EQAOPTS data set. If you specify both the VADSCP*nnnnn* suboption and the CODEPAGE command, z/OS Debugger uses only the CODEPAGE command. The following table shows the images required for CCSIDs 930, 939 (Japanese EBCDIC), 933 (Korean EBCDIC), 1141 (Germany EBCDIC), and 1047 (Latin 1/Open Systems, EBCDIC). See *IBM z/OS Debugger Reference and Messages* for a detailed description of the suboption VADSCP*nnnnn*.

Table 31. Source and target CCSID to specify, depending on the code page command used

| VADSCPnnnn suboption or CODEPAGE command                            | Source CCSID      | Target CCSID      |
|---------------------------------------------------------------------|-------------------|-------------------|
| VADSCP930 or CODEPAGE,930                                           | 1390 <sup>1</sup> | 1208 (UTF-8)      |
|                                                                     | 1208              | 1390 <sup>1</sup> |
| VADSCP939 or CODEPAGE,939                                           | 1399 <sup>1</sup> | 1208 (UTF-8)      |
|                                                                     | 1208              | 1399 <sup>1</sup> |
| VADSCP933 or CODEPAGE,933                                           | 933               | 1208 (UTF-8)      |
|                                                                     | 1208              | 933               |
| VADSCP1141 or CODEPAGE,1141                                         | 1141              | 1208 (UTF-8)      |
|                                                                     | 1208              | 1141              |
| VADSCP1047 or CODEPAGE,1047                                         | 1047              | 1208 (UTF-8)      |
|                                                                     | 1208              | 1047              |
| <b>Note:</b>                                                        |                   |                   |
| 1. For compatibility with earlier versions, 1390 and 1399 are used. |                   |                   |

For each suboption, a pair of conversion images are needed for bidirectional conversion.

- The conversion technique, also called the technique search order. z/OS Debugger uses the technique search order RECLM, which means roundtrip, enforced subset, customized, Language Environment-behavior, and modified language. RECLM is the default technique search order, so you do not have to specify the technique search order in the JCL.

You might need to create a conversion image so that users debugging COBOL programs in full screen or batch mode can modify NATIONAL or UTF-8 variables with the STORAGE command or to properly display C/C++ variables that contain characters in a code page other than 037. To create the conversion image, you need to do the following steps:

1. Ask your system programmer for the host's CCSID.
2. Submit a JCL job that specifies the conversion image between the host CCSID, which you obtained in step “1” on page 145, and CCSID 1200 (UTF-16).

“Example: JCL for generating conversion images” on page 145 describes how one JCL creates the conversion images for both situations.

## Example: JCL for generating conversion images

The following JCL generates the conversions images required for z/OS Debugger.

This JCL is a variation of the JCL located at *h7q*. SCUNJCL (CUNJIUTL), which is provided by the Unicode conversion services package.

```
//CUNMIUTL EXEC PGM=CUNMIUTL
//SYSPRINT DD SYSOUT=*
//SYSUDUMP DD SYSOUT=*
//SYSIMG DD DSN=UNI.IMAGES(CUNIMG01),DISP=SHR
//TABIN DD DSN=UNI.SCUNTBL,DISP=SHR
//SYSIN DD *
/*****/
/* Conversion image input for z/OS Debugger in Remote */
/* debug mode */
/*****/
CONVERSION 1390,1208; /* IBM-930 to UTF-8,RECLM */
CONVERSION 1208,1390; /* UTF-8 to IBM-930,RECLM */
CONVERSION 1399,1208; /* IBM-939 to UTF-8,RECLM */
CONVERSION 1208,1399; /* UTF-8 to IBM-939,RECLM */
```

```

CONVERSION 933,1208; /* IBM-933 to UTF-8,RECLM */
CONVERSION 1208,933; /* UTF-8 to IBM-933,RECLM */
CONVERSION 1141,1208; /* IBM-1141 to UTF-8,RECLM */
CONVERSION 1208,1141; /* UTF-8 to IBM-1141,RECLM */
CONVERSION 1047,1208; /* IBM-1047 to UTF-8,RECLM */
CONVERSION 1208,1141; /* UTF-8 to IBM-1141,RECLM */
/*****
/* Conversion image input for z/OS Debugger to modify COBOL NATIONAL*/
/* variables with the STORAGE command while in full screen mode */
/*****
CONVERSION 0037,1200; /*IBM-37 to UTF-16,RECLM */
/*

```

z/OS Debugger uses the character conversion services but not the case conversion or the normalization services of Unicode conversion services. You do not need to include CASE or NORMALIZE control statements unless other applications require them.

## COMMANDSDSN

Indicates that you want z/OS Debugger to read a user's commands file (with the name of the data set containing the commands file determined by the specified naming pattern) each time it starts. This works in the following situation:

- You do not specify a data set name or DD name for the user's commands file using any other method; for example, the TEST runtime option.
- You or your site specifies the EQAOPTS COMMANDSDSN command.
- The data set specified by the EQAOPTS COMMANDSDSN command exists and contains a member whose name matches the initial load module name in the first enclave.

The following diagram describes the syntax of the COMMANDSDSN command:

```

➡ EQAXOPT — COMMANDSDSN — , — ' — file_name_pattern — ' — LOAD

```

### *file\_name\_pattern*

Specifies a naming pattern that determines the name of the data set that contains the user's commands file. Follow these guidelines when you create the naming pattern:

- Create a data set name that includes &&USERID. as one of the qualifiers. z/OS Debugger substitutes the user ID of the current user for this qualifier when it determines the name of the data set.
- Specify NULLFILE to indicate you do not want z/OS Debugger to process a commands file.

### LOUD

Specifies that z/OS Debugger display WTO messages, which helps you debug processing done by this command. z/OS Debugger normally does not display any messages if it does not find the data set or data set member. If you are trying to determine why z/OS Debugger is not processing a user's commands file, specify LOUD to see if it displays a message that it cannot find the data set or the member.

If you choose to implement this option, users who want to use this function must create the commands file as a PDS or PDSE with the allocation parameters that are described in "Data sets used by z/OS Debugger" in the *IBM z/OS Debugger User's Guide*. Then, users create a member for each program that they want to debug, with the name of the member matching the initial load module name in the first enclave.

### Example

```
EQAXOPT COMMANDSDSN, '&&USERID.DBGTOOL.COMMANDS'
```

If you log in with user ID jsmith, z/OS Debugger determines the name of the data set to be JSMITH.DBGTOOL.COMMANDS.

## DEFAULTVIEW

A user can control whether to display the statements of an assembler macro in the Source window by entering the SET DEFAULT VIEW command. Every time a LOADDEBUGDATA command is run for an assembler compile unit, z/OS Debugger uses the setting of this command to determine whether to display the macro-generated statements. You can control the initial default for this setting by using the EQAOPTS DEFAULTVIEW command.

The following diagram describes the syntax of the DEFAULTVIEW command:

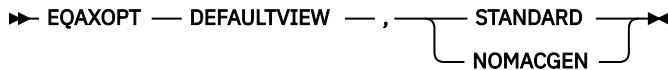

Each of these fields corresponds to the similar field in the SET DEFAULT VIEW command. If you do not code the EQAOPTS DEFAULTVIEW command, the initial setting for DEFAULTVIEW is STANDARD.

### Example

```
EQAXOPT DEFAULTVIEW,NOMACGEN
```

## DISABLERLIM

You can specify this command only in the EQAOPTS load module. It cannot be specified at run time.

You can specify this command to control whether or not z/OS Debugger disables Omegamon Resource Limiting (RLIM) during debug sessions in a CICS region.

The following diagram describes the syntax of the DLAYDBG command:



The following list describes the parameters of the DISABLERLIM command:

### YES

Indicates that you want z/OS Debugger to disable RLIM processing during debug sessions; this is the default value.

### NO

Indicates that you do not want z/OS Debugger to disable RLIM processing.

### Example

```
EQAXOPT DISABLERLIM,YES
EQAXOPT DISABLERLIM,NO
```

## DLAYDBG

You can specify this command only in the EQAOPTS load module. The only exception to this rule is a transaction executing in a private message region under the IMS Transaction Isolation Facility, which accepts this command in EQAOPTS DD as well.

You can specify this command to enable z/OS Debugger to delay the starting of a debug session until z/OS Debugger recognizes a certain program name or C function name (compile unit) (along with an optional load module name).

This command can be used only in the non-CICS environments.

The following diagram describes the syntax of the DLAYDBG command:

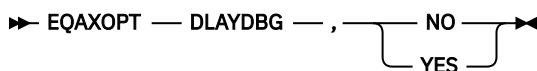

The following list describes the parameters of the DLAYDBG command:

**NO**

Indicates that you do not want delay debug enabled; this is the default value.

**YES**

Indicates that you want delay debug enabled.

If you choose to implement this option, users who want to use this option must create the delay debug profile as a physical sequential data set by using the option B of the IBM z/OS Debugger Utilities: Delay Debug Profile.

**Example**

```
EQAXOPT DLAYDBG,NO
EQAXOPT DLAYDBG,YES
```

## DLAYDBGEND

You can specify this command only in the EQAOPTS load module. It cannot be specified at run time.

You can use this command to indicate whether you want z/OS Debugger to monitor condition events in the delay debug mode.

This command can be used only in the non-CICS environments.

The following diagram describes the syntax of the DLAYDBGEND command:



The following list describes the parameters of the DLAYDBGEND command:

**ALL**

Indicates that you want z/OS Debugger to monitor all condition events. This is the default option.

**NONE**

Indicates that you do not want z/OS Debugger to monitor condition events.

**Example**

```
EQAXOPT DLAYDBGEND,NONE
```

## DLAYDBGDSN

You can specify this command only in the EQAOPTS load module. The only exception to this rule is a transaction executing in a private message region under the IMS Transaction Isolation Facility, which accepts this command in EQAOPTS DD as well.

You can specify this command to indicate that you want z/OS Debugger to use the specified naming pattern when it constructs the delay debug profile data set name.

This command can be used only in the non-CICS environments.

The following diagram describes the syntax of the DLAYDBGDSN command:

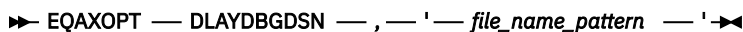

***file\_name\_pattern***

Specifies a naming pattern that determines the name of the data set that contains the delay debug profile. Follow this guideline when you create the naming pattern:

- Create a data set name that includes &&USERID. as one of the qualifiers. z/OS Debugger substitutes the user ID of the current user for this qualifier when it determines the name of the data set.



The default naming pattern is &&USERID . DLAYDBG . EQAUOPTS.

### Example

```
EQAXOPT DLAYDBGDSN, '&&USERID . DLAYDBG . EQAUOPTS' ;
```

## DLAYDBGTRC

You can specify this command only in the EQAOPTS load module. The only exception to this rule is a transaction executing in a private message region under the IMS Transaction Isolation Facility, which accepts this command in EQAOPTS DD as well.

You can specify this command to indicate that you want z/OS Debugger to generate trace during the pattern match process in the delay debug mode. z/OS Debugger uses the WTO (write to operator) command to output the trace.

This command can be used only in the non-CICS environments.

The following diagram describes the syntax of the DLAYDBGTRC command:

►► EQAXOPT — DLAYDBGTRC — , — *trace\_level* ►►

### *trace\_level*

Specifies a trace level that determines the level of traces that z/OS Debugger generates. Valid levels are:

- 0 - no trace message; this is the default value.
- 1 - error and warning messages
- 2 - error, warning, and diagnostic messages
- 3 - error, warning, diagnostic, and internal diagnostic messages

### Example

```
EQAXOPT DLAYDBGTRC,2
```

## DLAYDBGXRF

You can specify this command only in the EQAOPTS load module. The only exception to this rule is a transaction executing in a private message region under the IMS Transaction Isolation Facility, which accepts this command in EQAOPTS DD as well.

In this section, the term generic ID refers to a user ID that executes a task but is not the ID that debugs the task. Common examples include the user ID associated with a WebSphere® MQ for z/OS trigger monitor, or the user ID that runs a web services-initiated program.

You can use the DLAYDBGXRF command to map a generic ID to a user ID that is obtained from one of the following sources:

- The Delay Debug cross reference file
- Users logged on to Terminal Interface Manager

The user ID that is obtained by this method is used in place of the current user ID when the delay debug profile data set name is constructed.

The generic ID-to-user ID mapping can occur in the following environments:

- In the IMS environment when an IMS transaction is started with a generic ID.
- In the DB/2 stored procedures environment. This environment is supported by the REPOSITORY and CLIENTID options.

The following diagram describes the syntax of the DLAYDBGXRF command:

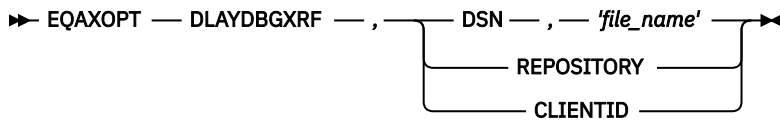

### DSN

Specifies that the generic ID cross reference file *'file\_name'* should be used to map the generic ID to the user ID of the z/OS Debugger user.

### REPOSITORY

Specifies that z/OS Debugger communicates with Terminal Interface Manager (TIM) to determine whether a user has logged on to TIM and requested to debug the current IMS transaction or DB/2 stored procedure.

The REPOSITORY option requires that the debugging user ID be granted RACF authority to debug tasks initiated by the generic ID. This is done via the EQADTOOL.GENERICID.*generic\_user\_ID* facility. To set this up, use the following RACF commands:

```
RDEFINE EQADTOOL.GENERICID.generic_user_ID CLASS(FACILITY) UACC(NONE)
PERMIT EQADTOOL.GENERICID.generic_user_ID ID(user) ACC(READ)
```

The *generic\_user\_ID* can be a pattern.

The REPOSITORY option also requires that you start the Terminal Interface Manager started task with the REPOSITORY option. See [“Starting the Terminal Interface Manager”](#) for more information.

### CLIENTID

Specifies that z/OS Debugger uses the DB/2 client user ID for a stored procedure call to determine whether a remote debug user has requested to debug DB/2 stored procedures that execute with that client user ID. If such a user exists, their user ID will be used to locate the delay debug profile data set.

### *'file\_name'*

Specifies an MVS sequential data set with FB LRECL 80 characteristics.

### Example

```
EQAXOPT DLAYDBGXRF,DSN,'EQAW.TRNUSRID.XREF'
EQAXOPT DLAYDBGXRF,REPOSITORY
```

Refer to the following topics for more information related to the material discussed in this topic.

#### Related references

*Debugging tasks running under a generic user ID* in the *IBM z/OS Debugger User's Guide*

## DOPTACBDSN

You can specify this command only in the EQAOPTS load module. It cannot be specified at run time.

The DOPTACBDSN command identifies the data set that will contain DOPT PSBs that are created by z/OS Debugger for the IMS Transaction Isolation Facility. This data set will be used to store ACBs generated for the EQATccn DOPT PSBs.

There is no default value for this command. If your site will use the IMS Transaction Isolation Facility, this command must be specified.

The following diagram describes the syntax of the DOPTACBDSN command:



### *'data\_set\_name'*

Fully-qualified name of the data set that will contain the EQATccn DOPT PSBs.

## DTCNDELETEDEADPROF

You can specify this command only in the EQAOPTS load module. It cannot be specified at run time.

This command controls the deletion of DTCN profiles. A dead profile is a profile whose owner has logged off or disconnected from the CICS region.

DTCN scans its repository for dead profiles from time to time, and on demand when EQADCDEL is called. When a dead profile is found, it deactivates the profile by default. You can specify DTCNDELETEDEADPROF to delete the profile instead. The dead profile is deactivated or deleted by the INACTIVATE or DELETE DTCN function.

The following diagram describes the syntax of the DTCNDELETEDEADPROF command:



### NO

Indicates that you want DTCN not to delete the profile. NO is the default option.

### YES

Indicates that you want DTCN to delete the profile.

### Example

```
EQAXOPT DTCNDELETEDEADPROF ,YES
```

## DTCNFORCExxxx

You can specify these commands only in the EQAOPTS load module. You cannot specify them at run time.

If your users create debugging profiles with DTCN, you can use the DTCNFORCExxxx commands to require that certain DTCN fields are not left blank. The following list describes each resource type you can require each user to specify:

- DTCNFORCECUID or DTCNFORCEPROGID, which requires the user to specify the name of a compile unit or compile units.
- DTCNFORCEIP, which requires the user to specify the IP name or address.
- DTCNFORCELOADMODID, which requires the user to specify the name of a load module or load modules.
- DTCNFORCENETNAME, which requires the user to specify the four character name of a CICS terminal or a CICS system.
- DTCNFORCETERMID, which requires the user to specify the CICS terminal.
- DTCNFORCETRANID, which requires the user to specify a transaction ID.
- DTCNFORCEUSERID, which requires the user to specify a user ID.

If any of the statements are not included, the statement defaults to NO.

The following diagram describes the syntax of the DTCNFORCExxxx command:

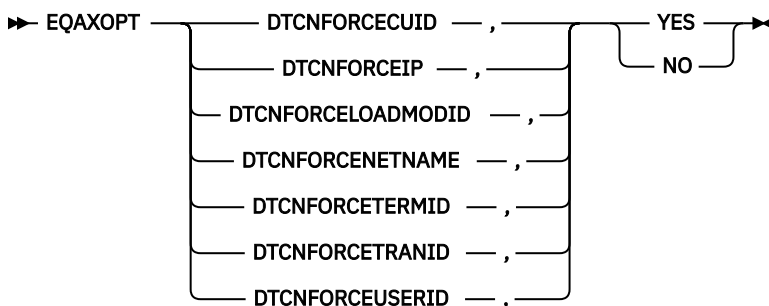

**YES**

Indicates that the specified field is required.

**NO**

Indicates that the specified field is not required.

**Examples**

```
EQAXOPT DTCNFORCEUSERID,YES
EQAXOPT DTCNFORCETRANID,NO
```

## DYNDEBUG

*z/OS Debugger Reference and Messages* describes how you use the SET DYNDEBUG command to enable or disable dynamic debug mode in z/OS Debugger.

The initial default setting is DYNDEBUG ON. If you want to change the initial default setting, use the EQAOPTS DYNDEBUG command.

The following diagram describes the syntax of the DYNDEBUG command:

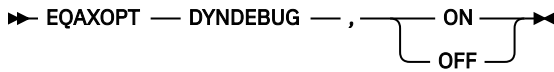
**ON**

Sets the initial default to DYNDEBUG ON.

**OFF**

Sets the initial default to DYNDEBUG OFF.

**Example**

```
EQAXOPT DYNDEBUG,OFF
```

## EQAQPP

You must specify this command to enable z/OS Debugger to debug MasterCraft Q++ programs, provided by Tata Consultancy Services Ltd. For more information about how to enable z/OS Debugger to support MasterCraft Q++, contact Tata Consultancy Services Ltd.

The following diagram describes the syntax of the EQAQPP command:

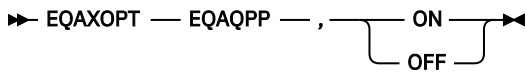
**ON**

Indicates z/OS Debugger supports Q++ debugging.

**OFF**

Indicates z/OS Debugger does not support Q++ debugging. If you do not specify the EQAQPP command, OFF is the default.

**Example**

```
EQAXOPT EQAQPP,ON
```

## EXPLICITDEBUG

The *IBM z/OS Debugger Reference and Messages* describes how you use the SET EXPLICITDEBUG command to enable explicit debug mode in z/OS Debugger. However, before you can enter the SET EXPLICITDEBUG command, z/OS Debugger has already processed the initial load module and loaded the

debug data for the compile units it contains. If you want to enable explicit debug mode prior to processing the initial load module, use the EQAOPTS EXPLICITDEBUG command.

The following diagram describes the syntax of the EXPLICITDEBUG command:



#### ON

Enables explicit debug mode.

#### OFF

Disables explicit debug mode. This is the default.

#### Example

```
EQAXOPT EXPLICITDEBUG,ON
```

## GPFDSN

You can create a *global preferences file* that runs a set of z/OS Debugger commands at the start of all z/OS Debugger sessions. For example, a global preferences file can have a command that sets PF keys to specific values. If your site uses the PF6 key as the program exit key, you can specify the SET PF6 "EXIT" = QUIT; command, which assigns the z/OS Debugger QUIT command to the PF6 key, in the global preferences file. (See "Customizing your full-screen session" in the *IBM z/OS Debugger User's Guide* for a description of the interface features you can change.)

Whenever a user starts z/OS Debugger, z/OS Debugger processes the commands in the global preferences file first. The user can also create his or her own preferences file and a commands file. In this situation, z/OS Debugger processes the files in the following order:

1. Global preferences file
2. User preferences file
3. Commands file

To create a global preferences file, do the following steps:

1. Create a preferences file that is stored as a sequential file or a PDS member. Refer to *IBM z/OS Debugger User's Guide* for a description of preferences files.

The rules for the preferences file are dependant on the programming language of the first program z/OS Debugger encounters. Because you might not know what programming language z/OS Debugger will encounter first, use the following rules when you create the preferences file:

- Put the commands in columns 8 - 72.
- Do not put line numbers in the file.
- Use COMMENT or /\* \*/ to delimit comments.

2. Specify the GPFDSN command to indicate the name of the global preferences file.

For '*file\_name*', specify the name of the data set where the global preferences file will be stored.

The following diagram describes the syntax of the GPFDSN command:

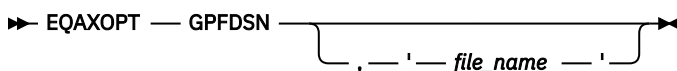

#### 'file\_name'

The name of the data set where you stored the global preferences file.

## Examples

```
EQAXOPT GPFDSN, 'GROUP1.COMMON.DTOOL.PREFS'
EQAXOPT GPFDSN
```

## HOSTPORTS

You can specify this command only in the EQAOPTS load module. It cannot be specified at run time. To use this command in the CICS environment, you must be using the TCP/IP Socket Interface for CICS. For instructions on activating the TCP/IP Socket Interface for CICS, see the z/OS Communications Server *IP CICS Sockets Guide*.

You can use this command to specify a host port or range of ports for a TCP/IP connection from the host to a workstation when using remote debug mode.

The following diagram describes the syntax of the HOSTPORTS command:

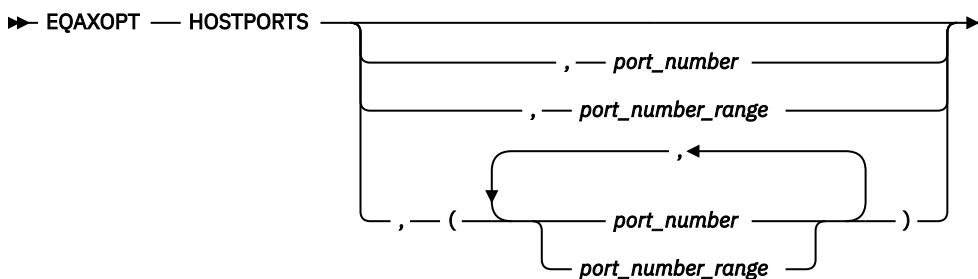

### **port\_number**

A positive integer (1-32767) identifying a TCP/IP port number.

### **port\_number\_range**

The first and last *port\_number* identifying a range of port numbers, separated by a hyphen (-).

## Examples

```
EQAXOPT HOSTPORTS,29500-30499
EQAXOPT HOSTPORTS,(29500-30499,31500-32499)
```

## IGNOREODOLIMIT

This command tells z/OS Debugger to display COBOL table data items even when an ODO value is out of range, and to suppress the following messages:

### **MFI and batch:**

EQA1471E Incorrect value for ODO variable data item

### **Remote:**

EQA2377E Invalid data.

The following diagram describes the syntax of the IGNOREODOLIMIT command:

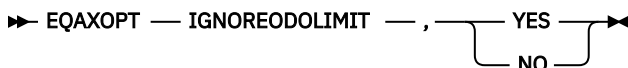

### **YES**

Indicates that z/OS Debugger should display the requested table data item even when an ODO value is out of range, and to suppress issuing EQA1471E or EQA2377E.

### **NO**

Indicates that z/OS Debugger should not display the requested table data item when an ODO value is out of range, and to issue EQA1471E or EQA2377E.

## Examples

```
EQAXOPT IGNOREODOLIMIT,YES
EQAXOPT IGNOREODOLIMIT,NO
```

### Notes:

- The default setting is NO.
- IGNOREODOLIMIT only affects the behaviour of z/OS Debugger if the compilation unit was compiled with one of the following compilers:
  - COBOL for OS/390 & VM Version 2 (5648-A25)
  - Enterprise COBOL for z/OS and OS/390 Version 3 (5655-G53)
  - Enterprise COBOL for z/OS Version 4 (5655-S71)
- IGNOREODOLIMIT is ignored for LangX COBOL.

## IMISISOORIGPSB

**Note:** This command is deprecated. It is accepted for compatibility but has no effect. The original PSB is always preserved.

You can specify this command only in the EQAOPTS load module. It cannot be specified at run time. For the command to take effect, the EQAOPTS load module that contains it must be in the search path of the IMS control region.

This command instructs the IMS Transaction Isolation Facility to preserve the original PSB of the transaction when a message is routed to a private message processing region.

For example, if you register to debug conversational transaction IVTCB, and the private message class 121 is assigned to you, a message routed to your private message processing region will be sent to transaction EQAC1211. Ordinarily, the PSB name for EQAC1211 is EQAT1211. With IMISISOORIGPSB in effect, EQAC1211 is changed to associate the PSB name with IVTCB, DFSIVP34.

The following diagram describes the syntax of the IMISISOORIGPSB command:



### YES

Indicates that you want IMS Isolation to preserve the original PSB of the transaction when a message is routed to a private message. IMS Transaction Isolation bypasses its normal operations for bringing up the transaction under the control of the debugger. Therefore, the debugger starts only for Language Environment-enabled programs.

### NO

Indicates that you want IMS Isolation not to preserve the original PSB of the transaction when a message is routed to a private message. **NO** is the default setting.

## LOGDSN

By default, z/OS Debugger handles the log file data set in one of the following ways:

- In a non-CICS environment, when z/OS Debugger starts in batch mode or full-screen mode, and you allocate the INSPLOG DD name, z/OS Debugger runs the command SET LOG ON FILE INSPLOG OLD and starts writing the log to INSPLOG.
- In a CICS environment, when z/OS Debugger starts in full-screen mode, it runs the command SET LOG OFF. If you want a log file, you run the command SET LONG ON FILE *fileid* OLD and z/OS Debugger starts writing the log to *fileid*.

LOGDSN allows a site or a user to specify the default data set name for the log file. If you specify the LOGDSN command, z/OS Debugger handles the log file in the following way:

- In a non-CICS environment, when z/OS Debugger starts in batch mode or full-screen mode, and you allocate the INSPLOG DD name, z/OS Debugger runs the command SET LOG ON FILE INSPLOG OLD and starts writing the log to INSPLOG . This behavior remains the same.
- In a non-CICS environment, when z/OS Debugger starts in full-screen mode, if you do not allocate the INSPLOG DD name, z/OS Debugger runs the command SET LOG ON FILE *fileid* OLD and starts writing the log to the data set specified in the LOGDSN command.
- In CICS, when z/OS Debugger starts in full-screen mode, it runs the command SET LOG ON FILE *fileid* OLD and starts writing the log to the data set specified in the LOGDSN command.

This allows a user to always write the log file to a data set, whether in CICS or not, and without having to pre-allocate the log file data set.

For instructions on how to specify the allocation parameters for automatically creating the data set, see “LOGDSNALLOC” on page 156. Use the EQAOPTS LOGDSN and LOGDSNALLOC commands to help a new z/OS Debugger user automatically create and write to the log file.

If you are an existing z/OS Debugger user that uses a SAVESETS data set, and you or your site specify the EQAOPTS commands LOGDSN and LOGDSNALLOC, then the SAVESETS data set contains a SET LOG command that overrides the EQAOPTS command LOGDSN.

The following diagram describes the syntax of the LOGDSN command:

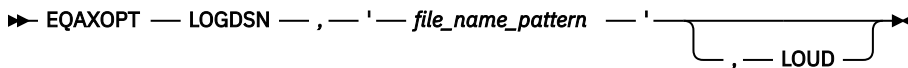

### ***file\_name\_pattern***

Specifies a naming pattern that determines the name of the data set that contains the log file. Follow these guidelines when you create the naming pattern:

- Create a data set name that includes `&&USERID` . as one of the qualifiers. z/OS Debugger substitutes the user ID of the current user for this qualifier when it determines the name of the data set.
- Specify `NULLFILE` to indicate you do not want z/OS Debugger to write to a log file.

### **LOUD**

Specifies that z/OS Debugger display WTO messages, which helps you debug processing done by this command. z/OS Debugger normally does not display any messages if it does not find the data set. If you are trying to determine why z/OS Debugger is not writing to this log file, specify `LOUD` to see if it displays any messages.

If you choose to implement this option, users who want to use the EQAOPTS LOGDSN command must create a log file in one of the following ways:

- Instruct z/OS Debugger to create the log file by specifying the EQAOPTS LOGDSNALLOC command, as described in “LOGDSNALLOC” on page 156.
- Create the log file manually with the allocation parameters that are described in "Data sets used by z/OS Debugger" in the *IBM z/OS Debugger User's Guide* .

### **Example**

```
EQAXOPT LOGDSN , '&&USERID.DBGTOOL.LOG'
```

If you log in with user ID `jsmith`, z/OS Debugger determines the name of the data set to be `JSMITH.DBGTOOL.LOG`.

## **LOGDSNALLOC**

Indicates that you want z/OS Debugger to create the log file data set specified by EQAOPTS LOGDSN command if it does not exist. You specify the EQAOPTS LOGDSNALLOC command with the corresponding allocation parameters for the data set, which z/OS Debugger uses when it creates the data set.



The following diagram describes the syntax of the LOGDSNALLOC command:

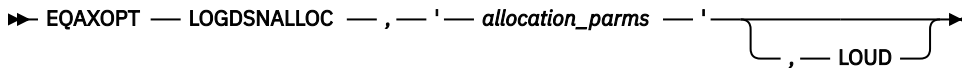

### **allocation\_parms**

Specifies the allocation parameters you want z/OS Debugger to use when it creates the data set. You can specify only the keys in the following list:

- BLKSIZE
- BLOCK
- CYL
- DATACLAS
- DIR
- DSNTYPE
- DSORG
- LRECL
- MGMTCLAS
- RECFM
- SPACE
- STORCLAS
- TRACKS
- UNIT
- VOL

Separate the keys by one or more blanks. z/OS Debugger does not provide defaults for any of the keys.

For information on the format of the keys, see the chapter "BPXWDYN: a text interface to dynamic allocation and dynamic output" in the *z/OS Using REXX and z/OS UNIX System Services* manual. Specify that the data set be sequential. To learn about other formatting rules for the log file, see "Data sets used by z/OS Debugger" of the *IBM z/OS Debugger User's Guide*.

### **LOUD**

Specifies that z/OS Debugger display WTO messages, which helps you debug processing done by this command. z/OS Debugger normally does not display any messages when it creates this data set. If you are trying to determine why the log file was not created, specify LOUD to view any messages.

### **Example**

```
EQAXOPT LOGDSNALLOC, 'MGMTCLAS(STANDARD) STORCLAS(DEFAULT) +
LRECL(72) BLKSIZE(0) RECFM(F,B) DSORG(PS) SPACE(2,2) +
CYL'
```

## **MAXTRANUSER**

You can specify this command only in the EQAOPTS load module. It cannot be specified at run time.

The MAXTRANUSER command defines the maximum number of IMS transactions that a single user can register to debug using the IBM Transaction Isolation Facility. If this command is not specified, the default value of 15 will be used.

The following diagram describes the syntax of the MAXTRANUSER command:



### **max\_trans**

An integer value between 1 and 15 to designate the maximum number of transactions a user can register to debug.

## **MDBG**

If you are using z/OS XL C/C++, Version 1.10 or later, you can indicate that z/OS Debugger always searches for .mdbg files to retrieve the source and debug information by using the MDBG command.

The following diagram describes the syntax of the MDBG command:

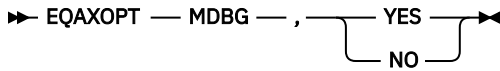

### **YES**

Indicates that z/OS Debugger searches for .mdbg files.

### **NO**

Indicates that z/OS Debugger does not search for .mdbg files.

When you set MDBG to YES, z/OS Debugger retrieves the debug information from an .mdbg file and does not try to find the debug information from the following sources, even if they exist:

- a .dbg file
- if the program was compiled with the ISD compiler option, the object

If you do not specify MDBG or set it to NO, z/OS Debugger retrieves the debug information from either the .dbg file or, if the program was compiled with the ISD compiler option, the object.

### **Example**

```
EQAXOPT MDBG, YES
```

## **MULTIPROCESS**

Controls the behavior of z/OS Debugger when a new POSIX process is created by a fork() or exec() function in the application.

With the MULTIPROCESS command, you can instruct z/OS Debugger to perform any of the following tasks when a new POSIX process is created:

- Continue debugging the current process. The current process is also referred to as the PARENT process.
- Stop debugging the current process and start debugging the newly created process. The newly created process is also referred to as the CHILD process.
- Prompt you to decide whether to follow the PARENT or CHILD process.

**Note:** The MULTIPROCESS command applies only to remote debug mode.

The following diagram describes the syntax of the MULTIPROCESS command:

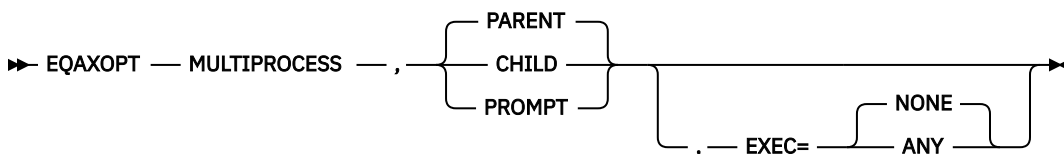

The following list describes the parameters of the MULTIPROCESS command:

### **PARENT**

Indicates that z/OS Debugger continues with the current debug session; that is, z/OS Debugger follows the PARENT process.

## CHILD

Indicates that z/OS Debugger stops debugging the current process and starts debugging the newly created process; that is, z/OS Debugger follows the CHILD process.

## PROMPT

Indicates that the remote debug GUI prompts you to decide whether to follow the PARENT or CHILD process.

## EXEC=ANY

Indicates that z/OS Debugger debugs any process that is reinitialized by the exec() function.

## EXEC=NONE

Indicates that z/OS Debugger does not debug a process that is reinitialized by the exec() function. If you do not specify the EXEC option, the default setting is EXEC=NONE.

## Examples

- Specify that z/OS Debugger follows the PARENT process and debugs the new process that is created by the exec() function.

```
EQAXOPT MULTIPROCESS , PARENT , EXEC=ANY
```

- Specify that z/OS Debugger follows the CHILD process and does not debug the new process that is created by the exec() function.

```
EQAXOPT MULTIPROCESS , CHILD , EXEC=NONE
```

- Specify that you are prompted to choose whether to follow the PARENT or CHILD process and z/OS Debugger does not debug the new process that is created by the exec() function.

```
EQAXOPT MULTIPROCESS , PROMPT
```

## NAMES

The topic "Solving Problems in Complex Applications" in the IBM z/OS Debugger User's Guide in the describes how the NAMES command can be used to perform several specific functions dealing with load module and compile unit names recognized by z/OS Debugger. However, the NAMES command cannot be used to alter the behavior of load module or compile unit names that have already been seen by z/OS Debugger at the time the NAMES command is processed.

If it becomes necessary to perform these functions on the initial load module processed by z/OS Debugger or on any of the compile units contained in that load module, you must provide the information (that would otherwise have been specified using the NAMES command) through the EQAOPTS NAMES command.

One or more invocations of the EQAOPTS NAMES command can be used for this purpose.

The following diagram describes the syntax of the NAMES command:

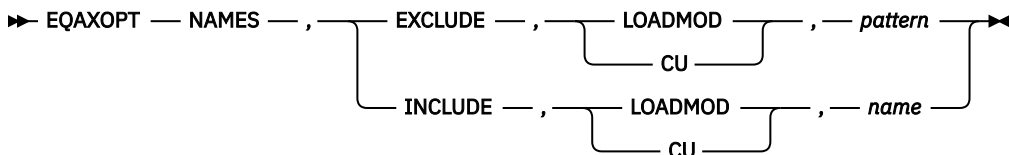

Each of these fields corresponds to the similar parameter in the z/OS Debugger NAMES command. If you use an asterisk (\*) in *pattern* to indicate a wildcard, you must enclose *pattern* in apostrophes.

## Examples

```
EQAXOPT NAMES , EXCLUDE , LOADMOD , 'ABC1*'
EQAXOPT NAMES , EXCLUDE , CU , MYCU22
EQAXOPT NAMES , EXCLUDE , CU , 'MYCU*'
EQAXOPT NAMES , INCLUDE , LOADMOD , CEEMYMOD
EQAXOPT NAMES , INCLUDE , CU , EQATESTP
```

## NODISPLAY

In the following two situations, in which a user can request a specific user interface, that interface might not be available:

- Full-screen mode using the Terminal Interface Manager. If the terminal is not available, the program being debugged terminates with a U4038 abend.
- Remote debugger. If the remote debugger is not available, z/OS Debugger will use full-screen mode if the user is running under TSO. If the user is not running under TSO, z/OS Debugger will use batch mode.

In both cases, Write To Operator (WTO) messages also appear.

You can modify these behaviors by specifying the EQAOPTS NODISPLAY command so that z/OS Debugger continues processing as if the user immediately entered a QUIT DEBUG command. This modification prevents any forced abend or prevents the debugger from starting.

The following diagram describes the syntax of the NODISPLAY command:

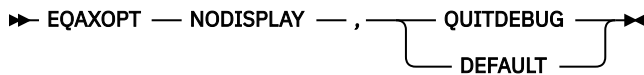

### DEFAULT

z/OS Debugger follows the default behavior.

### QUITDEBUG

z/OS Debugger displays a message that indicates that z/OS Debugger will quit, and that the user interface could not be used. z/OS Debugger processing continues as if the user entered a QUIT DEBUG command.

### Example

```
EQAXOPT NODISPLAY,QUITDEBUG
```

## PREFERENCESDSN

Indicates that you want z/OS Debugger to read a user's preferences file (with the name of the data set containing the preferences file determined by the specified naming pattern) each time it starts. This works in the following situation:

- You do not specify a data set name or DD name for the user's preferences file using any other method; for example, the TEST runtime option.
- In a non-CICS environment, you do not allocate ISPPREF DD.
- You or your site specifies the PREFERENCESDSN command.
- The data set specified by the PREFERENCESDSN command exists.

The following diagram describes the syntax of the PREFERENCESDSN command:

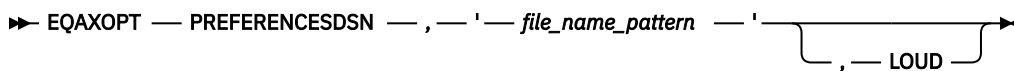

### *file\_name\_pattern*

Specifies a naming pattern that determines the name of the data set that contains the preferences file. Follow these guidelines when you create the naming pattern:

- Create a data set name that includes &&USERID. as one of the qualifiers. z/OS Debugger substitutes the user ID of the current user for this qualifier when it determines the name of the data set.
- Specify NULLFILE to indicate you do not want z/OS Debugger to process a preferences file.

## LOUD

Specifies that z/OS Debugger display WTO messages, which helps you debug processing done by this command. z/OS Debugger normally does not display any messages if it does not find the data set. If you are trying to determine why z/OS Debugger is not processing your preferences file, specify LOUD to see if it displays any messages about not finding the data set.

If you choose to implement this option, users who want to use this function must create the preferences file as a sequential data set with the allocation parameters that are described in "Data sets used by z/OS Debugger" in the *IBM z/OS Debugger User's Guide*.

### Example

```
EQAXOPT PREFERENCESDSN, '&&USERID.DBGTOOL.PREFS'
```

If you log in with user ID `jsmith`, z/OS Debugger determines the name of the data set to be `JSMITH.DBGTOOL.PREFS`.

## SAVEBPDSN, SAVESETDSN

You can modify the default names of the data sets used to save and restore settings and breakpoints, monitor values, and LOADDEBUGDATA (LDD) specifications. The following list describes the initial default names:

- For settings: `userid.DBGTOOL.SAVESETS`
- For breakpoints, monitor values, and LOADDEBUGDATA (LDD) specifications: `userid.DBGTOOL.SAVEBPS`

To change the default name for either or both of these data sets, you need to specify the EQAOPTS SAVESETDSN and SAVEBPDSN commands, along with a corresponding naming pattern for the data set.

The following diagram describes the syntax of the SAVESETDSN and SAVEBPDSN commands:

```
EQAXOPT SAVEBPDSN , — 'file_name_pattern' — EQAXOPT
 SAVESETDSN
```

### *file\_name\_pattern*

Specifies a naming pattern for the data set that stores this information.

In most environments, you should choose one of the following rules for the naming pattern:

- Any data set name that includes `&&USERID.` as one of the qualifiers. z/OS Debugger substitutes the user ID of the current user for this qualifier when it creates the data set.
- A DD name (Reminder: DD names are not supported under CICS)
- The string `NULLFILE` to indicate that saving and restoring this information is not supported

### Examples

```
EQAXOPT SAVESETDSN, 'CICS.DTDATA.&&USERID.SAVSET'
EQAXOPT SAVEBPDSN, '&&USERID.USERDATA.DTOOL.SAVBPMON';
```

## SAVESETDSNALLOC, SAVEBPDSNALLOC

Indicates that you want z/OS Debugger to create the data sets for SAVESETS, SAVEBPS, or both (specified by EQAOPTS SAVESETDSN or SAVEBPDSN commands) if they do not exist. You specify the EQAOPTS SAVESETDSNALLOC and SAVEBPDSNALLOC commands with the corresponding allocation parameters for the data sets, which z/OS Debugger uses when it creates the data sets. After creating each data set, z/OS Debugger runs commands that save the information (settings, breakpoints, monitors, preferences, and LDD specifications) in the corresponding data set.

The following diagram describes the syntax of the SAVEBPDSNALLOC and SAVESETDSNALLOC commands:

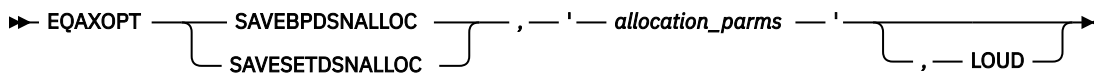

### **allocation\_parms**

Specifies the allocation parameters you want z/OS Debugger to use when it creates the data set. You can specify only the keys in the following list:

- BLKSIZE
- BLOCK
- CYL
- DATACLAS
- DIR
- DSNTYPE
- DSORG
- LRECL
- MGMTCLAS
- RECFM
- SPACE
- STORCLAS
- TRACKS
- UNIT
- VOL

Separate the keys by one or more blanks. z/OS Debugger does not provide defaults for any of the keys.

For information on the format of the keys, see the chapter "BPXWDYN: a text interface to dynamic allocation and dynamic output" in the *z/OS Using REXX and z/OS UNIX System Services* manual. Specify that the data set be sequential for SAVESETS; a PDS or PDSE for SAVEBPS. To learn about other formatting rules for these files, see "Data sets used by z/OS Debugger" of the *IBM z/OS Debugger User's Guide*.

### **LOUD**

Specifies that z/OS Debugger display WTO messages, which helps you debug processing done by this command. z/OS Debugger normally does not display any messages when it creates these data sets. If you are trying to determine why the data sets were not created, specify LOUD to view any messages.

z/OS Debugger does the following tasks when you specify these commands:

1. If you specified the SAVESETDSNALLOC command, it creates the SAVESETS data set.
2. If it creates the SAVESETS data set successfully, it runs the following commands:

```
SET SAVE SETTINGS AUTO;
SET RESTORES SETTINGS AUTO;
```

If it did not create the SAVESETS data set successfully, it skips the rest of these steps and does the next processing task.

3. If you specified the SAVEBPDSNALLOC command, it creates the SAVEBPS data set.
4. If it creates the SAVEBPS data set successfully, it runs the following commands:

```
SET SAVE BPS AUTO;
SET SAVE MONITORS AUTO;
SET RESTORE BPS AUTO;
SET RESTORE MONITORS AUTO;
```

In a CICS environment, review the performance implications discussed in the "Performance considerations in multi-enclave environments" section of the "Using full-screen mode: overview" topic

in the *IBM z/OS Debugger User's Guide* before choosing to implement the SAVEBPDSNALLOC command. If you think the performance implications might adversely affect your site, do not implement the SAVEBPDSNALLOC command in the EQAOPTS for CICS.

### Example

```
EQAXOPT SAVESETDSNALLOC, 'MGMTCLAS(STANDARD) STORCLAS(DEFAULT) +
LRECL(3204) BLKSIZE(0) RECFM(V,B) DSORG(PS) SPACE(2,2) +
TRACKS'
EQAXOPT SAVEBPDSNALLOC, 'MGMTCLAS(STANDARD) STORCLAS(DEFAULT) +
LRECL(3204) BLKSIZE(0) RECFM(V,B) DSORG(PO) +
DSNTYPE(LIBRARY) SPACE(1,3) CYL'
```

## SESSIONTIMEOUT

You can specify this command only in the EQAOPTS load module. It cannot be specified at run time.

You can establish a timeout for idle z/OS Debugger sessions that use the Terminal Interface Manager. Timed out sessions are canceled after a specified period of no user activity.

The following diagram describes the syntax of the SESSIONTIMEOUT command:

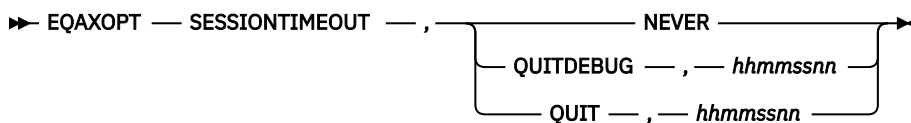

### NEVER

No timeout is enforced. Unattended sessions will not be canceled.

### QUITDEBUG, hmmmssnn

Sessions left unattended for the specified time interval will be canceled, and the process being debugged will proceed as though the QUIT DEBUG command had been entered.

The time interval is expressed as *hmmmssnn*, where

- *hh* is the number of hours,
- *mm* is the number of minutes,
- *ss* is the number of seconds,
- *nn* is the number of hundredths of seconds.

### QUIT, hmmmssnn

Sessions left unattended for the specified time interval will be canceled, and the process being debugged will be terminated with a U4038 abend, as though the QUIT ABEND command had been entered.

The time interval is expressed as *hmmmssnn*, where

- *hh* is the number of hours,
- *mm* is the number of minutes,
- *ss* is the number of seconds,
- *nn* is the number of hundredths of seconds.

If the command is not specified in the EQAOPTS load module, the default behavior is "NEVER", which means that any full-screen mode session using Terminal Interface Manager left unattended will not be canceled.

### Example

To specify a timeout interval of 1 hour and allow the debugged process to proceed after the debug session is canceled, enter the following EQAOPTS command:

```
EQAXOPT SESSIONTIMEOUT, QUITDEBUG, 01000000
```

## STARTSTOPMSG

This command controls whether to issue a message when each debugging session is initiated or terminated. By default, these messages are not issued.

The following diagram describes the syntax of the STARTSTOPMSG command:

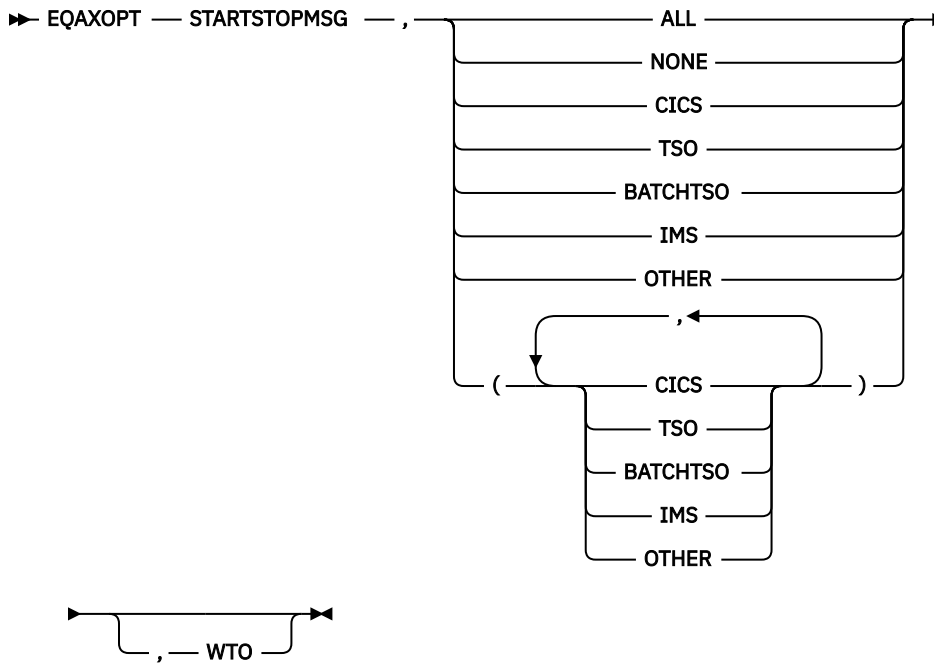

The following list describes the parameters of the STARTSTOPMSG command:

### ALL

Indicates that the start/stop messages should be written in all environments.

### NONE

Indicates that no start/stop messages should be written. If you do not specify EQAOPTS STARTSTOPMSG, the default option is NONE.

### CICS

Indicates that the start/stop messages should be written in the CICS environment.

### TSO

Indicates that the start/stop messages should be written in the TSO environment.

### BATCHTSO

Indicates that the start/stop messages should be written in the BATCH TSO environment.

### IMS

Indicates that the start/stop messages should be written when running under IMS. In addition, an informational message that contains the IMS system ID, region ID, and transaction ID is written.

### OTHER

Indicates that the start/stop messages should be written in all other environments, such as MVS batch.

### WTO

Indicates that the start/stop messages should be written to the system log using a WTO.

### Examples

```
EQAXOPT STARTSTOPMSG , ALL , WTO
EQAXOPT STARTSTOPMSG , (TSO , OTHER) , WTO
```



## STARTSTOPMSGDSN

You can specify this command only in the EQAOPTS load module. It cannot be specified at run time.

You can use this command to indicate that you want z/OS Debugger to write a message in the message file when the debug session is started and stopped.

The following diagram describes the syntax of the STARTSTOPMSGDSN command:

►► EQAXOPT — STARTSTOPMSGDSN — , — 'file\_name' —  
└──────────────────────────┘  
└────────── LOUD ─────────┘

### 'file\_name'

Specifies an MVS sequential data set with FB LRECL 80 characteristics. It is recommended that you allocate sufficient space for the file and perform regular maintenance by removing outdated messages. In a CICS environment, the region owner must have the update authority to the data set.

### LOUD

Specifies that z/OS Debugger displays WTO messages, which help you debug processing done by this command. z/OS Debugger normally does not display any messages when it operates on the data set. If you try to determine problems related to the data set, specify LOUD to view any related messages.

### Example

```
EQAXOPT STARTSTOPMSGDSN, 'EQAW.SMSG.LOG'
```

## SUBSYS

If both of the following conditions apply at your site, you need to use the EQAOPTS SUBSYS command:

- The source code is managed by a library system that requires that you specify the `SUBSYS=library_subsystem_name` allocation parameter when you allocate a data set.
- Your users are debugging C or C++ programs without using the EQAOPTS MDBG command or debugging Enterprise PL/I programs compiled without the SEPARATE suboption of the TEST compiler option.

In this case, you must run z/OS Debugger and the specified subsystem on the same system.

You cannot use SUBSYS to debug programs that run under CICS.

The following diagram describes the syntax of the SUBSYS command:

►► EQAXOPT — SUBSYS —  
└──────────────────────────┘  
└── , — ' four\_character\_name — ' ───┘

### four\_character\_name

Specifies the subsystem name to be used.

### Examples

```
EQAXOPT SUBSYS
EQAXOPT SUBSYS, 'SBSX'
```

## SVCScreen

In a non-CICS environment, z/OS Debugger requires SVC screening for the following situations:

- Invoking z/OS Debugger by using EQANMDBG to debug programs that start outside Language Environment including non-Language Environment COBOL programs.
- Debugging programs that do not run in Language Environment and are started by programs that begin in Language Environment.
- Debugging LangX COBOL programs.
- Detecting services such as MVS LINK, LOAD, DELETE and ATTACH.

If you need to run z/OS Debugger in any of the following situations, you must specify the actions that z/OS Debugger must take regarding SVC screening:

- Start z/OS Debugger by using EQANMDBG in an environment that already uses SVC screening.
- Run z/OS Debugger when debugging programs that do not run in Language Environment and are started by programs that begin in Language Environment.
- Run z/OS Debugger when debugging LangX COBOL programs.
- Run z/OS Debugger when you need to detect services such as MVS LINK, LOAD and DELETE.
- Run z/OS Debugger when you debug subtasks within a multi-tasked application, where subtasks are started by using the ATTACH assembler macro.
- Run z/OS Debugger in a situation that requires SVC screening and SVC screening is already in use by a program with which z/OS Debugger supports MERGE SVC screening as described by the MERGE operand that follows.

The following diagram describes the syntax of the SVCSCREEN command:

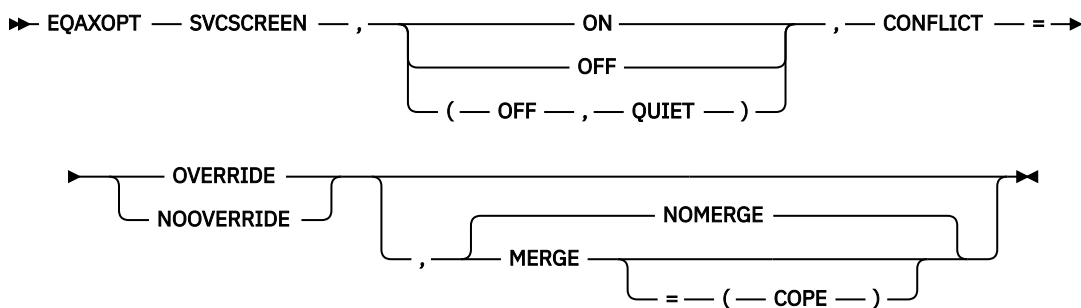

#### ON

Indicates that you want z/OS Debugger to use SVC screening in order to support MVS LOAD, DELETE, and LINK SVCs.

#### OFF

Indicates that you want z/OS Debugger to not use SVC screening. z/OS Debugger will not know about programs started through MVS LOAD, DELETE, and LINK SVCs. If you start z/OS Debugger by using the EQANMDBG program, the OFF setting is ignored.

#### QUIET

Suppresses message EQA2458I, which is written to the z/OS Debugger log when SVC screening is disabled by default.

#### CONFLICT=

Specifies what you want z/OS Debugger to do when ON is specified or defaulted and SVC screening is already used by another program.

#### OVERRIDE

Indicates that you want z/OS Debugger to override the current SVC screening and take control of SVC screening.

#### NOOVERRIDE

Indicates that if SVC screening is already in use, z/OS Debugger does not initiate SVC screening and proceeds as if OFF were specified.

#### NOMERGE

Indicates that SVC screening is not to be merged with SVC screening used by any other product. NOMERGE is the default.

#### MERGE

Indicates that when SVC screening is already being used by another program when z/OS Debugger starts, z/OS Debugger saves the current SVC screening environment, then enables SVC screening for both z/OS Debugger and the other program. When z/OS Debugger terminates, it restores the original SVC screening environment.

Currently, z/OS Debugger supports the MERGE command with only one other program: COPE.

If you specify the MERGE command and z/OS Debugger does not recognize the program that is using the SVC screening, the MERGE command is ignored and z/OS Debugger starts based on the value of the CONFLICT option.

### MERGE=(COPE)

If COPE is active, z/OS Debugger saves the current SVC screening environment, then enables SVC screening for both z/OS Debugger and COPE. When z/OS Debugger terminates, it restores COPE's SVC screening environment.

If COPE is not active, z/OS Debugger starts based on the value of the CONFLICT option.

The default parameters for the EQAOPTS SVCSCREEN command is one of the following situations:

- If z/OS Debugger is started by using the EQANMDBG program:  
SVCSCREEN, ON, CONFLICT=NOOVERRIDE, NOMERGE
- If z/OS Debugger is started by any other method:  
SVCSCREEN, OFF, CONFLICT=NOOVERRIDE, NOMERGE

Use [Table 32 on page 167](#) as a guide to select the appropriate suboptions.

### Examples

```
EQAXOPT SVCSCREEN,ON,CONFLICT=OVERRIDE,NOMERGE
EQAXOPT SVCSCREEN,OFF,CONFLICT=NOOVERRIDE,NOMERGE
```

## Combinations of suboptions for the EQAOPTS SVCSCREEN command

The following table shows examples of combinations of suboptions for the EQAOPTS SVCSCREEN command:

| <i>Table 32. Combination of SVCSCREEN options and their effects</i> |                                           |                                                                                                                                                                                                                                                                                                                                                                                                                      |
|---------------------------------------------------------------------|-------------------------------------------|----------------------------------------------------------------------------------------------------------------------------------------------------------------------------------------------------------------------------------------------------------------------------------------------------------------------------------------------------------------------------------------------------------------------|
| <b>SVCSCREEN options</b>                                            | <b>Type of z/OS Debugger session</b>      | <b>Action</b>                                                                                                                                                                                                                                                                                                                                                                                                        |
| OFF, CONFLICT=NOOVERRIDE<br>(default)                               | z/OS Debugger started by using EQANMDBG   | Same as for ON, CONFLICT=NOOVERRIDE.                                                                                                                                                                                                                                                                                                                                                                                 |
|                                                                     | z/OS Debugger started by any other method | <ul style="list-style-type: none"> <li>• z/OS Debugger does not enable its SVC screening.</li> <li>• You cannot debug programs that do not run in Language Environment which were started by programs that do run in Language Environment.</li> <li>• z/OS Debugger does not detect the MVS services LINK, LOAD and DELETE.</li> <li>• The CONFLICT setting is ignored when the OFF setting is specified.</li> </ul> |
| OFF, CONFLICT=OVERRIDE                                              | z/OS Debugger started by using EQANMDBG   | Same as for ON, CONFLICT=OVERRIDE.                                                                                                                                                                                                                                                                                                                                                                                   |
|                                                                     | z/OS Debugger started by any other method | Same as for OFF, CONFLICT=NOOVERRIDE.<br><br>The CONFLICT setting is ignored when the OFF setting is specified.                                                                                                                                                                                                                                                                                                      |

Table 32. Combination of SVSCREEN options and their effects (continued)

| SVSCREEN options        | Type of z/OS Debugger session             | Action                                                                                                                                                                                                                                                                                                                                                                                                                                                                |
|-------------------------|-------------------------------------------|-----------------------------------------------------------------------------------------------------------------------------------------------------------------------------------------------------------------------------------------------------------------------------------------------------------------------------------------------------------------------------------------------------------------------------------------------------------------------|
| ON, CONFLICT=NOOVERRIDE | z/OS Debugger started by using EQANMDBG   | If SVC screening is active, z/OS Debugger terminates. If SVC screening is not active, z/OS Debugger enables its SVC screening, runs the debugging session, and disables its SVC screening after the debugging session ends.                                                                                                                                                                                                                                           |
|                         | z/OS Debugger started by any other method | If SVC screening is active, z/OS Debugger does not enable its SVC screening. You cannot debug programs that do not run in Language Environment which were started by programs that do run in Language Environment. z/OS Debugger does not detect the MVS services LINK, LOAD and DELETE.<br><br>If SVC screening is not active, z/OS Debugger enables its SVC screening, runs the debugging session, and disables its SVC screening after the debugging session ends. |
| ON, CONFLICT=OVERRIDE   | z/OS Debugger started by using EQANMDBG   | If any SVC screening is active and the NOMERGE option is in effect, z/OS Debugger overrides the existing SVC screening. This is also the default behavior. z/OS Debugger enables its SVC screening, runs the debugging session, and disables its SVC screening after the debugging session ends. If any SVC screening was active, z/OS Debugger restores the previous SVC screening. If you specify the MERGE option, see the following information about MERGE.      |
|                         | z/OS Debugger started by any other method |                                                                                                                                                                                                                                                                                                                                                                                                                                                                       |

## TCPIP DATASN

You can specify this command only in the EQAOPTS load module. It cannot be specified at run time.

You can use this command to instruct z/OS Debugger to dynamically allocate the specified *'file\_name'* to DDNAME SYSTCPD (if SYSTCPD is not already allocated). This provides the data set name for TCPIP.DATA when no GLOBALTCPIPDATA statement is configured in the system TCP/IP options.

The following diagram describes the syntax of the TCPIP DATASN command:

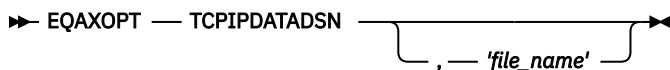

### Examples

```
EQAXOPT TCPIP DATASD, 'SYS2.TCPIP.DATA'
```

```
EQAXOPT TCPIP DATASD, 'SYS2.TCPIP.PARMLIB(TCPDATA)'
```

If you want to use an alternative TCP/IP stack, you can add an entry to the specified TCPIP . DATA dataset with a TCPIPJOBNAME statement.

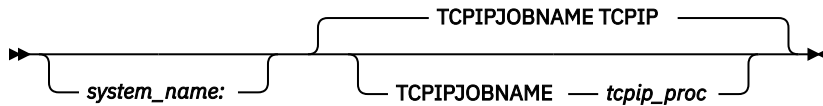

### Example

To specify TCPIPA as the name of the procedure that was used to start the TCP/IP address space, add the following code to the specified TCPIP . DATA dataset:

```
TCPIPJOBNAME TCPIPA
```

## THREADTERMCOND

You can indicate that z/OS Debugger should not prompt the user when a FINISH, CEE066, or CEE067 thread termination condition is raised by Language Environment, regardless of the suboptions used in the TEST runtime option. These conditions are raised by statements like STOP RUN, GOBACK, or EXEC CICS RETURN, which can occur frequently in an application program. Suppressing the display of these prompts can reduce the number of times your users are interrupted by this prompt during a debugging session.

The following diagram describes the syntax of the THREADTERMCOND command:

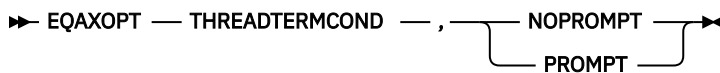

### NOPROMPT

Suppress the display of termination prompts.

### PROMPT

Prompts the user at termination. If you do not specify the THREADTERMCOND command, the default PROMPT is used.

### Example

```
EQAXOPT THREADTERMCOND, NOPROMPT
```

## TIMACB

You can include this command only in the EQAOPTS load module. You cannot specify it at run time.

TIMACB identifies the name of an ACB, other than EQASESSM, that z/OS Debugger uses to make full-screen mode using the Terminal Interface Manager work in an environment where you want to run the Terminal Interface Manager on more than one LPAR in the same VTAM network. You specify TIMACB as the last step in "Example: Defining the VTAM EQAMVnnn and Terminal Interface Manager APPL definition statements when z/OS Debugger runs on four LPARs" in the IBM z/OS Debugger Customization Guide.

The following diagram describes the syntax of the TIMACB command:



### ACB\_name

The new ACB name you want used. The default name is EQASESSM.

### Example

```
EQAXOPT TIMACB,EQASESS2
```

## END

The END command identifies the last EQAOPTS command. You must always specify it and it must be the last command in the input stream.

The following diagram describes the syntax of the END command:

►► EQAXOPT — END ◄◄

### Example

```
EQAXOPT END
```

## Appendix A. SMP/E USERMODs

SMP/E USERMODs are available for a number of the customizations listed in the *IBM z/OS Debugger Customization Guide* and *IBM z/OS Debugger User's Guide*. The following table shows the available USERMODs and the associated names.

| <i>hlq</i> .SEQAEXEC | <i>hlq</i> .SEQATLIB | <i>hlq</i> .SEQASAMP    | <i>hlq</i> .SEQAMOD   | SMP/E USERMOD in <i>hlq</i> .SEQASAMP |
|----------------------|----------------------|-------------------------|-----------------------|---------------------------------------|
| EQASTART             |                      |                         |                       | EQAUMOD2                              |
|                      | EQALMPFX             |                         |                       | EQAUMOD3                              |
|                      | EQALMPGM             |                         |                       | EQAUMOD4                              |
|                      | EQAZDFLT             |                         |                       | EQAUMOD5                              |
|                      | EQAZDSYS             |                         |                       | EQAUMOD6                              |
|                      | EQAZDUSR             |                         |                       | EQAUMOD7                              |
|                      | EQAZPROC             |                         |                       | EQAUMOD8                              |
|                      |                      | EQACUIDF <sup>1</sup>   | EQACUIDF <sup>2</sup> | EQAUMOD9                              |
|                      |                      | EQACUIDM                |                       | EQAUMODA                              |
|                      |                      | EQAOPTS <sup>1</sup>    | EQAOPTS <sup>2</sup>  | EQAUMODE                              |
|                      |                      | EQAUEDAT <sup>1</sup>   | EQAUEDAT <sup>2</sup> | EQAUMODF                              |
|                      | EQABMPSM             |                         |                       | EQAUMODG                              |
|                      | EQADBBSM             |                         |                       | EQAUMODH                              |
|                      | EQADLISM             |                         |                       | EQAUMODI                              |
|                      |                      | EQAUEDAC <sup>1</sup>   | EQAUEDAT <sup>2</sup> | EQAUMODJ                              |
|                      |                      | EQAD3CXT <sup>1,3</sup> | EQAD3CXT <sup>2</sup> | EQAUMODK                              |
| EQAJCL               |                      |                         |                       | EQAUMODL                              |

**Note:**

1. The source for these parts is in *hlq*.SEQASAMP. The executable (the part updated by the USERMOD) is in SEQAMOD.
2. The *IBM z/OS Debugger User's Guide* and *IBM z/OS Debugger Customization Guide* discussion of these parts typically shows generating a private copy of these load modules. If you want to update *hlq*.SEQAMOD so that all users see these customizations, you should use the SMP/E USERMOD method.
3. z/OS Debugger SMP/E USERMODs for these parts are only available if you choose the method that updates *hlq*.SEQAMOD. They are not available if you choose to update CEE.SCEERUN.





---

## Appendix B. Enabling debugging in full-screen mode using a dedicated terminal

**Note:** This chapter is not applicable to IBM Developer for z/OS (non-Enterprise Edition) or IBM Wazi Developer for Red Hat CodeReady Workspaces.

This is a copy of Chapter 6 from the Debug Tool V10.1 Customization Guide. It documents the setup for 'full-screen mode using a dedicated terminal without/with Terminal Interface Manager' (indicated via the TEST runtime sub-options %MFI and %VTAM). It should be used

- by sites that want to continue to use the TEST %MFI option to specify a dedicated terminal
- as a reference for sites that are moving from an older release of Debug Tool to Debug Tool V11 (or later).

To enable users to debug the following types of programs while using a 3270-type terminal, you need to enable full-screen mode using a dedicated terminal:

- Batch programs
- TSO programs (using a separate terminal for debugging)
- Programs running under UNIX System Services
- Db2 stored procedures
- IMS programs

A dedicated terminal has specific set up requirements so that it can interact with z/OS Debugger in these environments. Thus, the terminal is dedicated for use by z/OS Debugger. Users do not typically use it to access other services.

---

### How z/OS Debugger uses full-screen mode using a dedicated terminal

---

The following steps describe how a user would start a debugging session for a batch job using full-screen mode using a dedicated terminal. Study these steps to understand how z/OS Debugger uses full-screen mode using a dedicated terminal and to understand why you need to do the configuration steps described in “[Enabling full-screen mode using a dedicated terminal](#)” on page 174.

1. Start two terminal emulator sessions. Connect the second session to a terminal LU that can handle a full-screen mode using a dedicated terminal.
2. On the first terminal emulator session, log on to TSO.
3. Note the LU name (LU\_name) to which the second terminal emulator session is connected.
4. Make following changes to the PARM string in the batch job that starts your debugging session:
  - Specify the TEST runtime option in the following format:

```
TEST(,,MFI%LU_name:*)
```

*LU\_name* is the LU name you noted in step “3” on page 173.

If your site requires that you specify the VTAM network identifier (NETID), specify the TEST runtime option in the following format:

```
TEST(,,MFI%NETID.LU_name:*)
```

*NETID* identifies the network in which the second terminal emulator resides. For example, in the string NETA.LU001, NETA is the *NETID*.

5. Submit the batch job. z/OS Debugger completes the following tasks:

- a. z/OS Debugger allocates a VTAM ACB (EQAMVnnn) for its end of a VTAM session.
- b. z/OS Debugger uses VTAM to initiate a session with the terminal LU to which the second terminal emulator is connected.
- c. A VTAM session is then conducted between z/OS Debugger and the terminal LU.

The user does not log on to any host application through the second terminal emulator. z/OS Debugger initiates the connection between itself and that second terminal LU.

6. On the second terminal emulator, the emulator displays a full-screen mode debugging session. Interact with it in the same way you would with any other full-screen mode debugging session.

This technique requires you to define and configure a number of items in the z/OS Communications Server. Section “[Enabling full-screen mode using a dedicated terminal](#)” on page 174 describes these definitions and configuration.

## Enabling full-screen mode using a dedicated terminal

---

To enable full-screen mode using a dedicated terminal, do the following steps:

1. Define the VTAM APPL definition statements that z/OS Debugger uses for its end of the session, as described in “[Defining the VTAM EQAMVnnn APPL definition statements](#)” on page 174.
2. Define the terminal LUs used by z/OS Debugger, as described in “[Defining terminal LUs used by z/OS Debugger](#)” on page 176.
3. If your terminals are connected through a SNA network, you are done. If your terminals are connected through a TN3270 network, you must continue.
4. If a TN3270 server manages the terminal, configure the TN3270 Telnet Server, as described in “[Configuring the TN3270 Telnet Server to access the terminal LUs](#)” on page 177.
5. Verify the installation of the facility to debug programs in full-screen mode using a dedicated terminal, as described in “[Verifying the customization of the facility to debug full-screen mode using a dedicated terminal](#)” on page 181.

## Defining the VTAM EQAMVnnn APPL definition statements

You must define the APPL definition statements that z/OS Debugger uses for its end of the VTAM session with the terminal LU. You can define up to 999 APPLs for z/OS Debugger. You can define an APPL by using one of the following naming conventions:

- Define each APPL with the following naming convention: the first five characters of the APPL name must be EQAMV and the last three characters must be consecutive three digit numbers, starting with 001. Do not code an ACBNAME operand on the APPL definition statements for this method.
- Define each APPL name with the naming convention you use at your site. Code an ACBNAME operand on the APPL definition statement that uses EQAMV as the first five characters, and three numeric digits (starting with 001) as the last three characters.

**Tip:** The EQAMVnnn names are used internally by z/OS Debugger. Do not confuse these names with the terminal LU names. The user needs to know only the terminal LU name, which he specifies with the MFI% suboption of the TEST runtime option.

The number of APPL names you define must be sufficient to allow for the maximum number of concurrent z/OS Debugger full-screen mode using a dedicated terminal sessions. (z/OS Debugger uses one of these APPL names for its end of each VTAM session that is initiated with a terminal LU.)

The descriptions and examples used in this book assume you defined APPL names by using the EQAMVnnn naming convention. z/OS Debugger uses the EQAMVnnn names for internal processing.

The EQAWAPPL member in the *hlq*.SEQASAMP data set predefines 50 APPL names, EQAMV001 to EQAMV050. You can do one of the following tasks to add this member to the VTAM definitions library (VTAMLST).

- Copy EQAWAPPL into a new member:

1. Create a new member in the VTAM definitions library (VTAMLST). The VTAM definitions library is often stored in the data set SYS1.VTAMLST.
  2. Copy the contents of the EQAWAPPL member into the new member.
  3. Add the new member's name to the VTAM start options configuration file, ATCCONxxx, so that VTAM activates the z/OS Debugger APPL definitions at initialization.
- Copy EQAWAPPL into an existing member that is already defined in VTAMLST:
    1. Select a member in the VTAM definitions library (VTAMLST) that contains the major node definitions.
    2. Copy the APPL definition statements for z/OS Debugger from the EQAWAPPL member into the selected member.

**Tip:** The existing member has the VBUILD TYPE=APPL statement, so do not copy this statement from EQAWAPPL.

If you are running VTAM in a multi-domain environment and you require the ability to debug full-screen mode using a dedicated terminal on more than one host, edit the copy of EQAWAPPL on each system to make the names for z/OS Debugger major and minor nodes unique for each system.

For example, if you have hosts SYSA, SYSB, and SYSC, and need to provide definitions for up to 50 concurrent users debugging programs in full-screen mode using a dedicated terminal on each system, you can code the following entries:

- SYSA VTAMLST EQAWAPPL entry:

```
EQAAPPLA VBUILD TYPE=APPL
EQAMV001 APPL AUTH=(PASS,ACQ),PARSESS=NO
EQAMV002 APPL AUTH=(PASS,ACQ),PARSESS=NO
...
EQAMV050 APPL AUTH=(PASS,ACQ),PARSESS=NO
```

- SYSB VTAMLST EQAWAPPL entry:

```
EQAAPPLB VBUILD TYPE=APPL
EQAMV051 APPL AUTH=(PASS,ACQ),PARSESS=NO
EQAMV052 APPL AUTH=(PASS,ACQ),PARSESS=NO
...
EQAMV100 APPL AUTH=(PASS,ACQ),PARSESS=NO
```

- SYSC VTAMLST EQAWAPPL entry:

```
EQAAPPLC VBUILD TYPE=APPL
EQAMV101 APPL AUTH=(PASS,ACQ),PARSESS=NO
EQAMV102 APPL AUTH=(PASS,ACQ),PARSESS=NO
...
EQAMV150 APPL AUTH=(PASS,ACQ),PARSESS=NO
```

You can have up to 999 unique APPL names for full-screen mode using a dedicated terminal spread across your network.

As an alternative to coding each minor node name, you can use the Model Application Names function. With this function, VTAM dynamically creates the minor nodes. Use one of the following ways (alter these examples, if needed, to maintain unique names per system as discussed in [“Defining the VTAM EQAMVnnn APPL definition statements”](#) on page 174):

- EQAMV??? APPL AUTH=(PASS,ACQ),PARSESS=NO
- ABCDE??? APPL AUTH=(PASS,ACQ),PARSESS=NO,ACBNAME=EQAMV???

## Activating the VTAM EQAMVnnn APPLs

Activate the VTAM APPLs by entering the following command from the console, where *member-name* is the member name in the VTAM library (VTAMLST):

```
VARY NET,ACT,ID=member-name
```

## Defining terminal LUs used by z/OS Debugger

The terminal LUs used by z/OS Debugger in full-screen mode using a dedicated terminal must meet the requirements specified in the following sections:

[“Terminal LU specifications” on page 176](#)

[“Terminal LU state requirements” on page 176](#)

### Terminal LU specifications

All terminal LUs that are used to debug programs in full-screen mode using a dedicated terminal must have a default log mode specified in the corresponding VTAM definitions. This log mode must match the characteristics of the terminal emulator session that is attached to this terminal LU. Use the DLOGMOD= operand on the APPL definition for the terminal logical unit (LU) to specify the default log mode.

To support the widest range of terminal characteristics, we recommend you use a DLOGMOD specification of D4C32XX3, in the IBM supplied MODETAB of ISTINCLM. If you use a DLOGMOD specification of D4C32XX3, you must use a TN3270E emulator that responds to a VTAM query with terminal characteristics, such as size, color, and extended graphics.

If your terminal emulator session cannot provide this information, select a log mode that matches your terminal emulator session characteristics. For example, if you have a TN3270 emulator that does not respond to a query, select one of the following log modes that matches the terminal size that the user will be using:

- D4C32782 24x80
- D4C32783 32x80
- D4C32784 43x80
- D4C32785 27x132

When you specify these types of log modes, the user must select a terminal size that matches your DLOGMOD specification.

An example of a set of terminal LU definitions for the terminal side of the VTAM session is *h7q*. SEQASAMP (EQAWTRML). See the log mode definitions in the *IBM Communications Server SNA Resource Definition Reference* for further information about log modes. The MODETAB log mode table load module that contains the DLOGMOD default log mode specification must be available to VTAM via the VTAMLIB DD statement.

You need to VARY on these new terminal LU definitions, similar to the way it was done in [“Activating the VTAM EQAMVnnn APPLs” on page 175](#).

### Terminal LU state requirements

When z/OS Debugger accesses the terminal LU, the terminal LU must be in the following state:

- It must be known to the z/OS Communications Server on the system which z/OS Debugger runs.
- It must be marked secondary logical unit (SLU) enabled.
- It must not be in session with any application.

You can determine whether a particular terminal LU meets these criteria by using the DISPLAY VTAM operator command:

1. Access the desired LU using your terminal emulator, and exit any session manager.
2. On your system console, enter the following command, where *name* is the LU name:

```
DISPLAY NET, ID=name, SCOPE=ALL
```

3. Inspect the output of the command for the following information:

- The IST486I message indicates STATUS=ACTIV and DESIRED STATE=ACTIV, and an IST172I NO SESSIONS EXIST message is displayed.

- The IST597I message indicates SLU ENABLED.
- The IST934I message indicates that a DLOGMOD was specified.

## Configuring the TN3270 Telnet Server to access the terminal LUs

If you use the IBM Communications Server for z/OS TN3270 Telnet Server to manage your terminals, you must configure TN3270 Telnet Server to support terminals with the following characters:

- Terminal LUs that have a proper DLOGMOD specified must be accessed.
- The LUMAP KEEPOPEN statement needs to be specified, so that VTAM allocates the ACB for the terminal LU when a terminal emulator session is connected to it, rather than only when an application is started.
- The terminal LU name must be available to the user of the terminal emulator session.

One way to enable this support is to set up a new TN3270 telnet port. The following instructions guide you through setting up a new port and the changes you must make to the PROFILE.TCPIP data set. The examples in [“Configuring the TN3270 Telnet Server” on page 179](#) show several variations of this support.

1. Select an unused port, such as 2023. If you have a firewall installed, ensure that this port is allowed through the firewall.
2. Do one of the following steps:
  - If you are running the TN3270 Telnet Server in a separate address space (optional on z/OS Communications Server Version 1.6 through 1.8, required on Version 1.9 or later), specify a `PORT num TCP jobname NOAUTOLOG` statement to reserve the new port for the TN3270 Telnet Server.
  - If you are running the TN3270 Telnet Server in the TCP/IP address space, specify a `PORT num TCP INTCLIEN` statement to reserve the new port for the TN3270 Telnet Server.
3. Create a new set of TELNETPARMS and BEGINVTAM blocks for the new port by copying the existing TELNETPARMS and BEGINVTAM blocks for port 23.
4. Customize the new TELNETPARMS and BEGINVTAM blocks to use this new port number. Ensure that the previous TELNETPARMS and BEGINVTAM blocks also specify a port number (typically 23).
5. Make the following changes to your new BEGINVTAM block:
  - a. If you intend to use this new port for only z/OS Debugger in full-screen mode using a dedicated terminal, you can remove all the statements from the BEGINVTAM block that you created in step 3, except the PORT statement. Go to step 5c.
  - b. Remove any copied DEFAULTLUS, DEFAULTLUSSPEC, DEFAULTAPPL and LUMAP statements.
  - c. Specify a new LUGROUP specification that indicates which terminal LUs that will be used as dedicated terminals for debugging in full-screen mode using a dedicated terminal. These terminal LUs must have a DLOGMOD specification in their APPL definition statement.
  - d. Specify some client\_identification statements (such as HNGROUP and IPGROUP).
  - e. Specify a new LUMAP statement with KEEPOPEN (along with the proper LU group operand and client\_identification operand).
 

The KEEPOPEN operand forces the TN3270 Telnet Server to keep the access control block (ACB) for the LU open at all times (for those LUs affected by this LUMAP statement). With the ACB open, z/OS Debugger can acquire the LU if the LU is connected to a client terminal emulator session but is not in session.
  - f. Specify a new ALLOWAPPL EQAMV\* statement (or ALLOWAPPL \* if site policies allow it) in the BEGINVTAM block to let z/OS Debugger start a session with the terminal LU.
 

If you defined the name that z/OS Debugger uses for its side of the VTAM session with a name other than EQAMVnnn, then you should specify that name on the ALLOWAPPL statement, rather than EQAMVnnn. (Or just use \* if your site policies allow it.)
  - g. Specify whether the terminal is to display a session manager panel, a USSMSG10 panel, or a Telnet Solicitor Logon panel.

The user must know what terminal LU they have acquired when they connect their terminal emulator session to this new port. If you normally use a session manager that displays the terminal LU, then you can continue to use that method. Otherwise, use one of the following panels:

- A modified USSMSG10 panel that displays the terminal LU name
- The Telnet Solicitor Logon panel, if the terminal emulator itself shows the terminal LU name

To specify which panel is to be displayed, do the following steps:

- To display a session manager panel, specify the `FIRSTONLY` operand on a `DEFAULTAPPL` statement that defines the session manager to run. To use the LU to debug a program in full-screen mode using a dedicated terminal, the user must first exit the session manager panel and return to the Telnet Solicitor Logon panel.
- To display a USSMSG10 panel, specify a `USSTCP` statement. If your terminal emulator session supports the TN3270E protocol, the USSMSG10 panel can be customized to display the terminal LU name. See the *IBM Communication Server IP Configuration Reference* manual for information about how to create a new USS table load module that contains a USSMSG10 panel which includes the `@@LUNAME` parameter.
- To display a Telnet Solicitor Logon panel, code no additional statements.

If you want to restrict access for a terminal connected to this new port so that no one can use it to start any application and that no application other than z/OS Debugger can acquire it, then do the following steps:

1. Remove any statements from the port's `BEGINVTAM` block other than those recommended above.
2. Write only one `ALLOWAPPL` statement, specifying `EQAMVnnn` or, if you didn't use `EQAMVnnn`, the minor node name that z/OS Debugger uses for its side of the VTAM session.
3. Use the USSMSG10 panel or Telnet Solicitor Logon Panel display method.

After you make these changes to the TCP/IP configuration data set, you must instruct TCP/IP to use this updated definition and start the new port. The Telnet server uses the `VARY` command to change Telnet functions. One of the following commands can help you change Telnet functions:

#### **VARY TCPIP, ,OBEYFILE**

To start, restart or change a port by updating the Telnet profile. If you are running a TN3270 Telnet Server in a separate address space, you need to include the TN3270 Telnet Server *jobname* in the command. For example, `VARY TCPIP, ,jobname, OBEYFILE`.

#### **VARY TCPIP, ,TELNET, STOP and VARY TCPIP, ,OBEYFILE**

To stop a Telnet port, and then restart that port or a new port without stopping the TCP/IP stack.

See *IBM Communication Server IP Configuration Reference* for more information about the `VARY TCPIP` command.

After making these changes, your users can set up a unique terminal emulator session that connects to this new port, and debug programs that require the use of full-screen mode using a dedicated terminal.

## **Example: Activating full-screen mode using a dedicated terminal when using TCP/IP TN3270 Telnet Server**

---

The examples below describe how to define the z/OS Debugger minor node names, define the terminal LUs for use by z/OS Debugger, and three ways to define Telnet ports that the TN3270 Telnet server can use.

After you code these definitions, you need activate these changes by using the `VARY NET` and `VARY TCPIP` commands as described previously.

## Defining z/OS Debugger to VTAM

These are the z/OS Debugger minor node names defined to VTAM through VTAMLST:

```
EQAAPPL VBUILD TYPE=APPL
EQAMV001 APPL AUTH=(PASS,ACQ),PARSESS=NO
EQAMV002 APPL AUTH=(PASS,ACQ),PARSESS=NO
EQAMV003 APPL AUTH=(PASS,ACQ),PARSESS=NO
EQAMV004 APPL AUTH=(PASS,ACQ),PARSESS=NO
EQAMV005 APPL AUTH=(PASS,ACQ),PARSESS=NO
...
EQAMV050 APPL AUTH=(PASS,ACQ),PARSESS=NO
```

See *hlq*.SEQASAMP (EQAWAPPL) for a sample of these definitions.

## Defining the terminals used by z/OS Debugger

These are the terminal LUs defined to VTAM through VTAMLST:

```
EQATRML VBUILD TYPE=APPL
TRMLU001 APPL AUTH=NVPACE,EAS=1,PARSESS=NO,MODETAB=ISTINCLM, *
 SESSLIM=YES,DLOGMOD=D4C32XX3
TRMLU002 APPL AUTH=NVPACE,EAS=1,PARSESS=NO,MODETAB=ISTINCLM, *
 SESSLIM=YES,DLOGMOD=D4C32XX3
TRMLU003 APPL AUTH=NVPACE,EAS=1,PARSESS=NO,MODETAB=ISTINCLM, *
 SESSLIM=YES,DLOGMOD=D4C32XX3
TRMLU004 APPL AUTH=NVPACE,EAS=1,PARSESS=NO,MODETAB=ISTINCLM, *
 SESSLIM=YES,DLOGMOD=D4C32XX3
TRMLU005 APPL AUTH=NVPACE,EAS=1,PARSESS=NO,MODETAB=ISTINCLM, *
 SESSLIM=YES,DLOGMOD=D4C32XX3
...
TRMLU050 APPL AUTH=NVPACE,EAS=1,PARSESS=NO,MODETAB=ISTINCLM, *
 SESSLIM=YES,DLOGMOD=D4C32XX3
```

See *hlq*.SEQASAMP (EQAWTRML) for a sample of these definitions.

Note that the DLOGMOD operand is specified. Change the TRMLU $nnn$  names on the terminal LU APPL definition statements to names that meet your site convention for terminal LU names. These names must match the entries in the LUGROUP statements in the BEGINVTAM blocks shown in [“Example 1” on page 179](#), [“Example 2” on page 180](#), and [“Example 3” on page 180](#).

## Configuring the TN3270 Telnet Server

The examples below highlight the changes made to the TCP/IP TN3270 server's configuration file.

### Example 1

The example defines a new port (2023). When a user connects a terminal emulator session to this port, the Netview Access Services (NVAS) menu appears when the LU is created. The user copies the LU name that appears on the NVAS screen and specifies it as the value for the MFI%LU\_name suboption of the TEST run-time option. After the user copies the LU name, the user exits NVAS and returns to the Telnet Solicitor Logon panel to make the terminal LU available to z/OS Debugger.

Each change is highlighted with a number in **reverse highlighting**. This number corresponds to the step number in the list of instructions in [“Configuring the TN3270 Telnet Server to access the terminal LUs” on page 177](#).

```
PORT
...
2 2023 TCP jobname NOAUTOLOG ; Telnet Server - z/OS Debugger
...
;
; Define Telnet pool for z/OS Debugger
;
TELNETPARMS
4 PORT 2023
... the rest of this should be a copy of port 23
```

```

ENDTELNETPARMS

BEGINVTAM
4 PORT 2023

LUGROUP DBGTOOL
5c TRMLU001..TRMLU050
ENDLUGROUP

IPGROUP EVERYONE
5d 0.0.0.0:0.0.0.0
ENDIPGROUP

5g1 DEFAULTAPPL NVAS FIRSTONLY
5e LUMAP DBGTOOL EVERYONE KEEPOPEN
5f ALLOWAPPL EQAMV*
ENDVTAM

```

See `hlq.SEQASAMP(EQAWTTS1)` for a sample of these definitions.

## Example 2

The example defines a new port (2023). When a user connects a terminal emulator session to this port, a USSMSG10 panel is displayed. The USSTCP statement is coded to point to a customized USSMSG10 panel that you defined that displays the LU name. The user copies this LU name and assigns it to the `MFI%LU_name` suboption of the TEST runtime option. When the USSMSG10 panel is displayed, the terminal LU is available to z/OS Debugger.

Each change is highlighted with a number in **reverse highlighting**. This number corresponds to the step number in the list of instructions in [“Configuring the TN3270 Telnet Server to access the terminal LUs” on page 177](#).

```

PORT
2 ... 2023 TCP jobname NOAUTOLOG ; Telnet Server - z/OS Debugger
...

;
; Define Telnet pool for z/OS Debugger
;
TELNETPARMS
4 PORT 2023
... the rest of this should be a copy of port 23
ENDTELNETPARMS

BEGINVTAM
4 PORT 2023

LUGROUP DBGTOOL
5c TRMLU001..TRMLU050
ENDLUGROUP

IPGROUP EVERYONE
5d 0.0.0.0:0.0.0.0
ENDIPGROUP

5g2 USSTCP USS$EQAW EVERYONE
5e LUMAP DBGTOOL EVERYONE KEEPOPEN
5f ALLOWAPPL EQAMV*
ENDVTAM

```

See `hlq.SEQASAMP(EQAWTTS2)` for a sample of these definitions.

## Example 3

The example defines a new port (2023). When the user connects a terminal emulator session to this port, the Telnet Solicitor Logon panel is displayed, and the terminal LU is available to z/OS Debugger. The user copies the LU name from the terminal emulator session's information area and assigns it to the `MFI%LU_name` suboption of the TEST runtime option.



Each change is highlighted with a number in **reverse highlighting**. This number corresponds to the step number in the list of instructions in [“Configuring the TN3270 Telnet Server to access the terminal LUs” on page 177](#).

```
PORT
 2 2023 TCP jobname NOAUTOLOG ; Telnet Server - z/OS Debugger
 ...
;
; Define Telnet pool for z/OS Debugger
;
TELNETPARMS
 4 PORT 2023
 ... the rest of this should be a copy of port 23
ENDTELNETPARMS

BEGINVTAM
 4 PORT 2023

LUGROUP DBGTOOL
 5c TRMLU001..TRMLU050
 ENDLUGROUP

IPGROUP EVERYONE
 5d 0.0.0.0:0.0.0.0
 ENDIPGROUP

 5e LUMAP DBGTOOL EVERYONE KEEPOPEN
 5f ALLOWAPPL EQAMV*
ENDVTAM
```

See *hlq*.SEQASAMP (EQAWTTS3) for a sample of these definitions.

## Verifying the customization of the facility to debug full-screen mode using a dedicated terminal

Connect a terminal emulator session to one of the terminal LUs setup as described previously in this chapter. Issue the DISPLAY command from your system console as shown in [“Terminal LU state requirements” on page 176](#). Verify that the output of the DISPLAY command is correct. If the output of the DISPLAY command is not correct, you must review every step in [“Enabling full-screen mode using a dedicated terminal” on page 174](#) and verify that you completed each step correctly. Then run one of the install verification jobs described below.

To help you verify the installation of the facility to debug full-screen mode using a dedicated terminal, the *hlq*.SEQASAMP data set contains the following installation verification program (IVP) jobs:

- EQAWIVP5 (COBOL)
- EQAWIVP6 (C)
- EQAWIVP7 (PL/I)
- EQAWIVP9 (Enterprise PL/I)
- EQAWIVPB (Language Environment assembler)
- EQAWIVPD (non-Language Environment assembler)
- EQAWIVPW (OS/VS COBOL)
- EQAWIVPY (non-Language Environment VS COBOL II)

Before you run a sample, customize it for your installation as described in the sample.

# Using z/OS Debugger Terminal Interface Manager as a dedicated terminal

---

The z/OS Debugger Terminal Interface Manager enables a user to debug in full-screen mode using a dedicated terminal without having to know the LU name of the dedicated terminal. Use the z/OS Debugger Terminal Interface Manager because it makes it easier for users to identify the terminals to use for their debugging sessions.

Complete the steps in “[Enabling full-screen mode using a dedicated terminal](#)” on page 174 before you do the instructions in this section to ensure that the basic full-screen mode using a dedicated terminal function works at your site.

## Example: a debugging session using the z/OS Debugger Terminal Interface Manager

Compare the following steps with the steps shown in “[How z/OS Debugger uses full-screen mode using a dedicated terminal](#)” on page 173 to understand how using the Terminal Interface Manager affects the flow of work.

1. Start two terminal emulator sessions. These sessions can be either of the following situations:

- Two separate terminal emulator sessions.
- If you use IBM Session Manager, two sessions selected from the IBM Session Manager menu.

In either situation, ensure that the second session connects to a terminal that can handle a full-screen mode debugging session through a dedicated terminal and that starts z/OS Debugger Terminal Interface Manager.

2. On the first terminal emulator session, log on to TSO.

3. On the second terminal emulator session, provide your login credentials to the Terminal Interface Manager and press Enter. The login credentials can be your TSO user ID and password, PassTicket, password phrase, or MFA token.

### Notes:

- a. You are not logging on TSO. You are indicating that you want your user ID associated with this terminal LU.
- b. When the number of characters entered into the password field, including blanks, exceeds 8, the input is passed to the security system as a password phrase.
- c. To use PassTickets with Terminal Interface Manager, define the PTKTDATA profile by following the rules for MVS batch jobs. For more information, see [Defining profiles in the PTKTDATA class](#) in the z/OS documentation.

A panel similar to the following panel is then displayed on the second terminal emulator session:

z/OS Debugger TERMINAL INTERFACE MANAGER

```
EQAY001I Terminal TRMLU001 connected for user USER1
EQAY001I Ready for z/OS Debugger
```

```
PF12=LOGOFF PF3=EXIT PF10=Edit LE options data set
```

The terminal is now ready to receive a z/OS Debugger full-screen mode using a dedicated terminal session.

4. Edit the PARM string of your batch job so that you specify the TEST runtime parameter as follows:

```
TEST(,,VTAM%userid:*)
```

5. Submit the batch job.

The tasks completed are similar to the tasks described in step “5” on page 173 except that first the batch job communicates with the Terminal Interface Manager to correlate the user ID to the terminal LU of the second terminal emulator session. The remaining steps are the same as described in step “5” on page 173.

6. On the second terminal emulator session, a full-screen mode debugging session is displayed. Interact with it the same way you would with any other full-screen mode debugging session.
7. After you exit z/OS Debugger, the second terminal emulator session displays the panel and messages you saw in step “3” on page 182. This indicates that z/OS Debugger can use this session again. (this will happen each time you exit from z/OS Debugger).
8. If you want to start another debugging session, return to step “5” on page 183. If you are finished debugging, you can do one of the following tasks:
  - Close the second terminal emulator session.
  - Exit the Terminal Interface Manager by choosing one of the following options:
    - Press PF12 to display the Terminal Interface Manager logon panel. You can log in with the same ID or a different user ID.
    - Press PF3 to exit the Terminal Interface Manager.

## Enabling full-screen mode using a dedicated terminal with z/OS Debugger Terminal Interface Manager

To enable full-screen mode using a dedicated terminal with z/OS Debugger Terminal Interface Manager, do the following steps:

1. Define the VTAM APPL definition statements as described in [“Defining the Terminal Interface Manager APPL definition statements” on page 184](#).
2. Start the z/OS Debugger Terminal Interface Manager as described in [“Starting the z/OS Debugger Terminal Interface Manager as a dedicated terminal” on page 184](#).

3. Configure the Telnet Server as described in [“Configuring the TN3270 Telnet Server to access the Terminal Interface Manager”](#) on page 185.
4. Verify that the customizations are completed correctly by following the steps in [“Verifying the customization of the Terminal Interface Manager”](#) on page 188.

## Defining the Terminal Interface Manager APPL definition statements

You must define the APPL definition statements that the Terminal Interface Manager will use for its sessions. To define the APPL definition statements, do the following steps:

1. Define the APPL definition statements as shown in the EQAWSESS member in the *hlq.SEQASAMP* data set by doing one of the following tasks:
  - Copy EQAWSESS into a new member:
    - a. Create a new member in the VTAM definitions library (VTAMLST). The VTAM definitions library is often stored in the data set SYS1.VTAMLST.
    - b. Copy the contents of the EQAWSESS member into the new member.
    - c. Add the new member's name to the VTAM start options configuration file, ATCCONxx.
  - Copy EQAWSESS into an existing member:
    - a. Select a member in the VTAM definitions library (VTAMLST) that contains the major node definitions.
    - b. Copy the APPL definition statements for z/OS Debugger from the EQAWSESS member into the selected member.

To activate the new definitions, enter the following command from the console:

```
VARY NET,ACT,ID=member-name
```

*member-name* is the member name in the VTAM definitions library.

## Starting the z/OS Debugger Terminal Interface Manager as a dedicated terminal

The z/OS Debugger Terminal Interface Manager is a VTAM application that must be started (following the start of VTAM itself) before users can access it. Follow these steps to start it:

1. Copy the EQAYSESM member of the data set *hlq.SEQASAMP* to the SYS1.PROCLIB data set, making any changes required by your installation.
2. Make sure that the z/OS Debugger Terminal Interface Manager load modules, EQAYSESM and EQAYTRMM, resides in an APF authorized library (this module can be found in the *hlq.SEQAAUTH* data set). This is required to allow access to functions to validate users by login credentials.
3. Start the z/OS Debugger Terminal Interface Manager using the START command from the console. The START command can be added to the COMMNDxx member of SYS1.PARMLIB to start the z/OS Debugger Terminal Interface Manager when the system is IPLed.

The z/OS Debugger Terminal Interface Manager load module accepts three parameters, which you can provide by using the OPTS substitution variable on the START command or in the EQAYSESM PROC definition. You can code the parameters in any sequence and all of them are optional. The following list describes the parameters:

### **-a *acbname***

Specifies an alternate VTAM ACB name for Terminal Interface Manager to open. For more information about this parameter, see [“Running the Terminal Interface Manager on more than one LPAR on the same VTAM network”](#) on page 186.

### **-s**

Instructs Terminal Interface Manager to supply an additional entry field on each Terminal Interface Manager panel, in which the user can enter an IBM Session Manager escape sequence. For more

information about this parameter, see [“Configuring Terminal Interface Manager as an IBM Session Manager application”](#) on page 187.

**+T**

Turns on internal tracing for Terminal Interface Manager. Do not use this parameter unless instructed by IBM support personnel.

The following example starts the z/OS Debugger Terminal Interface Manager for alternate ACB EQASESS2 and instructs it to provide an extra entry field for use with IBM Session Manager:

```
START EQAYSESM,OPTS='-a EQASESS2 -s'
```

## Configuring the TN3270 Telnet Server to access the Terminal Interface Manager

Select an additional unused port (for example, 2024) and then implement [“Example 1”](#) on page 179 with the following changes:

- Specify port 2024 instead of 2023 (3 times)
- Specify the following value for the DEFAULTAPPL statement:

```
DEFAULTAPPL EQASESSM FIRSTONLY
```

- Make the following change on the ALLOWAPPL statement:

```
ALLOWAPPL EQA*
```

### Example 4

The example below shows the modified [“Example 1”](#) on page 179, with the changes highlighted with an asterisk (\*).

```
PORT
...
* 2024 TCP jobname NOAUTOLOG ; Telnet Server - z/OS Debugger
...

; Add a TELNETPARMS block for the new port

TELNETPARMS
* PORT 2024 ; z/OS Debugger
... the rest of this should be a copy of the existing Port 23
ENDTELNETPARMS

; Add a BEGINVTAM block for the new port

BEGINVTAM
* PORT 2024

; Define the VTAM terminal LUs to use for this port (see EQAWTRML)

LUGROUP DBGTOOL
 TRMLU001..TRMLU050
ENDLUGROUP

; Allow anyone with access to this system to use the LUs above

IPGROUP EVERYONE
 0.0.0.0:0.0.0.0
ENDIPGROUP

; The z/OS Debugger Terminal Interface
Manager will be displayed
; when an emulator connects

* DEFAULTAPPL EQASESSM FIRSTONLY

; Indicate that the ACBs always be allocated

LUMAP DBGTOOL EVERYONE KEEPOPEN

; Allow only z/OS Debugger to use this port
```

```
* ALLOWAPPL EQA*
```

```
ENDVTAM
```

See `hlq.SEQASAMP (EQAWTTS4)` for a sample of these definitions.

Instruct TCP/IP to use this additional definition, as described on page [“Configuring the TN3270 Telnet Server to access the terminal LUs”](#) on page 177.

After you make these changes, your users can set up a unique terminal emulator session that connects to this new port, and debug programs that require the use of full-screen mode using a dedicated terminal with the z/OS Debugger Terminal Interface Manager. The user does the following steps:

1. Starts a terminal emulator session that connects to this new port. The z/OS Debugger Terminal Interface Manager is displayed.
2. The user enters his user ID and password and then presses Enter. The terminal is now ready to receive a z/OS Debugger full-screen mode using a dedicated terminal session.
3. On another terminal emulator session, the user starts his program with the TEST run-time option and specifies the VTAM%*userid* suboption. The terminal emulator session connected to this new port displays a full-screen mode using a dedicated terminal session.

## Example: Connecting a VTAM network with multiple LPARs with one Terminal Interface Manager

This example describes the connections that need to be made in a VTAM network that has four LPARs that run z/OS Debugger jobs with one of the LPARs managing the terminals.

- LPAR 1 runs a TN3270E server and the Terminal Interface Manager with the default ACB name. Its VTAM also owns all the terminal LUs. Users connect their TN3270E emulator to this LPAR for the Terminal Interface Manager session. Users use the Terminal Interface Manager to create the connection between z/OS Debugger and the terminal LU used for their full-screen mode using a dedicated terminal debugging session.
- VTAM on LPAR1 defines the terminal LU APPL definition statements and the EQASESSM APPL definition statement for the Terminal Interface Manager.
- VTAM on LPAR 1 needs visibility to the EQAMVnnn APPL definition statements on LPARs 2, 3 and 4. This enables communication between the Terminal Interface Manager and z/OS Debugger.
- Each VTAM on LPAR 1, 2, 3 and 4 has a unique set of EQAMVnnn APPL definition statements. For example, LPAR 1 has APPL definition statements 001-050, LPAR 2 has APPL definition statements 051-100, LPAR 3 has APPL definition statements 101-150, and LPAR 4 has APPL definition statements 151-200.
- Each VTAM on LPAR 2, 3 and 4 needs visibility to the EQASESSM APPL definition statement on LPAR 1. This enables communication between z/OS Debugger and the Terminal Interface Manager.
- Each VTAM on LPAR 2, 3 and 4 needs visibility to the terminal LU APPL definition statements on LPAR 1.

## Running the Terminal Interface Manager on more than one LPAR on the same VTAM network

This topic describes the modifications you need to make to the steps described in [“Defining the Terminal Interface Manager APPL definition statements”](#) on page 184, [“Starting the z/OS Debugger Terminal Interface Manager as a dedicated terminal”](#) on page 184, and [“Configuring the TN3270 Telnet Server to access the Terminal Interface Manager”](#) on page 185 in order to make full-screen mode using a dedicated terminal with Terminal Interface Manager work in an environment where you want to run the Terminal Interface Manager on more than one LPAR in the same VTAM network.

Do the following steps for each additional instance of the Terminal Interface Manager:

1. In “[Defining the Terminal Interface Manager APPL definition statements](#)” on page 184, after you have copied EQAWSESS into a new or existing member, modify it so that you specify an ACB name other than the default EQASESSM.

By default, z/OS Debugger assumes you work in an environment where you use only one instance of Terminal Interface Manager and the default ACB name used by this instance of Terminal Interface Manager and z/OS Debugger is EQASESSM. By specifying the ACB name used by the Terminal Interface Manager (instead of using the default name), you can create a unique ACB name for each instance of the Terminal Interface Manager.

2. In “[Starting the z/OS Debugger Terminal Interface Manager as a dedicated terminal](#)” on page 184, after you copy the EQAYSESM member to the SYS1.PROCLIB data set, modify it to specify the new ACB name you created in step “1” on page 187 by specifying OPTS= ' -a XXXXXXXX ', where XXXXXXXX is the new ACB name.
3. In “[Configuring the TN3270 Telnet Server to access the Terminal Interface Manager](#)” on page 185, when you modify the TCP/IP TN3270 server's configuration file, modify the DEFAULTAPPL statement to specify the ACB name you created in step “1” on page 187, instead of EQASESSM.
4. Specify the EQAOPTS TIMACB command, as described in “[TIMACB](#)” on page 169, using the new ACB name you created in step “1” on page 187 for *ACB-name*.

## Configuring Terminal Interface Manager as an IBM Session Manager application

To define z/OS Debugger Terminal Interface Manager as an application within IBM Session Manager, do the following steps:

1. Define a TN3270 port and a group of terminal LUs which start Terminal Interface Manager as described in “[Configuring the TN3270 Telnet Server to access the Terminal Interface Manager](#)” on page 185.
2. Enable the IBM Session Manager TCP/IP support, as described in *IBM Session Manager for z/OS: Installation and Getting Started*.
3. Define Terminal Interface Manager to IBM Session Manager as a TCP/IP application. To do this, create an APPL statement in the IBM Session Manager configuration, similar to the following statement:

```
APPL applname APPLID TCP_1
 DESC 'description'
 DATA 'protocol://host-addr:port'
```

The following list describes the variables used in this statement:

### **applname**

Your choice for the application name. This is the name used when referring to the application in other IBM Session Manager definitions.

### **description**

The descriptive text you want displayed on any session menus.

### **protocol**

One of the following values: TELNET, TN3270 or TN3270E. For a description of these protocols, see “Session Manager and TCP/IP” in *IBM Session Manager: Facilities Reference*.

### **host-addr**

The hostname or IP address of the server that hosts Terminal Interface Manager.

### **port**

The port number that was configured for Terminal Interface Manager in step “1” on page 187.

For a complete description of the IBM Session Manager APPL configuration statement, see *IBM Session Manager: Technical Reference*.

The following example shows an APPL statement:

```
APPL DTTIM
 APPLID TCP_1
```

```
DESC 'z/OS Debugger Terminal Interface
Manager'
DATA 'TN3270E://mvsa.ibm.com:2024'
```

4. Start the Terminal Interface Manager started task with the `-s` parameter. This causes the Terminal Interface Manager panels to display an extra field where you can enter the IBM Session Manager escape key.

## Verifying the customization of the Terminal Interface Manager

Do the following steps to verify the installation and customization:

1. Start a terminal emulator session that starts the Terminal Interface Manager. Enter your user ID and password and then press Enter.
2. On your other terminal emulator session, select the same IVP as you used above, change the run time parameter string from `MFI%VTAM_LU_id:*` to `VTAM%userid:*`, submit the job and then follow the rest of the instructions in the IVP.
3. On your other terminal emulator session, select the same IVP as you used above, change the runtime parameter string from `MFI%LU_name:*` to `VTAM%userid:*`, submit the job and then follow the rest of the instructions in the IVP.



---

## Appendix C. Applying maintenance

Support resources and problem solving information describes all the resources available to obtain technical support information. Follow the steps in this section to apply a service APAR or PTF.

### Applying Service APAR or PTF

---

This chapter describes how to apply service updates to z/OS Debugger. To use the maintenance procedures effectively, you must install the product or products by using SMP/E before doing the maintenance procedures below.

#### What you receive

If you report a problem with z/OS Debugger to your IBM Support Center, you may receive a tape containing one or more Authorized Program Analysis Reports (APARs) or Program Temporary Fixes (PTFs) that were created to solve your problem.

You may also receive a list of prerequisite APARs or PTFs, which you must apply to your system before applying the current APAR. These prerequisite APARs or PTFs might relate to z/OS Debugger or any other licensed product you have installed, including z/OS.

#### Checklist for applying an APAR or PTF

The following checklist describes the steps and associated SMP/E commands to install the APAR or PTF:

1. Prepare to install the APAR or PTF.
2. Receive the APAR or PTF. (SMP/E RECEIVE)
3. Review the HOLDDATA.
4. Accept previously applied APARs or PTFs (optional). (SMP/E ACCEPT)
5. Apply APAR or PTF. (SMP/E APPLY)
6. Run REPORT CROSSZONE and apply any missing requisites.
7. Test APAR or PTF.
8. Accept APAR or PTF. (SMP/E ACCEPT)

#### Step 1. Prepare to install APAR or PTF

Before you start to install an APAR or PTF, do the following:

1. Create a backup copy of the current z/OS Debugger libraries. Save this copy of z/OS Debugger until you have completed installing the APAR or PTF, and you are confident that the service runs correctly.
2. Research each service tape through the IBM Support Center for any errors or additional information. Note all errors on the tape that were reported by APARs or PTFs and apply the relevant fixes. You should also review the current Preventive Service Planning (PSP) information.

#### Step 2. Receive the APAR or PTF

Receive the service using the SMP/E RECEIVE command from either the SMP/E dialogs in ISPF, or using a batch job similar to EQAWRECV in *hlq*.SEQASAMP.

#### Step 3. Review the HOLDDATA

Review the HOLDDATA summary reports for the APAR or PTF. Follow any instructions described in the summary reports.

#### **Step 4. Accept previously applied APAR or PTF (optional)**

If there is any APAR or PTF which you applied earlier but did not accept, and the earlier APAR or PTF is not causing problems in your installation, accept the applied service from either the SMP/E dialogs in ISPF, or using a batch job similar to EQAWACPT in *hlq*.SEQASAMP.

Accepting the earlier service allows you to use the SMP/E RESTORE command to return to your current level if you encounter a problem with the service you are currently applying. You can do this either from the SMP/E dialogs in ISPF, or using a batch job.

#### **Step 5. Apply the APAR or PTF**

We recommend you first use the SMP/E APPLY command with the CHECK operand. Check the output; if it shows no conflict, rerun the APPLY command without the CHECK operand. This can be done from the SMP/E dialogs in ISPF or using a batch job similar to EQAWAPLY in *hlq*.SEQASAMP.

#### **Step 6. Run REPORT CROSSZONE and apply any missing requisites**

Run an SMP/E REPORT CROSSZONE by using the SMP/E dialogs or by using a batch job similar to EQAWRPXZ in *hlq*.SEQASAMP. Apply any missing requisites found by SMP/E.

#### **Step 7. Test the APAR or PTF**

Thoroughly test your updated z/OS Debugger. Do not accept an APAR or PTF until you are confident that it runs correctly.

#### **Step 8. Accept the APAR or PTF**

We recommend you first use the SMP/E ACCEPT command with the CHECK operand. Check the output; if it shows no conflict, rerun the ACCEPT command without the CHECK operand. You can do this either from the SMP/E dialogs in ISPF, or using a batch job similar to EQAWACPT in *hlq*.SEQASAMP.

---

## Appendix D. Support resources and problem solving information

This section shows you how to quickly locate information to help answer your questions and solve your problems. If you have to call IBM support, this section provides information that you need to provide to the IBM service representative to help diagnose and resolve the problem.

- [“Searching knowledge bases” on page 191](#)
- [“Getting fixes” on page 192](#)
- [“Subscribing to support updates” on page 192](#)
- [“Contacting IBM Support” on page 193](#)

---

### Searching knowledge bases

You can search the available knowledge bases to determine whether your problem was already encountered and is already documented.

- [“Searching IBM Knowledge Center” on page 191](#)
- [“Searching product support documents” on page 191](#)

### Searching IBM Knowledge Center

You can find this publication and documentation for many other products in IBM Knowledge Center at <https://www.ibm.com/support/knowledgecenter>.

### Searching product support documents

If you need to look beyond the information center to answer your question or resolve your problem, you can use one or more of the following approaches:

- Find the content that you need by using the IBM Support Portal at [www.ibm.com/software/support](http://www.ibm.com/software/support) or directly at [www.ibm.com/support/entry/portal](http://www.ibm.com/support/entry/portal).

The IBM Support Portal is a unified, centralized view of all technical support tools and information for all IBM systems, software, and services. The IBM Support Portal lets you access the IBM electronic support portfolio from one place. You can tailor the pages to focus on the information and resources that you need for problem prevention and faster problem resolution.

Access a specific IBM Software Support site:

- [Application Performance Analyzer for z/OS Support](#)
  - [z/OS Debugger support](#)
  - [Enterprise COBOL for z/OS Support](#)
  - [Enterprise PL/I for z/OS Support](#)
  - [Fault Analyzer for z/OS Support](#)
  - [File Export for z/OS Support](#)
  - [File Manager for z/OS Support](#)
  - [WebSphere Studio Asset Analyzer for Multiplatforms Support](#)
  - [Workload Simulator for z/OS and OS/390 Support](#)
- Search for content by using the IBM masthead search. You can use the IBM masthead search by typing your search string into the Search field at the top of any [ibm.com](http://www.ibm.com)® page.

- Search for content by using any external search engine, such as Google, Yahoo, or Bing. If you use an external search engine, your results are more likely to include information that is outside the ibm.com domain. However, sometimes you can find useful problem-solving information about IBM products in newsgroups, forums, and blogs that are not on ibm.com. Include "IBM" and the name of the product in your search if you are looking for information about an IBM product.
- The IBM Support Assistant (also referred to as ISA) is a free local software serviceability workbench that helps you resolve questions and problems with IBM software products. It provides quick access to support-related information. You can use the IBM Support Assistant to help you in the following ways:
  - Search through IBM and non-IBM knowledge and information sources across multiple IBM products to answer a question or solve a problem.
  - Find additional information through product and support pages, customer news groups and forums, skills and training resources and information about troubleshooting and commonly asked questions.

In addition, you can use the built in Updater facility in IBM Support Assistant to obtain IBM Support Assistant upgrades and new features to add support for additional software products and capabilities as they become available.

General information about the IBM Support Assistant can be found on the IBM Support Assistant home page at <http://www.ibm.com/software/support/isa>.

## Getting fixes

---

A product fix might be available to resolve your problem. To determine what fixes and other updates are available, select a link from the following list:

- [Latest PTFs for Application Performance Analyzer for z/OS](#)
- [Latest PTFs for Fault Analyzer for z/OS](#)
- [Latest PTFs for File Manager for z/OS](#)
- [Latest PTFs for z/OS Debugger](#)
- [Latest PTFs for IBM Developer for z/OS Enterprise Edition](#)
- [Latest PTFs for ADFz Common Components](#)

When you find a fix that you are interested in, click the name of the fix to read its description and to optionally download the fix.

Subscribe to receive e-mail notifications about fixes and other IBM Support information as described in [Subscribing to Support updates](#).

## Subscribing to support updates

---

To stay informed of important information about the IBM products that you use, you can subscribe to updates. By subscribing to receive updates, you can receive important technical information and updates for specific Support tools and resources. You can subscribe to updates by using the following:

- [RSS feeds and social media subscriptions](#)
- [My Notifications](#)

### RSS feeds and social media subscriptions

For general information about RSS, including steps for getting started and a list of RSS-enabled IBM web pages, visit the IBM Software Support RSS feeds site at <http://www.ibm.com/software/support/rss/other/index.html>. For information about the RSS feed for the IBM System z<sup>®</sup> Enterprise Development Tools & Compilers information center, refer to the [Subscribe to information center updates](#) topic in the information center at <https://www.ibm.com/support/knowledgecenter>.

## My Notifications

With My Notifications, you can subscribe to Support updates for any IBM product. You can specify that you want to receive daily or weekly email announcements. You can specify what type of information you want to receive (such as publications, hints and tips, product flashes (also known as alerts), downloads, and drivers). My Notifications enables you to customize and categorize the products about which you want to be informed and the delivery methods that best suit your needs.

To subscribe to Support updates, follow the steps below.

1. Click [My notifications](#) to get started. Click **Subscribe now!** on the page.
2. Sign in My notifications with your IBM ID. If you do not have an IBM ID, create one ID by following the instructions.
3. After you sign in My notifications, enter the name of the product that you want to subscribe in the **Product lookup** field. The look-ahead feature lists products matching what you typed. If the product does not appear, use the **Browse for a product** link.
4. Next to the product, click the **Subscribe** link. A green check mark is shown to indicate the subscription is created. The subscription is listed under Product subscriptions.
5. To indicate the type of notices for which you want to receive notifications, click the **Edit** link. To save your changes, click the **Submit** at the bottom of the page.
6. To indicate the frequency and format of the email message you receive, click **Delivery preferences**. Then, click **Submit**.
7. Optionally, you can click the RSS/Atom feed by clicking **Links**. Then, copy and paste the link into your feeder.
8. To see any notifications that were sent to you, click **View**.

## Contacting IBM Support

---

IBM Support provides assistance with product defects, answering FAQs, and performing rediscovery.

After trying to find your answer or solution by using other self-help options such as technotes, you can contact IBM Support. Before contacting IBM Support, your company must have an active IBM maintenance contract, and you must be authorized to submit problems to IBM. For information about the types of available support, see the information below or refer to the Support portfolio topic in the Software Support Handbook at <http://www14.software.ibm.com/webapp/set2/sas/f/handbook/offerings.html>.

- For IBM distributed software products (including, but not limited to, Tivoli®, Lotus®, and Rational products, as well as Db2 and WebSphere products that run on Windows, or UNIX operating systems), enroll in Passport Advantage® in one of the following ways:

### Online

Go to the Passport Advantage Web site at <https://www-01.ibm.com/software/passportadvantage/> and click **How to Enroll**.

### By phone

For the phone number to call in your country, go to the Contacts page of the *IBM Software Support Handbook on the Web* at <http://www14.software.ibm.com/webapp/set2/sas/f/handbook/contacts.html> and click the name of your geographic region.

- For customers with Subscription and Support (S & S) contracts, go to the Software Service Request Web site at <http://www.ibm.com/support/servicerequest>.
- For IBM eServer™ software products (including, but not limited to, Db2 and WebSphere products that run in zSeries, pSeries, and iSeries environments), you can purchase a software maintenance agreement by working directly with an IBM sales representative or an IBM Business Partner. For more information about support for eServer software products, go to the IBM Technical Support Advantage Web site at <http://www.ibm.com/servers/eserver/techsupport.html>.

If you are not sure what type of software maintenance contract you need, call 1-800-IBMSERV (1-800-426-7378) in the United States. From other countries, go to the Contacts page of the *IBM Software Support Handbook on the Web* at <http://www14.software.ibm.com/webapp/set2/sas/f/handbook/contacts.html> and click the name of your geographic region for phone numbers of people who provide support for your location.

Complete the following steps to contact IBM Support with a problem:

1. [“Define the problem and determine the severity of the problem” on page 194](#)
2. [“Gather diagnostic information” on page 194](#)
3. [“Submit the problem to IBM Support” on page 195](#)

To contact IBM Software support, follow these steps:

## Define the problem and determine the severity of the problem

Define the problem and determine severity of the problem When describing a problem to IBM, be as specific as possible. Include all relevant background information so that IBM Support can help you solve the problem efficiently.

IBM Support needs you to supply a severity level. Therefore, you need to understand and assess the business impact of the problem that you are reporting. Use the following criteria:

### Severity 1

The problem has a **critical** business impact. You are unable to use the program, resulting in a critical impact on operations. This condition requires an immediate solution.

### Severity 2

The problem has a **significant** business impact. The program is usable, but it is severely limited.

### Severity 3

The problem has **some** business impact. The program is usable, but less significant features (not critical to operations) are unavailable.

### Severity 4

The problem has **minimal** business impact. The problem causes little impact on operations, or a reasonable circumvention to the problem was implemented.

For more information, see the Getting IBM support topic in the Software Support Handbook at <http://www14.software.ibm.com/webapp/set2/sas/f/handbook/getsupport.html>.

## Gather diagnostic information

To save time, if there is a Mustgather document available for the product, refer to the Mustgather document and gather the information specified. Mustgather documents contain specific instructions for submitting your problem to IBM and gathering information needed by the IBM support team to resolve your problem. To determine if there is a Mustgather document for this product, go to the product support page and search on the term Mustgather. At the time of this publication, the following Mustgather documents are available:

- Mustgather: Read first for problems encountered with Application Performance Analyzer for z/OS: <http://www-01.ibm.com/support/docview.wss?uid=swg21265542>
- Mustgather: Read first for problems encountered with z/OS Debugger: <http://www-01.ibm.com/support/docview.wss?uid=swg21254711>
- Mustgather: Read first for problems encountered with Fault Analyzer for z/OS: <http://www-01.ibm.com/support/docview.wss?uid=swg21255056>
- Mustgather: Read first for problems encountered with File Manager for z/OS: <http://www-01.ibm.com/support/docview.wss?uid=swg21255514>
- Mustgather: Read first for problems encountered with Enterprise COBOL for z/OS: <http://www-01.ibm.com/support/docview.wss?uid=swg21249990>

- Mustgather: Read first for problems encountered with Enterprise PL/I for z/OS: <http://www-01.ibm.com/support/docview.wss?uid=swg21260496>

If the product does not have a Mustgather document, please provide answers to the following questions:

- What software versions were you running when the problem occurred?
- Do you have logs, traces, and messages that are related to the problem symptoms? IBM Software Support is likely to ask for this information.
- Can you re-create the problem? If so, what steps were performed to re-create the problem?
- Did you make any changes to the system? For example, did you make changes to the hardware, operating system, networking software, and so on.
- Are you currently using a workaround for the problem? If so, be prepared to explain the workaround when you report the problem.

## Submit the problem to IBM Support

You can submit your problem to IBM Support in one of three ways:

### Online using the IBM Support Portal

Click **Service request** on the IBM Software Support site at <http://www.ibm.com/software/support>. On the right side of the Service request page, expand the Product related links section. Click Software support (general) and select ServiceLink/IBMLink to open an Electronic Technical Response (ETR). Enter your information into the appropriate problem submission form.

### Online using the Service Request tool

The Service Request tool can be found at <http://www.ibm.com/software/support/servicerequest>.

### By phone

Call 1-800-IBMSERV (1-800-426-7378) in the United States or, from other countries, go to the Contacts page of the *IBM Software Support Handbook* at <http://www14.software.ibm.com/webapp/set2/sas/f/handbook/contacts.html> and click the name of your geographic region.

If the problem you submit is for a software defect or for missing or inaccurate documentation, IBM Support creates an Authorized Program Analysis Report (APAR). The APAR describes the problem in detail. Whenever possible, IBM Support provides a workaround that you can implement until the APAR is resolved and a fix is delivered. IBM publishes resolved APARs on the IBM Support website daily, so that other users who experience the same problem can benefit from the same resolution.

After a Problem Management Record (PMR) is open, you can submit diagnostic MustGather data to IBM using one of the following methods:

- FTP diagnostic data to IBM. For more information, refer to <http://www-01.ibm.com/support/docview.wss?uid=swg21154524>.
- If FTP is not possible, e-mail diagnostic data to [techsupport@mainz.ibm.com](mailto:techsupport@mainz.ibm.com). You must add PMR xxxxx bbb ccc in the subject line of your e-mail. xxxxx is your PMR number, bbb is your branch office, and ccc is your IBM country code. Go to <http://itcenter.mainz.de.ibm.com/ecurep/mail/subject.html> for more details.

Always update your PMR to indicate that data has been sent. You can update your PMR online or by phone as described above.





---

## Appendix E. Accessibility

Accessibility features help a user who has a physical disability, such as restricted mobility or limited vision, to use software products successfully. The accessibility features in z/OS provide accessibility for z/OS Debugger.

The major accessibility features in z/OS enable users to:

- Use assistive technology products such as screen readers and screen magnifier software
- Operate specific or equivalent features by using only the keyboard
- Customize display attributes such as color, contrast, and font size

The *IBM System z Enterprise Development Tools & Compilers* Information Center, and its related publications, are accessibility-enabled. The accessibility features of the information center are described at <https://www.ibm.com/support/knowledgecenter>.

---

### Using assistive technologies

Assistive technology products work with the user interfaces that are found in z/OS. For specific guidance information, consult the documentation for the assistive technology product that you use to access z/OS interfaces.

---

### Keyboard navigation of the user interface

Users can access z/OS user interfaces by using TSO/E or ISPF. Refer to *z/OS TSO/E Primer*, *z/OS TSO/E User's Guide*, and *z/OS ISPF User's Guide Volume 1* for information about accessing TSO/E and ISPF interfaces. These guides describe how to use TSO/E and ISPF, including the use of keyboard shortcuts or function keys (PF keys). Each guide includes the default settings for the PF keys and explains how to modify their functions.

---

### Accessibility of this document

Information in the following format of this document is accessible to visually impaired individuals who use a screen reader:

- HTML format when viewed from the *IBM System z Enterprise Development Tools & Compilers* Information Center

Syntax diagrams start with the word Format or the word Fragments. Each diagram is preceded by two images. For the first image, the screen reader will say "Read syntax diagram". The associated link leads to an accessible text diagram. When you return to the document at the second image, the screen reader will say "Skip visual syntax diagram" and has a link to skip around the visible diagram.



## Notices

---

This information was developed for products and services offered in the U.S.A. IBM might not offer the products, services, or features discussed in this document in other countries. Consult your local IBM representative for information on the products and services currently available in your area. Any reference to an IBM product, program, or service is not intended to state or imply that only that IBM product, program, or service may be used. Any functionally equivalent product, program, or service that does not infringe any IBM intellectual property right may be used instead. However, it is the user's responsibility to evaluate and verify the operation of any non-IBM product, program, or service.

IBM may have patents or pending patent applications covering subject matter in this document. The furnishing of this document does not give you any license to these patents. You can send license inquiries, in writing, to:

IBM Corporation  
J46A/G4  
555 Bailey Avenue  
San Jose, CA 95141-1003  
U.S.A.

For license inquiries regarding double-byte (DBCS) information, contact the IBM Intellectual Property Department in your country or send inquiries, in writing, to:

Intellectual Property Licensing  
Legal and Intellectual Property Law  
IBM Japan, Ltd.  
3-2-12, Roppongi, Minato-ku, Tokyo 106-8711

The following paragraph does not apply to the United Kingdom or any other country where such provisions are inconsistent with the local law:

INTERNATIONAL BUSINESS MACHINES CORPORATION PROVIDES THIS PUBLICATION "AS IS" WITHOUT WARRANTY OF ANY KIND, EITHER EXPRESS OR IMPLIED, INCLUDING, BUT NOT LIMITED TO, THE IMPLIED WARRANTIES OF NON-INFRINGEMENT, MERCHANTABILITY OR FITNESS FOR A PARTICULAR PURPOSE.

Some states do not allow disclaimer of express or implied warranties in certain transactions; therefore, this statement might not apply to you.

This information could include technical inaccuracies or typographical errors. Changes are periodically made to the information herein; these changes will be incorporated in new editions of the publication. IBM may make improvements and/or changes in the product(s) and/or the program(s) described in this publication at any time without notice.

## Trademarks and service marks

---

IBM, the IBM logo, and [ibm.com](http://ibm.com) are trademarks of International Business Machines Corp., registered in many jurisdictions worldwide. Other product and service names might be trademarks of IBM or other companies. A current list of IBM trademarks is available on the Web at "Copyright and trademark information" at [www.ibm.com/legal/copytrade.shtml](http://www.ibm.com/legal/copytrade.shtml).

Java and all Java-based trademarks and logos are trademarks of Oracle and/or its affiliates.

Linux® is a registered trademark of Linus Torvalds in the United States, other countries, or both.

Microsoft, Windows, Windows NT, and the Windows logo are trademarks of Microsoft Corporation in the United States, other countries, or both.

UNIX is a registered trademark of The Open Group in the United States and other countries.

MasterCraft is a trademark of Tata Consultancy Services Ltd.



# Glossary

---

This glossary defines technical terms and abbreviations used in *IBM z/OS Debugger Customization Guide* documentation. If you do not find the term you are looking for, refer to the *IBM Glossary of Computing Terms*, located at the IBM Terminology web site:

<http://www.ibm.com/ibm/terminology>

## B

### **batch**

Pertaining to a predefined series of actions performed with little or no interaction between the user and the system. Contrast with *interactive*.

### **batch job**

A job submitted for batch processing. See *batch*. Contrast with *interactive*.

## C

### **CADP**

A CICS-supplied transaction used for managing debugging profiles from a 3270 terminal.

### **compile**

To translate a program written in a high level language into a machine-language program.

### **compile unit**

A sequence of HLL statements that make a portion of a program complete enough to compile correctly. Each HLL product has different rules for what comprises a compile unit.

### **compiler**

A program that translates instructions written in a high level programming language into machine language.

## D

### **data set**

The major unit of data storage and retrieval, consisting of a collection of data in one of several prescribed arrangements and described by control information to which the system has access.

### **debug**

To detect, diagnose, and eliminate errors in programs.

### **DTCN**

z/OS Debugger Control utility, a CICS transaction that enables the user to identify which CICS programs to debug.

### **debugging profile**

Data that specifies a set of application programs which are to be debugged together.

## E

### **eXtra Performance LINKage (XPLINK)**

A new call linkage between functions that has the potential for a significant performance increase when used in an environment of frequent calls between small functions. XPLINK makes subroutine calls more efficient by removing nonessential instructions from the main path. When all functions are compiled with the XPLINK option, pointers can be used without restriction, which makes it easier to port new applications to z/OS.

## F

### **full-screen mode**

An interface mode for use with a nonprogrammable terminal that displays a variety of information about the program you are debugging.

## H

### **hook**

An instruction inserted into a program by a compiler when you specify the TEST compile option. Using a hook, you can set breakpoints to instruct z/OS Debugger to gain control of the program at selected points during its execution.

## I

### **index**

A computer storage position or register, the contents of which identify a particular element in a table.

## L

### **link-edit**

To create a loadable computer program using a linkage editor.

### **load module**

A program in a form suitable for loading into main storage for execution. In this document this term is also used to refer to a Dynamic Load Library (DLL).

### **logical window**

A group of related debugging information (for example, variables) that is formatted so that it can be displayed in a physical window.

## LU

See [logical unit](#).

### **logical unit**

A type of network accessible unit that enables users to gain access to network resources and communicate with each other.

A name used by VTAM to identify a terminal or other resource.

## M

### **minor node**

In VTAM, a uniquely defined resource within a major node.

### **multitasking**

A mode of operation that provides for concurrent performance, or interleaved execution of two or more tasks.

## N

### **network identifier**

In TCP/IP, that part of the IP address that defines a network. The length of the network ID depends on the type of network class (A, B, or C).

### **node name**

The name assigned to a node during network definition. The format for the node name is *netid.cpname*.

## O

### **offset**

The number of measuring units from an arbitrary starting point to some other point.

## P

### **parameter**

Data passed between programs or procedures.

### **partitioned data set (PDS)**

A data set in direct access storage that is divided into partitions, called members, each of which can contain a program, part of a program, or data.

### **PDS**

See *partitioned data set*.

### **physical window**

A section of the screen dedicated to the display of one of the four logical windows: Monitor window, Source window, Log window, or Memory window.

### **PLU**

See *primary logical unit*.

### **primary logical unit**

In SNA, the logical unit that contains the primary half-session for a particular logical unit-to-logical unit (LU-to-LU) session.

In SNA, the logical unit (LU) that sends the BIND to activate a session with its partner LU.

### **profile**

A group of customizable settings that govern how the user's session appears and operates.

### **program**

A sequence of instructions suitable for processing by a computer. Processing can include the use of an assembler, a compiler, an interpreter, or a translator to prepare the program for execution, as well as to execute it.

## S

### **secondary logical unit**

In SNA, the logical unit (LU) that contains the secondary half-session for a particular LU-LU session. An LU may contain secondary and primary half-sessions for different active LU-LU sessions.

A VTAM Secondary Logical Unit (i.e., terminal).

### **session**

The events that take place between the time the user starts an application and the time the user exits the application.

### **SIMLOGON**

A VTAM macro instruction that initiates a session in which the application program acts as the PLU.

### **Single Point of Control**

The control interface that sends commands to one or more members of an IMSplex and receives command responses.

### **SLU**

See [secondary logical unit](#).

### **SPOC**

See [Single Point of Control](#).

### **statement**

An instruction in a program or procedure.

In programming languages, a language construct that represents a step in a sequence of actions or a set of declarations.

## U

### **utility**

A computer program in general support of computer processes; for example, a diagnostic program, a trace program, or a sort program.

## V

### VTAM

See [Virtual Telecommunications Access Method](#).

### Virtual Telecommunications Access Method (VTAM)

IBM software that controls communication and the flow of data in an SNA network by providing the SNA application programming interfaces and SNA networking functions. An SNA network includes subarea networking, Advanced Peer-to-Peer Networking (APPN), and High-Performance Routing (HPR). Beginning with Release 5 of the OS/390 operating system, the VTAM for MVS/ESA function was included in Communications Server for OS/390; this function is called Communications Server for OS/390 - SNA Services.

An access method commonly used by MVS to communicate with terminals and other communications devices.

## X

### XPLINK

See [eXtra Performance LINKage \(XPLINK\)](#).



# Bibliography

---

## IBM z/OS Debugger publications

---

Using CODE/370 with VS COBOL II and OS PL/I, SC09-1862

### IBM z/OS Debugger

You can access the IBM z/OS Debugger publications by visiting the following library pages:

- IBM Debug for z/OS library page: <http://www-01.ibm.com/support/docview.wss?uid=swg27050482>
- IBM Developer for z/OS library page: <http://www.ibm.com/support/docview.wss?uid=swg27048563>

*IBM z/OS Debugger User's Guide*, SC27-9580

*IBM z/OS Debugger Reference and Messages*, SC27-9582

*IBM z/OS Debugger Reference Summary*, SC27-9581

*IBM z/OS Debugger API User's Guide and Reference*, SC27-9584

*IBM z/OS Debugger Customization Guide*, SC27-9583

*Program Directory for IBM z/OS Debugger*, GI13-4540

*COBOL and CICS Command Level Conversion Aid for OS/390 & MVS & VM: User's Guide*, SC26-9400

*Program Directory for IBM COBOL and CICS Command Level Conversion Aid for OS/390 & MVS & VM*, GI10-5080

*Japanese Program Directory for IBM COBOL and CICS Command Level Conversion Aid for OS/390 & MVS & VM*, GI10-6976

*Program Directory for IBM Application Delivery Foundation for z/OS Common Components*, GI10-8969

*IBM Application Delivery Foundation for z/OS Common Components Customization Guide and User Guide*, SC27-9050

## High level language publications

---

### z/OS C and C++

*Compiler and Run-Time Migration Guide*, GC09-4913

*Curses*, SA22-7820

*Language Reference*, SC09-4815

*Programming Guide*, SC09-4765

*Run-Time Library Reference*, SA22-7821

*User's Guide*, SC09-4767

### Enterprise COBOL for z/OS, Version 6

*Customization Guide*, SC27-8712

*Language Reference*, SC27-8713

*Programming Guide*, SC27-8714

*Migration Guide*, GC27-8715

*Program directory*, GI11-9180

*Licensed Program Specifications*, GI13-4532

### Enterprise COBOL for z/OS, Version 5

*Customization Guide*, SC14-7380

*Language Reference*, SC14-7381

*Programming Guide*, SC14-7382  
*Migration Guide*, GC14-7383  
*Program directory*, GI11-9180  
*Licensed Program Specifications*, GI11-9181

### **Enterprise COBOL for z/OS, Version 4**

*Compiler and Runtime Migration Guide*, GC23-8527  
*Customization Guide*, SC23-8526  
*Licensed Program Specifications*, GI11-7871  
*Language Reference*, SC23-8528  
*Programming Guide*, SC23-8529

### **Enterprise COBOL for z/OS and OS/390, Version 3**

*Migration Guide*, GC27-1409  
*Customization*, GC27-1410  
*Licensed Program Specifications*, GC27-1411  
*Language Reference*, SC27-1408  
*Programming Guide*, SC27-1412

### **COBOL for OS/390 & VM**

*Compiler and Run-Time Migration Guide*, GC26-4764  
*Customization under OS/390*, GC26-9045  
*Language Reference*, SC26-9046  
*Programming Guide*, SC26-9049

### **Enterprise PL/I for z/OS, Version 5**

*Language Reference*, SC27-8940  
*Licensed Program Specifications*, GC27-4621  
*Messages and Codes*, GC27-8950  
*Compiler and Run-Time Migration Guide*, GC27-8930  
*Programming Guide*, GI13-4536

### **Enterprise PL/I for z/OS, Version 4**

*Language Reference*, SC14-7285  
*Licensed Program Specifications*, GC14-7283  
*Messages and Codes*, GC14-7286  
*Compiler and Run-Time Migration Guide*, GC14-7284  
*Programming Guide*, GI11-9145

### **Enterprise PL/I for z/OS and OS/390, Version 3**

*Diagnosis*, SC27-1459  
*Language Reference*, SC27-1460  
*Licensed Program Specifications*, GC27-1456  
*Messages and Codes*, SC27-1461  
*Migration Guide*, GC27-1458  
*Programming Guide*, SC27-1457

## **VisualAge PL/I for OS/390**

*Compiler and Run-Time Migration Guide*, SC26-9474  
*Diagnosis Guide*, SC26-9475  
*Language Reference*, SC26-9476  
*Licensed Program Specifications*, GC26-9471  
*Messages and Codes*, SC26-9478  
*Programming Guide*, SC26-9473

## **PL/I for MVS & PM**

*Compile-Time Messages and Codes*, SC26-3229  
*Compiler and Run-Time Migration Guide*, SC26-3118  
*Diagnosis Guide*, SC26-3149  
*Installation and Customization under MVS*, SC26-3119  
*Language Reference*, SC26-3114  
*Licensed Program Specifications*, GC26-3116  
*Programming Guide*, SC26-3113  
*Reference summary*, SX26-3821

## **Related publications**

---

### **CICS**

*Application Programming Guide*, SC34-6231  
*Application Programming Primer*, SC34-0674  
*Application Programming Reference*, SC34-6232

### **DB2 Universal Database for z/OS**

*Administration Guide*, SC18-7413  
*Application Programming and SQL Guide*, SC18-7415  
*Command Reference*, SC18-7416  
*Data Sharing: Planning and Administration*, SC18-7417  
*Installation Guide*, GC18-7418  
*Messages and Codes*, GC18-7422  
*Reference for Remote RDRA\* Requesters and Servers*, SC18-7424  
*Release Planning Guide*, SC18-7425  
*SQL Reference*, SC18-7426  
*Utility Guide and Reference*, SC18-7427

### **IMS**

*IMS Application Programming: Database Manager*, SC27-1286  
*IMS Application Programming: EXEC DLI Commands for CICS & IMS*, SC27-1288  
*IMS Application Programming: Transaction Manager*, SC27-1289

### **TSO/E**

*Command Reference*, SA22-7782  
*Programming Guide*, SA22-7788  
*System Programming Command Reference*, SA22-7793  
*User's Guide*, SA22-7794

## **z/OS**

*MVS JCL Reference, SA22-7597*  
*MVS JCL User's Guide, SA22-7598*  
*MVS System commands, SA22-7627*

## **z/OS Language Environment**

*Concepts Guide, SA22-7567*  
*Customization, SA22-7564*  
*Debugging Guide, GA22-7560*  
*Programming Guide, SA22-7561*  
*Programming Reference, SA22-7562*  
*Run-Time Migration Guide, GA22-7565*  
*Vendor Interfaces, SA22-7568*  
*Writing Interlanguage Communication Applications, SA22-7563*

# Index

## Special Characters

[./E, BTS Environment command](#) [62](#)  
[&PGMNAME](#) [61](#)  
[&USERID](#) [61](#)

## A

accessing  
    another language by using NATLANG [70](#)  
activating  
    SVCs without using a system IPL [9](#)  
    z/OS Debugger definitions to VTAM [20](#),  
    [175](#)  
Address space count [41](#)  
ALLOWAPPL EQAMV\*  
    specifying, statement [177](#)  
AOR example [103](#)  
AOR example, application does not use terminal [105](#)  
APPL definition statements [19](#), [174](#)  
assembler, definition of [xv](#)  
assigning  
    values to NATLANG, LOCALE, and LINECOUNT [129](#)  
AT-TLS configuration, PROFILE.TCPIP [32](#)  
AT-TLS policy [33](#)  
AT-TLS policy activation [37](#)  
AT-TLS security updates [35](#)  
AT-TLS setup [31](#)  
authentication, Debug Manager [37](#)  
authorizing  
    Dynamic Debug facility to access programs in protected  
    storage [11](#)

## B

browse mode  
    controlled by EQAOPTS [140](#), [141](#)  
    controlled by RACF [67](#)  
    setting up facility access [67](#)  
    setting up user access [68](#)  
BTS Environment command (./E), when to use [62](#)

## C

CCSID [144](#)  
CEEBXITA  
    description of how it works [61](#)  
CEEBXITA, comparing two methods of linking [64](#)  
CEEBXITA, specifying message display level in [63](#)  
CEEBXITA, specifying naming pattern in [62](#)  
CEEREACTAFTERQDBG command  
    syntax of EQAXOPT macro for [143](#)  
CEETEST [143](#)  
checklist [1](#)  
CICS  
    adding support for [91](#)

CICS (*continued*)  
    AOR example [103](#)  
    AOR example, application does not use terminal [105](#)  
    CSD [91](#)  
    DFHRPL [91](#)  
    EQAOCPLT [94](#)  
    EQACCSO [91](#)  
    EQACDCT [91](#)  
    INITPARM [94](#)  
    IVPs [102](#)  
    JCL, updating [91](#)  
    SEQAMOD [91](#)  
    SEQAMOD must be APF-authorized [15](#)  
    Terminal to TOR then routes to AOR example, with CADP  
    [104](#)  
    Terminal to TOR then routes to AOR example, with DTCN  
    [104](#)  
    Terminal to TOR, application on AOR example [106](#)  
CICS translator  
    specifying a different [77](#)  
CICS, changes to make to [53](#)  
code pages  
    creating conversion images for [144](#)  
command  
    syntax diagrams [xvi](#)  
commands, Start (S) [43](#)  
commands, Stop (P) [45](#)  
COMMANDSDSN command  
    syntax of EQAXOPT macro for [141–143](#), [146](#)  
COMMNDxx, add started tasks [26](#)  
communication, External [39](#)  
communication, Internal [39](#)  
controlled libraries for RSE, Define MVS [29](#)  
copying  
    data sets to specified DD concatenation [70](#)  
CSD [91](#)  
customer support [193](#)  
customizing  
    Delay Debug Profile [83](#)  
    IBM z/OS Debugger Utilities [72](#)  
    IMS Transaction and User ID Cross Reference Table [83](#)  
    Non-CICS Debug Session Start and Stop Message  
    Viewer [84](#), [85](#)  
    Other IBM Application Delivery Foundation for z/OS  
    tools [74](#)  
    Program Preparation [76](#)  
    z/OS Debugger User Exit Data Set [80](#)

## D

data sets  
    copying into DD concatenation [70](#)  
Db2 precompiler  
    specifying a different [77](#)  
DBGMGR [27](#)  
DBGMGR, debug manager [30](#)  
debug manager [27](#), [30](#)

- Debug Manager authentication [37](#)
- Debug Manager logging [42](#)
- Debug Manager started tasks, Define [29](#)
- debug manager, DBGMGR [30](#)
- Debug Profile Service [48–52](#)
- Debug Tool DTCN and DTSP Profile Manager [53, 57](#)
- debugger, manager [30](#)
- DEFAULTVIEW command
  - syntax of EQAXOPT macro for [147](#)
- Define MVS program controlled libraries for RSE [29](#)
- Define RSE server as a secure z/OS UNIX [29](#)
- defining
  - DTCN transaction name [92](#)
  - names [19, 174](#)
  - TCP/IP terminals [177](#)
- defining Transient Data queues [91](#)
- DELETE, detecting [165](#)
- deleting debug profiles from VSAM or temporary storage queue [100](#)
- DFHLETRU [101](#)
- DLAYDBG command
  - description of [147](#)
  - syntax of EQAXOPT macro for [147](#)
- DLAYDBGDSN command
  - syntax of EQAXOPT macro for [148](#)
- DLAYDBGTRC command
  - syntax of EQAXOPT macro for [149](#)
- DLOGMOD operand, specifying [176](#)
- documents, licensed [xiii](#)
- DSALIM [94](#)
- DTCX transaction [95](#)
- Dynamic Debug
  - accessing programs in unprotected storage [11](#)

## E

- editing
  - EQAZPROC to add other procedure libraries [72](#)
- EDSALIM [94](#)
- Enterprise PL/I, definition of [xv](#)
- EQA00SVC
  - checking level of [10](#)
  - description of [9](#)
- EQA01SVC
  - checking level of [10](#)
  - description of [9](#)
- EQA0CPLT
  - INITPARM
    - example [94](#)
    - parameters [94](#)
  - PLT, adding [94](#)
  - set up [94](#)
- EQA9974I [95](#)
- EQACCSO [91](#)
- EQACDCT [91](#)
- EQAD3CXT
  - comparing Db2 RUNOPTS to [61](#)
- EQADCDEL [100](#)
- EQADTCN2, where to define [96](#)
- EQADTOOL.BROWSE.CICS [67](#)
- EQADTOOL.BROWSE.MVS [67](#)
- EQADTOOL.DTCDDELETEALL [109](#)
- EQADTOOL.DTCIINACTALL [109](#)
- EQADTOOL.DTCNCHNGEANY [56](#)

- EQADTOOL.DTSTMODCICSK [108](#)
- EQADTOOL.DTSTMODUSERK [108](#)
- EQANCPLT [95](#)
- EQA\_OPTS, using to set global preferences [153](#)
- EQA\_OPTS, using to set SVC screening option [166](#)
- EQAPRFSU [49](#)
- EQARMTSU [45](#)
- EQASET
  - when to run [61](#)
- EQASTART
  - modifying, to customize data set names [71](#)
- EQAUEDAT [127](#)
- EQAWAPPL
  - modifying [19, 174](#)
- EQAYSESM PROC definition [21, 184](#)
- EQAZDFLT
  - example of, showing parameters to set [74, 76](#)
- EQAZDSYS [81](#)
- EQAZPCM [37](#)
- EQAZPROC [72](#)
- example
  - activating z/OS Debugger definitions to VTAM [178](#)
  - full-screen mode using a dedicated terminal [173](#)
  - full-screen mode using the Terminal Interface Manager [17](#)
  - JCL that generates conversion images [145](#)
  - VTAM in a sysplex environment [19, 175](#)
- External communication [39](#)

## F

- FEJCNFG [39](#)
- FIRSTONLY operand
  - specifying, to display a session manager panel [178](#)
- fixes, getting [192](#)
- full-screen mode using a dedicated terminal with z/OS Debugger Terminal Interface Manager,
  - overview of steps to enable [183](#)
- full-screen mode using a dedicated terminal,
  - overview of steps to enable [174](#)
- full-screen mode using a dedicated terminal, how users start [173](#)
- full-screen mode using the Terminal Interface Manager,
  - overview of steps to enable [19](#)

## G

- global preferences file [153](#)
- goals, setting in WLM [40](#)

## H

- HOSTPORTS [154](#)

## I

- IBM Knowledge Center, searching for problem resolution [191](#)
- IBM Support Assistant, searching for problem resolution [191](#)
- IGNOREODOLIMIT [154](#)
- IMS
  - adding support for [111](#)
  - program that do not run in Language Environment [113](#)

IMSIISOORIGPSB [155](#)

IMSpIex

configuring for [78](#), [79](#)

initial default data set names

LDD specifications file [161](#)

saved breakpoints file [161](#)

saved monitor values file [161](#)

saved settings file [161](#)

INITPARM

example [94](#)

NLE [94](#)

NWP [94](#)

STK [94](#)

installation verification programs

CICS [102](#)

Internal communication [39](#)

Internet

searching for problem resolution [191](#)

IPL

to install z/OS Debugger SVC

[9](#)

IVP

running for z/OS Debugger facility

[10](#)

IVPs [102](#)

## J

Japanese

adding data sets to DD concatenation [70](#)

Customizing z/OS Debugger [130](#)

data sets [71](#)

JES Job Monitor tracing [42](#)

## K

knowledge bases, searching for problem resolution [191](#)

Korean

data sets [71](#)

## L

Language Environment

user exit, link, into private copy of Language

Environment runtime module [65](#)

user exits, methods to modify sample assembler [62](#)

Language Environment user exit, create and manage data set used by [65](#)

Language Environment user exit, requirements for data set used by [65](#)

libraries for RSE , Define MVS [29](#)

licensed documents [xiii](#)

LINK, detecting [165](#)

LOAD, detecting [165](#)

log mode [176](#)

LOGDSN command

syntax of EQAXOPT macro for [155](#), [156](#)

logging, Debug Manager [42](#)

LPAR, multiple, with multiple Terminal Interface Manager (on same VTAM network) [186](#)

LPAR, multiple, with one Terminal Interface Manager [23](#), [186](#)

## M

managing debugging profiles [101](#)

message display level, how to specify, in Language Environment user exit [63](#)

MFI VTAM [17](#), [173](#)

Model Application Names [20](#), [175](#)

modifying

EQASTART [71](#)

EQAWAPPL [19](#), [174](#)

moving to new level of Language Environment [65](#)

multi-domain environment

modifying EQAWAPPL [19](#), [175](#)

multiple instances, Running [42](#)

multiple systems, customizing Preparation Utilities for [75](#), [78](#)

MULTIPROCESS

MULTIPROCESS CHILD [158](#)

MULTIPROCESS PARENT [158](#)

MULTIPROCESS PROMPT [158](#)

MVS program controlled libraries for RSE , Define [29](#)

## N

NAMES command

description of [159](#)

naming pattern, how to specify, in Language Environment user exit [63](#)

NATLANG [70](#)

NLE [94](#)

NWP [94](#)

## O

optimizing z/OS Debugger's performance [94](#)

order in which commands and preferences files are processed [153](#)

## P

parameters

setting, using EQAZDFLT example [74](#), [76](#)

specifying, for Db2 and CICS [77](#)

PARMLIB [48](#), [52](#)

performance

optimizing for CICS [94](#)

PL/I, definition of [xvi](#)

plug-ins [53](#), [57](#)

Policy Agent configuration [33](#)

Policy Agent started task [33](#)

port reservation, TCP/IP [39](#)

ports, TCP/IP [38](#)

preferences file, setting global [153](#)

PREFERENCEDSN command

syntax of EQAXOPT macro for [160](#)

preparing

to customize z/OS Debugger

[1](#)

problem determination

describing problems [194](#)

determining business impact [194](#)

submitting problems [195](#)

Process count [41](#)

PROCLIB [46](#), [49](#)

PROCLIB changes [27](#)  
PROFILE.TCPIP data set [177](#)  
PROFILE.TCPIP, AT-TLS configuration [32](#)  
PROGxx, APF authorizations [26](#)

## R

RACF profiles  
as option for BROWSE [141](#)  
Authorizing DTCD and DTCT transactions to delete or deactivate debug profiles [109](#)  
Authorizing DTST transaction to modify storage [108](#)  
browse mode [67](#)  
data sets that require READ authorization, Db2 stored procedures [89](#)  
reserve for CICS administrator [99](#)  
reserve for CICS administrators [100](#)  
remote debug mode [53](#), [57](#)  
Remote Debug Service [45–48](#)  
reservation, TCPIP port [39](#)  
resource usage, overview [41](#)  
resource usage, tuning [41](#)  
RSE , Define MVS program controlled libraries for [29](#)  
RSE daemon [39](#)  
RSE server [39](#)  
RSE, Define as a secure z/OS UNIX server [29](#)  
Running multiple instances [42](#)  
RUNOPTS (Db2)  
comparing EQAD3CXT to [61](#)

## S

SAVEBPDSN command  
syntax of EQAXOPT macro for [161](#)  
SAVESETDSN command  
syntax of EQAXOPT macro for [161](#)  
screen control mode [106](#)  
screening, setting SVC [165](#)  
secure communication [47](#), [51](#)  
secure z/OS UNIX server, Define RSE as a [29](#)  
security definitions [47](#)  
security settings and classes, Activate [28](#)  
security settings, verify [30](#)  
separate debug file, attributes to use for [94](#)  
separate terminal mode [106](#)  
SEQABMOD [13](#)  
SEQAEXEC  
modifying [71](#)  
SEQATLIB [70](#), [71](#), [74](#), [76](#)  
service, when you apply to Language Environment [65](#)  
session manager panel  
displaying [178](#)  
SESSIONTIMEOUT [163](#)  
SET DEFAULT VIEW command  
description of [147](#)  
setting global preferences file [153](#)  
setting goals, WLM [40](#)  
settings and classes, Activate security [28](#)  
SIT [101](#)  
Software Support  
contacting [193](#)  
describing problems [194](#)  
determining business impact [194](#)

Software Support (*continued*)  
receiving updates [192](#)  
submitting problems [195](#)  
Start (S) command [43](#)  
started task [47](#), [50](#)  
started task, Policy Agent [33](#)  
started tasks, Define for Debug Manager  
JMON started tasks [29](#)  
RSED started tasks [29](#)  
started tasks, verifying [30](#)  
starting  
IBM z/OS Debugger Utilities from an ISPF panel [72](#)  
STARTSTOPMSG [164](#)  
STK [94](#)  
Stop (P) command [45](#)  
SVC  
installing, without using a system IPL [9](#)  
setting screening option [165](#)  
SVC screening [165](#)  
syntax diagrams  
how to read [xvi](#)  
syslogd setup [32](#)  
sysplex  
modifying EQAWAPPL [19](#), [175](#)  
SYSPLEX  
z/OS Debugger  
[43](#)  
system initialization parameter  
DEBUGTOOL [101](#)

## T

TCP/IP  
defining terminals to TN3270 [177](#)  
VARY NET command [20](#), [175](#)  
VARY TCPIP command [178](#)  
TCP/IP port reservation [39](#)  
TCP/IP ports [38](#)  
TCP/IP ports, graphical representation [38](#)  
TCP/IP updates [27](#)  
TCP/IP, using with CICS [25](#)  
TCPIP DATASD [168](#)  
temporary storage queue  
setting up to share among CICS systems [96](#)  
Terminal Interface Manager  
as IBM Session Manager application [187](#)  
Configuring telnet server for [185](#)  
description of [182](#)  
example of use [182](#)  
how to start [21](#), [184](#)  
multiple LPARs on same VTAM network [186](#)  
multiple LPARs with one Terminal Interface Manager [23](#), [186](#)  
Verifying customization of [188](#)  
Terminal to TOR then routes to AOR example, with CADP [104](#)  
Terminal to TOR then routes to AOR example, with DTCN [104](#)  
Terminal to TOR, application on AOR example [106](#)  
terminology, z/OS Debugger [xiv](#)  
Thread count [41](#)  
TIM [187](#)  
TLS v1.2 considerations [34](#)  
TOR [104](#), [106](#)  
tracing, JES Job Monitor [42](#)



TSQ [100](#)  
tuning considerations [41](#)

## U

UNIX server, Define RSE as [29](#)  
USEQSAM [101](#)  
user exit  
    EQAUEDAT [127](#)  
    XEIIN [95](#)  
    XEIOUT [95](#)  
    XPCFTCH [95](#)  
    XPCHAIR [95](#)  
    XPCTA [95](#)  
USSMSG10 panel  
    displaying [178](#)

## V

Verify security settings [30](#)  
verifying  
    installation of z/OS Debugger SVCs  
        [10](#)  
Visual Studio Code [45](#)  
VS Code [45](#)  
VSAM  
    defining file locally to all CICS regions [98](#)  
    deleting or deactivating debug profiles [99](#)  
    migrating debug profiles from a previous release [96](#)  
    setting up to function-ship file operations to a FOR [97](#)  
    setting up to share among CICS systems [96](#)  
    setting up, to store DTCN profiles [96](#)  
VTAM  
    activating z/OS Debugger definitions to, example [178](#)  
    allowing users to debug using [17](#), [173](#)  
    DLOGMOD operand [176](#)  
    in a multi-domain environment [19](#), [175](#)  
    in a sysplex environment [19](#), [175](#)  
    LU characteristics [176](#)  
    verifying installation of the z/OS Debugger definitions to  
        [22](#), [181](#)  
VTAM definitions library [19](#), [174](#)  
VTAM minor node  
    defining for Terminal Interface Manager [184](#)  
    defining for the Terminal Interface Manager [20](#)  
VTAMLST [19](#), [174](#)

## Y

yb2\* parameters [81](#), [82](#)

## Z

z/OS Debugger  
    parameters  
        assigning values to [129](#)  
    SYSPLEX [43](#)  
    terminology [xiv](#)  
z/OS Debugger SVCs  
    Dynamic Debug Facility [9](#)  
z/OS UNIX server, Define RSE as [29](#)







Product Number: 5724-T07