

IBM XL C/C++ for AIX, V13.1.2



Language Reference

Version 13.1.2

IBM XL C/C++ for AIX, V13.1.2



Language Reference

Version 13.1.2

Note

Before using this information and the product it supports, read the information in "Notices" on page 529.

First edition

This edition applies to IBM XL C/C++ for AIX, V13.1.2 (Program 5765-J07; 5725-C72) and to all subsequent releases and modifications until otherwise indicated in new editions. Make sure you are using the correct edition for the level of the product.

© Copyright IBM Corporation 1998, 2015.

US Government Users Restricted Rights – Use, duplication or disclosure restricted by GSA ADP Schedule Contract with IBM Corp.

Contents

About this document ix

Who should read this document	ix
How to use this document	ix
How this document is organized	ix
Conventions	x
Related information	xiii
IBM XL C/C++ information	xiii
Standards and specifications.	xv
Other IBM information	xv
Other information	xv
Technical support	xvi
How to send your comments	xvi

Chapter 1. Language levels and language extensions 1

Chapter 2. Scope and linkage 5

Scope	6
Block/local scope.	6
Function scope	7
Function prototype scope	7
File/global scope	7
Examples of scope in C.	8
Class scope (C++ only)	8
Namespaces of identifiers	9
Name hiding (C++ only)	10
Program linkage	11
Internal linkage	11
External linkage	12
No linkage	12
Language linkage (C++ only)	13

Chapter 3. Lexical elements. 15

Tokens	15
Keywords	15
Identifiers	18
Literals	21
Punctuators and operators	37
Source program character set	38
Multibyte characters	39
Escape sequences	40
The Unicode standard	41
Digraph characters	42
Trigraph sequences	43
Comments.	43

Chapter 4. Data objects and declarations 47

Overview of data objects and declarations	47
Overview of data objects	47
Overview of data declarations and definitions	49
<code>_Static_assert</code> declaration (C11)	51
<code>static_assert</code> declaration (C++11)	52
Storage class specifiers.	54

The auto storage class specifier	55
The static storage class specifier	55
The extern storage class specifier	57
The mutable storage class specifier (C++ only).	58
The register storage class specifier	58
The <code>__thread</code> storage class specifier (IBM extension)	60
Type specifiers	61
Integral types.	62
Boolean types	63
Floating-point types	64
Character types	65
The void type	66
Vector types (IBM extension)	66
User-defined types	69
The auto type specifier (C++11).	89
The <code>decltype(<i>expression</i>)</code> type specifier (C++11).	90
The <code>constexpr</code> specifier (C++11).	96
Compatibility of arithmetic types (C only)	97
Type qualifiers	98
The <code>__align</code> type qualifier (IBM extension)	99
The <code>const</code> type qualifier	101
The <code>restrict</code> type qualifier	102
The <code>volatile</code> type qualifier	103
Type attributes (IBM extension)	104
The <code>aligned</code> type attribute	105
The <code>may_alias</code> type attribute	106
The <code>packed</code> type attribute	107
The <code>transparent_union</code> type attribute (C only)	107
The <code>visibility</code> type attribute.	108

Chapter 5. Declarators 111

Overview of declarators	111
Examples of declarators	113
Type names	113
Pointers	114
Pointer arithmetic	115
Type-based aliasing	116
Compatibility of pointers (C only)	117
Null pointers	118
Arrays.	120
Variable length arrays	122
Compatibility of arrays	123
References (C++ only)	123
Initializers	124
Initialization and storage classes	125
Designated initializers for aggregate types (C only)	126
Initialization of vectors (IBM extension)	128
Initialization of structures and unions	129
Initialization of enumerations	131
Initialization of pointers	132
Initialization of arrays	133
Initialization of references (C++ only)	135
Initialization of complex types (C11).	139

Variable attributes (IBM extension)	140
The aligned variable attribute	141
The mode variable attribute	142
The packed variable attribute	143
The tls_model attribute	143
The weak variable attribute.	144
The visibility variable attribute	144

Chapter 6. Type conversions 147

Arithmetic conversions and promotions	148
Integral conversions	148
Boolean conversions	148
Floating-point conversions	149
Usual arithmetic conversions	151
Integral and floating-point promotions	153
Lvalue-to-rvalue conversions	155
Pointer conversions	156
Conversion to void*	157
Reference conversions (C++ only)	158
Function argument conversions	158

Chapter 7. Expressions and operators 159

Lvalues and rvalues	159
Primary expressions	161
Names	162
Literals	162
Integer constant expressions	162
Identifier expressions (C++ only)	163
Parenthesized expressions ()	164
Generic selection (C11)	165
Scope resolution operator :: (C++ only)	166
Generalized constant expressions (C++11)	167
Function call expressions	167
Member expressions	168
Dot operator	168
Arrow operator ->	169
Unary expressions	169
Increment operator ++	170
Decrement operator --	170
Unary plus operator +	171
Unary minus operator -	171
Logical negation operator !	171
Bitwise negation operator ~	171
Address operator &	172
Indirection operator *	173
The typeid operator (C++ only)	174
The __alignof__ operator (IBM extension)	175
The sizeof operator	176
The typeof operator (IBM extension)	178
The __real__ and __imag__ operators (IBM extension)	179
The vec_step operator (IBM extension)	180
Binary expressions	180
Assignment operators	181
Multiplication operator *	183
Division operator /	183
Remainder operator %	183
Addition operator +	184
Subtraction operator -	184
Bitwise left and right shift operators << >>	185

Relational operators < > <= >=	185
Equality and inequality operators == !=	186
Bitwise AND operator &	187
Bitwise exclusive OR operator ^	188
Bitwise inclusive OR operator 	188
Logical AND operator &&	189
Logical OR operator 	189
Array subscripting operator []	190
Vector subscripting operator [] (IBM extension)	191
Comma operator ,	192
Pointer to member operators * ->* (C++ only)	193
Conditional expressions	194
Types in conditional C expressions (C only)	194
Types in conditional C++ expressions (C++ only)	195
Examples of conditional expressions	195
Cast expressions	196
Cast operator ().	196
The static_cast operator (C++ only)	199
The reinterpret_cast operator (C++ only)	200
The const_cast operator (C++ only)	202
The dynamic_cast operator (C++ only)	204
Compound literal expressions	206
new expressions (C++ only)	207
Placement syntax	208
Initialization of objects created with the new operator	209
Handling new allocation failure	210
delete expressions (C++ only)	211
throw expressions (C++ only)	212
Label value expressions (IBM extension)	212
Operator precedence and associativity	212
Reference collapsing (C++11)	216

Chapter 8. Statements 219

Labeled statements	219
Locally declared labels (IBM extension)	220
Labels as values (IBM extension)	220
Expression statements	221
Resolution of ambiguous statements (C++ only)	221
Block statements	222
Example of blocks	222
Statement expressions (IBM extension)	223
Selection statements	223
The if statement	223
The switch statement	225
Iteration statements	229
The while statement	229
The do statement	230
The for statement	231
Jump statements	233
The break statement	233
The continue statement	233
The return statement	235
The goto statement	236
Null statement	237
Inline assembly statements (IBM extension)	238
Supported and unsupported constructs	242
Restrictions on inline assembly statements	242
Examples of inline assembly statements	242

Chapter 9. Functions	247
Function declarations and definitions	247
Function declarations	247
Function definitions	248
Examples of function declarations	251
Examples of function definitions	252
Compatible functions (C only)	252
Multiple function declarations (C++ only)	253
Function storage class specifiers	254
The static storage class specifier	254
The extern storage class specifier	254
Function specifiers	255
The inline function specifier	256
The <code>_Noreturn</code> function specifier	260
Function return type specifiers	261
Function return values	262
Function declarators	262
Parameter declarations	263
Trailing return type (C++11)	266
Function attributes (IBM extension)	268
alias	270
always_inline	271
const	272
deprecated	272
format	272
format_arg	273
gnu_inline	274
malloc	275
noinline	276
noreturn	276
pure	276
used	277
weak	277
weakref	277
visibility	278
The <code>main()</code> function	279
Function calls	280
Pass by value	281
Pass by pointer	282
Pass by reference (C++ only)	283
Allocation and deallocation functions (C++ only)	284
Default arguments in C++ functions (C++ only)	285
Restrictions on default arguments (C++ only)	286
Evaluation of default arguments (C++ only)	287
Pointers to functions	287
Nested functions (C only) (IBM extension)	289
Constexpr functions (C++11)	289
Chapter 10. Namespaces (C++ only)	293
Defining namespaces	293
Declaring namespaces	293
Creating a namespace alias	293
Creating an alias for a nested namespace	294
Extending namespaces	294
Namespaces and overloading	295
Unnamed namespaces	295
Namespace member definitions	297
Namespaces and friends	297
The <code>using</code> directive	298
The <code>using</code> declaration and namespaces	298
Explicit access	299

Inline namespace definitions (C++11)	300
The visibility namespace attribute (IBM extension)	303

Chapter 11. Overloading (C++ only) 305

Overloading functions	305
Restrictions on overloaded functions	306
Overloading operators	307
Overloading unary operators	309
Overloading increment and decrement operators	310
Overloading binary operators	311
Overloading assignments	312
Overloading function calls	313
Overloading subscripting	314
Overloading class member access	315
Overload resolution	315
Implicit conversion sequences	317
Resolving addresses of overloaded functions	322

Chapter 12. Classes (C++ only). . . . 325

Declaring class types	325
Using class objects	326
Classes and structures	328
Scope of class names	329
Incomplete class declarations	330
Nested classes	330
Local classes	332
Local type names	333

Chapter 13. Class members and friends (C++ only) 335

Class member lists	335
Data members	336
Member functions	337
Inline member functions	337
Constant and volatile member functions	338
Virtual member functions	338
Special member functions	338
Member scope	339
Pointers to members	340
The <code>this</code> pointer	341
Static members	344
Using the class access operators with static members	344
Static data members	345
Static member functions	347
Member access	349
Friends	351
Friend scope	355
Friend access	357

Chapter 14. Inheritance (C++ only) 359

Derivation	361
Inherited member access	364
Protected members	364
Access control of base class members	365
The <code>using</code> declaration and class members	366
Overloading member functions from base and derived classes	367
Changing the access of a class member	369
Multiple inheritance	370

Virtual base classes	371
Multiple access	372
Ambiguous base classes	373
Virtual functions	377
Ambiguous virtual function calls	380
Virtual function access	382
Abstract classes.	382

Chapter 15. Special member functions (C++ only). 385

Overview of constructors and destructors	385
Constructors.	386
Default constructors	387
Delegating constructors (C++11)	387
Constexpr constructors (C++11)	389
Explicit initialization with constructors	391
Initialization of base classes and members	392
Constructor execution order for class objects	396
Destructors	398
Pseudo-destructors	400
User-defined conversions	401
Conversion constructors	402
Explicit conversion constructors	403
Conversion functions	404
Explicit conversion operators (C++11)	405
Copy constructors	406
Copy assignment operators.	408

Chapter 16. Templates (C++ only). 411

Template parameters	412
Type template parameters	412
Non-type template parameters	412
Template template parameters	413
Default arguments for template parameters	413
Naming template parameters as friends (C++11)	414
Template arguments	415
Template type arguments	415
Template non-type arguments	416
Template template arguments	418
Class templates.	419
Class template declarations and definitions	421
Static data members and templates	422
Member functions of class templates	422
Friends and templates	423
Function templates	424
Template argument deduction	426
Overloading function templates	432
Partial ordering of function templates	433
Template instantiation	433
Explicit instantiation	434
Implicit instantiation	437
Template specialization	438
Explicit specialization	438
Partial specialization	443
Variadic templates (C++11).	446
Name binding and dependent names	458
The typename keyword	459
The template keyword as qualifier	460

Chapter 17. Exception handling (C++ only) 463

try blocks	463
Nested try blocks	464
catch blocks	465
Function try block handlers	466
Arguments of catch blocks	470
Matching between exceptions thrown and caught.	470
Order of catching	471
throw expressions	472
Rethrowing an exception	472
Stack unwinding	474
Exception specifications	476
Special exception handling functions	479
The unexpected() function	479
The terminate() function.	480
The set_unexpected() and set_terminate() functions	481
Example using the exception handling functions	482

Chapter 18. Preprocessor directives 485

Macro definition directives	485
The #define directive	485
The #undef directive	490
The # operator	491
The ## operator	492
Standard predefined macro names	492
File inclusion directives	494
The #include directive	494
The #include_next directive (IBM extension)	495
Conditional compilation directives	496
The #if and #elif directives	497
The #ifdef directive	498
The #ifndef directive	499
The #else directive.	499
The #endif directive	499
Extension of #endif and #else (IBM extension)	499
Message generation directives	501
The #error directive	501
The #warning directive (IBM extension)	501
The #line directive.	502
Assertion directives (IBM extension).	503
Predefined assertions.	504
The null directive (#)	504
Pragma directives	504
The _Pragma preprocessing operator	505
Standard pragmas.	505
C99 preprocessor features adopted in C++11	506

Chapter 19. The IBM XL C language extensions 511

General IBM extensions	511
C11 compatibility	512
Extensions for GNU C compatibility.	512
Extensions for Unicode support	516
Extensions for vector processing support	516

Chapter 20. The IBM XL C++ language extensions	517
General IBM extensions	517
Extensions for C99 compatibility	518
Extensions for C11 compatibility	519
C++11 compatibility	519
Extensions for GNU C compatibility	521
Extensions for GNU C++ compatibility	525

Extensions for Unicode support	526
Extensions for vector processing support	526

Notices	529
Trademarks	531

Index	533
--------------	------------

About this document

This document describes the syntax, semantics, and IBM® XL C/C++ for AIX® implementation of the C and C++ programming languages. Although the XL C and XL C++ compilers conform to the specifications maintained by the ISO standards for the C and C++ programming languages, the compilers also incorporate many extensions to the core languages. These extensions have been implemented to enhance usability in specific operating environments, support compatibility with other compilers, and support new hardware capabilities. For example, many language constructs have been added for compatibility with the GNU Compiler Collection (GCC) to maximize portability between the two development environments.

Who should read this document

This document is a reference for users who already have experience on programming applications in C or C++. Users new to C or C++ can still use this document to find language and features unique to XL C/C++; however, this reference does not aim to teach programming concepts nor to promote specific programming practices.

How to use this document

Unless indicated otherwise, all of the text in this reference pertains to both C and C++ languages. Where there are differences between languages, these are indicated through qualifying text and other graphical elements (see below for the conventions used).

While this document covers both standard and implementation-specific features, it does not include the following topics:

- Standard C and C++ library functions and headers. For standard C++ library information, refer to the *Standard C++ Library Reference*. For information on the standard C library, refer to your AIX operating system information.
- Constructs for writing multi-threaded programs, including IBM SMP directives, OpenMP directives and functions, and POSIX Pthread functions. For reference information about IBM SMP and OpenMP constructs, see the *XL C/C++ Compiler Reference*; for information about Pthreads library functions, refer to your AIX information.
- Compiler pragmas, predefined macros, and built-in functions. These are described in the *XL C/C++ Compiler Reference*.

How this document is organized

This document is organized to loosely follow the structure of the ISO standard language specifications and topics are grouped into similar headings.

- Chapters 1 through 9 discuss language elements that are common to both C and C++, including lexical elements, data types, declarations, declarators, type conversions, expressions, operators, statements, and functions. Throughout these chapters, both standard features and extensions are discussed.
- Chapters 10 through 17 discuss standard C++ features exclusively, including namespaces, overloading, classes, inheritance, templates, and exception handling.

- Chapter 18 discusses directives to the preprocessor.
- Chapters 19 and 20 provide summary lists of all the extended features that are supported by each language.

Conventions

Typographical conventions

The following table shows the typographical conventions used in the IBM XL C/C++ for AIX, V13.1.2 information.

Table 1. *Typographical conventions*

Typeface	Indicates	Example
bold	Lowercase commands, executable names, compiler options, and directives.	The compiler provides basic invocation commands, <code>xlc</code> and <code>xlc</code> (<code>xlc++</code>), along with several other compiler invocation commands to support various C/C++ language levels and compilation environments.
<i>italics</i>	Parameters or variables whose actual names or values are to be supplied by the user. Italics are also used to introduce new terms.	Make sure that you update the <i>size</i> parameter if you return more than the <i>size</i> requested.
<u>underlining</u>	The default setting of a parameter of a compiler option or directive.	<code>nomaf</code> <u><code>maf</code></u>
monospace	Programming keywords and library functions, compiler builtins, examples of program code, command strings, or user-defined names.	To compile and optimize <code>myprogram.c</code> , enter: <code>xlc myprogram.c -03</code> .

Qualifying elements (icons)

Most features described in this information apply to both C and C++ languages. In descriptions of language elements where a feature is exclusive to one language, or where functionality differs between languages, this information uses icons to delineate segments of text as follows:

Table 2. *Qualifying elements*

















Qualifier/Icon	Meaning
C only begins  	The text describes a feature that is supported in the C language only; or describes behavior that is specific to the C language.
C only ends	
C++ only begins  	The text describes a feature that is supported in the C++ language only; or describes behavior that is specific to the C++ language.
C++ only ends	

Table 2. Qualifying elements (continued)

Qualifier/Icon	Meaning
IBM extension begins   IBM extension ends	The text describes a feature that is an IBM extension to the standard language specifications.
C11 begins   C11 ends	The text describes a feature that is introduced into standard C as part of C11.
C++11 begins   C++11 ends	The text describes a feature that is introduced into standard C++ as part of C++11.

Syntax diagrams

Throughout this information, diagrams illustrate XL C/C++ syntax. This section helps you to interpret and use those diagrams.

- Read the syntax diagrams from left to right, from top to bottom, following the path of the line.
 - The  symbol indicates the beginning of a command, directive, or statement.
 - The  symbol indicates that the command, directive, or statement syntax is continued on the next line.
 - The  symbol indicates that a command, directive, or statement is continued from the previous line.
 - The  symbol indicates the end of a command, directive, or statement.
- Fragments, which are diagrams of syntactical units other than complete commands, directives, or statements, start with the  symbol and end with the  symbol.

- Required items are shown on the horizontal line (the main path):

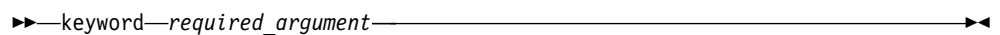

- Optional items are shown below the main path:

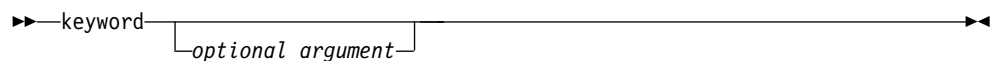

- If you can choose from two or more items, they are shown vertically, in a stack. If you *must* choose one of the items, one item of the stack is shown on the main path.

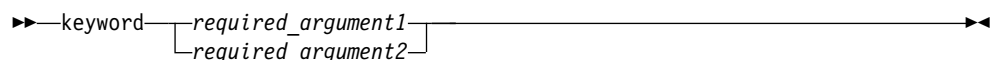

If choosing one of the items is optional, the entire stack is shown below the main path.



- An arrow returning to the left above the main line (a repeat arrow) indicates that you can make more than one choice from the stacked items or repeat an item. The separator character, if it is other than a blank, is also indicated:

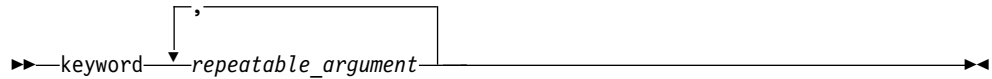

- The item that is the default is shown above the main path.



- Keywords are shown in nonitalic letters and should be entered exactly as shown.
- Variables are shown in italicized lowercase letters. They represent user-supplied names or values.
- If punctuation marks, parentheses, arithmetic operators, or other such symbols are shown, you must enter them as part of the syntax.

Sample syntax diagram

The following syntax diagram example shows the syntax for the **#pragma comment** directive.

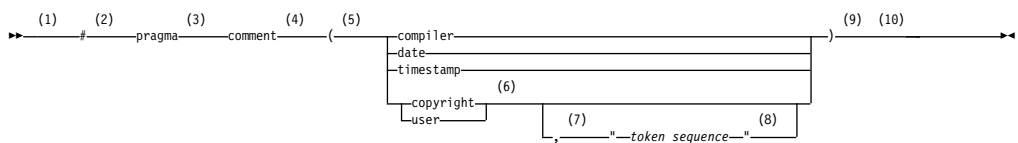

Notes:

- 1 This is the start of the syntax diagram.
- 2 The symbol # must appear first.
- 3 The keyword pragma must appear following the # symbol.
- 4 The name of the pragma comment must appear following the keyword pragma.
- 5 An opening parenthesis must be present.
- 6 The comment type must be entered only as one of the types indicated: compiler, date, timestamp, copyright, or user.
- 7 A comma must appear between the comment type copyright or user, and an optional character string.
- 8 A character string must follow the comma. The character string must be enclosed in double quotation marks.
- 9 A closing parenthesis is required.

10 This is the end of the syntax diagram.

The following examples of the **#pragma comment** directive are syntactically correct according to the diagram shown above:

```
#pragma comment(date)
#pragma comment(user)
#pragma comment(copyright,"This text will appear in the module")
```

Example of a syntax statement

EXAMPLE *char_constant* {*a|b*}[*c|d*]*e*[,*e*]... *name_list*{*name_list*}...

The following list explains the syntax statement:

- Enter the keyword EXAMPLE.
- Enter a value for *char_constant*.
- Enter a value for *a* or *b*, but not for both.
- Optionally, enter a value for *c* or *d*.
- Enter at least one value for *e*. If you enter more than one value, you must put a comma between each.
- Optionally, enter the value of at least one *name* for *name_list*. If you enter more than one value, you must put a comma between each *name*.

Note: The same example is used in both the syntax-statement and syntax-diagram representations.

Examples in this information

The examples in this information, except where otherwise noted, are coded in a simple style that does not try to conserve storage, check for errors, achieve fast performance, or demonstrate all possible methods to achieve a specific result.

The examples for installation information are labelled as either *Example* or *Basic example*. *Basic examples* are intended to document a procedure as it would be performed during a basic, or default, installation; these need little or no modification.

Related information

The following sections provide related information for XL C/C++:

IBM XL C/C++ information

XL C/C++ provides product information in the following formats:

- Quick Start Guide

The Quick Start Guide ([quickstart.pdf](#)) is intended to get you started with IBM XL C/C++ for AIX, V13.1.2. It is located by default in the XL C/C++ directory and in the \quickstart directory of the installation DVD.

- README files

README files contain late-breaking information, including changes and corrections to the product information. README files are located by default in the XL C/C++ directory and in the root directory of the installation DVD.

- Installable man pages

Man pages are provided for the compiler invocations and all command-line utilities provided with the product. Instructions for installing and accessing the man pages are provided in the *IBM XL C/C++ for AIX, V13.1.2 Installation Guide*.

- Online product documentation
The fully searchable HTML-based documentation is viewable in IBM Knowledge Center at http://www.ibm.com/support/knowledgecenter/SSGH3R_13.1.2/com.ibm.compilers.aix.doc/welcome.html.
- PDF documents
PDF documents are available on the web at <http://www.ibm.com/support/docview.wss?uid=swg27036618>.
The following files comprise the full set of XL C/C++ product information:

Table 3. XL C/C++ PDF files

Document title	PDF file name	Description
<i>IBM XL C/C++ for AIX, V13.1.2 Installation Guide, SC27-4258-01</i>	install.pdf	Contains information for installing XL C/C++ and configuring your environment for basic compilation and program execution.
<i>Getting Started with IBM XL C/C++ for AIX, V13.1.2, SC27-4257-01</i>	getstart.pdf	Contains an introduction to the XL C/C++ product, with information about setting up and configuring your environment, compiling and linking programs, and troubleshooting compilation errors.
<i>IBM XL C/C++ for AIX, V13.1.2 Compiler Reference, SC27-4259-01</i>	compiler.pdf	Contains information about the various compiler options, pragmas, macros, environment variables, and built-in functions, including those used for parallel processing.
<i>IBM XL C/C++ for AIX, V13.1.2 Language Reference, SC27-4260-01</i>	langref.pdf	Contains information about the C and C++ programming languages, as supported by IBM, including language extensions for portability and conformance to nonproprietary standards.
<i>IBM XL C/C++ for AIX, V13.1.2 Optimization and Programming Guide, SC27-4261-01</i>	proguide.pdf	Contains information about advanced programming topics, such as application porting, interlanguage calls with Fortran code, library development, application optimization and parallelization, and the XL C/C++ high-performance libraries.
<i>Standard C++ Library Reference, SC27-4262-01</i>	stdlib.pdf	Contains reference information about the standard C++ runtime libraries and headers.
<i>C/C++ Legacy Class Libraries Reference, SC09-7652-00</i>	legacy.pdf	Contains reference information about the USL I/O Stream Library and the Complex Mathematics Library.

To read a PDF file, use Adobe Reader. If you do not have Adobe Reader, you can download it (subject to license terms) from the Adobe website at <http://www.adobe.com>.

More information related to XL C/C++, including IBM Redbooks® publications, white papers, and other articles, is available on the web at <http://www.ibm.com/support/docview.wss?uid=swg27036618>.

For more information about C/C++, see the C/C++ café at <https://www.ibm.com/developerworks/community/groups/service/html/communityview?communityUuid=5894415f-be62-4bc0-81c5-3956e82276f3>.

Standards and specifications

XL C/C++ is designed to support the following standards and specifications. You can refer to these standards and specifications for precise definitions of some of the features found in this information.

- *Information Technology - Programming languages - C, ISO/IEC 9899:1990*, also known as C89.
- *Information Technology - Programming languages - C, ISO/IEC 9899:1999*, also known as C99.
- *Information Technology - Programming languages - C, ISO/IEC 9899:2011*, also known as C11. (Partial support)
- *Information Technology - Programming languages - C++, ISO/IEC 14882:1998*, also known as C++98.
- *Information Technology - Programming languages - C++, ISO/IEC 14882:2003*, also known as *Standard C++*.
- *Information Technology - Programming languages - C++, ISO/IEC 14882:2011*, also known as C++11 (Partial support).
- *Draft Technical Report on C++ Library Extensions, ISO/IEC DTR 19768*. This draft technical report has been submitted to the C++ standards committee, and is available at <http://www.open-std.org/JTC1/SC22/WG21/docs/papers/2005/n1836.pdf>.
- *AltiVec Technology Programming Interface Manual*, Motorola Inc. This specification for vector data types, to support vector processing technology, is available at http://www.freescale.com/files/32bit/doc/ref_manual/ALTIVECPIM.pdf.
- *Information Technology - Programming Languages - Extension for the programming language C to support decimal floating-point arithmetic, ISO/IEC WDTR 24732*. This draft technical report has been submitted to the C standards committee, and is available at <http://www.open-std.org/JTC1/SC22/WG14/www/docs/n1176.pdf>.
- *Decimal Types for C++: Draft 4* <http://www.open-std.org/jtc1/sc22/wg21/docs/papers/2006/n1977.html>
- *ANSI/IEEE Standard for Binary Floating-Point Arithmetic, ANSI/IEEE Std 754-1985*.
- *OpenMP Application Program Interface Version 3.1* (full support) and *OpenMP Application Program Interface Version 4.0* (partial support), available at <http://www.openmp.org>

Other IBM information

- *Parallel Environment for AIX: Operation and Use*
- The IBM Systems Information Center, at <http://publib.boulder.ibm.com/infocenter/systems/index.jsp?topic=/com.ibm.aix.doc/doc/base/aixparent.htm>, is a resource for AIX information.

You can find the following books for your specific AIX system:

- *AIX Commands Reference, Volumes 1 - 6*
- *Technical Reference: Base Operating System and Extensions, Volumes 1 & 2*
- *AIX National Language Support Guide and Reference*
- *AIX General Programming Concepts: Writing and Debugging Programs*
- *AIX Assembler Language Reference*

Other information

- *Using the GNU Compiler Collection* available at <http://gcc.gnu.org/onlinedocs>

Technical support

Additional technical support is available from the XL C/C++ Support page at http://www.ibm.com/support/entry/portal/Overview/Software/Rational/XL_C~C++_for_AIX. This page provides a portal with search capabilities to a large selection of Technotes and other support information.

If you cannot find what you need, you can send an email to compinfo@cn.ibm.com.

For the latest information about XL C/C++, visit the product information site at <http://www.ibm.com/software/products/us/en/xlcpp-aix/>.

How to send your comments

Your feedback is important in helping to provide accurate and high-quality information. If you have any comments about this information or any other XL C/C++ information, send your comments by email to compinfo@cn.ibm.com.

Be sure to include the name of the manual, the part number of the manual, the version of XL C/C++, and, if applicable, the specific location of the text you are commenting on (for example, a page number or table number).

Chapter 1. Language levels and language extensions

The C and C++ languages described in this reference are based on the standards listed in “Standards and specifications” on page xv.

We refer to the following language specifications as “base language levels” in order to introduce the notion of an extension to a base. In this context the base language levels refer to the following specifications:

- C++11
- C++03
- C++98
- C99
- C89

This information uses the term *K&R C* to refer to the C language plus the generally accepted extensions produced by Brian Kernighan and Dennis Ritchie that were in use prior to the ISO standardization of C.

In addition to the features supported by the base levels, XL C/C++ contains language extensions that enhance usability and facilitate porting programs to different platforms, including:

- “Extensions related to C11 standard features” on page 2
- “Extensions related to C++11 standard features” on page 2
- “Extensions to C++ to support C99 and C11 standard features” on page 2
- “Extensions related to GNU C and GNU C++” on page 3
- “Extensions supporting and extending the AltiVec Programming Interface” on page 3
- “Extensions supporting Unicode” on page 3

You can control the language level to be used for compilation through several mechanisms, including:

- various invocation commands in the *XL C/C++ Compiler Reference*
- the **-qlanglvl** option in the *XL C/C++ Compiler Reference*

With a few exceptions, almost all of the language extensions are supported when you compile using the basic invocation commands **xlc** (for C) and **xlc++** or **xlc** (for C++).

The default language level for the **xlc** invocation command is **extc99**, which includes all of the features introduced by the C99 standard, and most of the IBM extensions described in this information. For a complete listing of the C extensions and various methods for enabling them, see Chapter 19, “The IBM XL C language extensions,” on page 511.

The default language level for the **xlc** or **xlc++** invocation command is **extended**, which includes most of the IBM extensions described in this information, as well as many C99 features. For a complete listing of the C++ extensions and methods for enabling them, see Chapter 20, “The IBM XL C++ language extensions,” on page 517.

For information on the various methods for controlling the language level for compilation, see *Invoking the compiler in the XL C/C++ Compiler Reference* and `-qlanglvl` in the *XL C/C++ Compiler Reference*.

Extensions related to C11 standard features

C11

Note: IBM supports selected features of C11, known as C1X before its ratification. IBM will continue to develop and implement the features of this standard. The implementation of the language level is based on IBM's interpretation of the standard. Until IBM's implementation of all the C11 features is complete, including the support of a new C11 standard library, the implementation may change from release to release. IBM makes no attempt to maintain compatibility, in source, binary, or listings and other compiler interfaces, with earlier releases of IBM's implementation of the C11 features.

C11

XL C/C++ supports the currently implemented C11 features as part of a continual phased release process leading towards full compliance with C11. A complete list of C11 features supported in XL C/C++ is provided in “C11 compatibility” on page 512.

Extensions related to C++11 standard features

C++11

Note: IBM supports selected features of C++11, known as C++0x before its ratification. IBM will continue to develop and implement the features of this standard. The implementation of the language level is based on IBM's interpretation of the standard. Until IBM's implementation of all the C++11 features is complete, including the support of a new C++11 standard library, the implementation might change from release to release. IBM makes no attempt to maintain compatibility, in source, binary, or listings and other compiler interfaces, with earlier releases of IBM's implementation of the new C++11 features.

C++11

XL C/C++ supports the currently-implemented C++11 features as part of a continual phased release process leading towards full compliance with C++11. A complete list of C++11 features supported in XL C++ is provided in “C++11 compatibility” on page 519.

Extensions to C++ to support C99 and C11 standard features

The C++03 language specification does not include many of the features specified in the C99 and C11 language standards. To promote compatibility and portability between C++ and C99 or between C++ and C11, the XL C++ compiler enables many of the C99 and C11 features that are supported by the XL C compiler. Because these features extend the C++ standard, they are considered extensions to the base language. In this reference, unless the text is marked to indicate that a

feature is supported in C, C99, or C11 only, C99 and C11 features also apply to C++. A complete list of C99 and C11 features supported in XL C++ is provided in “Extensions for C99 compatibility” on page 518 and “Extensions for C11 compatibility” on page 519.

Extensions related to GNU C and GNU C++

Certain language extensions that correspond to GNU C and GNU C++ features are implemented to facilitate portability. These include extensions to C89, C99, C++98, and C++03. Throughout this information, the text indicates the IBM extensions that have been implemented for compatibility with GNU C and GNU C++; a complete list of these is provided in “Extensions for GNU C compatibility” on page 512 and “Extensions for GNU C++ compatibility” on page 525.

Extensions supporting and extending the AltiVec Programming Interface

XL C/C++ supports and extends AltiVec vector types when vector support is enabled. These language extensions exploit the SIMD and parallel processing capabilities of the PowerPC[®] processor, and facilitate the associated optimization techniques. The IBM implementation of the AltiVec Programming Interface specification is an extended implementation, which, for the most part, matches the syntax and semantics of the GNU C implementation. In addition to the text provided throughout this information that describes the behavior of the vector extensions, a list of the IBM extensions to the AltiVec Programming Interface is also provided in “Extensions for vector processing support” on page 516.

Extensions supporting Unicode

The *Unicode Standard* is the specification of an encoding scheme for written characters and text. It is a universal standard that enables consistent encoding of multilingual text and allows text data to be interchanged internationally without conflict. The ISO C and ISO C++ Committees have approved the implementation of *u-literals* and *U-literals* to support Unicode UTF-16 and UTF-32 character literals, respectively. See “Extensions for Unicode support” on page 516 for details.

Chapter 2. Scope and linkage

Scope is the largest region of program text in which a name can potentially be used without qualification to refer to an entity; that is, the largest region in which the name is potentially valid. Broadly speaking, scope is the general context used to differentiate the meanings of entity names. The rules for scope combined with those for name resolution enable the compiler to determine whether a reference to an identifier is legal at a given point in a file.

The scope of a declaration and the visibility of an identifier are related but distinct concepts. Scope is the mechanism by which it is possible to limit the visibility of declarations in a program. The *visibility* of an identifier is the region of program text from which the object associated with the identifier can be legally accessed. Scope can exceed visibility, but visibility cannot exceed scope. Scope exceeds visibility when a duplicate identifier is used in an inner declarative region, thereby hiding the object declared in the outer declarative region. The original identifier cannot be used to access the first object until the scope of the duplicate identifier (the lifetime of the second object) has ended.

Thus, the scope of an identifier is interrelated with the *storage duration* of the identified object, which is the length of time that an object remains in an identified region of storage. The lifetime of the object is influenced by its storage duration, which in turn is affected by the scope of the object identifier.

Linkage refers to the use or availability of a name across multiple translation units or within a single translation unit. The term *translation unit* refers to a source code file plus all the header and other source files that are included after preprocessing with the `#include` directive, minus any source lines skipped because of conditional preprocessing directives. Linkage allows the correct association of each instance of an identifier with one particular object or function.

Scope and linkage are distinguishable in that scope is for the benefit of the compiler, whereas linkage is for the benefit of the linker. During the translation of a source file to object code, the compiler keeps track of the identifiers that have external linkage and eventually stores them in a table within the object file. The linker is thereby able to determine which names have external linkage, but is unaware of those with internal or no linkage.

The distinctions between the different types of scopes are discussed in “Scope” on page 6. The different types of linkages are discussed in “Program linkage” on page 11.

Related reference:

“Storage class specifiers” on page 54

Chapter 10, “Namespaces (C++ only),” on page 293

Scope

The *scope* of an identifier is the largest region of the program text in which the identifier can potentially be used to refer to its object. In C++, the object being referred to must be unique. However, the name to access the object, the identifier itself, can be reused. The meaning of the identifier depends upon the context in which the identifier is used. Scope is the general context used to distinguish the meanings of names.

The scope of an identifier is possibly noncontiguous. One of the ways that breakage occurs is when the same name is reused to declare a different entity, thereby creating a contained declarative region (inner) and a containing declarative region (outer). Thus, point of declaration is a factor affecting scope. Exploiting the possibility of a noncontiguous scope is the basis for the technique called *information hiding*.

The concept of scope that exists in C was expanded and refined in C++. The following table shows the kinds of scopes and the minor differences in terminology.

Table 4. Kinds of scope

C	C++
block	local
function	function
Function prototype	Function prototype
file	global namespace
	namespace
	class

In all declarations, the identifier is in scope before the initializer. The following example demonstrates this:

```
int x;  
void f() {  
    int x = x;  
}
```

The `x` declared in function `f()` has local scope, not global scope.

Related reference:

Chapter 10, “Namespaces (C++ only),” on page 293

Block/local scope

A name has *local scope* or *block scope* if it is declared in a block. A name with local scope can be used in that block and in blocks enclosed within that block, but the name must be declared before it is used. When the block is exited, the names declared in the block are no longer available.

Parameter names for a function have the scope of the outermost block of that function. Also, if the function is declared and not defined, these parameter names have function prototype scope.

When one block is nested inside another, the variables from the outer block are usually visible in the nested block. However, if the declaration of a variable in a

nested block has the same name as a variable that is declared in an enclosing block, the declaration in the nested block hides the variable that was declared in the enclosing block. The original declaration is restored when program control returns to the outer block. This is called *block visibility*.

Name resolution in a local scope begins in the immediately enclosing scope in which the name is used and continues outward with each enclosing scope. The order in which scopes are searched during name resolution causes the phenomenon of information hiding. A declaration in an enclosing scope is hidden by a declaration of the same identifier in a nested scope.

Related reference:

“Block statements” on page 222

Function scope

The only type of identifier with *function scope* is a label name. A label is implicitly declared by its appearance in the program text and is visible throughout the function that declares it.

A label can be used in a `goto` statement before the actual label is seen.

Related reference:

“Labeled statements” on page 219



Function prototype scope

In a function declaration (also called a *function prototype*) or in any function declarator—except the declarator of a function definition—parameter names have *function prototype scope*. Function prototype scope terminates at the end of the nearest enclosing function declarator.

Related reference:

“Function declarations” on page 247

File/global scope

 A name has *file scope* if the identifier's declaration appears outside of any block. A name with file scope and internal linkage is visible from the point where it is declared to the end of the translation unit. 

 *Global scope* or *global namespace scope* is the outermost namespace scope of a program, in which objects, functions, types and templates can be defined. A name has *global namespace scope* if the identifier's declaration appears outside of all blocks, namespaces, and classes.

A name with global namespace scope and internal linkage is visible from the point where it is declared to the end of the translation unit.

A name with global (namespace) scope is also accessible for the initialization of global variables. If that name is declared extern, it is also visible at link time in all object files being linked.

A user-defined namespace can be nested within the global scope using namespace definitions, and each user-defined namespace is a different scope, distinct from the global scope. 

Related reference:

Chapter 10, “Namespaces (C++ only),” on page 293

“Internal linkage” on page 11

“The extern storage class specifier” on page 57

Examples of scope in C

The following example declares the variable `x` on line 1, which is different from the `x` it declares on line 2. The declared variable on line 2 has function prototype scope and is visible only up to the closing parenthesis of the prototype declaration. The variable `x` declared on line 1 resumes visibility after the end of the prototype declaration.

```
1 int x = 4;          /* variable x defined with file scope */
2 long myfunc(int x, long y); /* variable x has function      */
3                               /* prototype scope          */
4 int main(void)
5 {
6     /* . . . */
7 }
```

The following program illustrates blocks, nesting, and scope. The example shows two kinds of scope: file and block. The main function prints the values 1, 2, 3, 0, 3, 2, 1 on separate lines. Each instance of `i` represents a different variable.

```
        #include <stdio.h>
        int i = 1;          /* i defined at file scope */

        int main(int argc, char * argv[])
        {
1         printf("%d\n", i);          /* Prints 1 */
1
1         {
1 2             int i = 2, j = 3;    /* i and j defined at block scope */
1 2                                     /* global definition of i is hidden */
1 2             printf("%d\n%d\n", i, j); /* Prints 2, 3 */
1 2
1 2             {
1 2 3                 int i = 0; /* i is redefined in a nested block */
1 2 3                                     /* previous definitions of i are hidden */
1 2 3                 printf("%d\n%d\n", i, j); /* Prints 0, 3 */
1 2             }
1 2             printf("%d\n", i);    /* Prints 2 */
1 2
1         }
1
1         printf("%d\n", i);          /* Prints 1 */
1
1         return 0;
1     }
```

Class scope (C++ only)

A name declared within a member function hides a declaration of the same name whose scope extends to or past the end of the member function's class.

When the scope of a declaration extends to or past the end of a class definition, the regions defined by the member definitions of that class are included in the scope of the class. Members defined lexically outside of the class are also in this scope. In addition, the scope of the declaration includes any portion of the declarator following the identifier in the member definitions.

The name of a class member has *class scope* and can only be used in the following cases:

- In a member function of that class
- In a member function of a class derived from that class
- After the . (dot) operator applied to an instance of that class
- After the . (dot) operator applied to an instance of a class derived from that class, as long as the derived class does not hide the name
- After the -> (arrow) operator applied to a pointer to an instance of that class
- After the -> (arrow) operator applied to a pointer to an instance of a class derived from that class, as long as the derived class does not hide the name
- After the :: (scope resolution) operator applied to the name of a class
- After the :: (scope resolution) operator applied to a class derived from that class

Related reference:

Chapter 12, “Classes (C++ only),” on page 325

“Scope of class names” on page 329

“Member scope” on page 339

“Friend scope” on page 355

“Access control of base class members” on page 365

“Scope resolution operator :: (C++ only)” on page 166

Namespaces of identifiers

Namespaces are the various syntactic contexts within which an identifier can be used. Within the same context and the same scope, an identifier must uniquely identify an entity. Note that the term *namespace* as used here applies to C as well as C++ and does not refer to the C++ namespace language feature. The compiler sets up *namespaces* to distinguish among identifiers referring to different kinds of entities. Identical identifiers in different namespaces do not interfere with each other, even if they are in the same scope.

The same identifier can declare different objects as long as each identifier is unique within its namespace. The syntactic context of an identifier within a program lets the compiler resolve its namespace without ambiguity.

Within each of the following four namespaces, the identifiers must be unique:

- *Tags* of the following types must be unique within a single scope:
 - Enumerations
 - Structures and unions
- *Members* of structures, unions, and classes must be unique within a single structure, union, or class type.
- *Statement labels* have function scope and must be unique within a function.
- All other *ordinary identifiers* must be unique within a single scope:
 - C function names (C++ function names can be overloaded)
 - Variable names
 - Names of function parameters
 - Enumeration constants
 - typedef names

You can redefine identifiers in the same namespace using enclosed program blocks.

Structure tags, structure members, variable names, and statement labels are in four different namespaces. No name conflict occurs among the items named `student` in the following example:

```
int get_item()
{
    struct student      /* structure tag */
    {
        char student[20]; /* structure member */
        int section;
        int id;
    } student;          /* structure variable */

    goto student;
    student::;          /* null statement label */
    return 0;
}
```

The compiler interprets each occurrence of `student` by its context in the program: when `student` appears after the keyword `struct`, it is a structure tag; when it appears in the block defining the `student` type, it is a structure member variable; when it appears at the end of the structure definition, it declares a structure variable; and when it appears after the `goto` statement, it is a label.

Name hiding (C++ only)

If a class name or enumeration name is in scope and not hidden, it is *visible*. A class name or enumeration name can be hidden by an explicit declaration of that same name — as an object, function, or enumerator — in a nested declarative region or derived class. The class name or enumeration name is hidden wherever the object, function, or enumerator name is visible. This process is referred to as *name hiding*.

In a member function definition, the declaration of a local name hides the declaration of a member of the class with the same name. The declaration of a member in a derived class hides the declaration of a member of a base class of the same name.

Suppose a name `x` is a member of namespace `A`, and suppose that the members of namespace `A` are visible in namespace `B` through the use of a declaration. A declaration of an object named `x` in namespace `B` will hide `A::x`. The following example demonstrates this:

```
#include <iostream>
#include <typeinfo>
using namespace std;

namespace A {
    char x;
};

namespace B {
    using namespace A;
    int x;
};

int main() {
    cout << typeid(B::x).name() << endl;
}
```

See the output of the above example:

```
int
```

The declaration of the integer `x` in namespace `B` hides the character `x` introduced by the using declaration.

Related reference:

Chapter 12, “Classes (C++ only),” on page 325

“Member functions” on page 337

“Member scope” on page 339

Chapter 10, “Namespaces (C++ only),” on page 293

Program linkage

Linkage determines whether identifiers that have identical names refer to the same object, function, or other entity, even if those identifiers appear in different translation units. The linkage of an identifier depends on how it was declared. There are three types of linkages:

- “Internal linkage” : identifiers can only be seen within a translation unit.
- “External linkage” on page 12 : identifiers can be seen (and referred to) in other translation units.
- “No linkage” on page 12: identifiers can only be seen in the scope in which they are defined.

Linkage does not affect scoping, and normal name lookup considerations apply.

► C++ You can also have linkage between C++ and non-C++ code fragments, which is called *language linkage*. Language linkage enables the close relationship between C++ and C by allowing C++ code to link with that written in C. All identifiers have a language linkage, which by default is C++. Language linkage must be consistent across translation units, and non-C++ language linkage implies that the identifier has external linkage.

Related reference:

“The static storage class specifier” on page 55

“The extern storage class specifier” on page 57

“Function storage class specifiers” on page 254

“Type qualifiers” on page 98

“Structures and unions” on page 70

Internal linkage

The following kinds of identifiers have internal linkage:

- Objects, references, or functions explicitly declared `static`
- Objects or references declared in namespace scope (or global scope in C) with the specifier `const` ► C++11 or `constexpr` ► C++11 ◀ and neither explicitly declared `extern`, nor previously declared to have external linkage
- Data members of an anonymous union
- ► C++ Function templates explicitly declared `static`
- ► C++ Identifiers declared in the unnamed namespace

A function declared inside a block will usually have external linkage. An object declared inside a block will usually have external linkage if it is specified `extern`. If a variable that has `static` storage is defined outside a function, the variable has internal linkage and is available from the point where it is defined to the end of the current translation unit.

If the declaration of an identifier has the keyword `extern` and if a previous declaration of the identifier is visible at namespace or global scope, the identifier has the same linkage as the first declaration.

External linkage

C In global scope, identifiers for the following kinds of entities declared without the `static` storage class specifier have external linkage:

- An object
- A function

If an identifier in C is declared with the `extern` keyword and if a previous declaration of an object or function with the same identifier is visible, the identifier has the same linkage as the first declaration. For example, a variable or function that is first declared with the keyword `static` and later declared with the keyword `extern` has internal linkage. However, a variable or function that has no linkage and was later declared with a linkage specifier will have the linkage that was expressly specified. **C**

C++ In namespace scope, the identifiers for the following kinds of entities have external linkage:

- A reference or an object that does not have internal linkage
- A function that does not have internal linkage
- A named class or enumeration
- An unnamed class or enumeration defined in a typedef declaration
- An enumerator of an enumeration that has external linkage
- A template, unless it is a function template with internal linkage
- A namespace, unless it is declared in an unnamed namespace

If the identifier for a class has external linkage, then, in the implementation of that class, the identifiers for the following entities will also have external linkage:

- A member function
- A static data member
- A class of class scope
- An enumeration of class scope

C++

No linkage

The following kinds of identifiers have no linkage:

- Names that have neither external nor internal linkage
- Names declared in local scopes (with exceptions of certain entities declared with the `extern` keyword)
- Identifiers that do not represent an object or a function, including labels, enumerators, typedef names that refer to entities with no linkage, type names, function parameters, and **C++** template names **C++**

You cannot use a name with no linkage to declare an entity with linkage. For example, you cannot use the name of a structure or enumeration or a typedef name referring to an entity with no linkage to declare an entity with linkage. The following example demonstrates this:

```

int main() {
    struct A { };
    // extern A a1;
    typedef A myA;
    // extern myA a2;
}

```

The compiler will not allow the declaration of `a1` with external linkage. Structure `A` has no linkage. The compiler will not allow the declaration of `a2` with external linkage. The typedef name `myA` has no linkage because `A` has no linkage.

Language linkage (C++ only)

Linkage between C++ and non-C++ code fragments is called *language linkage*. All function types, function names, and variable names have a language linkage, which by default is C++.

You can link C++ object modules to object modules produced using other source languages such as C by using a *linkage specification*.

Linkage specification syntax

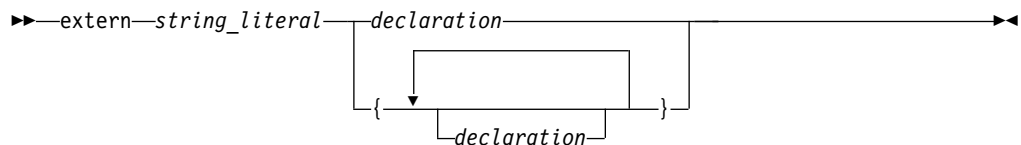

The *string_literal* is used to specify the linkage associated with a particular function. String literals used in linkage specifications should be considered as case-sensitive. All platforms support the following values for *string_literal*:

- "C++" Unless otherwise specified, objects and functions have this default linkage specification.
- "C" Indicates linkage to a C procedure.

Calling shared libraries that were written before C++ needed to be taken into account requires the `#include` directive to be within an `extern "C" { }` declaration.

```

extern "C" {
#include "shared.h"
}

```

The following example shows a C printing function that is called from C++.

```

// in C++ program
extern "C" int displayfoo(const char *);
int main() {
    return displayfoo("hello");
}

/* in C program */
#include <stdio.h>
extern int displayfoo(const char * str) {
    while (*str) {
        putchar(*str);
        putchar(' ');
        ++str;
    }
    putchar('\n');
}

```

Name mangling (C++ only)

Name mangling is the encoding of function and variable names into unique names so that linkers can separate common names in the language. Type names may also be mangled. Name mangling is commonly used to facilitate the overloading feature and visibility within different scopes. The compiler generates function names with an encoding of the types of the function arguments when the module is compiled. If a variable is in a namespace, the name of the namespace is mangled into the variable name so that the same variable name can exist in more than one namespace. The C++ compiler also mangles C variable names to identify the namespace in which the C variable resides.

The scheme for producing a mangled name differs with the object model used to compile the source code: the mangled name of an object of a class compiled using one object model will be different from that of an object of the same class compiled using a different object model. The object model is controlled by compiler option or by pragma.

Name mangling is not desirable when linking C modules with libraries or object files compiled with a C++ compiler. To prevent the C++ compiler from mangling the name of a function, you can apply the extern "C" linkage specifier to the declaration or declarations, as shown in the following example:

```
extern "C" {
    int f1(int);
    int f2(int);
    int f3(int);
};
```

This declaration tells the compiler that references to the functions f1, f2, and f3 should not be mangled.

The extern "C" linkage specifier can also be used to prevent mangling of functions that are defined in C++ so that they can be called from C. For example,

```
extern "C" {
    void p(int){
        /* not mangled */
    }
};
```

In multiple levels of nested extern declarations, the innermost extern specification prevails.

```
extern "C" {
    extern "C++" {
        void func();
    }
}
```

In this example, func has C++ linkage.

Chapter 3. Lexical elements

A *lexical element* refers to a character or groupings of characters that might legally appear in a source file. This chapter contains discussions of the basic lexical elements and conventions of the C and C++ programming languages.

Tokens

Source code is treated during preprocessing and compilation as a sequence of *tokens*. A token is the smallest independent unit of meaning in a program, as defined by the compiler.

Adjacent identifiers, keywords, and literals must be separated with white space. Other tokens should be separated by white space to make the source code more readable. White space includes blanks, horizontal and vertical tabs, new lines, form feeds, and comments.

There are the following different types of tokens:

- “Keywords”
- “Identifiers” on page 18
- “Literals” on page 21
- “Punctuators and operators” on page 37

Keywords



Keywords are identifiers reserved by the language for special use. Although you can use them for preprocessor macro names, it is considered poor programming style. Only the exact spelling of keywords is reserved. For example, `auto` is reserved but `AUTO` is not.

Keywords for the C and C++ languages

Table 5. C and C++ keywords

<code>auto</code> ¹	<code>double</code>	<code>int</code>	<code>struct</code>
<code>break</code>	<code>else</code>	<code>long</code>	<code>switch</code>
<code>case</code>	<code>enum</code>	<code>register</code>	<code>typedef</code>
<code>char</code>	<code>extern</code> ²	<code>return</code>	<code>union</code>
<code>const</code>	<code>float</code>	<code>short</code>	<code>unsigned</code>
<code>continue</code>	<code>for</code>	<code>signed</code>	<code>void</code>
<code>default</code>	<code>goto</code>	<code>sizeof</code>	<code>volatile</code>
<code>do</code>	<code>if</code>	<code>static</code>	<code>while</code>

Notes:

1.  In C++11, the keyword `auto` is no longer used as a storage class specifier. Instead, it is used as a type specifier, which can deduce the type of an `auto` variable from the type of its initializer expression.
2. The keyword `extern` was previously used as a storage specifier or as part of a linkage specification. The C++11 standard adds a third usage to use this keyword to specify explicit instantiation declarations. 



Keywords for the C language only

Standard C at the C99 and C11 levels also reserves the following keywords:

Table 6. C99 and C11 keywords

<code>_Bool</code>	<code>inline</code>
<code>_Complex</code>	<code>_Noreturn¹</code>
<code>_Generic¹</code>	<code>_Static_assert¹</code>
<code>_Imaginary²</code>	<code>restrict</code>

Notes:

1.  These keywords are introduced due to the C11 language level. 
2. The keyword `_Imaginary` is reserved for possible future use. For complex number functionality, use `_Complex`; see Complex literals for details.

 C

 C++

Keywords for the C++ language only

The C++ language also reserves the following keywords:

Table 7. C++ keywords

<code>bool</code>	<code>dynamic_cast</code>	<code>new</code>	<code>this</code>
<code>catch</code>	<code>decltype</code>	<code>nullptr</code>	<code>throw</code>
<code>class</code>	<code>explicit</code>	<code>operator</code>	<code>true</code>
	<code>export</code>	<code>private</code>	<code>try</code>
	<code>false</code>	<code>protected</code>	<code>typeid</code>
<code>const_cast</code>	<code>friend</code>	<code>public</code>	<code>typename</code>
<code>constexpr</code>	<code>inline</code>	<code>reinterpret_cast</code>	<code>using</code>
<code>delete</code>	<code>mutable</code>	<code>static_assert</code>	<code>virtual</code>
	<code>namespace</code>	<code>static_cast</code>	<code>wchar_t</code>
		<code>template</code>	

 C++











Keywords for language extensions (IBM extension)

In addition to standard language keywords, the XL C/C++ compiler reserves the following keywords for use in language extensions:

Table 8. Keywords for C and C++ language extensions

<code>__alignof</code>	<code>__extension__</code>	<code>__static_assert</code> ⁵
<code>__alignof__</code>	<code>__label__</code>	<code>__volatile__</code>
<code>asm</code>	<code>__imag__</code>	<code>__volatile__</code>
<code>__asm</code>	<code>__inline__</code> ¹	<code>__thread</code> ⁴
<code>__asm__</code>	<code>__Noreturn</code> ⁶	<code>typeof</code> ²
<code>__attribute__</code>	<code>pixel</code> ⁸	<code>__typeof__</code>
<code>__attribute</code>	<code>__pixel</code> ⁸	<code>vector</code> ⁸
<code>bool (C only)</code> ⁸	<code>__real__</code>	<code>__vector</code> ⁸
<code>__complex__</code>	<code>__restrict</code>	
<code>__const__</code>	<code>__restrict__</code>	
<code>__Decimal32</code> ³	<code>__signed__</code>	
<code>__Decimal64</code> ³	<code>__signed</code>	
<code>__Decimal128</code> ³		
<code>__decltype</code> ⁷		

Notes:

1.  The `__inline__` keyword uses the GNU C semantics for inline functions. For details, see “Linkage of inline functions” on page 257. 
2.  `typeof` is recognized only when `-qkeyword=typeof` is in effect. 
3. These keywords are recognized only when `-qdfp` is enabled.
4. `__thread` is recognized only when `-qt1s` is enabled.
5.  `__static_assert` is a keyword for C language extension for compatibility with the C++11 standard. 
6.  `__Noreturn` is a keyword for C++ language extension for compatibility with the C11 standard. 
7.  `__decltype` is a keyword for C++ language extension. It enables you to use the C++11 `decltype` functionality in all language levels. 
8. These keywords are recognized only in a vector declaration context, when vector support is enabled.

 The XL C/C++ compiler reserves the following keywords as language extensions for compatibility with C99.

Table 9. Keywords for C++ language extensions related to C99

<code>_Complex</code>
<code>_Imaginary</code> ¹
<code>restrict</code>

Note:

1. The keyword `_Imaginary` is reserved for possible future use. For complex number functionality, use `_Complex`; see Complex literals for details.



More detailed information regarding the compilation contexts in which extension keywords are valid is provided in the sections that describe each keyword.





Related reference:

 See `-qlanglvl` in the XL C/C++ Compiler Reference

 See `-qkeyword` in the XL C/C++ Compiler Reference
 “Vector types (IBM extension)” on page 66

Identifiers

Identifiers provide names for the following language elements:

- Functions
- Objects
- Labels
- Function parameters
- Macros and macro parameters
- Type definitions
- Enumerated types and enumerators
- Structure and union names
-  Classes and class members
-  Templates
-  Template parameters
-  Namespaces



An identifier consists of an arbitrary number of letters, digits, or the underscore character in the form:





Characters in identifiers

The first character in an identifier must be a letter or the `_` (underscore) character; however, beginning identifiers with an underscore is considered poor programming style.



The compiler distinguishes between uppercase and lowercase letters in identifiers. For example, `PROFIT` and `profit` represent different identifiers. If you specify a lowercase `a` as part of an identifier name, you cannot substitute an uppercase `A` in its place; you must use the lowercase letter.

The universal character names for letters and digits outside of the basic source character set are allowed in C++ and at the C99 language level.  In C++, you must compile with the `-q1ang1v1=ucs` option for universal character name support. 

 The dollar sign can appear in identifier names when compiled using the `-q dollar` compiler option or at one of the extended language levels that encompasses this option. 

Reserved identifiers

Identifiers with two initial underscores or an initial underscore followed by an uppercase letter are reserved globally for use by the compiler.

 Identifiers that begin with a single underscore are reserved as identifiers with file scope in both the ordinary and tag namespaces. 

► C++ Identifiers that begin with a single underscore are reserved in the global namespace. ◀ C++

Although the names of system calls and library functions are not reserved words if you do not include the appropriate headers, avoid using them as identifiers. Duplication of a predefined name can lead to confusion for the maintainers of your code and can cause errors at link time or run time. If you include a library in a program, be aware of the function names in that library to avoid name duplications. You should always include the appropriate headers when using standard library functions.

The `__func__` predefined identifier

The C99 predefined identifier `__func__` makes a function name available for use within the function. ► C++ The XL C/C++ compiler supports this feature as an IBM extension. ◀ C++ Immediately following the opening brace of each function definition, `__func__` is implicitly declared by the compiler. The resulting behavior is as if the following declaration had been made:

```
static const char __func__[] = "function-name";
```

where *function-name* is the name of the lexically-enclosing function. The function name is not mangled.

► C++ The function name is qualified with the enclosing class name or function name. For example, if `foo` is a member function of class `X`, the predefined identifier of `foo` is `X::foo`. If `foo` is defined within the body of `main`, the predefined identifier of `foo` is `main::X::foo`.

The names of template functions or member functions reflect the instantiated type. For example, the predefined identifier for the template function `foo` instantiated with `int`, `template<classT> void foo()` is `foo<int>`. ◀ C++

For debugging purposes, you can explicitly use the `__func__` identifier to return the name of the function in which it appears. For example:

```
#include <stdio.h>

void myfunc(void) {
    printf("%s\n", __func__);
    printf("size of __func__ = %d\n", sizeof(__func__));
}

int main() {
    myfunc();
}
```

The output of the program is:

```
myfunc
size of __func__ = 7
```

When the `assert` macro is used inside a function definition, the macro adds the name of the enclosing function on the standard error stream.

Assembly labels (IBM extension)

The compiler binds each non-static external variable and function name in the source code to a name that it generates in the object file and any assembly code that is emitted. For compatibility with GCC, the compiler implements an extension

to standard C and C++ that allows you to specify the name to be used in the object file and assembly code, by applying an assembly *label* to the declaration of a global variable or function prototype. You can also define names that do not start with an underscore even on systems where an underscore is normally prepended to the name of a function or variable.

► C++ You can use assembly labels with member functions, and functions and variables that are declared in namespaces other than the global namespace.

► C++ ◀

Assembly label syntax

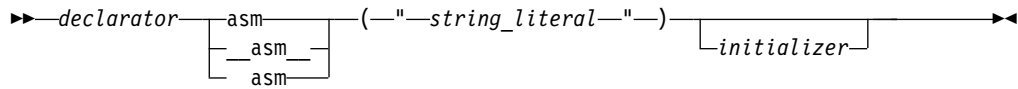

The *string_literal* is a valid assembly name that is to be bound to the given object or function.

The following are examples of assembly label specifications:

```
void func3() __asm__("foo3");
int i __asm("abc");
char c asm("abcs") = 'a';
```

► C++ To distinguish between overloaded functions, XL C++ mangles function names in the object file. Therefore, if you use an assembly label to map a function name, you must use the mangled name of the target function. Furthermore, you must ensure that an assembly label name that you specify for a variable does not conflict with any mangled name. Alternatively, you can prevent name mangling on a target function by declaring it as having C linkage; for more information, see “Name mangling (C++ only)” on page 14. ► C++ ◀

The following restrictions apply to the use of assembly labels:

- Assembly labels cannot be specified on local or static variables.
- The same assembly label name cannot be applied to multiple identifiers (in C++, this is the name after mangling) in the same compilation unit.
- The assembly label name cannot be the same as any other global identifier name (in C++, the name after mangling) in the same compilation unit, unless the label name and identifier name are used for the same variable or function declaration.
- The assembly label cannot be specified on typedef declarations.
- An assembly label cannot be the same as a name specified on a different variable or function by a previous **#pragma map** directive. Similarly, the map name specified by a **#pragma map** directive cannot be the same as a name specified by a previous assembly label on a different variable or function.
- You cannot apply an assembly label to an identifier that has been mapped to a different name by a **#pragma map** directive on a previous declaration of that variable or function. Similarly, you cannot specify a **#pragma map** directive on an identifier that has previously been remapped by an assembly label.
- ► C ◀ If you apply different labels to multiple declarations of the same variable or function, the first specification is honored, and all subsequent assembly labels are ignored with a warning.
- ► C++ ◀ You cannot apply an assembly label to any of the following:
 - member variable declarations

- friend declarations
- template function and member declarations, or any declarations contained within a template
- virtual member functions
- constructors and destructors

Related reference:

“Identifier expressions (C++ only)” on page 163

“The Unicode standard” on page 41

“Keywords” on page 15



See `-qlanglvl` in the XL C/C++ Compiler Reference

“Function declarations and definitions” on page 247



See `#pragma map` in the XL C/C++ Compiler Reference

“alias” on page 270



Variables in specified registers (IBM extension)

“Inline assembly statements (IBM extension)” on page 238



See `-qreserved_reg` in the XL C/C++ Compiler Reference

Literals

The term *literal constant*, or *literal*, refers to a value that occurs in a program and cannot be changed.  The C language uses the term *constant* in place of the noun *literal* . The adjective *literal* adds to the concept of a constant the notion that we can speak of it only in terms of its value. A literal constant is nonaddressable, which means that its value is stored somewhere in memory, but we have no means of accessing that address.

Every *literal* has a value and a data type. The value of any literal does not change while the program runs and must be in the range of representable values for its type.

There are the following different types of literals:

- “Integer literals”
- “Boolean literals” on page 25
- “Floating-point literals” on page 26
- “Vector literals (IBM extension)” on page 30
- “Character literals” on page 33
- “String literals” on page 34
- “Pointer literal (C++11)” on page 36

Integer literals

 C++11

Note: IBM supports selected features of C++11, known as C++0x before its ratification. IBM will continue to develop and implement the features of this standard. The implementation of the language level is based on IBM's interpretation of the standard. Until IBM's implementation of all the C++11 features is complete, including the support of a new C++11 standard library, the implementation might change from release to release. IBM makes no attempt to

maintain compatibility, in source, binary, or listings and other compiler interfaces, with earlier releases of IBM's implementation of the new C++11 features.

C++11 <

Integer literals are numbers that do not have a decimal point or an exponential part. They can be represented as:

- Decimal integer literals
- Hexadecimal integer literals
- Octal integer literals

An integer literal might have a prefix that specifies its base, or a suffix that specifies its type.

Integer literal syntax

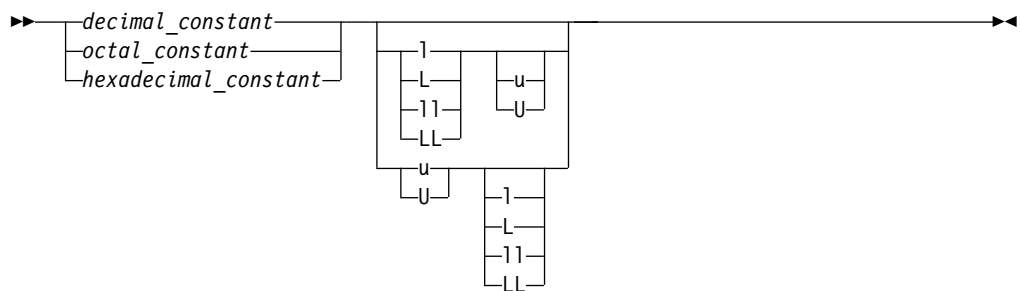

The long long features

There are two long long features:

- the C99 long long feature
- the non-C99 long long feature

Note: The syntax of integer literals is the same for both of the long long features.

Types of integer literals that are supported in pre-C99 and pre-C++11 modes

The following table lists the integer literals and shows the possible data types when the C99 long long feature is not enabled.

Table 10. Types of integer literals that are supported in pre-C99 and pre-C++11 modes¹

Representation	Suffix	Possible data types					
		int	unsigned int	long int	unsigned long int	IBM long long int	IBM unsigned long long int
Decimal	None	+		+	+ ²		
Octal, Hex	None	+	+	+	+		
All	u or U		+		+		
Decimal	l or L			+	+		
Octal, Hex	l or L			+	+		

Table 10. Types of integer literals that are supported in pre-C99 and pre-C++11 modes¹ (continued)

Representation	Suffix	Possible data types					
All	Both u or U and l or L				+		
Decimal	ll or LL					+	+
Octal, Hex	ll or LL					+	+
All	Both u or U and ll or LL						+

Note:

- When none of the long long features are enabled, types of integer literals include all the types in this table except the last two columns.
-  The unsigned long int type is not required here in the C++98 and C++03 standards. The C++ compiler includes the type in the implementation for compatibility purposes only.

Types of integer literals that are supported in C99 and C++11

The following example demonstrates the different behaviors of the compiler when you enable different long long behaviors:

```
#include <stdio.h>

int main(){
    if(0>3999999999-4000000000){
        printf("C99 long long");
    }
    else{
        printf("non-C99 IBM long long extension");
    }
}
```

In this example, the values 3999999999 and 4000000000 are too large to fit into the 32-bit long int type, but they can fit into either the unsigned long or the long long int type. If you enable the C99 long long feature, the two values have the long long int type, so the difference of 3999999999 and 4000000000 is negative. Otherwise, if you enable the non-C99 IBM long long extension, the two values have the unsigned long type, so the difference is positive.

When both the C99 and non-C99 long long features are disabled, integer literals that have one of the following suffixes cause a severe compile-time error:

- ll or LL
- Both u or U and ll or LL

 To strictly conform to the C++11 standard, the compiler introduces the extended integer safe behavior to ensure that a signed value never becomes an unsigned value after a promotion. After you enable this behavior, if a decimal integer literal that does not have a suffix containing u or U cannot be represented by the long long int type, the compiler issues an error message to indicate that

the value of the literal is out of range. The extended integer safe behavior is the only difference between the C99 long long feature with the associated IBM extensions and the C99 long long feature. [C++11](#)

The following table lists the integer literals and shows the possible data types when the C99 long long feature is enabled.

Table 11. Types of integer literals that are supported in C99 and C++11

Representation	Suffix	Possible data types					
		int	unsigned int	long int	unsigned long int	long long int	unsigned long long int
Decimal	None	+		+		+	+ ¹
Octal, Hex	None	+	+	+	+	+	+
All	u or U		+		+		+
Decimal	l or L			+		+	+ ¹
Octal, Hex	l or L			+	+	+	+
All	Both u or U and l or L				+		+
Decimal	ll or LL					+	+ ¹
Octal, Hex	ll or LL					+	+
All	Both u or U and ll or LL						+

Note:

- [C++11](#) The compiler does not support this type if the extended integer safe behavior is enabled.

Decimal integer literals

A *decimal integer literal* contains any of the digits 0 through 9. The first digit cannot be 0. Integer literals beginning with the digit 0 are interpreted as an octal integer literal rather than as a decimal integer literal.

Decimal integer literal syntax



See the following examples of decimal literals:

```
485976
5
```

A plus (+) or minus (-) symbol can precede a decimal integer literal. The operator is treated as a unary operator rather than as part of the literal. Consider the following example:

```
-433132211
+20
```

Hexadecimal integer literals

A *hexadecimal integer literal* begins with the 0 digit followed by either an x or X, followed by any combination of the digits 0 through 9 and the letters a through f or A through F. The letters A (or a) through F (or f) represent the values 10 through 15, respectively.

Hexadecimal integer literal syntax



See the following examples of hexadecimal integer literals:

```
0x3b24
0XF96
0x21
0x3AA
0X29b
0X4bD
```

Octal integer literals

An *octal integer literal* begins with the digit 0 and contains any of the digits 0 through 7.

Octal integer literal syntax



See the following examples of octal integer literals:

```
0
0125
034673
03245
```

Related reference:

“Integral types” on page 62

“Integral conversions” on page 148

“Integral and floating-point promotions” on page 153

 See `-qlanglvl` in the XL C/C++ Compiler Reference

“C++11 compatibility” on page 519

Boolean literals

C At the C99 level, C defines `true` and `false` as macros in the header file `stdbool.h`.

C++ There are only two Boolean literals: `true` and `false`.

Related reference:

“Boolean types” on page 63

“Boolean conversions” on page 148

Floating-point literals

Floating-point literals are numbers that have a decimal point or an exponential part. They can be represented as:

- Real literals
 - Binary floating-point literals
 - Hexadecimal floating-point literals
 -  Decimal floating-point literals (IBM extension)
- Complex literals

Binary floating-point literals

A real binary floating-point constant consists of the following:

- An integral part
- A decimal point
- A fractional part
- An exponent part
- An optional suffix

Both the integral and fractional parts are made up of decimal digits. You can omit either the integral part or the fractional part, but not both. You can omit either the decimal point or the exponent part, but not both.

Binary floating-point literal syntax

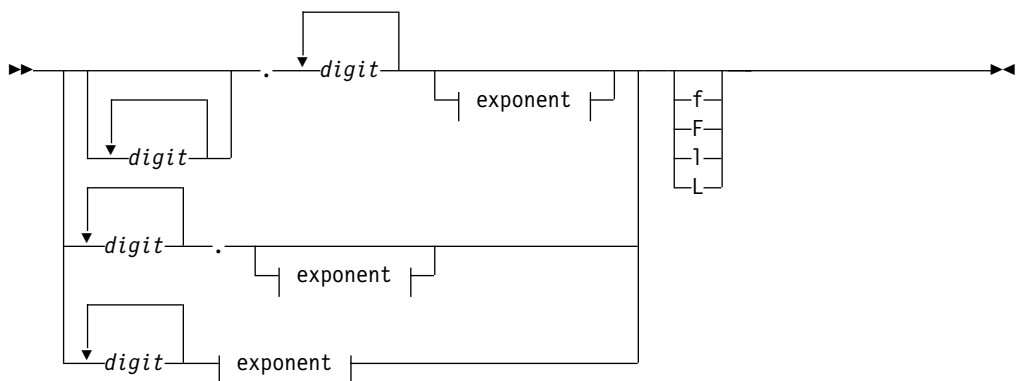

Exponent:





The suffix `f` or `F` indicates a type of float, and the suffix `l` or `L` indicates a type of long double. If a suffix is not specified, the floating-point constant has a type double.

A plus (+) or minus (-) symbol can precede a floating-point literal. However, it is not part of the literal; it is interpreted as a unary operator.

The following are examples of floating-point literals:

floating-point constant	Value
5.3876e4	53,876
4e-11	0.00000000004
1e+5	100000
7.321E-3	0.007321
3.2E+4	32000
0.5e-6	0.0000005
0.45	0.45
6.e10	60000000000

Hexadecimal floating-point literals

Real hexadecimal floating-point constants, which are a C99 feature, consist of the following parts.  The XL C/C++ compiler supports this feature as an IBM extension. 

- a hexadecimal prefix
- a significant part
- a binary exponent part
- an optional suffix

The significant part represents a rational number and is composed of the following:

- a sequence of hexadecimal digits (whole-number part)
- an optional fraction part

The optional fraction part is a period followed by a sequence of hexadecimal digits.

The exponent part indicates the power of 2 to which the significant part is raised, and is an optionally signed decimal integer. The type suffix is optional. The full syntax is as follows:

Hexadecimal floating-point literal syntax

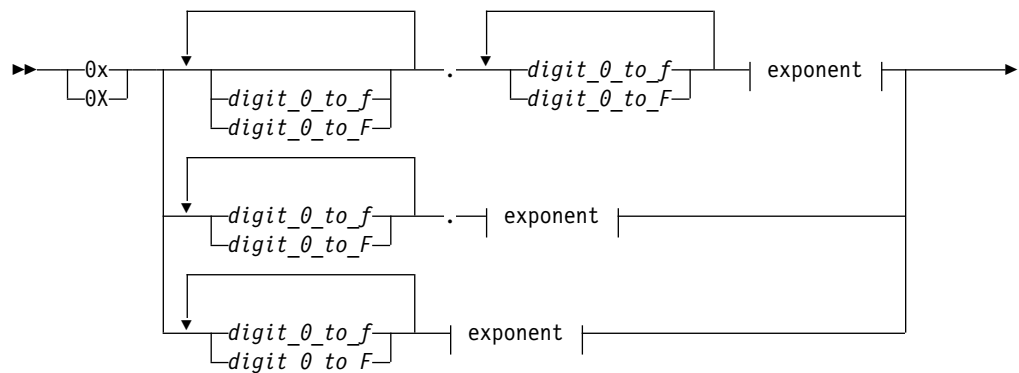



Exponent:



The suffix *f* or *F* indicates a type of float, and the suffix *l* or *L* indicates a type of long double. If a suffix is not specified, the floating-point constant has a type double. You can omit either the whole-number part or the fraction part, but not both. The binary exponent part is required to avoid the ambiguity of the type suffix *F* being mistaken for a hexadecimal digit.

Decimal floating-point literals (IBM extension)

A real decimal floating-point constant consists of the following:

- An integral part
- A decimal point
- A fractional part
- An exponent part
- An optional suffix

Both the integral and fractional parts are made up of decimal digits. You can omit either the integral part or the fractional part, but not both. You can omit either the decimal point or the exponent part, but not both.

Decimal floating-point literal syntax

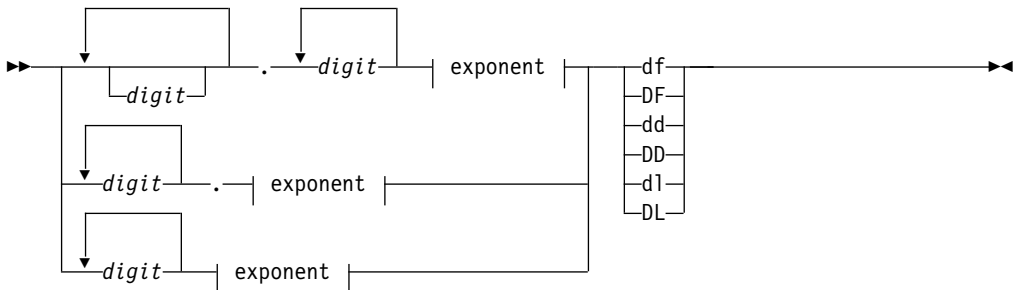

Exponent:



The suffix `df` or `DF` indicates a type of `_Decimal32`, the suffix `dd` or `DD` indicates a type of `_Decimal64`, and the suffix `d1` or `DL` indicates a type of `_Decimal128`. If a suffix is not specified, the floating-point constant has a type `double`.

You cannot use mixed cases in the literal suffix. For example, the suffix `dF` or `Df` is invalid.

The following are examples of decimal floating-point literal declarations:

```
_Decimal32 a = 22.2df;  
_Decimal64 b = 33.3dd;
```

Note: Decimal floating-point literal suffixes are recognized only when the `-qdfp` option is enabled.

Complex literals

Complex literals, which were introduced in the C99 standard, are constructed in two parts: the real part, and the imaginary part.

Complex literal syntax

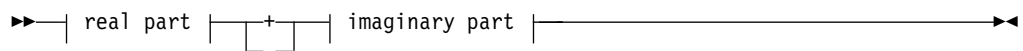

real part:

`floating-point constant`

imaginary part:

`floating-point constant * _Complex_I`

floating-point constant can be specified as a decimal or hexadecimal floating-point literal (including optional suffixes), in any of the formats described in the previous sections.

`_Complex_I` is a macro defined in the `complex.h` header file, representing the imaginary unit *i*, the square root of `-1`.

For example, the declaration:

```
varComplex = 2.0f + 2.0f * _Complex_I;
```

initializes the complex variable `varComplex` to a value of `2.0 + 2.0i`.

IBM For ease of porting applications developed with GNU C, XL C/C++ also allows you to indicate the imaginary part of a complex literal with a suffix, in addition to the standard suffixes that indicate the type of the complex number (float, double, or long double).

The simplified syntax for a complex literal using the GNU suffixes is as follows:

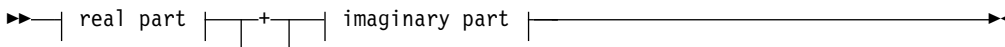

real part:

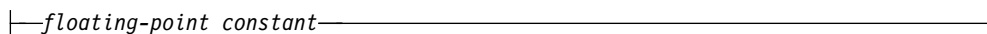

imaginary part:



floating-point constant can be specified as a decimal or hexadecimal floating-point literal (including optional suffixes), in any of the formats described in the previous sections.

imaginary-suffix is one of the suffixes *i*, *I*, *j*, or *J*, representing the imaginary unit.

For example, the declaration

```
varComplex = 3.0f + 4.0fi;
```

initializes the complex variable `varComplex` to a value of `3.0 + 4.0i`. **IBM**

Related reference:

- “Floating-point types” on page 64
- “Floating-point conversions” on page 149
- “Unary expressions” on page 169
- Complex floating-point types

Vector literals (IBM extension)

A vector literal is a constant expression for which the value is interpreted as a vector type. The data type of a vector literal is represented by a parenthesized vector type, and its value is a set of constant expressions that represent the vector elements and are enclosed in parentheses or braces. When all vector elements have the same value, the value of the literal can be represented by a single constant expression. You can initialize vector types with vector literals.

Vector literal syntax

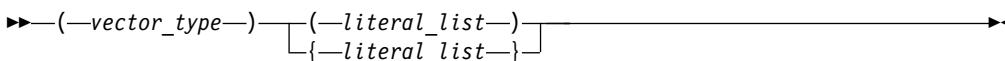

literal_list:



The *vector_type* is a supported vector type; see “Vector types (IBM extension)” on page 66 for a list of these.

The *literal_list* can be either of the following expressions:

- A single expression.

If the single expression is enclosed with parentheses, all elements of the vector are initialized to the specified value. If the single expression is enclosed with braces, the first element of the vector is initialized to the specified value, and the remaining elements of the vector are initialized to 0.

- A comma-separated list of expressions. Each element of the vector is initialized to the respectively specified value.

The number of constant expressions is determined by the type of the vector and whether it is enclosed with braces or parentheses.

If the comma-separated list of expressions is enclosed with braces, the number of constant expressions can be equal to or less than the number of elements in the vector. If the number of constant expressions is less than the number of elements in the vector, the values of the unspecified elements are 0.

If the comma-separated list of expressions is enclosed with parentheses, the number of constant expressions must match the number of elements in the vector as follows:

- 2 For vector long long, vector bool long long, and vector double types.
- 4 For vector int, vector long, and vector float types.
- 8 For vector short and vector pixel types.
- 16 For vector char types.

The following table shows the supported vector literals and how the compiler interprets them to determine their values.

Table 12. Vector literals

Syntax	Interpreted by the compiler as
(vector unsigned char)(unsigned int) (vector unsigned char){unsigned int}	A set of 16 unsigned 8-bit quantities that all have the value of the single integer.
(vector unsigned char)(unsigned int, ...) (vector unsigned char){unsigned int, ...}	A set of 16 unsigned 8-bit quantities with the value specified by each of the 16 integers.
(vector signed char)(int) (vector signed char){int}	A set of 16 signed 8-bit quantities that all have the value of the single integer.
(vector signed char)(int, ...) (vector signed char){int, ...}	A set of 16 signed 8-bit quantities with the value specified by each of the 16 integers.
(vector bool char)(unsigned int) (vector bool char){unsigned int}	A set of 16 unsigned 8-bit quantities that all have the value of the single integer.
(vector bool char)(unsigned int, ...) (vector bool char){unsigned int, ...}	A set of 16 unsigned 8-bit quantities with a value specified by each of 16 integers.

Table 12. Vector literals (continued)

Syntax	Interpreted by the compiler as
(vector unsigned short)(<i>unsigned int</i>) (vector unsigned short){ <i>unsigned int</i> }	A set of 8 unsigned 16-bit quantities that all have the value of the single integer.
(vector unsigned short)(<i>unsigned int, ...</i>) (vector unsigned short){ <i>unsigned int, ...</i> }	A set of 8 unsigned 16-bit quantities with a value specified by each of the 8 integers.
(vector signed short)(<i>int</i>) (vector signed short){ <i>int</i> }	A set of 8 signed 16-bit quantities that all have the value of the single integer.
(vector signed short)(<i>int, ...</i>) (vector signed short){ <i>int, ...</i> }	A set of 8 signed 16-bit quantities with a value specified by each of the 8 integers.
(vector bool short)(<i>unsigned int</i>) (vector bool short){ <i>unsigned int</i> }	A set of 8 unsigned 16-bit quantities that all have the value of the single integer.
(vector bool short)(<i>unsigned int, ...</i>) (vector bool short){ <i>unsigned int, ...</i> }	A set of 8 unsigned 16-bit quantities with a value specified by each of the 8 integers.
(vector unsigned int)(<i>unsigned int</i>) (vector unsigned int){ <i>unsigned int</i> }	A set of 4 unsigned 32-bit quantities that all have the value of the single integer.
(vector unsigned int)(<i>unsigned int, ...</i>) (vector unsigned int){ <i>unsigned int, ...</i> }	A set of 4 unsigned 32-bit quantities with a value specified by each of the 4 integers.
(vector signed int)(<i>int</i>) (vector signed int){ <i>int</i> }	A set of 4 signed 32-bit quantities that all have the value of the single integer.
(vector signed int)(<i>int, ...</i>) (vector signed int){ <i>int, ...</i> }	A set of 4 signed 32-bit quantities with a value specified by each of the 4 integers.
(vector bool int)(<i>unsigned int</i>) (vector bool int){ <i>unsigned int</i> }	A set of 4 unsigned 32-bit quantities that all have the value of the single integer.
(vector bool int)(<i>unsigned int, ...</i>) (vector bool int){ <i>unsigned int, ...</i> }	A set of 4 unsigned 32-bit quantities with a value specified by each of the 4 integers.
(vector unsigned long long)(<i>unsigned long long</i>) (vector unsigned long long){ <i>unsigned long long</i> }	A set of 2 unsigned 64-bit quantities that both have the value of the single long long.
(vector unsigned long long)(<i>unsigned long long, ...</i>) (vector unsigned long long){ <i>unsigned long long, ...</i> }	A set of 2 unsigned 64-bit quantities specified with a value by each of the 2 unsigned long longs.
(vector signed long long)(<i>signed long long</i>) (vector signed long long){ <i>signed long long</i> }	A set of 2 signed 64-bit quantities that both have the value of the single long long.
(vector signed long long)(<i>signed long long, ...</i>) (vector signed long long){ <i>signed long long, ...</i> }	A set of 2 signed 64-bit quantities with a value specified by each of the 2 long longs.
(vector bool long long)(<i>unsigned long long</i>) (vector bool long long){ <i>unsigned long long</i> }	A set of 2 boolean 64-bit quantities with a value specified by the single unsigned long long.

Table 12. Vector literals (continued)

Syntax	Interpreted by the compiler as
(vector bool long long)(<i>unsigned long long</i> , ...) (vector bool long long){ <i>unsigned long long</i> , ...}	A set of 2 boolean 64-bit quantities with a value specified by each of the 2 unsigned long longs.
(vector float)(<i>float</i>) (vector float){ <i>float</i> }	A set of 4 32-bit single-precision floating-point quantities that all have the value of the single float.
(vector float)(<i>float</i> , ...) (vector float){ <i>float</i> , ...}	A set of 4 32-bit single-precision floating-point quantities with a value specified by each of the 4 floats.
(vector double)(<i>double</i>) (vector double){ <i>double</i> }	A set of 2 64-bit double-precision floating-point quantities that both have the value of the single double.
(vector double)(<i>double</i> , <i>double</i>) (vector double){ <i>double</i> , <i>double</i> }	A set of 2 64-bit double-precision floating-point quantities with a value specified by each of the 2 doubles.
(vector pixel)(<i>unsigned int</i>) (vector pixel){ <i>unsigned int</i> }	A set of 8 unsigned 16-bit quantities that all have the value of the single integer.
(vector pixel)(<i>unsigned int</i> , ...) (vector pixel){ <i>unsigned int</i> , ...}	A set of 8 unsigned 16-bit quantities with a value specified by each of the 8 integers.

Note: The value of an element in a vector bool is FALSE if each bit of the element is set to 0 and TRUE if each bit of the element is set to 1.

For example, for an unsigned integer vector type, the literal could be either of the following:

```
(vector unsigned int)(10) /* initializes all four elements to a value of 10 */
(vector unsigned int)(14, 82, 73, 700) /* initializes the first element
to 14, the second element to 82,
the third element to 73, and the
fourth element to 700 */
```

You can cast vector literals with the “Cast operator ()” on page 196. Enclosing the vector literal to be cast in parentheses can improve the readability of the code. For example, you can use the following code to cast a vector signed int literal to a vector unsigned char literal:

```
(vector unsigned char)((vector signed int)(-1, -1, 0, 0))
```

Related reference:

- “Vector types (IBM extension)” on page 66
- “Initialization of vectors (IBM extension)” on page 128

Character literals

A *character literal* contains a sequence of characters or escape sequences enclosed in single quotation mark symbols, for example 'c'. A character literal may be prefixed with the letter L, for example L'c'. A character literal without the L prefix is an *ordinary character literal* or a *narrow character literal*. A character literal with the L prefix is a *wide character literal*. An ordinary character literal that contains more than one character or escape sequence (excluding single quotes (')), backslashes (\) or new-line characters) is a *multicharacter literal*.

C The type of a narrow character literal is `int`. The type of a wide character literal is `wchar_t`. The type of a multicharacter literal is `int`.

C++ The type of a character literal that contains only one character is `char`, which is an integral type. The type of a wide character literal is `wchar_t`. The type of a multicharacter literal is `int`.

Character literal syntax

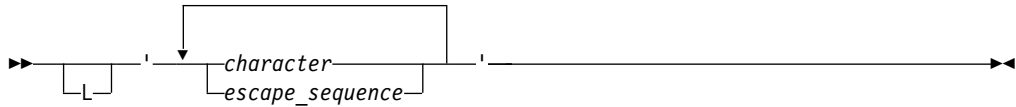

At least one character or escape sequence must appear in the character literal, and the character literal must appear on a single logical source line.

The characters can be from the source program character set. You can represent the double quotation mark symbol by itself, but to represent the single quotation mark symbol, you must use the backslash symbol followed by a single quotation mark symbol (`'` escape sequence). (See “Escape sequences” on page 40 for a list of other characters that are represented by escape characters.)

Outside of the basic source character set, the universal character names for letters and digits are allowed in C++ and at the C99 language level. **C++** In C++, you must compile with the `-q1anglv1=ucs` option for universal character name support.

The following are examples of character literals:

```
'a'  
'\  
L'0'  
'('
```

Related reference:

“Character types” on page 65

“Source program character set” on page 38

“The Unicode standard” on page 41

 See `-q1anglv1` in the XL C/C++ Compiler Reference

String literals

A *string literal* contains a sequence of characters or escape sequences enclosed in double quotation mark symbols. A string literal with the prefix `L` is a *wide string literal*. A string literal without the prefix `L` is an *ordinary* or *narrow string literal*.

C The type of a narrow string literal is array of `char`. The type of a wide string literal is array of `wchar_t`. **C**

C++ The type of a narrow string literal is array of `const char`. The type of a wide string literal is array of `const wchar_t`. Both types have static storage duration. **C++**

String literal syntax



Multiple spaces contained within a string literal are retained.

Use the escape sequence `\n` to represent a new-line character as part of the string. Use the escape sequence `\\` to represent a backslash character as part of the string. You can represent a single quotation mark symbol either by itself or with the escape sequence `\'`. You must use the escape sequence `\"` to represent a double quotation mark.

Outside of the basic source character set, the universal character names for letters and digits are allowed in C++ and at the C99 language level.  In C++, you must compile with the `-q1angl1=ucs` option for universal character name support.



 The Pascal string form of a string literal is also accepted when you compile with the `-qmacpstr` option. 

See the following examples of string literals:

```
char titles[ ] = "Handel's \"Water Music\"";
char *temp_string = "abc" "def" "ghi"; // *temp_string = "abcdefghi\0"
wchar_t *wide_string = L"longstring";
```

This example illustrates escape sequences in string literals:

```
#include <iostream> using namespace std;

int main () {
    char *s = "Hi there! \n";
    cout << s;
    char *p = "The backslash character \\\.";
    cout << p << endl;
    char *q = "The double quotation mark \".\n";
    cout << q ;
}
```

This program produces the following output:

```
Hi there! The backslash character \. The double quotation mark ".
```

To continue a string on the next line, use the line continuation character (`\` symbol) followed by optional whitespace and a new-line character (required). For example:

```
char *mail_addr = "Last Name   First Name   MI   Street Address \
893   City   Province   Postal code ";
```

Note: When a string literal appears more than once in the program source, how that string is stored depends on whether strings are read-only or writable. By default, the compiler considers strings to be read-only. XL C/C++ might allocate only one location for a read-only string; all occurrences refer to that one location. However, that area of storage is potentially write-protected. If strings are writable, then each occurrence of the string has a separate, distinct storage location that is always modifiable. You can use the `#pragma strings` directive or the `-qro` compiler option to change the default storage for string literals.

String concatenation

Another way to continue a string is to have two or more consecutive strings. Adjacent string literals can be concatenated to produce a single string. For example:





```
"hello " "there"    //equivalent to "hello there"
"hello" "there"    //equivalent to "hellothere"
```

Characters in concatenated strings remain distinct. For example, the strings `"\xab"` and `"3"` are concatenated to form `"\xab3"`. However, the characters `\xab` and `3` remain distinct and are not merged to form the hexadecimal character `\xab3`.

If a wide string literal and a narrow string literal are adjacent, as in the following example:

```
"hello " L"there"
```

the result is a wide string literal.

Note:  In C99, narrow strings can be concatenated with wide string literals.   In C++11, the changes to string literal concatenation in the C99 preprocessor are adopted to provide a common preprocessor interface for C and C++ compilers. Narrow strings can be concatenated with wide string literals in C++11. For more information, see “C99 preprocessor features adopted in C++11” on page 506. 

Following any concatenation, `'\0'` of type `char` is appended at the end of each string. For a wide string literal, `'\0'` of type `wchar_t` is appended. By convention, programs recognize the end of a string by finding the null character. For example:

```
char *first = "Hello ";           //stored as "Hello \0"
char *second = "there";          //stored as "there\0"
char *third = "Hello " "there";  //stored as "Hello there\0"
```

Related reference:

“Character types” on page 65

“Source program character set” on page 38

“The Unicode standard” on page 41

String concatenation of u-literals



See `-qlanglvl` in the XL C/C++ Compiler Reference



See `-qmacpstr` in the XL C/C++ Compiler Reference



See `-qro` in the XL C/C++ Compiler Reference



See `#pragma strings` in the XL C/C++ Compiler Reference

Pointer literal (C++11)

The only pointer literal is the `nullptr` keyword that is a prvalue of type `std::nullptr_t`. A prvalue of this type is a null pointer constant that can be converted to any pointer type, pointer-to-member type, or `bool` type.

Related reference:

“Null pointers” on page 118

“Pointer conversions” on page 156

Punctuators and operators

A *punctuator* is a token that has syntactic and semantic meaning to the compiler, but the exact significance depends on the context. A punctuator can also be a token that is used in the syntax of the preprocessor.

C99 and C++ define the following tokens as punctuators, operators, or preprocessing tokens:

Table 13. C and C++ punctuators

[]	()	{ }	,	:	;
*	=	...	#		
.	->	++	--	##	
&	+	-	~	!	
/	%	<<	>>	!=	
<	>	<=	>=	==	
^		&&		?	
*=	/=	%=	+=	-=	
<<=	>>=	&t=	^=	=	

C++ In addition to the C99 preprocessing tokens, operators, and punctuators, C++ allows the following tokens as punctuators:

Table 14. C++ punctuators

::	.*	->*	new	delete	
and	and_eq	bitand	bitor	comp	
not	not_eq	or	or_eq	xor	xor_eq

C++

Alternative tokens

Both C and C++ provide the following alternative representations for some operators and punctuators. The alternative representations are also known as *digraphs*.

Operator or punctuator	Alternative representation
{	<%
}	%>
[<:
]	:>
#	%:
##	%:%:

In addition to the operators and punctuators listed above, C++ and C at the C99 language level provide the following alternative representations. In C, they are defined as macros in the header file `iso646.h`.

Operator or punctuator	Alternative representation
&&	and
	bitor
	or

Operator or punctuation	Alternative representation
<code>^</code>	<code>xor</code>
<code>~</code>	<code>compl</code>
<code>&</code>	<code>bitand</code>
<code>&=</code>	<code>and_eq</code>
<code> =</code>	<code>or_eq</code>
<code>^=</code>	<code>xor_eq</code>
<code>!</code>	<code>not</code>
<code>!=</code>	<code>not_eq</code>

Related reference:

- “Digraph characters” on page 42
- “Boolean types” on page 63
- “Boolean conversions” on page 148
- “Floating-point types” on page 64
- “Floating-point conversions” on page 149
- “Unary expressions” on page 169
- “Vector types (IBM extension)” on page 66
- “Initialization of vectors (IBM extension)” on page 128
- “Source program character set”
- “The Unicode standard” on page 41
- “Character types” on page 65
- Chapter 7, “Expressions and operators,” on page 159

Source program character set

See the following list of the basic source character sets that are available at both compile time and run time:

- The uppercase and lowercase letters of the English alphabet:
`a b c d e f g h i j k l m n o p q r s t u v w x y z`
`A B C D E F G H I J K L M N O P Q R S T U V W X Y Z`
- The decimal digits:
`0 1 2 3 4 5 6 7 8 9`
- The following graphic characters:
`! " # % & ' () * + , - . / : ; < = > ? [\] _ { } ~`
 - The caret (^) character in ASCII (bitwise exclusive OR symbol).
 - The split vertical bar (!) character in ASCII.
- The space character
- The control characters representing new-line, horizontal tab, vertical tab, form feed, end of string (NULL character), alert, backspace, and carriage return.

 Depending on the compiler option, other specialized identifiers, such as the dollar sign (\$) or characters in national character sets, may be allowed to appear in an identifier.

Related reference:

Characters in identifiers

Multibyte characters

The compiler recognizes and supports the additional characters (the extended character set) which you can meaningfully use in string literals and character constants. The support for extended characters includes *multibyte character* sets. A *multibyte character* is a character whose bit representation fits into more than one byte. To instruct the compiler to recognize multibyte character sets as source input, be sure to compile with the `-qmbcs` option.

Multibyte characters can appear in any of the following contexts:

- String literals and character constants. To declare a multibyte literal, use a wide-character representation, prefixed by `L`. For example:

```
wchar_t *a = L"wide_char_string";  
wchar_t b = L'wide_char';
```

Strings containing multibyte characters are treated essentially the same way as strings without multibyte characters. Generally, wide characters are permitted anywhere multibyte characters are, but they are incompatible with multibyte characters in the same string because their bit patterns differ. Wherever permitted, you can mix single-byte and multibyte characters in the same string.

- Preprocessor directives. The following preprocessor directives permit multibyte-character constants and string literals:

- `#define`
- `#pragma comment`
- `#include`

A file name specified in an `#include` directive can contain multibyte characters. For example:

```
#include <multibyte_char/mydir/mysource/multibyte_char.h>  
#include "multibyte_char.h"
```

- Macro definitions. Because string literals and character constants can be part of `#define` statements, multibyte characters are also permitted in both object-like and function-like macro definitions.
- The `#` and `##` operators.
- Program comments.

The following are restrictions on the use of multibyte characters:

- Multibyte characters are not permitted in identifiers.
- Hexadecimal values for multibyte characters must be in the range of the code page being used.
- You cannot mix wide characters and multibyte characters in macro definitions. For example, a macro expansion that concatenates a wide string and a multibyte string is not permitted.
- Assignment between wide characters and multibyte characters is not permitted.
- Concatenating wide character strings and multibyte character strings is not permitted.

Related reference:

Character literals

“The Unicode standard” on page 41

“Character types” on page 65



See `-qmbcs` in the XL C/C++ Compiler Reference

Escape sequences

You can represent any member of the execution character set by an *escape sequence*. They are primarily used to put nonprintable characters in character and string literals. For example, you can use escape sequences to put such characters as tab, carriage return, and backspace into an output stream.

Escape character syntax

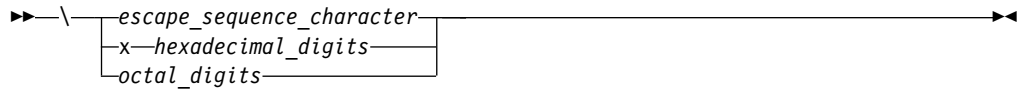

An escape sequence contains a backslash (\) symbol followed by one of the escape sequence characters or an octal or hexadecimal number. A hexadecimal escape sequence contains an x followed by one or more hexadecimal digits (0-9, A-F, a-f). An octal escape sequence uses up to three octal digits (0-7). The value of the hexadecimal or octal number specifies the value of the wanted character or wide character.

Note: The line continuation sequence (\ followed by a new-line character) is not an escape sequence. It is used in character strings to indicate that the current line of source code continues on the next line.

The escape sequences and the characters they represent are:

Escape sequence	Character represented
<code>\a</code>	Alert (bell, alarm)
<code>\b</code>	Backspace
<code>\f</code>	Form feed (new page)
<code>\n</code>	New-line
<code>\r</code>	Carriage return
<code>\t</code>	Horizontal tab
<code>\v</code>	Vertical tab
<code>\'</code>	Single quotation mark
<code>\"</code>	Double quotation mark
<code>\?</code>	Question mark
<code>\\</code>	Backslash

The value of an escape sequence represents the member of the character set used at run time. Escape sequences are translated during preprocessing. For example, on a system using the ASCII character codes, the value of the escape sequence `\x56` is the letter V. On a system using EBCDIC character codes, the value of the escape sequence `\xE5` is the letter V.

Use escape sequences only in character constants or in string literals. An error message is issued if an escape sequence is not recognized.

In string and character sequences, when you want the backslash to represent itself (rather than the beginning of an escape sequence), you must use a `\\` backslash escape sequence. For example:

```
cout << "The escape sequence \\n." << endl;
```



This statement results in the following output:

The escape sequence `\n`.

The Unicode standard

The *Unicode Standard* is the specification of an encoding scheme for written characters and text. It is a universal standard that enables consistent encoding of multilingual text and allows text data to be interchanged internationally without conflict. The ISO standards for C and C++ refer to *Information technology – Programming Languages – Universal Multiple-Octet Coded Character Set (UCS), ISO/IEC 10646:2003*. (The term *octet* is used by ISO to refer to a byte.) The ISO/IEC 10646 standard is more restrictive than the Unicode Standard in the number of encoding forms: a character set that conforms to ISO/IEC 10646 is also conformant to the Unicode Standard.

The Unicode Standard specifies a unique numeric value and name for each character and defines three encoding forms for the bit representation of the numeric value. The name/value pair creates an identity for a character. The hexadecimal value representing a character is called a *code point*. The specification also describes overall character properties, such as case, directionality, alphabetic properties, and other semantic information for each character. Modeled on ASCII, the Unicode Standard treats alphabetic characters, ideographic characters, and symbols, and allows implementation-defined character codes in reserved code point ranges. According to the Unicode Standard, the encoding scheme of the standard is therefore sufficiently flexible to handle all known character encoding requirements, including coverage of all the world's historical scripts.

C99 allows the universal character name construct defined in ISO/IEC 10646 to represent characters outside the basic source character set. It permits universal character names in identifiers, character constants, and string literals.  To be compatible with C99, the XL C/C++ compiler supports universal character names as an IBM extension. In C++, you must compile with the `-q1anglvl=ucs` option for universal character name support. 

The following table shows the generic universal character name construct and how it corresponds to the ISO/IEC 10646 short name.

Universal character name	ISO/IEC 10646 short name
<i>where N is a hexadecimal digit</i>	
<code>\UNNNNNNNN</code>	NNNNNNNN
<code>\uNNNN</code>	000NNNN

C99 and C++ disallow the hexadecimal values representing characters in the basic character set (base source code set) and the code points reserved by ISO/IEC 10646 for control characters.

The following characters are also disallowed:

- Any character whose short identifier is less than 00A0. The exceptions are 0024 (\$), 0040 (@), or 0060 (').
- Any character whose short identifier is in the code point range D800 through DFFF inclusive.

UTF literals (IBM extension)

The ISO C and ISO C++ Committees have approved the implementation of *u-literals* and *U-literals* to support Unicode UTF-16 and UTF-32 character literals, respectively.

The following table shows the syntax for UTF literals.

Table 15. UTF literals

Syntax	Explanation
<code>u'character'</code>	Denotes a UTF-16 character.
<code>u"character-sequence"</code>	Denotes an array of UTF-16 characters.
<code>U'character'</code>	Denotes a UTF-32 character.
<code>U"character-sequence"</code>	Denotes an array of UTF-32 characters.

String concatenation of u-literals

The u-literals and U-literals follow the same concatenation rule as wide character literals: the normal character string is widened if they are present. The following shows the allowed combinations. All other combinations are invalid.

Combination	Result
<code>u"a" u"b"</code>	<code>u"ab"</code>
<code>u"a" "b"</code>	<code>u"ab"</code>
<code>"a" u"b"</code>	<code>u"ab"</code>
<code>U"a" U"b"</code>	<code>U"ab"</code>
<code>U"a" "b"</code>	<code>U"ab"</code>
<code>"a" U"b"</code>	<code>U"ab"</code>

Multiple concatenations are allowed, with these rules applied recursively.

Related reference:

 See `-qutf` in the XL C/C++ Compiler Reference

String concatenation

Digraph characters

You can represent unavailable characters in a source program by using a combination of two keystrokes that are called a *digraph character*. The preprocessor reads digraphs as tokens during the preprocessor phase.

The digraph characters are:

<code>#: or %%%</code>	<code>#</code>	number sign
<code><:</code>	<code>[</code>	left bracket
<code>:></code>	<code>]</code>	right bracket
<code><%</code>	<code>{</code>	left brace
<code>%></code>	<code>}</code>	right brace
<code>%%: or %%%%</code>	<code>##</code>	preprocessor macro concatenation operator

You can create digraphs by using macro concatenation. XL C/C++ does not replace digraphs in string literals or in character literals. For example:

```
char *s = "<%%>; // stays "<%%>"

switch (c) {
  case '<%': { /* ... */ } // stays '<%'
  case '%>': { /* ... */ } // stays '%>'
}
```

Related reference:



See `-qdigraph` in the XL C/C++ Compiler Reference

Trigraph sequences

Some characters from the C and C++ character set are not available in all environments. You can enter these characters into a C or C++ source program using a sequence of three characters called a *trigraph*. The trigraph sequences are:

Trigraph	Single character	Description
??=	#	pound sign
??([left bracket
??)]	right bracket
??<	{	left brace
??>	}	right brace
??/	\	backslash
??'	^	caret
??!		vertical bar
??-	~	tilde

The preprocessor replaces trigraph sequences with the corresponding single-character representation. For example,

```
some_array??(i??) = n;
```

Represents:

```
some_array[i] = n;
```

Comments

A *comment* is text replaced during preprocessing by a single space character; the compiler therefore ignores all comments.

There are two kinds of comments:

- The `/*` (slash, asterisk) characters, followed by any sequence of characters (including new lines), followed by the `*/` characters. This kind of comment is commonly called a *C-style comment*.
- The `//` (two slashes) characters followed by any sequence of characters. A new line not immediately preceded by a backslash terminates this form of comment. This kind of comment is commonly called a *single-line comment* or a *C++ comment*. A C++ comment can span more than one physical source line if it is joined into one logical source line with line-continuation (`\`) characters. The backslash character can also be represented by a trigraph.

You can put comments anywhere the language allows white space. You cannot nest C-style comments inside other C-style comments. Each comment ends at the first occurrence of `*/`.

You can also include multibyte characters; to instruct the compiler to recognize multibyte characters in the source code, compile with the **-qmbcs** option.

Note: The `/*` or `*/` characters found in a character constant or string literal do not start or end comments.

In the following program, the second `printf()` is a comment:

```
#include <stdio.h>

int main(void)
{
    printf("This program has a comment.\n");
    /* printf("This is a comment line and will not print.\n"); */
    return 0;
}
```

Because the second `printf()` is equivalent to a space, the output of this program is:

This program has a comment.

Because the comment delimiters are inside a string literal, `printf()` in the following program is not a comment.

```
#include <stdio.h>

int main(void)
{
    printf("This program does not have \
/* NOT A COMMENT */ a comment.\n");
    return 0;
}
```

The output of the program is:

This program does not have
/* NOT A COMMENT */ a comment.

In the following example, the comments are highlighted:

/* A program with nested comments. */

```
#include <stdio.h>

int main(void)
{
    test_function();
    return 0;
}

int test_function(void)
{
    int number;
    char letter;
    /*
    number = 55;
    letter = 'A';
    /* number = 44; */
    */
    return 999;
}
```

In `test_function`, the compiler reads the first `/*` through to the first `*/`. The second `*/` causes an error. To avoid commenting over comments already in the source code, you should use conditional compilation preprocessor directives to cause the

compiler to bypass sections of a program. For example, instead of commenting out the above statements, change the source code in the following way:

```
/* A program with conditional compilation to avoid nested comments. */

#define TEST_FUNCTION 0
#include <stdio.h>

int main(void)
{
    test_function();
    return 0;
}

int test_function(void)
{
    int number;
    char letter;
    #if TEST_FUNCTION
        number = 55;
        letter = 'A';
        /*number = 44;*/
    #endif /*TEST_FUNCTION */
}
```

You can nest single line comments within C-style comments. For example, the following program will not output anything:

```
#include <stdio.h>

int main(void)
{
    /*
    printf("This line will not print.\n");
    // This is a single line comment
    // This is another single line comment
    printf("This line will also not print.\n");
    */
    return 0;
}
```

Note: You can also use the **#pragma comment** directive to place comments into an object module.

Related reference:



See `-qmbcs` in the XL C/C++ Compiler Reference



See `-qlanglvl` in the XL C/C++ Compiler Reference



See `-qcpluscmt` in the XL C/C++ Compiler Reference
“Multibyte characters” on page 39

Chapter 4. Data objects and declarations

The topics in this chapter discuss the various elements that constitute a declaration of a data object.

Topics are sequenced to loosely follow the order in which elements appear in a declaration. The discussion of the additional elements of data declarations is also continued in Chapter 5, “Declarators,” on page 111.

Overview of data objects and declarations

The following sections introduce some fundamental concepts regarding data objects and data declarations that will be used throughout this reference.

Overview of data objects

A data *object* is a region of storage that contains a value or group of values. Each value can be accessed using its identifier or a more complex expression that refers to the object. In addition, each object has a unique *data type*. The data type of an object determines the storage allocation for that object and the interpretation of the values during subsequent access. It is also used in any type checking operations. Both the identifier and data type of an object are established in the object *declaration*.

 An instance of a class type is commonly called a *class object*. The individual class members are also called objects.

Data types are often grouped into type categories that overlap, such as:

Fundamental types versus derived types

Fundamental data types are also known as "basic", "fundamental" or "built-in" to the language. These include integers, floating-point numbers, and characters. *Derived* types, also known as "compound" types in Standard C++, are created from the set of basic types, and include arrays, pointers, structures, unions, enumerations, and vectors. All C++ classes are considered compound types.

Built-in types versus user-defined types

Built-in data types include all of the fundamental types, plus types that refer to the addresses of basic types, such as arrays and pointers.



User-defined types are created by the user from the set of basic types, in typedef, structure, union, and enumeration definitions. C++ classes are considered user-defined types.

Scalar types versus aggregate types



Scalar types represent a single data value, while *aggregate* types represent multiple values, of the same type or of different types. Scalars include the arithmetic types and pointers. Aggregate types include arrays, structures, and vectors. C++ classes are considered aggregate types.

The following matrix lists the supported data types and their classification into fundamental, derived, scalar, and aggregate types.

Table 16. C/C++ data types



Data object	Basic	Compound	Built-in	User-defined	Scalar	Aggregate
integer types	+		+		+	
floating-point types ¹	+		+		+	
character types			+		+	
Booleans	+		+		+	
void type	+ ²		+		+	
pointers		+	+		+	
arrays		+	+			+
structures		+		+		+
unions		+		+		
enumerations		+		+	see note ³	
 classes		+		+		+
 vector types			+			+

Note:

1. Although complex floating-point types are represented internally as an array of two elements, they behave in the same way as real floating-pointing types in terms of alignment and arithmetic operations, and can therefore be considered scalar types.
2. The void type is really an incomplete type, as discussed in “Incomplete types.” Nevertheless, Standard C++ defines it as a fundamental type.
3.  The C standard does not classify enumerations as either scalar or aggregate.  Standard C++ classifies enumerations as scalars.

Incomplete types

The following are incomplete types:

- The void type
- Arrays of unknown size
- Arrays of elements that are of incomplete type
- Structure, union, or enumerations that have no definition
-  Pointers to class types that are declared but not defined
-  Classes that are declared but not defined

However, if an array size is specified by `[*]`, indicating a variable length array, the size is considered as having been specified, and the array type is then considered a complete type. For more information, see “Variable length arrays” on page 122.

The following examples illustrate incomplete types:

```
void *incomplete_ptr;
struct dimension linear; /* no previous definition of dimension */
```

Compatible and composite types

➤ C

In C, compatible types are defined as:

- two types that can be used together without modification (as in an assignment expression)
- two types that can be substituted one for the other without modification

A *composite type* is constructed from two compatible types. Determining the resultant composite type for two compatible types is similar to following the usual binary conversions of integral types when they are combined with some arithmetic operators.

Obviously, two types that are identical are compatible; their composite type is the same type. Less obvious are the rules governing type compatibility of non-identical types, user-defined types, type-qualified types, and so on. “Type specifiers” on page 61 discusses compatibility for basic and user-defined types in C.

➤ C

➤ C++ A separate notion of type compatibility as distinct from being of the same type does not exist in C++. Generally speaking, type checking in C++ is stricter than in C: identical types are required in situations where C would only require compatible types.

Related reference:

Chapter 12, “Classes (C++ only),” on page 325

“The void type” on page 66

“Incomplete class declarations” on page 330

“Compatibility of arrays” on page 123

“Compatibility of pointers (C only)” on page 117

“Compatible functions (C only)” on page 252

Overview of data declarations and definitions

A *declaration* establishes the names and characteristics of data objects used in a program. A *definition* allocates storage for data objects, and associates an identifier with that object. When you declare or define a *type*, no storage is allocated.

The following table shows examples of declarations and definitions. The identifiers declared in the first column do not allocate storage; they refer to a corresponding definition. The identifiers declared in the second column allocate storage; they are both declarations and definitions.

Declarations	Declarations and definitions
<code>extern double pi;</code>	<code>double pi = 3.14159265;</code>
<code>struct payroll;</code>	<code>struct payroll { char *name; float salary; } employee;</code>

Note: C The C99 standard no longer requires that all declarations appear at the beginning of a function before the first statement. C++ As in C++, you can mix declarations with other statements in your code.

Declarations determine the following properties of data objects and their identifiers:

- Scope, which describes the region of program text in which an identifier can be used to access its object
- Visibility, which describes the region of program text from which legal access can be made to the identifier's object
- Duration, which defines the period during which the identifiers have real, physical objects allocated in memory
- Linkage, which describes the correct association of an identifier to one particular object
- Type, which determines how much memory is allocated to an object and how the bit patterns found in the storage allocation of that object should be interpreted by the program

The elements of a declaration for a data object are as follows:

- “Storage class specifiers” on page 54, which specify storage duration and linkage
- “Type specifiers” on page 61, which specify data types
- “Type qualifiers” on page 98, which specify the mutability of data values
- Declarators, which introduce and include identifiers
- “Initializers” on page 124, which initialize storage with initial values

IBM In addition, for compatibility with GCC, XL C/C++ allows you to use *attributes* to modify the properties of data objects. *Type attributes*, which can be used to modify the definition of user-defined types, are described in “Type attributes (IBM extension)” on page 104. *Variable attributes*, which can be used to modify the declaration of variables, are described in “Variable attributes (IBM extension)” on page 140. IBM

All declarations have the form:

Data declaration syntax

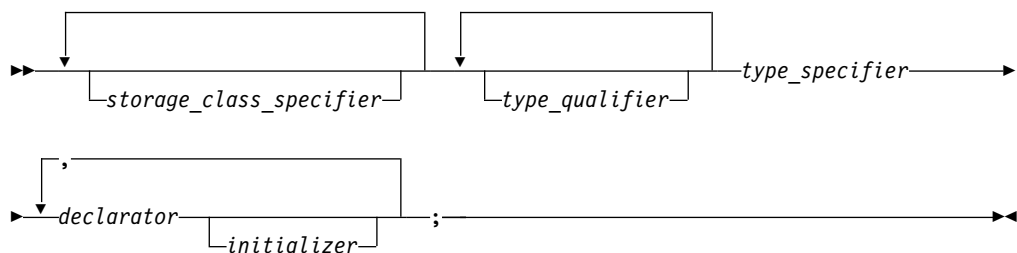

Tentative definitions

C A *tentative definition* is any external data declaration that has no storage class specifier and no initializer. A tentative definition becomes a full definition if the end of the translation unit is reached and no definition has appeared with an initializer for the identifier. In this situation, the compiler reserves uninitialized space for the object defined.

C The following statements show normal definitions and tentative definitions.

```
int i1 = 10;          /* definition, external linkage */
static int i2 = 20;  /* definition, internal linkage */
extern int i3 = 30;  /* definition, external linkage */
int i4;              /* tentative definition, external linkage */
static int i5;       /* tentative definition, internal linkage */

int i1;              /* valid tentative definition */
int i2;              /* not legal, linkage disagreement with previous */
int i3;              /* valid tentative definition */
int i4;              /* valid tentative definition */
int i5;              /* not legal, linkage disagreement with previous */
```

C++ C++ does not support the concept of a tentative definition: an external data declaration without a storage class specifier is always a definition.

Related reference:

“Function declarations and definitions” on page 247

_Static_assert declaration (C11)

Note: IBM supports selected features of C11, known as C1X before its ratification. IBM will continue to develop and implement the features of this standard. The implementation of the language level is based on IBM's interpretation of the standard. Until IBM's implementation of all the C11 features is complete, including the support of a new C11 standard library, the implementation may change from release to release. IBM makes no attempt to maintain compatibility, in source, binary, or listings and other compiler interfaces, with earlier releases of IBM's implementation of the C11 features.

Static assertions can be declared to detect and diagnose common usage errors at compile time. A `_Static_assert` declaration takes the following form:

_Static_assert declaration syntax

```
▶▶ _Static_assert—(—constant_expression—, —string_literal—)—; ▶▶
```

The *constant_expression* must be an integer constant expression. If the integer constant expression evaluates to 0, the compiler issues a severe error containing the *string_literal* with the source location of the `_Static_assert` declaration. Otherwise, the `_Static_assert` declaration has no effect.

The declaration of static assertions does not declare a new type or object, and does not imply any size or time cost at run time.

`static_assert` is a macro defined in `assert.h` for C.

The addition of static assertions to the C language has the following benefits:

- Libraries can detect common usage errors at compile time.
- Implementations of the C Standard Library can detect and diagnose common usage errors, improving usability.

You can declare static assertions to check important program invariants at compile time.

Examples: `_Static_assert` declaration

Example 1: The following example demonstrates the use of a `_Static_assert` declaration inside a structure.

```
#include <stddef.h>
struct __attribute__((packed)) B{
    char a;
    int i;
};

struct A{
    struct B b;
    _Static_assert(offsetof(struct B,i)==1,"S not packed");
};
```

Example 2: The following example contains static assertions declared with `static_assert`, so the `assert.h` header file must be included.

```
/* static_assert requires <assert.h> */
#include <assert.h>
static_assert(sizeof(long) >= 8, "64-bit not enabled.");
```

Example 3: The following example shows the use of a `_Static_assert` declaration with an invalid constant expression.

```
_Static_assert(1 / 0, "never shows up!");
```

When you compile this program, the compiler does not show the *string literal* in the `_Static_assert` declaration. Instead, the compiler issues an error message indicating that the divisor cannot be zero.

Related reference:

“C11 compatibility” on page 512

static_assert declaration (C++11)

Note: IBM supports selected features of C++11, known as C++0x before its ratification. IBM will continue to develop and implement the features of this standard. The implementation of the language level is based on IBM's interpretation of the standard. Until IBM's implementation of all the C++11 features is complete, including the support of a new C++11 standard library, the implementation might change from release to release. IBM makes no attempt to maintain compatibility, in source, binary, or listings and other compiler interfaces, with earlier releases of IBM's implementation of the new C++11 features.

Static assertions can be declared to detect and diagnose common usage errors at compile time. A `static_assert` declaration takes the following form:

static_assert declaration syntax

```
▶▶—static_assert—(—constant_expression—,—string_literal—)—;————▶▶
```

The *constant_expression* must be a constant expression that can be contextually converted to `bool`. If the value of the expression converted in such a way is false, the compiler issues a severe error containing the *string literal* with the source location of the `static_assert` declaration. Otherwise, the `static_assert` declaration has no effect.

You can declare static assertions anywhere that you use a using declaration, including namespace scope, block scope, and class member declaration lists.

The declaration of static assertions does not declare a new type or object, and does not imply any size or time cost at run time.

The C++ programming language also supports the `_Static_assert` keyword in all language levels for improved compatibility with the C programming language.

The addition of static assertions to the C++ language has the following benefits:

- Libraries can detect common usage errors at compile time.
- Implementations of the C++ Standard Library can detect and diagnose common usage errors, improving usability.

You can declare static assertions to check important program invariants at compile time.

Examples: `static_assert` declaration

The following example illustrates the use of a `static_assert` declaration in namespace scope.

```
static_assert(sizeof(long) >= 8, "64-bit code generation not
enabled/supported.");
```

The following example demonstrates the use of a `static_assert` declaration in class scope, with templates.

```
#include <type_traits>
#include <string>

template<typename T>
struct X {
    static_assert(std::tr1::is_pod<T>::value, "POD required to
instantiate class template X.");
    // ...
};

int main() {
    X<std::string> x;
}
```

The following example demonstrates the use of a `static_assert` declaration in block scope, with templates:

```
template <typename T, int N>
void f() {
    static_assert (N >=0, "length of array a is negative.");
    T a[N];
    // ...
}

int main() {
    f<int, -1>();
}
```

The following example shows the use of a `static_assert` declaration with an invalid constant expression.

```
static_assert(1 / 0, "never shows up!");
```

When you compile this program, the compiler does not show the *string literal* in the `static_assert` declaration. Instead, the compiler issues an error message indicating that the divisor cannot be zero.

Related reference:

“C++11 compatibility” on page 519

Storage class specifiers

A storage class specifier is used to refine the declaration of a variable, a function, and parameters. Storage classes determine whether:

- The object has internal, external, or no linkage
- The object is to be stored in memory or in a register, if available
- The object receives the default initial value of 0 or an indeterminate default initial value
- The object can be referenced throughout a program or only within the function, block, or source file where the variable is defined
- The storage duration for the object is maintained throughout program run time or only during the execution of the block where the object is defined

For a variable, its default storage duration, scope, and linkage depend on where it is declared: whether inside or outside a block statement or the body of a function. When these defaults are not satisfactory, you can use a storage class specifier to explicitly set its storage class.

C++11

In C++11, the keyword `auto` is no longer used as a storage class specifier. Instead, it is used as a type specifier. The compiler deduces the type of an `auto` variable from the type of its initializer expression. For more information, see “The `auto` type specifier (C++11)” on page 89.

The keyword `extern` was previously used as a storage specifier or as part of a linkage specification. The C++11 standard adds a third usage to use this keyword to specify explicit instantiation declarations. For more information, see “Explicit instantiation” on page 434.

C++11

The storage class specifiers in C and C++ are:

- `auto`
- `static`
- `extern`
- **C++** `mutable`
- `register`
- **IBM** `__thread`

Related reference:

“Function storage class specifiers” on page 254

“Initializers” on page 124

The auto storage class specifier

The auto storage class specifier lets you explicitly declare a variable with *automatic storage*. The auto storage class is the default for variables declared inside a block. A variable `x` that has automatic storage is deleted when the block in which `x` was declared exits.

You can only apply the auto storage class specifier to names of variables declared in a block or to names of function parameters. However, these names by default have automatic storage. Therefore the storage class specifier `auto` is usually redundant in a data declaration.

Storage duration of automatic variables

Objects with the auto storage class specifier have automatic storage duration. Each time a block is entered, storage for auto objects defined in that block is made available. When the block is exited, the objects are no longer available for use. An object declared with no linkage specification and without the `static` storage class specifier has automatic storage duration.

If an auto object is defined within a function that is recursively invoked, a new object is allocated at each invocation of the block.

Linkage of automatic variables

An auto variable has block scope and no linkage.

Note:  In C++11, the keyword `auto` is no longer used as a storage class specifier. Instead, it is used as a type specifier. The compiler deduces the type of an auto variable from the type of its initializer expression. For more information, see “The auto type specifier (C++11)” on page 89.

Related reference:

“Initialization and storage classes” on page 125

“Block statements” on page 222

“The goto statement” on page 236

The static storage class specifier

Objects declared with the `static` storage class specifier have *static storage duration*, which means that memory for these objects is allocated when the program begins running and is freed when the program terminates. Static storage duration for a variable is different from file or global scope: a variable can have static duration but local scope.

 The keyword `static` is the major mechanism in C to enforce information hiding.

 C++ enforces information hiding through the namespace language feature and the access control of classes. The use of the keyword `static` to limit the scope of external variables is deprecated for declaring objects in namespace scope.

The `static` storage class specifier can be applied to the following declarations:

- Data objects
-  Class members

- Anonymous unions

You cannot use the `static` storage class specifier with the following:

- Type declarations
- Function parameters

C At the C99 language level, the `static` keyword can be used in the declaration of an array parameter to a function. The `static` keyword indicates that the argument passed into the function is a pointer to an array of at least the specified size. In this way, the compiler is informed that the pointer argument is never null. See “Static array indices in function parameter declarations (C only)” on page 265 for more information.

Linkage of static variables

If a declaration of an object contains the `static` storage class specifier and has file scope, the identifier has internal linkage. Each instance of the particular identifier therefore represents the same object within one file only. If a declaration of an object contains the `static` storage class specifier and has function scope, an object is statically allocated and all the function calls use the same object. For example, if a static variable `x` has been declared in function `f`, when the program exits the scope of `f`, `x` is not destroyed:

```
#include <stdio.h>

int f(void) {
    static int x = 0;
    x++;
    return x;
}

int main(void) {
    int j;
    for (j = 0; j < 5; j++) {
        printf("Value of f(): %d\n", f());
    }
    return 0;
}
```

The following is the output of the above example:

```
Value of f(): 1
Value of f(): 2
Value of f(): 3
Value of f(): 4
Value of f(): 5
```

Because `x` is a function local static variable, it is not reinitialized to 0 on successive calls to `f`.

Related reference:

“The static storage class specifier” on page 254

“Static members” on page 344

“Initialization and storage classes” on page 125

“Internal linkage” on page 11

Chapter 10, “Namespaces (C++ only),” on page 293

The extern storage class specifier

The extern storage class specifier lets you declare objects that several source files can use. An extern declaration makes the described variable usable by the succeeding part of the current source file. This declaration does not replace the definition. The declaration is used to describe the variable that is externally defined.

An extern declaration can appear outside a function or at the beginning of a block. If the declaration describes a function or appears outside a function and describes an object with external linkage, the keyword `extern` is optional.

If a declaration for an identifier already exists at file scope, any extern declaration of the same identifier found within a block refers to that same object. If no other declaration for the identifier exists at file scope, the identifier has external linkage.

C++ C++ restricts the use of the extern storage class specifier to the names of objects or functions. Using the extern specifier with type declarations is illegal. An extern declaration cannot appear in class scope.

Storage duration of external variables

All extern objects have static storage duration. Memory is allocated for extern objects before the `main` function begins running, and is freed when the program terminates. The scope of the variable depends on the location of the declaration in the program text. If the declaration appears within a block, the variable has block scope; otherwise, it has file scope.

Linkage of external variables

C Like the scope, the linkage of a variable declared extern depends on the placement of the declaration in the program text. If the variable declaration appears outside of any function definition and has been declared `static` earlier in the file, the variable has internal linkage; otherwise, it has external linkage in most cases. All object declarations that occur outside a function and that do not contain a storage class specifier declare identifiers with external linkage.

C++ For objects in the unnamed namespace, the linkage may be external, but the name is unique, and so from the perspective of other translation units, the name effectively has internal linkage.

Note: **C++11** The keyword `extern` was previously used as a storage specifier or as part of a linkage specification. The C++11 standard adds a third usage to use this keyword to specify explicit instantiation declarations. For more information, see “Explicit instantiation” on page 434.

Related reference:

“External linkage” on page 12

“Initialization and storage classes” on page 125

“The extern storage class specifier” on page 254

Chapter 10, “Namespaces (C++ only),” on page 293

“Class scope (C++ only)” on page 8

The mutable storage class specifier (C++ only)

The mutable storage class specifier is used only on a class data member to make it modifiable even though the member is part of an object declared as `const`. You cannot use the mutable specifier with names declared as `static` or `const`, or reference members.

In the following example:

```
class A
{
public:
    A() : x(4), y(5) { };
    mutable int x;
    int y;
};

int main()
{
    const A var2;
    var2.x = 345;
    // var2.y = 2345;
}
```

the compiler would not allow the assignment `var2.y = 2345` because `var2` has been declared as `const`. The compiler will allow the assignment `var2.x = 345` because `A::x` has been declared as `mutable`.

Related reference:

“Type qualifiers” on page 98

“References (C++ only)” on page 123

The register storage class specifier

The register storage class specifier indicates to the compiler that the object should be stored in a machine register. The register storage class specifier is typically specified for heavily used variables, such as a loop control variable, in the hopes of enhancing performance by minimizing access time. However, the compiler is not required to honor this request. Because of the limited size and number of registers available on most systems, few variables can actually be put in registers. If the compiler does not allocate a machine register for a register object, the object is treated as having the storage class specifier `auto`.

An object having the register storage class specifier must be defined within a block or declared as a parameter to a function.

The following restrictions apply to the register storage class specifier:

- **C** You cannot use pointers to reference objects that have the register storage class specifier.
- **C** You cannot use the register storage class specifier when declaring objects in global scope.
- **C** A register does not have an address. Therefore, you cannot apply the address operator (`&`) to a register variable.
- **C++** You cannot use the register storage class specifier when declaring objects in namespace scope.

C++ Unlike C, C++ lets you take the address of an object with the register storage class. For example:

```
register int i;
int* b = &i;    // valid in C++, but not in C
```

Storage duration of register variables

Objects with the register storage class specifier have automatic storage duration. Each time a block is entered, storage for register objects defined in that block is made available. When the block is exited, the objects are no longer available for use.

If a register object is defined within a function that is recursively invoked, a new object is allocated at each invocation of the block.

Linkage of register variables

Since a register object is treated as the equivalent to an object of the auto storage class, it has no linkage.

Variables in specified registers (IBM extension)

You can specify that a particular hardware register is dedicated to a variable by using an asm *register variable* declaration. This language extension is provided for compatibility with GNU C.

Global register variables reserve registers throughout the program; stores into the reserved register are never deleted.

Local register variables do not actually reserve the registers, except when the variables are used as input or output operands in an inline assembly statement. In this case, using the variable as an asm operand guarantees that the specified register is used for the operand and is a convenient way to control which register is used.

Register variable declaration syntax

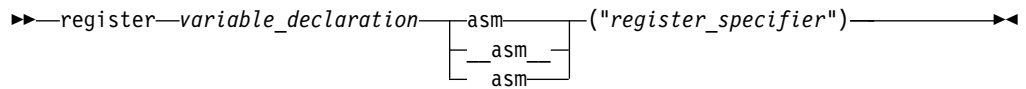

The *register_specifier* is a string representing a hardware register. The register name is CPU-specific. The following are valid register names:

r0 to r31

General purpose registers

f0 to f31

Floating-point registers

v0 to v31

Vector registers (on selected processors)

The following are the rules of use for register variables:

- You cannot reserve registers for the following types of variables:
 - long long types
 - aggregate types
 - class types
 - reference types

- void types
- `_Complex` types
- 128-bit long double types
- decimal floating-point types
- General purpose registers can only be reserved for variables of integer or pointer type.
- Floating-point registers can only be reserved for variables of float, double, or 64-bit long double type.
- Vector registers can only be reserved for variables of vector type.
- A global register variable cannot be initialized.
- The register dedicated for a global register variable should not be a volatile register, or the value stored into the global variable might not be preserved across a function call.
- More than one register variable can reserve the same register; however, the two variables become aliases of each other, and this is diagnosed with a warning.
- The same global register variable cannot reserve more than one register.
- A register variable should not be used in an OpenMP clause or OpenMP parallel or work-sharing region.
- The register specified in the global register declaration is reserved for the declared variable only in the compilation unit in which the register declaration is specified. The register is not reserved in other compilation units unless you place the global register declaration in a common header file, or use the `-qreserved_reg` compiler option.

► C++11

Note: The register storage class specifier is deprecated in C++11.

Related reference:

“Initialization and storage classes” on page 125

“Block/local scope” on page 6

“References (C++ only)” on page 123

Assembly labels (IBM extension)

“Inline assembly statements (IBM extension)” on page 238



See `-qreserved_reg` in the XL C/C++ Compiler Reference

The `__thread` storage class specifier (IBM extension)

The `__thread` storage class marks a static variable as having *thread-local* storage duration. This means that, in a multithreaded application, a unique instance of the variable is created for each thread that uses it, and destroyed when the thread terminates. The `__thread` storage class specifier can provide a convenient way of assuring thread-safety: declaring an object as per-thread allows multiple threads to access the object without the concern of race conditions, while avoiding the need for low-level programming of thread synchronization or significant program restructuring.

The `tls_model` attribute allows source-level control for the thread-local storage model used for a given variable. The `tls_model` attribute must specify one of `local-exec`, `initial-exec`, `local-dynamic`, or `global-dynamic` access method, which overrides the `-qtls` option for that variable. For example:

```
__thread int i __attribute__((tls_model("local-exec")));
```

The `tls_model` attribute allows the linker to check that the correct thread model has been used to build the application or shared library. The linker/loader behavior is as follows:

Table 17. Link time/runtime behavior for thread access models



Access method	Link-time diagnostic	Runtime diagnostic
local-exec	Fails if referenced symbol is imported.	Fails if module is not the main program. Fails if referenced symbol is imported (but the linker should have detected the error already).
initial-exec	None.	<code>dlopen()/load()</code> fails if referenced symbol is not in the module loaded at execution time.
local-dynamic	Fails if referenced symbol is imported.	Fails if referenced symbol is imported (but the linker should have detected the error already).
global-dynamic	None.	None.

Note: In order for the `__thread` keyword to be recognized, you must compile with the `-qtls` option. See `-qtls` in the *XL C/C++ Compiler Reference* for details.

The specifier can be applied to variables with static storage duration. It cannot be applied to function-scoped or block-scoped automatic variables or non-static data members.

The thread specifier can be either preceded or followed by the `static` or `extern` specifier.

```
__thread int i;
extern __thread struct state s;
static __thread char *p;
```

 A thread variable must be initialized with a constant expression. 

Applying address operator (`&`) to a thread-local variable returns the runtime address of the current thread's instance of the variable. That thread can pass this address to any other thread; however, when the first thread terminates, any pointers to its thread-local variables become invalid.

Related reference:

 See `-qtls` in the *XL C/C++ Compiler Reference*

Type specifiers

Type specifiers indicate the type of the object being declared. See the following available kinds of types:

- Fundamental or built-in types:
 - Arithmetic types
 - Integral types
 - Boolean types

- Floating-point types
- Character types
- The void type
-  Vector types
- User-defined types

C++

A type is a literal type if it satisfies one of the following conditions:

- It is a scalar type.
- It is a reference type.
- It is an array of literal type.
-  It is a class type with all the following properties:
 - The class has a trivial destructor.
 - Each constructor call and full expression in the initializers for nonstatic data members (if any) is a constant expression.
 - The class is an aggregate type or has at least one `constexpr` constructor or constructor template that is not a copy or move constructor.
 - All nonstatic data members and base classes of the class are of literal types.

C++11

C++

C++11

In the C++11 standard, the following type specifiers are introduced:

- The `auto` type specifier
- The `decltype(expression)` type specifier

C++11

Related reference:

“Function return type specifiers” on page 261

Integral types

Integer types fall into the following categories:

- Signed integer types:
 - signed char
 - short int
 - int
 - long int
 - long long int
- Unsigned integer types:
 - unsigned char
 - unsigned short int
 - unsigned int
 - unsigned long int
 - unsigned long long int

The unsigned prefix indicates that the object is a nonnegative integer. Each unsigned type provides the same size storage as its signed equivalent. For example, `int` reserves the same storage as unsigned `int`. Because a signed type reserves a sign bit, an unsigned type can hold a larger positive integer value than the equivalent signed type.

The declarator for a simple integer definition or declaration is an identifier. You can initialize a simple integer definition with an integer constant or with an expression that evaluates to a value that can be assigned to an integer.

► **C++** When the arguments in overloaded functions and overloaded operators are integer types, two integer types that both come from the same group are not treated as distinct types. For example, you cannot overload an `int` argument against a signed `int` argument.

Related reference:

Integer literals

“Integral conversions” on page 148

“Arithmetic conversions and promotions” on page 148

Chapter 11, “Overloading (C++ only),” on page 305

Boolean types

A Boolean variable can be used to hold the integer values 0 or 1, ► **C++** or the literals `true` or `false` ► **C++** ◀, which are implicitly promoted to the integers 1 and 0 respectively, whenever an arithmetic value is necessary. The Boolean type is unsigned and has the lowest ranking in its category of standard unsigned integer types; it may not be further qualified by the specifiers `signed`, `unsigned`, `short`, or `long`. In simple assignments, if the left operand is a Boolean type, then the right operand must be either an arithmetic type or a pointer.

► **C** Boolean type is a C99 feature. To declare a Boolean variable, use the `_Bool` type specifier. ► **C** ◀

► **IBM** The token `bool` is recognized as a keyword in C only when used in a vector declaration context and vector support is enabled. ► **IBM** ◀

► **C++** To declare a Boolean variable in C++, use the `bool` type specifier. The result of the equality, relational, and logical operators is of type `bool`: either of the Boolean constants `true` or `false`. ► **C++** ◀

You can use Boolean types to make *Boolean logic tests*. A Boolean logic test is used to express the results of a logical operation. For example:

```
_Bool f(int a, int b)
{
    return a==b;
}
```

If `a` and `b` have the same value, `f` returns `true`. If not, `f` returns `false`.

Related reference:

Boolean literals

“Boolean conversions” on page 148

“Vector types (IBM extension)” on page 66

Floating-point types

Floating-point type specifiers fall into the following categories:

- Real floating-point types
- Complex floating-point types

Real floating-point types

Generic, or binary, floating-point types consist of the following:

- float
- double
- long double

IBM Decimal floating-point types consist of the following:

- `_Decimal32`
- `_Decimal64`
- `_Decimal128`

Note: In order for the `_Decimal32`, `_Decimal64`, and `_Decimal128` keywords to be recognized, you must compile with the `-qdfp` compiler option. See `-qdfp` in the *XL C/C++ Compiler Reference* for details.

IBM

The magnitude ranges of the real floating-point types are given in the following table.

Table 18. Magnitude ranges of real floating-point types

Type	Range
float	approximately 1.2^{-38} to 3.4^{38}
double, long double	approximately 2.2^{-308} to 1.8^{308}
<code>_Decimal32</code>	0.000001^{-95} to 9.999999^{96}
<code>_Decimal64</code>	$0.0000000000000001^{-383}$ to 9.9999999999999999^{384}
<code>_Decimal128</code>	$0.0000000000000000000000000000000000000001^{-6143}$ to 9.99^{6144}

If a floating-point constant is too large or too small, the result is undefined by the language.

The declarator for a simple floating-point declaration is an identifier. Initialize a simple floating-point variable with a float constant or with a variable or expression that evaluates to an integer or floating-point number.

IBM You can use decimal floating-point types with any of the operators that are supported for binary floating-point types. However, you cannot mix decimal floating-point types with generic floating-point types or complex floating-point types in arithmetic expressions unless you use explicit conversions. Implicit conversions are applicable as follows:

- Implicit conversions among decimal floating-point types are always supported.
- Implicit conversions between decimal floating-point types and integral types are always supported.

- Implicit conversions between decimal floating-point types and generic floating-point types are supported conditionally. See “Floating-point conversions” on page 149 for details.

IBM

Complex floating-point types

Complex floating-point types are introduced in the C99 standard. C++ The XL C/C++ compiler supports this feature as an IBM extension. C++ The complex floating-point type specifiers are as follows:

- `float _Complex`
- `double _Complex`
- `long double _Complex`

The representation and alignment requirements of a complex type are the same as an array type containing two elements of the corresponding real type. The real part is equal to the first element; the imaginary part is equal to the second element.

The equality and inequality operators have the same behavior as for real types. None of the relational operators may have a complex type as an operand.

IBM As an extension to C99 and Standard C++, complex numbers may also be operands to the unary operators `++` (increment), `--` (decrement), and `~` (bitwise negation). IBM

Related reference:

Floating-point literals

“Floating-point conversions” on page 149

“Arithmetic conversions and promotions” on page 148

Complex literals (C only)

“The `__real__` and `__imag__` operators (IBM extension)” on page 179

Character types

Character types fall into the following categories:

- Narrow character types:
 - `char`
 - signed char
 - unsigned char
- Wide character type `wchar_t`

The `char` specifier is an integral type. The `wchar_t` type specifier is an integral type that has enough storage to represent a wide character literal. (A wide character literal is a character literal that is prefixed with the letter `L`, for example `L'x'`)

C A `char` is a distinct type from signed char and unsigned char, and the three types are not compatible.

C++ For the purposes of distinguishing overloaded functions, a C++ `char` is a distinct type from signed char and unsigned char.

If it does not matter if a `char` data object is signed or unsigned, you can declare the object as having the data type `char`. Otherwise, explicitly declare signed char or

unsigned char to declare numeric variables that occupy a single byte. When a char (signed or unsigned) is widened to an int, its value is preserved.

By default, char behaves like an unsigned char. To change this default, you can use the `-qchars` option or the `#pragma chars` directive. See `-qchars` in the *XL C/C++ Compiler Reference* for more information.

Related reference:

Character literals

String literals

“Arithmetic conversions and promotions” on page 148

The void type

The void data type always represents an empty set of values. The only object that can be declared with the type specifier void is a pointer.

You cannot declare a variable of type void, but you can explicitly convert any expression to type void. The resulting expression can only be used as one of the following cases:

- An expression statement
- The left operand of a comma expression
- The second or third operand in a conditional expression.

Related reference:

“Pointers” on page 114

“Comma operator ,” on page 192

“Conditional expressions” on page 194

“Function declarations and definitions” on page 247

Vector types (IBM extension)

XL C/C++ supports vector processing technologies through language extensions. XL C/C++ implements and extends the AltiVec Programming Interface specification. In the extended syntax, type qualifiers and storage class specifiers can precede the keyword vector (or its alternative spelling, `__vector`) in a declaration.

Most of the legal forms of the syntax are captured in the following diagram. Some variations have been omitted from the diagram for the sake of clarity: type qualifiers such as `const` and storage class specifiers such as `static` can appear in any order within the declaration, as long as neither immediately follows the keyword vector (or `__vector`).

Vector declaration syntax



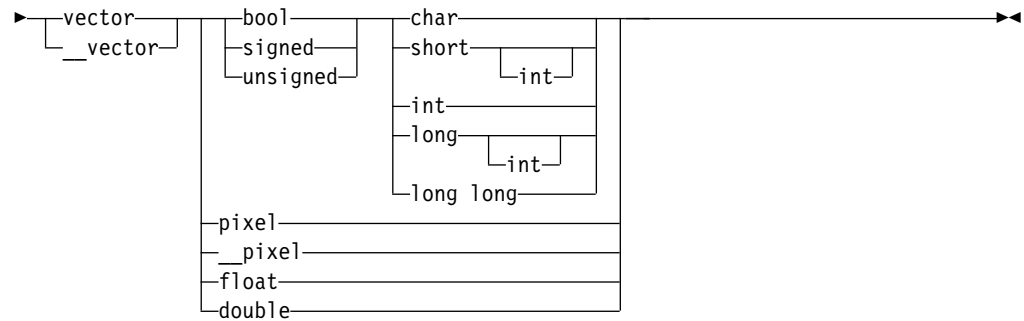

Notes:

1. The keyword vector is recognized in a declaration context only when used as a type specifier and when vector support is enabled. The keywords pixel, __pixel and bool are recognized as valid type specifiers only when preceded by the keyword vector or __vector.
2. The long type specifier is deprecated in a vector context and is treated as an int.
3. Duplicate type specifiers are ignored in a vector declaration context.

The following table lists the supported vector data types, the size and possible values for each type.

Table 19. Vector data types

Type	Interpretation of content	Range of values
vector unsigned char	16 unsigned char	0..255
vector signed char	16 signed char	-128..127
vector bool char	16 unsigned char	0, 255
vector unsigned short	8 unsigned short	0..65535
vector unsigned short int		
vector signed short	8 signed short	-32768..32767
vector signed short int		
vector bool short	8 unsigned short	0, 65535
vector bool short int		
vector unsigned int	4 unsigned int	0..2 ³² -1
vector unsigned long		
vector unsigned long int		
vector signed int	4 signed int	-2 ³¹ ..2 ³¹ -1
vector signed long		
vector signed long int		
vector bool int	4 unsigned int	0, 2 ³² -1
vector bool long		
vector bool long int		
vector unsigned long long	2 unsigned long long	0..2 ⁶⁴ -1
vector bool long long		0, 2 ⁶⁴ -1

Table 19. Vector data types (continued)

Type	Interpretation of content	Range of values
vector signed long long	2 signed long long	$-2^{63}..2^{63}-1$
vector float	4 float	IEEE-754 single (32 bit) precision floating-point values
vector double	2 double	IEEE-754 double (64 bit) precision floating-point values
vector pixel	8 unsigned short	1/5/5/5 pixel

Note: The **vector unsigned long long**, **vector bool long long**, **vector signed long long**, and **vector double** types require architectures that support the VSX instruction set extensions, such as POWER7® or POWER8®. You must specify the corresponding **-qarch** suboption such as **-qarch=pwr7** or **-qarch=pwr8** when you use these types.

All vector types are aligned on a 16-byte boundary. An aggregate that contains one or more vector types is aligned on a 16-byte boundary, and padded, if necessary, so that each member of vector type is also 16-byte aligned.

Vector data type operators

Vector data types can use some of the unary, binary, and relational operators that are used with primitive data types. Note that all operators require compatible types as operands unless otherwise stated. These operators are not supported at global scope or for objects with static duration, and there is no constant folding.

For unary operators, each element in the vector has the operation applied to it.

Table 20. Unary operators

Operator	Integer vector types	Vector double	Bool vector types
++	Yes	Yes	No
--	Yes	Yes	No
+	Yes	Yes	No
-	Yes (except unsigned vectors)	Yes	No
~	Yes	No	Yes

For binary operators, each element has the operation applied to it with the same position element in the second operand. Binary operators also include assignment operators.

Table 21. Binary operators

Operator	Integer vector types	Vector double	Bool vector types
+	Yes	Yes	No
-	Yes	Yes	No
*	Yes	Yes	No
/	Yes	Yes	No

Table 21. Binary operators (continued)

Operator	Integer vector types	Vector double	Bool vector types
%	Yes	No	No
&	Yes	No	Yes
	Yes	No	Yes
^	Yes	No	Yes
<<	Yes	No	Yes
>>	Yes	No	Yes
[]	Yes	Yes	Yes

Note: The [] operator returns the vector element at the position specified. If the position specified is outside of the valid range, the behavior is undefined.

For relational operators, each element has the operation applied to it with the same position element in the second operand and the results have the AND operator applied to them to get a final result of a single value.

Table 22. Relational operators

Operator	Integer vector types	Vector double	Bool vector types
==	Yes	Yes	Yes
!=	Yes	Yes	Yes
<	Yes	Yes	No
>	Yes	Yes	No
<=	Yes	Yes	No
>=	Yes	Yes	No

For the following code:

```
vector unsigned int a = {1,2,3,4};
vector unsigned int b = {2,4,6,8};
vector unsigned int c = a + b;
int e = b > a;
int f = a[2];
vector unsigned int d = ++a;
```

c would have the value (3,6,9,12), d would have the value (2,3,4,5), e would have a non-zero value, and f would have the value 3.

Related reference:

Vector literals

“Initialization of vectors (IBM extension)” on page 128

“The __align type qualifier (IBM extension)” on page 99

“The aligned variable attribute” on page 141

User-defined types

See the following user-defined types:

- Structures and unions
- Enumerations
- Typedef definitions

- **C++** Classes
- **C++** Elaborated type specifiers

C++ classes are discussed in Chapter 12, “Classes (C++ only),” on page 325. Elaborated type specifiers are discussed in “Scope of class names” on page 329.

Related reference:

“Type attributes (IBM extension)” on page 104

Structures and unions

A *structure* contains an ordered group of data objects. Unlike the elements of an array, the data objects within a structure can have varied data types. Each data object in a structure is a *member* or *field*.

A *union* is an object similar to a structure except that all of its members start at the same location in memory. A union variable can represent the value of only one of its members at a time.

C++ In C++, structures and unions are the same as classes except that their members and inheritance are public by default. **C++**

You can declare a structure or union type separately from the definition of variables of that type, as described in “Structure and union type definition” and “Structure and union variable declarations” on page 76; or you can define a structure or union data type and all variables that have that type in one statement, as described in “Structure and union type and variable definitions in a single statement” on page 77.

Structures and unions are subject to alignment considerations. For a complete discussion of alignment, see “Aligning data” in the *XL C/C++ Optimization and Programming Guide*.

Structure and union type definition

A structure or union *type definition* contains the struct or union keyword followed by an optional identifier (the structure tag) and a brace-enclosed list of members.

Structure or union type definition syntax

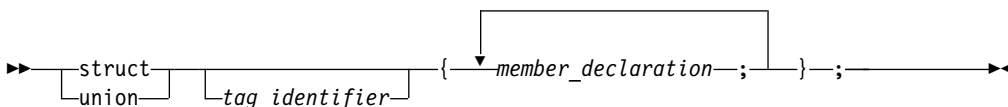

The *tag_identifier* gives a name to the type. If you do not provide a tag name, you must put all variable definitions that refer to the type within the declaration of the type, as described in “Structure and union type and variable definitions in a single statement” on page 77. Similarly, you cannot use a type qualifier with a structure or union definition; type qualifiers placed in front of the struct or union keyword can only apply to variables that are declared within the type definition.

Member declarations

The list of members provides a structure or union data type with a description of the values that can be stored in the structure or union. The definition of a member has the form of a standard variable declaration. The names of member variables

must be distinct within a single structure or union, but the same member name may be used in another structure or union type that is defined within the same scope, and may even be the same as a variable, function, or type name.



A structure or union member may be of any type except:

- any variably modified type
- void type
-  a function
- any incomplete type

Because incomplete types are not allowed as members, a structure or union type may not contain an instance of itself as a member, but is allowed to contain a pointer to an instance of itself. As a special case, the last member of a structure with more than one member may have an incomplete array type, which is called a *flexible array member*, as described in Flexible array members.

IBM

As an extension to Standard C and C++ for compatibility with GNU C/C++, XL C/C++ also allows zero-extent arrays as members of structures and unions, as described in Zero-extent array members (IBM extension). 



 A union member cannot be a class object that has a constructor, destructor, or overloaded copy assignment operator, nor can it be of reference type. A union member cannot be declared with the keyword `static`. 

A member that does not represent a bit field can be qualified with either of the type qualifiers `volatile` or `const`. The result is an lvalue.

Structure members are assigned to memory addresses in increasing order, with the first component starting at the beginning address of the structure name itself. To allow proper alignment of components, padding bytes may appear between any consecutive members in the structure layout.

The storage allocated for a union is the storage required for the largest member of the union (plus any padding that is required so that the union will end at a natural boundary of its member having the most stringent requirements). All of a union's components are effectively overlaid in memory: each member of a union is allocated storage starting at the beginning of the union, and only one member can occupy the storage at a time.

Flexible array members

A *flexible array member* is an unbounded array that occurs within a structure. It is a C99 feature and  the XL C/C++ compiler supports it as an IBM extension . Flexible array members can be used to access a variable-length object. A flexible array member is permitted as the last member of a structure, provided that the structure has more than one named member. It is declared with an empty index as follows:

```
array_identifier [ ];
```

For example, `b` is a flexible array member of structure `f`.

```
struct f{  
    int a;  
    int b[];  
};
```

Because a flexible array member has an incomplete type, you cannot apply the `sizeof` operator to a flexible array. In this example, the statement `sizeof(f)` returns the same result as `sizeof(f.a)`, which is the size of an integer. The statement `sizeof(f.b)` cannot be used, because `b` is a flexible array member that has an incomplete type.

Any structure containing a flexible array member cannot be a member of another structure or an element of an array, for example:

```
struct f{
    int a;
    int b[];
};
struct f fa[10]; // Error.
```

IBM To be compatible with GNU C/C++, the XL C/C++ compiler extends Standard C and C++, to ease the restrictions on flexible array members and allow the following situations:

- Flexible array members can be declared in any part of a structure, not just as the last member. The type of any member that follows the flexible array member is not required to be compatible with the type of the flexible array member; however, a warning message is issued when a flexible array member is followed by members of an incompatible type. The following example demonstrates this:

```
struct s {
    int a;
    int b[];
    char c; // The compiler issues a warning message.
} f;
```

- Structures containing flexible array members can be members of other structures.
- **C** Flexible array members can be statically initialized only if either of the following two conditions is true:

- The flexible array member is the last member of the structure, for example:

```
struct f {
    int a;
    int b[];
} f1 = {1,{1,2,3}}; // Fine.

struct a {
    int b;
    int c[];
    int d[];
} e = { 1,{1,2},3}; // Error, c is not the last member
// of structure a.
```

- Flexible array members are contained in the outermost structure of nested structures. Members of inner structures cannot be statically initialized, for example:

```
struct b {
    int c;
    int d[];
};

struct c {
    struct b f;
    int g[];
} h ={{1,{1,2}},{1,2}}; // Error, member d of structure b is
// in the inner nested structure.
```

C

IBM

Zero-extent array members (IBM extension)

Zero-extent arrays are provided for GNU C/C++ compatibility, and can be used to access a variable-length object.

A zero-extent array is an array with an explicit zero specified as its dimension.

```
array_identifier [0]
```

For example, *b* is a zero-extent array member of structure *f*.

```
struct f{
    int a;
    int b[0];
};
```

The `sizeof` operator can be applied to a zero-extent array, and the value returned is 0. In this example, the statement `sizeof(f)` returns the same result as `sizeof(f.a)`, which is the size of an integer. The statement `sizeof(f.b)` returns 0.

A structure containing a zero-extent array can be an element of an array, for example:

```
struct f{
    int a;
    int b[0];
};
struct f fa[10]; // Fine.
```

A zero-extent array can only be statically initialized with an empty set `{}`. Otherwise, it must be initialized as a dynamically allocated array. For example:

```
struct f{
    int a;
    int b[0];
};
struct f f1 = {100, {}}; //Fine.
struct f f2 = {100, {1, 2}}; //Error.
```

If a zero-extent array is not initialized, no static zero filling occurs, because a zero-extent array is defined to have no members. The following example demonstrates this:

```
#include <stdio.h>

struct s {
    int a;
    int b[0];
};

struct t1 {
    struct s f;
    int c[3];
} g1 = {{1},{1,2}};

struct t2 {
    struct s f;
    int c[3];
} g2 = {{1,{}},{1,2}};

int main() {
    printf("%d %d %d %d\n", g1.f.a, g1.f.b[0], g1.f.b[1], g1.f.b[2]);
    printf("%d %d %d %d\n", g2.f.a, g2.f.b[0], g2.f.b[1], g2.f.b[2]);
    return 0;
}
```

In this example, the two `printf` statements produce the same output:

```
1 1 2 0
```

A zero-extent array can be declared in any part of a structure, not just as the last member. The type of any member following the zero-extent array is not required to be compatible with the type of the zero-extent array; however, a warning is issued when a zero-extent array is followed by members of an incompatible type. For example:

```
struct s {
    int a;
    int b[0];
    char c;    // Issues a warning message
} f;
```

You can declare a zero extent array only as a member of an aggregate type. For example:

```
int func(){
    int a[0];    // error
    struct S{
        int x;
        char b[0];    // fine
    };
}
```

Bit field members

Both C and C++ allow integer members to be stored into memory spaces smaller than the compiler would ordinarily allow. These space-saving structure members are called *bit fields*, and their width in bits can be explicitly declared. Bit fields are used in programs that must force a data structure to correspond to a fixed hardware representation and are unlikely to be portable.

Bit field member declaration syntax

► *type_specifier* declarator : *constant_expression* ; ◀

The *constant_expression* is a constant integer expression that indicates the field width in bits. A bit field declaration may not use either of the type qualifiers `const` or `volatile`.

► C

In C99, the allowable data types for a bit field include `_Bool`, `int`, `signed int`, and `unsigned int`. ▶ IBM The data type for a bit field can also be any version of `char`, `short`, and `long`. If a bit field is of any version of type `char` or `short`, its type is replaced by `signed int` or `unsigned int`, depending on the setting of

`-qbitfields`. ▶ IBM ◀

► C

▶ C++ A bit field can be any integral type or enumeration type. ▶ C++ ◀

The maximum bit-field length is 64 bits. To increase portability, do not use bit fields greater than 32 bits in size.

The following structure has three bit-field members `kingdom`, `phylum`, and `genus`, occupying 12, 6, and 2 bits respectively:

```
struct taxonomy {
    int kingdom : 12;
    int phylum : 6;
    int genus : 2;
};
```

When you assign a value that is out of range to a bit field, the low-order bit pattern is preserved and the appropriate bits are assigned.

The following restrictions apply to bit fields. You cannot:

- Define an array of bit fields
- Take the address of a bit field
- Have a pointer to a bit field
- Have a reference to a bit field

Bit fields are bit packed. They can cross word and byte boundaries. No padding is inserted between two (non-zero length) bit field members. Bit padding can occur after a bit field member if the next member is a zero length bitfield or a non-bit field. Non-bit field members are aligned based on their declared type. For example, the following structure demonstrates the lack of padding between bit field members, and the insertion of padding after a bit field member that precedes a non-bit field member.

```
struct {
    int larry : 25; // Bit Field: offset 0 bytes and 0 bits.
    int curly : 25; // Bit Field: offset 3 bytes and 1 bit (25 bits).
    int moe;      // non-Bit Field: offset 8 bytes and 0 bits (64 bits).
} stooges;
```

There is no padding between **`larry`** and **`curly`**. The bit offset of **`curly`** would be 25 bits. The member **`moe`** would be aligned on the next 4 byte boundary, causing 14 bits a padding between **`curly`** and **`moe`**.

Bit fields with a length of 0 must be unnamed. Unnamed bit fields cannot be referenced or initialized.

The following example demonstrates padding, and is valid for all implementations. Suppose that an `int` occupies 4 bytes. The example declares the identifier `kitchen` to be of type `struct on_off`:

```
struct on_off {
    unsigned light : 1;
    unsigned toaster : 1;
    int count; /* 4 bytes */
    unsigned ac : 4;
    unsigned : 4;
    unsigned clock : 1;
    unsigned : 0;
    unsigned flag : 1;
} kitchen;
```

The structure `kitchen` contains eight members totalling 16 bytes. The following table describes the storage that each member occupies:

Member name	Storage occupied
<code>light</code>	1 bit

Member name	Storage occupied
toaster	1 bit
(padding — 30 bits)	To the next int boundary
count	The size of an int (4 bytes)
ac	4 bits
(unnamed field)	4 bits
clock	1 bit
(padding — 23 bits)	To the next int boundary (unnamed field)
flag	1 bit
(padding — 31 bits)	To the next int boundary

Structure and union variable declarations

A structure or union *declaration* has the same form as a definition except the declaration does not have a brace-enclosed list of members. You must declare the structure or union data type before you can define a variable having that type.

Structure or union variable declaration syntax

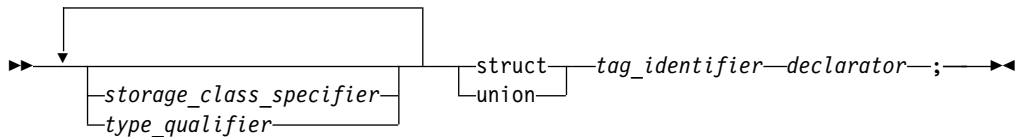

The *tag_identifier* indicates the data type of the structure or union.

► C++ The keyword `struct` is optional in structure variable declarations.
◀ C++

You can declare structures or unions having any storage class. The storage class specifier and any type qualifiers for the variable must appear at the beginning of the statement. Structures or unions declared with the `register` storage class specifier are treated as automatic variables.

The following example defines structure type `address`:

```

struct address {
    int street_no;
    char *street_name;
    char *city;
    char *prov;
    char *postal_code;
};

```

The following examples declare two structure variables of type `address`:

```

struct address perm_address;
struct address temp_address;

```

Structure and union type and variable definitions in a single statement

You can define a structure (or union) type and a structure (or union) variable in one statement, by putting a declarator and an optional initializer after the variable definition. The following example defines a union data type (not named) and a union variable (named `length`):

```
union {
    float meters;
    double centimeters;
    long inches;
} length;
```

Note that because this example does not name the data type, `length` is the only variable that can have this data type. Putting an identifier after `struct` or `union` keyword provides a name for the data type and lets you declare additional variables of this data type later in the program.

To specify a storage class specifier for the variable or variables, you must put the storage class specifier at the beginning of the statement. For example:

```
static struct {
    int street_no;
    char *street_name;
    char *city;
    char *prov;
    char *postal_code;
} perm_address, temp_address;
```

In this case, both `perm_address` and `temp_address` are assigned static storage.

Type qualifiers can be applied to the variable or variables declared in a type definition. Both of the following examples are valid:

```
volatile struct class1 {
    char descript[20];
    long code;
    short complete;
} file1, file2;

struct class1 {
    char descript[20];
    long code;
    short complete;
} volatile file1, file2;
```

In both cases, the structures `file1` and `file2` are qualified as `volatile`.

Access to structure and union members

Once structure or union variables have been declared, members are referenced by specifying the variable name with the dot operator (`.`) or a pointer with the arrow operator (`->`) and the member name. For example, both of the following:

```
perm_address.prov = "Ontario";
p_perm_address -> prov = "Ontario";
```

assign the string "Ontario" to the pointer `prov` that is in the structure `perm_address`.

All references to members of structures and unions, including bit fields, must be fully qualified. In the previous example, the fourth field cannot be referenced by `prov` alone, but only by `perm_address.prov`.

Anonymous structures

Note: IBM supports selected features of C11, known as C1X before its ratification. IBM will continue to develop and implement the features of this standard. The implementation of the language level is based on IBM's interpretation of the standard. Until IBM's implementation of all the C11 features is complete, including the support of a new C11 standard library, the implementation may change from release to release. IBM makes no attempt to maintain compatibility, in source, binary, or listings and other compiler interfaces, with earlier releases of IBM's implementation of the C11 features.

An *anonymous structure* is a structure that does not have a tag or a name and that is a member of another structure or union. All the members of the anonymous structure behave as if they were members of the parent structure. An anonymous structure must meet the following conditions:

- The structure is nested inside another structure or union.
- The structure has no tag.
- The structure has no name.

For example, the following code fragment demonstrates the conditions that an anonymous structure must meet.

```
struct v {
    union {
        // This is an anonymous structure, because it has no tag, no name,
        // and is a member of another structure or union.
        struct { int i, j; };

        // This is not an anonymous structure, because it has a name.
        struct { long k, l; } w;

        // This is not an anonymous structure, because
        // the structure has a tag "phone".
        struct phone {int number, areanumber;};
    };

    int m;
} v1;
```

Anonymous unions

An *anonymous union* is a union that does not have a tag or a name and that is a member of another union or structure. It cannot be followed by a declarator. An anonymous union is not a type; it defines an unnamed object.

The member names of an anonymous union must be distinct from other names within the scope in which the union is declared. You can use member names directly in the union scope without any additional member access syntax.

For example, in the following code fragment, you can access the data members `i` and `cptr` directly because they are in the scope containing the anonymous union. Because `i` and `cptr` are union members and have the same address, you should only use one of them at a time. The assignment to the member `cptr` will change the value of the member `i`.

```

void f() {
    union { int i; char* cptr ; };
    /* . . . */
    i = 5;
    cptr = "string_in_union"; // Overrides the value 5.
}

```

► C++ An anonymous union cannot have protected or private members, and it cannot have member functions. A global or namespace anonymous union must be declared with the keyword `static`. ◀ C++

◀ C11

Related reference:

“Classes and structures” on page 328

“The aligned type attribute” on page 105

“The packed type attribute” on page 107

“Variable length arrays” on page 122



See Alignment of bit fields in the XL C/C++ Optimization and Programming Guide

“The aligned variable attribute” on page 141

“The `_align` type qualifier (IBM extension)” on page 99

“The packed variable attribute” on page 143

“Initialization of structures and unions” on page 129

“Compatibility of structures, unions, and enumerations (C only)” on page 85

“Dot operator `.`” on page 168

“Arrow operator `->`” on page 169

“Storage class specifiers” on page 54

“Type qualifiers” on page 98

“The static storage class specifier” on page 55

“Member functions” on page 337

Enumerations

An *enumeration* is a data type that consists of a set of named values that represent integral constants, known as *enumeration constants*. An enumeration is also referred to as an *enumerated type* because you must list (enumerate) each of the values in creating a name for each of them. In addition to providing a way of defining and grouping sets of integral constants, enumerations are useful for variables that have a small number of possible values.

You can declare an enumeration type separately from the definition of variables of that type, as described in “Enumeration type definition” and “Enumeration variable declarations” on page 84; or you can define an enumeration data type and all variables that have that type in one statement, as described in “Enumeration type and variable definitions in a single statement” on page 85.

Enumeration type definition

An enumeration type definition contains the `enum`, ◀ C++11 `enum class`, or `enum struct` ◀ C++11 keyword followed by an optional identifier (the enumeration tag), ◀ C++11 an optional underlying type specifier ◀ C++11, and a brace-enclosed list of enumerators. ◀ C++11 For scoped enumerations, the identifier is mandatory.

◀ C++11 A comma separates each enumerator in the enumerator list. C99 allows a

trailing comma between the last enumerator and the closing brace. C++11 This feature is also adopted by the C++11 standard. C++11

Enumeration definition syntax

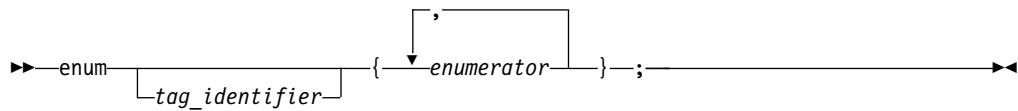

C++11

Unscoped enumeration definition syntax

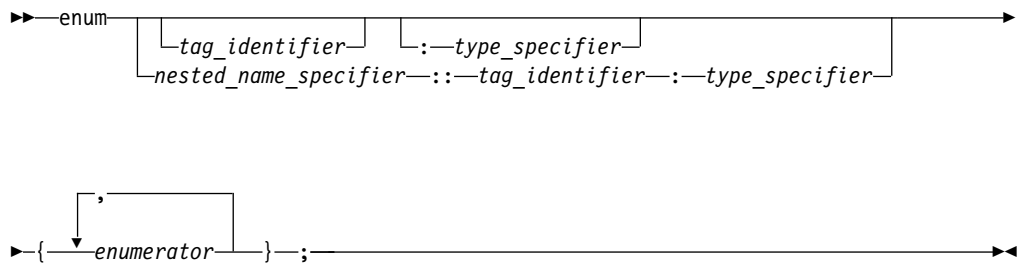

Scoped enumeration definition syntax

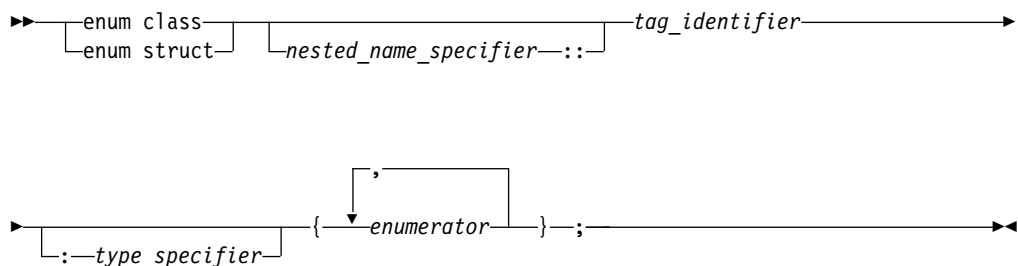

Enumeration forward declaration syntax

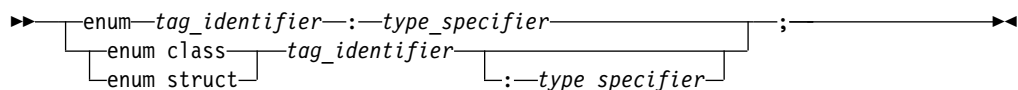

The keyword `enum` declares an unscoped enumeration type, whose enumerators are unscoped enumerators. The keywords `enum class` or `enum struct` declare a scoped enumeration type, whose enumerators are scoped enumerators. The keywords `enum class` and `enum struct` are semantically equivalent.

For the unscoped enumeration, each enumerator is declared both in the scope of the enumeration specifier, and the scope that immediately contains the enumeration specifier.

For the scoped enumeration, each enumerator is declared in the scope of the enumeration specifier. In addition, the scoped enumeration does not allow the

value of an enumerator (or an object of an enumeration type) to be converted to an integer by integral promotion, but explicit cast to int, char, float, or any other scalar type is allowed. For example:

```
enum class Colour { orange, green, purple };
enum class Fruit { apple, pear, grape, orange };

void functionx(int) {}
void functionx(Colour) {}
void functionx(Fruit) {}

int main()
{
    functionx(green);           // error, green is not introduced into
                               // the global scope
    functionx(Colour::green);  // calls functionx(Colour)
    functionx(Fruit::apple);   // calls functionx(Fruit)
    int i = Colour::orange;    // error, no conversion from Colour to int
    int j = (int)Colour::green; // valid, explicit cast to integer is allowed
}
```

C++11 ◀

The *tag_identifier* gives a name to the enumeration type. If you do not provide a tag name, you must put all variable definitions that refer to the enumeration type within the declaration of the type, as described in “Enumeration type and variable definitions in a single statement” on page 85. Similarly, you cannot use a type qualifier with an enumeration definition; type qualifiers placed in front of the enum keyword can only apply to variables that are declared within the type definition.

▶ **C++11** The *type_specifier* specifies the underlying type of an enumeration explicitly. Each enumeration has an underlying type. The *type_specifier* can be any integer type. Note that the enumeration type is not an integer type. By specifying the underlying type of an enumeration, you can ensure program correctness and use the enumeration reliably in structs. If *type_specifier* is not specified, the underlying type of the enumeration is determined as follows:

- If the enumeration is scoped, the underlying type has the fixed type int.
- If the enumeration is unscoped, the underlying type is an integral type that can represent all the enumerator values defined in the enumeration.

For example:

```
// the underlying type is "unsigned int"
enum Colour : unsigned int { orange = 0, green = 1, purple = 0x02U };

// the underlying type is "unsigned long"
enum class E : unsigned long { E1 = 0, E2 = 1, Emax = 0xFFFFFFFF0U };

// if the type_specifier is not specified, the underlying type
// is "int" for the scoped enumeration
enum class A { A1, A2, A3 = 100, A4 };

// the underlying type is an integer type enough to represent the given
// enumerator values, eg. [signed/unsigned] long long
enum A { A1, A2, A3 = 10000000000000000000, A4 };
```

The *nested_name_specifier* refers to the class or namespace where the enumeration was previously declared. For example:

```
class C{

//Declaration of a scoped enumeration A.
enum class A;
```

```
};

// C is the nested_name_specifier that refers to the class where
// the enumeration A was declared.
enum class C::A { a, b };
```

You can forward declare an enumeration without providing a list of enumerators. The forward declaration of an enumeration can reduce compile time and dependencies, because it can physically decouple the implementation specifics of the enumeration and its usage.

The forward declaration of an enumeration is a redeclaration of an enumeration in the current scope or a declaration of a new enumeration. The redeclaration of the same enumeration must match the previous declaration. The rules for the redeclaration of enumerations are as follows:

- A scoped enumeration cannot be later redeclared as unscoped or with a different underlying type.
- An unscoped enumeration cannot be later redeclared as scoped and each redeclaration must include a *type_specifier* specifying the same underlying type.

For example:

```
enum E1 : unsigned long;           // valid, forward declaration of an unscoped
                                   // enumeration with the underlying type
                                   // "unsigned long"

enum class E2 : char;             // valid, forward declaration of a scoped
                                   // enumeration with the underlying type
                                   // "char"

enum class E3;                   // valid, forward declaration of a scoped
                                   // enumeration with the implied underlying
                                   // type "int"

enum E4;                          // error, you must specify the underlying type
                                   // when you forward declare an unscoped
                                   // enumeration

enum E1 : unsigned long;         // valid, the redeclaration of E1 matches the
                                   // previous declaration of E1

enum class E2 : short;           // error, the previously declared enumeration
                                   // E2 had the underlying type "char", and it
                                   // cannot be redeclared with a different
                                   // underlying type

enum E3 : int;                   // error, the previously declared enumeration
                                   // E3 was a scoped enumeration, and it cannot
                                   // be redeclared as an unscoped enumeration

enum class E3 : int { a, b, c }; // valid, definition of E3
```

C++11 ◀

Elaborated type specifier

Elaborated type specifier syntax

▶▶—enum—*tag_identifier*—*x*—▶▶

The elaborated type specifier refers to a previously declared enumeration. The *x* is a variable that has the type *tag_identifier*.

The `enum` keyword can be used to refer to scoped or unscoped enumerations during variable declaration or definition. For example:

```
// a scoped enumeration
enum class color { red, white, black, yellow };

// an unscoped enumeration
enum letter {A, B, C, D};

// valid, regular type name usage
color pic1 = color :: white;

// valid, elaborated type usage
enum color pic2 = color :: red;
```

You cannot use `enum class` or `enum struct` in the elaborated type specifier. For example:

```
enum class color pic3 = color :: black;    // invalid
```

The elaborated type specifier for an unscoped enumeration is the same as that for a scoped enumeration. For example:

```
enum letter let1 = letter :: A;            // valid
```

Enumeration members

The list of enumeration members, or *enumerators*, provides the data type with a set of values.

Enumeration member declaration syntax

►—*identifier*—┐
└—=*enumeration_constant*—┘

► **C** In C, an *enumeration constant* is of type `int`. If a constant expression is used as an initializer, the value of the expression cannot exceed the range of `int` (that is, `INT_MIN` to `INT_MAX` as defined in the header `limits.h`). **C** ◀

► **C++** In C++, each enumeration constant has a value that can be promoted to a signed or unsigned integer value and a distinct type that does not have to be integral. You can use an enumeration constant anywhere an integer constant is allowed, or anywhere a value of the enumeration type is allowed. **C++** ◀

The value of an enumeration constant is determined in the following way:

1. An equal sign (=) and a constant expression after the enumeration constant gives an explicit value to the enumeration constant. The enumeration constant represents the value of the constant expression.
2. If no explicit value is assigned to the first enumerator, then it takes the value 0 (zero).
3. Enumeration constants with no explicitly assigned values receive the integer value that is one greater than the value represented by the previous enumeration constant.

► C++11

The underlying type of the following enumerations is fixed. The enumerator values obtained by following the previous rules must be representable by the underlying type. Otherwise the enumeration is ill-formed.

- Scoped enumerations
- Unscoped enumerations with explicit underlying type specified

The underlying type of an unscoped enumeration, with no explicit underlying type, is not fixed, and is determined by enumerator values as follows:

- The underlying type is an implementation-defined integral type that is not larger than `int` and can represent all values of the enumeration.
- If the values of the enumeration are not representable by an `int` or unsigned `int`, the underlying type is an implementation-defined integral type large enough to represent all enumerator values.
- If no type can represent all enumerator values, the enumeration is ill-formed.

► C++11 ◀

The following data type declarations list `oats`, `wheat`, `barley`, `corn`, and `rice` as enumeration constants. The number under each constant shows the integer value.

```
enum grain { oats, wheat, barley, corn, rice };
/*      0      1      2      3      4      */

enum grain { oats=1, wheat, barley, corn, rice };
/*      1      2      3      4      5      */

enum grain { oats, wheat=10, barley, corn=20, rice };
/*      0      10     11     20     21     */
```

It is possible to associate the same integer with two different enumeration constants. For example, the following definition is valid. The identifiers `suspend` and `hold` have the same integer value.

```
enum status { run, clear=5, suspend, resume, hold=6 };
/*      0      5      6      7      6      */
```

Each unscoped enumeration constant must be unique within the scope in which the enumeration is defined. In the following example, the second declarations of `average` and `poor` cause compiler errors:

```
func()
{
    enum score { poor, average, good };
    enum rating { below, average, above };
    int poor;
}
```

► C++11 ◀ With scoped enumerations, you can avoid such an error, because the enumerators are declared only in the scope of the enumeration, not the scope containing the enumeration. ◀ C++11 ◀

Enumeration variable declarations

You must declare the enumeration data type before you can define a variable having that type.

Enumeration variable declaration syntax

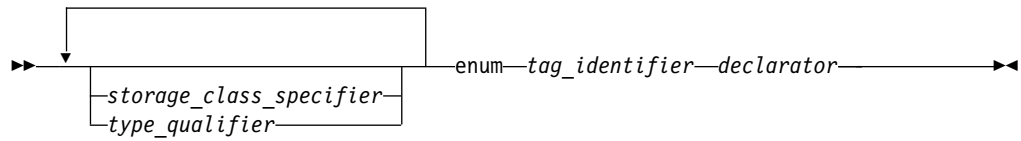

The `tag_identifier` indicates the previously-defined data type of the enumeration.

C++ The keyword `enum` is optional in enumeration variable declarations.
C++

Enumeration type and variable definitions in a single statement

You can define a type and a variable in one statement by using a declarator and an optional initializer after the variable definition. To specify a storage class specifier for the variable, you must put the storage class specifier at the beginning of the declaration. For example:

```
register enum score { poor=1, average, good } rating = good;
```

C++ C++ also lets you put the storage class immediately before the declarator list. For example:

```
enum score { poor=1, average, good } register rating = good;
```

C++

Either of these examples is equivalent to the following two declarations:

```
enum score { poor=1, average, good };  
register enum score rating = good;
```

Both examples define the enumeration data type `score` and the variable `rating`. `rating` has the storage class specifier `register`, the data type `enum score`, and the initial value `good`.

Combining a data type definition with the definitions of all variables having that data type lets you leave the data type unnamed. For example:

```
enum { Sunday, Monday, Tuesday, Wednesday, Thursday, Friday,  
      Saturday } weekday;
```

defines the variable `weekday`, which can be assigned any of the specified enumeration constants. However, you cannot declare any additional enumeration variables using this set of enumeration constants.

Related reference:

“Arithmetic conversions and promotions” on page 148

“Integral types” on page 62

“Initialization of enumerations” on page 131

“Compatibility of structures, unions, and enumerations (C only)”

Compatibility of structures, unions, and enumerations (C only)

Within a single source file, each structure or union definition creates a new type that is neither the same as nor compatible with any other structure or union type. However, a type specifier that is a reference to a previously defined structure or

union type is the same type. The tag associates the reference with the definition, and effectively acts as the type name. To illustrate this, only the types of structures j and k are compatible in this example:

```
struct { int a; int b; } h;  
struct { int a; int b; } i;  
struct S { int a; int b; } j;  
struct S k;
```

Compatible structures may be assigned to each other.

Structures or unions with identical members but different tags are not compatible and cannot be assigned to each other. Structures and unions with identical members but using different alignments are not also compatible and cannot be assigned to each other.

Since the compiler treats enumeration variables and constants as integer types, you can freely mix the values of different enumerated types, regardless of type compatibility. Compatibility between an enumerated type and the integer type that represents it is controlled by compiler options and related pragmas. For a full discussion of the **-qenum** compiler option and related pragmas, see **-qenum** and **#pragma enum** in the *XL C/C++ Compiler Reference*.

Compatibility across separate source files

When the definitions for two structures, unions, or enumerations are defined in separate source files, each file can theoretically contain a different definition for an object of that type with the same name. The two declarations must be compatible, or the run time behavior of the program is undefined. Therefore, the compatibility rules are more restrictive and specific than those for compatibility within the same source file. For structure, union, and enumeration types defined in separately compiled files, the composite type is the type in the current source file.

The requirements for compatibility between two structure, union, or enumerated types declared in separate source files are as follows:

- If one is declared with a tag, the other must also be declared with the same tag.
- If both are completed types, their members must correspond exactly in number, be declared with compatible types, and have matching names.

For enumerations, corresponding members must also have the same values.

For structures and unions, the following additional requirements must be met for type compatibility:

- Corresponding members must be declared in the same order (applies to structures only).
- Corresponding bit fields must have the same widths.

Related reference:

“Arithmetic conversions and promotions” on page 148

Chapter 12, “Classes (C++ only),” on page 325

Structure or union type definition

Incomplete types

typedef definitions

Note: IBM supports selected features of C11, known as C1X before its ratification. IBM will continue to develop and implement the features of this standard. The

implementation of the language level is based on IBM's interpretation of the standard. Until IBM's implementation of all the C11 features is complete, including the support of a new C11 standard library, the implementation may change from release to release. IBM makes no attempt to maintain compatibility, in source, binary, or listings and other compiler interfaces, with earlier releases of IBM's implementation of the C11 features.

You can use the `typedef` declaration to define your own identifiers that can be used in place of type specifiers such as `int`, `float`, and `double`. A `typedef` declaration does not reserve storage. The names you define using `typedef` are not new data types, but synonyms for the data types or combinations of data types they represent.

The name space for a `typedef` name is the same as other identifiers. When an object is defined using a `typedef` identifier, the properties of the defined object are exactly the same as if the object were defined by explicitly listing the data type associated with the identifier.

► C11

Using `typedef` redeclaration, you can redefine a name that is a previous `typedef` name in the same scope to refer to the same type. For example:

```
typedef char AChar;  
typedef char AChar;
```

The `typedef` redeclaration feature can be enabled by any extended language level.

IBM When any extended language level is in effect, `typedef` redeclaration supports all types, including a variably modified type. IBM ◀

For more information about variably modified types, see “Variable length arrays” on page 122.

► C11 ◀

Examples of `typedef` definitions

The following statements define `LENGTH` as a synonym for `int` and then use this `typedef` to declare `length`, `width`, and `height` as integer variables:

```
typedef int LENGTH;  
LENGTH length, width, height;
```

The preceding declarations are equivalent to the following declaration:

```
int length, width, height;
```

Similarly, `typedef` can be used to define a structure, union, or C++ class. For example:

```
typedef struct {  
    int scruples;  
    int drams;  
    int grains;  
} WEIGHT;
```

The structure `WEIGHT` can then be used in the following declarations:

```
WEIGHT chicken, cow, horse, whale;
```

In the following example, the type of `yds` is "pointer to function with no parameters, returning `int`".

```
typedef int SCROLL(void);  
extern SCROLL *yds;
```

In the following typedef definitions, the token `struct` is part of the type name: the type of `ex1` is `struct a`; the type of `ex2` is `struct b`.

```
typedef struct a { char x; } ex1, *ptr1;  
typedef struct b { char x; } ex2, *ptr2;
```

Type `ex1` is compatible with the type `struct a` and the type of the object pointed to by `ptr1`. Type `ex1` is not compatible with `char`, `ex2`, or `struct b`.

C++

In C++, a typedef name must be different from any class type name declared within the same scope. If the typedef name is the same as a class type name, it can only be so if that typedef is a synonym of the class name.

A C++ class defined in a typedef definition without being named is given a dummy name. Such a class cannot have constructors or destructors. Consider the following example:

```
typedef class {  
    ~Trees();  
} Trees;
```

In this example, an unnamed class is defined in a typedef definition. `Trees` is an alias for the unnamed class, but not the class type name. So you cannot define a destructor `~Trees()` for this unnamed class; otherwise, the compiler issues an error.

C++

C++11

Declaring typedef names as friends

In the C++11 standard, the extended friend declarations feature is introduced, with which you can declare typedef names as friends. For more information, see "Extended friend declarations" on page 352.

C++11

Related reference:

"Type names" on page 113

"Type specifiers" on page 61

"Structures and unions" on page 70

Chapter 12, "Classes (C++ only)," on page 325

"Friends" on page 351

The auto type specifier (C++11)

Note: IBM supports selected features of C++11, known as C++0x before its ratification. IBM will continue to develop and implement the features of this standard. The implementation of the language level is based on IBM's interpretation of the standard. Until IBM's implementation of all the C++11 features is complete, including the support of a new C++11 standard library, the implementation might change from release to release. IBM makes no attempt to maintain compatibility, in source, binary, or listings and other compiler interfaces, with earlier releases of IBM's implementation of the new C++11 features.

C++11 introduces the keyword `auto` as a new type specifier. `auto` acts as a placeholder for a type to be deduced from the initializer expression of a variable. With auto type deduction enabled, you no longer need to specify a type while declaring a variable. Instead, the compiler deduces the type of an `auto` variable from the type of its initializer expression.

The following examples demonstrate the usage of auto type deduction.

```
auto x = 1;      //x : int

float* p;
auto x = p;     //x : float*
auto* y = p;    //y : float*

double f();
auto x = f();   //x : double
const auto& y = f(); //y : const double&

class R;
R* h();
auto* x = h();  //x : R*
auto y = h();   //y : R*

int& g();
auto x = g();   //x : int
const auto& y = g(); //y : const int&
auto* z = g();  //error, g() does not return a pointer type
```

By delegating the task of type deduction to the compiler, auto type deduction increases programming convenience, and potentially eliminates typing errors made by programmers. Auto type deduction also reduces the size and improves the readability of programs.

The following two examples demonstrate the benefits of enabling auto type deduction. The first example does not enable auto type deduction.

```
vector<int> vec;
for (vector<int>::iterator i = vec.begin(); i < vec.end(); i++)
{
    int* a = new int(1);
    //...
}
```

With auto type deduction enabled, the first example can be simplified as follows:

```
vector<int> vec;
for (auto i = vec.begin(); i < vec.end(); i++)
{
    auto a = new auto(1);
    //...
}
```

The following rules and constraints apply to the use of `auto` as a type specifier in auto type deduction.

- Auto type deduction cannot deduce array types.

```
int x[5];
auto y[5] = x;    //error, x decays to a pointer,
                 //which does not match the array type
```

- Auto type deduction cannot deduce *cv-qualifier* or reference type from the initializer.

```
int f();
auto& x = f();    //error, cannot bind a non-const reference
                 //to a temporary variable

int& g();
auto y = g();    //y is of type int
auto& z = g();    //z is of type int&
```

- Auto type deduction supports multi-variable auto declarations. If the list of declarators contains more than one declarator, the type of each declarator can be deduced independently. If the deduced type is not the same in each deduction, the program is ill-formed.

```
auto x=3, y=1.2, *z=new auto(1);    //error y: deduced as double,
                                   //but was previously deduced as int
```

- The name of the object that is declared can not be used in its initializer expression.

```
auto x = x++;    //error
```

- `auto` can not be used in function parameters.

```
int func(auto x = 3)    //error
{
    //...
}
```

Note: In C++11, the keyword `auto` is no longer used as a storage class specifier.

Related reference:

“Storage class specifiers” on page 54

“The auto storage class specifier” on page 55

“Type qualifiers” on page 98

“C++11 compatibility” on page 519

The `decltype(expression)` type specifier (C++11)

Note: IBM supports selected features of C++11, known as C++0x before its ratification. IBM will continue to develop and implement the features of this standard. The implementation of the language level is based on IBM's interpretation of the standard. Until IBM's implementation of all the C++11 features is complete, including the support of a new C++11 standard library, the implementation might change from release to release. IBM makes no attempt to maintain compatibility, in source, binary, or listings and other compiler interfaces, with earlier releases of IBM's implementation of the new C++11 features.

The `decltype(expression)` specifier is a type specifier introduced in C++11. With this type specifier, you can get a type that is based on the resultant type of a possibly type-dependent expression.

`decltype(expression)` takes *expression* as an operand. When you define a variable by using `decltype(expression)`, it can be thought of as being replaced by the compiler with the type or the derived type of *expression*. Consider the following example:

```
int i;
static const decltype(i) j = 4;
```

In this example, `decltype(i)` is equivalent to the type name `int`.

General rules for using `decltype`

When you use `decltype(expression)` to get a type, the following rules are applicable:

1. If *expression* is an unparenthesized *id-expression* or class member, `decltype(expression)` is the type of the entity named by *expression*. If there is no such entity, or if *expression* names a set of overloaded functions, the program is ill formed.
2. Otherwise, if *expression* is an xvalue, `decltype(expression)` is `T&&`, where *T* is the type of *expression*.
3. Otherwise, if *expression* is an lvalue, `decltype(expression)` is `T&`, where *T* is the type of *expression*.
4. Otherwise, `decltype(expression)` is the type of *expression*.

The following example illustrates how these rules are used:

```
const int* g(){
    return new int[0];
}

int&& fun(){
    int&& var = 1;
    return 1;
}

struct A{
    double x;
};

template <class T> T tf(const T& t){
    return t;
}

bool f(){
    return false;
}

struct str1{
    template <typename T, typename U>
    static decltype((*T*)0) * ((*U*)0)) mult(const U& arg1, const T& arg2){
        return arg1 * arg2;
    }
};

template <typename T, typename U> struct str2{
    typedef decltype((*T*)0) + ((*U*)0)) btype;
    static btype g(T t, U u);
};

int main(){
    int i = 4;
    const int j = 6;
    const int& k = i;
    int&& m = 1;
    int a[5];
    int *p;

    decltype(i) var1;           // int
    decltype(1) var2;          // int
    decltype(2+3) var3;        // int(+ operator returns an rvalue)
```

```

decltype(i=1) var4 = i;      // int&, because assignment to int
                             // returns an lvalue
decltype((i)) var5 = i;    // int&
decltype(j) var6 = 1;      // const int
decltype(k) var7 = j;      // const int&
decltype("decltype") var8 = "decltype"; // const char(&)[9]
decltype(a) var9;          // int[5]
decltype(a[3]) var10 = i;  // int&([] returns an lvalue)
decltype(*p) var11 = i;    // int&(*operator returns an lvalue)
decltype(fun()) var12 = 1; // int&&
decltype(tf(A())) var13;   // A
decltype(f()) var14;       // bool
decltype((f())) var15;    // bool, parentheses around f() are ignored
decltype(f) var16;        // bool()
decltype(&f) var17;        // bool(*)()
decltype(&A::x) var18;     // double A::*
decltype(str1::mult(3.0, 4u)) var19; // double
decltype(str2<float, short>::g(1,3)) var20; // float
decltype(m) var21 = 1;     // int&&
decltype((m)) var22 = m;  // int&
return 0;
}

```

In this example, the comment after each `decltype` statement explains the type of the defined variable.

The following example illustrates an incorrect usage of `decltype(expression)`:

```

int func(){
    return 0;
}
int func(int a){
    return 0;
}

int main(){
    int i = 4;

    // Incorrect usage. func names an overload function
    decltype(func) var1;

    // Correct usage. The overload operation is not ambiguous
    decltype(func(i)) var2;

    return 0;
}

```

In this example, the compiler issues an error message because it does not know which `func` function to match.

Rules for using `decltype` with structure member variables

When you use `decltype(expression)` to get a type, and `expression` is an unparenthesized member variable of an *object expression* (with a `.` operator) or a *pointer expression* (with a `->` operator), the following rules apply:

- If the object expression or the pointer expression is specified with a constant or volatile qualifier, the type qualifier does not contribute to the result of `decltype(expression)`.
- The lvalueness or rvalueness of the object expression or the pointer expression does not affect whether `decltype(expression)` is a reference type or not.

Example:

```

struct Foo{
    int x;
};

int main(){
    struct Foo f;
    const struct Foo g = {0};
    volatile struct Foo* h = &f;
    struct Foo func();

    decltype(g.x) var1;        // int
    decltype(h->x) var2;       // int
    decltype(func().x) var3;   // int
    return 0;
}

```

In this example, the constant qualifier of the object expression `g` is not desired in the result of `decltype(g.x)`. Similarly, the volatile qualifier of the pointer expression `h` is not desired in the result of `decltype(h->x)`. The object expression `g` and the pointer expression `h` are lvalues, and the object expression `func()` is an rvalue, but they do not affect whether the `decltype` results of their unparenthesized member variables are reference types or not.

If *expression* declared in `decltype(expression)` is a parenthesized nonstatic non-reference class member variable, the constant or volatile type qualifier of the parent object expression or pointer expression of *expression* contributes to the result of `decltype(expression)`. Similarly, the lvalueness or rvalueness of the object expression or the pointer expression affects the result of `decltype(expression)`.

Example:

```

struct Foo{
    int x;
};

int main(){
    int i = 1;
    struct Foo f;
    const struct Foo g = {0};
    volatile struct Foo* h = &f;
    struct Foo func();

    decltype((g.x)) var1 = i;        // const int&
    decltype((h->x)) var2 = i;       // volatile int&
    decltype((func().x)) var3 = 1;   // int
    return 0;
}

```

In this example, the result of `decltype((g.x))` inherits the constant qualifier of the object expression `g`. Similarly, the result of `decltype((h->x))` inherits the volatile qualifier of the pointer expression `h`. The object expression `g` and the pointer expression `h` are lvalues, so `decltype((g.x))` and `decltype((h->x))` are reference types. The object expression `func()` is an rvalue, so `decltype((func().x))` is a nonreference type.

If you use the built-in operators `.*` or `->*` within a `decltype(expression)`, the constant or volatile type qualifier of the parent object expression or pointer expression of *expression* contributes to the result of `decltype(expression)`, regardless of whether *expression* is a parenthesized or an unparenthesized structure member variable. Similarly, the lvalueness or rvalueness of the object expression or the pointer expression affects the result of `decltype(expression)`.

Example:

```
class Foo{
    int x;
};
int main(){
    int i = 0;
    Foo f;
    const Foo & g = f;
    volatile Foo* h = &f;
    const Foo func();

    decltype(f.*&Foo::x) var1 = i;           // int&, f is an lvalue
    decltype(g.*&Foo::x) var2 = i;           // const int&, g is an lvalue
    decltype(h->*&Foo::x) var3 = i;          // volatile int&, h is an lvalue
    decltype((h->*&Foo::x)) var4 = i;        // volatile int&, h is an lvalue
    decltype(func().*&Foo::x) var5 = 1;      // const int, func() is an rvalue
    decltype((func().*&Foo::x)) var6 = 1;    // const int, func() is an rvalue
    return 0;
}
```

Side effects and decltype

If you use `decltype(expression)` to get a type, additional operations in the `decltype` parenthetical context can be performed, but they do not have side effects outside of the `decltype` context. Consider the following example:

```
int i = 5;
static const decltype(i++) j = 4;    // i is still 5
```

The variable *i* is not increased by 1 outside of the `decltype` context.

There are exceptions to this rule. In the following example, because the expression given to `decltype` must be valid, the compiler has to perform a template instantiation:

```
template <int N>
struct Foo{
    static const int n=N;
};
int i;

decltype(Foo<101>::n,i) var = i;    // int&
```

In this example, `Foo` template instantiation occurs, even though `var` is only determined by the type of the variable *i*.

Redundant qualifiers and specifiers with decltype

Because `decltype(expression)` is considered syntactically to be a type specifier, the following redundant qualifiers or specifiers are ignored:

- constant qualifiers
- volatile qualifiers
- & specifiers

The following example demonstrates this case:

```
int main(){
    int i = 5;
    int& j = i;
    const int k = 1;
    volatile int m = 1;

    // int&, the redundant & specifier is ignored
```



```

    decltype(j)& var1 = i;

    // const int, the redundant const qualifier is ignored
    const decltype(k) var2 = 1;

    // volatile int, the redundant volatile qualifer is ignored
    volatile decltype(m) var3;
    return 0;
}

```

Note: The functionality of ignoring the redundant & specifiers in `decltype(expression)` is not supported in the current C++11 standard, but it is implemented in this compiler release.

Template dependent names and decltype

Without using the `decltype` feature, when you pass parameters from one function to another function, you might not know the exact types of the results that are passed back. The `decltype` feature provides a mechanism to generalize the return types easily. The following program shows a generic function that performs the multiplication operation on some operands:

```

struct Math{
    template <typename T>
    static T mult(const T& arg1, const T& arg2){
        return arg1 * arg2;
    }
};

```

If `arg1` and `arg2` are not the same type, the compiler cannot deduce the return type from the arguments. You can use the `decltype` feature to solve this problem, as shown in the following example:

```

struct Foo{
    template<typename T, typename U>
    static decltype((*T*)0)*((*U*)0) mult(const T& arg1, const U& arg2)
    {
        return arg1 * arg2;
    }
};

```

In this example, the return type of the function is the type of the multiplication result of the two template-dependent function parameters.

The typeof operator and decltype

 The `decltype` feature is similar to the existing `typeof` feature. One difference between these two features is that `decltype` accepts only an expression as its operand, while `typeof` can also accept a type name. Consider the following example:

```

__typeof__(int) var1;    // okay
decltype(int) var2;    // error

```

In this example, `int` is a type name, so it is invalid as the operand of `decltype`.

Note: `__typeof__` is an alternate spelling of `typeof`.



Related reference:

“Keywords” on page 15

“Name binding and dependent names” on page 458

“C++11 compatibility” on page 519

“Lvalues and rvalues” on page 159

“References (C++ only)” on page 123

The constexpr specifier (C++11)

Note: IBM supports selected features of C++11, known as C++0x before its ratification. IBM will continue to develop and implement the features of this standard. The implementation of the language level is based on IBM's interpretation of the standard. Until IBM's implementation of all the C++11 features is complete, including the support of a new C++11 standard library, the implementation might change from release to release. IBM makes no attempt to maintain compatibility, in source, binary, or listings and other compiler interfaces, with earlier releases of IBM's implementation of the new C++11 features.

The C++11 standard introduces a new keyword `constexpr` as a declaration specifier. You can apply the `constexpr` specifier only to the following contexts:

- The definition of a variable
- The declaration of a function or function template
- The declaration of a static data member

For example:

```
constexpr int i = 1;    // OK, definition
constexpr extern int j; // Error, not a definition
constexpr int f1();    // OK, function declaration, but must be defined before use
```

If you declare a function that is not a constructor with a `constexpr` specifier, that function is a `constexpr` function. Similarly, if you declare a constructor with a `constexpr` specifier, that constructor is a `constexpr` constructor. Both `constexpr` functions and `constexpr` constructors are implicitly inline. For example:

```
struct S {
    constexpr S(int i) : mem(i) { } // OK, declaration of a constexpr constructor
private:
    int mem;
};
constexpr S s(55); // OK, invocation of a constexpr constructor
```

The `constexpr` specifier has no effect on the type of a `constexpr` function or a `constexpr` constructor. If any declaration of a function or function template is specified with `constexpr`, all its declarations must contain the `constexpr` specifier.

For example:

```
constexpr int f1(); // OK, function declaration
int f1() {          // Error, the constexpr specifier is missing
    return 55;
}
```

Function parameters cannot be declared with the `constexpr` specifier. The following example demonstrates this:

```
constexpr int f4(constexpr int); //Error
```

A `constexpr` specifier used in an object declaration declares the object as `const`. Such an object must be of a literal type and initialized. If it is initialized by a constructor call, that call must be a constant expression. Otherwise, if a `constexpr` specifier is used in a reference declaration, every full expression that appears in its

initializer must be a constant expression. Each implicit conversion used in converting the initializer expressions and each constructor call used for the initialization must be valid in a constant expression. For example:

```
constexpr int var;          // Error, var is not initialized
constexpr int var1 = 1;    // OK

void func() {
    var1 = 5; //Error, var1 is const
}

struct L {
    constexpr L() : mem(55) { }
    constexpr L(double d) : mem((int)d) { }
    L(int i) : mem(i) { }
    operator int() { return mem; }
private:
    int mem;
};

// Error, initializer involves a non-constexpr constructor.
constexpr L var2(55);

double var3 = 55;

// Error, initializer involves a constexpr constructor with non-constant argument
constexpr L var4(var3);

// Error, involves conversion that uses a non-constexpr conversion function
constexpr int var5 = L();
```

A constexpr specifier for a nonstatic member function that is not a constructor declares that member function to be const. The class of that constexpr member function must be a literal type. In the following example, the class NL is a non-literal type because it has a user-provided destructor.

```
struct NL {
    constexpr int f(){          //error, enclosing class is not a literal type
        return 55;
    }
    ~NL() { }
};
```

A call to a constexpr function produces the same result as a call to an equivalent non-constexpr function, except that a call to a constexpr function can appear in a constant expression.

The main function cannot be declared with the constexpr specifier.

Related reference:

“Literals” on page 21

“Constexpr functions (C++11)” on page 289

“Constexpr constructors (C++11)” on page 389

“Generalized constant expressions (C++11)” on page 167

Compatibility of arithmetic types (C only)

Two arithmetic types are compatible only if they are the same type.

The presence of type specifiers in various combinations for arithmetic types may or may not indicate different types. For example, the type `signed int` is the same as `int`, except when used as the types of bit fields; but `char`, `signed char`, and `unsigned char` are different types.

The presence of a type qualifier changes the type. That is, `const int` is not the same type as `int`, and therefore the two types are not compatible.

Type qualifiers

A type qualifier is used to refine the declaration of a variable, a function, and parameters, by specifying whether:

- The value of an object can be changed
- The value of an object must always be read from memory rather than from a register
- More than one pointer can access a modifiable memory address

XL C/C++ recognizes the following type qualifiers:

-  `__align`
- `const`
- `restrict`
- `volatile`

Standard C++ refers to the type qualifiers `const` and `volatile` as *cv-qualifiers*. In both languages, the cv-qualifiers are only meaningful in expressions that are lvalues.

When the `const` and `volatile` keywords are used with pointers, the placement of the qualifier is critical in determining whether it is the pointer itself that is to be qualified, or the object to which the pointer points. For a pointer that you want to qualify as `volatile` or `const`, you must put the keyword between the `*` and the identifier. For example:

```
int * volatile x;      /* x is a volatile pointer to an int */
int * const y = &z;   /* y is a const pointer to the int variable z */
```

For a pointer to a `volatile` or `const` data object, the type specifier and qualifier can be in any order, provided that the qualifier does not follow the `*` operator. For example, for a pointer to a `volatile` data object:

```
volatile int *x;      /* x is a pointer to a volatile int */
```

or

```
int volatile *x;      /* x is a pointer to a volatile int */
```

For a pointer to a `const` data object:



```
const int *y;        /* y is a pointer to a const int */
```

or

```
int const *y;        /* y is a pointer to a const int */
```

The following examples contrast the semantics of these declarations:

Declaration	Description
<code>const int * ptr1;</code>	Defines a pointer to a constant integer: the value pointed to cannot be changed.
<code>int * const ptr2;</code>	Defines a constant pointer to an integer: the integer can be changed, but <code>ptr2</code> cannot point to anything else.
<code>const int * const ptr3;</code>	Defines a constant pointer to a constant integer: neither the value pointed to nor the pointer itself can be changed.

You can put more than one qualifier on a declaration, and the compiler ignores duplicate type qualifiers. This is a C99 language feature.  To be compatible with C99, the XL C/C++ compiler supports it as an IBM extension. 

A type qualifier cannot apply to user-defined types, but only to objects created from a user-defined type. Therefore, the following declaration is illegal:

```
volatile struct omega {
    int limit;
    char code;
}
```

However, if a variable or variables are declared within the same definition of the type, a type qualifier can be applied to the variable or variables by placing it at the beginning of the statement or before the variable declarator or declarators.



Therefore:

```
volatile struct omega {
    int limit;
    char code;
} group;
```

provides the same storage as:

```
struct omega {
    int limit;
    char code;
} volatile group;
```

In both examples, the `volatile` qualifier only applies to the structure variable `group`.

When type qualifiers are applied to a structure,  `class` , or union variable, they also apply to the members of the structure, class or union.

Related reference:

“Pointers” on page 114

“Constant and volatile member functions” on page 338

The `__align` type qualifier (IBM extension)

The `__align` qualifier is a language extension that allows you to specify an explicit alignment for an aggregate or a static (or global) variable. The specified byte boundary affects the alignment of an aggregate as a whole, not that of its members. The `__align` qualifier can be applied to an aggregate definition nested within another aggregate definition, but not to individual elements of an aggregate. The alignment specification is ignored for parameters and automatic variables.

A declaration takes one of the following forms:

`__align` qualifier syntax for simple variables

► `type_specifier __align(—int_constant—) declarator` ◀

`__align` qualifier syntax for structures or unions

► `__align(—int_constant—) [struct | union] tag_identifier` ◀

► `{—member_declaration_list—};` ◀

where *int_constant* is a positive integer value indicating the byte-alignment boundary. Legal values are powers of 2 up to 32768.

The following restrictions and limitations apply:

- The `__align` qualifier cannot be used where the size of the variable alignment is smaller than the size of the type alignment.
- Not all alignments may be representable in an object file.
- The `__align` qualifier cannot be applied to the following:
 - Individual elements within an aggregate definition.
 - Individual elements of an array.
 - Variables of incomplete type.
 - Aggregates declared but not defined.
 - Other types of declarations or definitions, such as a typedef, a function, or an enumeration.

Examples using the `__align` qualifier

Applying `__align` to static or global variables:

```
// varA is aligned on a 1024-byte boundary and padded with 1020 bytes
int __align(1024) varA;
```

```
int main()
{...}
```

```
// varB is aligned on a 512-byte boundary and padded with 508 bytes
static int __align(512) varB;
```

```
// Error
int __align(128) functionB( );
```

```
// Error
typedef int __align(128) T;
```

```
// Error
__align enum C {a, b, c};
```

Applying `__align` to align and pad aggregate tags without affecting aggregate members:

```
// Struct structA is aligned on a 1024-byte boundary
// with size including padding of 1024 bytes.
__align(1024) struct structA
{
    int i;
    int j;
```

```

};

// Union unionA is aligned on a 1024-byte boundary
// with size including padding of 1024 bytes.
__align(1024) union unionA
{
    int i;
    int j;
};

```

Applying **__align** to a structure or union, where the size and alignment of the aggregate using the structure or union is affected:

```

// sizeof(struct S) == 128
__align(128) struct S {int i;};

// sarray is aligned on 128-byte boundary with sizeof(sarray) == 1280
struct S sarray[10];

// Error: alignment of variable is smaller than alignment of type
struct S __align(64) svar;

// s2 is aligned on 128-byte boundary with sizeof(s2) == 256
struct S2 {struct S s1; int a;} s2;

```

Applying **__align** to an array:

In the following example, only arrayA is aligned on a 64-byte boundary, and elements within that array are aligned according to the alignment of AnyType. Padding is applied before the beginning of the array and does not affect the size of the array member itself.

```
AnyType __align(64) arrayA[10];
```

Applying **__align** where the size of the variable alignment differs from the size of the type alignment:

```

__align(64) struct S {int i;};

// Error: alignment of variable is smaller than alignment of type.
struct S __align(32) s1;

// s2 is aligned on 128-byte boundary
struct S __align(128) s2;

// Error
struct S __align(16) s3[10];

// Error
int __align(1) s4;

// Error
__align(1) struct S {int i;};

```

Related reference:

“The aligned variable attribute” on page 141

“The `__alignof__` operator (IBM extension)” on page 175



See Aligning data in the XL C/C++ Optimization and Programming Guide

The **const** type qualifier

The **const** qualifier explicitly declares a data object as something that cannot be changed. Its value is set at initialization. You cannot use **const** data objects in

expressions requiring a modifiable lvalue. For example, a `const` data object cannot appear on the left side of an assignment statement.

C A `const` object cannot be used in constant expressions. A global `const` object without an explicit storage class is considered `extern` by default. **C**

C++ In C++, all `const` declarations must have initializers, except those referencing externally defined constants. A `const` object can appear in a constant expression if it is an integer and it is initialized to a constant. The following example demonstrates this:

```
const int k = 10;
int ary[k];    /* allowed in C++, not legal in C */
```

In C++ a global `const` object without an explicit storage class is considered `static` by default, with internal linkage.

```
const int k = 12; /* Different meanings in C and C++ */

static const int k2 = 120; /* Same meaning in C and C++ */
extern const int k3 = 121; /* Same meaning in C and C++ */
```

Because its linkage is assumed to be internal, a `const` object can be more easily defined in header files in C++ than in C. **C++**

An item can be both `const` and `volatile`. In this case the item cannot be legitimately modified by its own program but can be modified by some asynchronous process.

Related reference:

“The `#define` directive” on page 485

“The `this` pointer” on page 341

The `restrict` type qualifier

This type qualifier is introduced in the C99 standard. **C++** The XL C/C++ compiler supports it as an IBM extension. **C++**

A pointer is the address of a location in memory. More than one pointer can access the same chunk of memory and modify it during the course of a program. The `restrict` (or `__restrict` or `__restrict__`)¹ type qualifier can be applied to a pointer type to form a `restrict`-qualified pointer. During the execution of the block that is associated with the declaration of an object that provides a way to designate a `restrict`-qualified pointer, the memory addressed via the `restrict`-qualified pointer cannot be modified or can be accessed only via this pointer if the pointer does not point to a `const`-qualified type. The compiler may choose to optimize code involving `restrict`-qualified pointers in a way that might otherwise result in incorrect behavior. It is the responsibility of the programmer to ensure that `restrict`-qualified pointers are used as they were intended to be used. Otherwise, undefined behavior may result.

If a particular chunk of memory is not modified, it can be aliased through more than one `restrict` pointer. The following example shows `restrict` pointers as parameters of `foo()`, and how an unmodified object can be aliased through two `restrict` pointers.

```

void foo(int n, int * restrict a, int * restrict b, int * restrict c)
{
    int i;
    for (i = 0; i < n; i++)
        a[i] = b[i] + c[i];
}

```

Assignments between restricted pointers are limited, and no distinction is made between a function call and an equivalent nested block.





```

{
    int * restrict x;
    int * restrict y;
    x = y; // undefined
    {
        int * restrict x1 = x; // okay
        int * restrict y1 = y; // okay
        x = y1; // undefined
    }
}



```

In nested blocks containing restricted pointers, only assignments of restricted pointers from outer to inner blocks are allowed. The exception is when the block in which the restricted pointer is declared finishes execution. At that point in the program, the value of the restricted pointer can be carried out of the block in which it was declared.

Notes:

1. The restrict qualifier is represented by the following keywords (all have the same semantics):
 -  The restrict keyword is recognized under compilation with `xlc` or `c99` or with the `-qlanglvl=stdc99` or `-qlanglvl=extc99` options or `-qkeyword=restrict`. The `__restrict` and `__restrict__` keywords are recognized at all language levels.
 -   The restrict, `__restrict` and `__restrict__` keywords are recognized at `-qlanglvl=extended`. The restrict keyword is also recognized at other language levels with `-qkeyword=restrict`.
2.  Using the `-qrestrict` option is equivalent to adding the restrict keyword to the pointer parameters within the specified functions.

Related reference:

-  See `-qlanglvl` in the XL C/C++ Compiler Reference
-  See `-qkeyword` in the XL C/C++ Compiler Reference
-  See `-qrestrict` in the XL C/C++ Compiler Reference

The volatile type qualifier

The volatile qualifier maintains consistency of memory access to data objects. Volatile objects are read from memory each time their value is needed, and written back to memory each time they are changed. The `volatile` qualifier declares a data object that can have its value changed in ways outside the control or detection of the compiler (such as a variable updated by the system clock or by another program). This prevents the compiler from optimizing code referring to the object by storing the object's value in a register and re-reading it from there, rather than from memory, where it may have changed.

Accessing any lvalue expression that is `volatile`-qualified produces a side effect. A side effect means that the state of the execution environment changes.

References to an object of type "pointer to volatile" may be optimized, but no optimization can occur to references to the object to which it points. An explicit cast must be used to assign a value of type "pointer to volatile T" to an object of type "pointer to T". The following shows valid uses of volatile objects.

```
volatile int * pvol;
int *ptr;
pvol = ptr;           /* Legal */
ptr = (int *)pvol;   /* Explicit cast required */
```

C A signal-handling function may store a value in a variable of type `sig_atomic_t`, provided that the variable is declared `volatile`. This is an exception to the rule that a signal-handling function may not access variables with static storage duration. **C**

An item can be both `const` and `volatile`. In this case the item cannot be legitimately modified by its own program but can be modified by some asynchronous process.

Type attributes (IBM extension)

Type attributes are language extensions provided to facilitate compilation of programs developed with the GNU C/C++ compilers. These language features allow you to use named attributes to specify special properties of data objects. Any variables that are declared as having that type will have the attribute applied to them.

A type attribute is specified with the keyword `__attribute__` followed by the attribute name and any additional arguments the attribute name requires. Although there are variations, the syntax of a type attribute is of the general form:

Type attribute syntax

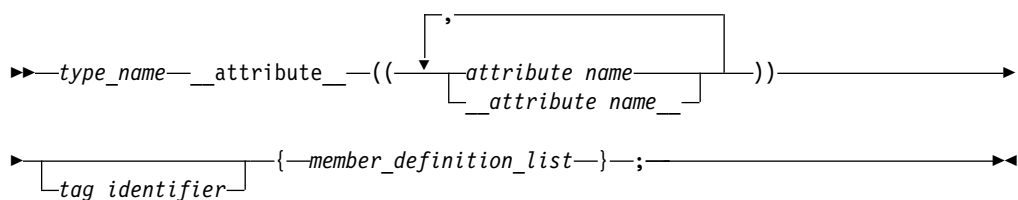

Type attribute syntax — typedef declarations

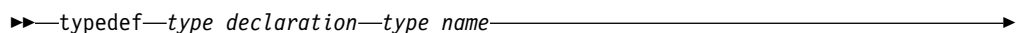

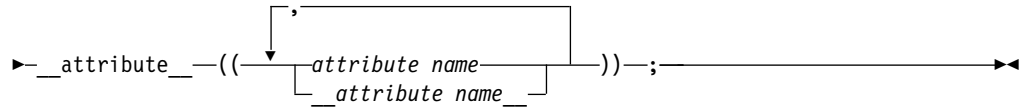

You can specify *attribute name* with or without leading and trailing double underscore characters; however, using the double underscore characters reduces the likelihood of name conflicts with macros of the same name. For unsupported attribute names, the XL C/C++ compiler issues diagnostics and ignores the attribute specification. Multiple attribute names can be specified in the same attribute specification.

The following type attributes are supported:

- “The aligned type attribute”
- “The packed type attribute” on page 107
- “The may_alias type attribute” on page 106
- “The transparent_union type attribute (C only)” on page 107
- “The visibility type attribute” on page 108

Related reference:

- “Variable attributes (IBM extension)” on page 140
- “Function attributes (IBM extension)” on page 268

The aligned type attribute

With the aligned type attribute, you can override the default alignment mode to specify a minimum alignment value, expressed as a number of bytes, for a structure, C++ classes , union, enumeration, or other user-defined type created in a typedef declaration. The aligned attribute is typically used to increase the alignment of any variables declared of the type to which the attribute applies.

aligned type attribute syntax

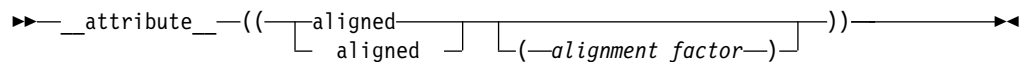

The *alignment_factor* is the number of bytes, specified as a constant expression that evaluates to a positive power of 2. If you omit the alignment factor (and its enclosing parentheses), the compiler automatically uses 16 bytes. You can specify a value up to a maximum 268435456 bytes. If you specify an alignment factor greater than the maximum, the compiler issues an error and the compilation fails.

The alignment value that you specify is applied to all instances of the type. Also, the alignment value applies to the variable as a whole; if the variable is an aggregate, the alignment value applies to the aggregate as a whole, not to the individual members of the aggregate.

Example

In all of the following examples, the aligned attribute is applied to the structure type A. Because a is declared as a variable of type A, it also receives the alignment specification, as any other instances declared of type A.

```

struct __attribute__((_aligned_(8))) A {};
struct __attribute__((_aligned_(8))) A { a; };
typedef struct __attribute__((_aligned_(8))) A { a; };

```

Related reference:

“The `__align` type qualifier (IBM extension)” on page 99

“The aligned variable attribute” on page 141

“The `__alignof__` operator (IBM extension)” on page 175

 See Aligning data in the XL C/C++ Optimization and Programming Guide

The `may_alias` type attribute

You can specify the `may_alias` type attribute for a type so that lvalues of the type can alias objects of any type, similar to a `char` type. Types with the `may_alias` attribute are not subject to type-based aliasing rules.

`may_alias` type attribute syntax

```

▶▶ __attribute__((__may_alias__))

```

You can specify the `may_alias` type attribute in the following ways:

```

struct __attribute__((__may_alias__)) my_struct {} *ps;
typedef long __attribute__((__may_alias__)) t_long;
typedef struct __attribute__((__may_alias__)) my_struct {} t_my_struct;

```

Instead of specifying `-qalias=noansi`, you can alternatively specify the `may_alias` type attribute for a type to violate the ANSI aliasing rules when compiling expressions that contain lvalues of that type. For example:

```

#define __attribute__(x) // Invalidates all __attribute__ declarations
typedef float __attribute__((__may_alias__)) t_float;

int main (void){
    int i = 42;
    t_float *pa = (t_float *) &i;
    *pa = 0;
    if (i == 42)
        return 1;
    return 0;
}

```

If you compile this code with the `-qalias=ansi` option at a high optimization level, such as `-O3`, the executable program returns 1. Because the lvalue `*pa` is of type `float`, according to the ANSI aliasing rules, the assignment to lvalue `*pa` cannot modify the value of `i`, which is of type `int`.

If you remove the `#define __attribute__(x)` statement and compile the code with the same options as before, the executable program returns 0. Because the type of `*pa` is `float __attribute__((__may_alias__))`, `*pa` can alias any other object of any type, and the assignment to lvalue `*pa` can modify the value of `i` to 0.

The use of the `may_alias` type attribute can result in less pessimistic aliasing assumptions by the compiler, leading to more optimization opportunities, compared to usage of the `-qalias=noansi` compiler option.

c This attribute is supported at the extc89, extc99, extended, and extc1x language levels. **c**

C++ This attribute is supported at the extended and extended0x language levels. **C++**

Related reference:

“Type-based aliasing” on page 116

The packed type attribute

The packed type attribute specifies that the minimum alignment should be used for the members of a structure, class, union, or enumeration type. For structure, class, or union types, the alignment is one byte for a member and one bit for a bit field member. For enumeration types, the alignment is the smallest size that will accommodate the range of values in the enumeration. All members of all instances of that type will use the minimum alignment.

packed type attribute syntax

```
►► __attribute__((packed))
```

Unlike the aligned type attribute, the packed type attribute is not allowed in a typedef declaration.

Related reference:

“The `__align` type qualifier (IBM extension)” on page 99

“The packed variable attribute” on page 143

“The `__alignof__` operator (IBM extension)” on page 175

 See Aligning data in the XL C/C++ Optimization and Programming Guide

The transparent_union type attribute (C only)

The `transparent_union` attribute applied to a union definition or a union typedef definition indicates the union can be used as a *transparent union*. The union must be a complete union type.

Whenever a transparent union is the type of a function parameter and that function is called, the transparent union can accept an argument of any type that matches that of one of its members without an explicit cast. Arguments to this function parameter are passed to the transparent union, using the calling convention of the first member of the union type. Because of this, all members of the union must have the same machine representation. Transparent unions are useful in library functions that use multiple interfaces to resolve issues of compatibility.

transparent_union type attribute syntax

```
►► __attribute__((transparent_union))
```

When the `transparent_union` type attribute is applied to the outer union of a nested union, the size of the inner union (that is, its largest member) is used to determine if it has the same machine representation as the other members of the outer union. For example:

```
union u_t{
    union u2_t{
        char a;
        short b;
        char c;
        char d;
    }u;
    int a1;
}__attribute__((transparent_union));
```

The attribute is ignored because the first member of union `u_t`, which is itself a union, has a machine representation of 2 bytes, whereas the other member of union `u_t` is of type `int`, which has a machine representation of 4 bytes.

The same rationale applies to members of a union that are structures. When a member of a union to which type attribute `transparent_union` has been applied is a `struct`, the machine representation of the entire `struct` is considered, rather than members.

All members of the union must have the same machine representation as the first member of the union. This means that all members must be representable by the same amount of memory as the first member of the union. The machine representation of the first member represents the maximum memory size for any remaining union members. For instance, if the first member of a union to which type attribute `transparent_union` has been applied is of type `int`, then all following members must be representable by at most 4 bytes. Members that are representable by 1, 2, or 4 bytes are considered valid for this transparent union.

Floating-point types (`float`, `double`, `float _Complex`, or `double _Complex`) types or vector types can be members of a transparent union, but they cannot be the first member. The restriction that all members of the transparent union have the same machine representation as the first member still applies.

The visibility type attribute

With the visibility type attributes, you can control whether and how a structure/union/class or an enumeration that is defined in one module can be referenced or used in other modules. Visibility attributes affect only types with external linkage. By using this feature, you can make a shared library smaller and decrease the possibility of symbol collision. For details, see *Using visibility attributes in the XL C/C++ Optimization and Programming Guide*.

visibility type attribute syntax

```
►► __attribute__((visibility(visibility) ("default"|"protected"|"hidden"|"internal")))
```

Example

In the following example, the visibility attribute of class `A` is `protected`, and that of enumeration `E` is `hidden`:

```
class __attribute__((visibility("protected"))) A {};  
enum __attribute__((visibility("hidden"))) E {e1,e2} e;
```

Related reference:

“External linkage” on page 12

“The visibility variable attribute” on page 144

“visibility” on page 278

“The visibility namespace attribute (IBM extension)” on page 303

 See Using visibility attributes in the XL C/C++ Optimization and Programming Guide

 See -qvisibility in the XL C/C++ Compiler Reference

 See -qmksprobj in the XL C/C++ Compiler Reference

 See -G in the XL C/C++ Compiler Reference

 See #pragma GCC visibility push, #pragma GCC visibility pop (IBM extension) in the XL C/C++ Compiler Reference

Chapter 5. Declarators

This section continues the discussion of data declarations and includes information on type names, pointers, arrays, [C++](#) references [C++](#), initializers, and variable attributes.

Overview of declarators

A declarator declares an object, function, or [C++](#) reference [C++](#) as part of a declaration.

A declarator has the following form:

Declarator syntax (C only):

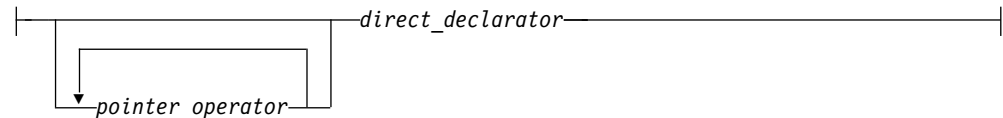

Declarator syntax (C++ only):

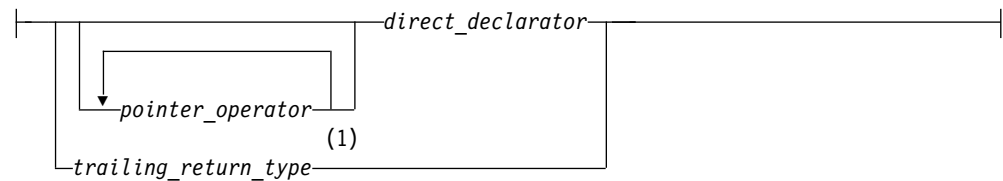

Notes:

1 C++11

Direct declarator:

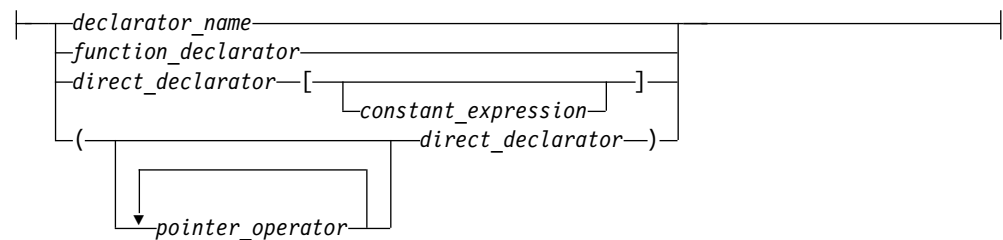

Pointer operator (C only):

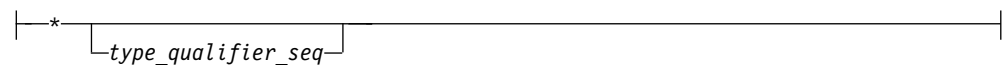

Declarator name (C only):

|—*identifier_expression*—|

Pointer operator (C++ only):

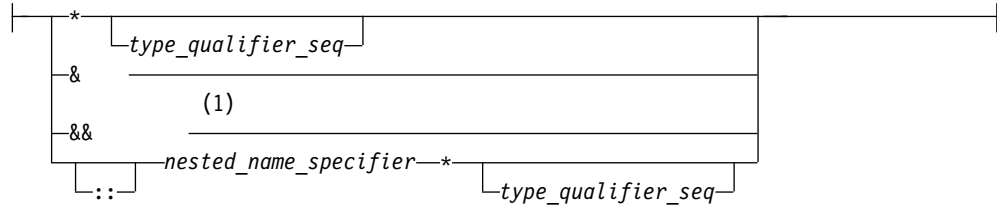



Notes:

1 C++11

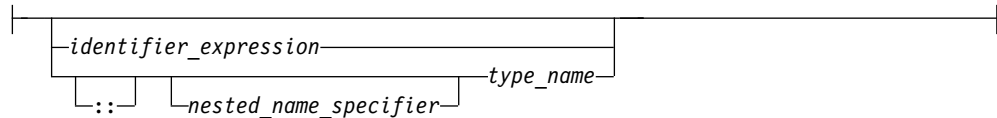

Declarator name (C++ only):



Notes:



- The *type_qualifier_seq* represents one or a combination of type qualifiers. For the details of type qualifiers, see “Type qualifiers” on page 98.
-  A *nested_name_specifier* is a qualified identifier expression. An *identifier_expression* can be a qualified or unqualified identifier. 

For the details of function declarators, see “Function declarators” on page 262.

 For the details of trailing return types, see “Trailing return type (C++11)” on page 266. 

The following types are known as *derived declarator* types, and are therefore discussed in this section:

- “Pointers” on page 114
- “Arrays” on page 120
- “References (C++ only)” on page 123

 In addition, for compatibility with GNU C and C++, XL C/C++ allows you to use *variable attributes* to modify the properties of data objects. As they are normally specified as part of the declarator in a declaration, they are described in “Variable attributes (IBM extension)” on page 140. 

Related reference:

“Initializers” on page 124

“Type qualifiers” on page 98

Examples of declarators

The following table indicates the declarators within the declarations:

Declaration	Declarator	Description
<code>int owner;</code>	<code>owner</code>	owner is an integer data object.
<code>int *node;</code>	<code>*node</code>	node is a pointer to an integer data object.
<code>int names[126];</code>	<code>names[126]</code>	names is an array of 126 integer elements.
<code>volatile int min;</code>	<code>min</code>	min is a volatile integer.
<code>int * volatile volume;</code>	<code>* volatile volume</code>	volume is a volatile pointer to an integer.
<code>volatile int * next;</code>	<code>*next</code>	next is a pointer to a volatile integer.
<code>volatile int * sequence[5];</code>	<code>*sequence[5]</code>	sequence is an array of five pointers to volatile integer data objects.
<code>extern const volatile int clock;</code>	<code>clock</code>	clock is a constant and volatile integer with static storage duration and external linkage.

Related reference:

"Type qualifiers" on page 98

"Array subscripting operator []" on page 190

"Scope resolution operator :: (C++ only)" on page 166

"Function declarators" on page 262

Type names

A *type name*, is required in several contexts as something that you must specify without declaring an object; for example, when writing an explicit cast expression or when applying the `sizeof` operator to a type. Syntactically, the name of a data type is the same as a declaration of a function or object of that type, but without the identifier.

To read or write a type name correctly, put an "imaginary" identifier within the syntax, splitting the type name into simpler components. For example, `int` is a type specifier, and it always appears to the left of the identifier in a declaration. An imaginary identifier is unnecessary in this simple case. However, `int *[5]` (an array of 5 pointers to `int`) is also the name of a type. The type specifier `int *` always appears to the left of the identifier, and the array subscripting operator always appears to the right. In this case, an imaginary identifier is helpful in distinguishing the type specifier.

As a general rule, the identifier in a declaration always appears to the left of the subscripting and function call operators, and to the right of a type specifier, type qualifier, or indirection operator. Only the subscripting, function call, and indirection operators may appear in a type name declaration. They bind according to normal operator precedence, which is that the indirection operator is of lower precedence than either the subscripting or function call operators, which have equal ranking in the order of precedence. Parentheses may be used to control the binding of the indirection operator.

It is possible to have a type name within a type name. For example, in a function type, the parameter type syntax nests within the function type name. The same rules of thumb still apply, recursively.

The following constructions illustrate applications of the type naming rules.

Table 23. Type names

Syntax	Description
<code>int *[5]</code>	array of 5 pointers to <code>int</code>
<code>int (*)[5]</code>	pointer to an array of 5 integers
<code>int (*)[*]</code>	pointer to a variable length array of an unspecified number of integers
<code>int *()</code>	function with no parameter specification returning a pointer to <code>int</code>
<code>int *(void)</code>	function with no parameters returning an <code>int</code>
<code>int (*const [])(unsigned int, ...)</code>	array of an unspecified number of constant pointers to functions returning an <code>int</code> . Each function takes one parameter of type <code>unsigned int</code> and an unspecified number of other parameters.

The compiler turns any function designator into a pointer to the function. This behavior simplifies the syntax of function calls.

```
int foo(float); /* foo is a function designator */
int (*p)(float); /* p is a pointer to a function */
p=&foo; /* legal, but redundant */
p=foo; /* legal because the compiler turns foo into a function pointer */
```

C++ In C++, the keywords `typename` and `class`, which are interchangeable, indicate the name of the type. **C++**

Related reference:

“Operator precedence and associativity” on page 212

“Examples of expressions and precedence” on page 215

“The `typename` keyword” on page 459

“Parenthesized expressions ()” on page 164

Pointers

A *pointer* type variable holds the address of a data object or a function. A pointer can refer to an object of any one data type; it cannot refer to a bit field or a reference.



Some common uses for pointers are:

- To access dynamic data structures such as linked lists, trees, and queues.
- To access elements of an array or members of a structure or C++ class.
- To access an array of characters as a string.
- To pass the address of a variable to a function. (In C++, you can also use a reference to do this.) By referencing a variable through its address, a function can change the contents of that variable.

Note that the placement of the type qualifiers `volatile` and `const` affects the semantics of a pointer declaration. If either of the qualifiers appears before the `*`, the declarator describes a pointer to a type-qualified object. If either of the qualifiers appears between the `*` and the identifier, the declarator describes a type-qualified pointer.

The following table provides examples of pointer declarations.

Table 24. Pointer declarations

Declaration	Description
<code>long *pcoat;</code>	<code>pcoat</code> is a pointer to an object having type <code>long</code>
<code>extern short * const pvolt;</code>	<code>pvolt</code> is a constant pointer to an object having type <code>short</code>
<code>extern int volatile *pnut;</code>	<code>pnut</code> is a pointer to an <code>int</code> object having the <code>volatile</code> qualifier
<code>float * volatile psoup;</code>	<code>psoup</code> is a <code>volatile</code> pointer to an object having type <code>float</code>
<code>enum bird *pfowl;</code>	<code>pfowl</code> is a pointer to an enumeration object of type <code>bird</code>
<code>char (*pvish)(void);</code>	<code>pvish</code> is a pointer to a function that takes no parameters and returns a <code>char</code>
<code> nullptr_t pnull;</code>	<code>pnull</code> is a null pointer that does not point to any valid object or function. 

Related reference:

- “Type qualifiers” on page 98
- “Initialization of pointers” on page 132
- “Compatibility of pointers (C only)” on page 117
- “Pointer conversions” on page 156
- “Address operator `&`” on page 172
- “Indirection operator `*`” on page 173
- “Pointers to functions” on page 287

Pointer arithmetic

You can perform a limited number of arithmetic operations on pointers. These operations are:

- Increment and decrement
- Addition and subtraction
- Comparison
- Assignment

The increment (`++`) operator increases the value of a pointer by the size of the data object the pointer refers to. For example, if the pointer refers to the second element in an array, the `++` makes the pointer refer to the third element in the array.

The decrement (`--`) operator decreases the value of a pointer by the size of the data object the pointer refers to. For example, if the pointer refers to the second element in an array, the `--` makes the pointer refer to the first element in the array.

You can add an integer to a pointer but you cannot add a pointer to a pointer.

If the pointer `p` points to the first element in an array, the following expression causes the pointer to point to the third element in the same array:

```
p = p + 2;
```

If you have two pointers that point to the same array, you can subtract one pointer from the other. This operation yields the number of elements in the array that separate the two addresses that the pointers refer to.

You can compare two pointers with the following operators: `==`, `!=`, `<`, `>`, `<=`, and `>=`.

Pointer comparisons are defined only when the pointers point to elements of the same array. Pointer comparisons using the `==` and `!=` operators can be performed even when the pointers point to elements of different arrays.

You can assign to a pointer the address of a data object, the value of another compatible pointer or the `NULL` pointer.

 Pointer arithmetic is defined for pointer to vector types. Given:

```
vector unsigned int *v;
```

the expression `v + 1` represents a pointer to the vector following `v`. 

Related reference:

“Increment operator `++`” on page 170

“Arrays” on page 120

“Decrement operator `--`” on page 170

Chapter 7, “Expressions and operators,” on page 159

Type-based aliasing

The compiler follows the type-based aliasing rule in the C and C++ standards when the `-qalias=ansi` option is in effect (which it is by default). This rule, also known as the ANSI aliasing rule, states that a pointer can only be dereferenced to an object of the same type or a compatible type.¹

1. The C Standard states that an object shall have its stored value accessed only by an lvalue that has one of the following types:

- the declared type of the object,
- a qualified version of the declared type of the object,
- a type that is the signed or unsigned type corresponding to the declared type of the object,
- a type that is the signed or unsigned type corresponding to a qualified version of the declared type of the object,
- an aggregate or union type that includes one of the aforementioned types among its members (including, recursively, a member of a subaggregate or contained union), or
- a character type

The C++ standard states that if a program attempts to access the stored value of an object through an lvalue of other than one of the following types, the behavior is undefined:

- the dynamic type of the object,
- a cv-qualified version of the dynamic type of the object,
- a type that is the signed or unsigned type corresponding to the dynamic type of the object,
- a type that is the signed or unsigned type corresponding to a cv-qualified version of the dynamic type of the object,
- an aggregate or union type that includes one of the aforementioned types among its members (including, recursively, a member of a subaggregate or contained union),
- a type that is a (possible cv-qualified) base class type of the dynamic type of the object,
- a `char` or unsigned `char` type.

The common coding practice of casting a pointer to an incompatible type and then dereferencing it violates this rule. (Note that char pointers are an exception to this rule)

The compiler uses the type-based aliasing information to perform optimizations to the generated code. Contravening the type-based aliasing rule can lead to unexpected behavior, as demonstrated in the following example:

```
int *p;
double d = 0.0;

int *faa(double *g);      /* cast operator inside the function */

void foo(double f) {
    p = faa(&f);          /* turning &f into an int ptr */
    f += 1.0;             /* The optimizer might move the */
                          /* assignment after the printf statement. */
    printf("f=%x\n", *p);
}

int *faa(double *g) { return (int*) g; } /* questionable cast; */
                                          /* the function can be in */
                                          /* another translation unit */

int main() {
    foo(d);
}
```

In the above printf statement, *p cannot be dereferenced to a double under the ANSI aliasing rule. The compiler determines that the result of f += 1.0 does not affect the value of *p. Thus, the optimizer might move the assignment after the printf statement. If you compile the above example with optimization enabled, the printf statement might output 0 (zero).

Related reference:

“The may_alias type attribute” on page 106

“The reinterpret_cast operator (C++ only)” on page 200



See -qalias in the XL C/C++ Compiler Reference

Compatibility of pointers (C only)

Two pointer types with the same type qualifiers are compatible if they point to objects of compatible types. The composite type for two compatible pointer types is the similarly qualified pointer to the composite type.

The following example shows compatible declarations for the assignment operation:

```
float subtotal;
float * sub_ptr;
/* ... */
sub_ptr = &subtotal;
printf("The subtotal is %f\n", *sub_ptr);
```

The next example shows incompatible declarations for the assignment operation:

```
double league;
int * minor;
/* ... */
minor = &league; /* error */
```

Null pointers

A null pointer has a reserved value that is called a null pointer constant for indicating that the pointer does not point to any valid object or function. You can use null pointers in the following cases:

- Initialize pointers.
- Represent conditions such as the end of a list of unknown length.
- Indicate errors in returning a pointer from a function.

A null pointer constant is an integer constant expression that evaluates to zero. For example, a null pointer constant can be 0, 0L, or such an expression that can be cast to type (void *)0. C++11 C++11 defines a new null pointer constant `nullptr` that can only be converted to any pointer type, pointer-to-member type, or bool type. C++11

You can specify any of the following values for a null pointer constant:

- 0
- NULL
- C++11 `nullptr` C++11

Note: NULL is a macro. It must be defined before use.

Null pointer constants

0 You can use an integer constant expression with the value 0 or an expression that is cast to (void *)0 as a null pointer constant.

NULL The macro NULL and value 0 are equivalent as null pointer constants, but NULL is cleaner because it represents the purpose of using the constant for a pointer.

C++11

nullptr

`nullptr` is an explicit null pointer constant. In C++, initializing null pointers with 0 or NULL have the following problems:

- It is impossible to distinguish between a null pointer and integer 0 for overloaded functions. For example, given two overloaded functions `f(int)` and `f(char*)`, the call `f(0)` resolves to `f(int)` because 0 is converted to the integral type instead of the pointer type. See Example 1.
- A null pointer constant does not have a type-safe name. The macro NULL cannot be distinguished from the 0 constant for overloaded functions and error detection.

To solve the problems of null pointer constants, C++11 introduced a new keyword `nullptr`. The `nullptr` constant can be distinguished from integer 0 for overloaded functions. See Example 2.

A null pointer constant with the `nullptr` value has the following characteristics:

- It can be converted to any pointer or pointer-to-member type.
- It cannot be implicitly converted to any other type, except for the bool type.
- It cannot be used in an arithmetic expression.
- It can be compared with the integer 0.

- It can be used in relational expressions to compare with pointers or data of the `std::nullptr_t` type.

See Example 3 for information about how to use `nullptr` as an initializer for all pointer types and in comparison expressions.

Note: It is still acceptable to assign the value 0 or NULL to a pointer.

The `nullptr` keyword designates a constant rvalue of type `decltype(nullptr)`. The typedef expression is `typedef decltype(nullptr) nullptr_t`, of which `nullptr_t` is a typedef for `decltype(nullptr)` that is defined in `<cstddef>`. A non-type template parameter and argument can have the `std::nullptr_t` type. If a non-type template parameter is of type `std::nullptr_t`, the corresponding argument must be of type `std::nullptr_t`. See Example 4. If a non-type template parameter is of one of the following types, the type of the corresponding non-type template argument can be `std::nullptr_t`. The null pointer conversion occurs for the last three types:

- `std::nullptr_t`
- pointer
- pointer-to-member
- `bool`

When you use `nullptr` in exception handling, pay attention to the `throw` and `catch` arguments. A handler matches the exception object of type `E` if the handler is of type `cv T` or `const T&`. `T` is a pointer or pointer-to-member type and `E` is of type `std::nullptr_t`. See Example 5.

Examples

Example 1

This example illustrates inappropriate use of the NULL constant for overloaded functions:

```
#include <stdio.h>

void func(int* i){
    printf("func(int*)\n");
}

void func(int i){
    printf("func(int)\n");
}

int main(){
    func(NULL);
}
```

Suppose you want the main function to call `func(int* i)`. As a result, the main function calls `func(int i)` instead of `func(int* i)` because the constant `NULL` is equal to the integer 0. Constant 0 is implicitly converted to `(void*)0`, only when `func(int i)` does not exist.

Example 2

This example illustrates how `nullptr` is used in overloading functions:

```

void f( char* );
void f( int );
f( nullptr );    // calls f( char* )
f( 0 );         // calls f( int )

```

Example 3

The following expressions illustrate the correct and incorrect use of the `nullptr` constant:

```

char* p = nullptr;    // p has the null pointer value
char* p1 = 0;        // p has the null pointer value
int a = nullptr;     // error
int a2 = 0;          // a2 is zero of integral type
if( p == 0 );        // evaluates to true
if( p == nullptr ); // evaluates to true
if( p );             // evaluates to false
if( a2 == 0 );       // evaluates to true
if( a2 == nullptr ); // error, no conversion
if( nullptr );      // OK, conversion to the bool type
if( nullptr == 0 ); // OK, comparison with 0
nullptr = 0;        // error, nullptr is not an lvalue
nullptr + 2;       // error

```

Example 4

This example illustrates that a non-type template parameter or argument can have the `std::nullptr_t` type:

```

typedef decltype(nullptr) nullptr_t;
template <nullptr_t> void fun1(); // non-type template parameter

fun1<nullptr>();    // non-type template arguments
fun1<0>();          // error. The corresponding argument must be of type
                  // std::nullptr_t if the parameter is of type std::nullptr_t.

template <int* p> void fun2();
fun2<nullptr>();    //Correct

template<typename T> void h( T t );
h( 0 );            // deduces T = int
h( nullptr );     // deduces T = nullptr_t
h( (float*) nullptr ); // deduces T = float*

```

Example 5

This example illustrates how to use `nullptr` in exception handling:

```

int main() {
try {
    throw nullptr;
} catch(int* p) { // match the pointer.
    return p == 0;
}
}

```

C++11 ◀

Arrays

An *array* is a collection of objects of the same data type, allocated contiguously in memory. Individual objects in an array, called *elements*, are accessed by their position in the array. The subscripting operator (`[]`) provides the mechanics for creating an index to array elements. This form of access is called *indexing* or

subscripting. An array facilitates the coding of repetitive tasks by allowing the statements executed on each element to be put into a loop that iterates through each element in the array.

The C and C++ languages provide limited built-in support for an array type: reading and writing individual elements. Assignment of one array to another, the comparison of two arrays for equality, returning self-knowledge of size are not supported by either language.

The type of an array is derived from the type of its elements, in what is called *array type derivation*. If array objects are of incomplete type, the array type is also considered incomplete. Array elements may not be of type `void` or of function type. However, arrays of pointers to functions are allowed.

▶ C++ Array elements may not be of reference type or of an abstract class type.
▶ C++

The array declarator contains an identifier followed by an optional *subscript declarator*. An identifier preceded by an asterisk (*) is an array of pointers.

Array subscript declarator syntax

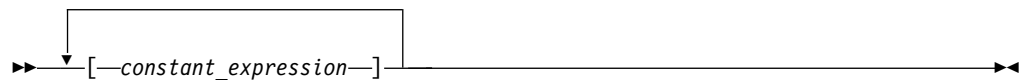

The *constant_expression* is a constant integer expression, indicating the size of the array, which must be positive.

If the declaration appears in block or function scope, a nonconstant expression can be specified for the array subscript declarator, and the array is considered a *variable-length array*, as described in “Variable length arrays” on page 122.

The subscript declarator describes the number of dimensions in the array and the number of elements in each dimension. Each bracketed expression, or subscript, describes a different dimension and must be a constant expression.

The following example defines a one-dimensional array that contains four elements having type `char`:

```
char  
list[4];
```

The first subscript of each dimension is 0. The array `list` contains the elements:

```
list[0]  
list[1]  
list[2]  
list[3]
```

The following example defines a two-dimensional array that contains six elements of type `int`:

```
int  
roster[3][2];
```

Multidimensional arrays are stored in row-major order. When elements are referred to in order of increasing storage location, the last subscript varies the fastest. For example, the elements of array `roster` are stored in the order:

```

roster[0][0]
roster[0][1]
roster[1][0]
roster[1][1]
roster[2][0]
roster[2][1]

```

In storage, the elements of roster would be stored as:

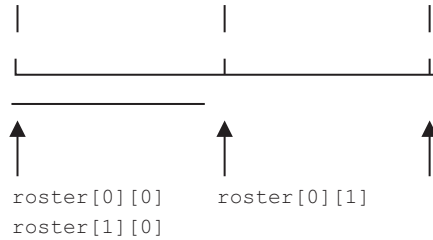

You can leave the first (and only the first) set of subscript brackets empty in:

- Array definitions that contain initializations
- extern declarations
- Parameter declarations

In array definitions that leave the first set of subscript brackets empty, the initializer determines the number of elements in the first dimension. In a one-dimensional array, the number of initialized elements becomes the total number of elements. In a multidimensional array, the initializer is compared to the subscript declarator to determine the number of elements in the first dimension.

Related reference:

“Array subscripting operator []” on page 190

“Initialization of arrays” on page 133

Variable length arrays

A variable length array, which is a C99 feature, is an array of automatic storage duration whose length is determined at run time. C++ The XL C/C++ compiler supports this feature as an IBM extension. C++

Variable length array declarator syntax

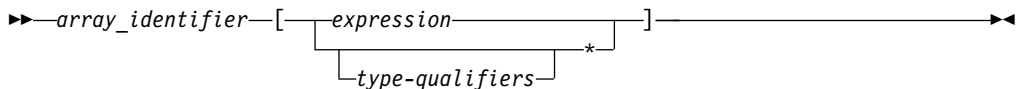

If the size of the array is indicated by * instead of an expression, the variable length array is considered to be of unspecified size. Such arrays are considered complete types, but can only be used in declarations of function prototype scope.

A variable length array and a pointer to a variable length array are considered *variably modified types*. Declarations of variably modified types must be at either block scope or function prototype scope. Array objects declared with the extern storage class specifier cannot be of variable length array type. Array objects declared with the static storage class specifier can be a pointer to a variable length array, but not an actual variable length array. A variable length array cannot be initialized.

Note:  In C++ applications, storage allocated for use by variable length arrays is not released until the function they reside in completes execution.







A variable length array can be the operand of a `sizeof` expression. In this case, the operand is evaluated at run time, and the size is neither an integer constant nor a constant expression, even though the size of each instance of a variable array does not change during its lifetime.

A variable length array can be used in a `typedef` statement. The `typedef` name will have only block scope. The length of the array is fixed when the `typedef` name is defined, not each time it is used.

A function parameter can be a variable length array. The necessary size expressions must be provided in the function definition. The compiler evaluates the size expression of a variably modified parameter on entry to the function. For a function declared with a variable length array as a parameter, as in the following, `void f(int x, int a[][x]);`

the size of the variable length array argument must match that of the function definition.

  The C++ extension does not include support for references to a variable length array type; neither might a function parameter be a reference to a variable length array type.  

Related reference:

Flexible array members

Compatibility of arrays

Two compatible array types must have compatible element types. In addition, if each array has a size specifier that is an integer constant expression, both size specifiers must have the same constant value. For example, the types of the following two arrays are not compatible:

```
char ex1[25];
const char ex2[25];
```

The composite type of two compatible array types is an array with the composite element type. The composite type of two compatible arrays is determined by the following rules:

1. If one of the original types is an array of known constant size, the composite type is an array of that size. For example:

```
// The composite type is char [42].
char ex3[];
char ex4[42];
```

2. Otherwise, if one of the original types is a variable length array, the composite type is that type.

Related reference:

“External linkage” on page 12

References (C++ only)

A *reference* is an alias or an alternative name for an object or function. All operations applied to an object reference act on the object to which the reference refers. The address of a reference is the address of the aliased object or function.

An lvalue reference type is defined by placing the reference modifier `&` or `lval` and after the type specifier. [C++11](#) An rvalue reference type is defined by placing the reference modifier `&&` or `rval` and after the type specifier. For the details of rvalue references, see **Using rvalue references (C++11)**. [C++11](#) Reference types include both lvalue reference [C++11](#) and rvalue reference [C++11](#) types.

Because arguments of a function are passed by value, a function call does not modify the actual values of the arguments. If a function needs to modify the actual value of an argument or needs to return more than one value, the argument must be *passed by reference* (as opposed to being *passed by value*). Passing arguments by reference can be done using either references or pointers. Unlike C, C++ does not force you to use pointers if you want to pass arguments by reference. The syntax of using a reference is simpler than that of using a pointer. Passing an object by reference enables the function to change the object being referred to without creating a copy of the object within the scope of the function. Only the address of the actual original object is put on the stack, not the entire object.

For example:

```
int f(int&);
int main()
{
    extern int i;
    f(i);
}
```

You cannot tell from the function call `f(i)` that the argument is being passed by reference.

The following types of references are invalid:

- References to NULL
- References to `void`
- References to invalid objects or functions
- References to bit fields
- References to references [C++11](#) except with reference collapsing. See “Reference collapsing (C++11)” on page 216 for more information. [C++11](#)

You also cannot declare arrays of references, pointers to references, and cv-qualifiers on references. If cv-qualifiers are introduced through a typedef or template argument deduction, the cv-qualifiers are ignored.

For information on references to functions, see “Pointers to functions” on page 287.

Related reference:

“Initialization of references (C++ only)” on page 135

“Pointers” on page 114

“Address operator `&`” on page 172

“Pass by reference (C++ only)” on page 283

Initializers

An *initializer* specifies an initial value to a data object and is optional in a data declaration. Whether an initializer is valid for a particular declaration depends on the type and storage class of the object to be initialized.

The initializer consists of the `=` symbol followed by an initial *expression* or a brace-enclosed list of initial expressions separated by commas. Individual

expressions must be separated by commas, and groups of expressions can be enclosed in braces and separated by commas. Braces ({ }) are optional if the initializer for a character string is a string literal. The number of initializers must not be greater than the number of elements to be initialized. The initial expression evaluates to the first value of the data object.

To assign a value to an arithmetic or pointer type, use the simple initializer: = *expression*. For example, the following data definition uses the initializer = 3 to set the initial value of group to 3:

```
int group = 3;
```

You initialize a variable of character type with a character literal (consisting of one character) or with an expression that evaluates to an integer.

C++ You can initialize variables at namespace scope with nonconstant expressions. **C++** **C** You cannot initialize variables at global scope with nonconstant expressions. **C**

Related reference:

“Using class objects” on page 326

Initialization and storage classes

This topic includes descriptions of the following:

- Initialization of automatic variables
- Initialization of static variables
- Initialization of external variables
- Initialization of register variables

Initialization of automatic variables

You can initialize any auto variable except function parameters. If you do not explicitly initialize an automatic object, its value is indeterminate. If you provide an initial value, the expression representing the initial value can be any valid C or C++ expression. The object is then set to that initial value each time the program block that contains the object's definition is entered.

Note that if you use the goto statement to jump into the middle of a block, automatic variables within that block are not initialized.

Note: **C++11** In C++11, the keyword auto is no longer used as a storage class specifier. Instead, it is used as a type specifier. The compiler deduces the type of an auto variable from the type of its initializer expression. For more information, see “The auto type specifier (C++11)” on page 89. **C++11**

Initialization of static variables

You can initialize a static object with a constant expression, or an expression that reduces to the address of a previously declared extern or static object, possibly modified by a constant expression. If you do not explicitly initialize a static (or external) variable, it will have a value of zero of the appropriate type, unless it is a pointer, in which case it will be initialized to NULL.

C A static variable in a block is initialized only one time, prior to program execution, whereas an auto variable that has an initializer is initialized every time it comes into existence. **C**

C++ A static variable in a block can be dynamically initialized when the flow of control passes through its definition in a block for the first time. Dynamic initialization of a static variable can occur with non-constant expressions. A static object of class type will use the default constructor if you do not initialize it.

C++

Initialization of external variables

You can initialize any object with the extern storage class specifier at global scope in C or at namespace scope in C++. The initializer for an extern object must either:

- **C** Appear as part of the definition, and the initial value must be described by a constant expression; **C**
- **C++** Appear as part of the definition. **C++**
- Reduce to the address of a previously declared object with static storage duration. You may modify this object with pointer arithmetic. (In other words, you may modify the object by adding or subtracting an integral constant expression.)

If you do not explicitly initialize an extern variable, its initial value is zero of the appropriate type. Initialization of an extern object is completed by the time the program starts running.

Initialization of register variables

You can initialize any register object except function parameters. If you do not initialize an automatic object, its value is indeterminate. If you provide an initial value, the expression representing the initial value can be any valid C or C++ expression. The object is then set to that initial value each time the program block that contains the object's definition is entered.

Related reference:

“The auto storage class specifier” on page 55

“The static storage class specifier” on page 55

“The extern storage class specifier” on page 57

“The register storage class specifier” on page 58

Designated initializers for aggregate types (C only)

Designated initializers, a C99 feature, are supported for aggregate types, including arrays, structures, and unions. A designated initializer, or *designator*, points out a particular element to be initialized. A *designator list* is a comma-separated list of one or more designators. A designator list followed by an equal sign constitutes a *designation*.

Designated initializers allow for the following flexibility:

- Elements within an aggregate can be initialized in any order.
- The initializer list can omit elements that are declared anywhere in the aggregate, rather than only at the end. Elements that are omitted are initialized as if they are static objects: arithmetic types are initialized to 0; pointers are initialized to NULL.

- Where inconsistent or incomplete bracketing of initializers for multi-dimensional arrays or nested aggregates may be difficult to understand, designators can more clearly identify the element or member to be initialized.

Designator list syntax for structures and unions

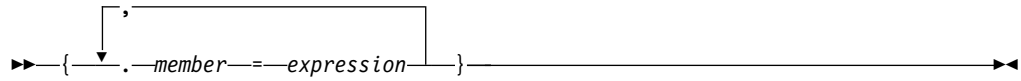

Designator list syntax for arrays

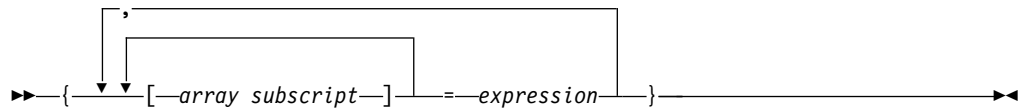

In the following example, the designator is `.any_member` and the designated initializer is `.any_member = 13`:

```
union { /* ... */ } caw = { .any_member = 13 };
```

The following example shows how the second and third members `b` and `c` of structure variable `k1m` are initialized with designated initializers:

```
struct xyz {
    int a;
    int b;
    int c;
} k1m = { .a = 99, .c = 100 };
```

In the following example, the third and second elements of the one-dimensional array `aa` are initialized to 3 and 6, respectively:

```
int aa[4] = { [2] = 3, [1] = 6 };
```

The following example initializes the first four and last four elements, while omitting the middle four:

```
static short grid[3][4] = { [0][0]=8, [0][1]=6,
                           [0][2]=4, [0][3]=1,
                           [2][0]=9, [2][1]=3,
                           [2][2]=1, [2][3]=1 };
```

The omitted four elements of `grid` are initialized to zero:

Element	Value	Element	Value
grid[0][0]	8	grid[1][2]	0
grid[0][1]	6	grid[1][3]	0
grid[0][2]	4	grid[2][0]	9
grid[0][3]	1	grid[2][1]	3
grid[1][0]	0	grid[2][2]	1
grid[1][1]	0	grid[2][3]	1

Designated initializers can be combined with regular initializers, as in the following example:

```
int a[10] = {2, 4, [8]=9, 10}
```

In this example, `a[0]` is initialized to 2, `a[1]` is initialized to 4, `a[2]` to `a[7]` are initialized to 0, and `a[9]` is initialized to 10.

In the following example, a single designator is used to "allocate" space from both ends of an array:

```
int a[MAX] = {
    1, 3, 5, 7, 9, [MAX-5] = 8, 6, 4, 2, 0
};
```

The designated initializer, `[MAX-5] = 8`, means that the array element at subscript `MAX-5` should be initialized to the value 8. If `MAX` is 15, `a[5]` through `a[9]` will be initialized to zero. If `MAX` is 7, `a[2]` through `a[4]` will first have the values 5, 7, and 9, respectively, which are overridden by the values 8, 6, and 4. In other words, if `MAX` is 7, the initialization would be the same as if the declaration had been written:

```
int a[MAX] = {
    1, 3, 8, 6, 4, 2, 0
};
```

You can also use designators to represent members of nested structures. For example:

```
struct a {
    struct b {
        int c;
        int d;
    } e;
    float f;
} g = {.e.c = 3};
```

initializes member `c` of structure variable `e`, which is a member of structure variable `g`, to the value of 3.

Related reference:

"Initialization of structures and unions" on page 129

"Initialization of arrays" on page 133

Initialization of vectors (IBM extension)

A vector type is initialized by a vector literal or any expression having the same vector type. For example:

```
vector unsigned int v = (vector unsigned int)(10);
```

The `Altivec` specification allows a vector type to be initialized by an initializer list. This feature is an extension for compatibility with GNU C.

Unlike vector literals, the values in the initializer list do not have to be constant expressions except in contexts where a constant value is required; `> c` the initialization of a global vector variable is one such context. `< c` Thus, the following code is legal:



```
int i=1;
int function() { return 2; }
int main()
{
    vector unsigned int v1 = {i, function()};
    return 0;
}
```

Initialization of structures and unions

An initializer for a structure is a brace-enclosed comma-separated list of values, and for a union, a brace-enclosed single value. The initializer is preceded by an equal sign (=).

C99 and C++ allow the initializer for an automatic member variable of a union or structure type to be a constant or non-constant expression.

There are two ways to specify initializers for structures and unions:

- With C89-style initializers, structure members must be initialized in the order declared, and only the first member of a union can be initialized.
-  Using *designated* initializers, a C99 feature which allows you to *name* members to be initialized, structure members can be initialized in any order, and any (single) member of a union can be initialized. Designated initializers are described in detail in “Designated initializers for aggregate types (C only)” on page 126. 

Using C89-style initialization, the following example shows how you would initialize the first union member `birthday` of the union variable `people`:

```
union {
    char birthday[9];
    int age;
    float weight;
} people = {"23/07/57"};
```

 Using a designated initializer in the same example, the following initializes the second union member `age` :

```
union {
    char birthday[9];
    int age;
    float weight;
} people = { .age = 14 };
```



The following definition shows a completely initialized structure:

```
struct address {
    int street_no;
    char *street_name;
    char *city;
    char *prov;
    char *postal_code;
};
static struct address perm_address =
    { 3, "Savona Dr.", "Dundas", "Ontario", "L4B 2A1"};
```

The values of `perm_address` are:

Member	Value
<code>perm_address.street_no</code>	3
<code>perm_address.street_name</code>	address of string "Savona Dr."
<code>perm_address.city</code>	address of string "Dundas"
<code>perm_address.prov</code>	address of string "Ontario"
<code>perm_address.postal_code</code>	address of string "L4B 2A1"

Unnamed structure or union members do not participate in initialization and have indeterminate value after initialization. Therefore, in the following example, the bit field is not initialized, and the initializer 3 is applied to member b:

```
struct {
    int a;
    int :10;
    int b;
} w = { 2, 3 };
```

You do not have to initialize all members of structure variables. If a structure variable does not have an initializer, the initial values of the structure members depend on the storage class associated with the structure variable:

- If a structure variable has static storage, its members are implicitly initialized to zero of the appropriate type.
- If a structure variable has automatic storage, its members have no default initialization.

If a structure variable is partially initialized, all the uninitialized structure members are implicitly initialized to zero no matter what the storage class of the structure variable is. See the following example:

```
struct one {
    int a;
    int b;
    int c;
};
void main(){
    struct one z1;           // Members in z1 do not have default initial values.
    static struct one z2;   // z2.a=0, z2.b=0, and z2.c=0.
    struct one z3 = {1};   // z3.a=1, z3.b=0, and z3.c=0.
}
```

In this example, structure variable z1 has automatic storage, and it does not have an initializer, so none of the members in z1 have default initial values. Structure variable z2 has static storage, and all its members are implicitly initialized to zero. Structure variable z3 is partially initialized, so all its uninitialized members are implicitly initialized to zero.

You do not have to initialize all members of a union. The default initializer for a union with static storage is the default for the first component. A union with automatic storage has no default initialization.

C To initialize only the third and fourth members of the temp_address variable, you could use a designated initializer list, as follows:

```
struct address {
    int street_no;
    char *street_name;
    char *city;
    char *prov;
    char *postal_code;
};
struct address temp_address =
    { .city = "Hamilton", .prov = "Ontario" };
```

C

Related reference:

Structure and union variable declarations

“Explicit initialization with constructors” on page 391

“Assignment operators” on page 181

Initialization of enumerations

The initializer for an enumeration variable contains the = symbol followed by an expression *enumeration_constant*.

C++ In C++, the initializer must have the same type as the associated enumeration type. **C++**

The following statement declares an **C++11** unscoped **C++11** enumeration grain.

```
enum grain { oats, wheat, barley, corn, rice };
```

The following statement defines a variable `g_food` and initializes `g_food` to the value of `barley`. The integer value associated with `barley` is 2.

```
enum grain g_food = barley;
```

C++11

The following rules apply to both the scoped and unscoped enumerations.

- An enumeration cannot be initialized using an integer or enumeration constant from a different enumeration, without an explicit cast.
- An uninitialized enumeration variable has undefined value.

The following statement declares an unscoped enumeration `color`.

```
enum color { white, yellow, green, red, brown };
```

The following statement declares a scoped enumeration `letter` and references the scoped enumerators directly inside the scope of the enumeration. The initial values of `A`, `B`, `C`, and `D` are 0, 1, 1, and 2.

```
enum class letter { A, B, C = B, D = C + 1 };
```

The following statement defines a variable `let1` and initializes `let1` to the value of `A`. The integer value associated with `A` is 0.

```
letter let1 = letter :: A;
```

To reference scoped enumerators outside of the enumeration's scope, you must qualify the enumerators with the name of the enumeration. For example, the following statement is invalid.

```
letter let2 = A; //invalid
```

The keyword `enum` in the following statement is optional and can be omitted.

```
enum letter let3 = letter :: B;
```

The `white` enumerator is visible in the following statement, because `color` is an unscoped enumeration.

```
color color1 = white; // valid
```

Unscoped enumerations can also be qualified with their enumeration scope, for example:

```
color color2 = color :: yellow; // valid
```

You cannot initialize an enumeration with an enumeration constant from a different enumeration or an integer without an explicit cast. For example, the following two statements are invalid.

```
letter let4 = color :: white; // invalid

letter let5 = 1; // invalid
```

You can use explicit cast to initialize an enumeration with an enumeration constant from a different enumeration or an integer. For example, the following two statements are valid.

```
letter let6 = (letter) color :: white; // valid

letter let7 = (letter) 2; // valid
```

C++11 ◀

Related reference:

Enumeration variable declarations

Initialization of pointers

The initializer is an = (equal sign) followed by the expression that represents the address that the pointer is to contain. The following example defines the variables `time` and `speed` as having type `double` and `amount` as having type pointer to a `double`. The pointer `amount` is initialized to point to `total`:

```
double time, speed, *amount = &total;
```

The compiler converts an unsubscripted array name to a pointer to the first element in the array. You can assign the address of the first element of an array to a pointer by specifying the name of the array. The following two sets of definitions are equivalent. Both define the pointer `student` and initialize `student` to the address of the first element in `section`:

```
int section[80];
int *student = section;
```

is equivalent to:

```
int section[80];
int *student = &section[0];
```

You can assign the address of the first character in a string constant to a pointer by specifying the string constant in the initializer. The following example defines the pointer variable `string` and the string constant `"abcd"`. The pointer `string` is initialized to point to the character `a` in the string `"abcd"`.

```
char *string = "abcd";
```

The following example defines `weekdays` as an array of pointers to string constants. Each element points to a different string. The pointer `weekdays[2]`, for example, points to the string `"Tuesday"`.

```
static char *weekdays[ ] ={
    "Sunday", "Monday", "Tuesday", "Wednesday",
    "Thursday", "Friday", "Saturday"
};
```

A pointer can also be initialized to null with any integer constant expression that evaluates to 0, **C++11** ▶ or with the `nullptr` keyword **C++11** ◀. Such a pointer is a null pointer and it does not point to any object. For more information about the null pointer, see “Null pointers” on page 118.

The following examples define pointers with null pointer values:

```
char *a = 0;  
char *b = NULL;
```

▶ C++11

```
char *ch = nullptr;
```

▶ C++11 ◀

Related reference:

“Pointers” on page 114

Initialization of arrays

The initializer for an array is a comma-separated list of constant expressions enclosed in braces ({ }). The initializer is preceded by an equal sign (=). You do not need to initialize all elements in an array. If an array is partially initialized, elements that are not initialized receive the value 0 of the appropriate type. The same applies to elements of arrays with static storage duration. (All file-scope variables and function-scope variables declared with the `static` keyword have static storage duration.)

There are two ways to specify initializers for arrays:

- With C89-style initializers, array elements must be initialized in subscript order.
- ▶ C ◀ Using *designated* initializers, which allow you to specify the values of the subscript elements to be initialized, array elements can be initialized in any order. Designated initializers are described in detail in “Designated initializers for aggregate types (C only)” on page 126. ◀ C ▶

Using C89-style initializers, the following definition shows a completely initialized one-dimensional array:

```
static int number[3] = { 5, 7, 2 };
```

The array `number` contains the following values: `number[0]` is 5, `number[1]` is 7; `number[2]` is 2. When you have an expression in the subscript declarator defining the number of elements (in this case 3), you cannot have more initializers than the number of elements in the array.

The following definition shows a partially initialized one-dimensional array:

```
static int number1[3] = { 5, 7 };
```

The values of `number1[0]` and `number1[1]` are the same as in the previous definition, but `number1[2]` is 0.

▶ C

The following definition shows how you can use designated initializers to skip over elements of the array that you don't want to initialize explicitly:

```
static int number[3] = { [0] = 5, [2] = 7 };
```

The array `number` contains the following values: `number[0]` is 5; `number[1]` is implicitly initialized to 0; `number[2]` is 7.

▶ C ◀

Instead of an expression in the subscript declarator defining the number of elements, the following one-dimensional array definition defines one element for each initializer specified:

```
static int item[ ] = { 1, 2, 3, 4, 5 };
```

The compiler gives `item` the five initialized elements, because no size was specified and there are five initializers.

Initialization of character arrays

You can initialize a one-dimensional character array by specifying:

- A brace-enclosed comma-separated list of constants, each of which can be contained in a character
- A string constant (braces surrounding the constant are optional)

Initializing a string constant places the null character (`\0`) at the end of the string if there is room or if the array dimensions are not specified.

The following definitions show character array initializations:



```
static char name1[ ] = { 'J', 'a', 'n' };
static char name2[ ] = { "Jan" };
static char name3[4] = "Jan";
```

These definitions create the following elements:

Element	Value	Element	Value	Element	Value
<code>name1[0]</code>	J	<code>name2[0]</code>	J	<code>name3[0]</code>	J
<code>name1[1]</code>	a	<code>name2[1]</code>	a	<code>name3[1]</code>	a
<code>name1[2]</code>	n	<code>name2[2]</code>	n	<code>name3[2]</code>	n
		<code>name2[3]</code>	<code>\0</code>	<code>name3[3]</code>	<code>\0</code>

Note that the following definition would result in the null character being lost:

```
static char name3[3]="Jan";
```

 When you initialize an array of characters with a string, the number of characters in the string — including the terminating `'\0'` — must not exceed the number of elements in the array. 

Initialization of multidimensional arrays

You can initialize a multidimensional array using any of the following techniques:

- Listing the values of all elements you want to initialize, in the order that the compiler assigns the values. The compiler assigns values by increasing the subscript of the last dimension fastest. This form of a multidimensional array initialization looks like a one-dimensional array initialization. The following definition completely initializes the array `month_days`:

```
static month_days[2][12] =
{
    31, 28, 31, 30, 31, 30, 31, 31, 30, 31, 30, 31,
    31, 29, 31, 30, 31, 30, 31, 31, 30, 31, 30, 31
};
```

- Using braces to group the values of the elements you want initialized. You can put braces around each element, or around any nesting level of elements. The

following definition contains two elements in the first dimension (you can consider these elements as rows). The initialization contains braces around each of these two elements:

```
static int month_days[2][12] =
{
  { 31, 28, 31, 30, 31, 30, 31, 31, 30, 31, 30, 31 },
  { 31, 29, 31, 30, 31, 30, 31, 31, 30, 31, 30, 31 }
};
```

- Using nested braces to initialize dimensions and elements in a dimension selectively. In the following example, only the first eight elements of the array `grid` are explicitly initialized. The remaining four elements that are not explicitly initialized are automatically initialized to zero.

```
static short grid[3][4] = {8, 6, 4, 1, 9, 3, 1, 1};
```

The initial values of `grid` are:

Element	Value	Element	Value
<code>grid[0][0]</code>	8	<code>grid[1][2]</code>	1
<code>grid[0][1]</code>	6	<code>grid[1][3]</code>	1
<code>grid[0][2]</code>	4	<code>grid[2][0]</code>	0
<code>grid[0][3]</code>	1	<code>grid[2][1]</code>	0
<code>grid[1][0]</code>	9	<code>grid[2][2]</code>	0
<code>grid[1][1]</code>	3	<code>grid[2][3]</code>	0

- **C** Using *designated* initializers. The following example uses designated initializers to explicitly initialize only the last four elements of the array. The first eight elements that are not explicitly initialized are automatically initialized to zero.

```
static short grid[3][4] = { [2][0] = 8, [2][1] = 6,
                           [2][2] = 4, [2][3] = 1 };
```

The initial values of `grid` are:

Element	Value	Element	Value
<code>grid[0][0]</code>	0	<code>grid[1][2]</code>	0
<code>grid[0][1]</code>	0	<code>grid[1][3]</code>	0
<code>grid[0][2]</code>	0	<code>grid[2][0]</code>	8
<code>grid[0][3]</code>	0	<code>grid[2][1]</code>	6
<code>grid[1][0]</code>	0	<code>grid[2][2]</code>	4
<code>grid[1][1]</code>	0	<code>grid[2][3]</code>	1

C

Related reference:

“Arrays” on page 120

“Designated initializers for aggregate types (C only)” on page 126

Initialization of references (C++ only)

When you initialize a reference, you bind that reference to an object, which is not necessarily the object denoted by the initializer expression.

Once a reference has been initialized, it cannot be modified to refer to another object. For example:

```
int num1 = 10;
int num2 = 20;

int &RefOne = num1;           // valid
int &RefOne = num2;           // error, two definitions of RefOne
RefOne = num2;                // assign num2 to num1
int &RefTwo;                  // error, uninitialized reference
int &RefTwo = num2;           // valid
```

Note that the initialization of a reference is not the same as an assignment to a reference. Initialization operates on the actual reference by binding the reference to the object it is an alias for. Assignment operates through the reference on the object referred to.

A reference can be declared without an initializer:

- When it is used in a parameter declaration
- In the declaration of a return type for a function call
- In the declaration of class member within its class declaration
- When the extern specifier is explicitly used

Reference binding

Suppose T and U are two types. If ignoring top-level cv-qualifiers, T is of the same type as U or is a base class of U, T and U are *reference-related*.

Example 1

```
typedef int t1;
typedef const int t2;
```

In this example, t1 and t2 are reference-related.

If T and U are reference-related, and T is at least as cv-qualified as U, T is *reference-compatible* with U. In Example 1, t1 is not reference-compatible with t2, but t2 is reference-compatible with t1.

If an lvalue reference r to type T is to be initialized by an expression e of type U, and T is reference-compatible with U, the reference r can be bound directly to e or a base class subobject of e unless T is an inaccessible or ambiguous base class of U.

Example 2

```
int a = 1;
const int& ra = a;

struct A {};
struct B: A { } b;

A& rb = b;
```

In this example, the const int type is reference-compatible with the int type, so ra can be bound directly to a. Structure A is reference-related to structure B, so rb can be bound directly to b.

If an lvalue reference `r` to type `T` is to be initialized by an expression `e` of type `U`, `r` can be bound to the lvalue result of the conversion of `e` or a base class of `e` if the following conditions are satisfied. In this case, the conversion function is chosen by overload resolution.

- `U` is a class type.
- `T` is not reference-related to `U`.
- `e` can be converted to an lvalue of type `S`, and `T` is reference-compatible with `S`.

Example 3

```
struct A {
    operator int&();
};

const int& x= A();
```

In this example, structure `A` is a class type, and the `const int` type is not reference-related to structure `A`. However, `A` can be converted to an lvalue of type `int`, and `const int` is reference-compatible with `int`, so reference `x` of type `const int` can be bound to the conversion result of `A()`.

By default, the compiler cannot bind a non-const or volatile lvalue reference to an rvalue.

Example 4

```
int& a = 2; // error
const int& b = 1; // ok
```

In this example, the variable `a` is a non-const lvalue reference. The compiler cannot bind `a` to the temporary initialized with the rvalue expression `2`, and issues an error message. The variable `b` is a nonvolatile const lvalue reference, which can be initialized with the temporary initialized with the rvalue expression `1`.

IBM

If you specify the `-qclanglval=compatrvaluebinding` option, the compiler can bind a non-const or volatile lvalue reference to an rvalue of a user-defined type where an initializer is not required. The default value of this option is `-qclanglval=nocompatrvaluebinding`. This compiler behavior conflicts with the rvalue references feature, which does not allow a non-const or volatile lvalue reference to be bound to an rvalue. If both of the features are enabled, the compiler issues an error message. For details of the rvalue references feature, see "Using rvalue references (C++11)" in the *XL C/C++ Optimization and Programming Guide*.

Notes:

- A non-const or volatile lvalue reference cannot be bound to an rvalue of a built-in type.
- A non-const or volatile lvalue reference that is a class member cannot be bound to an rvalue.

IBM

C++11

Suppose an expression `e` of type `U` belongs to one of the following value categories:

- An xvalue
- A class prvalue
- An array prvalue
- A function lvalue

If an rvalue reference or a nonvolatile const lvalue reference *r* to type *T* is to be initialized by the expression *e*, and *T* is reference-compatible with *U*, reference *r* can be initialized by expression *e* and bound directly to *e* or a base class subobject of *e* unless *T* is an inaccessible or ambiguous base class of *U*.

Example 5

```
int& func1();
int& (&&rf1)()=func1;

int&& func2();
int&& rf2 = func2();

struct A{
    int arr[5];
};
int(&&ar_ref)[5] = A().arr;
A&& a_ref = A();
```

In this example, *rf1*, *rf2*, *ar_ref*, and *a_ref* are all rvalue references. *rf1* is bound to the function lvalue *func1*, *rf2* is bound to the xvalue result of the call *func2()*, *ar_ref* is bound to the array prvalue *A().arr*, and *a_ref* is bound to the class prvalue *A()*.

Suppose *r* is an rvalue reference or nonvolatile const lvalue reference to type *T*, and *r* is to be initialized by an expression *e* of type *U*. *r* can be bound to the conversion result of *e* or a base class of *e* if the following conditions are satisfied. In this case, the conversion function is chosen by overload resolution.

- *U* is a class type.
- *T* is not reference-related to *U*.
- *e* can be converted to an xvalue, class prvalue, or function lvalue type of *S*, and *T* is reference-compatible with *S*.

Example 6

```
int i;
struct A {
    operator int&&(){
        return static_cast<int&&>(i);
    }
};

const int& x = A();

int main() {
    assert(&x == &i);
}
```

In this example, structure *A* is a class type, and the `const int` type is not reference-related to structure *A*. However, *A* can be converted to an xvalue of type `int`, and `const int` is reference-compatible with `int`, so reference *x* of `const int` can be initialized with *A()* and bound to variable *i*.

An rvalue reference can be initialized with an lvalue in the following contexts:

- A function lvalue

- A temporary converted from an lvalue
- An rvalue result of a conversion function for an lvalue object that is of a class type

Example 7

```
int i = 1;
int&& a = 2; // ok
int&& b = i; // error
double&& c = i; // ok
```

In this example, the rvalue reference `a` can be bound to the temporary initialized with the rvalue expression `2`, but the rvalue reference `b` cannot be bound to the lvalue expression `i`. You can bind the rvalue reference `c` to the temporary value `1.0` that is converted from the variable `i`.

C++11

Related reference:

“References (C++ only)” on page 123

“Pass by reference (C++ only)” on page 283

“Lvalues and rvalues” on page 159

Initialization of complex types (C11)

When the C11 complex initialization feature is enabled, you can initialize C99 complex types with a value of the form $x + yi$, where x and y can be any floating point value, including `Inf` or `NaN`.

C The C11 complex initialization feature can be enabled by the `-qlanglvl=extc1x` group option. **C**

C++ The C11 complex initialization feature can be enabled by the `-qlanglvl=extended` or `-qlanglvl=extended0x` group option. You can also use the `-qlanglvl=complexinit` suboption to enable this feature. When you specify the `-qlanglvl=nocomplexinit` option, only the C11 form of complex initialization is disabled. **C++**

C To enable the initialization of these complex types, macros `CMPLX`, `CMPLXF`, and `CMPLXL` are defined inside the standard header file `complex.h` for C11 compilation, which act as if the following functions are used.

```
float complex CMPLXF( float x, float y );
double complex CMPLX( double x, double y );
long double complex CMPLXL( long double x, long double y );
```

Note: These macros might infringe upon user namespaces. You must avoid using the macro names for other purposes.

C

These macros are available only if the C language header file `complex.h` is included, and they result in values that are suitable for static initialization if arguments are suitable for static initialization. **C++** To use the C language header file `complex.h` in C++ programs, you must specify the `-qlanglvl=c99complexheader` or `-qlanglvl=c99complex` option. **C++**

The following example shows how to initialize a complex type with a value of the form $x + yi$.

```
// a.c
#include <stdio.h>
#include <complex.h>

double _Complex a = CMPLX(5.0, 1.0/0);

int main(void) {
    double _Complex c = CMPLX(5.0, 1.0/0);
    printf("Value: %e + %e * I\n", __real__(a), __imag__(a));
    printf("Value: %e + %e * I\n", __real__(c), __imag__(c));
}
```

You can specify either of the following commands to compile this program:

C

```
xlc -qlanglvl=extc1x a.c
```

C

C++

```
xlc -qlanglvl=c99complexheader a.c -+
```

C++

The result of running the program is:

```
Value: 5 + Inf * I
```

```
Value: 5 + Inf * I
```

Related reference:

“C11 compatibility” on page 512

“Floating-point literals” on page 26

“Floating-point types” on page 64



See `-qlanglvl` in the XL C/C++ Compiler Reference

Variable attributes (IBM extension)

Variable attributes are language extensions provided to facilitate the compilation of programs developed with the GNU C/C++ compilers. These language features allow you to use named attributes to specify special properties of data objects. *Variable* attributes apply to the declarations of simple variables, aggregates, and member variables of aggregates.

A variable attribute is specified with the keyword `__attribute__` followed by the attribute name and any additional arguments the attribute name requires. A variable `__attribute__` specification is included in the declaration of a variable, and can be placed before or after the declarator. Although there are variations, the syntax generally takes either of the following forms:

Variable attribute syntax: post-declarator

► `declarator` `__attribute__` `((` `attribute name` `)` `)` ►

Variable attribute syntax: pre-declarator

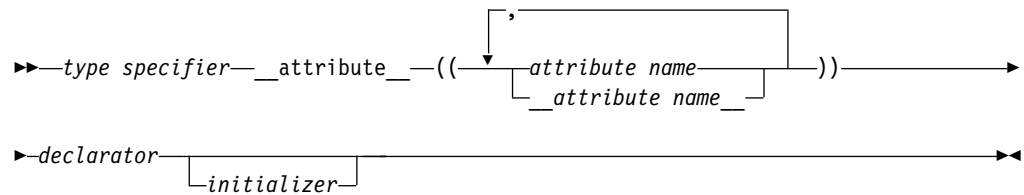

You can specify *attribute name* with or without leading and trailing double underscore characters; however, using the double underscore characters reduces the likelihood of name conflicts with macros of the same name. For unsupported attribute names, the XL C/C++ compiler issues diagnostics and ignores the attribute specification. Multiple attribute names can be specified in the same attribute specification.

In a comma-separated list of declarators on a single declaration line, if a variable attribute appears before all the declarators, it applies to all declarators in the declaration. If the attribute appears after a declarator, it only applies to the immediately preceding declarator. For example:

```
struct A{
    int b __attribute__((aligned));           // typical placement of variable attribute
    int __attribute__((aligned)) c;         // variable attribute can also be placed here
    int d, e, f __attribute__((aligned));   // attribute applies to f only
    int g __attribute__((aligned)), h, i;   // attribute applies to g only
    int __attribute__((aligned)) j, k, l;   // attribute applies to j, k, and l
};
```

The following variable attributes are supported:

- “The aligned variable attribute”
- “The mode variable attribute” on page 142
- “The packed variable attribute” on page 143
- “The `tls_model` attribute” on page 143
- “The weak variable attribute” on page 144
- “The visibility variable attribute” on page 144

The aligned variable attribute

With the aligned variable attribute, you can override the default memory alignment mode to specify a minimum memory alignment value, expressed as a number of bytes, for any of the following types of variables:

- Non-aggregate variables
- Aggregate variables (such as a structures, classes, or unions)
- Selected member variables

The attribute is typically used to increase the alignment of the given variable.

aligned variable attribute syntax

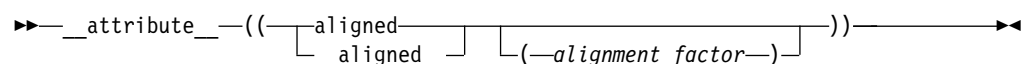

The *alignment_factor* is the number of bytes, specified as a constant expression that evaluates to a positive power of 2. You can specify a value up to a maximum of 268435456. If you omit the alignment factor, and its enclosing parentheses, the compiler automatically uses 16 bytes. If you specify an alignment factor greater than the maximum, the compiler issues an error and the compilation fails.

When you apply the aligned attribute to a member variable in a bit field structure, the attribute specification is applied to the bit field container. If the default alignment of the container is greater than the alignment factor, the default alignment is used.

Example

In the following example, the structures `first_address` and `second_address` are set to an alignment of 16 bytes:

```
struct address {
    int street_no;
    char *street_name;
    char *city;
    char *prov;
    char *postal_code;
} first_address __attribute__((__aligned__(16))) ;

struct address second_address __attribute__((__aligned__(16))) ;
```

In the following example, only the members `first_address.prov` and `first_address.postal_code` are set to an alignment of 16 bytes:

```
struct address {
    int street_no;
    char *street_name;
    char *city;
    char *prov __attribute__((__aligned__(16))) ;
    char *postal_code __attribute__((__aligned__(16))) ;
} first_address ;
```

Related reference:

“The `__align` type qualifier (IBM extension)” on page 99



See *Aligning data in the XL C/C++ Optimization and Programming Guide*

“The `__alignof__` operator (IBM extension)” on page 175

“The aligned type attribute” on page 105

The mode variable attribute

The variable attribute `mode` allows you to override the type specifier in a variable declaration, to specify the size of a particular integral type.

mode variable attribute syntax

```

▶▶ __attribute__((mode(mode) (byte|word|pointer|_byte|_word|_pointer)))
    └──┬──┘
    mode
    └──┬──┘
    byte
    word
    pointer
    └──┬──┘
    _byte
    _word
    _pointer

```

The valid argument for the mode is any of the of the following type specifiers that indicates a specific width:

- `byte` means a 1-byte integer type

- word means a 4-byte integer type
- pointer means a 4-byte integer type in 32-bit mode and an 8-byte integer type in 64-bit mode

The packed variable attribute

The variable attribute `packed` allows you to override the default alignment mode, to reduce the alignment for all members of an aggregate, or selected members of an aggregate to the smallest possible alignment: one byte for a member and one bit for a bit field member.

packed variable attribute syntax

```
▶▶ __attribute__((packed)) ▶▶
```

Related reference:

“The `__align` type qualifier (IBM extension)” on page 99



See *Aligning data in the XL C/C++ Optimization and Programming Guide* “The `__alignof__` operator (IBM extension)” on page 175

The `tls_model` attribute

The `tls_model` attribute allows source-level control for the thread-local storage model used for a given variable. The `tls_model` attribute must specify one of `local-exec`, `initial-exec`, `local-dynamic`, or `global-dynamic` access method, which overrides the `-qtls` option for that variable. For example:

```
__thread int i __attribute__((tls_model("local-exec")));
```

The `tls_model` attribute allows the linker to check that the correct thread model has been used to build the application or shared library. The linker/loader behavior is as follows:

Table 25. Link time/runtime behavior for thread access models

Access method	Link-time diagnostic	Runtime diagnostic
<code>local-exec</code>	Fails if referenced symbol is imported.	Fails if module is not the main program. Fails if referenced symbol is imported (but the linker should have detected the error already).
<code>initial-exec</code>	None.	<code>dlopen()/load()</code> fails if referenced symbol is not in the module loaded at execution time.
<code>local-dynamic</code>	Fails if referenced symbol is imported.	Fails if referenced symbol is imported (but the linker should have detected the error already).
<code>global-dynamic</code>	None.	None.

The weak variable attribute

The weak variable attribute causes the symbol resulting from the variable declaration to appear in the object file as a weak symbol, rather than a global one. The language feature provides the programmer writing library functions with a way to allow variable definitions in user code to override the library declaration without causing duplicate name errors.

weak variable attribute syntax

►► `__attribute__((weak))`

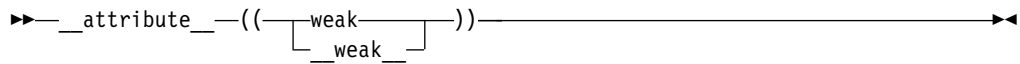

Related reference:



See `#pragma weak` in the XL C/C++ Compiler Reference “weak” on page 277

The visibility variable attribute

The visibility variable attribute describes whether and how a variable defined in one module can be referenced or used in other modules. The visibility attribute affects only variables with external linkage. By using this feature, you can make a shared library smaller and decrease the possibility of symbol collision. For details, see Using visibility attributes in the XL C/C++ Optimization and Programming Guide.

visibility variable attribute syntax

►► `__attribute__((visibility("__visibility__"), ("default"|"protected"|"hidden"|"internal")))`

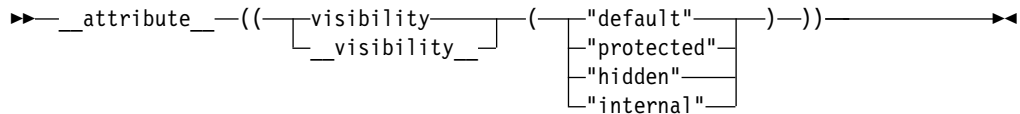

Example

In the following example, the visibility attribute of variable a is protected, and that of variable b is hidden:

```
struct str{
    int var;
};
int a __attribute__((visibility("protected")));
struct str __attribute__((visibility("hidden"))) b;
```

Related reference:

“External linkage” on page 12

“visibility” on page 278

“The visibility type attribute” on page 108

“The visibility namespace attribute (IBM extension)” on page 303



See Using visibility attributes in the XL C/C++ Optimization and Programming Guide



See `-qvisibility` in the XL C/C++ Compiler Reference



See `-qmkshrobj` in the XL C/C++ Compiler Reference

 See `-G` in the XL C/C++ Compiler Reference

 See `#pragma GCC visibility push`, `#pragma GCC visibility pop` (IBM extension) in the XL C/C++ Compiler Reference

Chapter 6. Type conversions

An expression of a given type is *implicitly converted* when it is used in the following situations:

- As an operand of an arithmetic or logical operation.
- As a condition in an `if` statement or an iteration statement (such as a `for` loop). The expression will be converted to a Boolean (or an integer in C89).
- In a `switch` statement. The expression is converted to an integral type.
- As the right operand of an assignment or as an initializer.
- As an initialization. This includes the following types:
 - A function is provided an argument value that has a different type than the parameter.
 - The value specified in the return statement of a function has a different type from the defined return type for the function.

C The implicit conversion result is an rvalue. **C**

C++ The implicit conversion result belongs to one of the following value categories depending on different converted expressions types:

- An lvalue if the type is an lvalue reference type **C++11** or an rvalue reference to a function type **C++11**
- **C++11** An xvalue if the type is an rvalue reference to an object type **C++11**
- A **C++11** (prvalue) **C++11** rvalue in other cases

C++

You can perform *explicit* type conversions using a *cast* expression, as described in “Cast expressions” on page 196.

Vector type casts (IBM extension)

Vector types can be cast to other vector types. The cast does not perform a conversion: it preserves the 128-bit pattern, but not necessarily the value. A cast between a vector type and a scalar type is not allowed.

Vector pointers and pointers to non-vector types can be cast back and forth to each other. When a pointer to a non-vector type is cast to a vector pointer, the address should be 16-byte aligned. The referenced object of the pointer to a non-vector type can be aligned on a 16-byte boundary by using either the `__align` type qualifier or `__attribute__((aligned(16)))`.

Related reference:

“User-defined conversions” on page 401

“Conversion constructors” on page 402

“Conversion functions” on page 404

“The `switch` statement” on page 225

“The `if` statement” on page 223

“The return statement” on page 235

“Lvalues and rvalues” on page 159

“References (C++ only)” on page 123

Arithmetic conversions and promotions

The following sections discuss the rules for the standard conversions for arithmetic types:

- “Integral conversions”
- “Floating-point conversions” on page 149
- “Boolean conversions”

If two operands in an expression have different types, they are subject to the rules of the *usual arithmetic conversions*, as described in “Usual arithmetic conversions” on page 151.

Integral conversions

Unsigned integer to unsigned integer or signed integer to signed integer

If the types are identical, there is no change. If the types are of a different size, and the value can be represented by the new type, the value is not changed; if the value cannot be represented by the new type, truncation or sign shifting will occur.

Signed integer to unsigned integer

The resulting value is the smallest unsigned integer type congruent to the source integer. If the value cannot be represented by the new type, truncation or sign shifting will occur.

Unsigned integer to signed integer

If the signed type is large enough to hold the original value, there is no change. If the value can be represented by the new type, the value is not changed; if the value cannot be represented by the new type, truncation or sign shifting will occur.

Signed and unsigned character types to integer

The character types are promoted to type `int`.

Wide character type `wchar_t` to integer

If the original value can be represented by `int`, it is represented as `int`. If the value cannot be represented by `int`, it is promoted to the smallest type that can hold it: `unsigned int`, `long`, or `unsigned long`.

Signed and unsigned integer bit field to integer

If the original value can be represented by `int`, it is represented as `int`. If the value cannot be represented by `int`, it is promoted to `unsigned int`.

Enumeration type to integer

If the original value can be represented by `int`, it is represented as `int`. If the value cannot be represented by `int`, it is promoted to the smallest type that can hold it: `unsigned int`, `long`, or `unsigned long`. Note that an enumerated type can be converted to an integral type, but an integral type cannot be converted to an enumeration.

Boolean conversions

An unscoped enumeration, pointer, or pointer to member type can be converted to a Boolean type.

► C If the scalar value is equal to 0, the Boolean value is 0; otherwise, the Boolean value is 1. ◀ C

► **C++** A zero, null pointer, or null member pointer value is converted to false. All other values are converted to true. **C++** ◀

► **C++11** A null pointer with the `nullptr` value is converted to false. **C++11** ◀

Floating-point conversions

The standard rule for converting between real floating-point types (binary to binary, decimal to decimal and decimal to binary) is as follows:

If the value being converted can be represented exactly in the new type, it is unchanged. If the value being converted is in the range of values that can be represented but cannot be represented exactly, the result is rounded, according to the current compile-time or runtime rounding mode in effect. If the value being converted is outside the range of values that can be represented, the result is dependent on the rounding mode.

Integer to floating point (binary or decimal)

If the value being converted can be represented exactly in the new type, it is unchanged. If the value being converted is in the range of values that can be represented but cannot be represented exactly, the result is correctly rounded. If the value being converted is outside the range of values that can be represented, the result is quiet NaN.

Floating point (binary or decimal) to integer

The fractional part is discarded (i.e., the value is truncated toward zero). If the value of the integral part cannot be represented by the integer type, the result is one of the following:

- If the integer type is unsigned, the result is the largest representable number if the floating-point number is positive, or 0 otherwise.
- If the integer type is signed, the result is the most negative or positive representable number according to the sign of the floating-point number.

Implicit conversions of decimal floating-point types (IBM extension)

The compiler has the following decimal floating-point types:

- `_Decimal32`
- `_Decimal64`
- `_Decimal128`

The following implicit conversions are always supported:

- Implicit conversions between decimal floating-point types:
 - `_Decimal32` to `_Decimal64`
 - `_Decimal32` to `_Decimal128`
 - `_Decimal64` to `_Decimal32`
 - `_Decimal64` to `_Decimal128`
 - `_Decimal128` to `_Decimal32`
 - `_Decimal128` to `_Decimal64`
- Implicit conversions between decimal floating-point types and the following integer types:
 - signed char, unsigned char
 - signed short int, unsigned short int

- signed int, unsigned int
- signed long int, unsigned long int
- signed long long int, unsigned long long int
- Implicit conversions between decimal floating-point types and Boolean types `bool` or `_Bool`.

Implicit conversions between decimal floating-point types and the following generic floating-point types are supported conditionally. It is supported through assignment operation using the simple assignment operator `=`, initialization, function argument passing and function return statements.

- `float`
- `double`
- `long double`

The following examples demonstrate the implicit conversion from a generic floating-point type to a decimal floating-point type. In this example, variable `f1` is implicitly converted from type `float` to type `_Decimal32` in the initialization.

```
float f1;
_Decimal32 d1 = f1;
```

▶ C++

```
float f1;
_Decimal32 d1(f1);
```

▶ C++

Restriction: You cannot mix decimal floating-point types with generic floating-point types or complex floating-point types in arithmetic expressions unless you use explicit conversions. Here is an example:

```
_Decimal32 d1;
float f1;
float f2 = f1 + d1;           // Incorrect
float f3 = f1 + (float)d1;   // Correct
```

Complex conversions

Complex to complex

If the types are identical, there is no change. If the types are of a different size, and the value can be represented by the new type, the value is not changed; if the value cannot be represented by the new type, both real and imaginary parts are converted according to the standard conversion rule given above.

Complex to real (binary)

The imaginary part of the complex value is discarded. If necessary, the value of the real part is converted according to the standard conversion rule given above.

Complex to real (decimal)

The imaginary part of the complex value is discarded. The value of the real part is converted from binary to decimal floating point, according to the standard conversion rule given above.

Real (binary) to complex

The source value is used as the real part of the complex value, and

converted, if necessary, according to the standard conversion rule given above. The value of the imaginary part is zero.

Real (decimal) to complex

The source value is converted from decimal to binary floating point, according to the standard conversion rule given above, and used as the real part of the complex value. The value of the imaginary part is zero.

Related reference:

“Floating-point types” on page 64

Usual arithmetic conversions

When different arithmetic types are used as operands in certain types of expressions, standard conversions known as *usual arithmetic conversions* are applied.

For example, when the values of two different integral types are added together, both values are first converted to the same type: when a `short int` value and an `int` value are added together, the `short int` value is converted to the `int` type. Chapter 7, “Expressions and operators,” on page 159 provides a list of the operators and expressions that participate in the usual arithmetic conversions.

Conversion ranks for arithmetic types

The ranks in the tables are listed from highest to lowest:

Table 26. Conversion ranks for floating-point types

Operand type
long double or long double _Complex
double or double _Complex
float or float _Complex

▶ IBM

Table 27. Conversion ranks for decimal floating-point types





Operand type
_Decimal128
_Decimal64
_Decimal32

IBM ◀

Table 28. Conversion ranks for integer types

Operand type
long long int, unsigned long long int
long int, unsigned long int
int, unsigned int
short int, unsigned short int
char, signed char, unsigned char
Boolean

Table 28. Conversion ranks for integer types (continued)

Operand type
<p>Notes:</p> <ul style="list-style-type: none"> • The long long int and unsigned long long int types are not included in the C89, C++98 and C++03 standards. •  The wchar_t type is not a distinct type, but rather a typedef for an integer type. The rank of the wchar_t type is equal to the rank of its underlying type.  •  The rank of enumerated type is equal to the rank of its underlying type. 

Rules for decimal floating-point operands

 IBM

In a context where an operation involves two operands, if one of the operands is of decimal floating type, the other operand cannot be a generic floating type, imaginary type, or complex type. The compiler performs the usual arithmetic conversions to bring these two operands to a common type. The floating-point promotions are applied to both operands and the following rules apply to the promoted operands:

1. If both operands have the same type, no conversion is needed.
2. If one operand has the `_Decimal128` type, the other operand is converted to `_Decimal128`.
3. Otherwise, if one operand has the `_Decimal64` type, the other operand is converted to `_Decimal64`.
4. Otherwise, if one operand has the `_Decimal32` type, the other operand is converted to `_Decimal32`.

 IBM

Rules for other floating-point operands

In a context where an operation involves two operands, if either of the operands is of floating-point type, the compiler performs the usual arithmetic conversions to bring these two operands to a common type. The floating-point promotions are applied to both operands. If the rules for decimal floating-point operands do not apply, the following rules apply to the promoted operands:

1. If both operands have the same type, no conversion is needed.
2. Otherwise, if both operands have complex types, the type at a lower integer conversion rank is converted to the type at a higher rank. For more information, see “Floating-point conversions” on page 149.
3. Otherwise, if one operand has a complex type, the type of both operands after conversion is the higher rank of the following types:
 - The complex type corresponding to the type of the generic floating-point operand
 - The type of the complex operand

For more information, see “Floating-point conversions” on page 149.

4. Otherwise, both operands have generic floating types. The following rules apply:
 - a. If one operand has the long double type, the other operand is converted to long double.
 - b. Otherwise, if one operand has the double type, the other operand is converted to double.
 - c. Otherwise, if one operand has the float type, the other operand is converted to float.

Rules for integral operands

In a context where an operation involves two operands, if both of the operands are of integral types, the compiler performs the usual arithmetic conversions to bring these two operands to a common type. The integral promotions are applied to both operands and the following rules apply to the promoted operands:

1. If both operands have the same type, no conversion is needed.
2. Otherwise, if both operands have signed integer types or both have unsigned integer types, the type at a lower integer conversion rank is converted to the type at a higher rank.
3. Otherwise, if one operand has an unsigned integer type and the other operand has a signed integer type, the following rules apply:
 - a. If the rank for the unsigned integer type is higher than or equal to the rank for the signed integer type, the signed integer type is converted to the unsigned integer type.
 - b. Otherwise, if the signed integer type can represent all of the values of the unsigned integer type, the unsigned integer type is converted to the signed integer type.
 - c. Otherwise, both types are converted to the unsigned integer type that corresponds to the signed integer type.

Related reference:

“Integral types” on page 62

“Boolean types” on page 63

“Floating-point types” on page 64

“Character types” on page 65

“Enumerations” on page 79

“Binary expressions” on page 180

Integral and floating-point promotions

The *integral and floating-point promotions* are used automatically as part of the usual arithmetic conversions and default argument promotions. The integral and floating-point promotions do not change either the sign or the magnitude of the value. For more information about the usual arithmetic conversions, see “Usual arithmetic conversions” on page 151.

► C++11

Integral promotion rules for `wchar_t`

If a value is of the `wchar_t` type, the type of the value can be converted to the first of the following types that can represent all the values of the underlying type of `wchar_t`:

- `int`
- `unsigned int`
- `long int`
- `unsigned long int`
- `long long int`
- `unsigned long long int`

If none of the types in the list can represent all the values of the underlying type of `wchar_t`, the `wchar_t` type is converted to the underlying type of `wchar_t`.

C++11 <

Integral promotion rules for bit field

C

The rules apply to the following conditions:

- The `-qurconv` option is in effect.
- The type of an integral bit field is unsigned.
- The type of the integral bit field is smaller than the `int` type.

If all these conditions are satisfied, one of the following rules applies to the promotion of the integral bit field:

- If the `unsigned int` type can represent all the values of the integral bit field, the bit field is converted to `unsigned int`.
- Otherwise, no integral promotion applies to the bit field.

If any of these conditions is not satisfied, one of the following rules applies to the promotion of the integral bit field:

- If the `int` type can represent all the values of the integral bit field, the bit field is converted to `int`.
- Otherwise, if the `unsigned int` type can represent all the values, the bit field is converted to `unsigned int`.
- Otherwise, no integral promotion applies to the bit field.

C

C++

One of the following rules applies to an integral bit field promotion:

- If the `int` type can represent all the values of an integral bit field, the bit field is converted to `int`.
- Otherwise, if the `unsigned int` type can represent all the values, the bit field is converted to `unsigned int`.
- Otherwise, no integral promotion applies to the bit field.

C++ <

Integral promotion rules for Boolean

C If the `-qupconv` option is in effect, a Boolean value is converted to the unsigned int type with its value unchanged. Otherwise, if the `-qnoupconv` option is in effect, a Boolean value is converted to the int type with its value unchanged.

C

C++ If a Boolean value is false, it is converted to an int with a value of 0. If a Boolean value is true, it is converted to an int with a value of 1.

Integral promotion rules for other types

C The rules apply to the following conditions:

- The `-qupconv` option is in effect.
- The type of an integer type other than bit field and Boolean is unsigned.
- The type of the integer type is smaller than the int type.

If all these conditions are satisfied, the integer type is converted to the unsigned int type.

If any of these conditions is not satisfied, one of the following rules applies to the promotion of the integer type:

- If the integer type can be represented by the int type and its rank is lower than the rank of int, the integer type is converted to the int type.
- Otherwise, the integer type is converted to the unsigned int type.

C

C++ One of the following rules applies to the promotion of an integer type other than `wchar_t`, bit field, and Boolean:

- If the integer type can be represented by the int type and its rank is lower than the rank of int, the integer type is converted to the int type.
- Otherwise, the integer type is converted to the unsigned int type.

C++

floating-point promotion rules

The float type can be converted to the double type. The float value is not changed after the promotion.

Related reference:

 See `-qupconv` (C only) in the XL C/C++ Compiler Reference

 See `-qbitfields` in the XL C/C++ Compiler Reference

 See `-qchars` in the XL C/C++ Compiler Reference

Lvalue-to-rvalue conversions

If an lvalue **C++11** or xvalue **C++11** is used in a situation in which the compiler expects a **C++11** (prvalue) **C++11** rvalue, the compiler converts the lvalue **C++11** or xvalue **C++11** to a **C++11** (prvalue) **C++11** rvalue. However, a **C++11** (prvalue) **C++11** rvalue cannot be converted implicitly to an

lvalue `> C++11` or xvalue `< C++11`, `> C++` except by user-defined conversions `< C++`. The following table lists exceptions to this rule.

Situation before conversion	Resulting behavior
The lvalue is a function type.	A pointer to function
The lvalue is an array.	A pointer to the first element of the array
The type of the lvalue <code>> C++11</code> or xvalue <code>< C++11</code> is an incomplete type.	compile-time error
The lvalue <code>> C++11</code> or xvalue <code>< C++11</code> refers to an uninitialized object.	undefined behavior
The lvalue <code>> C++11</code> or xvalue <code>< C++11</code> refers to an object not of the type of the <code>> C++11</code> (prvalue) <code>< C++11</code> rvalue, nor of a type derived from the type of the <code>> C++11</code> (prvalue) <code>< C++11</code> rvalue.	undefined behavior
<code>> C++</code> The lvalue <code>> C++11</code> or xvalue <code>< C++11</code> is a nonclass type, qualified by either const or volatile. <code>< C++</code>	The type after conversion is not qualified by either const or volatile.

Related reference:

“Lvalues and rvalues” on page 159

Pointer conversions

Pointer conversions are performed when pointers are used, including pointer assignment, initialization, and comparison.

`> C` Conversions that involve pointers must use an explicit type cast. The exceptions to this rule are the allowable assignment conversions for C pointers. In the following table, a const-qualified lvalue cannot be used as a left operand of the assignment.

Table 29. Legal assignment conversions for C pointers

Left operand type	Permitted right operand types
pointer to (object) T	<ul style="list-style-type: none"> the constant 0 a pointer to a type compatible with T a pointer to void (void*)
pointer to (function) F	<ul style="list-style-type: none"> the constant 0 a pointer to a function compatible with F

The referenced type of the left operand must have the same or more cv-qualifiers as compared to those of the right operand.

`> C`

Zero constant to null pointer

An integral constant expression that evaluates to zero is a *null pointer constant*. This expression can be converted to a pointer. This pointer is a null pointer (pointer with a zero value), and is guaranteed not to point to any object.

► C++ A constant expression that evaluates to zero can also be converted to the null pointer to a member.

Array to pointer

An lvalue or rvalue with type "array of N ," where N is the type of a single element of the array, to N^* . The result is a pointer to the initial element of the array. This conversion is not performed if the expression is used as the operand of the address operator `&` or the `sizeof` operator ► C++ or when the array is bound to a reference of the array type ► C++ .

Function to pointer

An lvalue that is a function can be converted to a ► C++11 (prvalue) ► C++11 rvalue that is a pointer to a function of the same type, except when the expression is used as the operand of the `&` (address) operator, the `()` (function call) operator, or the `sizeof` operator.

Related reference:

"Pointers" on page 114

"Integer constant expressions" on page 162

"Arrays" on page 120

"Pointers to functions" on page 287

"Pointers to members" on page 340

Ambiguous base classes (C++ only)

"Lvalues and rvalues" on page 159

Conversion to void*

C pointers are not necessarily the same size as type `int`. Pointer arguments given to functions should be explicitly cast to ensure that the correct type expected by the function is being passed. The generic object pointer in C is `void*`, but there is no generic function pointer.

Any pointer to an object, optionally type-qualified, can be converted to `void*`, keeping the same `const` or `volatile` qualifications.

► C The allowable assignment conversions involving `void*` as the left operand are shown in the following table.

Table 30. Legal assignment conversions in C for `void*`

Left operand type	Permitted right operand types
(void*)	<ul style="list-style-type: none">• The constant 0.• A pointer to an object. The object may be of incomplete type.• (void*)

► C

► C++ Pointers to functions cannot be converted to the type `void*` with a standard conversion: this can be accomplished explicitly, provided that a `void*` has sufficient bits to hold it. ► C++

Related reference:

"The void type" on page 66

Reference conversions (C++ only)

A reference conversion can be performed wherever a reference initialization occurs, including reference initialization done in argument passing and function return values. A reference to a class can be converted to a reference to an accessible base class of that class as long as the conversion is not ambiguous. The result of the conversion is a reference to the base class subobject of the derived class object.

Reference conversion is allowed if the corresponding pointer conversion is allowed.

Related reference:

“References (C++ only)” on page 123

“Initialization of references (C++ only)” on page 135

“Function calls” on page 280

“Function return values” on page 262

Function argument conversions

When a function is called, if a function declaration is present and includes declared argument types, the compiler performs type checking. The compiler compares the data types provided by the calling function with the data types that the called function expects and performs necessary type conversions. For example, when function `funct` is called, argument `f` is converted to a `double`, and argument `c` is converted to an `int`:

```
char * funct (double d, int i);

int main(void){
    float f;
    char c;
    funct(f, c) /* f is converted to a double, c is converted to an int */
    return 0;
}
```

If no function declaration is visible when a function is called, or when an expression appears as an argument in the variable part of a prototype argument list, the compiler performs default argument promotions or converts the value of the expression before passing any arguments to the function. The automatic conversions consist of the following:

- The integral and floating-point promotions are performed.
- Arrays or functions are converted to pointers.

Related reference:

“Integral and floating-point promotions” on page 153

“The `transparent_union` type attribute (C only)” on page 107

“Function call expressions” on page 167

“Function calls” on page 280

Chapter 7. Expressions and operators

Expressions are sequences of operators, operands, and punctuators that specify a computation.

The evaluation of expressions is based on the operators that the expressions contain and the context in which they are used. An expression can result in a value and can produce *side effects*. A side effect is a change in the state of the execution environment.

“Operator precedence and associativity” on page 212 provides tables listing the precedence of all the operators described in the various sections listed above.

► C++ C++ operators can be defined to behave differently when applied to operands of class type. This is called operator *overloading*, and is described in “Overloading operators” on page 307. C++ ◀

Lvalues and rvalues

Expressions can be categorized into one of the following value categories:

Lvalue

An expression can appear on the left side of an assignment expression if the expression is not `const` qualified.

► C++11 Xvalue C++11 ◀

An rvalue reference that is to expire.

► C++11 (Prvalue) C++11 ◀ rvalue

A ► C++11 non-xvalue C++11 ◀ expression that appears only on the right side of an assignment expression.

► C++11 Rvalues include both xvalues and prvalues. Lvalues and xvalues can be referred as glvalues. C++11 ◀

Notes:

- Class ► C++11 (prvalue) C++11 ◀ rvalues can be cv-qualified, but non-class ► C++11 (prvalue) C++11 ◀ rvalues cannot be cv-qualified.
- Lvalues ► C++11 and xvalues C++11 ◀ can be of incomplete types, but ► C++11 (prvalue) C++11 ◀ rvalues must be of complete types or void types.

An object is a region of storage that can be examined and stored into. An lvalue ► C++11 or xvalue C++11 ◀ is an expression that refers to such an object. An lvalue does not necessarily permit modification of the object it designates. For example, a `const` object is an lvalue that cannot be modified. The term *modifiable lvalue* is used to emphasize that the lvalue allows the designated object to be changed as well as examined. Lvalues of the following object types are not modifiable lvalues:

- An array type
- An incomplete type
- A `const`-qualified type
- A structure or union type with one of its members qualified as a `const` type

Because these lvalues are not modifiable, they cannot appear on the left side of an assignment statement, `C++` except where a suitable assignment operator exists `C++`.

`C` C defines a *function designator* as an expression that has function type. A function designator is distinct from an object type or an lvalue. It can be the name of a function or the result of dereferencing a function pointer. The C language also differentiates between its treatment of a function pointer and an object pointer.

`C`

`C++` A function call that returns an lvalue reference is an lvalue. Expressions can produce an lvalue, `C++11` an xvalue `C++11`, a `C++11` (prvalue) `C++11` rvalue, or no value. `C++`

Certain `C++` built-in `C++` operators require lvalues for some of their operands. The following table lists these operators and additional constraints on their usage.

Operator	Requirement
& (unary)	Operand must be an lvalue.
++ --	Operand must be a modifiable lvalue. This applies to both prefix and postfix forms.
= += -= *= %= <<= >>= &= ^= =	Left operand must be a modifiable lvalue.

For example, all assignment operators evaluate their right operand and assign that value to their left operand. The left operand must be a modifiable lvalue.

The address operator (&) requires an lvalue as an operand while the increment (++) and the decrement (--) operators require a modifiable lvalue as an operand. The following example shows expressions and their corresponding lvalues.

Expression	Lvalue
<code>x = 42</code>	<code>x</code>
<code>*ptr = newvalue</code>	<code>*ptr</code>
<code>a++</code>	<code>a</code>
<code>C++ f()</code>	The function call to <code>f()</code>

`C++11`

The following expressions are xvalues:

- The result of calling a function whose return type is of an rvalue reference type
- A cast to an rvalue reference
- A nonstatic data member of a non-reference type accessed through an xvalue expression
- A pointer to member access expression in which the first operand is an xvalue expression and the second operand is of a pointer to member type

See the following example:

```
int a;
int&& b= static_cast<int&&>(a);

struct str{
```

```

    int c;
};

int&& f(){
    int&& var =1;
    return var;
}

str&& g();
int&& rc = g().c;

```

In this example, The initializer for rvalue reference b is an xvalue because it is a result of a cast to an rvalue reference. A call to the function f() produces an xvalue because the return type of this function is of the int&& type. The initializer for rvalue reference rc is an xvalue because it is an expression that accesses a nonstatic non-reference data member c through an xvalue expression.

C++11 <

C **IBM** When GNU C language extensions are enabled, compound expressions, conditional expressions, and casts are allowed as lvalues, if their operands are lvalues.

A compound expression can be assigned if the last expression in the sequence is an lvalue. The following expressions are equivalent:

```

(x + 1, y) *= 42;
x + 1, (y *=42);

```

The address operator can be applied to a compound expression, provided the last expression in the sequence is an lvalue. The following expressions are equivalent:

```

&(x + 1, y);
x + 1, &y;

```

A conditional expression can be a valid lvalue if its type is not void and both of its branches for true and false are valid lvalues. Casts are valid lvalues if the operand is an lvalue. The primary restriction is that you cannot take the address of an lvalue cast. **IBM** **C**

Related reference:

“Arrays” on page 120

“Lvalue-to-rvalue conversions” on page 155

“References (C++ only)” on page 123

Primary expressions



Primary expressions fall into the following general categories:

- Names (identifiers)
- Literals (constants)
- Integer constant expressions
- Identifier expressions
- Parenthesized expressions ()
- **C11** Generic selection **C11** <
- **C++** The this pointer (described in “The this pointer” on page 341)
- Names qualified by the scope resolution operator (::) **C++** <

Names

The value of a name depends on its type, which is determined by how that name is declared. The following table shows whether a name is an lvalue expression.

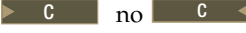
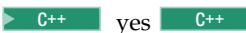
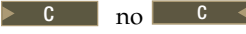
Table 31. Primary expressions: Names

Name declared as	Evaluates to	Is an lvalue?
Variable of arithmetic, pointer, enumeration, structure, or union type	An object of that type	yes
Enumeration constant	The associated integer value	no
Array	That array. In contexts subject to conversions, a pointer to the first object in the array, except where the name is used as the argument to the sizeof operator.	 
Function	That function. In contexts subject to conversions, a pointer to that function, except where the name is used as the argument to the sizeof operator, or as the function in a function call expression.	 

As an expression, a name may not refer to a label, typedef name, structure member, union member, structure tag, union tag, or enumeration tag. Names used for these purposes reside in a namespace that is separate from that of names used in expressions. However, some of these names may be referred to within expressions by means of special constructs: for example, the dot or arrow operators may be used to refer to structure and union members; typedef names may be used in casts or as an argument to the sizeof operator.

Literals

A literal is a numeric constant or string literal. When a literal is evaluated as an expression, its value is a constant. A lexical constant is never an lvalue. However, a string literal is an lvalue.

Related reference:

“Literals” on page 21

“The this pointer” on page 341

Integer constant expressions

An *integer constant* is a value that is determined at compile time and cannot be changed at run time. An *integer constant expression* is an expression that is composed of constants and evaluated to a constant at compile time.

An integer constant expression is an expression that is composed of only the following elements:

- literals
- enumerators
- const variables initialized with compile-time constant expressions or

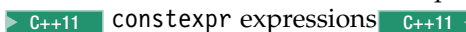

- static const data members initialized with compile-time constant expressions or `C++11` constexpr expressions `C++11`
- casts to integral types
- sizeof expressions, where the operand is not a variable length array

The sizeof operator applied to a variable length array type is evaluated at run time, and therefore is not a constant expression.

You must use an integer constant expression in the following situations:

- In the subscript declarator as the description of an array bound.
- After the keyword case in a switch statement.
- In an enumerator, as the numeric value of an enumeration constant.
- In a bit-field width specifier.
- In the preprocessor #if statement. (Enumeration constants, address constants, and sizeof cannot be specified in a preprocessor #if statement.)

Note: `C++11` The C++11 standard generalizes the concept of constant expressions. For more information, see “Generalized constant expressions (C++11)” on page 167. `C++11`

Related reference:

“The sizeof operator” on page 176

Identifier expressions (C++ only)

An identifier expression, or *id-expression*, is a restricted form of primary expression. Syntactically, an *id-expression* requires a higher level of complexity than a simple identifier to provide a name for all of the language elements of C++.

An *id-expression* can be either a qualified or unqualified identifier. It can also appear after the dot and arrow operators.

Identifier expression syntax

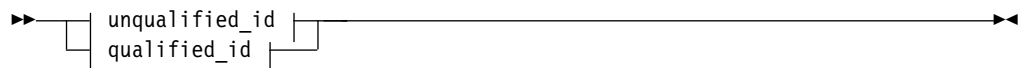

unqualified_id:



qualified_id:

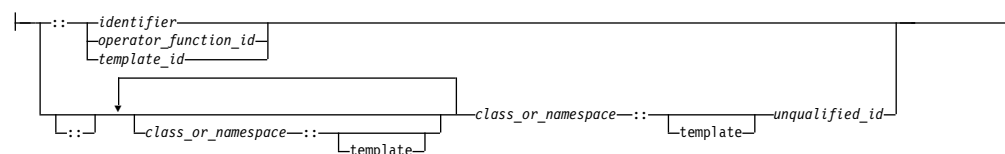

Related reference:

“Identifiers” on page 18

Chapter 5, “Declarators,” on page 111

Parenthesized expressions ()

Use parentheses to explicitly force the order of expression evaluation. The following expression does not use parentheses to group operands and operators. The parentheses surrounding `weight`, `zipcode` are used to form a function call. Note how the compiler groups the operands and operators in the expression according to the rules for operator precedence and associativity:

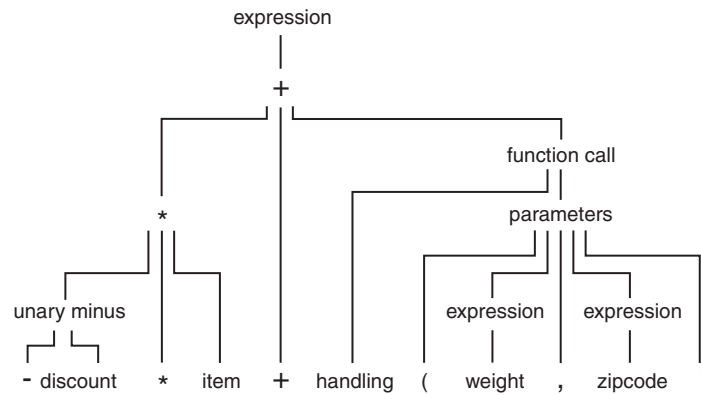

The following expression is similar to the previous expression, but it contains parentheses that change how the operands and operators are grouped:

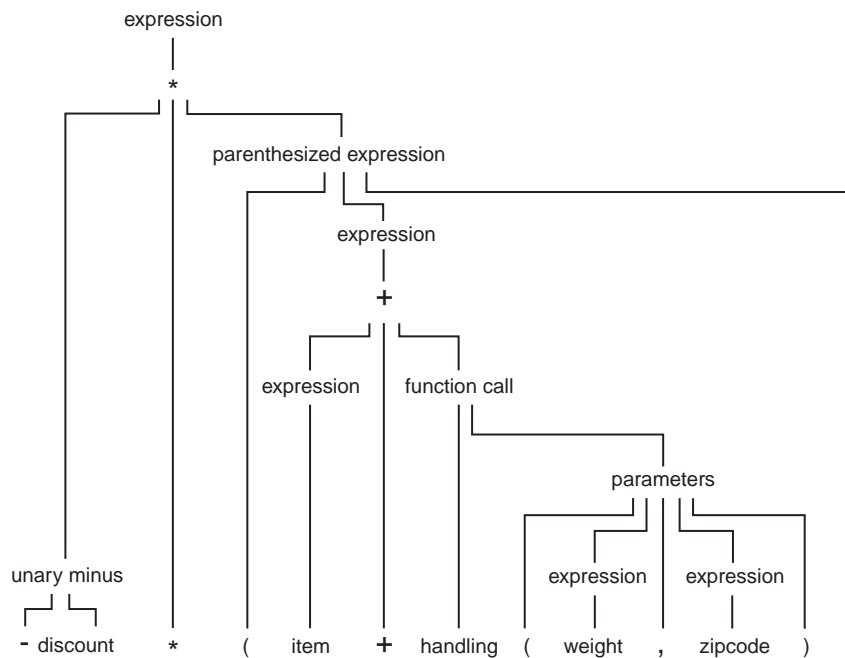

In an expression that contains both associative and commutative operators, you can use parentheses to specify the grouping of operands with operators. The parentheses in the following expression guarantee the order of grouping operands with the operators:

```
x = f + (g + h);
```

Related reference:

“Operator precedence and associativity” on page 212

Generic selection (C11)

A generic selection is a primary expression. Its type and value depend on the selected generic association.

The following diagram shows the generic selection syntax:

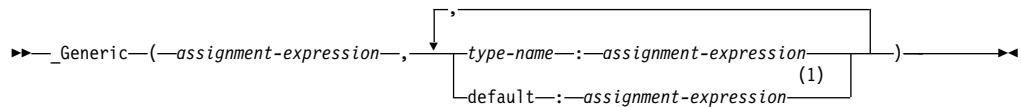

Notes:

1 A generic selection can have at most one default generic association.

where:

type-name

Specifies the type of a generic association. The type name that you specify in a generic association must be a complete object type other than a variably modified type.

assignment-expression

Is an assignment expression. The first assignment expression is called the controlling expression.

The generic association list is a group of generic associations. There are two forms of generic associations:

- type-name: assignment-expression
- default: assignment-expression

One generic selection cannot have two or more generic associations that specify compatible types. In one generic selection, the controlling expression can have at most one compatible type name in the generic association list. If a generic selection has no default generic association, its controlling expression must have exactly one compatible type name in its generic association list.

If there is a generic association with a type name that is compatible with the controlling expression in the generic selection, the expression in the generic selection is the result expression. Otherwise, the result expression of the generic selection is the expression in the default generic association. The controlling expression of a generic selection is not evaluated. None of the expressions from any other generic association of the generic selection is evaluated.

The type and value of a generic selection are identical to those of its result expression. For example, a generic selection is an lvalue, a function designator, or a void expression if its result expression is an lvalue, a function designator, or a void expression.

Example

The following sample `myprogram.c` defines a type-generic macro:

```

#define myfunction(X) _Generic((X), \
    long double:myfunction_longdouble, \
    default:myfunction_double, \
    float:myfunction_float \
)(X)
void myfunction_longdouble(long double x){printf("calling %s\n",__func__);}
void myfunction_double(double x){printf("calling %s\n",__func__);}
void myfunction_float(float x){printf("calling %s\n",__func__);}

int main()
{
    long double ld;
    double d;
    float f;
    myfunction(ld);
    myfunction(d);
    myfunction(f);
}

```

When you execute the program:

```

xlc myprogram.c -qldbl128 -qlanglvl=extc1x
./a.out

```

the result is as follows:

```

calling myfunction_longdouble
calling myfunction_double
calling myfunction_float

```

Scope resolution operator :: (C++ only)

The :: (scope resolution) operator is used to qualify hidden names so that you can still use them. You can use the unary scope operator if a namespace scope or global scope name is hidden by an explicit declaration of the same name in a block or class. For example:

```

int count = 0;

int main(void) {
    int count = 0;
    ::count = 1; // set global count to 1
    count = 2;  // set local count to 2
    return 0;
}

```

The declaration of count declared in the main function hides the integer named count declared in global namespace scope. The statement ::count = 1 accesses the variable named count declared in global namespace scope.

You can also use the class scope operator to qualify class names or class member names. If a class member name is hidden, you can use it by qualifying it with its class name and the class scope operator.

In the following example, the declaration of the variable X hides the class type X, but you can still use the static class member count by qualifying it with the class type X and the scope resolution operator.

```

#include <iostream>
using namespace std;

class X
{
public:
    static int count;
};

```



```

int X::count = 10;           // define static data member

int main ()
{
    int X = 0;              // hides class type X
    cout << X::count << endl; // use static member of class X
}

```

Related reference:

“Scope of class names” on page 329

Chapter 10, “Namespaces (C++ only),” on page 293

Generalized constant expressions (C++11)

The C++11 standard generalizes the concept of constant expressions and introduces a new keyword `constexpr` as a declaration specifier. A constant expression is an expression that can be evaluated at compile time by the compiler. The major benefits of this feature are as follows:

- Improves type safety and portability of code that requires compile-time evaluation
- Improves support for systems programming, library building, and generic programming
- Improves the usability of Standard Library components. Library functions that can be evaluated at compile time can be used in contexts that require constant expressions.

An object declaration with the `constexpr` specifier declares that object to be constant. The `constexpr` specifier can be applied only to the following contexts:

- The definition of an object
- The declaration of a function or function template
- The declaration of a static data member of a literal type

If you declare a function that is not a constructor with a `constexpr` specifier, then that function is a `constexpr` function. Similarly, if you declare a constructor with a `constexpr` specifier, then that constructor is a `constexpr` constructor.

With this feature, constant expressions can include calls to template and non-template `constexpr` functions, `constexpr` objects of class literal types, and references bound to `const` objects that are initialized with constant expressions.

Evaluations of floating-point operations at compile time use the default semantics of the `-qfloat` option.

Related reference:

“The `constexpr` specifier (C++11)” on page 96

“`constexpr` functions (C++11)” on page 289

“`constexpr` constructors (C++11)” on page 389

“C++11 compatibility” on page 519

Function call expressions

A *function call* is an expression containing the function name followed by the function call operator, `()`. If the function has been defined to receive parameters, the values that are to be sent into the function are listed inside the parentheses of the function call operator. The argument list can contain any number of expressions separated by commas. The argument list can also be empty.

The type of a function call expression is the return type of the function. This type can either be a complete type, a reference type, or the type `void`.

C A function call is always an rvalue. **C**

C++ A function call belongs to one of the following value categories depending on the result type of the function:

- An lvalue if the result type is an lvalue reference type **C++11** or an rvalue reference to a function type **C++11**
- **C++11** An xvalue if the result type is an rvalue reference to an object type **C++11**
- A **C++11** (prvalue) **C++11** rvalue in other cases

C++

Here are some examples of the function call operator:

```
stub()
overdue(account, date, amount)
notify(name, date + 5)
report(error, time, date, ++num)
```

The order of evaluation for function call arguments is not specified. In the following example:

```
method(sample1, batch.process--, batch.process);
```

the argument `batch.process--` might be evaluated last, causing the last two arguments to be passed with the same value.

Related reference:

“Function argument conversions” on page 158

“Function calls” on page 280

“Lvalues and rvalues” on page 159

“References (C++ only)” on page 123

Member expressions

Member expressions indicate members of classes, structures, or unions. The member operators are:

- Dot operator `.`
- Arrow operator `->`

Dot operator `.`

The `.` (dot) operator is used to access class, structure, or union members. The member is specified by a postfix expression, followed by a `.` (dot) operator, followed by a possibly qualified identifier or a pseudo-destructor name. (A *pseudo-destructor* is a destructor of a nonclass type.) The postfix expression must be an object of type class, struct or union. The name must be a member of that object.

The value of the expression is the value of the selected member. If the postfix expression and the name are lvalues, the expression value is also an lvalue. If the postfix expression is type-qualified, the same type qualifiers will apply to the designated member in the resulting expression.

Related reference:

Access to structure and union members
“Pseudo-destructors” on page 400

Arrow operator ->

The -> (arrow) operator is used to access class, structure or union members using a pointer. A postfix expression, followed by an -> (arrow) operator, followed by a possibly qualified identifier or a pseudo-destructor name, designates a member of the object to which the pointer points. (A *pseudo-destructor* is a destructor of a nonclass type.) The postfix expression must be a pointer to an object of type `class`, `struct` or `union`. The name must be a member of that object.

The value of the expression is the value of the selected member. If the name is an lvalue, the expression value is also an lvalue. If the expression is a pointer to a qualified type, the same type-qualifiers will apply to the designated member in the resulting expression.

Related reference:

“Pointers” on page 114

Access to structure and union members

“Structures and unions” on page 70

Chapter 13, “Class members and friends (C++ only),” on page 335

“Pseudo-destructors” on page 400







Unary expressions

A *unary expression* contains one operand and a unary operator.

All unary operators have the same precedence and have right-to-left associativity, as shown in Table 36 on page 213.

As indicated in the descriptions of the operators, the usual arithmetic conversions are performed on the operands of most unary expressions.

The supported unary operators are:

- “Increment operator ++” on page 170
- “Decrement operator --” on page 170
- “Unary plus operator +” on page 171
- “Unary minus operator -” on page 171
- “Logical negation operator !” on page 171
- “Bitwise negation operator ~” on page 171
- “Address operator &” on page 172
- “Indirection operator *” on page 173
-  typeid 
-  alignof 
- sizeof
-  typeof
-  __real__ and __imag__ 

Related reference:

“Pointer arithmetic” on page 115

“Lvalues and rvalues” on page 159

Increment operator ++

The ++ (increment) operator adds 1 to the value of a scalar operand, or if the operand is a pointer, increments the operand by the size of the object to which it points. The operand receives the result of the increment operation. The operand must be a modifiable lvalue of arithmetic or pointer type.

You can put the ++ before or after the operand. If it appears before the operand, the operand is incremented. The incremented value is then used in the expression. If you put the ++ after the operand, the value of the operand is used in the expression *before* the operand is incremented. A pre-increment expression is an lvalue. A post-increment expression is an rvalue. For example:

```
play = ++play1 + play2++;
```

is similar to the following expressions; play1 is altered before play:

```
int temp, temp1, temp2;

temp1 = play1 + 1;
temp2 = play2;
play1 = temp1;
temp = temp1 + temp2;
play2 = play2 + 1;
play = temp;
```

The result has the same type as the operand after integral promotion.

The usual arithmetic conversions on the operand are performed.

 The increment operator has been extended to handle complex types. The operator works in the same manner as it does on a real type, except that only the real part of the operand is incremented, and the imaginary part is unchanged.



Decrement operator --

The -- (decrement) operator subtracts 1 from the value of a scalar operand, or if the operand is a pointer, decreases the operand by the size of the object to which it points. The operand receives the result of the decrement operation. The operand must be a modifiable lvalue.

You can put the -- before or after the operand. If it appears before the operand, the operand is decremented, and the decremented value is used in the expression. If the -- appears after the operand, the current value of the operand is used in the expression and the operand is decremented. A pre-decrement expression is an lvalue. A post-decrement expression is an rvalue.

For example:

```
play = --play1 + play2--;
```

is similar to the following expressions; play1 is altered before play:

```
int temp, temp1, temp2;

temp1 = play1 - 1;
temp2 = play2;
```

```
play1 = temp1;
temp = temp1 + temp2;
play2 = play2 - 1;
play = temp;
```

The result has the same type as the operand after integral promotion, but is not an lvalue.

The usual arithmetic conversions are performed on the operand.

IBM The decrement operator has been extended to handle complex types, for compatibility with GNU C. The operator works in the same manner as it does on a real type, except that only the real part of the operand is decremented, and the imaginary part is unchanged. **IBM**

Unary plus operator +

The + (unary plus) operator maintains the value of the operand. The operand can have any arithmetic type or pointer type. The result is not an lvalue.

The result has the same type as the operand after integral promotion.

Note: Any plus sign in front of a constant is not part of the constant.

Unary minus operator -

The - (unary minus) operator negates the value of the operand. The operand can have any arithmetic type. The result is not an lvalue.

For example, if `quality` has the value 100, `-quality` has the value -100.

The result has the same type as the operand after integral promotion.

Note: Any minus sign in front of a constant is not part of the constant.

Logical negation operator !

The ! (logical negation) operator determines whether the operand evaluates to 0 (false) or nonzero (true).

C The expression yields the value 1 (true) if the operand evaluates to 0, and yields the value 0 (false) if the operand evaluates to a nonzero value. **C**

C++ The expression yields the value true if the operand evaluates to false (0), and yields the value false if the operand evaluates to true (nonzero). The operand is implicitly converted to bool, and the type of the result is bool. **C++**

The following two expressions are equivalent:

```
!right;
right == 0;
```

Related reference:

“Boolean types” on page 63

Bitwise negation operator ~

The ~ (bitwise negation) operator yields the bitwise complement of the operand. In the binary representation of the result, every bit has the opposite value of the

same bit in the binary representation of the operand. The operand must have an integral type. The result has the same type as the operand but is not an lvalue.

Suppose `x` represents the decimal value 5. The 16-bit binary representation of `x` is:
0000000000000101

The expression `~x` yields the following result (represented here as a 16-bit binary number):

111111111111010

Note that the `~` character can be represented by the trigraph `??~`.

The 16-bit binary representation of `~0` is:

111111111111111

IBM The bitwise negation operator has been extended to handle complex types. With a complex type, the operator computes the complex conjugate of the operand by reversing the sign of the imaginary part. **IBM**

Related reference:

“Trigraph sequences” on page 43

Address operator &

The `&` (address) operator yields a pointer to its operand. The operand must be an lvalue, a function designator, or a qualified name. It cannot be a bit field.

C It cannot have the storage class register. **C**

If the operand is an lvalue or function, the resulting type is a pointer to the expression type. For example, if the expression has type `int`, the result is a pointer to an object having type `int`.

If the operand is a qualified name and the member is not static, the result is a pointer to a member of class and has the same type as the member. The result is not an lvalue.

If `p_to_y` is defined as a pointer to an `int` and `y` as an `int`, the following expression assigns the address of the variable `y` to the pointer `p_to_y`:

```
p_to_y = &y;
```

IBM The address operator has been extended to handle vector types, provided that vector support is enabled. The result of the address operator applied to a vector type can be stored in a pointer to a compatible vector type. The address of a vector type can be used to initialize a pointer to vector type if both sides of the initialization have compatible types. A pointer to `void` can also be initialized with the address of a vector type.

C++ The ampersand symbol `&` is used in C++ to form declarators for lvalue references in addition to being the address operator. The meanings are related but not identical.

```
int target;
int &rTarg = target; // rTarg is an lvalue reference to an integer.
                    // The reference is initialized to refer to target.
void f(int& p);     // p is an lvalue reference to a pointer
```

If you take the address of a reference, it returns the address of its target. Using the previous declarations, `&rTarg` is the same memory address as `&target`.

You may take the address of a register variable.

You can use the `&` operator with overloaded functions only in an initialization or assignment where the left side uniquely determines which version of the overloaded function is used. 

 The address of a label can be taken using the GNU C address operator `&&`. For details, see “Labels as values (IBM extension)” on page 220.

Related reference:







“Indirection operator `*`”

“Pointers” on page 114

“References (C++ only)” on page 123

“Labels as values (IBM extension)” on page 220

Indirection operator `*`

The `*` (indirection) operator determines the value referred to by the pointer-type operand. The operand can be a pointer to an incomplete type that is not `cv void`. The lvalue thus obtained cannot be converted to a  prvalue  rvalue. If the operand points to an object, the operation yields an lvalue referring to that object. If the operand points to a function, the result is  a function designator   an lvalue referring to the object to which the operand points . Arrays and functions are converted to pointers.

The type of the operand determines the type of the result. For example, if the operand is a pointer to an `int`, the result has type `int`.

Do not apply the indirection operator to any pointer that contains an address that is not valid, such as `NULL`. The result is not defined.

If `p_to_y` is defined as a pointer to an `int` and `y` as an `int`, the expressions:

```
p_to_y = &y;  
*p_to_y = 3;
```

cause the variable `y` to receive the value 3.



The indirection operator `*` has been extended to handle pointer to vector types, provided that vector support is enabled. A vector pointer can point to a memory location that has 16-byte alignment. However, the compiler does not enforce this constraint. Dereferencing a vector pointer maintains the vector type and its 16-byte alignment. If a program dereferences a vector pointer that does not contain a 16-byte aligned address, the behavior is undefined.



Related reference:

“Arrays” on page 120

“Pointers” on page 114

The typeid operator (C++ only)

The typeid operator provides a program with the ability to retrieve the actual derived type of the object referred to by a pointer or a reference. This operator, along with the `dynamic_cast` operator, are provided for runtime type identification (RTTI) support in C++.

typeid operator syntax

►► typeid (*expr*)
 └─ *type-name* ─┘

The typeid operator requires runtime type information (RTTI) to be generated, which must be explicitly specified at compile time through a compiler option.

The typeid operator returns an lvalue of type `const std::type_info` that represents the type of expression *expr*. You must include the standard template library header `<typeinfo>` to use the typeid operator.

If *expr* is a reference or a dereferenced pointer to a polymorphic class, typeid will return a `type_info` object that represents the object that the reference or pointer denotes at run time. If it is not a polymorphic class, typeid will return a `type_info` object that represents the type of the reference or dereferenced pointer. The following example demonstrates this:

```
#include <iostream>
#include <typeinfo>
using namespace std;

struct A { virtual ~A() { } };
struct B : A { };

struct C { };
struct D : C { };

int main() {
    B bobj;
    A* ap = &bobj;
    A& ar = bobj;
    cout << "ap: " << typeid(*ap).name() << endl;
    cout << "ar: " << typeid(ar).name() << endl;

    D dobj;
    C* cp = &dobj;
    C& cr = dobj;
    cout << "cp: " << typeid(*cp).name() << endl;
    cout << "cr: " << typeid(cr).name() << endl;
}
```

The following is the output of the above example:

```
ap: B
ar: B
cp: C
cr: C
```

Classes A and B are polymorphic; classes C and D are not. Although `cp` and `cr` refer to an object of type D, `typeid(*cp)` and `typeid(cr)` return objects that represent class C.

Lvalue-to-rvalue, array-to-pointer, and function-to-pointer conversions will not be applied to *expr*. For example, the output of the following example will be `int [10]`, not `int *`:

```
#include <iostream>
#include <typeinfo>
using namespace std;

int main() {
    int myArray[10];
    cout << typeid(myArray).name() << endl;
}
```

If *expr* is a class type, that class must be completely defined.

The `typeid` operator ignores top-level `const` or `volatile` qualifiers.

Related reference:

“Type names” on page 113

“The `typeof` operator (IBM extension)” on page 178

The `__alignof__` operator (IBM extension)

The `__alignof__` operator is a language extension to C99 and Standard C++ that returns the position to which its operand is aligned. The operand can be an expression or a parenthesized type identifier. If the operand is an expression that represents an lvalue, the number that is returned by `__alignof__` represents the alignment that the lvalue is known to have. The type of the expression is determined at compile time, but the expression itself is not evaluated. If the operand is a type, the number represents the alignment that is usually required for the type on the target platform.

The `__alignof__` operator cannot be applied to the following situations:

- An lvalue that represents a bit field
- A function type
- An undefined structure or class
- An incomplete type (such as `void`)

`__alignof__` operator syntax

```
►► __alignof__ [ unary_expression ]
                [ (—type-id—) ]
```

If *type-id* is a reference or a referenced type, the result is the alignment of the referenced type. If *type-id* is an array, the result is the alignment of the array element type. If *type-id* is a fundamental type, the result is implementation-defined.

For example, on AIX, `__alignof__(wchar_t)` returns 2 for a 32-bit target, and 4 for a 64-bit target.

The operand of `__alignof__` can be a vector type, provided that vector support is enabled. For example,

```
vector unsigned int v1 = (vector unsigned int)(10);
vector unsigned int *pv1 = &v1;
__alignof__(v1); // vector type alignment: 16.
__alignof__(&v1); // address of vector alignment: 4.
```

```

__alignof__(*pv1); // dereferenced pointer to vector alignment: 16.
__alignof__(pv1); // pointer to vector alignment: 4.
__alignof__(vector signed char); // vector type alignment: 16.

```

When `__attribute__((aligned))` is used to increase the alignment of a variable of vector type, the value that is returned by the `__alignof__` operator is the alignment factor that is specified by `__attribute__((aligned))`.

Related reference:

“The aligned variable attribute” on page 141

“Extensions for vector processing support” on page 516

The sizeof operator

The `sizeof` operator yields the size in bytes of the operand, which can be an expression or the parenthesized name of a type.

sizeof operator syntax

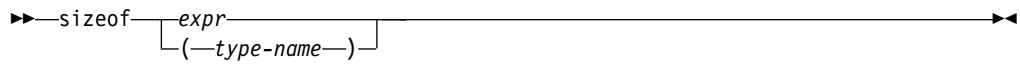

The result for either kind of operand is not an lvalue, but a constant integer value. The type of the result is the unsigned integral type `size_t` defined in the header file `stddef.h`.

Except in preprocessor directives, you can use a `sizeof` expression wherever an integral constant is required. One of the most common uses for the `sizeof` operator is to determine the size of objects that are referred to during storage allocation, input, and output functions.

Another use of `sizeof` is in porting code across platforms. You can use the `sizeof` operator to determine the size that a data type represents. For example:

```
sizeof(int);
```

The `sizeof` operator applied to a type name yields the amount of memory that can be used by an object of that type, including any internal or trailing padding.

IBM The operand of the `sizeof` operator can be a vector variable, a vector type, or the result of dereferencing a pointer to vector type, provided that vector support is enabled. In these cases, the return value of `sizeof` is always 16.





```

vector<bool> v1;
vector<bool> *pv1 = &v1;
sizeof(v1); // vector type: 16.
sizeof(&v1); // address of vector: 4.
sizeof(*pv1); // dereferenced pointer to vector: 16.
sizeof(pv1); // pointer to vector: 4.
sizeof(vector<bool>); // vector type: 16.

```

IBM

For compound types, results are as follows:

Operand	Result
An array	The result is the total number of bytes in the array. For example, in an array with 10 elements, the size is equal to 10 times the size of a single element. The compiler does not convert the array to a pointer before evaluating the expression.
 A class	The result is always nonzero. It is equal to the number of bytes in an object of that class, also including any padding required for placing class objects in an array. 
 A reference	The result is the size of the referenced object. 

The sizeof operator cannot be applied to:

- A bit field
- A function type
- An undefined structure or class
- An incomplete type (such as void)

The sizeof operator applied to an expression yields the same result as if it had been applied to only the name of the type of the expression. At compile time, the compiler analyzes the expression to determine its type. None of the usual type conversions that occur in the type analysis of the expression are directly attributable to the sizeof operator. However, if the operand contains operators that perform conversions, the compiler does take these conversions into consideration in determining the type. For example, the second line of the following sample causes the usual arithmetic conversions to be performed. Assuming that a short uses 2 bytes of storage and an int uses 4 bytes,

```
short x; ... sizeof (x)          /* the value of sizeof operator is 2 */
short x; ... sizeof (x + 1)     /* value is 4, result of addition is type int */
```

The result of the expression `x + 1` has type `int` and is equivalent to `sizeof(int)`. The value is also 4 if `x` has type `char`, `short`, `int`, or any enumeration type of the default enum size.

A variable length array can be the operand of a sizeof expression. In this case, the operand is evaluated at run time, and the size is neither an integer constant nor a constant expression, even though the size of each instance of a variable array does not change during its lifetime.

 `sizeof...` is a unary expression operator introduced by the variadic template feature. This operator accepts an expression that names a parameter pack as its operand. It then expands the parameter pack and returns the number of arguments provided for the parameter pack. Consider the following example:

```
template<typename...T> void foo(T...args){
    int v = sizeof...(args);
}
```

In this example, the variable `v` is assigned to the number of the arguments provided for the parameter pack `args`.

Notes:

- The operand of the `sizeof...` operator must be an expression that names a parameter pack.

- The operand of the sizeof operator cannot be an expression that names a parameter pack or a pack expansion.

For more information, see “Variadic templates (C++11)” on page 446

C++11 <

Related reference:

“Type names” on page 113

“Integer constant expressions” on page 162

“Arrays” on page 120

“References (C++ only)” on page 123

The typeof operator (IBM extension)

The typeof operator returns the type of its argument, which can be an expression or a type. The language feature provides a way to derive the type from an expression. Given an expression *e*, `__typeof__(e)` can be used anywhere a type name is needed, for example in a declaration or in a cast. The alternate spelling of the keyword, `__typeof__`, is recommended.

The typeof operator is extended to accept a vector type as its operand, when vector support is enabled.

typeof operator syntax

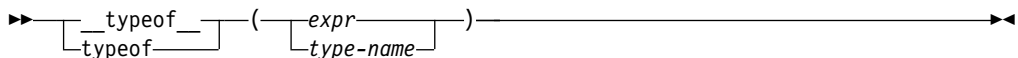

A `typeof` construct itself is not an expression, but the name of a type. A `typeof` construct behaves like a type name defined using `typedef`, although the syntax resembles that of `sizeof`.

The following examples illustrate its basic syntax. For an expression *e*:

```
int e;
__typeof__(e + 1) j; /* the same as declaring int j; */
e = (__typeof__(e)) f; /* the same as casting e = (int) f; */
```

Using a `typeof` construct is equivalent to declaring a `typedef` name. Given

```
typedef int T[2];
int i[2];
```

you can write

```
__typeof__(i) a; /* all three constructs have the same meaning */
__typeof__(int[2]) a;
__typeof__(T) a;
```

The behavior of the code is as if you had declared `int a[2];`.

For a bit field, `typeof` represents the underlying type of the bit field. For example, `int m:2;`, the `typeof(m)` is `int`. Since the bit field property is not reserved, `n` in `typeof(m) n;` is the same as `int n`, but not `int n:2`.

The `typeof` operator can be nested inside `sizeof` and itself. The following declarations of `arr` as an array of pointers to `int` are equivalent:

```
int *arr[10]; /* traditional C declaration */
__typeof__(__typeof__(int *)[10]) a; /* equivalent declaration */
```

The `typeof` operator can be useful in macro definitions where expression `e` is a parameter. For example,

```
#define SWAP(a,b) { __typeof__(a) temp; temp = a; a = b; b = temp; }
```

Notes:

1. The `typeof` and `__typeof__` keywords are supported as follows:
 - **C** The `__typeof__` keyword is recognized under compilation with the `xlC` invocation command or the `-qlanglvl=extc89`, `-qlanglvl=extc99`, or `-qlanglvl=extended` options. The `typeof` keyword is only recognized under compilation with `-qkeyword=typeof`.
 - **C++** The `typeof` and `__typeof__` keywords are recognized under compilation with `-qlanglvl=extended` option.
2. **C++11** `decltype` serves a similar purpose as `__typeof__`.

Related reference:

"The `decltype(expression)` type specifier (C++11)" on page 90

"Type names" on page 113

"typedef definitions" on page 86

"Vector types (IBM extension)" on page 66

The `__real__` and `__imag__` operators (IBM extension)

XL C/C++ extends the C99 and C++ standards to support the unary operators `__real__` and `__imag__`. These operators provide the ability to extract the real and imaginary parts of a complex type. These extensions have been implemented to ease the porting applications developed with GNU C.

`__real__` and `__imag__` operator syntax

```
→ [ __real__ | __imag__ ] ( var_identifier ) →
```

The *var_identifier* is the name of a previously declared complex variable. The `__real__` operator returns the real part of the complex variable, while the `__imag__` operator returns the imaginary part of the variable. If the operand of these operators is an lvalue, the resulting expression can be used in any context where lvalues are allowed. They are especially useful in initializations of complex variables, and as arguments to calls to library functions such as `printf` and `scanf` that have no format specifiers for complex types. For example:

```
float _Complex myvar;  
__imag__(myvar) = 2.0f;  
__real__(myvar) = 3.0f;
```

initializes the imaginary part of the complex variable `myvar` to $2.0i$ and the real part to 3.0, and

```
printf("myvar = %f + %f * i\n", __real__(myvar), __imag__(myvar));
```

prints:

```
myvar = 3.000000 + 2.000000 * i
```

Related reference:

Complex literals (C only)

Complex floating-point types (C only)

The `vec_step` operator (IBM extension)

The `vec_step` operator takes a vector type operand and returns an integer value representing the amount by which a pointer to a vector element should be incremented in order to move by 16 bytes (the size of a vector). The following table provides a summary of values by data type.

Table 32. Increment value for `vec_step` by data type

vec_step expression	Value
<code>vec_step(vector unsigned char)</code>	16
<code>vec_step(vector signed char)</code>	
<code>vec_step(vector bool char)</code>	
<code>vec_step(vector unsigned short)</code>	8
<code>vec_step(vector signed short)</code>	
<code>vec_step(vector bool short)</code>	
<code>vec_step(vector unsigned int)</code>	4
<code>vec_step(vector signed int)</code>	
<code>vec_step(vector bool int)</code>	
<code>vec_step(vector unsigned long long)</code>	2
<code>vec_step(vector signed long long)</code>	
<code>vec_step(vector bool long long)</code>	
<code>vec_step(vector pixel)</code>	8
<code>vec_step(vector float)</code>	4
<code>vec_step(vector double)</code>	2

For complete information about the `vec_step` operator, see the *AltiVec Technology Programming Interface Manual*, available at http://www.freescale.com/files/32bit/doc/ref_manual/ALTIVECPIM.pdf

Binary expressions

A *binary expression* contains two operands separated by one operator.

- “Assignment operators” on page 181

All binary operators have left-to-right associativity, but not all binary operators have the same precedence. The ranking and precedence rules for binary operators is summarized in Table 37 on page 214.

The order in which the operands of most binary operators are evaluated is not specified. To ensure correct results, avoid creating binary expressions that depend on the order in which the compiler evaluates the operands.

As indicated in the descriptions of the operators, the usual arithmetic conversions are performed on the operands of most binary expressions.

The supported binary operators are as follows:

- “Assignment operators” on page 181

- “Multiplication operator `*`” on page 183
- “Division operator `/`” on page 183
- “Remainder operator `%`” on page 183
- “Addition operator `+`” on page 184
- “Subtraction operator `-`” on page 184
- “Bitwise left and right shift operators `<< >>`” on page 185
- “Relational operators `< > <= >=`” on page 185
- “Equality and inequality operators `== !=`” on page 186
- “Bitwise AND operator `&`” on page 187
- “Bitwise exclusive OR operator `^`” on page 188
- “Bitwise inclusive OR operator `|`” on page 188
- “Logical AND operator `&&`” on page 189
- “Logical OR operator `||`” on page 189
- “Array subscripting operator `[]`” on page 190
- “Vector subscripting operator `[]` (IBM extension)” on page 191
- “Comma operator `,`” on page 192
- “Pointer to member operators `.* ->*` (C++ only)” on page 193

Related reference:

“Lvalues and rvalues” on page 159

“Arithmetic conversions and promotions” on page 148

Assignment operators

An *assignment expression* stores a value in the object designated by the left operand. There are two types of assignment operators:

- “Simple assignment operator `=`”
- “Compound assignment operators” on page 182

The left operand in all assignment expressions must be a modifiable lvalue. The type of the expression is the type of the left operand. The value of the expression is the value of the left operand after the assignment has completed.

C The result of an assignment expression is not an lvalue. **C**

C++ The result of an assignment expression is an lvalue. **C++**

All assignment operators have the same precedence and have right-to-left associativity.

Simple assignment operator `=`

The simple assignment operator has the following form:

lvalue = *expr*

The operator stores the value of the right operand *expr* in the object designated by the left operand *lvalue*.

If the left operand is not a class typenor **IBM** a vector type **IBM**, the right operand is implicitly converted to the type of the left operand. This converted type is not be qualified by `const` or `volatile`.

If the left operand is a class type, that type must be complete. The copy assignment operator of the left operand is called.

If the left operand is an object of reference type, the compiler assigns the value of the right operand to the object denoted by the reference.

Compound assignment operators

The compound assignment operators consist of a binary operator and the simple assignment operator. They perform the operation of the binary operator on both operands and store the result of that operation into the left operand, which must be a modifiable lvalue.

The following table shows the operand types of compound assignment expressions:

Operator	Left operand	Right operand
<code>+=</code> or <code>-=</code>	Arithmetic	Arithmetic
<code>+=</code> or <code>-=</code>	Pointer	Integral type
<code>*=</code> , <code>/=</code> , and <code>%=</code>	Arithmetic	Arithmetic
<code><<=</code> , <code>>>=</code> , <code>&=</code> , <code>^=</code> , and <code> =</code>	Integral type	Integral type

Note that the expression

```
a *= b + c
```

is equivalent to

```
a = a * (b + c)
```

and *not*

```
a = a * b + c
```

The following table lists the compound assignment operators and shows an expression using each operator:

Operator	Example	Equivalent expression
<code>+=</code>	<code>index += 2</code>	<code>index = index + 2</code>
<code>-=</code>	<code>*pointer -= 1</code>	<code>*pointer = *pointer - 1</code>
<code>*=</code>	<code>bonus *= increase</code>	<code>bonus = bonus * increase</code>
<code>/=</code>	<code>time /= hours</code>	<code>time = time / hours</code>
<code>%=</code>	<code>allowance %= 1000</code>	<code>allowance = allowance % 1000</code>
<code><<=</code>	<code>result <<= num</code>	<code>result = result << num</code>
<code>>>=</code>	<code>form >>= 1</code>	<code>form = form >> 1</code>
<code>&=</code>	<code>mask &= 2</code>	<code>mask = mask & 2</code>
<code>^=</code>	<code>test ^= pre_test</code>	<code>test = test ^ pre_test</code>
<code> =</code>	<code>flag = 0N</code>	<code>flag = flag 0N</code>

Although the equivalent expression column shows the left operands (from the example column) twice, it is in effect evaluated only once.

C++ In addition to the table of operand types, an expression is implicitly converted to the cv-unqualified type of the left operand if it is not of class type. However, if the left operand is of class type, the class becomes complete, and assignment to objects of the class behaves as a copy assignment operation. Compound expressions and conditional expressions are lvalues in C++, which allows them to be a left operand in a compound assignment expression.

C **IBM** When GNU C language features have been enabled, compound expressions and conditional expressions are allowed as lvalues, provided that their operands are lvalues. For details, see “Lvalues and rvalues” on page 159 **C**

IBM

Related reference:

“Lvalues and rvalues” on page 159

“Pointers” on page 114

“Type qualifiers” on page 98

Multiplication operator *

The * (multiplication) operator yields the product of its operands. The operands must have an arithmetic or enumeration type. The result is not an lvalue. The usual arithmetic conversions on the operands are performed.

Because the multiplication operator has both associative and commutative properties, the compiler can rearrange the operands in an expression that contains more than one multiplication operator. For example, the expression:

```
sites * number * cost
```

can be interpreted in any of the following ways:

```
(sites * number) * cost  
sites * (number * cost)  
(cost * sites) * number
```

Division operator /

The / (division) operator yields the algebraic quotient of its operands. If both operands are integers, any fractional part (remainder) is discarded. Throwing away the fractional part is often called *truncation toward zero*. The operands must have an arithmetic or enumeration type. The right operand may not be zero: the result is undefined if the right operand evaluates to 0. For example, expression `7 / 4` yields the value 1 (rather than 1.75 or 2). The result is not an lvalue.

The usual arithmetic conversions on the operands are performed.

C++ If both operands are negative, the sign of the remainder is also negative. Otherwise, the sign of the remainder is the same as the sign of the quotient.

Remainder operator %

The % (remainder) operator yields the remainder from the division of the left operand by the right operand. For example, the expression `5 % 3` yields 2. The result is not an lvalue.

Both operands must have an integral or enumeration type. If the right operand evaluates to 0, the result is undefined. If either operand has a negative value, the result is such that the following expression always yields the value of a if b is not 0 and a/b is representable:

```
( a / b ) * b + a %b;
```

The usual arithmetic conversions on the operands are performed.

If both operands are negative, the sign of the remainder is also negative. Otherwise, the sign of the remainder is the same as the sign of the quotient.

Addition operator +

The + (addition) operator yields the sum of its operands. Both operands must have an arithmetic type, or one operand must be a pointer to an object type and the other operand must have an integral or enumeration type.

When both operands have an arithmetic type, the usual arithmetic conversions on the operands are performed. The result has the type produced by the conversions on the operands and is not an lvalue.

A pointer to an object in an array can be added to a value having integral type. The result is a pointer of the same type as the pointer operand. The result refers to another element in the array, offset from the original element by the amount of the integral value treated as a subscript. If the resulting pointer points to storage outside the array, other than the first location outside the array, the result is undefined. A pointer to one element past the end of an array cannot be used to access the memory content at that address. The compiler does not provide boundary checking on the pointers. For example, after the addition, `ptr` points to the third element of the array:

```
int array[5];
int *ptr;
ptr = array + 2;
```

Related reference:

“Pointer arithmetic” on page 115

“Pointer conversions” on page 156

Subtraction operator -

The - (subtraction) operator yields the difference of its operands. Both operands must have an arithmetic or enumeration type, or the left operand must have a pointer type and the right operand must have the same pointer type or an integral or enumeration type. You cannot subtract a pointer from an integral value.

When both operands have an arithmetic type, the usual arithmetic conversions on the operands are performed. The result has the type produced by the conversions on the operands and is not an lvalue.

When the left operand is a pointer and the right operand has an integral type, the compiler converts the value of the right to an address offset. The result is a pointer of the same type as the pointer operand.

If both operands are pointers to elements in the same array, the result is the number of objects separating the two addresses. The number is of type `ptrdiff_t`, which is defined in the header file `stddef.h`. Behavior is undefined if the pointers do not refer to objects in the same array.

Related reference:

“Pointer arithmetic” on page 115

“Pointer conversions” on page 156

Bitwise left and right shift operators << >>

The bitwise shift operators move the bit values of a binary object. The left operand specifies the value to be shifted. The right operand specifies the number of positions that the bits in the value are to be shifted. The result is not an lvalue. Both operands have the same precedence and are left-to-right associative.

Operator	Usage
<<	Indicates the bits are to be shifted to the left.
>>	Indicates the bits are to be shifted to the right.

Each operand must have an integral or enumeration type. The compiler performs integral promotions on the operands, and then the right operand is converted to type `int`. The result has the same type as the left operand (after the arithmetic conversions).

The right operand should not have a negative value or a value that is greater than or equal to the width in bits of the expression being shifted. The result of bitwise shifts on such values is unpredictable.

If the right operand has the value 0, the result is the value of the left operand (after the usual arithmetic conversions).

The << operator fills vacated bits with zeros. For example, if `left_op` has the value 4019, the bit pattern (in 16-bit format) of `left_op` is:

```
0000111110110011
```

The expression `left_op << 3` yields:

```
0111110110011000
```

The expression `left_op >> 3` yields:

```
0000000111110110
```

Relational operators < > <= >=

The relational operators compare two operands and determine the validity of a relationship. The following table describes the four relational operators:

Operator	Usage
<	Indicates whether the value of the left operand is less than the value of the right operand.
>	Indicates whether the value of the left operand is greater than the value of the right operand.
<=	Indicates whether the value of the left operand is less than or equal to the value of the right operand.
>=	Indicates whether the value of the left operand is greater than or equal to the value of the right operand.

Both operands must have arithmetic or enumeration types or be pointers to the same type.

 The type of the result is `int` and has the values 1 if the specified relationship is true, and 0 if false. 

► C++ The type of the result is `bool` and has the values `true` or `false`. C++ ◀

The result is not an lvalue.

If the operands have arithmetic types, the usual arithmetic conversions on the operands are performed.

When the operands are pointers, the result is determined by the locations of the objects to which the pointers refer. If the pointers do not refer to objects in the same array, the result is not defined.

A pointer can be compared to a constant expression that evaluates to 0. You can also compare a pointer to a pointer of type `void*`. The pointer is converted to a pointer of type `void*`.

If two pointers refer to the same object, they are considered equal. If two pointers refer to nonstatic members of the same object, the pointer to the object declared later is greater, provided that they are not separated by an access specifier; otherwise the comparison is undefined. If two pointers refer to data members of the same union, they have the same address value.

If two pointers refer to elements of the same array, or to the first element beyond the last element of an array, the pointer to the element with the higher subscript value is greater.

You can only compare members of the same object with relational operators.

Relational operators have left-to-right associativity. For example, the expression:

```
a < b <= c
```

is interpreted as:

```
(a < b) <= c
```

If the value of `a` is less than the value of `b`, the first relationship yields 1 in C, or `true` in C++. The compiler then compares the value `true` (or 1) with the value of `c` (integral promotions are carried out if needed).

Equality and inequality operators `==` `!=`

The equality operators, like the relational operators, compare two operands for the validity of a relationship. The equality operators, however, have a lower precedence than the relational operators. The following table describes the two equality operators:

Operator	Usage
<code>==</code>	Indicates whether the value of the left operand is equal to the value of the right operand.
<code>!=</code>	Indicates whether the value of the left operand is not equal to the value of the right operand.

Both operands must have arithmetic or enumeration types or be pointers to the same type, or one operand must have a pointer type and the other operand must be a pointer to `void` or a null pointer.

► **C** The type of the result is `int` and has the values 1 if the specified relationship is true, and 0 if false. **C++** ◀ The type of the result is `bool` and has the values `true` or `false`.

► **C++** The type of the result is `bool` and has the values `true` or `false`. **C++** ◀

If the operands have arithmetic types, the usual arithmetic conversions on the operands are performed.

If the operands are pointers, the result is determined by the locations of the objects to which the pointers refer.

If one operand is a pointer and the other operand is an integer having the value 0, the `==` expression is true only if the pointer operand evaluates to `NULL`. The `!=` operator evaluates to true if the pointer operand does not evaluate to `NULL`.

You can also use the equality operators to compare pointers to members that are of the same type but do not belong to the same object. The following expressions contain examples of equality and relational operators:

```
time < max_time == status < complete
letter != EOF
```

Note: The equality operator (`==`) should not be confused with the assignment (`=`) operator.

For example,

```
if (x == 3)
```

evaluates to true (or 1) if `x` is equal to three. Equality tests like this should be coded with spaces between the operator and the operands to prevent unintentional assignments.

```
while
```

```
if (x = 3)
```

is taken to be true because `(x = 3)` evaluates to a nonzero value (3). The expression also assigns the value 3 to `x`.

Related reference:

Simple assignment operator =

Bitwise AND operator &

The `&` (bitwise AND) operator compares each bit of its first operand to the corresponding bit of the second operand. If both bits are 1's, the corresponding bit of the result is set to 1. Otherwise, it sets the corresponding result bit to 0.

Both operands must have an integral or enumeration type. The usual arithmetic conversions on each operand are performed. The result has the same type as the converted operands.

Because the bitwise AND operator has both associative and commutative properties, the compiler can rearrange the operands in an expression that contains more than one bitwise AND operator.

The following example shows the values of `a`, `b`, and the result of `a & b` represented as 16-bit binary numbers:

bit pattern of a	000000001011100
bit pattern of b	000000000101110
bit pattern of a & b	000000000001100

Note: The bitwise AND (&) should not be confused with the logical AND. (&&) operator. For example,

```
1 & 4 evaluates to 0
while
1 && 4 evaluates to true
```

Bitwise exclusive OR operator ^

The bitwise exclusive OR operator (in EBCDIC, the ^ symbol is represented by the \neg symbol) compares each bit of its first operand to the corresponding bit of the second operand. If both bits are 1's or both bits are 0's, the corresponding bit of the result is set to 0. Otherwise, it sets the corresponding result bit to 1.

Both operands must have an integral or enumeration type. The usual arithmetic conversions on each operand are performed. The result has the same type as the converted operands and is not an lvalue.

Because the bitwise exclusive OR operator has both associative and commutative properties, the compiler can rearrange the operands in an expression that contains more than one bitwise exclusive OR operator. Note that the ^ character can be represented by the trigraph `??^`.

The following example shows the values of a, b, and the result of a ^ b represented as 16-bit binary numbers:

bit pattern of a	000000001011100
bit pattern of b	000000000101110
bit pattern of a ^ b	000000001110010

Related reference:

“Trigraph sequences” on page 43

Bitwise inclusive OR operator |

The | (bitwise inclusive OR) operator compares the values (in binary format) of each operand and yields a value whose bit pattern shows which bits in either of the operands has the value 1. If both of the bits are 0, the result of that bit is 0; otherwise, the result is 1.

Both operands must have an integral or enumeration type. The usual arithmetic conversions on each operand are performed. The result has the same type as the converted operands and is not an lvalue.

Because the bitwise inclusive OR operator has both associative and commutative properties, the compiler can rearrange the operands in an expression that contains more than one bitwise inclusive OR operator. Note that the | character can be represented by the trigraph `??|`.

The following example shows the values of a, b, and the result of a | b represented as 16-bit binary numbers:

bit pattern of a	0000000001011100
bit pattern of b	0000000000101110
bit pattern of a b	0000000001111110

Note: The bitwise OR (|) should not be confused with the logical OR (||) operator. For example,

```
1 | 4 evaluates to 5
while
1 || 4 evaluates to true
```

Related reference:

“Trigraph sequences” on page 43

Logical AND operator &&

The && (logical AND) operator indicates whether both operands are true.

C If both operands have nonzero values, the result has the value 1. Otherwise, the result has the value 0. The type of the result is `int`. Both operands must have an arithmetic or pointer type. The usual arithmetic conversions on each operand are performed.

C++ If both operands have values of `true`, the result has the value `true`. Otherwise, the result has the value `false`. Both operands are implicitly converted to `bool` and the result type is `bool`.

Unlike the & (bitwise AND) operator, the && operator guarantees left-to-right evaluation of the operands. If the left operand evaluates to 0 (or `false`), the right operand is not evaluated.

The following examples show how the expressions that contain the logical AND operator are evaluated:

Expression	Result
<code>1 && 0</code>	false or 0
<code>1 && 4</code>	true or 1
<code>0 && 0</code>	false or 0

The following example uses the logical AND operator to avoid division by zero:
`(y != 0) && (x / y)`

The expression `x / y` is not evaluated when `y != 0` evaluates to 0 (or `false`).

Note: The logical AND (&&) should not be confused with the bitwise AND (&) operator. For example:

```
1 && 4 evaluates to 1 (or true)
while
1 & 4 evaluates to 0
```

Logical OR operator ||

The || (logical OR) operator indicates whether either operand is true.

C If either of the operands has a nonzero value, the result has the value 1. Otherwise, the result has the value 0. The type of the result is `int`. Both operands must have an arithmetic or pointer type. The usual arithmetic conversions on each operand are performed. **C**

C++ If either operand has a value of `true`, the result has the value `true`. Otherwise, the result has the value `false`. Both operands are implicitly converted to `bool` and the result type is `bool`. **C++**

Unlike the `|` (bitwise inclusive OR) operator, the `||` operator guarantees left-to-right evaluation of the operands. If the left operand has a nonzero (or `true`) value, the right operand is not evaluated.

The following examples show how expressions that contain the logical OR operator are evaluated:

Expression	Result
<code>1 0</code>	true or 1
<code>1 4</code>	true or 1
<code>0 0</code>	false or 0

The following example uses the logical OR operator to conditionally increment `y`:

```
++x || ++y;
```

The expression `++y` is not evaluated when the expression `++x` evaluates to a nonzero (or `true`) quantity.

Note: The logical OR (`||`) should not be confused with the bitwise OR (`|`) operator. For example:

```
1 || 4 evaluates to 1 (or true)
while
1 | 4 evaluates to 5
```

Array subscripting operator []

A postfix expression followed by an expression in `[]` (brackets) specifies an element of an array. The expression within the brackets is referred to as a *subscript*. The first element of an array has the subscript zero.

By definition, the expression `a[b]` is equivalent to the expression `*((a) + (b))`, and, because addition is associative, it is also equivalent to `b[a]`. Between expressions `a` and `b`, one must be a pointer to a type `T`, and the other must have integral or enumeration type. The result of an array subscript is an lvalue. The following example demonstrates this:

```
#include <stdio.h>

int main(void) {
    int a[3] = { 10, 20, 30 };
    printf("a[0] = %d\n", a[0]);
    printf("a[1] = %d\n", 1[a]);
    printf("a[2] = %d\n", *(2 + a));
    return 0;
}
```

See the output of the above example:

```
a[0] = 10
a[1] = 20
a[2] = 30
```

C++ The above restrictions on the types of expressions required by the subscript operator, as well as the relationship between the subscript operator and pointer arithmetic, do not apply if you overload operator[] of a class. **C++**

The first element of each array has the subscript 0. The expression `contract[35]` refers to the 36th element in the array `contract`.

In a multidimensional array, you can reference each element (in the order of increasing storage locations) by incrementing the right-most subscript most frequently.

For example, the following statement gives the value 100 to each element in the array `code[4][3][6]`:

```
for (first = 0; first < 4; ++first)
{
    for (second = 0; second < 3; ++second)
    {
        for (third = 0; third < 6; ++third)
        {
            code[first][second][third] =
                100;
        }
    }
}
```

C C99 allows array subscripting on arrays that are not lvalues. The following example is valid in C99:

```
struct trio{int a[3];};
struct trio f();
foo (int index)
{
    return f().a[index];
}
```

C

Related reference:

“Pointers” on page 114

“Integral types” on page 62

“Lvalues and rvalues” on page 159

“Arrays” on page 120

“Overloading subscripting” on page 314

“Pointer arithmetic” on page 115

Vector subscripting operator [] (IBM extension)

Access to individual elements of a vector data type is provided through the use of square brackets, similar to how array elements are accessed. The vector data type is followed by a set of square brackets containing the position of the element. The position of the first element is 0. The type of the result is the type of the elements contained in the vector type.

Example:

```
vector unsigned int v1 = {1,2,3,4};
unsigned int u1, u2, u3, u4;
u1 = v1[0];      // u1=1
u2 = v1[1];      // u2=2
u3 = v1[2];      // u3=3
u4 = v1[3];      // u4=4
```

Note: You can also access and manipulate individual elements of vectors with the following intrinsic functions:

- **vec_extract**
- **vec_insert**
- **vec_promote**
- **vec_splats**

Comma operator ,

A *comma expression* contains two operands of any type separated by a comma and has left-to-right associativity. The left operand is fully evaluated, possibly producing side effects, and its value, if there is one, is discarded. The right operand is then evaluated. The type and value of the result of a comma expression are those of its right operand, after the usual unary conversions.

C The result of a comma expression is not an lvalue. **C**

C++ In C++, the result is an lvalue if the right operand is an lvalue. The following statements are equivalent:

```
r = (a,b,...,c);
a; b; r = c;
```

The difference is that the comma operator may be suitable for expression contexts, such as loop control expressions.

Similarly, the address of a compound expression can be taken if the right operand is an lvalue.

```
&(a, b)
a, &b
```

C++

Any number of expressions separated by commas can form a single expression because the comma operator is associative. The use of the comma operator guarantees that the subexpressions will be evaluated in left-to-right order, and the value of the last becomes the value of the entire expression. In the following example, if `omega` has the value 11, the expression increments `delta` and assigns the value 3 to `alpha`:

```
alpha = (delta++, omega % 4);
```

A sequence point occurs after the evaluation of the first operand. The value of `delta` is discarded. Similarly, in the following example, the value of the expression: `intensity++, shade * increment, rotate(direction);`

is the value of the expression:

```
rotate(direction)
```

In some contexts where the comma character is used, parentheses are required to avoid ambiguity. For example, the function

```
f(a, (t = 3, t + 2), c);
```

has only three arguments: the value of `a`, the value 5, and the value of `c`. Other contexts in which parentheses are required are in field-length expressions in structure and union declarator lists, enumeration value expressions in enumeration declarator lists, and initialization expressions in declarations and initializers.

In the previous example, the comma is used to separate the argument expressions in a function invocation. In this context, its use does not guarantee the order of evaluation (left to right) of the function arguments.

The primary use of the comma operator is to produce side effects in the following situations:

- Calling a function
- Entering or repeating an iteration loop
- Testing a condition
- Other situations where a side effect is required but the result of the expression is not immediately needed

The following table gives some examples of the uses of the comma operator.

Statement	Effects
<pre>for (i=0; i<2; ++i, f());</pre>	A for statement in which <code>i</code> is incremented and <code>f()</code> is called at each iteration.
<pre>if (f(), ++i, i>1) { /* ... */ }</pre>	An if statement in which function <code>f()</code> is called, variable <code>i</code> is incremented, and variable <code>i</code> is tested against a value. The first two expressions within this comma expression are evaluated before the expression <code>i>1</code> . Regardless of the results of the first two expressions, the third is evaluated and its result determines whether the if statement is processed.
<pre>func((++a, f(a)));</pre>	A function call to <code>func()</code> in which <code>a</code> is incremented, the resulting value is passed to a function <code>f()</code> , and the return value of <code>f()</code> is passed to <code>func()</code> . The function <code>func()</code> is passed only a single argument, because the comma expression is enclosed in parentheses within the function argument list.

Pointer to member operators `.*` `->*` (C++ only)

There are two pointer to member operators: `.*` and `->*`.

The `.*` operator is used to dereference pointers to class members. The first operand must be of class type. If the type of the first operand is class type `T`, or is a class that has been derived from class type `T`, the second operand must be a pointer to a member of a class type `T`.

The `->*` operator is also used to dereference pointers to class members. The first operand must be a pointer to a class type. If the type of the first operand is a pointer to class type `T`, or is a pointer to a class derived from class type `T`, the second operand must be a pointer to a member of class type `T`.

The `.*` and `->*` operators bind the second operand to the first, resulting in an object or function of the type specified by the second operand.

If the result of `.*` or `->*` is a function, you can only use the result as the operand for the `()` (function call) operator. If the second operand is an lvalue, the result of `.*` or `->*` is an lvalue.

Related reference:

“Class member lists” on page 335

“Pointers to members” on page 340

Conditional expressions

A *conditional expression* is a compound expression that contains a condition that is implicitly converted to type `bool` in C++(*operand₁*), an expression to be evaluated if the condition evaluates to true (*operand₂*), and an expression to be evaluated if the condition has the value false (*operand₃*).

The conditional expression contains one two-part operator. The `?` symbol follows the condition, and the `:` symbol appears between the two action expressions. All expressions that occur between the `?` and `:` are treated as one expression.

The first operand must have a scalar type. The type of the second and third operands must be one of the following:

- An arithmetic type
- A compatible pointer, structure, or union type
- void

The second and third operands can also be a pointer or a null pointer constant.

Two objects are compatible when they have the same type but not necessarily the same type qualifiers (`volatile` or `const`). Pointer objects are compatible if they have the same type or are pointers to void.

The first operand is evaluated, and its value determines whether the second or third operand is evaluated:

- If the value is true, the second operand is evaluated.
- If the value is false, the third operand is evaluated.

The result is the value of the second or third operand.

If the second and third expressions evaluate to arithmetic types, the usual arithmetic conversions are performed on the values. The types of the second and third operands determine the type of the result.

Conditional expressions have right-to-left associativity with respect to their first and third operands. The leftmost operand is evaluated first, and then only one of the remaining two operands is evaluated. The following expressions are equivalent:

```
a ? b : c ? d : e ? f : g
a ? b : (c ? d : (e ? f : g))
```

Types in conditional C expressions (C only)

In C, a conditional expression is not an lvalue, nor is its result.

Table 33. Types of operands and results in conditional C expressions

Type of one operand	Type of other operand	Type of result
Arithmetic	Arithmetic	Arithmetic type after usual arithmetic conversions

Table 33. Types of operands and results in conditional C expressions (continued)

Type of one operand	Type of other operand	Type of result
Structure or union type	Compatible structure or union type	Structure or union type with all the qualifiers on both operands
void	void	void
Pointer to compatible type	Pointer to compatible type	Pointer to type with all the qualifiers specified for the type
Pointer to type	NULL pointer (the constant 0)	Pointer to type
Pointer to object or incomplete type	Pointer to void	Pointer to void with all the qualifiers specified for the type

IBM In GNU C, a conditional expression is a valid lvalue, provided that its type is not void and both of its branches are valid lvalues. The following conditional expression (a ? b : c) is legal under GNU C:

```
(a ? b : c) = 5
/* Under GNU C, equivalent to (a ? b = 5 : (c = 5)) */
```

This extension is available when compiling in one of the extended language levels.

IBM

Types in conditional C++ expressions (C++ only)

Table 34. Types of operands and results in C++ conditional expressions

Type of one operand	Type of other operand	Type of result
Reference to type	Reference to type	Reference after usual reference conversions
Class T	Class T	Class T
Class T	Class X	Class type for which a conversion exists. If more than one possible conversion exist, the result is ambiguous.
throw expression	Other (type, pointer, reference)	Type of the expression that is not a throw expression

Examples of conditional expressions

The following expression determines which variable has the greater value, y or z, and assigns the greater value to the variable x:

```
x = (y > z) ? y : z;
```

The following statement is equivalent to the previous expression.

```
if (y > z)
    x = y;
else
    x = z;
```

The following expression calls the function printf, which receives the value of the variable c, if c evaluates to a digit. Otherwise, printf receives the character constant 'x'.

```
printf(" c = %c\n", isdigit(c) ? c : 'x');
```

If the last operand of a conditional expression contains an assignment operator, use parentheses to ensure the expression evaluates properly. For example, the = operator has lower precedence than the ?: operator in the following expression:

```
int i,j,k;
(i == 7) ? j ++ : k = j;
```

The compiler will interpret this expression as if it were parenthesized this way:

```
int i,j,k;
((i == 7) ? j ++ : k) = j;
```

That is, k is treated as the third operand, not the entire assignment expression k = j.

To assign the value of j to k when i == 7 is false, enclose the last operand in parentheses:

```
int i,j,k;
(i == 7) ? j ++ : (k = j);
```

Cast expressions

A cast operator is used for *explicit type conversions*. It converts the value of an expression to a specified type.

The following cast operators are supported:

Cast operator ()

Cast expression syntax

►—(—*type*—)—*expression*—◄

► **C** In C, the result of the cast operation is not an lvalue. **C** ◄

► **C++** In C++, the cast result belongs to one of the following value categories:

- If *type* is an lvalue reference type ► **C++11** ◄ or an rvalue reference to a function type **C++11** ◄, the cast result is an lvalue.
- ► **C++11** ◄ If *type* is an rvalue reference to an object type, the cast result is an xvalue. **C++11** ◄
- In all other cases, the cast result is a ► **C++11** ◄ (prvalue) **C++11** ◄ rvalue.

C++ ◄

The following example demonstrates the use of the cast operator to dynamically create an integer array of size 10:

```
#include <stdlib.h>

int main(void) {
    int* myArray = (int*) malloc(10 * sizeof(int));
    free(myArray);
    return 0;
}
```

The malloc library function returns a void pointer that points to memory that holds an object of the size of its argument. The statement `int* myArray = (int*) malloc(10 * sizeof(int))` has the following steps:

- Creates a void pointer that points to memory that can hold ten integers.
- Converts that void pointer into an integer pointer with the use of the cast operator.
- Assigns that integer pointer to `myArray`.

C++ In C++ you can also use the following objects in cast expressions:

- Function-style casts
- C++ conversion operators, such as `static_cast`.

Function-style notation converts the value of *expression* to the type *type*:
`type(expression)`

The following example shows the same value cast with a C-style cast, the C++ function-style cast, and a C++ cast operator:

```
#include <iostream>
using namespace std;

int main() {
    float num = 98.76;
    int x1 = (int) num;
    int x2 = int(num);
    int x3 = static_cast<int>(num);

    cout << "x1 = " << x1 << endl;
    cout << "x2 = " << x2 << endl;
    cout << "x3 = " << x3 << endl;
}
```

See the output of the above example:

```
x1 = 98
x2 = 98
x3 = 98
```

The integer `x1` is assigned a value in which `num` has been explicitly converted to an `int` with the C-style cast. The integer `x2` is assigned a value that has been converted with the function-style cast. The integer `x3` is assigned a value that has been converted with the `static_cast` operator.

For C++, the operand of a cast expression can have class type. If the operand has class type, it can be cast to any type for which the class has a user-defined conversion function. Casts can invoke a constructor, if the target type is a class, or they can invoke a conversion function, if the source type is a class. They can be ambiguous if both conditions hold. **C++**

Cast to union type (C only) (IBM extension)

Casting to a union type is the ability to cast a union member to the same type as the union to which it belongs. Such a cast does not produce an lvalue. The feature is supported as an extension to C99, implemented to facilitate porting programs developed with GNU C.

Only a type that explicitly exists as a member of a union type can be cast to that union type. The cast can use either the tag of the union type or a union type name declared in a typedef expression. The type specified must be a complete union

type. An anonymous union type can be used in a cast to a union type, provided that it has a tag or type name. A bit field can be cast to a union type, provided that the union contains a bit field member of the same type, but not necessarily of the same length. The following code shows an example of a simple cast to union:

```
#include <stdio.h>

union f {
    char t;
    short u;
    int v;
    long w;
    long long x;
    float y;
    double z;
};

int main() {
    union f u;
    char a = 1;
    u = (union f)a;
    printf("u = %i\n", u.t);
}
```

The output of this example is:

```
u = 1
```

Casting to a nested union is also allowed. In the following example, the double type `dd` can be cast to the nested union `u2_t`.

```
int main() {
    union u_t {
        char a;
        short b;
        int c;
        union u2_t {
            double d;
        }u2;
    };
    union u_t U;
    double dd = 1.234;
    U.u2 = (union u2_t) dd;    // Valid.
    printf("U.u2 is %f\n", U.u2);
}
```

The output of this example is:

```
U.u2 is 1.234
```

A union cast is also valid as a function argument, part of a constant expression for initialization of a static or non-static data object, and in a compound literal statement. The following example shows a cast to union used as part of an expression for initializing a static object:

```
struct S{
    int a;
}s;

union U{
    struct S *s;
};

struct T{
```



```

    union U u;
};

static struct T t[] = { {(union U)&s} };

```

Related reference:

- “Structures and unions” on page 70
- “The transparent_union type attribute (C only)” on page 107
- “Type names” on page 113
- “Conversion functions” on page 404
- “Conversion constructors” on page 402
- “Lvalues and rvalues” on page 159
- “References (C++ only)” on page 123

The static_cast operator (C++ only)

The *static_cast* operator converts a given expression to a specified type.

static_cast operator syntax

►►—static_cast—<—Type—>—(—expression—)—————►►

► C++11 ◀ With the right angle bracket feature, you may specify a `template_id` as `Type` in the `static_cast` operator with the `>>` token in place of two consecutive `>` tokens. For details, see “Class templates” on page 419. ◀ C++11 ◀

The result of `static_cast<Type>(expression)` belongs to one of the following value categories:

- If `Type` is an lvalue reference type ► C++11 ◀ or an rvalue reference to a function type ◀ C++11 ◀, `static_cast<Type>(expression)` is an lvalue.
- ► C++11 ◀ If `Type` is an rvalue reference to an object type, `static_cast<Type>(expression)` is an xvalue. ◀ C++11 ◀
- In all other cases, `static_cast<Type>(expression)` is a ► C++11 ◀ (prvalue) ◀ C++11 ◀ rvalue.

An example of the `static_cast` operator:

```

#include <iostream>
using namespace std;

int main() {
    int j = 41;
    int v = 4;
    float m = j/v;
    float d = static_cast<float>(j)/v;
    cout << "m = " << m << endl;
    cout << "d = " << d << endl;
}

```

The output of this example is:

```

m = 10
d = 10.25

```

In this example, `m = j/v;` produces an answer of type `int` because both `j` and `v` are integers. Conversely, `d = static_cast<float>(j)/v;` produces an answer of type `float`. The `static_cast` operator converts variable `j` to type `float`. This allows the

compiler to generate a division with an answer of type `float`. All `static_cast` operators resolve at compile time and do not remove any `const` or `volatile` modifiers.

Applying the `static_cast` operator to a null pointer converts it to a null pointer value of the target type.

The compiler supports the following types of cast operations:

- An lvalue of type `A` to type `B&`, and the cast result is an lvalue of type `B`
- `> C++11` An lvalue or xvalue of type `A` to type `B&&`, and the cast result is an xvalue of type `B` `< C++11`
- `A > C++11` (prvalue) `< C++11` rvalue of pointer to `A` to pointer to `B`
- `> C++11` An lvalue of type `A` to type `B&&` if an xvalue of type `A` can be bound directly to a reference of type `B&&` `< C++11`
- An expression `e` to type `T` if the direct initialization `T t(e)` is valid.

To support the first three cast operations, the following conditions must be satisfied:

- `A` is a base class of `B`.
- There exists a standard conversion from a pointer to type `B` to a pointer to type `A`.
- Type `B` is the same as or more cv-qualified than type `A`.
- `A` is not a virtual base class or a base class of a virtual base class of `B`.

You can cast a `> C++11` (prvalue) `< C++11` rvalue of a pointer to member of `A` whose type is `cv1 T` to a `> C++11` (prvalue) `< C++11` rvalue of a pointer to member of `B` whose type is `cv2 T` if the following conditions are satisfied:

- `B` is a base class of `A`.
- There exists a standard conversion from a pointer to member of `B` whose type is `T` to a pointer to member of `A` whose type is `T`.
- `cv2` is the same or more cv-qualification than `cv1`.

You can explicitly convert a pointer to `cv1 void` to a pointer to `cv2 void` if `cv2` is the same or more cv-qualification than `cv1`.

Related reference:

“User-defined conversions” on page 401

“Type-based aliasing” on page 116

“Lvalues and rvalues” on page 159

“References (C++ only)” on page 123

The `reinterpret_cast` operator (C++ only)

A `reinterpret_cast` operator handles conversions between unrelated types.

`reinterpret_cast` operator syntax

`>> reinterpret_cast<<Type>>(<<expression>>)`

`> C++11` With the right angle bracket feature, you may specify a `template_id` as `Type` in the `reinterpret_cast` operator with the `>>` token in place of two consecutive `>` tokens. For details, see “Class templates” on page 419. `< C++11`

The result of `reinterpret_cast<Type>(expression)` belongs to one of the following value categories:

- If `Type` is an lvalue reference type `> C++11` or an rvalue reference to a function type `C++11 <`, `reinterpret_cast<Type>(expression)` is an lvalue.
- `> C++11` If `Type` is an rvalue reference to an object type, `reinterpret_cast<Type>(expression)` is an xvalue. `C++11 <`
- In all other cases, `reinterpret_cast<Type>(expression)` is a `> C++11` (prvalue) `C++11 <` rvalue.

The `reinterpret_cast` operator produces a value of a new type that has the same bit pattern as its argument. You cannot cast away a `const` or `volatile` qualification. You can explicitly perform the following conversions:

- A pointer to any integral type large enough to hold it
- A value of integral or enumeration type to a pointer
- A pointer to a function to a pointer to a function of a different type
- A pointer to an object to a pointer to an object of a different type
- A pointer to a member to a pointer to a member of a different class or type, if the types of the members are both function types or object types

A null pointer value is converted to the null pointer value of the destination type.

Given a type `T` and an lvalue expression `x`, the following two expressions for lvalue references have different syntax but the same semantics:

- `reinterpret_cast<T&>(x)`
- `*reinterpret_cast<T*>(&(x))`

`> C++11` Given a type `T` and an lvalue expression `x`, the following two expressions for rvalue references have different syntax but the same semantics:

- `reinterpret_cast<T&&>(x)`
- `static_cast<T&&>(*reinterpret_cast<T*>(&(x)))`

`C++11 <`

Reinterpreting one type of pointer as an incompatible type of pointer is usually invalid. The `reinterpret_cast` operator, as well as the other named cast operators, is more easily spotted than C-style casts, and highlights the paradox of a strongly typed language that allows explicit casts.

The C++ compiler detects and quietly fixes most but not all violations. It is important to remember that even though a program compiles, its source code may not be completely correct. On some platforms, performance optimizations are predicated on strict adherence to standard aliasing rules. Although the C++ compiler tries to help with type-based aliasing violations, it cannot detect all possible cases.

The following example violates the aliasing rule, but executes as expected when compiled unoptimized in C++ or in K&R C. It also successfully compiles optimized in C++, but does not necessarily execute as expected. The offending line 7 causes an old or uninitialized value for `x` to be printed.

```
1 extern int y = 7.;
2
3 int main() {
4     float x;
5     int i;
6     x = y;
7     cout << x << endl;
8 }
```

```

6     x = y;
7     i = *(int *) &x;
8     printf("i=%d. x=%f.\n", i, x);
9 }

```

The next code example contains an incorrect cast that the compiler cannot even detect because the cast is across two different files.

```

1 /* separately compiled file 1 */
2     extern float f;
3     extern int * int_pointer_to_f = (int *) &f; /* suspicious cast */
4
5 /* separately compiled file 2 */
6     extern float f;
7     extern int * int_pointer_to_f;
8     f = 1.0;
9     int i = *int_pointer_to_f;           /* no suspicious cast but wrong */

```

In line 8, there is no way for the compiler to know that `f = 1.0` is storing into the same object that `int i = *int_pointer_to_f` is loading from.

Related reference:

“User-defined conversions” on page 401

“Lvalues and rvalues” on page 159

“References (C++ only)” on page 123

The `const_cast` operator (C++ only)

A *const_cast operator* adds or removes a `const` or `volatile` modifier to or from a type.

`const_cast` operator syntax

►► `const_cast` ◀◀ *Type* ◀◀ (◀◀ *expression* ◀◀) ◀◀◀◀

► **C++11** With the right angle bracket feature, you may specify a `template_id` as *Type* in the `const_cast` operator with the `>>` token in place of two consecutive `>` tokens. For details, see “Class templates” on page 419. **C++11** ◀

The result of `const_cast<Type>(expression)` belongs to one of the following value categories:

- If *Type* is an lvalue reference to an object type, `const_cast<Type>(expression)` is an lvalue.
- ► **C++11** If *Type* is an rvalue reference to an object type, `const_cast<Type>(expression)` is an xvalue. **C++11** ◀
- In all other cases, `const_cast<Type>(expression)` is a ► **C++11** (prvalue) **C++11** ◀ rvalue.

Type and the type of *expression* may only differ with respect to their `const` and `volatile` qualifiers. Their cast is resolved at compile time. A single `const_cast` expression may add or remove any number of `const` or `volatile` modifiers.

If a pointer to *T1* can be converted to a pointer to *T2* using `const_cast<T2>`, where *T1* and *T2* are object types, you can also make the following types of conversions:

- An lvalue of type *T1* to an lvalue of type *T2* using `const_cast<T2&&>`
- ► **C++11** An lvalue or xvalue of type *T1* to an xvalue of type *T2* using `const_cast<T2&&>` **C++11** ◀

- **> C++11** A prvalue of class type T1 to an xvalue of type T2 using `const_cast<T2&&>` **C++11 <**

If a conversion from a **> C++11** (prvalue) **C++11 <** rvalue of type pointer to T1 to type pointer to T2 casts away constness, the following types of conversions also cast away constness:

- An lvalue of type T1 to an lvalue of type T2
- **> C++11** An expression of type T1 to an xvalue of type T2 **C++11 <**
- A **> C++11** (prvalue) **C++11 <** rvalue of type pointer to data member of X of type T1 to type pointer to data member of Y of type T2

Types cannot be defined within `const_cast`.

The following demonstrates the use of the `const_cast` operator:

```
#include <iostream>
using namespace std;

void f(int* p) {
    cout << *p << endl;
}

int main(void) {
    const int a = 10;
    const int* b = &a;

    // Function f() expects int*, not const int*
    // f(b);
    int* c = const_cast<int*>(b);
    f(c);

    // Lvalue is const
    // *b = 20;

    // Undefined behavior
    // *c = 30;

    int a1 = 40;
    const int* b1 = &a1;
    int* c1 = const_cast<int*>(b1);

    // Integer a1, the object referred to by c1, has
    // not been declared const
    *c1 = 50;

    return 0;
}
```

The compiler does not allow the function call `f(b)`. Function `f()` expects a pointer to an `int`, not a `const int`. The statement `int* c = const_cast<int*>(b)` returns a pointer `c` that refers to `a` without the `const` qualification of `a`. This process of using `const_cast` to remove the `const` qualification of an object is called *casting away constness*. Consequently the compiler does allow the function call `f(c)`.

The compiler would not allow the assignment `*b = 20` because `b` points to an object of type `const int`. The compiler does allow the `*c = 30`, but the behavior of this statement is undefined. If you cast away the constness of an object that has been explicitly declared as `const`, and attempt to modify it, the results are undefined.

However, if you cast away the constness of an object that has not been explicitly declared as `const`, you can modify it safely. In the above example, the object referred to by `b1` has not been declared `const`, but you cannot modify this object through `b1`. You may cast away the constness of `b1` and modify the value to which it refers.

Related reference:

“Type qualifiers” on page 98

“Type-based aliasing” on page 116

“Lvalues and rvalues” on page 159

“References (C++ only)” on page 123

The `dynamic_cast` operator (C++ only)

The `dynamic_cast` operator checks the following types of conversions at run time:

- A pointer to a base class to a pointer to a derived class
- An lvalue referring to a base class to an lvalue reference to a derived class
- C++11 An xvalue referring to a base class to an rvalue reference to a derived class C++11

A program can thereby use a class hierarchy safely. This operator and the `typeid` operator provide runtime type identification (RTTI) support in C++.

`dynamic_cast` operator syntax

►► `dynamic_cast` ◀◀ `T` ◀◀ ◀ `v` ◀◀ ◀◀

C++11 With the right angle bracket feature, you may specify a `template_id` as `T` in the `dynamic_cast` operator with the `>>` token in place of two consecutive `>` tokens. For details, see “Class templates” on page 419. C++11

The expression `dynamic_cast<T>(v)` converts the expression `v` to type `T`. Type `T` must be a pointer or reference to a complete class type or a pointer to `void`.

The following rules apply to the `dynamic_cast<T>(v)` expression:

- If `T` is a pointer type, `v` must be a C++11 (prvalue) C++11 rvalue, and `dynamic_cast<T>(v)` is a C++11 (prvalue) C++11 rvalue of type `T`.
- If `T` is an lvalue reference type, `v` must be an lvalue, and `dynamic_cast<T>(v)` is an lvalue of the type that is referred by `T`.
- C++11 If `T` is an rvalue reference type, `dynamic_cast<T>(v)` is an xvalue of the type that is referred by `T`. C++11

If `T` is a pointer and the `dynamic_cast` operator fails, the operator returns a null pointer of type `T`. If `T` is a reference and the `dynamic_cast` operator fails, the operator throws the exception `std::bad_cast`. You can find this class in the standard library header `<typeinfo>`.

The `dynamic_cast` operator requires runtime type identification (RTTI) to be generated, which must be explicitly specified at compile time through a compiler option.

If `T` is a void pointer, then `dynamic_cast` returns the starting address of the object pointed to by `v`. The following example demonstrates this:

```

#include <iostream>
using namespace std;

struct A {
    virtual ~A() { };
};

struct B : A { };

int main() {
    B bobj;
    A* ap = &bobj;
    void * vp = dynamic_cast<void *>(ap);
    cout << "Address of vp : " << vp << endl;
    cout << "Address of bobj: " << &bobj << endl;
}

```

The output of this example is similar to the following result. Both `vp` and `&bobj` refer to the same address:

```

Address of vp : 12FF6C
Address of bobj: 12FF6C

```

The primary purpose for the `dynamic_cast` operator is to perform type-safe *downcasts*. A downcast is the conversion of a pointer or reference to a class `A` to a pointer or reference to a class `B`, where class `A` is a base class of `B`. The problem with downcasts is that a pointer of type `A*` might point to an object that is not a base class subobject of type `A` that belongs to an object of type `B` or a class derived from `B`. The `dynamic_cast` operator ensures that if you convert a pointer to class `A` to a pointer to class `B`, the object of type `A` pointed to by the former belongs to an object of type `B` or a class derived from `B` as a base class subobject.

The following example demonstrates the use of the `dynamic_cast` operator:

```

#include <iostream>
using namespace std;

struct A {
    virtual void f() { cout << "Class A" << endl; }
};

struct B : A {
    virtual void f() { cout << "Class B" << endl; }
};

struct C : A {
    virtual void f() { cout << "Class C" << endl; }
};

void f(A* arg) {
    B* bp = dynamic_cast<B*>(arg);
    C* cp = dynamic_cast<C*>(arg);

    if (bp)
        bp->f();
    else if (cp)
        cp->f();
    else
        arg->f();
};

int main() {
    A aobj;
    C cobj;
    A* ap = &cobj;
}

```

```

    A* ap2 = &aobj;
    f(ap);
    f(ap2);
}

```

See the output of the above example:

```

Class C
Class A

```



The function `f()` determines whether the pointer `arg` points to an object of type `A`, `B`, or `C`. The function does this by trying to convert `arg` to a pointer of type `B`, then to a pointer of type `C`, with the `dynamic_cast` operator. If the `dynamic_cast` operator succeeds, it returns a pointer that points to the object denoted by `arg`. If `dynamic_cast` fails, it returns `0`.

You may perform downcasts with the `dynamic_cast` operator only on polymorphic classes. In the above example, all the classes are polymorphic because class `A` has a virtual function. The `dynamic_cast` operator uses the runtime type information generated from polymorphic classes.

Related reference:

- “Derivation” on page 361
- “User-defined conversions” on page 401
- “Type-based aliasing” on page 116
- “Lvalues and rvalues” on page 159
- “References (C++ only)” on page 123



Compound literal expressions

A *compound literal* is a postfix expression that provides an unnamed object whose value is given by an initializer list. The C99 language feature allows you to pass parameters to functions without the need for temporary variables. It is useful for specifying constants of an aggregate type (arrays, structures, and unions) when only one instance of such types is needed.  To be compatible with C99, the XL C/C++ compiler supports this feature as an IBM extension. 

The syntax for a compound literal resembles that of a cast expression. However, a compound literal is an lvalue, while the result of a cast expression is not. Furthermore, a cast can only convert to scalar types or `void`, whereas a compound literal results in an object of the specified type.

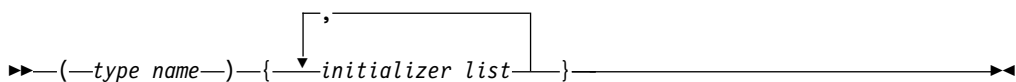
Compound literal syntax



The `type_name` can be any data type, including  `vector`  and user-defined types. It can be an array of unknown size, but not a variable length array. If the type is an array of unknown size, the size is determined by the initializer list.

The following example passes a constant structure variable of type `point` containing two integer members to the function `drawline`:

```
drawline((struct point){6,7});
```

If the compound literal occurs outside the body of a function, the initializer list must consist of constant expressions, and the unnamed object has static storage duration. If the compound literal occurs within the body of a function, the initializer list need not consist of constant expressions, and the unnamed object has automatic storage duration.

IBM For compatibility with GNU C, a static variable can be initialized with a compound literal of the same type, provided that all the initializers in the initializer list are constant expressions. **IBM**

Related reference:

String literals

new expressions (C++ only)

The new operator provides dynamic storage allocation.

new operator syntax

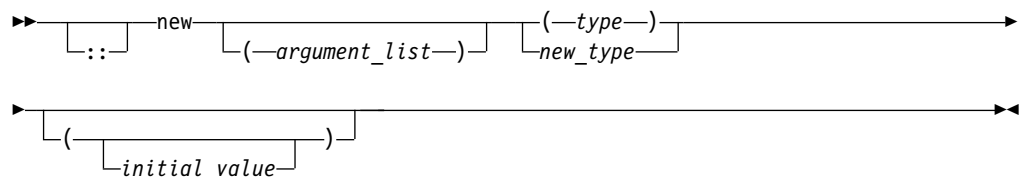

If you prefix new with the scope resolution operator (::), the global operator new() is used. If you specify an *argument_list*, the overloaded new operator that corresponds to that *argument_list* is used. The *type* is an existing built-in or user-defined type. A *new_type* is a type that has not already been defined and can include type specifiers and declarators.

An allocation expression containing the new operator is used to find storage in free store for the object being created. The *new expression* returns a pointer to the object created and can be used to initialize the object. If the object is an array, a pointer to the initial element is returned.

You cannot use the new operator to allocate function types, void, or incomplete class types because these are not object types. However, you can allocate pointers to functions with the new operator. You cannot create a reference with the new operator.

When the object being created is an array, only the first dimension can be a general expression. All subsequent dimensions must be integral constant expressions that evaluate to positive values. The first dimension can be a general expression even when an existing *type* is used. You can create an array with zero bounds with the new operator. For example:

```
char * c = new char[0];
```

In this case, a pointer to a unique object is returned.

An object created with operator new() or operator new[] () exists until the operator delete() or operator delete[] () is called to deallocate the object's memory. A delete operator or a destructor will not be implicitly called for an object created with a new that has not been explicitly deallocated before the end of the program.

If parentheses are used within a new type, parentheses should also surround the new type to prevent syntax errors.

In the following example, storage is allocated for an array of pointers to functions:

```
void f();
void g();

int main(void)
{
    void (**p)(), (**q)();
    // declare p and q as pointers to pointers to void functions
    p = new (void (*[3])());
    // p now points to an array of pointers to functions
    q = new void(*[3])(); // error
    // error - bound as 'q = (new void) (*[3])();'
    p[0] = f; // p[0] to point to function f
    q[2] = g; // q[2] to point to function g
    p[0](); // call f()
    q[2](); // call g()
    return (0);
}
```

However, the second use of new causes an erroneous binding of `q = (new void) (*[3])()`.

The type of the object being created cannot contain class declarations, enumeration declarations, or const or volatile types. It can contain pointers to const or volatile objects.

For example, `const char*` is allowed, but `char* const` is not.

Related reference:

Generalized constant expressions (C++11)

Placement syntax

Additional arguments can be supplied to new by using the *argument_list*, also called the *placement syntax*. If placement arguments are used, a declaration of operator `new()` or operator `new[]()` with these arguments must exist. For example:

```
#include <new>
using namespace std;

class X
{
public:
    void* operator new(size_t,int, int){ /* ... */ }
};

// ...

int main ()
{
    X* ptr = new(1,2) X;
}
```

The placement syntax is commonly used to invoke the global placement new function. The global placement new function initializes an object or objects at the location specified by the placement argument in the placement new expression. This location must address storage that has previously been allocated by some other means, because the global placement new function does not itself allocate memory. In the following example, no new memory is allocated by the calls

`new(whole) X(8);`, `new(seg2) X(9);`, or `new(seg3) X(10);`; Instead, the constructors `X(8)`, `X(9)`, and `X(10)` are called to reinitialize the memory allocated to the buffer `whole`.

Because placement `new` does not allocate memory, you should not use `delete` to deallocate objects created with the placement syntax. You can only delete the entire memory pool (`delete whole`). In the example, you can keep the memory buffer but destroy the object stored in it by explicitly calling a destructor.

```
#include <new>
class X
{
    public:
        X(int n): id(n){ }
        ~X(){ }
    private:
        int id;
        // ...
};

int main()
{
    char* whole = new char[ 3 * sizeof(X) ]; // a 3-part buffer
    X * p1 = new(whole) X(8);                // fill the front
    char* seg2 = &whole[ sizeof(X) ];        // mark second segment
    X * p2 = new(seg2) X(9);                // fill second segment
    char* seg3 = &whole[ 2 * sizeof(X) ];    // mark third segment
    X * p3 = new(seg3) X(10);               // fill third segment

    p2->~X(); // clear only middle segment, but keep the buffer
    // ...
    return 0;
}
```

The placement `new` syntax can also be used for passing parameters to an allocation routine rather than to a constructor.

Related reference:

“delete expressions (C++ only)” on page 211

“Scope resolution operator `::` (C++ only)” on page 166

“Overview of constructors and destructors” on page 385

Initialization of objects created with the `new` operator

You can initialize objects created with the `new` operator in several ways. For nonclass objects, or for class objects without constructors, a *new initializer* expression can be provided in a `new` expression by specifying `(expression)` or `()`. For example:

```
double* pi = new double(3.1415926);
int* score = new int(89);
float* unknown = new float();
```

If a class does not have a default constructor, the `new` initializer must be provided when any object of that class is allocated. The arguments of the `new` initializer must match the arguments of a constructor.

You cannot specify an initializer for arrays. You can initialize an array of class objects only if the class has a default constructor. The constructor is called to initialize each array element (class object).

Initialization using the new initializer is performed only if new successfully allocates storage.

Related reference:

“Overview of constructors and destructors” on page 385

Handling new allocation failure

When the new operator creates a new object, it calls the operator new() or operator new[]() function to obtain the needed storage.

When new cannot allocate storage to create a new object, it calls a *new handler* function if one has been installed by a call to set_new_handler(). The std::set_new_handler() function is declared in the header <new>. Use it to call a new handler you have defined or the default new handler.

Your new handler must perform one of the following:

- obtain more storage for memory allocation, then return
- throw an exception of type std::bad_alloc or a class derived from std::bad_alloc
- call either abort() or exit()

The set_new_handler() function has the prototype:

```
typedef void(*PNH)();  
PNH set_new_handler(PNH);
```

set_new_handler() takes as an argument a pointer to a function (the new handler), which has no arguments and returns void. It returns a pointer to the previous new handler function.

If you do not specify your own set_new_handler() function, new throws an exception of type std::bad_alloc.

The following program fragment shows how you could use set_new_handler() to return a message if the new operator cannot allocate storage:

```
#include <iostream>  
#include <new>  
#include <cstdlib>  
using namespace std;  
  
void no_storage()  
{  
    std::cerr << "Operator new failed: no storage is  
    available.\n";  
    std::exit(1);  
}  
int main(void)  
{  
    std::set_new_handler(&no_storage);  
    // Rest of program ...  
}
```

If the program fails because new cannot allocate storage, the program exits with the message:

```
Operator new failed:  
no storage is available.
```

delete expressions (C++ only)

The delete operator destroys the object created with new by deallocating the memory associated with the object.

The delete operator has a void return type.

delete operator syntax

► `[::] delete object_pointer` ►

The operand of delete must be a pointer returned by new, and cannot be a pointer to constant. Deleting a null pointer has no effect.

The delete[] operator frees storage allocated for array objects created with new[]. The delete operator frees storage allocated for individual objects created with new.

delete[] operator syntax

► `[::] delete [—] array` ►

The result of deleting an array object with delete is undefined, as is deleting an individual object with delete[]. The array dimensions do not need to be specified with delete[].

The result of any attempt to access a deleted object or array is undefined.

If a destructor has been defined for a class, delete invokes that destructor. Whether a destructor exists or not, delete frees the storage pointed to by calling the function operator delete() of the class if one exists.

The global ::operator delete() is used if:

- The class has no operator delete().
- The object is of a nonclass type.
- The object is deleted with the ::delete expression.

The global ::operator delete[] () is used if:

- The class has no operator delete[] ()
- The object is of a nonclass type
- The object is deleted with the ::delete[] expression.

The default global operator delete() only frees storage allocated by the default global operator new(). The default global operator delete[] () only frees storage allocated for arrays by the default global operator new[] ().

Related reference:

“The void type” on page 66

“Overview of constructors and destructors” on page 385

throw expressions (C++ only)

A *throw* expression is used to throw exceptions to C++ exception handlers. A throw expression is of type `void`.

Related reference:

Chapter 17, “Exception handling (C++ only),” on page 463

“The void type” on page 66

Label value expressions (IBM extension)

The label value operator `&&` returns the address of its operand, which must be a label defined in the current function or a containing function. The value is a constant of type `void*` and should be used only in a computed goto statement. The language feature is an extension to C and C++, implemented to facilitate porting programs developed with GNU C. For details, see “Labels as values (IBM extension)” on page 220.

Related reference:

“Labels as values (IBM extension)” on page 220

Computed goto statement

Operator precedence and associativity

Two operator characteristics determine how operands group with operators: *precedence* and *associativity*. Precedence is the priority for grouping different types of operators with their operands. Associativity is the left-to-right or right-to-left order for grouping operands to operators that have the same precedence. An operator's precedence is meaningful only if other operators with higher or lower precedence are present. Expressions with higher-precedence operators are evaluated first. The grouping of operands can be forced by using parentheses.

For example, in the following statements, the value of 5 is assigned to both `a` and `b` because of the right-to-left associativity of the `=` operator. The value of `c` is assigned to `b` first, and then the value of `b` is assigned to `a`.

```
b = 9;  
c = 5;  
a = b = c;
```

Because the order of subexpression evaluation is not specified, you can explicitly force the grouping of operands with operators by using parentheses.

In the expression

```
a + b * c / d
```

the `*` and `/` operations are performed before `+` because of precedence. `b` is multiplied by `c` before it is divided by `d` because of associativity.

The following tables list the C and C++ language operators in order of precedence and show the direction of associativity for each operator. Operators that have the same rank have the same precedence.

Table 35. Precedence and associativity of postfix operators

Rank	Right associative?	Operator function	Usage
1	yes	▶ C++ global scope resolution	<code>:: name_or_qualified name</code>
1		▶ C++ class or namespace scope resolution	<code>class_or_namespace :: member</code>
2		member selection	<code>object . member</code>
2		member selection	<code>pointer -> member</code>
2		subscripting	<code>pointer [expr]</code>
2		function call	<code>expr (expr_list)</code>
2		value construction	<code>type (expr_list)</code>
2		postfix increment	<code>lvalue ++</code>
2		postfix decrement	<code>lvalue --</code>
2	yes	▶ C++ type identification	<code>typeid (type)</code>
2	yes	▶ C++ type identification at run time	<code>typeid (expr)</code>
2	yes	▶ C++ conversion checked at compile time	<code>static_cast < type > (expr)</code>
2	yes	▶ C++ conversion checked at run time	<code>dynamic_cast < type > (expr)</code>
2	yes	▶ C++ unchecked conversion	<code>reinterpret_cast < type > (expr)</code>
2	yes	▶ C++ const conversion	<code>const_cast < type > (expr)</code>

Table 36. Precedence and associativity of unary operators

Rank	Right associative?	Operator function	Usage
3	yes	size of object in bytes	<code>sizeof expr</code>
3	yes	size of type in bytes	<code>sizeof (type)</code>
3	yes	prefix increment	<code>++ lvalue</code>
3	yes	prefix decrement	<code>-- lvalue</code>
3	yes	bitwise negation	<code>~ expr</code>
3	yes	not	<code>! expr</code>
3	yes	unary minus	<code>- expr</code>
3	yes	unary plus	<code>+ expr</code>
3	yes	address of	<code>& lvalue</code>
3	yes	indirection or dereference	<code>* expr</code>
3	yes	▶ C++ create (allocate memory)	<code>new type</code>

Table 36. Precedence and associativity of unary operators (continued)





Rank	Right associative?	Operator function	Usage
3	yes	 create (allocate and initialize memory)	<code>new type (expr_list) type</code>
3	yes	 create (placement)	<code>new type (expr_list) type (expr_list)</code>
3	yes	 destroy (deallocate memory)	<code>delete pointer</code>
3	yes	 destroy array	<code>delete [] pointer</code>
3	yes	type conversion (cast)	<code>(type) expr</code>

Table 37. Precedence and associativity of binary operators



Rank	Right associative?	Operator function	Usage
4		 member selection	<code>object .* ptr_to_member</code>
4		 member selection	<code>object ->* ptr_to_member</code>
5		multiplication	<code>expr * expr</code>
5		division	<code>expr / expr</code>
5		modulo (remainder)	<code>expr % expr</code>
6		binary addition	<code>expr + expr</code>
6		binary subtraction	<code>expr - expr</code>
7		bitwise shift left	<code>expr << expr</code>
7		bitwise shift right	<code>expr >> expr</code>
8		less than	<code>expr < expr</code>
8		less than or equal to	<code>expr <= expr</code>
8		greater than	<code>expr > expr</code>
8		greater than or equal to	<code>expr >= expr</code>
9		equal	<code>expr == expr</code>
9		not equal	<code>expr != expr</code>
10		bitwise AND	<code>expr & expr</code>
11		bitwise exclusive OR	<code>expr ^ expr</code>
12		bitwise inclusive OR	<code>expr expr</code>
13		logical AND	<code>expr && expr</code>
14		logical inclusive OR	<code>expr expr</code>
15		conditional expression	<code>expr ? expr : expr</code>
16	yes	simple assignment	<code>lvalue = expr</code>
16	yes	multiply and assign	<code>lvalue *= expr</code>
16	yes	divide and assign	<code>lvalue /= expr</code>
16	yes	modulo and assign	<code>lvalue %= expr</code>
16	yes	add and assign	<code>lvalue += expr</code>

Table 37. Precedence and associativity of binary operators (continued)

Rank	Right associative?	Operator function	Usage
16	yes	subtract and assign	<i>lvalue -= expr</i>
16	yes	shift left and assign	<i>lvalue <<= expr</i>
16	yes	shift right and assign	<i>lvalue >>= expr</i>
16	yes	bitwise AND and assign	<i>lvalue &= expr</i>
16	yes	bitwise exclusive OR and assign	<i>lvalue ^= expr</i>
16	yes	bitwise inclusive OR and assign	<i>lvalue = expr</i>
17	yes	 throw expression	throw <i>expr</i>
18		comma (sequencing)	<i>expr , expr</i>

Examples of expressions and precedence

The parentheses in the following expressions explicitly show how the compiler groups operands and operators.

```
total = (4 + (5 * 3));
total = (((8 * 5) / 10) / 3);
total = (10 + (5/3));
```

If parentheses did not appear in these expressions, the operands and operators would be grouped in the same manner as indicated by the parentheses. For example, the following expressions produce the same output.

```
total = (4+(5*3));
total = 4+5*3;
```

Because the order of grouping operands with operators that are both associative and commutative is not specified, the compiler can group the operands and operators in the expression:

```
total = price + prov_tax + city_tax;
```

in the following ways as indicated by parentheses:

```
total = (price + (prov_tax + city_tax));
total = ((price + prov_tax) + city_tax);
total = ((price + city_tax) + prov_tax);
```

The grouping of operands and operators does not affect the result.

Because intermediate values are rounded, different groupings of floating-point operators may give different results.

In certain expressions, the grouping of operands and operators can affect the result. For example, in the following expression, each function call might be modifying the same global variables.

```
a = b() + c() + d();
```

This expression can give different results depending on the order in which the functions are called.

If the expression contains operators that are both associative and commutative and the order of grouping operands with operators can affect the result of the expression, separate the expression into several expressions. For example, the following expressions could replace the previous expression if the called functions do not produce any side effects that affect the variable `a`.

```
a = b();
a += c();
a += d();
```

The order of evaluation for function call arguments or for the operands of binary operators is not specified. Therefore, the following expressions are ambiguous:

```
z = (x * ++y) / func1(y);
func2(++i, x[i]);
```

If `y` has the value of 1 before the first statement, it is not known whether or not the value of 1 or 2 is passed to `func1()`. In the second statement, if `i` has the value of 1 before the expression is evaluated, it is not known whether `x[1]` or `x[2]` is passed as the second argument to `func2()`.

Reference collapsing (C++11)

Note: IBM supports selected features of C++11, known as C++0x before its ratification. IBM will continue to develop and implement the features of this standard. The implementation of the language level is based on IBM's interpretation of the standard. Until IBM's implementation of all the C++11 features is complete, including the support of a new C++11 standard library, the implementation might change from release to release. IBM makes no attempt to maintain compatibility, in source, binary, or listings and other compiler interfaces, with earlier releases of IBM's implementation of the new C++11 features.

Before C++11, references to references are ill-formed in the C++ language. In C++11, the rules of reference collapsing apply when you use references to references through one of the following contexts:

- A `decltype` specifier
- A `typedef` name
- A template type parameter

You can define a variable `var` whose declared type `TR` is a reference to the type `T`, where `T` is also a reference type. For example,

```
// T denotes the int& type
typedef int& T;

// TR is an lvalue reference to T
typedef T& TR;

// The declared type of var is TR
TR var;
```

The actual type of `var` is listed in the following table for different cases, where neither `TR` nor `T` is qualified by `cv`-qualifiers.

Table 38. Reference collapsing without cv-qualifiers

T	TR	Type of var
A	T	A ¹
A	T&	A& ¹

Table 38. Reference collapsing without cv-qualifiers (continued)

T	TR	Type of var
A	T&&	A&& ¹
A&	T	A& ¹
A&	T&	A&
A&	T&&	A&
A&&	T	A&& ¹
A&&	T&	A&
A&&	T&&	A&&

Note:
1. Reference collapsing does not apply in this case, because T and TR are not both reference types.

The general rule in this table is that when T and TR are both reference types, but are not both rvalue reference types, var is of an lvalue reference type.

Example 1

```
typedef int& T;
// a has the type int&
T&& a;
```

In this example, T is of the int& type, and the declared type of a is T&&. After reference collapsing, the type of a is int&.

Example 2

```
template <typename T> void func(T&& a);
auto fp = func<int&&>;
```

In this example, the actual parameter of T is of the int&& type, and the declared type of a is T&&. An rvalue reference to an rvalue reference is formed. After reference collapsing, the type of a is int&&.

Example 3

```
auto func(int& a) -> const decltype(a)&;
```

In this example, decltype(a), which is a trailing return type, refers to the parameter a, whose type is int&. After reference collapsing, the return type of func is int&.

You can define a variable var whose declared type TR is a reference to the type T, where T is also a reference type. If either TR or T is qualified by cv-qualifiers, then the actual type of var is listed in the following table for different cases.

Table 39. Reference collapsing with cv-qualifiers

T	TR	Type of var
A	const T	const A ¹
const A	volatile T&	const volatile A& ¹
A	const T&&	const A&& ¹
A&	const T	A& ¹
const A&	volatile T&	const A&

Table 39. Reference collapsing with cv-qualifiers (continued)

T	TR	Type of var
const A&	T&&	const A&
A&&	const T	A&& ¹
const A&&	volatile T&	const A&
const A&&	T&&	const A&&
Note: 1. Reference collapsing does not apply in this case, because T and TR are not both reference types.		

The general rule of this table is that when T is a reference type, the type of var inherits only the cv-qualifiers from T.

Related reference:

 See Using rvalue references (C++11) in the XL C/C++ Optimization and Programming Guide

“The decltype(*expression*) type specifier (C++11)” on page 90

“typedef definitions” on page 86

“Type template parameters” on page 412

Chapter 8. Statements

A statement, the smallest independent computational unit, specifies an action to be performed. In most cases, statements are executed in sequence.

The following list is a summary of the statements available in C and C++:

- “Labeled statements”
- “Expression statements” on page 221
- “Block statements” on page 222
- “Selection statements” on page 223
- “Iteration statements” on page 229
- “Jump statements” on page 233
- “Null statement” on page 237
- “Inline assembly statements (IBM extension)” on page 238

Related reference:

Chapter 4, “Data objects and declarations,” on page 47

“Function declarations” on page 247

“try blocks” on page 463

Labeled statements

There are three kinds of labels: identifier, case, and default.

Labeled statement syntax

►► *identifier* : *statement* ◀◀

The label consists of the *identifier* and the colon (:) character.

► **C** A label name must be unique within the function in which it appears.

► **C**

► **C++** In C++, an identifier label can only be used as the target of a `goto` statement. A `goto` statement can use a label before its definition. Identifier labels have their own namespace; you do not have to worry about identifier labels conflicting with other identifiers. However, you cannot redeclare a label within a function. **C++** ◀

Case and default label statements only appear in `switch` statements. These labels are accessible only within the closest enclosing `switch` statement.

case statement syntax

►► *case* *constant_expression* : *statement* ◀◀

default statement syntax

►► *default* : *statement* ◀◀

The following are examples of labels:

```
comment_complete : ; /* null statement label */
test_for_null : if (NULL == pointer)
```

Related reference:

“The goto statement” on page 236

“The switch statement” on page 225

Locally declared labels (IBM extension)

A locally declared label, or *local label*, is an identifier label that is declared at the beginning of a statement expression and for which the scope is the statement expression in which it is declared and defined. This language feature is an extension of C and C++ to facilitate handling programs developed with GNU C.

A local label can be used as the target of a goto statement, jumping to it from within the same block in which it was declared. This language extension is particularly useful for writing macros that contain nested loops, capitalizing on the difference between its statement scope and the function scope of an ordinary label.

Locally declared label syntax



The declaration of local labels must precede any ordinary declarations and statements. The label declaration defines only the label name, so you must define the label itself in the usual way, with a name and a colon, within the statements of the statement expression.

Related reference:

“Statement expressions (IBM extension)” on page 223

Labels as values (IBM extension)

The address of a label defined in the current function or a containing function can be obtained and used as a value wherever a constant of type `void*` is valid. The address is the return value when the label is the operand of the unary operator `&&`. The ability to use the address of label as a value is an extension to C99 and C++, implemented to facilitate porting programs developed with GNU C.

In the following example, the computed goto statements use the values of `label1` and `label2` to jump to those spots in the function.

```
int main()
{
    void * ptr1, *ptr2;
    ...
    label1: ...
    ...
    label2: ...
    ...
    ptr1 = &&label1;
    ptr2 = &&label2;
    if (...) {
        goto *ptr1;
    } else {
```

```

        goto *ptr2;
    }
    ...
}

```

Related reference:

Computed goto statement
 “References (C++ only)” on page 123

Expression statements

An *expression statement* contains an expression. The expression can be null.

Expression statement syntax

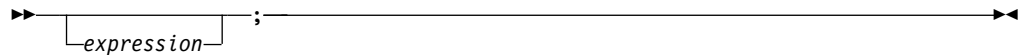

An expression statement evaluates *expression*, then discards the value of the expression. An expression statement without an expression is a null statement.

See the following examples of statements:

```

printf("Account Number: \n");          /* call to the printf */
marks = dollars * exch_rate;           /* assignment to marks */
(difference < 0) ? ++losses : ++gain; /* conditional increment */
  
```

Related reference:

Chapter 7, “Expressions and operators,” on page 159

Resolution of ambiguous statements (C++ only)

The C++ syntax does not disambiguate between expression statements and declaration statements. The ambiguity arises when an expression statement has a function-style cast as its left-most subexpression. (Note that, because C does not support function-style casts, this ambiguity does not occur in C programs.) If the statement can be interpreted both as a declaration and as an expression, the statement is interpreted as a declaration statement.

Note: The ambiguity is resolved only on a syntactic level. The disambiguation does not use the meaning of the names, except to assess whether or not they are type names.

The following expressions disambiguate into expression statements because the ambiguous subexpression is followed by an assignment or an operator. *type_spec* in the expressions can be any type specifier:

```

type_spec(i)++;           // expression statement
type_spec(i,3)<<d;        // expression statement
type_spec(i)->l=24;       // expression statement
  
```

In the following examples, the ambiguity cannot be resolved syntactically, and the statements are interpreted as declarations. *type_spec* is any type specifier:

```

type_spec(*) (int);      // declaration
type_spec(j)[5];         // declaration
type_spec(m) = { 1, 2 }; // declaration
type_spec(*k) (float(3)); // declaration
  
```

The last statement above causes a compile-time error because you cannot initialize a pointer with a float value.

Any ambiguous statement that is not resolved by the above rules is by default a declaration statement. All of the following are declaration statements:

```
type_spec(a);           // declaration
type_spec(*b)();       // declaration
type_spec(c)=23;       // declaration
type_spec(d),e,f,g=0;  // declaration
type_spec(h)(e,3);     // declaration
```

Related reference:

Chapter 4, “Data objects and declarations,” on page 47

Chapter 7, “Expressions and operators,” on page 159

“Function call expressions” on page 167

Block statements

A *block statement*, or *compound statement*, lets you group any number of data definitions, declarations, and statements into one statement. All definitions, declarations, and statements enclosed within a single set of braces are treated as a single statement. You can use a block wherever a single statement is allowed.

Block statement syntax

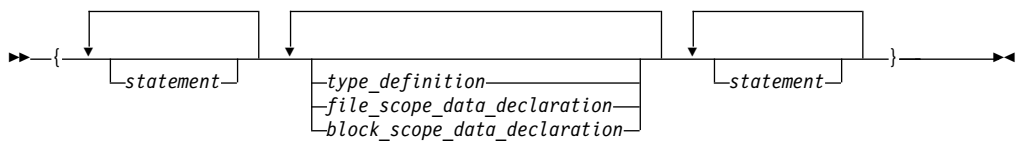

A block defines a local scope. If a data object is usable within a block and its identifier is not redefined, all nested blocks can use that data object.

Example of blocks

The following program shows how the values of data objects change in nested blocks:

```
/**
 ** This example shows how data objects change in nested blocks.
 **/
#include <stdio.h>

int main(void)
{
    int x = 1;           /* Initialize x to 1 */
    int y = 3;

    if (y > 0)
    {
        int x = 2;      /* Initialize x to 2 */
        printf("second x = %4d\n", x);
    }
    printf("first x = %4d\n", x);

    return(0);
}
```

The program produces the following output:

```
second x = 2
first x = 1
```

Two variables named `x` are defined in `main`. The first definition of `x` retains storage while `main` is running. However, because the second definition of `x` occurs within a nested block, `printf("second x = %4d\n", x);` recognizes `x` as the variable defined on the previous line. Because `printf("first x = %4d\n", x);` is not part of the nested block, `x` is recognized as the first definition of `x`.

Statement expressions (IBM extension)

A block statement is a sequence of statements enclosed by braces. In GNU C, a compound statement inside parentheses might appear as an expression in what is called a *statement expression*.

Statement expression syntax



The value of a statement expression is the value of the last simple expression to appear in the entire construct. If the last statement is not an expression, then the construct is of type `void` and has no value.

The statement expression can be combined with the `typeof` operator to create complex function-like macros in which each operand is evaluated only once. For example:

```
#define SWAP(a,b) ( {__typeof__(a) temp; temp=a; a=b; b=temp;} )
```

Selection statements

Selection statements consist of the following types of statements:

- The `if` statement
- The `switch` statement

The `if` statement

An `if` statement is a selection statement that allows more than one possible flow of control.

C++ An `if` statement lets you conditionally process a statement when the specified test expression, implicitly converted to `bool`, evaluates to `true`. If the implicit conversion to `bool` fails the program is ill-formed. **C++**

C In C, an `if` statement lets you conditionally process a statement when the specified test expression evaluates to a nonzero value. The test expression must be of arithmetic or pointer type. **C**

You can optionally specify an `else` clause on the `if` statement. If the test expression evaluates to `false` (or in C, a zero value) and an `else` clause exists, the statement associated with the `else` clause runs. If the test expression evaluates to `true`, the statement following the expression runs and the `else` clause is ignored.

`if` statement syntax

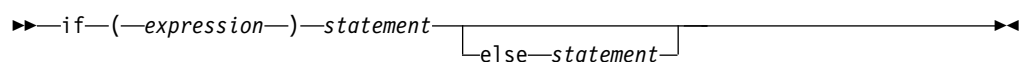

When if statements are nested and else clauses are present, a given else is associated with the closest preceding if statement within the same block.

A single statement following any selection statements (if, switch) is treated as a compound statement containing the original statement. As a result any variables declared on that statement will be out of scope after the if statement. For example:

```
if (x)
int i;
```

is equivalent to:

```
if (x)
{ int i; }
```

Variable i is visible only within the if statement. The same rule applies to the else part of the if statement.

Examples of if statements

The following example causes grade to receive the value A if the value of score is greater than or equal to 90.

```
if (score >= 90)
    grade = 'A';
```

The following example displays Number is positive if the value of number is greater than or equal to 0. If the value of number is less than 0, it displays Number is negative.

```
if (number >= 0)
    printf("Number is positive\n");
else
    printf("Number is negative\n");
```

The following example shows a nested if statement:

```
if (paygrade == 7)
    if (level >= 0 && level <= 8)
        salary *= 1.05;
    else
        salary *= 1.04;
else
    salary *= 1.06;
cout << "salary is " << salary << endl;
```

The following example shows a nested if statement that does not have an else clause. Because an else clause always associates with the closest if statement, braces might be needed to force a particular else clause to associate with the correct if statement. In this example, omitting the braces would cause the else clause to associate with the nested if statement.

```
if (kegs > 0) {
    if (furlongs > kegs)
        fxph = furlongs/kegs;
}
else
    fxph = 0;
```

The following example shows an if statement nested within an else clause. This example tests multiple conditions. The tests are made in order of their appearance. If one test evaluates to a nonzero value, a statement runs and the entire if statement ends.

```

if (value > 0)
    ++increase;
else if (value == 0)
    ++break_even;
else
    ++decrease;

```

Related reference:

“Boolean types” on page 63

The switch statement

A *switch statement* is a selection statement that lets you transfer control to different statements within the switch body depending on the value of the switch expression. The switch expression must evaluate to an integral or enumeration value. The body of the switch statement contains *case clauses* that consist of

- A case label
- An optional default label
- A case expression
- A list of statements.

If the value of the switch expression equals the value of one of the case expressions, the statements following that case expression are processed. If not, the default label statements, if any, are processed.

switch statement syntax

►►—switch—(—expression—)—switch_body—►►

The *switch body* is enclosed in braces and can contain definitions, declarations, *case clauses*, and a *default clause*. Each case clause and default clause can contain statements.

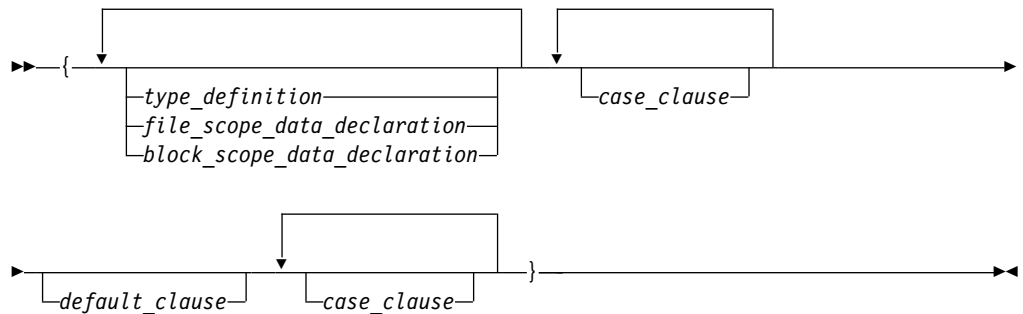

Note: An initializer within a *type_definition*, *file_scope_data_declaration* or *block_scope_data_declaration* is ignored.

A *case clause* contains a *case label* followed by any number of statements. A case clause has the form:

Case clause syntax



A *case label* contains the word `case` followed by an integral constant expression and a colon. The value of each integral constant expression must represent a different value; you cannot have duplicate case labels. Anywhere you can put one case label, you can put multiple case labels. A case label has the form:

case label syntax

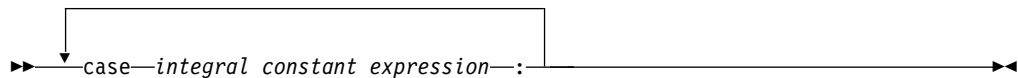

A *default clause* contains a default label followed by one or more statements. You can put a case label on either side of the default label. A `switch` statement can have only one default label. A *default clause* has the form:

Default clause statement

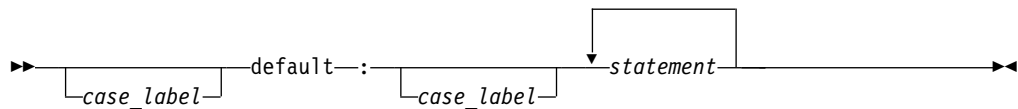

The `switch` statement passes control to the statement following one of the labels or to the statement following the `switch` body. The value of the expression that precedes the `switch` body determines which statement receives control. This expression is called the *switch expression*.

The value of the `switch` expression is compared with the value of the expression in each case label. If a matching value is found, control is passed to the statement following the case label that contains the matching value. If there is no matching value but there is a default label in the `switch` body, control passes to the default labelled statement. If no matching value is found, and there is no default label anywhere in the `switch` body, no part of the `switch` body is processed.

When control passes to a statement in the `switch` body, control only leaves the `switch` body when a `break` statement is encountered or the last statement in the `switch` body is processed.

If necessary, an integral promotion is performed on the controlling expression, and all expressions in the case statements are converted to the same type as the controlling expression. The `switch` expression can also be of class type if there is a single conversion to integral or enumeration type.

Compiling with option `-qinfo=gen` finds case labels that fall through when they should not.

Restrictions on switch statements

You can put data definitions at the beginning of the switch body, but the compiler does not initialize auto and register variables at the beginning of a switch body. You can have declarations in the body of the switch statement.

You cannot use a switch statement to jump over initializations.

When the scope of an identifier with a variably modified type includes a case or default label of a switch statement, the entire switch statement is considered to be within the scope of that identifier. That is, the declaration of the identifier must precede the switch statement.

C++ In C++, you cannot transfer control over a declaration containing an explicit or implicit initializer unless the declaration is located in an inner block that is completely bypassed by the transfer of control. All declarations within the body of a switch statement that contain initializers must be contained in an inner block.

C++

Examples of switch statements

The following switch statement contains several case clauses and one default clause. Each clause contains a function call and a break statement. The break statements prevent control from passing down through each statement in the switch body.

If the switch expression evaluated to '/', the switch statement would call the function divide. Control would then pass to the statement following the switch body.

```
char key;

printf("Enter an arithmetic operator\n");
scanf("%c",&key);

switch (key)
{
    case '+':
        add();
        break;

    case '-':
        subtract();
        break;

    case '*':
        multiply();
        break;

    case '/':
        divide();
        break;

    default:
        printf("invalid key\n");
        break;
}
```

If the switch expression matches a case expression, the statements following the case expression are processed until a break statement is encountered or the end of the switch body is reached. In the following example, break statements are not

present. If the value of `text[i]` is equal to 'A', all three counters are incremented. If the value of `text[i]` is equal to 'a', `lettera` and `total` are increased. Only `total` is increased if `text[i]` is not equal to 'A' or 'a'.

```
char text[100];
int capa, lettera, total;

// ...

for (i=0; i<sizeof(text); i++) {

    switch (text[i])
    {
        case 'A':
            capa++;
        case 'a':
            lettera++;
        default:
            total++;
    }
}
```

The following switch statement performs the same statements for more than one case label:

```
/**
 ** This example contains a switch statement that performs
 ** the same statement for more than one case label.
 **/

#include <stdio.h>

int main(void)
{
    int month;

    /* Read in a month value */
    printf("Enter month: ");
    scanf("%d", &month);

    /* Tell what season it falls into */
    switch (month)
    {
        case 12:
        case 1:
        case 2:
            printf("month %d is a winter month\n", month);
            break;

        case 3:
        case 4:
        case 5:
            printf("month %d is a spring month\n", month);
            break;

        case 6:
        case 7:
        case 8:
            printf("month %d is a summer month\n", month);
            break;

        case 9:
        case 10:
        case 11:
            printf("month %d is a fall month\n", month);
            break;
    }
}
```

```

        case 66:
        case 99:
        default:
            printf("month %d is not a valid month\n", month);
    }

    return(0);
}

```

If the expression `month` has the value 3, control passes to the statement:
`printf("month %d is a spring month\n", month);`

The `break` statement passes control to the statement following the `switch` body.

Related reference:

-  See `-qinfo=gen` in the XL C/C++ Compiler Reference
- Case and default labels
- "The `break` statement" on page 233
- "Generalized constant expressions (C++11)" on page 167

Iteration statements

Iteration statements consist of the following types of statements:

- The `while` statement
- The `do` statement
- The `for` statement

Related reference:



- "Boolean types" on page 63



The `while` statement

A *while statement* repeatedly runs the body of a loop until the controlling expression evaluates to `false` (or `0` in C).

while statement syntax



▶▶ `while`—(*expression*)—*statement*————▶▶

 **C** The *expression* must be of arithmetic or pointer type.  **C**

 **C++** The expression must be convertible to `bool`.  **C++**

The expression is evaluated to determine whether or not to process the body of the loop. If the expression evaluates to `false`, the body of the loop never runs. If the expression does not evaluate to `false`, the loop body is processed. After the body has run, control passes back to the expression. Further processing depends on the value of the condition.

A `break`, `return`, or `goto` statement can cause a `while` statement to end, even when the condition does not evaluate to `false`.

 **C++** A `throw` expression also can cause a `while` statement to end prior to the condition being evaluated.  **C++**

In the following example, `item[index]` triples and is printed out, as long as the value of the expression `++index` is less than `MAX_INDEX`. When `++index` evaluates to `MAX_INDEX`, the `while` statement ends.

```
/**
 ** This example illustrates the while statement.
 **/

#define MAX_INDEX (sizeof(item) / sizeof(item[0]))
#include <stdio.h>

int main(void)
{
    static int item[ ] = { 12, 55, 62, 85, 102 };
    int index = 0;

    while (index < MAX_INDEX)
    {
        item[index] *= 3;
        printf("item[%d] = %d\n", index, item[index]);
        ++index;
    }

    return(0);
}
```

The do statement

A *do statement* repeatedly runs a statement until the test expression evaluates to false (or 0 in C). Because of the order of processing, the statement is run at least once.

do statement syntax

► do statement while (—expression—); ◀

► C The *expression* must be of arithmetic or pointer type. ◀ C

► C++ The controlling *expression* must be convertible to type `bool`. ◀ C++

The body of the loop is run before the controlling `while` clause is evaluated. Further processing of the `do` statement depends on the value of the `while` clause. If the `while` clause does not evaluate to false, the statement runs again. When the `while` clause evaluates to false, the statement ends.

A `break`, `return`, or `goto` statement can cause the processing of a `do` statement to end, even when the `while` clause does not evaluate to false.

► C++ A `throw` expression also can cause a `while` statement to end prior to the condition being evaluated. ◀ C++

The following example keeps incrementing `i` while `i` is less than 5:

```
#include <stdio.h>

int main(void) {
    int i = 0;
    do {
        i++;
        printf("Value of i: %d\n", i);
    }
```



```

    }
    while (i < 5);
    return 0;
}

```

See the following output of the above example:

```

Value of i: 1
Value of i: 2
Value of i: 3
Value of i: 4
Value of i: 5

```

The for statement

A *for statement* provides the following benefits:

- Evaluate an expression before the first iteration of the statement (*initialization*)
- Specify an expression to determine whether or not the statement should be processed (the *condition*)
- Evaluate an expression after each iteration of the statement (often used to increment for each iteration)
- Repeatedly process the statement if the controlling part does not evaluate to false (or 0 in C).

for statement syntax

```

▶▶ for ( [expression1] ; [expression2] ; [expression3] ) ▶▶
▶▶ statement ▶▶

```

expression1 is the *initialization expression*. It is evaluated only before the *statement* is processed for the first time. You can use this expression to initialize a variable. You can also use this expression to declare a variable, provided that the variable is not declared as static (it must be automatic and may also be declared as register). If you declare a variable in this expression, or anywhere else in *statement*, that variable goes out of scope at the end of the for loop. If you do not want to evaluate an expression prior to the first iteration of the statement, you can omit this expression.

expression2 is the *conditional expression*. It is evaluated before each iteration of the *statement*. **C** *expression2* must be of arithmetic or pointer type. **C**
C++ *expression2* must be convertible to type bool. **C++**

If *expression2* evaluates to **C** 0 **C** or **C++** false **C++**, the statement is not processed and control moves to the next statement following the for statement. If *expression2* does not evaluate to false, the statement is processed. If you omit *expression2*, it is as if the expression had been replaced by true, and the for statement is not terminated by failure of this condition.

expression3 is evaluated after each iteration of the *statement*. This expression is often used for incrementing, decrementing, or assigning to a variable. This expression is optional.

A break, return, or goto statement can cause a for statement to end, even when the second expression does not evaluate to false. If you omit *expression2*, you must use a break, return, or goto statement to end the for statement.

C++ You can set a compiler option that allows a variable declared in the scope of a for statement to have a scope that is not local to the for statement.

Examples of for statements

The following for statement prints the value of count 20 times. The for statement initially sets the value of count to 1. After each iteration of the statement, count is incremented.

```
int count;
for (count = 1; count <= 20; count++)
    printf("count = %d\n", count);
```

The following sequence of statements accomplishes the same task. Note the use of the while statement instead of the for statement.

```
int count = 1;
while (count <= 20)
{
    printf("count = %d\n", count);
    count++;
}
```

The following for statement does not contain an initialization expression:

```
for (; index > 10; --index)
{
    list[index] = var1 + var2;
    printf("list[%d] = %d\n", index,
        list[index]);
}
```

The following for statement will continue running until scanf receives the letter e:

```
for (;;)
{
    scanf("%c", &letter);
    if (letter == '\n')
        continue;
    if (letter == 'e')
        break;
    printf("You entered the letter %c\n", letter);
}
```

The following for statement contains multiple initializations and increments. The comma operator makes this construction possible. The first comma in the for expression is a punctuator for a declaration. It declares and initializes two integers, i and j. The second comma, a comma operator, allows both i and j to be incremented at each step through the loop.

```
for (int i = 0,
    j = 50; i < 10; ++i, j += 50)
{
    cout << "i = " << i << "and j = " << j
        << endl;
}
```

The following example shows a nested for statement. It prints the values of an array having the dimensions [5][3].

```

for (row = 0; row < 5; row++)
    for (column = 0; column < 3; column++)
        printf("%d\n",
            table[row][column]);

```

The outer statement is processed as long as the value of `row` is less than 5. Each time the outer `for` statement is executed, the inner `for` statement sets the initial value of `column` to zero and the statement of the inner `for` statement is executed 3 times. The inner statement is executed as long as the value of `column` is less than 3.

Related reference:



See `-qlanglvl=noansifor` in the XL C/C++ Compiler Reference

Jump statements

Jump statements consist of the following types of statements:

- “The `break` statement”
- “The `continue` statement”
- “The `return` statement” on page 235
- “The `goto` statement” on page 236

The `break` statement

A *break statement* lets you end an *iterative* (`do`, `for`, or `while`) statement or a `switch` statement and exit from it at any point other than the logical end. A `break` may only appear on one of these statements.

break statement syntax

```

▶▶ break;

```

In an iterative statement, the `break` statement ends the loop and moves control to the next statement outside the loop. Within nested statements, the `break` statement ends only the smallest enclosing `do`, `for`, `switch`, or `while` statement.

In a `switch` statement, the `break` passes control out of the `switch` body to the next statement outside the `switch` statement.

The `continue` statement

A *continue statement* ends the current iteration of a loop. Program control is passed from the `continue` statement to the end of the loop body.

A `continue` statement has the form:

```

▶▶ continue;

```

A `continue` statement can only appear within the body of an iterative statement, such as `do`, `for`, or `while`.

The `continue` statement ends the processing of the action part of an iterative statement and moves control to the loop continuation portion of the statement. For example, if the iterative statement is a `for` statement, control moves to the third expression in the condition part of the statement, then to the second expression (the test) in the condition part of the statement.

Within nested statements, the continue statement ends only the current iteration of the do, for, or while statement immediately enclosing it.

Examples of continue statements

The following example shows a continue statement in a for statement. The continue statement causes processing to skip over those elements of the array rates that have values less than or equal to 1.

```
/**
 ** This example shows a continue statement in a for statement.
 **/

#include <stdio.h>
#define SIZE 5

int main(void)
{
    int i;
    static float rates[SIZE] = { 1.45, 0.05, 1.88, 2.00, 0.75 };

    printf("Rates over 1.00\n");
    for (i = 0; i < SIZE; i++)
    {
        if (rates[i] <= 1.00) /* skip rates <= 1.00 */
            continue;
        printf("rate = %.2f\n", rates[i]);
    }

    return(0);
}
```

The program produces the following output:

```
Rates over 1.00
rate = 1.45
rate = 1.88
rate = 2.00
```

The following example shows a continue statement in a nested loop. When the inner loop encounters a number in the array strings, that iteration of the loop ends. Processing continues with the third expression of the inner loop. The inner loop ends when the '\0' escape sequence is encountered.

```
/**
 ** This program counts the characters in strings that are part
 ** of an array of pointers to characters. The count excludes
 ** the digits 0 through 9.
 **/

#include <stdio.h>
#define SIZE 3

int main(void)
{
    static char *strings[SIZE] = { "ab", "c5d", "e5" };
    int i;
    int letter_count = 0;
    char *pointer;
    for (i = 0; i < SIZE; i++) /* for each string */
        /* for each character */
        for (pointer = strings[i]; *pointer != '\0';
            ++pointer)
        {
            /* if a number */
            if (*pointer >= '0' && *pointer <= '9')
                continue;
        }
}
```

```

        letter_count++;
    }
    printf("letter count = %d\n", letter_count);

    return(0);
}

```

The program produces the following output:

```
letter count = 5
```

The return statement

A *return statement* ends the processing of the current function and returns control to the caller of the function.

return statement syntax

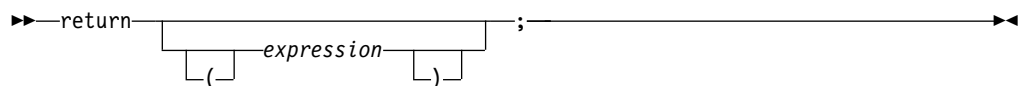

A value-returning function should include a return statement, containing an *expression*.

C If an expression is not given on a return statement in a function declared with a non-void return type, the compiler issues a warning message. **C**

C++ If an expression is not given on a return statement in a function declared with a non-void return type, the compiler issues an error message. **C++**

If the data type of the expression is different from the function return type, conversion of the return value takes place as if the value of the expression were assigned to an object with the same function return type.

For a function of return type `void`, a return statement is not strictly necessary. If the end of such a function is reached without encountering a return statement, control is passed to the caller as if a return statement without an expression were encountered. In other words, an implicit return takes place upon completion of the final statement, and control automatically returns to the calling function.

C++ If a return statement is used, it must not contain an expression. **C++**

Examples of return statements

The following are examples of return statements:

```

return;           /* Returns no value */
return result;   /* Returns the value of result */
return 1;        /* Returns the value 1 */
return (x * x);  /* Returns the value of x * x */

```

The following function searches through an array of integers to determine if a match exists for the variable `number`. If a match exists, the function `match` returns the value of `i`. If a match does not exist, the function `match` returns the value `-1` (negative one).

```

int match(int number, int array[ ], int n)
{
    int i;

```

```

    for (i = 0; i < n; i++)
        if (number == array[i])
            return (i);
    return(-1);
}

```

A function can contain multiple return statements. For example:

```

void copy( int *a, int *b, int c)
{
    /* Copy array a into b, assuming both arrays are the same size */

    if (!a || !b)          /* if either pointer is 0, return */
        return;

    if (a == b)           /* if both parameters refer */
        return;           /* to same array, return */

    if (c == 0)           /* nothing to copy */
        return;

    for (int i = 0; i < c; ++i) /* do the copying */
        b[i] = a[i];         /* implicit return */
}

```

In this example, the return statement is used to cause a premature termination of the function, similar to a break statement.

An expression appearing in a return statement is converted to the return type of the function in which the statement appears. If no implicit conversion is possible, the return statement is invalid.

Related reference:

“Function return type specifiers” on page 261

“Function return values” on page 262

The goto statement

A goto statement causes your program to unconditionally transfer control to the statement that is associated with the label specified on the goto statement.

goto statement syntax

►► `goto label_identifier;` ◄◄

Because the goto statement can interfere with the normal sequence of processing, it makes a program more difficult to read and maintain. Often, a break statement, a continue statement, or a function call can eliminate the need for a goto statement.

If an active block is exited using a goto statement, any local variables are destroyed when control is transferred from that block.

You cannot use a goto statement to jump over initializations.

A goto statement is allowed to jump within the scope of a variable length array, but not past any declarations of objects with variably modified types.

The following example shows a `goto` statement that is used to jump out of a nested loop. This function could be written without using a `goto` statement.

```
/**
 ** This example shows a goto statement that is used to
 ** jump out of a nested loop.
 **/

#include <stdio.h>
void display(int matrix[3][3]);

int main(void)
{
    int matrix[3][3]= {1,2,3,4,5,2,8,9,10};
    display(matrix);
    return(0);
}

void display(int matrix[3][3])
{
    int i, j;

    for (i = 0; i < 3; i++)
        for (j = 0; j < 3; j++)
        {
            if ( (matrix[i][j] < 1) || (matrix[i][j] > 6) )
                goto out_of_bounds;
            printf("matrix[%d][%d] = %d\n", i, j, matrix[i][j]);
        }
    return;
    out_of_bounds: printf("number must be 1 through 6\n");
}
```

Computed goto statement (IBM extension)

A computed `goto` is a `goto` statement for which the target is a label from the same function. The address of the label is a constant of type `void*`, and is obtained by applying the unary label value operator `&&` to the label. The target of a computed `goto` is known at run time, and all computed `goto` statements from the same function will have the same targets. The language feature is an extension to C99 and C++, implemented to facilitate porting programs developed with GNU C.

Computed goto statement syntax

▶▶—`goto—*expression—;`—▶▶

The **expression* is an expression of type `void*`.

Related reference:

“Labeled statements” on page 219

“Labels as values (IBM extension)” on page 220

“Label value expressions (IBM extension)” on page 212

Null statement

The *null statement* performs no operation. It has the form:

▶▶—`;`—▶▶

A null statement can hold the label of a labeled statement or complete the syntax of an iterative statement.

The following example initializes the elements of the array price. Because the initializations occur within the for expressions, a statement is only needed to finish the for syntax; no operations are required.

```
for (i = 0; i < 3; price[i++] = 0)
    ;
```

A null statement can be used when a label is needed before the end of a block statement. For example:

```
void func(void) {
    if (error_detected)
        goto depart;
    /* further processing */
    depart: ; /* null statement required */
}
```

Inline assembly statements (IBM extension)

Under extended language levels, the compiler provides support for embedded assembly code fragments among C and C++ source statements. This extension has been implemented for use in general system programming code, and in the operating system kernel and device drivers, which were originally developed with GNU C.

The keyword `asm` stands for assembly code. When strict language levels are used in compilation, the C compiler treats `asm` as a regular identifier and reserves `__asm` and `__asm__` as keywords. The C++ compiler always recognizes the `asm`, `__asm`, and `__asm__` keywords.

The syntax is as follows:

asm statement syntax — statement in local scope

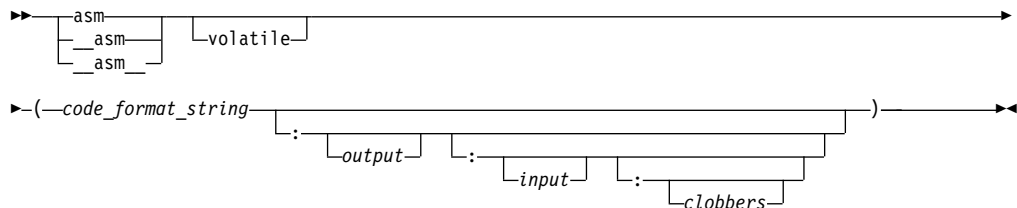

input:

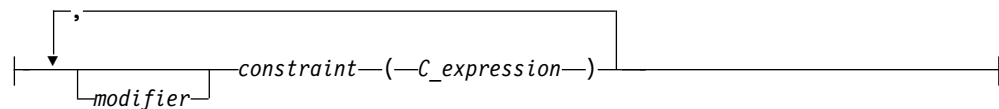

output:

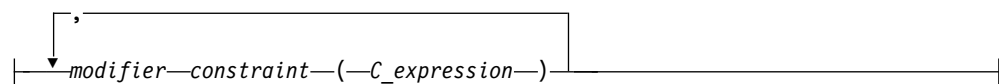

volatile

The qualifier `volatile` instructs the compiler to perform only minimal

optimizations on the assembly block. The compiler cannot move any instructions across the implicit fences surrounding the assembly block. See Example 1 for detailed usage information.

code_format_string

The *code_format_string* is the source text of the asm instructions and is a string literal similar to a printf format specifier.

Operands are referred to in the *%integer* format, where *integer* refers to the sequential number of the input or output operand. See Example 1 for detailed usage information.

To increase readability, each operand can be given a symbolic name enclosed in brackets. In the assembler code section, you can refer to each operand in the *%[symbolic_name]* format, where the *symbolic_name* is referenced in the operand list. You can use any name, including existing C or C++ symbols, because the symbolic names have no relation to any C or C++ identifiers. However, no two operands in the same assembly statement can use the same symbolic name. See Example 2 for detailed usage information.

output

The *output* consists of zero, one or more output operands, separated by commas. Each operand consists of a *constraint(C_expression)* pair. The output operand must be constrained by the = or + modifier (described below), and, optionally, by an additional % or & modifier.

input The *input* consists of zero, one or more input operands, separated by commas. Each operand consists of a *constraint(C_expression)* pair.

clobbers

clobbers is a comma-separated list of register names enclosed in double quotes. If an asm instruction updates registers that are not listed in the *input* or *output* of the asm statement, the registers must be listed as clobbered registers. The following register names are valid :

r0 to r31

General purpose registers

f0 to f31

Floating-point registers

lr Link register

ctr Loop count, decrement and branching register

fpscr Floating-point status and control register

xer Fixed-point exception register

cr0 to cr7

Condition registers. Example 3 shows a typical use of condition registers in the *clobbers*.

v0 to v31

Vector registers (on selected processors only)

In addition to the register names, *cc* and *memory* can also be used in the list of clobbered registers. The usage information of *cc* and *memory* is listed as follows:

cc Add *cc* to the list of clobbered registers if assembler instructions can alter the condition code register.

memory

Add memory to the clobber list if assembler instructions can change a memory location in an unpredictable fashion. The memory clobber ensures that the compiler does not move the assembler instruction across other memory references and ensures that any data that is used after the completion of the assembly statement is valid.

However, the memory clobber can result in many unnecessary reloads, reducing the benefits of hardware prefetching. Thus, the memory clobber can impose a performance penalty and should be used with caution. See Example 4 and Example 1 for the detailed usage information.

modifier

The *modifier* can be one of the following operators:

- =** Indicates that the operand is write-only for this instruction. The previous value is discarded and replaced by output data. See Example 5 for detailed usage information.
- +** Indicates that the operand is both read and written by the instruction. See Example 6 for detailed usage information.
- &** Indicates that the operand may be modified before the instruction is finished using the input operands; a register that is used as input should not be reused here.
- %** Declares the instruction to be commutative for this operand and the following operand. This means that the order of this operand and the next may be swapped when generating the instruction. This modifier can be used on an input or output operand, but cannot be specified on the last operand. See Example 7 for detailed usage information.

constraint

The *constraint* is a string literal that describes the kind of operand that is permitted, one character per constraint. The following constraints are supported:

- b** Use a general register other than zero. Some instructions treat the designation of register 0 specially, and do not behave as expected if the compiler chooses *r0*. For these instructions, the designation of *r0* does not mean that *r0* is used. Instead, it means that the literal value 0 is specified. See Example 8 for detailed usage information.
- c** Use the CTR register.
- d** Use a floating-point register.
- f** Use a floating-point register. See Example 7 for detailed usage information.
- g** Use a general register, memory, or immediate operand. In the POWER® architecture, there are no instructions where a register, memory specifier, or immediate operand can be used interchangeably. However, this constraint is tolerated where it is possible to do so.
- h** Use the CTR or LINK register.

- i** Use an immediate integer or string literal operand.
- l** Use the CTR register.
- m** Use a memory operand supported by the machine. You can use this constraint for operands of the form $D(R)$, where D is a displacement and R is a register. See Example 9 for detailed usage information.
- n** Use an immediate integer.
- o** Use a memory operand that is offsetable. This means that the memory operand can be addressed by adding an integer to a base address. In the POWER architecture, memory operands are always offsetable, so the constraints **o** and **m** can be used interchangeably.
- r** Use a general register. See Example 5 for detailed usage information.
- s** Use a string literal operand.
- v** Use a vector register.

0, 1, ...8, 9

A matching constraint. Allocate the same register in output as in the corresponding input.

I, J, K, L, M, N, O, P

Constant values. Fold the expression in the operand and substitute the value into the `%` specifier. These constraints specify a maximum value for the operand, as follows:

- **I** — signed 16-bit
- **J** — unsigned 16-bit shifted left 16 bits
- **K** — unsigned 16-bit constant
- **L** — signed 16-bit shifted left 16 bits
- **M** — unsigned constant greater than 31
- **N** — unsigned constant that is an exact power of 2
- **O** — zero
- **P** — signed whose negation is a signed 16-bit constant

C_expression

The *C_expression* is a C or C++ expression whose value is used as the operand for the `asm` instruction. Output operands must be modifiable lvalues. The *C_expression* must be consistent with the constraint specified on it. For example, if **i** is specified, the operand must be an integer constant number.

Note: If pointer expressions are used in *input* or *output*, the assembly instructions honor the ANSI aliasing rule (see “Type-based aliasing” on page 116 for more information). This means that indirect addressing using values in pointer expression operands should be consistent with the pointer types; otherwise, you must disable the `-qalias=ansi` option during compilation.

Related reference:



See `-qalias=ansi` in the XL C/C++ Compiler Reference

Supported and unsupported constructs

Supported constructs

The inline assembly statements support the following constructs:

- All the instruction statements listed in the Assembler Language Reference
- All extended instruction mnemonics
- Label definitions
- Branches to labels

Unsupported constructs

The inline assembly statements do not support the following constructs:

- Pseudo-operation statements, which are assembly statements that begin with a dot (`.`), such as `.function`
- Branches between different `asm` blocks

In addition, some constraints originating from the GNU compiler are not supported, but are tolerated where it is possible. For example, constraints `S` and `T` are treated as immediates, but the compiler issues a warning message stating that they are unsupported.

Restrictions on inline assembly statements

The following restrictions are on the use of inline assembly statements:

- The assembler instructions must be self-contained within an `asm` statement. The `asm` statement can only be used to generate instructions. All connections to the rest of the program must be established through the output and input operand list.
- Referencing an external symbol directly without going through the operand list is not supported.
- Assembler instructions requiring a pair of registers are not specifiable by any constraints, and are therefore not supported. For example, you cannot use the `%f` constraint for a `_Decimal128` operand.
- The shared register file between the floating-point scalar and the vector registers are not modelled as shared in inline assembly statements. You must specify registers `f0-f31` and `v0-v31` in the clobbers list. There is no combined `x0-x63`.
- Operand replacements (such as `%0`, `%1`, and so on) can use an optional `x` before the number or symbolic name to indicate that a `vsx` register reference must be used. For example, a vector operand `%1` allocated to register `v0` is replaced with `0` (for use in `VMX` instructions). The same operand used as `%x1` in the assembly text is replaced with `32` (for use in `VSX` instructions). Note that this restriction applies only for architectures that support `VSX` architecture extension.

Related reference:

Assembly labels (IBM extension)

Variables in specified registers (IBM extension)



See `-qasm` in the XL C/C++ Compiler Reference

Examples of inline assembly statements

Example 1: The following example illustrates the usage of the `volatile` keyword.

```

#include <stdio.h>

inline bool acquireLock(int *lock){
    bool returnvalue = false;
    int lockval;
    asm volatile(
        /*-----a fence here-----*/
        " 0: lwarx %0,0,%2 \n" // Loads the word and reserves
                                // a memory location for the subsequent
                                // stwcx. instruction.
        "    cmpwi %0,0 \n" // Compares the lock value to 0.
        "    bne- 1f \n" // If it is 0, you can acquire the
                                // lock. Otherwise, you did not get the
                                // lock and must try again later.
        "    ori %0,%0,1 \n" // Sets the lock to 1.
        "    stwcx. %0,0,%2 \n" // Tries to conditionally store 1
                                // into the lock word to acquire
                                // the lock.
        "    bne- 0b \n" // Reservation was lost. Try again.
        "    isync \n" // Lock acquired. The isync instruction
                                // implements an import barrier to
                                // ensure that the instructions that
                                // access the shared region guarded by
                                // this lock are executed only after
                                // they acquire the lock.
        "    ori %1,%1,1 \n" // Sets the return value for the
                                // function acquireLock to true.
        " 1: \n" // Did not get the lock.
                                // Will return false.

        /*-----a fence here-----*/

        : "+r" (lockval),
          "+r" (returnvalue)
        : "r" (lock) // "lock" is the address of the lock in
                                // memory.

        : "cr0" // cr0 is clobbered by cmpwi and stwcx.
    );

    return returnvalue;
}

int main()
{
    int myLock;
    if(acquireLock(&myLock)){
        printf("got it!\n");
    }else{
        printf("someone else got it\n");
    }
    return 0;
}

```

In this example, %0 refers to the first operand "+r" (lockval), %1 refers to the second operand "+r" (returnvalue), and %2 refers to the third operand "r" (lock).

The assembly statement uses a lock to control access to the shared storage; no instruction can access the shared storage before acquiring the lock.

The `volatile` keyword implies fences around the assembly instruction group, so that no assembly instructions can be moved out of or around the assembly block.

Without the `volatile` keyword, the compiler can move the instructions around for optimization. This might cause some instructions to access the shared storage without acquiring the lock.

It is unnecessary to use the memory clobber in this assembly statement, because the instructions do not modify memory in an unexpected way. If you use the memory clobber, the program is still functionally correct. However, the memory clobber results in many unnecessary reloads, imposing a performance penalty.

Example 2: The following example illustrates the use of the symbolic names for input and output operands.

```
int a ;
int b = 1, c = 2, d = 3 ;
__asm("  addc %[result], %[first], %[second]"
      : [result]      "=r"      (a)
      : [first]       "r"       (b),
        [second]      "r"       (d)
      );
```

In this example, `[result]` refers to the output operand variable `a`, `[first]` refers to the input operand variable `b`, and `[second]` refers to the input operand variable `d`.

Example 3: The following example shows a typical use of condition registers in the *clobbers*.

```
asm ("  add. %0,%1,%2  \n"
     : "=r"      (c)
     : "r"      (a),
       "r"      (b)
     : "cr0"
    );
```

In this example, apart from the registers listed in the *input* and *output* of the assembly statement, the `add.` instruction also affects the condition register field 0. Therefore, you must inform the compiler about this by adding `cr0` to the *clobbers*.

Example 4: The following example shows the usage of the memory clobber.

```
asm volatile ("  dcbz 0, %0  \n"
             : "=r"(b)
             :
             : "memory"
            );
```

In this example, the instruction `dcbz` clears a cache block, and might have changed the variables in the memory location. There is no way for the compiler to know which variables have been changed. Therefore, the compiler assumes that all data might be aliased with the memory changed by that instruction.

As a result, everything that is needed must be reloaded from memory after the completion of the assembly statement. The memory clobber ensures program correctness at the expense of program performance, because the compiler might reload data that had nothing to do with the assembly statement.

Example 5: The following example shows the usage of the `=` modifier and the `r` constraint.

```

int a ;
int b = 100 ;
int c = 200 ;
asm("  add %0, %1, %2"
    : "=r"    (a)
    : "r"     (b),
      "r"     (c)
    );

```

The add instruction adds the contents of two general purpose registers. The %0, %1, and %2 operands are substituted by the C expressions in the output/input operand fields.

The output operand uses the = modifier to indicate that a modifiable operand is required; it uses the r constraint to indicate that a general purpose register is required. Likewise, the r constraint in the input operands indicates that general purpose registers are required. Within these restrictions, the compiler is free to choose any registers to substitute for %0, %1, and %2.

Note: If the compiler chooses r0 for the second operand, the add instruction uses the literal value 0 and yields an unexpected result. Thus, to prevent the compiler from choosing r0 for the second operand, you can use the b constraint to denote the second operand.

Example 6: The following example shows the usage of the + modifier and the K constraint.

```

asm ("  addi %0,%0,%2"
    : "+r"    (a)
    : "r"     (a),
      "K"     (15)
    );

```

This assembly statement adds operand %0 and operand %2, and writes the result to operand %0. The output operand uses the + modifier to indicate that operand %0 can be read and written by the instruction. The K constraint indicates that the value loaded to operand %2 must be an unsigned 16-bit constant value.

Example 7: The following example shows the usage of the % modifier and the f constraint.

```

asm("  fadd %0, %1, %2"
    : "=f"    (c)
    : "%f"    (a),
      "f"     (b)
    );

```

This assembly statement adds operands a and b, and writes the result to operand c. The % modifier indicates that operands a and b can be switched if the compiler can generate better code in doing so. Each operand has the f constraint, which indicates that a floating point register is required.

Example 8: The following example shows the usage of the b constraint.

```

char res[8]={'a','b','c','d','e','f','g','h'};
char a='y';
int index=7;

asm ("  stbx %0,%1,%2    \n"    \
    :

```

```

:   "r"   (a),
   "b"   (index),
   "r"   (res)
);

```

In this example, the `b` constraint instructs the compiler to choose a general register other than `r0` for the input operand `%1`. The result string of this program is `abcdefgy`. However, if you use the `r` constraint and the compiler chooses `r0` for `%1`, this instruction produces an incorrect result string `ybcdefgh`. For instructions that treat the designation of `r0` specially, it is therefore important to denote the input operands with the `b` constraint.

Example 9: The following example shows the usage of the `m` constraint.

```

asm ("   stb %1,%0      \n"      \
:   "=m"   (res)      \
:   "r"   (a)
);

```

In this example, the syntax of the instruction `stb` is `stb RS,D(RA)`, where `D` is a displacement and `R` is a register. `D+RA` forms an effective address, which is calculated from `D(RA)`. By using constraint `m`, you do not need to manually construct effective addresses by specifying the register and displacement separately.

You can use a single constraint `m` or `o` to refer to the two operands in the instruction, regardless of what the correct offset should be and whether it is an offset off the stack or off the TOC (Table of Contents). This allows the compiler to choose the right register (`r1` for an automatic variable, for instance) and apply the right displacement automatically.

Chapter 9. Functions

In the context of programming languages, the term *function* means an assemblage of statements used for computing an output value. The word is used less strictly than in mathematics, where it means a set relating input variables *uniquely* to output variables. Functions in C or C++ programs might not produce consistent outputs for all inputs, might not produce output at all, or might have side effects. Functions can be understood as user-defined operations, in which the parameters of the parameter list, if any, are the operands.

Function declarations and definitions

The distinction between a function *declaration* and function *definition* is similar to that of a data declaration and definition. The declaration establishes the names and characteristics of a function but does not allocate storage for it, while the *definition* specifies the body for a function, associates an identifier with the function, and allocates storage for it. Thus, the identifiers declared in this example:

```
float square(float x);
```

do not allocate storage.

The *function definition* contains a function declaration and the body of a function. The body is a block of statements that perform the work of the function. The identifiers declared in this example allocate storage; they are both declarations and definitions.

```
float square(float x)
{ return x*x; }
```

A function can be declared several times in a program, but all declarations for a given function must be compatible; that is, the return type is the same and the parameters have the same type. However, a function can only have one definition. Declarations are typically placed in header files, while definitions appear in source files.

Function declarations

A function identifier preceded by its return type and followed by its parameter list is called a *function declaration* or *function prototype*. The prototype informs the compiler of the format and existence of a function prior to its use. The compiler checks for mismatches between the parameters of a function call and those in the function declaration. The compiler also uses the declaration for argument type checking and argument conversions.

C++ Implicit declaration of functions is not allowed: you must explicitly declare every function before you can call it. **C++**

C If a function declaration is not visible at the point at which a call to the function is made, the compiler assumes an implicit declaration of extern int func(); However, for conformance to C99, you should explicitly prototype every function before making a call to it. **C**

The elements of a declaration for a function are as follows:

- “Function storage class specifiers” on page 254, which specify linkage

- “Function return type specifiers” on page 261, which specify the data type of a value to be returned
- “Function specifiers” on page 255, which specify additional properties for functions
- “Function declarators” on page 262, which include function identifiers as well as lists of parameters

All function declarations have the form:

Function declaration syntax

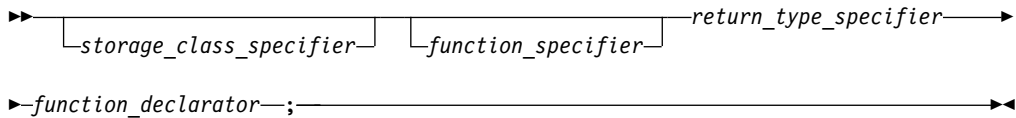

► C++11

Note: When *function_declarator* incorporates a trailing return type, *return_type_specifier* must be `auto`. For more information about trailing return type, see “Trailing return type (C++11)” on page 266.

► C++11 ◀

► IBM In addition, for compatibility with GNU C and C++, XL C/C++ allows you to use *attributes* to modify the properties of functions. They are described in “Function attributes (IBM extension)” on page 268.

Function definitions

The elements of a function definition are as follows:

- “Function storage class specifiers” on page 254, which specify linkage
- “Function return type specifiers” on page 261, which specify the data type of a value to be returned
- “Function specifiers” on page 255, which specify additional properties for functions
- “Function declarators” on page 262, which include function identifiers as well as lists of parameters
- The *function body*, which is a braces-enclosed series of statements representing the actions that the function performs
- ► C++ Constructor-initializers, which are used only in constructor functions declared in classes; they are described in “Constructors” on page 386.
- Try blocks, which are used in class functions; they are described in “try blocks” on page 463. ► C++ ◀

► IBM In addition, for compatibility with GNU C and C++, XL C/C++ allows you to use *attributes* to modify the properties of functions. They are described in “Function attributes (IBM extension)” on page 268. ► IBM ◀

Function definitions take the following form:

Function definition syntax (C only)

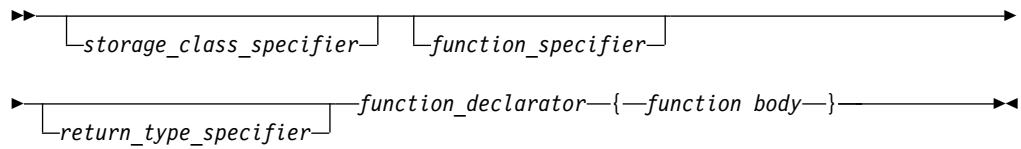

Function definition syntax (C++ only)

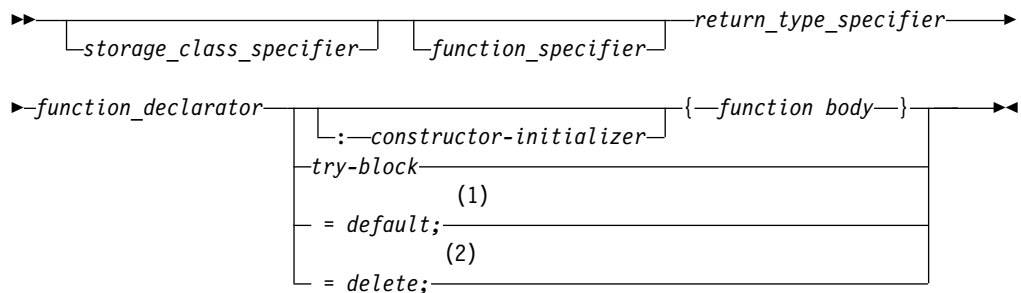

Notes:

- 1 This syntax is valid only in the C++11 standard.
- 2 This syntax is valid only in the C++11 standard.

> C++11

Note: When *function_declarator* incorporates a trailing return type, *return_type_specifier* must be `auto`. For more information about trailing return type, see “Trailing return type (C++11)” on page 266.

C++11 <

Explicitly defaulted functions

Note: IBM supports selected features of C++11, known as C++0x before its ratification. IBM will continue to develop and implement the features of this standard. The implementation of the language level is based on IBM's interpretation of the standard. Until IBM's implementation of all the C++11 features is complete, including the support of a new C++11 standard library, the implementation might change from release to release. IBM makes no attempt to maintain compatibility, in source, binary, or listings and other compiler interfaces, with earlier releases of IBM's implementation of the new C++11 features.

Explicitly defaulted function declaration is a new form of function declaration that is introduced into the C++11 standard. You can append the `=default;` specifier to the end of a function declaration to declare that function as an explicitly defaulted function. The compiler generates the default implementations for explicitly defaulted functions, which are more efficient than manually programmed function implementations. A function that is explicitly defaulted must be a special member function and has no default arguments. Explicitly defaulted functions can save your effort of defining those functions manually.

You can declare both inline and out-of-line explicitly defaulted functions. For example:

```

class A{
public:
    A() = default;           // Inline explicitly defaulted constructor definition
    A(const A&);
    ~A() = default;        // Inline explicitly defaulted destructor definition
};

A::A(const A&) = default; // Out-of-line explicitly defaulted constructor definition

```

You can declare a function as an explicitly defaulted function only if the function is a special member function and has no default arguments. For example:

```

class B {
public:
    int func() = default; // Error, func is not a special member function.
    B(int, int) = default; // Error, constructor B(int, int) is not
                          // a special member function.
    B(int=0) = default;   // Error, constructor B(int=0) has a default argument.
};

```

The explicitly defaulted function declarations enable more opportunities in optimization, because the compiler might treat explicitly defaulted functions as trivial.

Related reference:

Deleted functions (C++11)

Chapter 15, “Special member functions (C++ only),” on page 385

Deleted functions

Note: IBM supports selected features of C++11, known as C++0x before its ratification. IBM will continue to develop and implement the features of this standard. The implementation of the language level is based on IBM's interpretation of the standard. Until IBM's implementation of all the C++11 features is complete, including the support of a new C++11 standard library, the implementation might change from release to release. IBM makes no attempt to maintain compatibility, in source, binary, or listings and other compiler interfaces, with earlier releases of IBM's implementation of the new C++11 features.

Deleted function declaration is a new form of function declaration that is introduced into the C++11 standard. To declare a function as a deleted function, you can append the `=delete;` specifier to the end of that function declaration. The compiler disables the usage of a deleted function.

You can declare an implicitly defined function as a deleted function if you want to prevent its usage. For example, you can declare the implicitly defined copy assignment operator and copy constructor of a class as deleted functions to prevent object copy of that class.

```

class A{
public:
    A(int x) : m(x) {}
    A& operator = (const A &) = delete; // Declare the copy assignment operator
                                        // as a deleted function.
    A(const A&) = delete;                // Declare the copy constructor
                                        // as a deleted function.

private:
    int m;
};

int main(){

```

```

A a1(1), a2(2), a3(3);
a1 = a2; // Error, the usage of the copy assignment operator is disabled.
a3 = A(a2); // Error, the usage of the copy constructor is disabled.
}

```

You can also prevent problematic conversions by declaring the undesirable conversion constructors and operators as deleted functions. The following example shows how to prevent undesirable conversions from `double` to a class type.

```

class B{
public:
    B(int){}
    B(double) = delete; // Declare the conversion constructor as a deleted function
};

int main(){
    B b1(1);
    B b2(100.1); // Error, conversion from double to class B is disabled.
}

```

A deleted function is implicitly inline. A deleted definition of a function must be the first declaration of the function. For example:

```

class C {
public:
    C();
};

C::C() = delete; // Error, the deleted definition of function C must be
                // the first declaration of the function.

```

Related reference:

Explicitly defaulted functions (C++11)

Examples of function declarations

The following code fragments show several function declarations (or *prototypes*). The first declares a function `f` that takes two integer arguments and has a return type of `void`:

```
void f(int, int);
```

This fragment declares a pointer `p1` to a function that takes a pointer to a constant character and returns an integer:

```
int (*p1) (const char*);
```

The following code fragment declares a function `f1` that takes an integer argument, and returns a pointer to a function that takes an integer argument and returns an integer:

```
int (*f1(int)) (int);
```

Alternatively, a `typedef` can be used for the complicated return type of function `f1`:

```
typedef int f1_return_type(int);
f1_return_type* f1(int);
```

The following declaration is of an external function `f2` that takes a constant integer as its first argument, can have a variable number and variable types of other arguments, and returns type `int`.

```
extern int f2(const int, ...);
```

 Function `f4` takes no arguments, has return type `void`, and can throw class objects of types `X` and `Y`.

```

class X;
class Y;

// ...

void f4() throw(X,Y);

```

C++ <

Examples of function definitions

The following example is a definition of the function `sum`:

```

int sum(int x,int y)
{
    return(x + y);
}

```

The function `sum` has external linkage, returns an object that has type `int`, and has two parameters of type `int` declared as `x` and `y`. The function body contains a single statement that returns the sum of `x` and `y`.

The following function `set_date` declares a pointer to a structure of type `date` as a parameter. `date_ptr` has the storage class specifier `register`.

```

void set_date(register struct date *date_ptr)
{
    date_ptr->mon = 12;
    date_ptr->day = 25;
    date_ptr->year = 87;
}

```

Compatible functions (C only)

For two function types to be compatible, they must meet the following requirements:

- They must agree in the number of parameters (and use of ellipsis).
- They must have compatible return types.
- The corresponding parameters must be compatible with the type that results from the application of the default argument promotions.

The composite type of two compatible function types is determined as follows:

- If one of the function types has a parameter type list, the composite type is a function prototype with the same parameter type list.
- If both function types have parameter type lists, the composite type of each parameter is determined as follows:
 - The composite of parameters of different rank is the type that results from the application of the default argument promotions.
 - The composite of parameters with array or function type is the adjusted type.
 - The composite of parameters with qualified type is the unqualified version of the declared type.

For example, for the following two function declarations:

```

int f(int (*)(), double (*)[3]);
int f(int (*)(char *), double (*)[]);

```

The resulting composite type would be:

```

int f(int (*)(char *), double (*)[3]);

```

If the function declarator is not part of the function declaration, the parameters may have incomplete type. The parameters may also specify variable length array types by using the [*] notation in their sequences of declarator specifiers. The following are examples of compatible function prototype declarators:

```
int myMin(int n, int m, int a[n][m]);
int myMin(int n, int m, int a[*][*]);
int myMin(int n, int m, int a[ ][*]);
int myMin(int n, int m, int a[ ][m]);
```

Related reference:

Compatible and composite types

Multiple function declarations (C++ only)

All function declarations for a particular function must have the same number and type of parameters, and must have the same return type.

These return and parameter types are part of the function type, although the default arguments and exception specifications are not.

If a previous declaration of an object or function is visible in an enclosing scope, the identifier has the same linkage as the first declaration. However, a variable or function that has no linkage and later declared with a linkage specifier will have the linkage you have specified.

For the purposes of argument matching, ellipsis and linkage keywords are considered a part of the function type. They must be used consistently in all declarations of a function. If the only difference between the parameter types in two declarations is in the use of typedef names or unspecified argument array bounds, the declarations are the same. A `const` or `volatile` type qualifier is also part of the function type, but can only be part of a declaration or definition of a nonstatic member function.

If two function declarations match in both return type and parameter lists, then the second declaration is treated as redeclaration of the first. The following example declares the same function:

```
int foo(const string &bar);
int foo(const string &);
```

Declaring two functions differing only in return type is not valid function overloading, and is flagged as a compile-time error. For example:



```
void f();
int f();      // error, two definitions differ only in
              // return type

int g()
{
    return f();
}
```

Related reference:

“Overloading functions” on page 305

Function storage class specifiers

For a function, the storage class specifier determines the linkage of the function. By default, function definitions have external linkage, and can be called by functions defined in other files.  An exception is inline functions, which are treated by default as having internal linkage; see “Linkage of inline functions” on page 257 for more information. 



A storage class specifier may be used in both function declarations and definitions. The only storage class options for functions are:

- `static`
- `extern`

The static storage class specifier

A function declared with the `static` storage class specifier has internal linkage, which means that it may be called only within the translation unit in which it is defined.

The `static` storage class specifier can be used in a function declaration only if it is at file scope. You cannot declare functions within a block as `static`.

 This use of `static` is deprecated in C++. Instead, place the function in the unnamed namespace. 

Related reference:

“Internal linkage” on page 11

Chapter 10, “Namespaces (C++ only),” on page 293

The extern storage class specifier

A function that is declared with the `extern` storage class specifier has external linkage, which means that it can be called from other translation units. The keyword `extern` is optional; if you do not specify a storage class specifier, the function is assumed to have external linkage.

 An `extern` declaration cannot appear in class scope. You can use the `extern` keyword with arguments that specify the type of linkage.

extern function storage class specifier syntax

▶▶—`extern`—“—*linkage_specification*—”————▶▶

where *linkage_specification* can be any of the following:

- `C`
- `C++`

The following fragments illustrate the use of `extern "C"` :

```
extern "C" int cf();           //declare function cf to have C linkage

extern "C" int (*c_fp)();    //declare a pointer to a function,
                             // called c_fp, which has C linkage

extern "C" {
    typedef void(*cfp_T)(); //create a type pointer to function with C
                             // linkage
```



```

void cfn();           //create a function with C linkage
void (*cfn)();       //create a pointer to a function, with C
                    // linkage
}

```

Linkage compatibility affects all C library functions that accept a user function pointer as a parameter, such as `qsort`. Use the `extern "C"` linkage specification to ensure that the declared linkages are the same. The following example fragment uses `extern "C"` with `qsort`.

```

#include <stdlib.h>

// function to compare table elements
extern "C" int TableCmp(const void *, const void *); // C linkage
extern void * GenTable();                          // C++ linkage

int main() {
    void *table;

    table = GenTable();           // generate table
    qsort(table, 100, 15, TableCmp); // sort table, using TableCmp
                                    // and C library routine qsort();
}

```

While the C++ language supports overloading, other languages do not. The implications of this are:

- You can overload a function as long as it has C++ (default) linkage. Therefore, XL C++ allows the following series of statements:

```

int func(int);           // function with C++ linkage
int func(char);         // overloaded function with C++ linkage

```

By contrast, you cannot overload a function that has non-C++ linkage:

```

extern "FORTRAN"{int func(int);}
extern "FORTRAN"{int func(int,int);} // not allowed
//compiler will issue an error message

```

- Only one non-C++-linkage function can have the same name as overloaded functions. For example:

```

int func(char);
int func(int);
extern "FORTRAN"{int func(int,int);}

```

However, the non-C++-linkage function cannot have the same parameters as any of the C++ functions with the same name:

```

int func(char); // first function with C++ linkage
int func(int, int); // second function with C++ linkage
extern "FORTRAN"{int func(int,int);} // not allowed since the parameter
// list is the same as the one for
// the second function with C++ linkage
// compiler will issue an error message

```

C++ ◀

Related reference:

“External linkage” on page 12

“Class scope (C++ only)” on page 8

Chapter 10, “Namespaces (C++ only),” on page 293

Function specifiers

The available function specifiers for function definitions are:

- **C++11** `constexpr`, which can be used to declare `constexpr` functions and `constexpr` constructors, and is described in “The `constexpr` specifier (C++11)” on page 96. **C++11**
- `inline`, which instructs the compiler to expand a function definition at the point of a function call.
- **C++** `explicit`, which can only be used for member functions of classes, and is described in “Explicit conversion constructors” on page 403. **C++**
- **C11** `_Noreturn`, which indicates that a function does not return to its caller. **C11**
- **C++** `virtual`, which can only be used for member functions of classes, and is described in “Virtual functions” on page 377. **C++**

The inline function specifier

An inline function is one for which the compiler copies the code from the function definition directly into the code of the calling function rather than creating a separate set of instructions in memory. Instead of transferring control to and from the function code segment, a modified copy of the function body may be substituted directly for the function call. In this way, the performance overhead of a function call is avoided. Using the `inline` specifier is only a suggestion to the compiler that an inline expansion can be performed; the compiler is free to ignore the suggestion.

C Any function, with the exception of `main`, can be declared or defined as inline with the `inline` function specifier. Static local variables are not allowed to be defined within the body of an inline function. **C**

C++ C++ functions implemented inside of a class declaration are automatically defined inline. Regular C++ functions and member functions declared outside of a class declaration, with the exception of `main`, can be declared or defined as inline with the `inline` function specifier. Static locals and string literals defined within the body of an inline function are treated as the same object across translation units; see “Linkage of inline functions” on page 257 for details.

C++

The following code fragment shows an inline function definition:

```
inline int add(int i, int j) { return i + j; }
```

The use of the `inline` specifier does not change the meaning of the function. However, the inline expansion of a function may not preserve the order of evaluation of the actual arguments.

The most efficient way to code an inline function is to place the inline function definition in a header file, and then include the header in any file containing a call to the function which you would like to inline.

Note: The `inline` specifier is represented by the following keywords:

- **C** The `inline` keyword is recognized under compilation with `xc` or `c99`, or with the `-qlanglvl=stdc99` or `-qlanglvl=extc99` options or `-qkeyword=inline`. The `__inline__` (or `__inline`) keyword is recognized at all language levels; however, see “Linkage of inline functions” on page 257 below for the semantics of this keyword.
- **C++** The `inline`, `__inline`, and `__inline__` keywords are recognized at all language levels.

Linkage of inline functions

C

In C, inline functions are treated by default as having *static* linkage; that is, they are only visible within a single translation unit. Therefore, in the following example, even though function `foo` is defined in exactly the same way, `foo` in file `a.c` and `foo` in file `b.c` are treated as separate functions: two function bodies are generated, and assigned two different addresses in memory:

```
// a.c

#include <stdio.h>

inline int foo(){
    return 3;
}

void g() {
    printf("foo called from g: return value = %d, address = %p\n", foo(), &foo);
}

// b.c

#include <stdio.h>

inline int foo(){
    return 3;
}

void g();

int main() {
    printf("foo called from main: return value = %d, address = %p\n", foo(), &foo);
    g();
}
```

The output from the compiled program is:

```
foo called from main: return value = 3, address = 0x10000580
foo called from g: return value = 3, address = 0x10000500
```

Since inline functions are treated as having internal linkage, an inline function definition can co-exist with a regular, external definition of a function with the same name in another translation unit. However, when you call the function from the file containing the inline definition, the compiler may choose *either* the inline version defined in the same file *or* the external version defined in another file for the call; your program should not rely on the inline version being called. In the following example, the call to `foo` from function `g` could return either 6 or 3:

```
// a.c

#include <stdio.h>

inline int foo(){
    return 6;
}

void g() {
    printf("foo called from g: return value = %d\n", foo());
}

// b.c
```

```

#include <stdio.h>

int foo(){
    return 3;
}

void g();

int main() {
    printf("foo called from main: return value = %d\n", foo());
    g();
}

```

Similarly, if you define a function as `extern inline`, or redeclare an `inline` function as `extern`, the function simply becomes a regular, external function and is not inlined.

IBM If you specify the `__inline__` keyword, with the trailing underscores, the compiler uses the GNU C semantics for inline functions. In contrast to the C99 semantics, a function defined as `__inline__` provides an external definition only; a function defined as `static __inline__` provides an inline definition with internal linkage (as in C99); and a function defined as `extern __inline__`, when compiled with optimization enabled, allows the co-existence of an inline and external definition of the same function. For more information on the GNU C implementation of inline functions, see the GCC information, available at <http://gcc.gnu.org/onlinedocs/>. **IBM**

C

C++ You must define an inline function in exactly the same way in each translation unit in which the function is used or called. Furthermore, if a function is defined as `inline`, but never used or called within the same translation unit, it is discarded by the compiler (unless you compile with the `-qkeepinlines` option).

Nevertheless, in C++, inline functions are treated by default as having *external* linkage, meaning that the program behaves as if there is only one copy of the function. The function will have the same address in all translation units and each translation unit will share any static locals and string literals. Therefore, compiling the previous example gives the following output:

```

foo called from main: return value = 3, address = 0x10000580
foo called from g: return value = 3, address = 0x10000580

```

Redefining an inline function with the same name but with a different function body is illegal; however, the compiler does not flag this as an error, but simply generates a function body for the version defined in the first file entered on the compilation command line, and discards the others. Therefore, the following example, in which inline function `foo` is defined differently in two different files, may not produce the expected results:

```

// a.C

#include <stdio.h>

inline int foo(){
    return 6;
}

void g() {

```

```

    printf("foo called from g: return value = %d, address = %p\n", foo(), &foo);
}

// b.C

#include <stdio.h>

inline int foo(){
    return 3;
}

void g();

int main() {
    printf("foo called from main: return value = %d, address = %p\n", foo(), &foo);
    g();
}

```

When compiled with the command `xlc++ a.C b.C`, the output is:

```

foo called from main: return value = 6, address = 0x10001640
foo called from g: return value = 6, address = 0x10001640

```

The call to `foo` from `main` does not use the inline definition provided in `b.C`, but rather calls `foo` as a regular external function defined in `a.C`. It is your responsibility to ensure that inline function definitions with the same name match exactly across translation units, to avoid unexpected results.

Because inline functions are treated as having external linkage, any static local variables or string literals that are defined within the body of an inline function are treated as the same object across translation units. The following example demonstrates this:

```

// a.C

#include <stdio.h>

inline int foo(){
    static int x = 23;
    printf("address of x = %p\n", &x);
    x++;
    return x;
}

void g() {
    printf("foo called from g: return value = %d\n", foo());
}

// b.C

#include <stdio.h>

inline int foo()
{
    static int x=23;
    printf("address of x = %p\n", &x);
    x++;
    return x;
}

void g();

```

```

int main() {
    printf("foo called from main: return value = %d\n", foo());
    g();
}

```

The output of this program shows that `x` in both definitions of `foo` is indeed the same object:

```

address of x = 0x10011d5c
foo called from main: return value = 24
address of x = 0x10011d5c
foo called from g: return value = 25

```

If you want to ensure that each instance of function defined as inline is treated as a separate function, you can use the `static` specifier in the function definition in each translation unit, or compile with the `-qstaticinline` option. Note, however, that static inline functions are removed from name lookup during template instantiation, and are not found. 

Related reference:

“`always_inline`” on page 271

“`noinline`” on page 276

 See `-qlanglvl` in the XL C/C++ Compiler Reference

 See `-qkeyword` in the XL C/C++ Compiler Reference

“The static storage class specifier” on page 254

“The extern storage class specifier” on page 254

 See `-qstaticinline` in the XL C/C++ Compiler Reference

 See `-qkeepinlines` in the XL C/C++ Compiler Reference

The `_Noreturn` function specifier

The `_Noreturn` function specifier declares a function that does not return to its caller. When you declare a function with the specifier, the compiler can better optimize your code without regard to what happens if it returns. Any function, with the exception of `main`, can be declared or defined with the `_Noreturn` function specifier.

When `_Noreturn` is enabled, the `__IBMC_NORETURN` macro is defined as 1.

Include the standard header file `stdnoreturn.h` in your program when using the `_Noreturn` function specifier.



The following code fragment shows a function definition with the `_Noreturn` specifier:

```

_Noreturn void f (void) {
    abort();
}

```

Notes:

-  The `_Noreturn` keyword is recognized under compilation with the `-qlanglvl=extc89`, `-qlanglvl=extc99`, `-qlanglvl=extended`, or `-qlanglvl=extc1x` compiler option. 

- **C++** The `_Noreturn` keyword is recognized under compilation with the `-qlanglvl=extended`, `-qlanglvl=extended0x`, or `-qlanglvl=c1xnoreturn` compiler option. **C++**
- You can also define your own functions that never return by using the `_Noreturn` function specifier. However, any functions that are declared with `_Noreturn` must call one of the following functions. Otherwise, the functions will return the control to their respective caller.
 - `abort`
 - `exit`
 - `_Exit`
 - `longjmp`
 - `quick_exit`
 - `thrd_exit`

Function return type specifiers

The result of a function is called its *return value* and the data type of the return value is called the *return type*.

C++ Every function declaration and definition must specify a return type, whether or not it actually returns a value. **C++**

C If a function declaration does not specify a return type, the compiler assumes an implicit return type of `int`. However, for conformance to C99, you should specify a return type for every function declaration and definition, whether or not the function returns `int`. **C**

A function may be defined to return any type of value, except an array type or a function type; these exclusions must be handled by returning a pointer to the array or function. When a function does not return a value, `void` is the type specifier in the function declaration and definition.

A function cannot be declared as returning a data object having a `volatile` or `const` type, but it can return a pointer to a `volatile` or `const` object.

A function can have a return type that is a user-defined type. For example:

```
enum count {one, two, three};
enum count counter();
```

C The user-defined type may also be defined within the function declaration. **C** **C++** The user-defined type may not be defined within the function declaration. **C++**

```
enum count{one, two, three} counter(); // legal in C
enum count{one, two, three} counter(); // error in C++
```

C++ References can also be used as return types for functions. The reference returns the lvalue of the object to which it refers. **C++**

Related reference:

“Type specifiers” on page 61

Function return values

► **C** If a function is defined as having a return type of `void`, it should not return a value. **C** ► **C++** In C++, a function which is defined as having a return type of `void`, or is a constructor or destructor, *must* not return a value.

► **C++** ◀

► **C** If a function is defined as having a return type other than `void`, it should return a value. Under compilation for strict C99 conformance, a function defined with a return type *must* include an expression containing the value to be returned.

► **C** ◀

► **C++** A function defined with a return type *must* include an expression containing the value to be returned. **C++** ◀

When a function returns a value, the value is returned via a return statement to the caller of the function, after being implicitly converted to the return type of the function in which it is defined. The following code fragment shows a function definition including the return statement:

```
int add(int i, int j)
{
    return i + j; // return statement
}
```

The function `add()` can be called as shown in the following code fragment:

```
int a = 10,
    b = 20;
int answer = add(a, b); // answer is 30
```

In this example, the return statement initializes a variable of the returned type. The variable `answer` is initialized with the `int` value 30. The type of the returned expression is checked against the returned type. All standard and user-defined conversions are performed as necessary.

Each time a function is called, new copies of its variables with automatic storage are created. Because the storage for these automatic variables may be reused after the function has terminated, a pointer or reference to an automatic variable should not be returned. ► **C++** If a class object is returned, a temporary object may be created if the class has copy constructors or a destructor. **C++** ◀

Related reference:

- “The return statement” on page 235
- “Overloading assignments” on page 312
- “Overloading subscripting” on page 314
- “The auto storage class specifier” on page 55

Function declarators

Function declarators consist of the following elements:

- An *identifier*, or name
- “Parameter declarations” on page 263, which specify the parameters that can be passed to the function in a function call.
- ► **C++** Exception declarations, which include throw expressions; exception specifications are described in Chapter 17, “Exception handling (C++ only),” on page 463. **C++** ◀

- C++ A *cv_qualifier_seq*, which represents one or a combination of `const` and `volatile`, and can be used only in class member functions. For the details of constant and volatile member functions, see “Constant and volatile member functions” on page 338.
 C++

Function declarator syntax (C only)

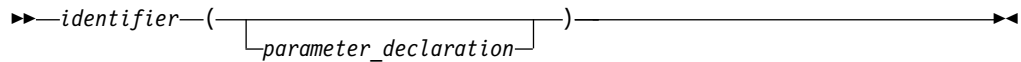

Function declarator syntax (C++ only)

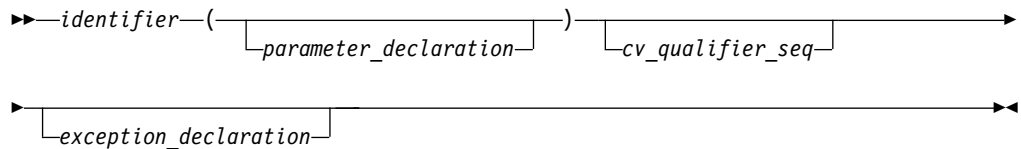

Note: More complex types might be formed by using the syntax of *direct_declarator* in place of *identifier*. For the details of *direct_declarator*, see “Overview of declarators” on page 111.

Related reference:

“Default arguments in C++ functions (C++ only)” on page 285
 Chapter 5, “Declarators,” on page 111

Parameter declarations

The function declarator includes the list of parameters that can be passed to the function when it is called by another function, or by itself.

- C++ In C++, the parameter list of a function is referred to as its *signature*. The name and signature of a function uniquely identify it. As the word itself suggests, the function signature is used by the compiler to distinguish among the different instances of overloaded functions.
 C++

Function parameter declaration syntax

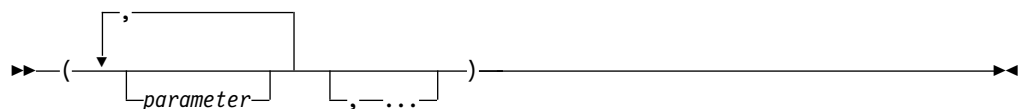

parameter

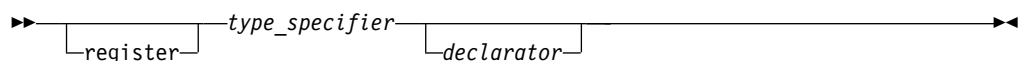

- C++ An empty argument list in a function declaration or definition indicates a function that takes no arguments. To explicitly indicate that a function does not take any arguments, you can declare the function in two ways: with an empty parameter list, or with the keyword `void`:

```
int f(void);
int f();
```

C++

An empty argument list in a function *definition* indicates that a function takes no arguments. An empty argument list in a function *declaration* indicates that a function may take any number or type of arguments. Thus,

```
int f()
{
...
}
```

indicates that function `f` takes no arguments. However,

```
int f();
```

simply indicates that the number and type of parameters is not known. To explicitly indicate that a function does not take any arguments, you can replace the argument list with the keyword `void`.

```
int f(void);
```

C

An ellipsis at the end of the parameter specifications is used to specify that a function has a variable number of parameters. The number of parameters is equal to, or greater than, the number of parameter specifications.

```
int f(int, ...);
```

C++

The comma before the ellipsis is optional. In addition, a parameter declaration is not required before the ellipsis.

C++

C

At least one parameter declaration, as well as a comma before the ellipsis, are both required in C.

C

Parameter types

In a function *declaration*, or prototype, the type of each parameter must be specified. In the function *definition*, the type of each parameter must also be specified. In the function *definition*, if the type of a parameter is not specified, it is assumed to be `int`.

A variable of a user-defined type may be declared in a parameter declaration, as in the following example, in which `x` is declared for the first time:

```
struct X { int i; };
void print(struct X x);
```

C

The user-defined type can also be defined within the parameter declaration. The user-defined type can not be defined within the parameter declaration.

```
void print(struct X { int i; } x); // legal in C
void print(struct X { int i; } x); // error in C++
```

Parameter names

In a function *definition*, each parameter must have an identifier. In a function *declaration*, or prototype, specifying an identifier is optional. Thus, the following example is legal in a function declaration:

```
int func(int, long);
```

► **C++** The following constraints apply to the use of parameter names in function declarations:

- Two parameters cannot have the same name within a single declaration.
- If a parameter name is the same as a name outside the function, the name outside the function is hidden and cannot be used in the parameter declaration.

In the following example, the third parameter name `intersects` is meant to have enumeration type `subway_line`, but this name is hidden by the name of the first parameter. The declaration of the function `subway()` causes a compile-time error, because `subway_line` is not a valid type name. The first parameter name `subway_line` hides the namespace scope enum type and cannot be used again in the third parameter.

```
enum subway_line {yonge, university, spadina, bloor};
int subway(char * subway_line, int stations, subway_line intersects);
```

◀ **C++**

Static array indices in function parameter declarations (C only)

Except in certain contexts, an unsubscripted array name (for example, `region` instead of `region[4]`) represents a pointer whose value is the address of the first element of the array, provided that the array has previously been declared. An array type in the parameter list of a function is also converted to the corresponding pointer type. Information about the size of the argument array is lost when the array is accessed from within the function body.

To preserve this information, which is useful for optimization, you may declare the index of the argument array using the `static` keyword. The constant expression specifies the minimum pointer size that can be used as an assumption for optimizations. This particular usage of the `static` keyword is highly prescribed. The keyword may only appear in the outermost array type derivation and only in function parameter declarations. If the caller of the function does not abide by these restrictions, the behavior is undefined.

Note: This feature is C99 specific.

The following examples show how the feature can be used.

```
void foo(int arr [static 10]);      /* arr points to the first of at least
                                  10 ints                               */
void foo(int arr [const 10]);     /* arr is a const pointer          */
void foo(int arr [static const i]); /* arr points to at least i ints;
                                  i is computed at run time.       */
void foo(int arr [const static i]); /* alternate syntax to previous example */
void foo(int arr [const]);        /* const pointer to int           */
```

Related reference:

“The static storage class specifier” on page 55

“Arrays” on page 120

“Array subscripting operator []” on page 190

“The void type” on page 66

“Type specifiers” on page 61

“Type qualifiers” on page 98

“Exception specifications” on page 476

Trailing return type (C++11)

Note: IBM supports selected features of C++11, known as C++0x before its ratification. IBM will continue to develop and implement the features of this standard. The implementation of the language level is based on IBM's interpretation of the standard. Until IBM's implementation of all the C++11 features is complete, including the support of a new C++11 standard library, the implementation might change from release to release. IBM makes no attempt to maintain compatibility, in source, binary, or listings and other compiler interfaces, with earlier releases of IBM's implementation of the new C++11 features.

The trailing return type feature removes a C++ limitation where the return type of a function template cannot be generalized if the return type depends on the types of the function arguments. For example, `a` and `b` are arguments of a function template `multiply(const A &a, const B &b)`, where `a` and `b` are of arbitrary types. Without the trailing return type feature, you cannot declare a return type for the `multiply` function template to generalize all the cases for `a*b`. With this feature, you can specify the return type after the function arguments. This resolves the scoping problem when the return type of a function template depends on the types of the function arguments.

Trailing return type syntax

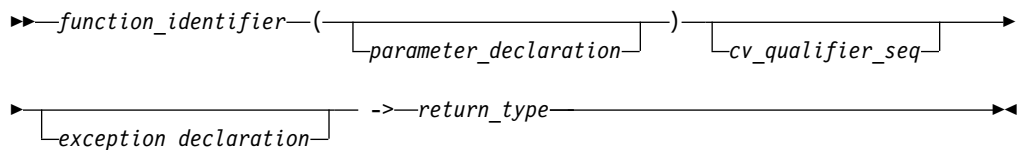

Notes:

- This syntax is not the one for a function declaration or definition. The auto placeholder occurs in the syntax for declarations and definitions where they specify *return_type_specifier*.
- As with function declarators without a trailing return type, this syntax might be used to declare a pointer or reference to function.
- More complex types might be formed by using the syntax of *direct_declarator* in place of *function_identifier*. For the details of *direct_declarator*, see "Overview of declarators" on page 111.

To use the trailing return type feature, declare a generic return type with the `auto` keyword before the function identifier, and specify the exact return type after the function identifier. For example, use the `decltype` keyword to specify the exact return type.

In the following example, the `auto` keyword is put before the function identifier `add`. The return type of `add` is `decltype(a + b)`, which depends on the types of the function arguments `a` and `b`.

```
// Trailing return type is used to represent
// a fully generic return type for a+b.
template <typename FirstType, typename SecondType>
auto add(FirstType a, SecondType b) -> decltype(a + b){
    return a + b;
}

int main(){
    // The first template argument is of the integer type, and
```

```

// the second template argument is of the character type.
add(1, 'A');

// Both the template arguments are of the integer type.
add(3, 5);
}

```

Notes:

- When a trailing return type is used, the placeholder return type must be auto. For example, the statement `auto *f()->char` results in a compile-time error, because `auto *` is not allowed as the placeholder return type.
- The auto type specifier can be used with a function declarator with a trailing return type. Otherwise, the auto type specifier is used in accordance to the auto type deduction feature. For more information about auto type deduction, see “The auto type specifier (C++11)” on page 89. Because a function declaration cannot have an initializer as required for auto type deduction, the auto type specifier cannot be used in a function declaration without a trailing return type. For declarations of pointers and references to functions, the auto type specifier can be used with either a corresponding trailing return type or an initializer. For details of pointers and references to functions, see “Pointers to functions” on page 287.
- The return type of a function cannot be any of the following types:
 - Function
 - Array
 - Incomplete class
- The return type of a function cannot define any of the following types:
 - struct
 - class
 - union
 - enum

However, the return type can be any of these types if the type is not defined in the function declaration.

In addition, this feature makes your program more compact and elegant in cases where functions have complicated return types. Without this feature, programs might be complicated and error prone. See the following example:

```

template <class A, class B> class K{
public:
    int i;
};

K<int, double> (*(*bar()))()() {
    return 0;
}

```

You can use the trailing return type feature to make the code compact. See the following example:

```

template <class A, class B> class K{
public:
    int i;
};

auto bar()->auto(*)()->K<int, double>(*)(){
    return 0;
}

```

This feature can also be used for member functions of classes. In the following example, the program is concise because the return type of the member function `bar` does not need to be qualified after using a trailing return type:

```
struct A{
    typedef int ret_type;
    auto bar() -> ret_type;
};

// ret_type is not qualified
auto A::bar() -> ret_type{
    return 0;
}
```

Another use of this feature is in writing perfect forwarding functions. That is, the forwarding function calls another function, and the return type of the forwarding function is the same as that of the called function. See the following example:

```
double number (int a){
    return double(a);
}

int number(double b){
    return int(b);
}

template <class A>
auto wrapper(A a) -> decltype(number(a)){
    return number(a);
}

int main(){
    // The return value is 1.000000.
    wrapper(1);

    // The return value is 1.
    wrapper(1.5);
}
```

In this example, the wrapper function and the number function have the same return type.

Related reference:

- “The auto type specifier (C++11)” on page 89
- “The `decltype(expression)` type specifier (C++11)” on page 90
- “C++11 compatibility” on page 519
- “Member functions” on page 337
- “Member functions of class templates” on page 422
- “Function templates” on page 424
- “Function declarations” on page 247
- “Function definitions” on page 248
- “Pointers to functions” on page 287

Function attributes (IBM extension)

Function attributes are extensions implemented to enhance the portability of programs developed with GNU C. Specifiable attributes for functions provide explicit ways to help the compiler optimize function calls and to instruct it to check more aspects of the code. Others provide additional functionality.

IBM XL C and XL C/C++ compilers implement a subset of the GNU C function attributes. For a particular function attribute that is not implemented, the compiler issues diagnostics and ignores the attribute specification.

A function attribute is specified with the keyword `__attribute__` followed by the attribute name and any additional arguments the attribute name requires. A function `__attribute__` specification is included in the declaration or definition of a function. The syntax takes the following forms:

Function attribute syntax: function definition (form 1)

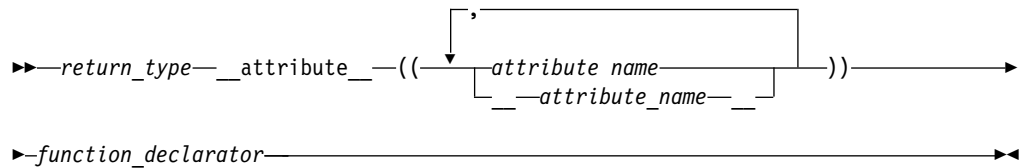

Function attribute syntax: function definition (form 2)

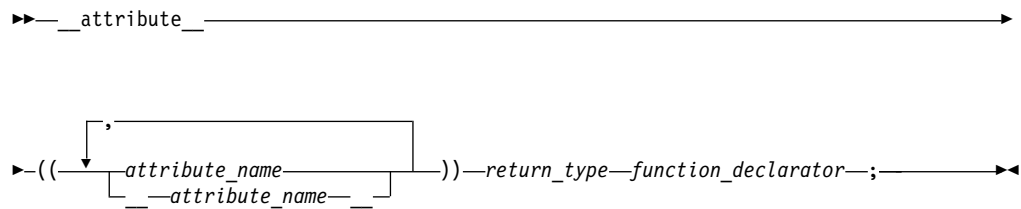

Function attribute syntax: function definition (form 3)

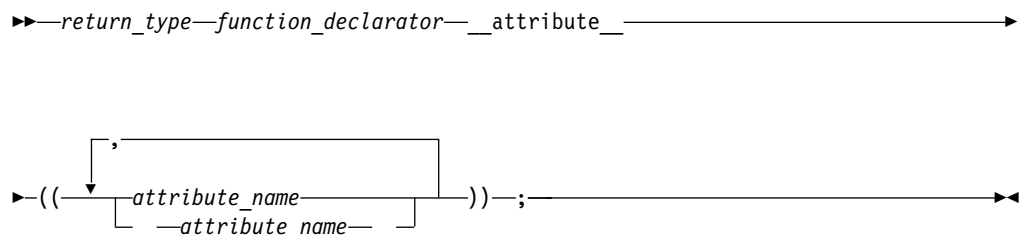

You can specify `attribute_name` with or without leading and trailing double underscore characters; however, using the double underscore characters reduces the likelihood of name conflicts with macros of the same name. These language features are collectively available when compiling in any of the extended language levels.

The following function declarations are all valid:

```
int __attribute__((attribute_name)) func(int i); //Form 1
__attribute__((attribute_name)) int func(int); //Form 2
int func() __attribute__((attribute_name)); //Form 3
```

C++ The attribute specification must follow any exception declaration that might present for the function. For example:

```
int func(int) throw(int) __attribute__((pure));
```

C++

The following function attributes are supported:

- "alias"
- "always_inline" on page 271
- "const" on page 272
- "format" on page 272
- "format_arg" on page 273
- "gnu_inline" on page 274
- "malloc" on page 275
- "noinline" on page 276
- "noreturn" on page 276
- "pure" on page 276
- "used" on page 277
- "weak" on page 277
- "weakref" on page 277
- "visibility" on page 278

Related reference:

"Variable attributes (IBM extension)" on page 140

alias

The alias function attribute causes the function declaration to appear in the object file as an alias for another symbol. This language feature provides a technique for coping with duplicate or cumbersome names.

alias function attribute syntax

► `__attribute__((alias(—"original_function_name"—))` ◀

└─ alias ─┘

└─ `__alias__` ─┘

► **C** The aliased function can be defined after the specification of its alias with this function attribute. C also allows an alias specification in the absence of a definition of the aliased function in the same compilation unit.

The following code declares func1 to be an alias for __func2:

```
void __func2(){ /* function body */ }
void func1() __attribute__((alias("__func2")));
```

C

► **C++** The *original_function_name* must be the mangled name.

The following code declares func1 to be an alias for __func2

```
extern "C" __func2(){ /* function body */ }
void func1() __attribute__((alias("__func2")));
```

C++





The compiler does not check for consistency between the declaration of `func1` and definition of `__func2`. Such consistency remains the responsibility of the programmer.

Related reference:

 See `#pragma weak` in the XL C/C++ Compiler Reference “The weak variable attribute” on page 144

always_inline

The `always_inline` function attribute instructs the compiler to inline a function. This function can be inlined when all of the following conditions are satisfied:

- The function is an inline function that satisfies any of the following conditions:
 - The function is specified with the `inline` or `__inline__` keyword.
 - The option `-qinline+<function_name>` is specified, where `function_name` is the name of the function to be inlined.
 -  The function is defined within a class declaration. 
- The function is not specified with the `noinline` or `__noinline__` attribute.
-  The optimization level is at **02** or higher. 
- The number of functions to be inlined does not exceed the limit of inline functions that can be supported by the compiler.

always_inline function attribute syntax

→ `__attribute__((always_inline | __always_inline__))` →

The `noinline` attribute takes precedence over the `always_inline` attribute. The `always_inline` attribute takes precedence over inlining compiler options only if inlining is enabled. The `always_inline` attribute is ignored if inlining is disabled.

 The compiler might not inline a virtual function even when the function is specified with the `always_inline` attribute. The compiler will not issue an informational message to indicate that a virtual function is not inlined.

When you specialize a function template that is specified with the `always_inline` attribute, this attribute is propagated to the template specification. If you apply the `always_inline` attribute to the template specification, the duplicate `always_inline` attribute is ignored. See the following example.

```
template<class T> inline __attribute__((always_inline)) T test() {
    return (T)0;
}

// The duplicate attribute "always_inline" is ignored.
template<> inline __attribute__((always_inline)) float test<float>() {
    return (float)0;
}
```



Related reference:

“The inline function specifier” on page 256
“noinline” on page 276

const

The `const` function attribute allows you to tell the compiler that the function can safely be called fewer times than indicated in the source code. The language feature provides you with an explicit way to help the compiler optimize code by indicating that the function does not examine any values except its arguments and has no effects except for its return value.

const function attribute syntax

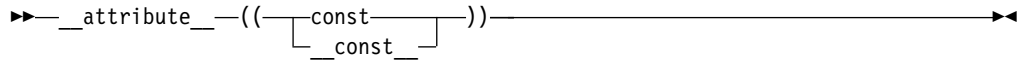
►► `__attribute__((const))` 

The following kinds of functions should not be declared `const`:

- A function with pointer arguments which examines the data pointed to.
- A function that calls a non-`const` function.

Note: GNU C has a non-attribute method that uses the `const` keyword to achieve the `const` function attribute, but the XL C/C++ compiler does not support this method.

Related reference:



See `-qisolated_call` in the XL C/C++ Compiler Reference

deprecated

With the `deprecated` function attribute, you can declare a function as deprecated.

deprecated function attribute syntax

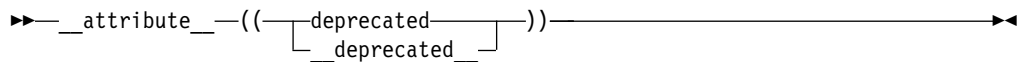
►► `__attribute__((deprecated))` 

If a function that is specified with the `deprecated` attribute is called, the compiler issues a warning message to indicate that the function is not recommended to be used. Warning messages are issued only for invocations but not declarations of deprecated functions. See the following example.

```
int func( ) __attribute__((deprecated));

int main( ){
    int i = func(); // warning: 'func' is deprecated
    int func();
    return i;
}

int func( ){
    return 1;
}
```

format

The `format` function attribute provides a way to identify user-defined functions that take format strings as arguments so that calls to these functions will be type-checked against a format string, similar to the way the compiler checks calls to the functions `printf`, `scanf`, `strftime`, and `strfmon` for errors.

format function attribute syntax

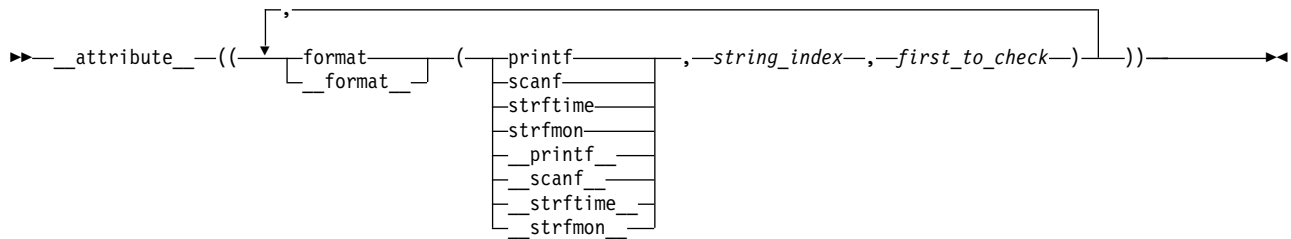

where

string_index

Is a constant integral expression that specifies which argument in the declaration of the user function is the format string argument. C++ In C++, the minimum value of *string_index* for nonstatic member functions is 2 because the first argument is an implicit this argument. This behavior is consistent with that of GNU C++. C++

first_to_check

Is a constant integral expression that specifies the first argument to check against the format string. If there are no arguments to check against the format string (that is, diagnostics should only be performed on the format string syntax and semantics), *first_to_check* should have a value of 0. For strftime-style formats, *first_to_check* is required to be 0.

It is possible to specify multiple format attributes on the same function, in which case, all apply.

```
void my_fn(const char* a, const char* b, ...)
    __attribute__((__format__(__printf__,1,0), __format__(__scanf__,2,3)));
```

It is also possible to diagnose the same string for different format styles. All styles are diagnosed.

```
void my_fn(const char* a, const char* b, ...)
    __attribute__((__format__(__printf__,2,3),
                  __format__(__strftime__,2,0),
                  __format__(__scanf__,2,3)));
```

format_arg

The `format_arg` function attribute provides a way to identify user-defined functions that modify format strings. Once the function is identified, calls to functions like `printf`, `scanf`, `strftime`, or `strfmon`, whose operands are a call to the user-defined function can be checked for errors.

format_arg function attribute syntax

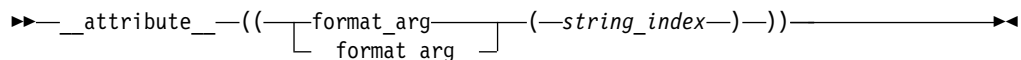

where *string_index* is a constant integral expression that specifies which argument is the format string argument, starting from 1. C++ For non-static member functions in C++, *string_index* starts from 2 because the first parameter is an implicit this parameter. C++

It is possible to specify multiple `format_arg` attributes on the same function, in which case, all apply.

```
extern char* my_dgettext(const char* my_format, const char* my_format2)
    __attribute__((__format_arg__(1))) __attribute__((__format_arg__(2)));

printf(my_dgettext("%", "%"));
//printf-style format diagnostics are performed on both "%" strings
```

gnu_inline

The `gnu_inline` attribute instructs the compiler to modify the inlining behavior of a function. When this function attribute is used, the compiler imitates the GNU legacy inlining extension to C.

This function attribute is only enabled if used in conjunction with an inline keyword (`__inline__`, `inline`, `__inline`, etc.).

gnu_inline function attribute syntax

```
▶▶—inline—__attribute__((—gnu_inline—))————▶▶
```

Note: The behavior of the `gnu_inline` function attribute is the same when used in conjunction with either the `inline` or `__inline__` keywords.

The semantics of the GNU legacy inlining extension to C are as follows:

C

extern gnu_inline:

```
extern inline __attribute__((gnu_inline)) func() {...};
```

This definition of `func` is used only for inlining. It is not compiled as a standalone function.

static gnu_inline:

```
static inline __attribute__((gnu_inline)) func() {...};
```

If the function is generated, it is generated with internal linkage.

plain gnu_inline:

```
inline __attribute__((gnu_inline)) func() {...};
```

The definition is used for inlining when possible. It is compiled as a standalone function (emitted as a strong definition) and emitted with external linkage.

C

C++

extern gnu_inline:

```
[extern] inline __attribute__((gnu_inline)) func() {...};
```

This definition of `func` is used only for inlining. It is not compiled as a standalone function. Note that member functions (including static ones and ones with no linkage) marked with function attribute `gnu_inline` has "extern" behavior.

static gnu_inline:

```
static inline __attribute__((gnu_inline)) func() {...};
```

If the function is generated, it is generated with internal linkage. Note that static behavior only applies to non-member static functions.

C++

The `gnu_inline` attribute can be specified inside double parentheses with keyword `__attribute__` in a function declaration. See the following example.

```
inline int func() __attribute__((gnu_inline));
```

As with other GCC function attributes, the double underscores on the attribute name are optional. The `gnu_inline` attribute should be used with a function that is also declared with the `inline` keyword.

malloc

With the function attribute `malloc`, you can instruct the compiler to treat a function as if any non-NULL pointer it returns cannot alias any other valid pointers. This type of function (such as `malloc` and `calloc`) has this property, hence the name of the attribute. As with all supported attributes, `malloc` will be accepted by the compiler without requiring any particular option or language level.

The `malloc` function attribute can be specified inside double parentheses via keyword `__attribute__` in a function declaration.

malloc function attribute syntax

```
►► __attribute__((malloc))
```

As with other GCC function attributes, the double underscores on the attribute name are optional.

Note:

- Do not use this function attribute unless you are sure that the pointer returned by a function points to unique storage. Otherwise, optimizations performed might lead to incorrect behavior at run time.
- If the function does not return a pointer or C++ reference return type but it is marked with the function attribute `malloc`, a warning is emitted, and the attribute is ignored.

Example

A simple case that should be optimized when attribute `malloc` is used:

```
#include <stdlib.h>
#include <stdio.h>
int a;
void* my_malloc(int size) __attribute__((malloc))
{
    void* p = malloc(size);
    if (!p) {
        printf("my_malloc: out of memory!\n");
        exit(1);
    }
    return p;
}
int main() {
    int* x = &a;
    int* p = (int*) my_malloc(sizeof(int));
```

```

*x = 0;
*p = 1;
if (*x) printf("This printf statement to be detected as unreachable
              and discarded during compilation process\n");
return 0;
}

```

noinline

The `noinline` function attribute prevents the function to which it is applied from being inlined, regardless of whether the function is declared `inline` or `non-inline`. The attribute takes precedence over inlining compiler options, the `inline` keyword, and the `always_inline` function attribute.

noinline function attribute syntax

```

▶▶ __attribute__((noinline))
                    [__noinline__]

```

Other than preventing inlining, the attribute does not remove the semantics of inline functions.

noreturn

The `noreturn` function attribute allows you to indicate to the compiler that the function will not return the control to its caller. The language feature provides the programmer with another explicit way to help the compiler optimize code and to reduce false warnings for uninitialized variables.

The return type of the function should be `void`.

noreturn function attribute syntax

```

▶▶ __attribute__((noreturn))
                    [__noreturn__]

```

Registers saved by the calling function may not necessarily be restored before calling the nonreturning function.

Related reference:



See `#pragma leaves` in the XL C/C++ Compiler Reference

pure

The `pure` function attribute allows you to declare a function that can be called fewer times than what is literally in the source code. Declaring a function with the attribute `pure` indicates that the function has no effect except a return value that depends only on the parameters, global variables, or both.

pure function attribute syntax

```

▶▶ __attribute__((pure))
                    [__pure__]

```

Related reference:



See `-qisolated_call` in the XL C/C++ Compiler Reference

used

When a function is referenced only in inline assembly, you can use the `used` function attribute to instruct the compiler to emit the code for the function even if it appears that the function is not referenced.

The `used` function attribute can be specified inside double parentheses via keyword `__attribute__` in a function declaration, for example, `int foo() __attribute__((__used__))`; As with other GCC function attributes, the double underscores on the attribute name are optional.

used function attribute syntax

```
▶▶ __attribute__((used)))
```

If the function attribute `gnu_inline` is specified in such a way that the function is discarded, and is specified together with the function attribute `used`, the `gnu_inline` attribute wins, and the function definition is discarded.

weak

The `weak` function attribute causes the symbol resulting from the function declaration to appear in the object file as a weak symbol, rather than a global one. The language feature provides the programmer writing library functions with a way to allow function definitions in user code to override the library function declaration without causing duplicate name errors.

weak function attribute syntax

```
▶▶ __attribute__((weak)))
```

Related reference:

 See `#pragma weak` in the XL C/C++ Compiler Reference “alias” on page 270

weakref

`weakref` is an attribute attached to function declarations which must specify a target name. The target name might also be specified through the attribute `alias` in any declaration of the function.

References to the `weakref` function are converted into references of the target name. If the target name is not defined in the current translation unit and it is not referenced directly or otherwise in a way that requires a definition of the target, for example if it is only referenced by using `weakref` functions, the reference is weak. In the presence of a definition of the target in the current translation unit, references to a `weakref` function resolve directly to said definition. The `weakref` attribute does not otherwise affect definitions of the target. A `weakref` function must have internal linkage.

The `weakref` attribute, as with other GCC attributes, can be expressed in a pre-fix or post-fix syntax:

pre-fix syntax

```
static __attribute__((weakref("bar"))) void foo(void);
```

post-fix syntax

```
static void foo(void) __attribute__((weakref("bar")));
```

Functions with `weakref` or `alias` attributes may refer to other such functions. The name referred to is that of the last, i.e., non-`weakref` and non-`alias` target.

Rules

If a `weakref` function is declared without the keyword `static`, an error message is emitted .

The target name specified in the `weakref` function declaration cannot directly or indirectly point to itself.

Using the `weakref` attribute without providing a target name is not recommended.

If a body is provided in a `weakref` function declaration with a pre-fix syntax, the attribute is ignored. A warning message reporting this situation will be emitted.

On AIX, when using `weakref` function with the option `-qnoweaksymbol`, the compiler issues a severe error message reporting a conflict between the option and the attribute.

Examples

The following examples illustrates various declarations of `weakref` functions:

```
static void foo() __attribute__((weakref("bar")));  
void foo() __attribute__((weakref("bar")));  
static void foo() __attribute__((weakref,alias("bar")));  
static void foo() __attribute__((alias("bar"),weakref));  
static void foo() __attribute__((alias("bar")));  
static void foo() __attribute__((weakref));  
static void foo() __attribute__((alias("bar")));  
void foo() __attribute__((weakref));  
static void foo() __attribute__((weakref));  
static void foo() __attribute__((alias("bar")));  
static void foo() __attribute__((weakref));  
void foo() __attribute__((alias("bar")));
```

Related reference:



See `#pragma weak` in the XL C/C++ Compiler Reference

visibility

The visibility function attributes describe whether and how a function defined in one module can be referenced or used in other modules. By using this feature, you can make a shared library smaller and decrease the possibility of symbol collision. For details, see *Using visibility attributes in the XL C/C++ Optimization and Programming Guide*.

visibility function attribute syntax

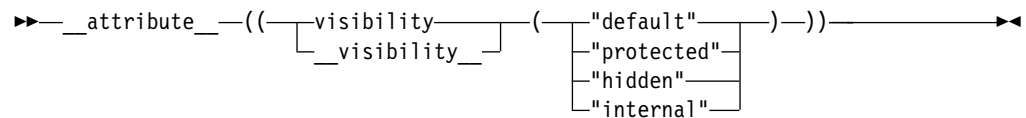

Example

In the following example, the visibility attribute of function `void f(int i, int j)` is hidden:

```
void __attribute__((visibility("hidden"))) f(int i, int j);
```

Related reference:

“External linkage” on page 12

“The visibility variable attribute” on page 144

“The visibility type attribute” on page 108

“The visibility namespace attribute (IBM extension)” on page 303

See Using visibility attributes in the XL C/C++ Optimization and Programming Guide

See `-qvisibility` in the XL C/C++ Compiler Reference

See `-qmksbobj` in the XL C/C++ Compiler Reference

See `-G` in the XL C/C++ Compiler Reference

See `#pragma GCC visibility push`, `#pragma GCC visibility pop` (IBM extension) in the XL C/C++ Compiler Reference

The main() function

When a program begins running, the system calls the function `main`, which marks the entry point of the program. By default, `main` has the storage class `extern`. Every program must have one function named `main`, and the following constraints apply:

- No other function in the program can be called `main`.
- `main` cannot be defined as `inline` or `static`.
- `main` cannot be called from within a program.
- The address of `main` cannot be taken.
- The `main` function cannot be overloaded.
- The `main` function cannot be declared with the `constexpr` specifier.

The function `main` can be defined with or without parameters, using any of the following forms:

```
int main (void){}
int main ( ){}
int main(int argc, char *argv[]){}
int main (int argc, char ** argv){}
```

Although any name can be given to these parameters, they are usually referred to as `argc` and `argv`. The first parameter, `argc` (argument count) is an integer that indicates how many arguments were entered on the command line when the program was started. The second parameter, `argv` (argument vector), is an array of

pointers to arrays of character objects. The array objects are null-terminated strings, representing the arguments that were entered on the command line when the program was started.

The first element of the array, `argv[0]`, is a pointer to the character array that contains the program name or invocation name of the program that is being run from the command line. `argv[1]` indicates the first argument passed to the program, `argv[2]` the second argument, and so on.

The following example program backward prints the arguments entered on a command line such that the last argument is printed first:

```
#include <stdio.h>
int main(int argc, char *argv[])
{
    while (--argc > 0)
        printf("%s ", argv[argc]);
    printf("\n");
}
```

Invoking this program from a command line:

```
backward string1 string2
```

gives the following output:

```
string2 string1
```

The arguments `argc` and `argv` would contain the following values at the start of the program:

Object	Value
<code>argc</code>	3
<code>argv[0]</code>	pointer to string "backward"
<code>argv[1]</code>	pointer to string "string1"
<code>argv[2]</code>	pointer to string "string2"
<code>argv[3]</code>	NULL

Related reference:

“The extern storage class specifier” on page 57

“The inline function specifier” on page 256

“The static storage class specifier” on page 55

“Function calls”

Function calls

After a function is declared and defined, it can be *called* from anywhere within the program: from within the `main` function, from another function, and even from itself. Calling the function involves specifying the function name, followed by the function call operator and any data values the function expects to receive. These values are the *arguments* for the parameters defined for the function. This process is called *passing arguments* to the function.

You can pass arguments to the called functions in three ways:

- “Pass by value” on page 281, which copies the *value* of an argument to the corresponding parameter in the called function;

- “Pass by pointer” on page 282, which passes a *pointer* argument to the corresponding parameter in the called function;
- **C++** “Pass by reference (C++ only)” on page 283, which passes the *reference* of an argument to the corresponding parameter in the called function. **C++**

C++ If a class has a destructor or a copy constructor that does more than a bitwise copy, passing a class object by value results in the construction of a temporary object that is actually passed by reference.

The compiler generates an error when a function argument is a class object and all of the following conditions are true:

- The class needs a copy constructor.
- The class does not have a user-defined copy constructor.
- A copy constructor cannot be generated for that class.

C++

C A function call is always an rvalue. **C**

C++ A function call belongs to one of the following value categories depending on the result type of the function:

- An lvalue if the result type is an lvalue reference type **C++11** or an rvalue reference to a function type **C++11**
- **C++11** An xvalue if the result type is an rvalue reference to an object type **C++11**
- A **C++11** (prvalue) **C++11** rvalue in other cases

C++

Related reference:

“Function argument conversions” on page 158

“Function call expressions” on page 167

“Constructors” on page 386

“Lvalues and rvalues” on page 159

“References (C++ only)” on page 123

Pass by value

When you use *pass-by-value*, the compiler copies the value of an argument in a calling function to a corresponding non-pointer or non-reference parameter in the called function definition. The parameter in the called function is initialized with the value of the passed argument. As long as the parameter has not been declared as constant, the value of the parameter can be changed, but the changes are only performed within the scope of the called function only; they have no effect on the value of the argument in the calling function.

In the following example, `main` passes `func` two values: 5 and 7. The function `func` receives copies of these values and accesses them by the identifiers `a` and `b`. The function `func` changes the value of `a`. When control passes back to `main`, the actual values of `x` and `y` are not changed.

```
/**
 ** This example illustrates calling a function by value
 **/

#include <stdio.h>
```

```

void func (int a, int b)
{
    a += b;
    printf("In func, a = %d    b = %d\n", a, b);
}

int main(void)
{
    int x = 5, y = 7;
    func(x, y);
    printf("In main, x = %d    y = %d\n", x, y);
    return 0;
}

```

The output of the program is:

```

In func, a = 12 b = 7
In main, x = 5 y = 7

```

Pass by pointer

Pass-by-pointer means to pass a pointer argument in the calling function to the corresponding formal parameter of the called function. The called function can modify the value of the variable to which the pointer argument points.

The following example shows how arguments are passed by pointer:

```

#include <stdio.h>

void swapnum(int *i, int *j) {
    int temp = *i;
    *i = *j;
    *j = temp;
}

int main(void) {
    int a = 10;
    int b = 20;

    swapnum(&a, &b);
    printf("A is %d and B is %d\n", a, b);
    return 0;
}

```

When the function `swapnum()` is called, the values of the variables `a` and `b` are exchanged because they are passed by pointer. The output is:

```
A is 20 and B is 10
```

When you use pass-by-pointer, a copy of the pointer is passed to the function. If you modify the pointer inside the called function, you only modify the copy of the pointer, but the original pointer remains unmodified and still points to the original variable.

The difference between pass-by-pointer and pass-by-value is that modifications made to arguments passed in by pointer in the called function have effect in the calling function, whereas modifications made to arguments passed in by value in the called function can not affect the calling function. Use pass-by-pointer if you want to modify the argument value in the calling function. Otherwise, use pass-by-value to pass arguments.

Related reference:

“Pointers” on page 114

Pass by reference (C++ only)

Pass-by-reference means to pass the reference of an argument in the calling function to the corresponding formal parameter of the called function. The called function can modify the value of the argument by using its reference passed in.

The following example shows how arguments are passed by reference. The reference parameters are initialized with the actual arguments when the function is called.

```
#include <stdio.h>

void swapnum(int &i, int &j) {
    int temp = i;
    i = j;
    j = temp;
}

int main(void) {
    int a = 10;
    int b = 20;

    swapnum(a, b);
    printf("A is %d and B is %d\n", a, b);
    return 0;
}
```

When the function `swapnum()` is called, the values of the variables `a` and `b` are exchanged because they are passed by reference. The output is:

```
A is 20 and B is 10
```

To modify a reference that is qualified by the `const` qualifier, you must cast away its constness with the `const_cast` operator. For example:

```
#include <iostream>
using namespace std;

void f(const int& x) {
    int& y = const_cast<int&>(x);
    ++y;
}

int main() {
    int a = 5;
    f(a);
    cout << a << endl;
}
```

This example outputs 6.

Pass-by-references is more efficient than pass-by-value, because it does not copy the arguments. The formal parameter is an alias for the argument. When the called function read or write the formal parameter, it is actually read or write the argument itself.

The difference between pass-by-reference and pass-by-value is that modifications made to arguments passed in by reference in the called function have effect in the calling function, whereas modifications made to arguments passed in by value in the called function can not affect the calling function. Use pass-by-reference if you want to modify the argument value in the calling function. Otherwise, use pass-by-value to pass arguments.

The difference between pass-by-reference and pass-by-pointer is that pointers can be NULL or reassigned whereas references cannot. Use pass-by-pointer if NULL is a valid parameter value or if you want to reassign the pointer. Otherwise, use constant or non-constant references to pass arguments.

Related reference:

“References (C++ only)” on page 123

“The `const_cast` operator (C++ only)” on page 202

Allocation and deallocation functions (C++ only)

You may define your own `new` operator or allocation function as a class member function or a global namespace function with the following restrictions:

- The first parameter must be of type `std::size_t`. It cannot have a default parameter.
- The return type must be of type `void*`.
- Your allocation function may be a template function. Neither the first parameter nor the return type may depend on a template parameter.
- If you declare your allocation function with the empty exception specification `throw()`, your allocation function must return a null pointer if your function fails. Otherwise, your function must throw an exception of type `std::bad_alloc` or a class derived from `std::bad_alloc` if your function fails.

You may define your own `delete` operator or deallocation function as a class member function or a global namespace function with the following restrictions:

- The first parameter must be of type `void*`.
- The return type must be of type `void`.
- Your deallocation function may be a template function. Neither the first parameter nor the return type may depend on a template parameter.

The following example defines replacement functions for global namespace `new` and `delete`:

```
#include <cstdio>
#include <cstdlib>

using namespace std;

void* operator new(size_t sz) {
    printf("operator new with %d bytes\n", sz);
    void* p = malloc(sz);
    if (p == 0) printf("Memory error\n");
    return p;
}

void operator delete(void* p) {
    if (p == 0) printf ("Deleting a null pointer\n");
    else {
        printf("delete object\n");
        free(p);
    }
}

struct A {
    const char* data;
    A() : data("Text String") { printf("Constructor of S\n"); }
    ~A() { printf("Destructor of S\n"); }
};

int main() {
```

```

A* ap1 = new A;
delete ap1;

printf("Array of size 2:\n");
A* ap2 = new A[2];
delete[] ap2;
}

```

See the following output of the above example:

```

operator
new with 40 bytes
operator new with 33 bytes
operator new with 4 bytes
Constructor of S
Destructor of S
delete object
Array of size 2:
operator new with 16 bytes
Constructor of S
Constructor of S
Destructor of S
Destructor of S
delete object

```

Related reference:

“new expressions (C++ only)” on page 207

Default arguments in C++ functions (C++ only)

You can provide default values for function parameters. For example:

```

#include <iostream>
using namespace std;

int a = 1;
int f(int a) { return a; }
int g(int x = f(a)) { return x; }

int h() {
    a = 2;
    {
        int a = 3;
        return g();
    }
}

int main() {
    cout << h() << endl;
}

```

This example prints 2 to standard output, because the `a` referred to in the declaration of `g()` is the one at file scope, which has the value 2 when `g()` is called.

The default argument must be implicitly convertible to the parameter type.

A pointer to a function must have the same type as the function. Attempts to take the address of a function by reference without specifying the type of the function will produce an error. The type of a function is not affected by arguments with default values.

The following example shows that default arguments are not considered part of a function's type. The default argument allows you to call a function without specifying all of the arguments, it does not allow you to create a pointer to the

function that does not specify the types of all the arguments. Function `f` can be called without an explicit argument, but the pointer `badpointer` cannot be defined without specifying the type of the argument:

```
int f(int = 0);
void g()
{
    int a = f(1);           // ok
    int b = f();           // ok, default argument used
}
int (*pointer)(int) = &f; // ok, type of f() specified (int)
int (*badpointer)() = &f; // error, badpointer and f have
                          // different types. badpointer must
                          // be initialized with a pointer to
                          // a function taking no arguments.
```

In this example, function `f3` has a return type `int`, and takes an `int` argument with a default value that is the value returned from function `f2`:

```
const int j = 5;
int f3( int x = f2(j) );
```

Related reference:

“Pointers to functions” on page 287

Restrictions on default arguments (C++ only)

Of the operators, only the function call operator and the operator `new` can have default arguments when they are overloaded.

Parameters with default arguments must be the trailing parameters in the function declaration parameter list. For example:

```
void f(int a, int b = 2, int c = 3); // trailing defaults
void g(int a = 1, int b = 2, int c); // error, leading defaults
void h(int a, int b = 3, int c);    // error, default in middle
```

Once a default argument has been given in a declaration or definition, you cannot redefine that argument, even to the same value. However, you can add default arguments not given in previous declarations. For example, the last declaration below attempts to redefine the default values for `a` and `b`:

```
void f(int a, int b, int c=1); // valid
void f(int a, int b=1, int c); // valid, add another default
void f(int a=1, int b, int c); // valid, add another default
void f(int a=1, int b=1, int c=1); // error, redefined defaults
```

You can supply any default argument values in the function declaration or in the definition. Any parameters in the parameter list following a default argument value must have a default argument value specified in this or a previous declaration of the function.

You cannot use local variables in default argument expressions. For example, the compiler generates errors for both function `g()` and function `h()` below:

```
void f(int a)
{
    int b=4;
    void g(int c=a); // Local variable "a" cannot be used here
    void h(int d=b); // Local variable "b" cannot be used here
}
```

Related reference:

“Function call expressions” on page 167

“new expressions (C++ only)” on page 207

Evaluation of default arguments (C++ only)

When a function defined with default arguments is called with trailing arguments missing, the default expressions are evaluated. For example:

```
void f(int a, int b = 2, int c = 3); // declaration
// ...
int a = 1;
f(a); // same as call f(a,2,3)
f(a,10); // same as call f(a,10,3)
f(a,10,20); // no default arguments
```

Default arguments are checked against the function declaration and evaluated when the function is called. The order of evaluation of default arguments is undefined. Default argument expressions cannot use other parameters of the function. For example:

```
int f(int q = 3, int r = q); // error
```

The argument `r` cannot be initialized with the value of the argument `q` because the value of `q` may not be known when it is assigned to `r`. If the above function declaration is rewritten:

```
int q=5;
int f(int q = 3, int r = q); // error
```

The value of `r` in the function declaration still produces an error because the variable `q` defined outside of the function is hidden by the argument `q` declared for the function. Similarly:

```
typedef double D;
int f(int D, int z = D(5.3) ); // error
```

Here the type `D` is interpreted within the function declaration as the name of an integer. The type `D` is hidden by the argument `D`. The cast `D(5.3)` is therefore not interpreted as a cast because `D` is the name of the argument not a type.

In the following example, the nonstatic member `a` cannot be used as an initializer because `a` does not exist until an object of class `X` is constructed. You can use the static member `b` as an initializer because `b` is created independently of any objects of class `X`. You can declare the member `b` after its use as a default argument because the default values are not analyzed until after the final bracket `}` of the class declaration.

```
class X
{
    int a;
    f(int z = a) ; // error
    g(int z = b) ; // valid
    static int b;
};
```

Pointers to functions

Pointers to functions

A pointer to a function points to the address of the executable code of the function. You can use pointers to call functions and to pass functions as arguments to other functions. You cannot perform pointer arithmetic on pointers to functions.

The type of a pointer to a function is based on both the return type and parameter types of the function.

A declaration of a pointer to a function must have the pointer name in parentheses. Function parameters have precedence over pointers in declarations, so parentheses are required to alter the precedence and declare a pointer to a function. Without them, the compiler interprets the declaration as a function that returns a pointer to a specified return type. For example:

```
int *f(int a);      /* function f returning an int*          */
int (*g)(int a);   /* pointer g to a function returning an int          */
```

In the first declaration, `f` is interpreted as a function that takes an `int` as argument, and returns a pointer to an `int`. In the second declaration, `g` is interpreted as a pointer to a function that takes an `int` argument and that returns an `int`.

► C++11

You can use a trailing return type in the declaration or definition of a pointer to a function. For example:

```
auto(*fp)()->int;
```

In this example, `fp` is a pointer to a function that returns `int`. You can rewrite the declaration of `fp` without using a trailing return type as `int (*fp)(void)`. For more information on trailing return type, see “Trailing return type (C++11)” on page 266.

◀ C++11

References to functions

A reference to a function is an alias or an alternative name for a function. You must initialize all references to functions after they are defined. Once defined, a reference to a function cannot be reassigned. You can use references to call functions and to pass functions as arguments to other functions. For example:

```
int g();
```

```
// f is a reference to a function that has no parameters and returns int.
int bar(int(&f)()){
```

```
    // call function f that is passed as an argument.
    return f();
}
```

```
int x = bar(g);
```

► C++11

You can also use a trailing return type in the declaration or definition of a reference to a function. In the following example, `fp` is a reference to a function that returns `int`. For more information on trailing return type, see “Trailing return type (C++11)” on page 266.

```
auto(&fp)()->int;
```

◀ C++11

Related reference:

“Language linkage (C++ only)” on page 13

“Pointers” on page 114

“Pointer conversions” on page 156

“References (C++ only)” on page 123

Nested functions (C only) (IBM extension)

A nested function is a function defined inside the definition of another function. It can be defined wherever a variable declaration is permitted, which allows nested functions within nested functions. Within the containing function, the nested function can be declared prior to being defined by using the `auto` keyword. Otherwise, a nested function has internal linkage. The language feature is an extension to C89 and C99, implemented to facilitate porting programs developed with GNU C.

A nested function can access all identifiers of the containing function that precede its definition.

A nested function must not be called after the containing function exits.

A nested function cannot use a `goto` statement to jump to a label in the containing function, or to a local label declared with the `__label__` keyword inherited from the containing function.

Related reference:

“Locally declared labels (IBM extension)” on page 220

Constexpr functions (C++11)

Note: IBM supports selected features of C++11, known as C++0x before its ratification. IBM will continue to develop and implement the features of this standard. The implementation of the language level is based on IBM's interpretation of the standard. Until IBM's implementation of all the C++11 features is complete, including the support of a new C++11 standard library, the implementation might change from release to release. IBM makes no attempt to maintain compatibility, in source, binary, or listings and other compiler interfaces, with earlier releases of IBM's implementation of the new C++11 features.

A non-constructor function that is declared with a `constexpr` specifier is a `constexpr` function. A `constexpr` function is a function that can be invoked within a constant expression.

A `constexpr` function must satisfy the following conditions:

- It is not virtual.
- Its return type is a literal type.
- Each of its parameters must be of a literal type.
- When initializing the return value, each constructor call and implicit conversion is valid in a constant expression.
- Its function body is `= delete` or `= default`; otherwise, its function body must contain only the following statements:
 - null statements
 - `static_assert` declarations
 - typedef declarations that do not define classes or enumerations
 - `using` directives
 - `using` declarations
 - One return statement

When a nonstatic member function that is not a constructor is declared with the `constexpr` specifier, that member function is constant, and the `constexpr` specifier has no other effect on the function type. The class of which that function is a member must be a literal type.

The following examples demonstrate the usage of `constexpr` functions:

```
const int array_size1 (int x) {
    return x+1;
}
// Error, constant expression required in array declaration
int array[array_size1(10)];

constexpr int array_size2 (int x) {
    return x+1;
}
// OK, constexpr functions can be evaluated at compile time
// and used in contexts that require constant expressions.
int array[array_size2(10)];

struct S {
    S() { }
    constexpr S(int) { }
    constexpr virtual int f() { // Error, f must not be virtual.
        return 55;
    }
};

struct NL {
    ~NL() { } // The user-provided destructor (even if it is trivial)
             // makes the type a non-literal type.
};

constexpr NL f1() { // Error, return type of f1 must be a literal type.
    return NL();
}

constexpr int f2(NL) { // Error, the parameter type NL is not a literal type.
    return 55;
}

constexpr S f3() {
    return S();
}

enum { val = f3() }; // Error, initialization of the return value in f3()
                   // uses a non-constexpr constructor.

constexpr void f4(int x) { // Error, return type should not be void.
    return;
}

constexpr int f5(int x) { // Error, function body contains more than
    if (x<0) // return statement.
        x = -x;
    return x;
}
```

When a function template is declared as a `constexpr` function, if the instantiation results in a function that does not satisfy the requirements of a `constexpr` function, the `constexpr` specifier is ignored. For example:

```
template <class C> constexpr NL f6(C c) { // OK, the constexpr specifier ignored
    return NL();
}
void g() {
    f6(55); // OK, not used in a constant expression
}
```

A call to a constexpr function produces the same result as a call to an equivalent non-constexpr function in all respects, except that a call to a constexpr function can appear in a constant expression.

A constexpr function is implicitly inline.

The main function cannot be declared with the constexpr specifier.



Related reference:

“The constexpr specifier (C++11)” on page 96

“Generalized constant expressions (C++11)” on page 167

Chapter 10. Namespaces (C++ only)

A *namespace* is an optionally named scope. You declare names inside a namespace as you would for a class or an enumeration. You can access names declared inside a namespace the same way you access a nested class name by using the scope resolution (::) operator. However namespaces do not have the additional features of classes or enumerations. The primary purpose of the namespace is to add an additional identifier (the name of the namespace) to a name.

 To be compatible with GNU C, the compiler supports the visibility attribute to namespaces. 

Defining namespaces

In order to uniquely identify a namespace, use the **namespace** keyword.

Namespace syntax

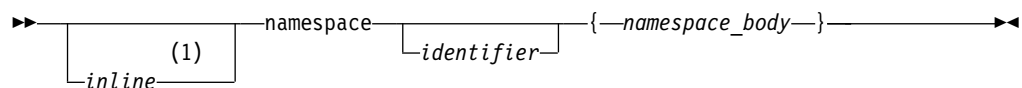

Notes:

- 1 This syntax is valid only at the C++11 language level.

The *identifier* in an original namespace definition is the name of the namespace. The identifier may not be previously defined in the declarative region in which the original namespace definition appears, except in the case of extending namespace. If an identifier is not used, the namespace is an *unnamed namespace*.

Related reference:

“Unnamed namespaces” on page 295

“Inline namespace definitions (C++11)” on page 300

Declaring namespaces

The identifier used for a namespace name should be unique. It should not be used previously as a global identifier.

```
namespace Raymond {  
    // namespace body here...  
}
```

In this example, *Raymond* is the identifier of the namespace. If you intend to access a namespace's elements, the namespace's identifier must be known in all translation units.

Related reference:

“File/global scope” on page 7

Creating a namespace alias

An alternate name can be used in order to refer to a specific namespace identifier.

```

namespace INTERNATIONAL_BUSINESS_MACHINES {
    void f();
}

namespace IBM = INTERNATIONAL_BUSINESS_MACHINES;

```

In this example, the IBM identifier is an alias for INTERNATIONAL_BUSINESS_MACHINES. This is useful for referring to long namespace identifiers.

If a namespace name or alias is declared as the name of any other entity in the same declarative region, a compile-time error will result. Also, if a namespace name defined at global scope is declared as the name of any other entity in any global scope of the program, a compile-time error will result.

Related reference:

“File/global scope” on page 7

Creating an alias for a nested namespace

Namespace definitions hold declarations. Since a namespace definition is a declaration itself, namespace definitions can be nested.

An alias can also be applied to a nested namespace.

```

namespace INTERNATIONAL_BUSINESS_MACHINES {
    int j;
    namespace NESTED_IBM_PRODUCT {
        void a() { j++; }
        int j;
        void b() { j++; }
    }
}
namespace NIBM = INTERNATIONAL_BUSINESS_MACHINES::NESTED_IBM_PRODUCT

```

In this example, the NIBM identifier is an alias for the namespace NESTED_IBM_PRODUCT. This namespace is nested within the INTERNATIONAL_BUSINESS_MACHINES namespace.

Related reference:

“Creating a namespace alias” on page 293

Extending namespaces

Namespaces are extensible. You can add subsequent declarations to a previously defined namespace. Extensions may appear in files separate from or attached to the original namespace definition. For example:

```

namespace X { // namespace definition
    int a;
    int b;
}

namespace X { // namespace extension
    int c;
    int d;
}

namespace Y { // equivalent to namespace X
    int a;
    int b;
    int c;
    int d;
}

```

In this example, namespace X is defined with a and b and later extended with c and d. namespace X now contains all four members. You may also declare all of the required members within one namespace. This method is represented by namespace Y. This namespace contains a, b, c, and d.

Namespaces and overloading

You can overload functions across namespaces. For example:

```
// Original X.h:
int f(int);

// Original Y.h:
int f(char);

// Original program.c:
#include "X.h"
#include "Y.h"

int main(){
    f('a'); // calls f(char) from Y.h
}
```

Namespaces can be introduced to the previous example without drastically changing the source code.

```
// New X.h:
namespace X {
    f(int);
}

// New Y.h:
namespace Y {
    f(char);
}

// New program.c:
#include "X.h"
#include "Y.h"

using namespace X;
using namespace Y;

int main(){
    f('a'); // calls f() from Y.h
}
```

In program.c, the main function calls function f(), which is a member of namespace Y. If you place the using directives in the header files, the source code for program.c remains unchanged.

Related reference:

Chapter 11, “Overloading (C++ only),” on page 305

Unnamed namespaces

A namespace with no identifier before an opening brace produces an *unnamed namespace*. Each translation unit may contain its own unique unnamed namespace. The following example demonstrates how unnamed namespaces are useful.

```
#include <iostream>

using namespace std;

namespace {
```

```

    const int i = 4;
    int variable;
}

int main()
{
    cout << i << endl;
    variable = 100;
    return 0;
}

```

In the previous example, the unnamed namespace permits access to `i` and `variable` without using a scope resolution operator.

The following example illustrates an improper use of unnamed namespaces.

```

#include <iostream>

using namespace std;

namespace {
    const int i = 4;
}

int i = 2;

int main()
{
    cout << i << endl; // error
    return 0;
}

```

Inside `main`, `i` causes an error because the compiler cannot distinguish between the global name and the unnamed namespace member with the same name. In order for the previous example to work, the namespace must be uniquely identified with an identifier and `i` must specify the namespace it is using.

You can extend an unnamed namespace within the same translation unit. For example:

```

#include <iostream>

using namespace std;

namespace {
    int variable;
    void funct (int);
}

namespace {
    void funct (int i) { cout << i << endl; }
}

int main()
{
    funct(variable);
    return 0;
}

```

both the prototype and definition for `funct` are members of the same unnamed namespace.

Note: Items defined in an unnamed namespace have internal linkage. Rather than using the keyword `static` to define items with internal linkage, define them in an unnamed namespace instead.

Related reference:

“Program linkage” on page 11

“Internal linkage” on page 11

Namespace member definitions

A namespace can define its own members within itself or externally using explicit qualification. See the following example of a namespace defining a member internally:

```
namespace A {
    void b() { /* definition */ }
}
```

Within namespace A member `void b()` is defined internally.

A namespace can also define its members externally using explicit qualification on the name being defined. The entity being defined must already be declared in the namespace and the definition must appear after the point of declaration in a namespace that encloses the declaration's namespace.

See the following example of a namespace defining a member externally:

```
namespace A {
    namespace B {
        void f();
    }
    void B::f() { /* defined outside of B */ }
}
```

In this example, function `f()` is declared within namespace B and defined (outside B) in A.

Namespaces and friends

Every name first declared in a namespace is a member of that namespace. If a friend declaration in a non-local class first declares a class or function, the friend class or function is a member of the innermost enclosing namespace.

The following is an example of this structure:

```
// f has not yet been defined
void z(int);
namespace A {
    class X {
        friend void f(X); // A::f is a friend
    };
    // A::f is not visible here
    X x;
    void f(X) { /* definition */ } // f() is defined and known to be a friend
}

using A::x;

void z()
{
    A::f(x); // OK
    A::X::f(x); // error: f is not a member of A::X
}
```

In this example, function `f()` can only be called through namespace `A` using the call `A::f(s)`; Attempting to call function `f()` through class `X` using the `A::X::f(x)`; call results in a compile-time error. Since the friend declaration first occurs in a non-local class, the friend function is a member of the innermost enclosing namespace and may only be accessed through that namespace.

Related reference:

“Friends” on page 351

The using directive

A `using` directive provides access to all namespace qualifiers and the scope operator. This is accomplished by applying the `using` keyword to a namespace identifier.

Using directive syntax

► `using namespace name;` ◀

The *name* must be a previously defined namespace. The `using` directive may be applied at the global and local scope but not the class scope. Local scope takes precedence over global scope by hiding similar declarations with some exceptions.

For unqualified name lookup, if a scope contains a `using` directive that nominates a second namespace and that second namespace contains another `using` directive, the `using` directive from the second namespace acts as if it resides within the first scope.

```
namespace A {
    int i;
}
namespace B {
    int i;
    using namespace A;
}
void f()
{
    using namespace B;
    i = 7; // error
}
```

In this example, attempting to initialize `i` within function `f()` causes a compile-time error, because function `f()` does not know which `i` to call; `i` from namespace `A`, or `i` from namespace `B`.

Related reference:

“The using declaration and class members” on page 366

“Inline namespace definitions (C++11)” on page 300

The using declaration and namespaces

A `using` declaration provides access to a specific namespace member. This is accomplished by applying the `using` keyword to a namespace name with its corresponding namespace member.

using declaration syntax

► `using namespace :: member;` ◄

In this syntax diagram, the qualifier name follows the `using` declaration and the *member* follows the qualifier name. For the declaration to work, the member must be declared inside the given namespace. For example:

```
namespace A {
    int i;
    int k;
    void f(){};
    void g(){};
}

using A::k;
```

In this example, the `using` declaration is followed by `A`, the name of namespace `A`, which is then followed by the scope operator (`::`), and `k`. This format allows `k` to be accessed outside of namespace `A` through a `using` declaration. After issuing a `using` declaration, any extension made to that specific namespace will not be known at the point at which the `using` declaration occurs.

Overloaded versions of a given function must be included in the namespace prior to that given function's declaration. A `using` declaration may appear at namespace, block and class scope.

Related reference:

"The `using` declaration and class members" on page 366

Explicit access

To explicitly qualify a member of a namespace, use the namespace identifier with a `::` scope resolution operator.

Explicit access qualification syntax

► `namespace_name :: member` ◄

For example:

```
namespace VENDITTI {
    void j()
};

VENDITTI::j();
```

In this example, the scope resolution operator provides access to the function `j` held within namespace `VENDITTI`. The scope resolution operator `::` is used to access identifiers in both global and local namespaces. Any identifier in an application can be accessed with sufficient qualification. Explicit access cannot be applied to an unnamed namespace.

Related reference:

"Scope resolution operator `::` (C++ only)" on page 166

Inline namespace definitions (C++11)

Note: IBM supports selected features of C++11, known as C++0x before its ratification. IBM will continue to develop and implement the features of this standard. The implementation of the language level is based on IBM's interpretation of the standard. Until IBM's implementation of all the C++11 features is complete, including the support of a new C++11 standard library, the implementation might change from release to release. IBM makes no attempt to maintain compatibility, in source, binary, or listings and other compiler interfaces, with earlier releases of IBM's implementation of the new C++11 features.

Inline namespace definitions are namespace definitions with an initial `inline` keyword. A namespace so defined is an inline namespace. You can define and specialize members of an inline namespace as if they were also members of the enclosing namespace.

Inline namespace definitions syntax

► `inline namespace_definition` ◄

When an inline namespace is defined, a `using` directive is implicitly inserted into its enclosing namespace. While looking up a qualified name through the enclosing namespace, members of the inline namespace are brought in and found by the implicit `using` directive, even if that name is declared in the enclosing namespace.

For example, if you compile the following code with `USE_INLINE_B` defined, the output of the resulting executable is 1; otherwise, the output is 2.

```
namespace A {
  #if USE_INLINE_B
    inline
  #endif
  namespace B {
    int foo(bool) { return 1; }
  }
  int foo(int) { return 2; }
}

int main(void) {
  return A::foo(true);
}
```

The properties of inline namespace definitions are transitive; that is, you can use members of an inline namespace as if they were also members of any namespace in its enclosing namespace set, which consists of the innermost non-inline namespace enclosing the inline namespace, together with any intervening inline namespaces. For example:

```
namespace L {
  inline namespace M {
    inline namespace N {
      / *...*/
    }
  }
}
```

In this example, a namespace L contains an inline namespace M, which in turn contains another inline namespace N. The members of N can also be used as if they were members of the namespaces in its enclosing namespace set, i.e., L and M.

Notes:

- Do not declare the namespace `std`, which is used for the C++ standard library, as an inline namespace.
- Do not declare a namespace to be an inline namespace if it is not inline in its first definition.
- You can declare an unnamed namespace as an inline namespace.

Using inline namespace definitions in explicit instantiation and specialization

You can explicitly instantiate or specialize each member of an inline namespace as if it were a member of its enclosing namespace. Name lookup for the primary template of an explicit instantiation or specialization in a namespace, for example M, considers the inline namespaces whose enclosing namespace set includes M. For example:

```
namespace L {
    inline namespace M {
        template <typename T> class C;
    }

    template <typename T> void f(T) { /*...*/ };
}

struct X { /*...*/ };
namespace L {
    template<> class C<X> { /*...*/ };    //template specialization
}

int main()
{
    L::C<X> r;
    f(r); // fine, L is an associated namespace of C
}
```

In this example, M is an inline namespace of its enclosing namespace L, class C is a member of inline namespace M, so L is an associated namespace of class C.

The following rules apply when you use inline namespace definitions in explicit instantiation and specialization:

- An explicit instantiation must be in an enclosing namespace of the primary template if the template name is qualified; otherwise, it must be in the nearest enclosing namespace of the primary template or a namespace in the enclosing namespace set.
- An explicit specialization declaration must first be declared in the namespace scope of the nearest enclosing namespace of the primary template, or a namespace in the enclosing namespace set. If the declaration is not a definition, it may be defined later in any enclosing namespace.

Using inline namespace definitions in library versioning

With inline namespace definitions, you can provide a common source interface for a library with several implementations, and a user of the library can choose one

implementation to be associated with the common interface. The following example demonstrates the use of inline namespace in library versioning with explicit specialization.

```
//foo.h
#ifndef SOME_LIBRARY_FOO_H
#define SOME_LIBRARY_FOO_H
namespace SomeLibrary
{
    #ifdef SOME_LIBRARY_USE_VERSION_2_
        inline namespace version_2 { }
    #else
        inline namespace version_1 { }
    #endif
    namespace version_1 {
        template <typename T> int foo(T a) {return 1;}
    }
    namespace version_2 {
        template <typename T> int foo(T a) {return 2;}
    }
}
#endif

//myFooCaller.C
#include <Foo.h>
#include <iostream>

struct MyIntWrapper { int x;};

//Specialize SomeLibrary::foo()
//Should specialize the correct version of foo()

namespace SomeLibrary {
    template <> int foo(MyIntWrapper a) { return a.x;}
}

int main(void) {
    using namespace SomeLibrary;
    MyIntWrapper intWrap = { 4 };
    std::cout << foo(intWrap) + foo(1.0) << std::endl;
}
```

If you compile this example with `SOME_LIBRARY_USE_VERSION_2_` defined, the output of the resulting executable is 6; otherwise, the output is 5. If the function call, `foo(intWrap)`, is qualified with one of the inline namespaces, then you need to ensure that the explicit specialization is effective.

Related reference:

- “Defining namespaces” on page 293
- “Extending namespaces” on page 294
- “The using directive” on page 298
- “The using declaration and namespaces” on page 298
- “Explicit instantiation” on page 434
- “Explicit specialization” on page 438
- “C++11 compatibility” on page 519

The visibility namespace attribute (IBM extension)

The visibility namespace attribute is a language extension that allows you to control whether and how the entities within a namespace defined in one module can be referenced or used in other modules. By using this feature, you can make a shared library smaller and decrease the possibility of symbol collision. For details, see Using visibility attributes in the XL C/C++ Optimization and Programming Guide.

visibility namespace attribute syntax

```
▶ namespace identifier __attribute__ _____▶  
▶ (( visibility ( "default" ) ) ) { namespace_body } ▶  
   | __visibility__ |  
   | "protected" |  
   | "hidden" |  
   | "internal" |
```

You can specify the attribute name `visibility` with or without leading and trailing double underscore characters; however, using the double underscore characters reduces the likelihood of name conflicts with macros of the same name.

Example

In the following example, function `fun()` is defined in namespace `A`, and the visibility attribute of `fun()` is `default`:

```
namespace A __attribute__((visibility("default"))) {  
    void fun();  
}
```

Related reference:

“External linkage” on page 12

“The visibility variable attribute” on page 144

“visibility” on page 278

“The visibility type attribute” on page 108

 See Using visibility attributes in the XL C/C++ Optimization and Programming Guide

 See `-qvisibility` in the XL C/C++ Compiler Reference

 See `-qmksprobj` in the XL C/C++ Compiler Reference

 See `-G` in the XL C/C++ Compiler Reference

 See `#pragma GCC visibility push`, `#pragma GCC visibility pop` (IBM extension) in the XL C/C++ Compiler Reference

Chapter 11. Overloading (C++ only)

If you specify more than one definition for a function name or an operator in the same scope, you have *overloaded* that function name or operator. Overloaded functions and operators are described in “Overloading functions” and “Overloading operators” on page 307, respectively.

An *overloaded declaration* is a declaration that had been declared with the same name as a previously declared declaration in the same scope, except that both declarations have different types.

If you call an overloaded function name or operator, the compiler determines the most appropriate definition to use by comparing the argument types you used to call the function or operator with the parameter types specified in the definitions. The process of selecting the most appropriate overloaded function or operator is called *overload resolution*, as described in “Overload resolution” on page 315.

Overloading functions

You overload a function name *f* by declaring more than one function with the name *f* in the same scope. The declarations of *f* must differ from each other by the types and/or the number of arguments in the argument list. When you call an overloaded function named *f*, the correct function is selected by comparing the argument list of the function call with the parameter list of each of the overloaded candidate functions with the name *f*. A *candidate function* is a function that can be called based on the context of the call of the overloaded function name.

Consider a function `print`, which displays an `int`. As shown in the following example, you can overload the function `print` to display other types, for example, `double` and `char*`. You can have three functions with the same name, each performing a similar operation on a different data type:

```
#include <iostream>
using namespace std;

void print(int i) {
    cout << " Here is int " << i << endl;
}
void print(double f) {
    cout << " Here is float " << f << endl;
}

void print(char* c) {
    cout << " Here is char* " << c << endl;
}

int main() {
    print(10);
    print(10.10);
    print("ten");
}
```

The following is the output of the above example:

```
Here is int 10
Here is float 10.1
Here is char* ten
```

Function overloading based on vector parameter types is supported.

Related reference:

“Restrictions on overloaded functions”

“Derivation” on page 361

Restrictions on overloaded functions

You cannot overload the following function declarations even if they appear in the same scope. Note that this list applies only to explicitly declared functions and those that have been introduced through using declarations:

- Function declarations that differ only by return type. For example, you cannot use the following declarations:

```
int f();
float f();
```

- Member function declarations that have the same name and the same parameter types, but one of these declarations is a static member function declaration. For example, you cannot use the following two member function declarations of `f()`:

```
struct A {
    static int f();
    int f();
};
```

- Member function template declarations that have the same name, the same parameter types, and the same template parameter lists, but one of these declarations is a static template member function declaration.
- Function declarations that have equivalent parameter declarations. These declarations are not allowed because they would be declaring the same function.
- Function declarations with parameters that differ only by the use of typedef names that represent the same type. Note that a typedef is a synonym for another type, not a separate type. For example, the following two declarations of `f()` are declarations of the same function:

```
typedef int I;
void f(float, int);
void f(float, I);
```

- Function declarations with parameters that differ only because one is a pointer and the other is an array. For example, see the following declarations of the same function:

```
void f(char*);
void f(char[10]);
```

The first array dimension is insignificant when differentiating parameters; all other array dimensions are significant. For example, see the following declarations of the same function:

```
void g(char(*)[20]);
void g(char[5][20]);
```

The following two declarations are *not* equivalent:

```
void g(char(*)[20]);
void g(char(*)[40]);
```

- Function declarations with parameters that differ only because one is a function type and the other is a pointer to a function of the same type. For example, see the following declarations of the same function:

```
void f(int(float));
void f(int (*)(float));
```

- Function declarations with parameters that differ only because of cv-qualifiers `const`, `volatile`, and `restrict`. This restriction only applies if any of these qualifiers appears at the outermost level of a parameter type specification. For example, see the following declarations of the same function:

```
int f(int);
int f(const int);
int f(volatile int);
```

Note that you can differentiate parameters with `const`, `volatile` and `restrict` qualifiers if you apply them *within* a parameter type specification. For example, the following declarations are *not* equivalent because `const` and `volatile` qualify `int`, rather than `*`, and thus are not at the outermost level of the parameter type specification.

```
void g(int*);
void g(const int*);
void g(volatile int*);
```

The following declarations are also not equivalent:

```
void g(float&);
void g(const float&);
void g(volatile float&);
```

- Function declarations with parameters that differ only because their default arguments differ. For example, see the following declarations of the same function:

```
void f(int);
void f(int i = 10);
```

- Multiple functions with extern "C" language-linkage and the same name, regardless of whether their parameter lists are different.

Related reference:

"The using declaration and namespaces" on page 298

"typedef definitions" on page 86

"Type qualifiers" on page 98

"Language linkage (C++ only)" on page 13

Overloading operators

You can redefine or overload the function of most built-in operators in C++. These operators can be overloaded globally or on a class-by-class basis. Overloaded operators are implemented as functions and can be member functions or global functions.

Operator overloading involving vector types is not supported.

An overloaded operator is called an *operator function*. You declare an operator function with the keyword `operator` preceding the operator. Overloaded operators are distinct from overloaded functions, but like overloaded functions, they are distinguished by the number and types of operands used with the operator.

Consider the standard `+` (plus) operator. When this operator is used with operands of different standard types, the operators have slightly different meanings. For example, the addition of two integers is not implemented in the same way as the addition of two floating-point numbers. C++ allows you to define your own meanings for the standard C++ operators when they are applied to class types. In the following example, a class called `complex` is defined to model complex numbers, and the `+` (plus) operator is redefined in this class to add two complex numbers.

```

// This example illustrates overloading the plus (+) operator.

#include <iostream>
using namespace std;

class complx
{
    double real,
          imag;
public:
    complx( double real = 0., double imag = 0.); // constructor
    complx operator+(const complx& c) const;    // operator+(?)
};

// define constructor
complx::complx( double r, double i )
{
    real = r; imag = i;
}

// define overloaded + (plus) operator
complx complx::operator+ (const complx& c) const
{
    complx result;
    result.real = (this->real + c.real);
    result.imag = (this->imag + c.imag);
    return result;
}

int main()
{
    complx x(4,4);
    complx y(6,6);
    complx z = x + y; // calls complx::operator+()
}

```

You can overload any of the following operators:

+	-	*	/	%	^	&		~
!	=	<	>	+=	-=	*=	/=	%=
^=	&=	=	<<	>>	<<=	>>=	==	!=
<=	>=	&&		++	--	,	->*	->
()	[]	new	delete	new[]	delete[]			

where () is the function call operator and [] is the subscript operator.

You can overload both the unary and binary forms of the following operators:

+	-	*	&
---	---	---	---

You cannot overload the following operators:

.	.*	::	?:
---	----	----	----

You cannot overload the preprocessor symbols # and ##.

An operator function can be either a nonstatic member function, or a nonmember function with at least one parameter that has class, reference to class, enumeration, or reference to enumeration type.

You cannot change the precedence, grouping, or the number of operands of an operator.

An overloaded operator (except for the function call operator) cannot have default arguments or an ellipsis in the argument list.

You must declare the overloaded =, [], (), and -> operators as nonstatic member functions to ensure that they receive lvalues as their first operands.

The operators new, delete, new[], and delete[] do not follow the general rules described in this section.

All operators except the = operator are inherited.

Overloading unary operators

You overload a unary operator with either a nonstatic member function that has no parameters, or a nonmember function that has one parameter. Suppose a unary operator @ is called with the statement @t, where t is an object of type T. A nonstatic member function that overloads this operator would have the following form:

```
return_type operator@()
```

A nonmember function that overloads the same operator would have the following form:

```
return_type operator@(T)
```

An overloaded unary operator may return any type.

The following example overloads the ! operator:

```
#include <iostream>
using namespace std;

struct X { };

void operator!(X) {
    cout << "void operator!(X)" << endl;
}

struct Y {
    void operator!() {
        cout << "void Y::operator!()" << endl;
    }
};

struct Z { };

int main() {
    X ox; Y oy; Z oz;
    !ox;
    !oy;
    // !oz;
}
```

See the output of the above example:

```
void operator!(X)
void Y::operator!()
```

The operator function call !ox is interpreted as operator!(X). The call !oy is interpreted as Y::operator!(). (The compiler would not allow !oz because the ! operator has not been defined for class Z.)

Related reference:

“Unary expressions” on page 169

Overloading increment and decrement operators

You overload the prefix increment operator `++` with either a nonmember function operator that has one argument of class type or a reference to class type, or with a member function operator that has no arguments.

In the following example, the increment operator is overloaded in both ways:

```
class X {
public:

    // member prefix ++x
    void operator++() { }
};

class Y { };

// non-member prefix ++y
void operator++(Y&) { }

int main() {
    X x;
    Y y;

    // calls x.operator++()
    ++x;

    // explicit call, like ++x
    x.operator++();

    // calls operator++(y)
    ++y;

    // explicit call, like ++y
    operator++(y);
}
```

The postfix increment operator `++` can be overloaded for a class type by declaring a nonmember function operator `operator++()` with two arguments, the first having class type and the second having type `int`. Alternatively, you can declare a member function operator `operator++()` with one argument having type `int`. The compiler uses the `int` argument to distinguish between the prefix and postfix increment operators. For implicit calls, the default value is zero.

For example:

```
class X {
public:

    // member postfix x++
    void operator++(int) { };
};

class Y { };

// nonmember postfix y++
void operator++(Y&, int) { };

int main() {
    X x;
    Y y;

    // calls x.operator++(0)
}
```



```

// default argument of zero is supplied by compiler
x++;
// explicit call to member postfix x++
x.operator++(0);

// calls operator++(y, 0)
y++;

// explicit call to non-member postfix y++
operator++(y, 0);
}

```

The prefix and postfix decrement operators follow the same rules as their increment counterparts.

Related reference:

“Increment operator ++” on page 170

“Decrement operator --” on page 170

Overloading binary operators

You overload a binary operator with either a nonstatic member function that has one parameter, or a nonmember function that has two parameters. Suppose a binary operator @ is called with the statement `t @ u`, where `t` is an object of type `T`, and `u` is an object of type `U`. A nonstatic member function that overloads this operator would have the following form:

```
return_type operator@(U)
```

A nonmember function that overloads the same operator would have the following form:

```
return_type operator@(T, U)
```

An overloaded binary operator may return any type.

The following example overloads the `*` operator:

```

struct X {

    // member binary operator
    void operator*(int) { }
};

// non-member binary operator
void operator*(X, float) { }

int main() {
    X x;
    int y = 10;
    float z = 10;

    x * y;
    x * z;
}

```

The call `x * y` is interpreted as `x.operator*(y)`. The call `x * z` is interpreted as `operator*(x, z)`.

Related reference:

“Binary expressions” on page 180

Overloading assignments

You overload the assignment operator, `operator=`, with a nonstatic member function that has only one parameter. You cannot declare an overloaded assignment operator that is a nonmember function. The following example shows how you can overload the assignment operator for a particular class:

```
struct X {
    int data;
    X& operator=(X& a) { return a; }
    X& operator=(int a) {
        data = a;
        return *this;
    }
};

int main() {
    X x1, x2;
    x1 = x2;    // call x1.operator=(x2)
    x1 = 5;    // call x1.operator=(5)
}
```

The assignment `x1 = x2` calls the copy assignment operator `X& X::operator=(X&)`. The assignment `x1 = 5` calls the copy assignment operator `X& X::operator=(int)`. The compiler implicitly declares a copy assignment operator for a class if you do not define one yourself. Consequently, the copy assignment operator (`operator=`) of a derived class hides the copy assignment operator of its base class.

However, you can declare any copy assignment operator as virtual. The following example demonstrates this:

```
#include <iostream>
using namespace std;

struct A {
    A& operator=(char) {
        cout << "A& A::operator=(char)" << endl;
        return *this;
    }
    virtual A& operator=(const A&) {
        cout << "A& A::operator=(const A&)" << endl;
        return *this;
    }
};

struct B : A {
    B& operator=(char) {
        cout << "B& B::operator=(char)" << endl;
        return *this;
    }
    virtual B& operator=(const A&) {
        cout << "B& B::operator=(const A&)" << endl;
        return *this;
    }
};

struct C : B { };

int main() {
    B b1;
    B b2;
    A* ap1 = &b1;
    A* ap2 = &b1;
    *ap1 = 'z';
    *ap2 = b2;
}
```

```

    C c1;
    // c1 = 'z';
}

```

The following is the output of the above example:

```

A& A::operator=(char)
B& B::operator=(const A&)

```

The assignment `*ap1 = 'z'` calls `A& A::operator=(char)`. Because this operator has not been declared `virtual`, the compiler chooses the function based on the type of the pointer `ap1`. The assignment `*ap2 = b2` calls `B& B::operator=(const &A)`. Because this operator has been declared `virtual`, the compiler chooses the function based on the type of the object that the pointer `ap1` points to. The compiler would not allow the assignment `c1 = 'z'` because the implicitly declared copy assignment operator declared in class `C` hides `B& B::operator=(char)`.

Related reference:

“Copy assignment operators” on page 408

“Assignment operators” on page 181

Overloading function calls

The function call operator, when overloaded, does not modify how functions are called. Rather, it modifies how the operator is to be interpreted when applied to objects of a given type.

You overload the function call operator, `operator()`, with a nonstatic member function that has any number of parameters. If you overload a function call operator for a class its declaration will have the following form:

```

return_type operator()(parameter_list)

```

Unlike all other overloaded operators, you can provide default arguments and ellipses in the argument list for the function call operator.

The following example demonstrates how the compiler interprets function call operators:

```

struct A {
    void operator()(int a, char b, ...) { }
    void operator()(char c, int d = 20) { }
};

int main() {
    A a;
    a(5, 'z', 'a', 0);
    a('z');
    // a();
}

```

The function call `a(5, 'z', 'a', 0)` is interpreted as `a.operator()(5, 'z', 'a', 0)`. This calls `void A::operator()(int a, char b, ...)`. The function call `a('z')` is interpreted as `a.operator>('z')`. This calls `void A::operator()(char c, int d = 20)`. The compiler would not allow the function call `a()` because its argument list does not match any function call parameter list defined in class `A`.

The following example demonstrates an overloaded function call operator:

```

class Point {
private:
    int x, y;
}

```

```

public:
    Point() : x(0), y(0) { }
    Point& operator()(int dx, int dy) {
        x += dx;
        y += dy;
        return *this;
    }
};

int main() {
    Point pt;

    // Offset this coordinate x with 3 points
    // and coordinate y with 2 points.
    pt(3, 2);
}

```

The above example reinterprets the function call operator for objects of class `Point`. If you treat an object of `Point` like a function and pass it two integer arguments, the function call operator will add the values of the arguments you passed to `Point::x` and `Point::y` respectively.

Related reference:

“Function call expressions” on page 167

Overloading subscripting

You overload operator `[]` with a nonstatic member function that has only one parameter. The following example is a simple array class that has an overloaded subscripting operator. The overloaded subscripting operator throws an exception if you try to access the array outside of its specified bounds:

```

#include <iostream>
using namespace std;

template <class T> class MyArray {
private:
    T* storage;
    int size;
public:
    MyArray(int arg = 10) {
        storage = new T[arg];
        size = arg;
    }

    ~MyArray() {
        delete[] storage;
        storage = 0;
    }

    T& operator[](const int location) throw (const char *);
};

template <class T> T& MyArray<T>::operator[](const int location)
    throw (const char *) {
    if (location < 0 || location >= size) throw "Invalid array access";
    else return storage[location];
}

int main() {
    try {
        MyArray<int> x(13);
        x[0] = 45;
        x[1] = 2435;
        cout << x[0] << endl;
        cout << x[1] << endl;
    }
}

```

```

        x[13] = 84;
    }
    catch (const char* e) {
        cout << e << endl;
    }
}

```

See the output of the above example:

```

45
2435
Invalid array access

```

The expression `x[1]` is interpreted as `x.operator[](1)` and calls `int& MyArray<int>::operator[](const int)`.

Overloading class member access

You overload `operator->` with a nonstatic member function that has no parameters. The following example demonstrates how the compiler interprets overloaded class member access operators:

```

struct Y {
    void f() { };
};

struct X {
    Y* ptr;
    Y* operator->() {
        return ptr;
    };
};

int main() {
    X x;
    x->f();
}

```

The statement `x->f()` is interpreted as `(x.operator->())->f()`.

The `operator->` is used (often in conjunction with the pointer-dereference operator) to implement "smart pointers." These pointers are objects that behave like normal pointers except they perform other tasks when you access an object through them, such as automatic object deletion (either when the pointer is destroyed, or the pointer is used to point to another object), or reference counting (counting the number of smart pointers that point to the same object, then automatically deleting the object when that count reaches zero).

One example of a smart pointer is included in the C++ Standard Library called `auto_ptr`. You can find it in the `<memory>` header. The `auto_ptr` class implements automatic object deletion.

Related reference:

"Arrow operator `->`" on page 169

Overload resolution

The process of selecting the most appropriate overloaded function or operator is called *overload resolution*.

Suppose that `f` is an overloaded function name. When you call the overloaded function `f()`, the compiler creates a set of *candidate functions*. This set of functions

includes all of the functions named `f` that can be accessed from the point where you called `f()`. The compiler may include as a candidate function an alternative representation of one of those accessible functions named `f` to facilitate overload resolution.

After creating a set of candidate functions, the compiler creates a set of *viable functions*. This set of functions is a subset of the candidate functions. The number of parameters of each viable function agrees with the number of arguments you used to call `f()`.

The compiler chooses the *best viable function*, the function declaration that the C++ runtime environment will use when you call `f()`, from the set of viable functions. The compiler does this by *implicit conversion sequences*. An implicit conversion sequence is the sequence of conversions required to convert an argument in a function call to the type of the corresponding parameter in a function declaration. The implicit conversion sequences are ranked; some implicit conversion sequences are better than others. The best viable function is the one whose parameters all have either better or equal-ranked implicit conversion sequences than all of the other viable functions. The compiler will not allow a program in which the compiler was able to find more than one best viable function. Implicit conversion sequences are described in more detail in “Implicit conversion sequences” on page 317.

When a variable length array is a function parameter, the leftmost array dimension does not distinguish functions among candidate functions. In the following, the second definition of `f` is not allowed because `void f(int [])` has already been defined.

```
void f(int a[*]) {}
void f(int a[5]) {} // illegal
```

However, array dimensions other than the leftmost in a variable length array do differentiate candidate functions when the variable length array is a function parameter. For example, the overload set for function `f` might comprise the following:

```
void f(int a[][5]) {}
void f(int a[][4]) {}
void f(int a[][g]) {} // assume g is a global int
```

but cannot include

```
void f(int a[][g2]){} // illegal, assuming g2 is a global int
```

because having candidate functions with second-level array dimensions `g` and `g2` creates ambiguity about which function `f` should be called: neither `g` nor `g2` is known at compile time.

You can override an exact match by using an explicit cast. In the following example, the second call to `f()` matches with `f(void*)`:

```
void f(int) { };
void f(void*) { };

int main() {
    f(0xaabb); // matches f(int);
    f((void*) 0xaabb); // matches f(void*)
}
```

Implicit conversion sequences

An *implicit conversion sequence* is the sequence of conversions required to convert an argument in a function call to the type of the corresponding parameter in a function declaration.

The compiler tries to determine an implicit conversion sequence for each argument. It then categorizes each implicit conversion sequence in one of three categories and ranks them depending on the category. The compiler does not allow any program in which it cannot find an implicit conversion sequence for an argument.

The following are the three categories of conversion sequences in order from best to worst:

- “Standard conversion sequences”
- “User-defined conversion sequences”
- “Ellipsis conversion sequences” on page 318

Note: Two standard conversion sequences or two user-defined conversion sequences might have different ranks.

Standard conversion sequences

Standard conversion sequences are categorized in one of three ranks. The ranks are listed in order from highest to lowest:

- Exact match: This rank includes the following conversions:
 - Identity conversions
 - Lvalue-to-rvalue conversions
 - Array-to-pointer conversions
 - Qualification conversions
- Promotion: This rank includes integral and floating point promotions.
- Conversion: This rank includes the following conversions:
 - Integral and floating-point conversions
 - Floating-integral conversions
 - Pointer conversions
 - Pointer-to-member conversions
 - Boolean conversions

The compiler ranks a standard conversion sequence by its lowest-ranked standard conversion. For example, if a standard conversion sequence has a floating-point conversion, then that sequence has conversion rank.

User-defined conversion sequences

A *user-defined conversion sequence* consists of the following:

- A standard conversion sequence
- A user-defined conversion
- A second standard conversion sequence

A user-defined conversion sequence A is better than a user-defined conversion sequence B if both A and B have the same user-defined conversion function or constructor, and the second standard conversion sequence of A is better than the

second standard conversion sequence of B.





Ellipsis conversion sequences

An *ellipsis conversion sequence* occurs when the compiler matches an argument in a function call with a corresponding ellipsis parameter.

Ranking implicit conversion sequences

Ranking standard conversion sequences

Suppose S1 and S2 are two standard conversion sequences. The compiler checks whether S1 and S2 satisfy the following conditions in sequence. If one of the conditions is satisfied, S1 is a better standard conversion sequence than S2.

1. S2 involves a qualification conversion, but S1 does not involve qualification conversions. See Example 1.
2. The rank of S1 is higher than the rank of S2. See Example 2.
3. Both S1 and S2 involve qualification conversions. T1 is the target type of S1, and T2 of S2. T2 is more cv-qualified than T1. See Example 3.
4.  S1 and S2 are reference bindings to an rvalue, and neither of them refers to the implicit object parameter of a nonstatic member function. S1 binds an rvalue reference and S2 binds an lvalue reference. See Example 4. 
5.  S1 and S2 are reference bindings. S1 binds an lvalue reference to a function lvalue, and S2 binds an rvalue reference to a function lvalue. See Example 5. 
6. S1 and S2 are reference bindings. T1 is the target type referred by S1, and T2 by S2. T1 and T2 differ only in top-level cv-qualifiers where T2 is more cv-qualified than T1. See Example 6.

If two standard conversion sequences S1 and S2 have the same rank, S1 is a better standard conversion sequence than S2 if one of the following conditions is satisfied:

- S1 converts a pointer, a pointer to member, or a null pointer, and S2 does not. See Example 7.
- Class A is a parent class of class B. S1 is a conversion from B* to A*, and S2 is a conversion from B* to void*; or S1 is a conversion from A* to void*, and S2 is a conversion from B* to void*. See Example 8.
- Class A is a parent class of class B, and class B is a parent class of class C. One of the following conditions is satisfied:
 - S1 is a conversion from C* to B*, and S2 is a conversion from C* to A*.
 - S1 binds an expression of type C to a reference of type B&, and S2 binds an expression of type C to a reference of type A&.
 - S1 is a conversion from A::* to B::*, and S2 is a conversion from A::* to C::*.
 - S1 is a conversion from C to B, and S2 is a conversion from C to A.
 - S1 is a conversion from B* to A*, and S2 is a conversion from C* to A*. See Example 9.
 - S1 binds an expression of type B to type A&, and S2 binds an expression of type C to type A&.
 - S1 is a conversion from B::* to C::*, and S2 is a conversion from A::* to C::*.
 - S1 is a conversion from B to A, and S2 is a conversion from C to A.

Example 1

```
void f(int*);           // #1 function
void f(const int*);    // #2 function

void test() {
    // The compiler calls #1 function
    f(static_cast<int*>(0));
}
```

In this example, for the call of `f(static_cast<int*>(0))`, the standard conversion sequence S1 of the `f(int*)` function is from `int*` to `int*`. The standard conversion sequence S2 of the `f(const int*)` function is from `int*` to `const int*`. S2 involves a qualification conversion, but S1 does not, so S1 is a better standard conversion sequence than S2.

Example 2

```
struct A { };
struct B : A { };

void f(const B*); // #1 function
void f(A*);       // #2 function

void test() {
    // The compiler calls #1 function
    f(static_cast<B*>(0));
}

struct A1 *g(int); // #3 function
struct A2 *g(short); // #4 function

void test2() {
    // The compiler calls #4 function
    A2* a2 = g(static_cast<short>(0));

    // The compiler calls #3 function
    A1* a1 = g('\0');
}
```

In this example, for the call of `f(static_cast<B*>(0))`, the standard conversion sequence of the `f(const B*)` function is an exact match, and the standard conversion sequence of the `f(A*)` function is a conversion. The rank of exact match is higher than that of conversion, so `f(const B*)` is chosen by overload resolution. Similarly, for the call of `g(static_cast<short>(0))`, the standard conversion sequence of the `g(short)` function is an exact match, and the standard conversion sequence of the `g(int)` function is a promotion. The `g(short)` function is called because the rank of exact match is higher than that of promotion. For the call of `g('\0')`, the standard conversion sequence of the `g(short)` function is a conversion, and the standard conversion sequence of the `g(int)` function is a promotion, `g(int)` is called in this case because the rank of promotion is higher than that of conversion.

Example 3

```
struct A { };
struct B : A { };
void g(const A*);           // #1 function
void g(const volatile A*); // #2 function
void test2() {
    // The compiler calls #1 function
    g(static_cast<B*>(0));
}
```

In this example, for the call of `g(static_cast<B*>(0))`, the standard conversion sequence S1 of the `g(const A*)` function is from `B*` to `const A*`. The standard conversion sequence S2 of the `g(const volatile A*)` function is from `B*` to `const volatile A*`. Both S1 and S2 involve qualification conversions, and `const volatile A*` is more cv-qualified than `const A*`, so S1 is a better standard conversion sequence than S2.

➤ C++11

Example 4

```
double f1();
int g(const double&&); // #1 function
int g(const double&); // #2 function

// The compiler calls #1 function
int i = g(f1());

struct A {
    int operator+(int);
};

int operator+(A &&, int);

A &&f2();

void test() {
    f2() + 0; // error
}
```

In this example, for the call of `g(f1())`, the standard conversion sequence of the `g(const double&)` function binds an lvalue reference, and the standard conversion sequence for `g(const double&&)` binds an rvalue reference. Neither of these two standard conversion sequences refers to the implicit object parameter of a nonstatic member function. The `g(const double&&)` function is called because its standard conversion sequence is a better one. For the expression `f2() + 0`, the class member candidate involves a reference binding of the implicit object parameter of a nonstatic member function and hence cannot be ordered with respect to the namespace scope candidate.

Example 5

```
double f();
int g(double(&&)()); // #1 function
int g(double(&)()); // #2 function

// The compiler calls #2 function
int i = g(f)
```

In this example, for the call of `g(f)`, the standard conversion sequence of the `g(double(&)())` function binds an lvalue reference to a function lvalue, and the standard conversion sequence of the `g(double(&&)())` function binds an rvalue reference to a function lvalue. The `g(double(&)())` function is called because its standard conversion sequence is a better one.

➤ C++11 ◀

Example 6

```
void f(A&); // #1 function
void f(const A&); // #2 function
void test() {
```

```

    A a;
    // The compiler calls #1 function
    f(a);
}

```

In this example, for the call of `f(a)`, the standard conversion sequence `S1` of the `f(A&)` function binds an lvalue reference `A&` to `a`, and the standard conversion sequence `S2` of the `f(const A&)` function binds a `const` lvalue reference `const A&` to `a`. Because `const A` and `A` are the same except for top-level cv-qualifiers, and `const A` is more cv-qualified than `A`, `S1` is a better standard conversion sequence than `S2`.

Example 7

```

void f(void*); // #1 function
void f(bool); // #2 function
void test() {
    // The compiler calls #1 function
    f(static_cast<int*>(0));
}

```

In this example, for the call of `f(static_cast<int*>(0))`, the standard conversion sequence `S1` of the `f(void*)` function is from `int*` to `void*`, and the standard conversion sequence `S2` of the `f(bool)` function is from `int*` to `bool`. `S1` and `S2` have the same rank. However, because `S1` does not convert a pointer, a pointer to member, or a null pointer to a `bool`, and `S2` converts a pointer to a `bool`, `S1` is a better standard conversion sequence than `S2`.

Example 8

```

//
void f(void*); // #1 function
void f(struct A*); // #2 function
struct A { };
struct B : A { };
void test() {
    // The compiler calls #2 function
    f(static_cast<B*>(0));
}

```

In this example, for the call of `f(static_cast<B*>(0))`, the standard conversion sequence of the `f(void*)` function is from `B*` to `void*`, and the standard conversion sequence of the `f(struct A*)` is from `B*` to `A*`. The `f(struct A*)` is called because its standard conversion sequence is a better one.

Example 9

```

void f(struct A *);
struct A { };
struct B : A { };
struct C : B { };
struct S {
    operator B*();
    operator C*();
}
void test() {
    // calls S::operator B*()
    f(S());
}

```

In this example, for the call of `f(S())`, the standard conversion sequence is from `S()` to `A*`, and the structure `S` has two conversion operators. The operator function `operator B* ()` is called, because the conversion from `B*` to `A*` is better than from `C*` to `A*`.

Ranking user-defined conversion sequences

Suppose U1 and U2 are two user-defined conversion sequences. U1 and U2 use the same user-defined conversion function, constructor, or aggregate initialization. U1 is a better user-defined conversion sequence than U2 if the second standard conversion sequence of U1 is better than that of U2. See Example 10:

Example 10

```
void f(void*); // #1 function
void f(bool); // #2 function
struct A {
    operator int*();
}
void test() {
    // The compiler calls #1 function
    f(A());
}
```

In this example, for the call of `f(A())`, the user-defined conversion sequence U1 of the `f(void*)` function is from `A` to `void*`. The user-defined conversion sequence U2 of the `f(bool)` function is from `A` to `bool`. U1 and U2 use the same user-defined conversion from `A` to `int*`. The standard conversion sequence from `int*` to `void*` is better than the standard conversion sequence from `int*` to `bool`, so U1 is a better user-defined conversion sequence than U2.

Related reference:

“Lvalue-to-rvalue conversions” on page 155

“Pointer conversions” on page 156

“Integral conversions” on page 148

“Floating-point conversions” on page 149

“Boolean conversions” on page 148

“Lvalues and rvalues” on page 159

“References (C++ only)” on page 123

Resolving addresses of overloaded functions

If you use an overloaded function name `f` without any arguments, that name can refer to a function, a pointer to a function, a pointer to member function, or a specialization of a function template. Because you did not provide any arguments, the compiler cannot perform overload resolution the same way it would for a function call or for the use of an operator. Instead, the compiler will try to choose the best viable function that matches the type of one of the following expressions, depending on where you have used `f`:

- An object or reference you are initializing
- The left side of an assignment
- A parameter of a function or a user-defined operator
- The return value of a function, operator, or conversion
- An explicit type conversion

If the compiler chose a declaration of a nonmember function or a static member function when you used `f`, the compiler matched the declaration with an expression of type pointer-to-function or reference-to-function. If the compiler chose a declaration of a nonstatic member function, the compiler matched that declaration with an expression of type pointer-to-member function. The following example demonstrates this:

```

struct X {
    int f(int) { return 0; }
    static int f(char) { return 0; }
};

int main() {
    int (X::*a)(int) = &X::f;
    // int (*b)(int) = &X::f;
}

```

The compiler will not allow the initialization of the function pointer `b`. No nonmember function or static function of type `int(int)` has been declared.

If `f` is a template function, the compiler will perform template argument deduction to determine which template function to use. If successful, it will add that function to the list of viable functions. If there is more than one function in this set, including a non-template function, the compiler will eliminate all template functions from the set and choose the non-template function. If there are only template functions in this set, the compiler will choose the most specialized template function. The following example demonstrates this:

```

template<class T> int f(T) { return 0; }
template<> int f(int) { return 0; }
int f(int) { return 0; }

int main() {
    int (*a)(int) = f;
    a(1);
}

```

The function call `a(1)` calls `int f(int)`.

Related reference:

- “Pointers to functions” on page 287
- “Pointers to members” on page 340
- “Function templates” on page 424
- “Explicit specialization” on page 438

Chapter 12. Classes (C++ only)

A *class* is a mechanism for creating user-defined data types. It is similar to the C language structure data type. In C, a structure is composed of a set of data members. In C++, a class type is like a C structure, except that a class is composed of a set of data members and a set of operations that can be performed on the class.

In C++, a class type can be declared with the keywords `union`, `struct`, or `class`. A union object can hold any one of a set of named members. Structure and class objects hold a complete set of members. Each class type represents a unique set of class members including data members, member functions, and other type names. The default access for members depends on the class key:

- The members of a class declared with the keyword `class` are private by default. A class is inherited privately by default.
- The members of a class declared with the keyword `struct` are public by default. A structure is inherited publicly by default.
- The members of a union (declared with the keyword `union`) are public by default. A union cannot be used as a base class in derivation.

Once you create a class type, you can declare one or more objects of that class type. For example:

```
class X
{
    /* define class members here */
};
int main()
{
    X xobject1;        // create an object of class type X
    X xobject2;        // create another object of class type X
}
```

You may have *polymorphic* classes in C++. Polymorphism is the ability to use a function name that appears in different classes (related by inheritance), without knowing exactly the class the function belongs to at compile time.

C++ allows you to redefine standard operators and functions through the concept of overloading. Operator overloading facilitates data abstraction by allowing you to use classes as easily as built-in types.

Related reference:

“Structures and unions” on page 70

Chapter 13, “Class members and friends (C++ only),” on page 335

Chapter 14, “Inheritance (C++ only),” on page 359

Chapter 11, “Overloading (C++ only),” on page 305

“Virtual functions” on page 377

Declaring class types

A class declaration creates a unique type class name.

A *class specifier* is a type specifier used to declare a class. Once a class specifier has been seen and its members declared, a class is considered to be defined even if the member functions of that class are not yet defined.

Class specifier syntax

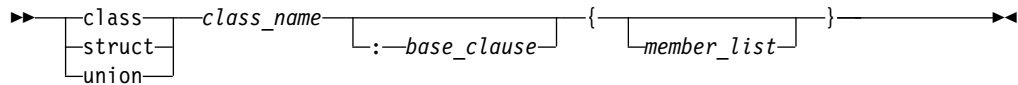

The *class_name* is a unique identifier that becomes a reserved word within its scope. Once a class name is declared, it hides other declarations of the same name within the enclosing scope.

The *member_list* specifies the class members, both data and functions, of the class *class_name*. If the *member_list* of a class is empty, objects of that class have a nonzero size. You can use a *class_name* within the *member_list* of the class specifier itself as long as the size of the class is not required.

The *base_clause* specifies the base class or classes from which the class *class_name* inherits members. If the *base_clause* is not empty, the class *class_name* is called a *derived class*.

A *structure* is a class declared with the *class_key* `struct`. The members and base classes of a structure are public by default. A *union* is a class declared with the *class_key* `union`. The members of a union are public by default; a union holds only one data member at a time.

An *aggregate class* is a class that has no user-defined constructors, no private or protected non-static data members, no base classes, and no virtual functions.

Related reference:

“Class member lists” on page 335

“Derivation” on page 361

Using class objects

You can use a class type to create instances or *objects* of that class type. For example, you can declare a class, structure, and union with class names X, Y, and Z respectively:

```
class X {
    // members of class X
};

struct Y {
    // members of struct Y
};

union Z {
    // members of union Z
};
```

You can then declare objects of each of these class types. Remember that classes, structures, and unions are all types of C++ classes.

```

int main()
{
    X xobj;    // declare a class object of class type X
    Y yobj;    // declare a struct object of class type Y
    Z zobj;    // declare a union object of class type Z
}

```

In C++, unlike C, you do not need to precede declarations of class objects with the keywords union, struct, and class unless the name of the class is hidden. For example:

```

struct Y { /* ... */ };
class X { /* ... */ };
int main ()
{
    int X;        // hides the class name X
    Y yobj;       // valid
    X xobj;       // error, class name X is hidden
    class X xobj; // valid
}

```

When you declare more than one class object in a declaration, the declarators are treated as if declared individually. For example, if you declare two objects of class S in a single declaration:

```

class S { /* ... */ };
int main()
{
    S S,T; // declare two objects of class type S
}

```

this declaration is equivalent to:

```

class S { /* ... */ };
int main()
{
    S S;
    class S T; // keyword class is required
               // since variable S hides class type S
}

```

but is not equivalent to:

```

class S { /* ... */ };
int main()
{
    S S;
    S T; // error, S class type is hidden
}

```

You can also declare references to classes, pointers to classes, and arrays of classes. For example:

```

class X { /* ... */ };
struct Y { /* ... */ };
union Z { /* ... */ };
int main()
{
    X xobj;
    X &xref = xobj; // reference to class object of type X
    Y *yptr;       // pointer to struct object of type Y
    Z zarray[10];  // array of 10 union objects of type Z
}

```

You can initialize classes in external, static, and automatic definitions. The initializer contains an = (equal sign) followed by a brace-enclosed, comma-separated list of values. You do not need to initialize all members of a class.

Objects of class types that are not copy restricted can be assigned, passed as arguments to functions, and returned by functions.

Related reference:

“Structures and unions” on page 70

“References (C++ only)” on page 123

“Scope of class names” on page 329

Classes and structures

The C++ class is an extension of the C language structure. Because the only difference between a structure and a class is that structure members have public access by default and class members have private access by default, you can use the keywords `class` or `struct` to define equivalent classes.

For example, in the following code fragment, the class `X` is equivalent to the structure `Y`:

```
class X {  
  
    // private by default  
    int a;  
  
public:  
  
    // public member function  
    int f() { return a = 5; };  
};  
  
struct Y {  
  
    // public by default  
    int f() { return a = 5; };  
  
private:  
  
    // private data member  
    int a;  
};
```

If you define a structure and then declare an object of that structure using the keyword `class`, the members of the object are still public by default. In the following example, `main()` has access to the members of `obj_X` even though `obj_X` has been declared using an elaborated type specifier that uses the class key `class`:

```
#include <iostream>  
using namespace std;  
  
struct X {  
    int a;  
    int b;  
};  
  
class X obj_X;  
  
int main() {
```

```

obj_X.a = 0;
obj_X.b = 1;
cout << "Here are a and b: " << obj_X.a << " " << obj_X.b << endl;
}

```

See the output of the above example:

Here are a and b: 0 1

Scope of class names

A class declaration introduces the class name into the scope where it is declared. Any class, object, function or other declaration of that name in an enclosing scope is hidden.

If a class name is declared in the same scope as a function, enumerator, or object with the same name, you must refer to that class using an *elaborated type specifier*:

Elaborated type specifier syntax

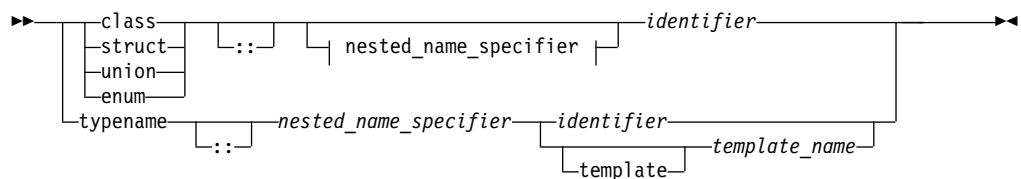

Nested name specifier:

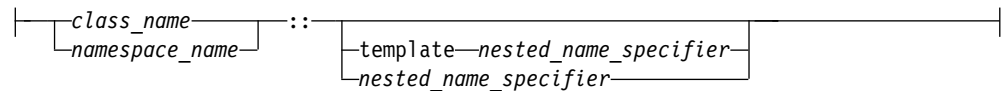

The following example must use an elaborated type specifier to refer to class A because this class is hidden by the definition of the function A():

```

class A { };

void A (class A*) { };

int main()
{
    class A* x;
    A(x);
}

```

The declaration `class A* x` is an elaborated type specifier. Declaring a class with the same name of another function, enumerator, or object as demonstrated above is not recommended.

An elaborated type specifier can also be used in the incomplete declaration of a class type to reserve the name for a class type within the current scope.

Related reference:

“Incomplete class declarations” on page 330

Incomplete class declarations

An *incomplete class declaration* is a class declaration that does not define any class members. You cannot declare any objects of the class type or refer to the members of a class until the declaration is complete. However, an incomplete declaration allows you to make specific references to a class prior to its definition as long as the size of the class is not required.

For example, you can define a pointer to the structure first in the definition of the structure second. Structure first is declared as an incomplete class declaration prior to the definition of second, and the definition of oneptr in structure second does not require the size of first:

```
struct first;           // incomplete declaration of struct first

struct second          // complete declaration of struct second
{
    first* oneptr;     // pointer to struct first refers to
                      // struct first prior to its complete
                      // declaration

    first one;        // error, you cannot declare an object of
                      // an incompletely declared class type

    int x, y;
};

struct first          // complete declaration of struct first
{
    second two;       // define an object of class type second
    int z;
};
```

However, if you declare a class with an empty member list, it is a complete class declaration. For example:

```
class X;               // incomplete class declaration
class Z {};           // empty member list
class Y
{
public:
    X yobj;           // error, cannot create an object of an
                      // incomplete class type
    Z zobj;           // valid
};
```

Related reference:

“Class member lists” on page 335

Nested classes

A *nested class* is declared within the scope of another class. The name of a nested class is local to its enclosing class. Unless you use explicit pointers, references, or object names, declarations in a nested class can only use visible constructs, including type names, static members, and enumerators from the enclosing class and global variables.

Member functions of a nested class follow regular access rules and have no special access privileges to members of their enclosing classes. Member functions of the enclosing class have no special access to members of a nested class. The following example demonstrates this:

```
class A {
    int x;

    class B { };
};
```

```

class C {

    // The compiler cannot allow the following
    // declaration because A::B is private:
    //   B b;

    int y;
    void f(A* p, int i) {

        // The compiler cannot allow the following
        // statement because A::x is private:
        //   p->x = i;

    }
};

void g(C* p) {

    // The compiler cannot allow the following
    // statement because C::y is private:
    //   int z = p->y;
}

int main() { }

```

The compiler would not allow the declaration of object `b` because class `A::B` is private. The compiler would not allow the statement `p->x = i` because `A::x` is private. The compiler would not allow the statement `int z = p->y` because `C::y` is private.

You can define member functions and static data members of a nested class in namespace scope. For example, in the following code fragment, you can access the static members `x` and `y` and member functions `f()` and `g()` of the nested class nested by using a qualified type name. Qualified type names allow you to define a typedef to represent a qualified class name. You can then use the typedef with the `::` (scope resolution) operator to refer to a nested class or class member, as shown in the following example:

```

class outside
{
public:
    class nested
    {
    public:
        static int x;
        static int y;
        int f();
        int g();
    };
};

int outside::nested::x = 5;
int outside::nested::f() { return 0; };

typedef outside::nested outnest; // define a typedef
int outnest::y = 10;           // use typedef with ::
int outnest::g() { return 0; };

```

However, using a typedef to represent a nested class name hides information and may make the code harder to understand.

You cannot use a typedef name in an elaborated type specifier. To illustrate, you cannot use the following declaration in the above example:

```
class outnest obj;
```

A nested class may inherit from private members of its enclosing class. The following example demonstrates this:

```
class A {
private:
    class B { };
    B *z;

    class C : private B {
private:
        B y;
//      A::B y2;
        C *x;
//      A::C *x2;
    };
};
```

The nested class `A::C` inherits from `A::B`. The compiler does not allow the declarations `A::B y2` and `A::C *x2` because both `A::B` and `A::C` are private.

Related reference:

“Class scope (C++ only)” on page 8

“Scope of class names” on page 329

“Member access” on page 349

“Static members” on page 344

Local classes

A *local class* is declared within a function definition. Declarations in a local class can only use type names, enumerations, static variables from the enclosing scope, as well as external variables and functions.

For example:

```
int x; // global variable
void f() // function definition
{
    static int y; // static variable y can be used by
                // local class
    int x; // auto variable x cannot be used by
          // local class
    extern int g(); // extern function g can be used by
                  // local class

    class local // local class
    {
        int g() { return x; } // error, local variable x
                            // cannot be used by g
        int h() { return y; } // valid,static variable y
        int k() { return ::x; } // valid, global x
        int l() { return g(); } // valid, extern function g
    };
}

int main()
{
    local* z; // error: the class local is not visible
    // ...}
}
```

Member functions of a local class have to be defined within their class definition, if they are defined at all. As a result, member functions of a local class are inline functions. Like all member functions, those defined within the scope of a local class do not need the keyword `inline`.

A local class cannot have static data members. In the following example, an attempt to define a static member of a local class causes an error:

```
void f()
{
    class local
    {
        int f();           // error, local class has noninline
                          // member function
        int g() {return 0;} // valid, inline member function
        static int a;      // error, static is not allowed for
                          // local class
        int b;            // valid, nonstatic variable
    };
}
// . . .
```

An enclosing function has no special access to members of the local class.

Related reference:

“Member functions” on page 337

“The inline function specifier” on page 256

Local type names

Local type names follow the same scope rules as other names. Type names defined within a class declaration have class scope and cannot be used outside their class without qualification.

If you use a class name, typedef name, or a constant name that is used in a type name, in a class declaration, you cannot redefine that name after it is used in the class declaration.

For example:

```
int main ()
{
    typedef double db;
    struct st
    {
        db x;
        typedef int db; // error
        db y;
    };
}
```

The following declarations are valid:

```
typedef float T;
class s {
    typedef int T;
    void f(const T);
};
```

Here, function `f()` takes an argument of type `s::T`. However, the following declarations, where the order of the members of `s` has been reversed, cause an error:

```
typedef float T;  
class s {  
    void f(const T);  
    typedef int T;  
};
```

In a class declaration, you cannot redefine a name that is not a class name, or a typedef name to a class name or typedef name once you have used that name in the class declaration.

Related reference:

“Scope” on page 6

“typedef definitions” on page 86

Chapter 13. Class members and friends (C++ only)

This section discusses the declaration of class members with respect to the information hiding mechanism and how a class can grant functions and classes access to its nonpublic members by the use of the friend mechanism. C++ expands the concept of information hiding to include the notion of having a public class interface but a private implementation. It is the mechanism for limiting direct access to the internal representation of a class type by functions in a program.

Related reference:

“Inherited member access” on page 364

Class member lists

An optional *member list* declares subobjects called *class members*. Class members can be data, functions, nested types, and enumerators.

Class member list syntax

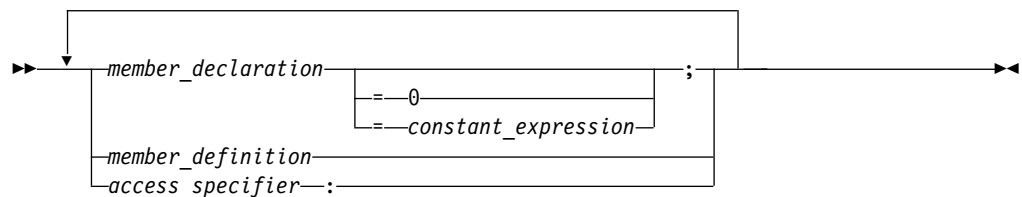

The member list follows the class name and is placed between braces. The following applies to member lists, and members of member lists:

- A *member_declaration* or a *member_definition* may be a declaration or definition of a data member, member function, nested type, or enumeration. (The enumerators of an enumeration defined in a class member list are also members of the class.)
- A member list is the only place where you can declare class members.
- Friend declarations are not class members but must appear in member lists.
- The member list in a class definition declares all the members of a class; you cannot add members elsewhere.
- You cannot declare a member twice in a member list.
- You may declare a data member or member function as `static` but not `auto`, `extern`, or `register`.
- You may declare a nested class, a member class template, or a member function, and define it outside the class.
- You must define static data members outside the class.
- Nonstatic members that are class objects must be objects of previously defined classes; a class A cannot contain an object of class A, but it can contain a pointer or reference to an object of class A.
- You must specify all dimensions of a nonstatic array member.

A *constant initializer* (= *constant_expression*) may only appear in a class member of integral or enumeration type that has been declared `static`.

A *pure specifier* (= 0) indicates that a function has no definition. It is only used with member functions declared as `virtual` and replaces the function definition of a member function in the member list.

An *access specifier* is one of `public`, `private`, or `protected`.

A *member declaration* declares a class member for the class containing the declaration.

The order of allocation of nonstatic class members separated by an *access specifier* is implementation-dependent.

The order of allocation of nonstatic class members separated by an *access specifier* is implementation-dependent. The compiler allocates class members in the order in which they are declared.

Suppose `A` is a name of a class. The following class members of `A` must have a name different from `A`:

- All data members
- All type members
- All enumerators of enumerated type members
- All members of all anonymous union members

Related reference:

“Declaring class types” on page 325

“Member access” on page 349

“Inherited member access” on page 364

“Static members” on page 344

Data members

Data members include members that are declared with any of the fundamental types, as well as other types, including pointer, reference, array types, bit fields, and user-defined types. You can declare a data member the same way as a variable, except that explicit initializers are not allowed inside the class definition. However, a `const` static data member of integral or enumeration type may have an explicit initializer.

If an array is declared as a nonstatic class member, you must specify all of the dimensions of the array.

A class can have members that are of a class type or are pointers or references to a class type. Members that are of a class type must be of a class type that has been previously declared. An incomplete class type can be used in a member declaration as long as the size of the class is not needed. For example, a member can be declared that is a pointer to an incomplete class type.

A class `X` cannot have a member that is of type `X`, but it can contain pointers to `X`, references to `X`, and static objects of `X`. Member functions of `X` can take arguments of type `X` and have a return type of `X`. For example:

```
class X
{
    X();
    X *xptr;
    X &xlref;
```

```
    X &&xrref;  
    static X xcount;  
    X xfunc(X);  
};
```

Related reference:

“Member access” on page 349

“Inherited member access” on page 364

“Static members” on page 344

Member functions

Member functions are operators and functions that are declared as members of a class. Member functions do not include operators and functions declared with the friend specifier. These are called *friends* of a class. You can declare a member function as *static*; this is called a *static member function*. A member function that is not declared as *static* is called a *nonstatic member function*.

The definition of a member function is within the scope of its enclosing class. The body of a member function is analyzed after the class declaration so that members of that class can be used in the member function body, even if the member function definition appears before the declaration of that member in the class member list. When the function `add()` is called in the following example, the data variables `a`, `b`, and `c` can be used in the body of `add()`.

```
class x  
{  
public:  
    int add()           // inline member function add  
    {return a+b+c;};  
private:  
    int a,b,c;  
};
```

▶ C++11

You can use trailing return types for member functions, including those that have complicated return types. For more information, see “Trailing return type (C++11)” on page 266.

◀ C++11

Inline member functions

You may either define a member function inside its class definition, or you may define it outside if you have already declared (but not defined) the member function in the class definition.

A member function that is defined inside its class member list is called an *inline member function*. Member functions containing a few lines of code are usually declared inline. In the above example, `add()` is an inline member function. If you define a member function outside of its class definition, it must appear in a namespace scope enclosing the class definition. You must also qualify the member function name using the scope resolution (`::`) operator.

An equivalent way to declare an inline member function is to either declare it in the class with the `inline` keyword (and define the function outside of its class) or to define it outside of the class declaration using the `inline` keyword.

In the following example, member function `Y::f()` is an inline member function:

```
struct Y {
private:
    char* a;
public:
    char* f() { return a; }
};
```

The following example is equivalent to the previous example; `Y::f()` is an inline member function:

```
struct Y {
private:
    char* a;
public:
    char* f();
};

inline char* Y::f() { return a; }
```

The `inline` specifier does not affect the linkage of a member or nonmember function: linkage is external by default.

Member functions of a local class must be defined within their class definition. As a result, member functions of a local class are implicitly inline functions. These inline member functions have no linkage.

Constant and volatile member functions

A member function declared with the `const` qualifier can be called for constant and nonconstant objects. A nonconstant member function can only be called for a nonconstant object. Similarly, a member function declared with the `volatile` qualifier can be called for volatile and nonvolatile objects. A nonvolatile member function can only be called for a nonvolatile object.

Related reference:

“The `this` pointer” on page 341

Virtual member functions

Virtual member functions are declared with the keyword `virtual`. They allow dynamic binding of member functions. Because all virtual functions must be member functions, virtual member functions are simply called *virtual functions*.

If the definition of a virtual function is replaced by a pure specifier in the declaration of the function, the function is said to be declared pure. A class that has at least one pure virtual function is called an *abstract class*.

Related reference:

“Virtual functions” on page 377

“Abstract classes” on page 382

Special member functions

Special member functions are used to create, destroy, initialize, convert, and copy class objects. These include the following elements:

- Default constructors

- Destructors
- Copy constructors
- Copy assignment operators

For full descriptions of these functions, see Chapter 15, “Special member functions (C++ only),” on page 385.

Member scope

Member functions and static members can be defined outside their class declaration if they have already been declared, but not defined, in the class member list. Nonstatic data members are defined when an object of their class is created. The declaration of a static data member is not a definition. The declaration of a member function is a definition if the body of the function is also given.

Whenever the definition of a class member appears outside of the class declaration, the member name must be qualified by the class name using the `::` (scope resolution) operator.

The following example defines a member function outside of its class declaration.

```
#include <iostream>
using namespace std;

struct X {
    int a, b ;

    // member function declaration only
    int add();
};

// global variable
int a = 10;

// define member function outside its class declaration
int X::add() { return a + b; }

int main() {
    int answer;
    X xobject;
    xobject.a = 1;
    xobject.b = 2;
    answer = xobject.add();
    cout << xobject.a << " + " << xobject.b << " = " << answer << endl;
}
```

The output for this example is: 1 + 2 = 3

All member functions are in class scope even if they are defined outside their class declaration. In the above example, the member function `add()` returns the data member `a`, not the global variable `a`.

The name of a class member is local to its class. Unless you use one of the class access operators, `.` (dot), or `->` (arrow), or `::` (scope resolution) operator, you can only use a class member in a member function of its class and in nested classes. You can only use types, enumerations and static members in a nested class without qualification with the `::` operator.

The order of search for a name in a member function body is:

1. Within the member function body itself

2. Within all the enclosing classes, including inherited members of those classes
3. Within the lexical scope of the body declaration

The search of the enclosing classes, including inherited members, is demonstrated in the following example:

```
class A { /* ... */ };
class B { /* ... */ };
class C { /* ... */ };
class Z : A {
    class Y : B {
        class X : C { int f(); /* ... */ };
    };
};
int Z::Y::X f()
{
    char j;
    return 0;
}
```

In this example, the search for the name `j` in the definition of the function `f` follows this order:

1. In the body of the function `f`
2. In `X` and in its base class `C`
3. In `Y` and in its base class `B`
4. In `Z` and in its base class `A`
5. In the lexical scope of the body of `f`. In this case, this is global scope.

Note that when the containing classes are being searched, only the definitions of the containing classes and their base classes are searched. The scope containing the base class definitions (global scope, in this example) is not searched.

Pointers to members

Pointers to members allow you to refer to nonstatic members of class objects. You cannot use a pointer to member to point to a static class member because the address of a static member is not associated with any particular object. To point to a static class member, you must use a normal pointer.

You can use pointers to member functions in the same manner as pointers to functions. You can compare pointers to member functions, assign values to them, and use them to call member functions. Note that a member function does not have the same type as a nonmember function that has the same number and type of arguments and the same return type.

Pointers to members can be declared and used as shown in the following example:

```
#include <iostream>
using namespace std;

class X {
public:
    int a;
    void f(int b) {
        cout << "The value of b is " << b << endl;
    }
};

int main() {
```

```

// declare pointer to data member
int X::*ptiptr = &X::a;

// declare a pointer to member function
void (X::* ptfptr) (int) = &X::f;

// create an object of class type X
X xobject;

// initialize data member
xobject.*ptiptr = 10;

cout << "The value of a is " << xobject.*ptiptr << endl;

// call member function
(xobject.*ptfptr) (20);
}

```

The output for this example is:

```

The value of a is 10
The value of b is 20

```

To reduce complex syntax, you can declare a typedef to be a pointer to a member. A pointer to a member can be declared and used as shown in the following code fragment:

```

typedef int X::*my_pointer_to_member;
typedef void (X::*my_pointer_to_function) (int);

int main() {
    my_pointer_to_member ptiptr = &X::a;
    my_pointer_to_function ptfptr = &X::f;
    X xobject;
    xobject.*ptiptr = 10;
    cout << "The value of a is " << xobject.*ptiptr << endl;
    (xobject.*ptfptr) (20);
}

```

The pointer to member operators `.*` and `->*` are used to bind a pointer to a member of a specific class object. Because the precedence of `()` (function call operator) is higher than `.*` and `->*`, you must use parentheses to call the function pointed to by `ptf`.

Pointer-to-member conversion can occur when pointers to members are initialized, assigned, or compared. Note that pointer to a member is not the same as a pointer to an object or a pointer to a function.

The this pointer

The keyword `this` identifies a special type of pointer. Suppose that you create an object named `x` of class `A`, and class `A` has a nonstatic member function `f()`. If you call the function `x.f()`, the keyword `this` in the body of `f()` stores the address of `x`. You cannot declare the `this` pointer or make assignments to it.

A static member function does not have a `this` pointer.

The type of the `this` pointer for a member function of a class type `X`, is `X*`. If the member function is declared with the `const` qualifier, the type of the `this` pointer for that member function for class `X`, is `const X*`.

A `const` `this` pointer can be used only with `const` member functions. Data members of the class will be constant within that function. The function is still able to change the value, but requires a `const_cast` to do so:

```
void foo::p() const{
member = 1;                // illegal
const_cast <int&> (member) = 1; // a bad practice but legal
}
```

A better technique would be to declare member mutable.

If the member function is declared with the **volatile** qualifier, the type of the `this` pointer for that member function for class `X` is `volatile X* const`. For example, the compiler will not allow the following:

```
struct A {
    int a;
    int f() const { return a++; }
};
```

The compiler will not allow the statement `a++` in the body of function `f()`. In the function `f()`, the `this` pointer is of type `A* const`. The function `f()` is trying to modify part of the object to which `this` points.

The `this` pointer is passed as a hidden argument to all nonstatic member function calls and is available as a local variable within the body of all nonstatic functions.

For example, you can refer to the particular class object that a member function is called for by using the `this` pointer in the body of the member function. The following code example produces the output `a = 5`:

```
#include <iostream>
using namespace std;

struct X {
private:
    int a;
public:
    void Set_a(int a) {

        // The 'this' pointer is used to retrieve 'xobj.a'
        // hidden by the automatic variable 'a'
        this->a = a;
    }
    void Print_a() { cout << "a = " << a << endl; }
};

int main() {
    X xobj;
    int a = 5;
    xobj.Set_a(a);
    xobj.Print_a();
}
```

In the member function `Set_a()`, the statement `this->a = a` uses the `this` pointer to retrieve `xobj.a` hidden by the automatic variable `a`.

Unless a class member name is hidden, using the class member name is equivalent to using the class member name with the `this` pointer and the class member access operator (`->`).

The example in the first column of the following table shows code that uses class members without the `this` pointer. The code in the second column uses the variable `THIS` to simulate the first column's hidden use of the `this` pointer:

Code without using <code>this</code> pointer	Equivalent code, the <code>THIS</code> variable simulating the hidden use of the <code>this</code> pointer
<pre>#include <string> #include <iostream> using namespace std; struct X { private: int len; char *ptr; public: int GetLen() { return len; } char * GetPtr() { return ptr; } X& Set(char *); X& Cat(char *); X& Copy(X&); void Print(); }; X& X::Set(char *pc) { len = strlen(pc); ptr = new char[len]; strcpy(ptr, pc); return *this; } X& X::Cat(char *pc) { len += strlen(pc); strcat(ptr,pc); return *this; } X& X::Copy(X& x) { Set(x.GetPtr()); return *this; } void X::Print() { cout << ptr << endl; } int main() { X xobj1; xobj1.Set("abcd") .Cat("efgh"); xobj1.Print(); X xobj2; xobj2.Copy(xobj1) .Cat("ijkl"); xobj2.Print(); }</pre>	<pre>#include <string> #include <iostream> using namespace std; struct X { private: int len; char *ptr; public: int GetLen (X* const THIS) { return THIS->len; } char * GetPtr (X* const THIS) { return THIS->ptr; } X& Set(X* const, char *); X& Cat(X* const, char *); X& Copy(X* const, X&); void Print(X* const); }; X& X::Set(X* const THIS, char *pc) { THIS->len = strlen(pc); THIS->ptr = new char[THIS->len]; strcpy(THIS->ptr, pc); return *THIS; } X& X::Cat(X* const THIS, char *pc) { THIS->len += strlen(pc); strcat(THIS->ptr, pc); return *THIS; } X& X::Copy(X* const THIS, X& x) { THIS->Set(THIS, x.GetPtr(&x)); return *THIS; } void X::Print(X* const THIS) { cout << THIS->ptr << endl; } int main() { X xobj1; xobj1.Set(&xobj1 , "abcd") .Cat(&xobj1 , "efgh"); xobj1.Print(&xobj1); X xobj2; xobj2.Copy(&xobj2 , xobj1) .Cat(&xobj2 , "ijkl"); xobj2.Print(&xobj2); }</pre>

Both examples produce the following output:

```
abcdefgh
abcdefghijkl
```

Related reference:

“Overloading assignments” on page 312

“Copy constructors” on page 406

Static members

Class members can be declared using the storage class specifier `static` in the class member list. Only one copy of the static member is shared by all objects of a class in a program. When you declare an object of a class having a static member, the static member is not part of the class object.

A typical use of static members is for recording data common to all objects of a class. For example, you can use a static data member as a counter to store the number of objects of a particular class type that are created. Each time a new object is created, this static data member can be incremented to keep track of the total number of objects.

You access a static member by qualifying the class name using the `::` (scope resolution) operator. In the following example, you can refer to the static member `f()` of class type `X` as `X::f()` even if no object of type `X` is ever declared:

```
struct X {
    static int f();
};

int main() {
    X::f();
}
```

Related reference:

“Constant and volatile member functions” on page 338

“Class member lists” on page 335

Using the class access operators with static members

You do not have to use the class member access syntax to refer to a static member; to access a static member `s` of class `X`, you could use the expression `X::s`. The following example demonstrates accessing a static member:

```
#include <iostream>
using namespace std;

struct A {
    static void f() { cout << "In static function A::f()" << endl; }
};

int main() {

    // no object required for static member
    A::f();

    A a;
    A* ap = &a;
    a.f();
    ap->f();
}
```

The three statements `A::f()`, `a.f()`, and `ap->f()` all call the same static member function `A::f()`.

You can directly refer to a static member in the same scope of its class, or in the scope of a class derived from the static member's class. The following example demonstrates the latter case (directly referring to a static member in the scope of a class derived from the static member's class):

```
#include <iostream>
using namespace std;

int g() {
    cout << "In function g()" << endl;
    return 0;
}

class X {
public:
    static int g() {
        cout << "In static member function X::g()" << endl;
        return 1;
    }
};

class Y: public X {
public:
    static int i;
};

int Y::i = g();

int main() { }
```

See the following output of the above code:

```
In static member function X::g()
```

The initialization `int Y::i = g()` calls `X::g()`, not the function `g()` declared in the global namespace.

Related reference:

“The static storage class specifier” on page 55

“Scope resolution operator `::` (C++ only)” on page 166

“Dot operator `.`” on page 168

“Arrow operator `->`” on page 169

Static data members

The declaration of a static data member in the member list of a class is not a definition. You must define the static member outside of the class declaration, in namespace scope. For example:

```
class X
{
public:
    static int i;
};
int X::i = 0; // definition outside class declaration
```

Once you define a static data member, it exists even though no objects of the static data member's class exist. In the above example, no objects of class `X` exist even though the static data member `X::i` has been defined.

Static data members of a class in namespace scope have external linkage. The initializer for a static data member is in the scope of the class declaring the member.

A static data member can be of any type except for `void` or `void` qualified with `const` or `volatile`. You cannot declare a static data member as `mutable`.

You can only have one definition of a static member in a program. Unnamed classes, classes contained within unnamed classes, and local classes cannot have static data members.

Static data members and their initializers can access other static private and protected members of their class. The following example shows how you can initialize static members using other static members, even though these members are private:

```
class C {
    static int i;
    static int j;
    static int k;
    static int l;
    static int m;
    static int n;
    static int p;
    static int q;
    static int r;
    static int s;
    static int f() { return 0; }
    int a;
public:
    C() { a = 0; }
};

C c;
int C::i = C::f();    // initialize with static member function
int C::j = C::i;     // initialize with another static data member
int C::k = c.f();    // initialize with member function from an object
int C::l = c.j;     // initialize with data member from an object
int C::s = c.a;     // initialize with nonstatic data member
int C::r = 1;       // initialize with a constant value

class Y : private C { } y;

int C::m = Y::f();   // error
int C::n = Y::r;    // error
int C::p = y.r;     // error
int C::q = y.f();   // error
```

The initialization of `C::m`, `C::n`, `C::p`, and `C::q` causes errors because the values used to initialize them are private members of class `Y` which can not be accessed.

If a static data member is of a `const` integral or `const` enumeration type, you can specify a *constant initializer* in the static data member's declaration. This constant initializer must be an integral constant expression.

► C++11 A static data member of a literal type can be declared with the `constexpr` specifier in the class definition, and the data member declaration must specify a constant initializer. For example:

```
struct Constants {
    static constexpr int bounds[] = { 42, 56 };
};

float a[Constants::bounds[0]][Constants::bounds[1]];
```

◀ C++11

Note that the constant initializer is not a definition. You still need to define the static member in an enclosing namespace. The following example demonstrates this:

```
#include <iostream>
using namespace std;

struct X {
    static const int a = 76;
};

const int X::a;

int main() {
    cout << X::a << endl;
}
```

The tokens = 76 at the end of the declaration of static data member a is a constant initializer.

Related reference:

“External linkage” on page 12

“Member access” on page 349

“Local classes” on page 332

Static member functions

You cannot have static and nonstatic member functions with the same names and the same number and type of arguments.

Like static data members, you may access a static member function f() of a class A without using an object of class A.

A static member function does not have a this pointer. The following example demonstrates this:

```
#include <iostream>
using namespace std;

struct X {
private:
    int i;
    static int si;
public:
    void set_i(int arg) { i = arg; }
    static void set_si(int arg) { si = arg; }

    void print_i() {
        cout << "Value of i = " << i << endl;
        cout << "Again, value of i = " << this->i << endl;
    }

    static void print_si() {
        cout << "Value of si = " << si << endl;
        cout << "Again, value of si = " << this->si << endl; // error
    }
};

int X::si = 77;        // Initialize static data member

int main() {
    X xobj;
    xobj.set_i(11);
    xobj.print_i();
}
```

```

    // static data members and functions belong to the class and
    // can be accessed without using an object of class X
    X::print_si();
    X::set_si(22);
    X::print_si();
}

```

The following is the output of the above example:

```

Value of i = 11
Again, value of i = 11
Value of si = 77
Value of si = 22

```

The compiler does not allow the member access operation `this->si` in function `A::print_si()` because this member function has been declared as static, and therefore does not have a `this` pointer.

You can call a static member function using the `this` pointer of a nonstatic member function. In the following example, the nonstatic member function `printall()` calls the static member function `f()` using the `this` pointer:

```

#include <iostream>
using namespace std;

class C {
    static void f() {
        cout << "Here is i: " << i << endl;
    }
    static int i;
    int j;
public:
    C(int firstj): j(firstj) { }
    void printall();
};

void C::printall() {
    cout << "Here is j: " << this->j << endl;
    this->f();
}

int C::i = 3;

int main() {
    C obj_C(0);
    obj_C.printall();
}

```

The following is the output of the above example:

```

Here is j: 0
Here is i: 3

```

A static member function cannot be declared with the keywords `virtual`, `const`, `volatile`, or `const volatile`.

A static member function can access only the names of static members, enumerators, and nested types of the class in which it is declared. Suppose a static member function `f()` is a member of class `X`. The static member function `f()` cannot access the nonstatic members `X` or the nonstatic members of a base class of `X`.

Related reference:

“The `this` pointer” on page 341

Member access

Member access determines if a class member is accessible in an expression or declaration. Suppose x is a member of class A. Class member x can be declared to have one of the following levels of accessibility:

- **public:** x can be used anywhere without the access restrictions defined by `private` or `protected`.
- **private:** x can be used only by the members and friends of class A.
- **protected:** x can be used only by the members and friends of class A, and the members and friends of classes derived from class A.

Members of classes declared with the keyword `class` are `private` by default. Members of classes declared with the keyword `struct` or `union` are `public` by default.

To control the access of a class member, you use one of the *access specifiers* `public`, `private`, or `protected` as a label in a class member list. The following example demonstrates these access specifiers:

```
struct A {
    friend class C;
private:
    int a;
public:
    int b;
protected:
    int c;
};

struct B : A {
    void f() {
        // a = 1;
        b = 2;
        c = 3;
    }
};

struct C {
    void f(A x) {
        x.a = 4;
        x.b = 5;
        x.c = 6;
    }
};

int main() {
    A y;
    // y.a = 7;
    y.b = 8;
    // y.c = 9;

    B z;
    // z.a = 10;
    z.b = 11;
    // z.c = 12;
}
```

The following table lists the access of data members `A::a`, `A::b`, and `A::c` in various scopes of the above example.

Scope	A::a	A::b	A::c
function B::f()	No access. Member A::a is private.	Access. Member A::b is public.	Access. Class B inherits from A.
function C::f()	Access. Class C is a friend of A.	Access. Member A::b is public.	Access. Class C is a friend of A.
object y in main()	No access. Member y.a is private.	Access. Member y.a is public.	No access. Member y.c is protected.
object z in main()	No access. Member z.a is private.	Access. Member z.a is public.	No access. Member z.c is protected.

An access specifier specifies the accessibility of members that follow it until the next access specifier or until the end of the class definition. You can use any number of access specifiers in any order. If you later define a class member within its class definition, its access specification must be the same as its declaration. The following example demonstrates this:

```
class A {
    class B;
    public:
        class B { };
};
```

The compiler will not allow the definition of class B because this class has already been declared as private.

A class member has the same access control regardless whether it has been defined within its class or outside its class.

Access control applies to names. In particular, if you add access control to a typedef name, it affects only the typedef name. The following example demonstrates this:

```
class A {
    class B { };
    public:
        typedef B C;
};

int main() {
    A::C x;
    // A::B y;
}
```

The compiler will allow the declaration `A::C x` because the typedef name `A::C` is public. The compiler would not allow the declaration `A::B y` because `A::B` is private.

Note that accessibility and visibility are independent. Visibility is based on the scoping rules of C++. A class member can be visible and inaccessible at the same time.

Related reference:

“Scope” on page 6

“Class member lists” on page 335

“Inherited member access” on page 364

Friends

A friend of a class X is a function or class that is not a member of X , but is granted the same access to X as the members of X . Functions declared with the friend specifier in a class member list are called *friend functions* of that class. Classes declared with the friend specifier in the member list of another class are called *friend classes* of that class.

A class Y must be defined before any member of Y can be declared a friend of another class. In the following example, the friend function `print` is a member of class Y and accesses the private data members `a` and `b` of class X .

```
#include <iostream>
using namespace std;

class X;

class Y {
public:
    void print(X& x);
};

class X {
    int a, b;
    friend void Y::print(X& x);
public:
    X() : a(1), b(2) { }
};

void Y::print(X& x) {
    cout << "a is " << x.a << endl;
    cout << "b is " << x.b << endl;
}

int main() {
    X xobj;
    Y yobj;
    yobj.print(xobj);
}
```

See the output of the above example:

```
a is 1
b is 2
```

You can declare an entire class as a friend. Suppose class F is a friend of class A . This means that every member function and static data member definition of class F has access to class A .

In the following example, the friend class F has a member function `print` that accesses the private data members `a` and `b` of class X and performs the same task as the friend function `print` in the above example. Any other members declared in class F also have access to all members of class X .

```
#include <iostream>
using namespace std;

class X {
    int a, b;
    friend class F;
public:
    X() : a(1), b(2) { }
};

class F {
```

```

public:
    void print(X& x) {
        cout << "a is " << x.a << endl;
        cout << "b is " << x.b << endl;
    }
};

int main() {
    X xobj;
    F fobj;
    fobj.print(xobj);
}

```

See the output of the above example:

```

a is 1
b is 2

```

You cannot define a class in a friend declaration. For example, the compiler does not accept the following code:

```

class F;
class X {
    friend class F { };
};

```

However, you can define a function in a friend declaration. The class must be a non-local class. The function must have namespace scope, and the function name must be unqualified. The following example demonstrates this:

```

class A {
    void g();
};

void z() {
    class B {
        friend void f() { }; // error
    };
}

class C {
    friend void A::g() { } // error
    friend void h() { }
};

```

The compiler accepts the definition of `h()`, but not the function definition of `f()` or `g()`.

You cannot declare a friend with a storage class specifier.

▶ C++11

Extended friend declarations

Note: IBM supports selected features of C++11, known as C++0x before its ratification. IBM will continue to develop and implement the features of this standard. The implementation of the language level is based on IBM's interpretation of the standard. Until IBM's implementation of all the C++11 features is complete, including the support of a new C++11 standard library, the implementation might change from release to release. IBM makes no attempt to maintain compatibility, in source, binary, or listings and other compiler interfaces,

with earlier releases of IBM's implementation of the new C++11 features. In the C++11 standard, the *extended friend declarations* feature accepts additional forms of non-function friend declarations.

Note: The syntactic form of extended friend declarations overlaps with the IBM old friend declaration syntax. This section is focused on the differences between the C++11 standard and the previous ISO C++ standard.

With this feature enabled, the class-key is no longer required in the context of friend declarations. This new syntax differs from the C++98 friend class declaration syntax, where the class-key is necessary as part of an elaborated-type-specifier. See the following example:

```
class F;
class G;

class X1 {
    //C++98 friend declarations remain valid in C++11.
    friend class F;

    //Error in C++98 for missing the class-key.
    friend G;
};

class X2 {
    //Error in C++98 for missing the class-key.
    //Error in C++11 for lookup failure (no previous class D declaration).
    friend D;

    friend class D;
};
```

In addition to functions and classes, you can also declare template parameters and basic types as friends. In this case, you cannot use an elaborated-type-specifier in the friend declaration. In the following example, you can declare the template parameter T as a friend of class F, and you can use the basic type char in friend declarations.

```
class C;

template <typename T, typename U> class F {
    //C++11 compiles successfully.
    //Error in C++98 for missing the class-key.
    friend T;

    //Error in both C++98 and C++11: a template parameter
    //must not be used in an elaborated type specifier.
    friend class U;
};

F<C> rc;
F<char> Ri;
```

You can also declare typedef names as friends, but you still cannot use an elaborated-type-specifier in the friend declaration. The following example demonstrates that the typedef name D is declared as a friend of class Base.

```
class Derived;
typedef Derived D;

class C;
typedef C Ct;

class Base{
```

```

public:
    Base() : x(55) {}

    //C++11 compiles successfully.
    //Error in C++98 for missing the class-key.
    friend D;

    //Error in both C++98 and C++11: a typedef name
    //must not be used in an elaborated type specifier.
    friend class Ct;

private:
    int x;
};

struct Derived : public Base {
    int foo() { return this->x; }
};

int main() {
    Derived d;
    return d.foo();
}

```

This feature also introduces a new name lookup rule for friend declarations. If a friend class declaration does not use an elaborated-type-specifier, then the compiler also looks for the entity name in scopes outside the innermost namespace that encloses the friend declaration. Consider the following example:

```

struct T { };

namespace N {
    struct A {
        friend T;
    };
}

```

In this example, if this feature is in effect, the friend declaration statement does not declare a new entity `T`, but looks for `T`. If there is no `T` found, then the compiler issues an error. Consider another example:

```

struct T { };

namespace N {
    struct A {
        friend class T; //fine, no error
    };
}

```

In this example, the friend declaration statement does not look for `T` outside namespace `N`, nor does it find `::T`. Instead, this statement declares a new class `T` in namespace `N`.

C++11 <

Related reference:

- “Static member functions” on page 347
- “The inline function specifier” on page 256
- “Local classes” on page 332
- “Member access” on page 349
- “Inherited member access” on page 364
- “C++11 compatibility” on page 519

Friend scope

The name of a friend function or class first introduced in a friend declaration is not in the scope of the class granting friendship (also called the *enclosing class*) and is not a member of the class granting friendship.

The name of a function first introduced in a friend declaration is in the scope of the first nonclass scope that contains the enclosing class. The body of a function provided inside a friend declaration is handled in the same way as a member function defined within a class. Processing of the definition does not start until the end of the outermost enclosing class. In addition, unqualified names in the body of the function definition are searched for starting from the class containing the function definition.

A friend class name first introduced by a friend declaration is considered to belong to the first nonclass enclosing scope. Until a matching declaration is provided in that scope, the class name is not found by name lookup. For example:

```
namespace A { //the first nonclass scope
    class B {
        class C {
            friend class D;
        }
    };
};
```

In this example, the first nonclass scope that encloses the friend declaration of class D is namespace A, so friend class D is in the scope of namespace A.

If the name of a friend class has been introduced before the friend declaration, the compiler searches for a class name that matches the name of the friend class beginning at the scope of the friend declaration. If the declaration of a nested class is followed by the declaration of a friend class with the same name, the nested class is a friend of the enclosing class.

If the friend function is a member of another class, you need to use the scope resolution operator (`::`). For example:

```
class A {
public:
    int f() { }
};

class B {
    friend int A::f();
};
```

Friends of a base class are not inherited by any classes derived from that base class. The following example demonstrates this:

```
class A {
    friend class B;
    int a;
};

class B { };

class C : public B {
    void f(A* p) {
        p->a = 2; // error
    }
};
```

The compiler does not support the statement `p->a = 2` because class C is not a friend of class A, although C inherits from a friend of A.

Friendship is not transitive. The following example demonstrates this:

```
class A {
    friend class B;
    int a;
};

class B {
    friend class C;
};

class C {
    void f(A* p) {
        p->a = 2; // error
    }
};
```

The compiler does not accept the statement `p->a = 2` because class C is not a friend of class A, although C is a friend of a friend of A.

If you declare a friend in a local class, and the friend name is unqualified, the compiler looks for the name only within the innermost enclosing nonclass scope. You must declare a function before declaring it as a friend of a local scope class. You do not have to do so with classes. The following example demonstrates this:

```
class X { };
void a();

void f() {
    class Y { };
    void b();
    class A {
        friend class X;
        friend class Y;
        friend class Z;
        friend void a(); // error
        friend void b();
        friend void c(); // error
    };
    ::X moocow;
    X moocow2;
}
```

In the above example, the compiler accepts the following statements:

- `friend class X`: This statement does not declare `::X` as a friend of A, but the local class X as a friend, even though this class is not otherwise declared.
- `friend class Y`: Local class Y has been declared in the scope of `f()`.
- `friend class Z`: This statement declares the local class Z as a friend of A even though Z is not otherwise declared.
- `friend void b()`: Function `b()` has been declared in the scope of `f()`.
- `::X moocow`: This declaration creates an object of the nonlocal class `::X`.
- `X moocow2`: This declaration also creates an object of the nonlocal class `::X`.

The compiler does not accept the following statements:

- `friend void a()`: This statement does not consider function `a()` declared in namespace scope. Since function `a()` has not been declared in the scope of `f()`, the compiler does not accept this statement.

- `friend void c();` Since function `c()` has not been declared in the scope of `f()`, the compiler does not accept this statement.

Related reference:

“Scope of class names” on page 329

“Nested classes” on page 330

“Local classes” on page 332

Friend access

A friend of a class can access the private and protected members of that class. Normally, you can only access the private members of a class through member functions of that class, and you can only access the protected members of a class through member functions of a class or classes derived from that class.

Friend declarations are not affected by access specifiers.

Related reference:

“Member access” on page 349

Chapter 14. Inheritance (C++ only)

Inheritance is a mechanism of reusing and extending existing classes without modifying them, thus producing hierarchical relationships between them.

Inheritance is almost like embedding an object into a class. Suppose that you declare an object *x* of class *A* in the class definition of *B*. As a result, class *B* will have access to all the public data members and member functions of class *A*. However, in class *B*, you have to access the data members and member functions of class *A* through object *x*. The following example demonstrates this:

```
#include <iostream>
using namespace std;

class A {
    int data;
public:
    void f(int arg) { data = arg; }
    int g() { return data; }
};

class B {
public:
    A x;
};

int main() {
    B obj;
    obj.x.f(20);
    cout << obj.x.g() << endl;
    // cout << obj.g() << endl;
}
```

In the main function, object *obj* accesses function *A::f()* through its data member *B::x* with the statement *obj.x.f(20)*. Object *obj* accesses *A::g()* in a similar manner with the statement *obj.x.g()*. The compiler would not allow the statement *obj.g()* because *g()* is a member function of class *A*, not class *B*.

The inheritance mechanism lets you use a statement like *obj.g()* in the above example. In order for that statement to be legal, *g()* must be a member function of class *B*.

Inheritance lets you include the names and definitions of another class's members as part of a new class. The class whose members you want to include in your new class is called a *base class*. Your new class is *derived* from the base class. The new class contains a *subobject* of the type of the base class. The following example is the same as the previous example except it uses the inheritance mechanism to give class *B* access to the members of class *A*:

```
#include <iostream>
using namespace std;

class A {
    int data;
public:
    void f(int arg) { data = arg; }
    int g() { return data; }
};
```

```

class B : public A { };

int main() {
    B obj;
    obj.f(20);
    cout << obj.g() << endl;
}

```

Class A is a base class of class B. The names and definitions of the members of class A are included in the definition of class B; class B inherits the members of class A. Class B is derived from class A. Class B contains a subobject of type A.

You can also add new data members and member functions to the derived class. You can modify the implementation of existing member functions or data by overriding base class member functions or data in the newly derived class.

You may derive classes from other derived classes, thereby creating another level of inheritance. The following example demonstrates this:

```

struct A { };
struct B : A { };
struct C : B { };

```

Class B is a derived class of A, but is also a base class of C. The number of levels of inheritance is only limited by resources.

Multiple inheritance allows you to create a derived class that inherits properties from more than one base class. Because a derived class inherits members from all its base classes, ambiguities can result. For example, if two base classes have a member with the same name, the derived class cannot implicitly differentiate between the two members. Note that, when you are using multiple inheritance, the access to names of base classes may be ambiguous. See “Multiple inheritance” on page 370 for more detailed information.

A *direct base class* is a base class that appears directly as a base specifier in the declaration of its derived class.

An *indirect base class* is a base class that does not appear directly in the declaration of the derived class but is available to the derived class through one of its base classes. For a given class, all base classes that are not direct base classes are indirect base classes. The following example demonstrates direct and indirect base classes:

```

class A {
public:
    int x;
};
class B : public A {
public:
    int y;
};
class C : public B { };

```

Class B is a direct base class of C. Class A is a direct base class of B. Class A is an indirect base class of C. (Class C has x and y as its data members.)

Polymorphic functions are functions that can be applied to objects of more than one type. In C++, polymorphic functions are implemented in two ways:

- Overloaded functions are statically bound at compile time.

- C++ provides virtual functions. A *virtual function* is a function that can be called for a number of different user-defined types that are related through derivation. Virtual functions are bound dynamically at run time. They are described in more detail in “Virtual functions” on page 377.

Derivation

Inheritance is implemented in C++ through the mechanism of derivation. Derivation allows you to derive a class, called a *derived class*, from another class, called a *base class*.

Derived class syntax

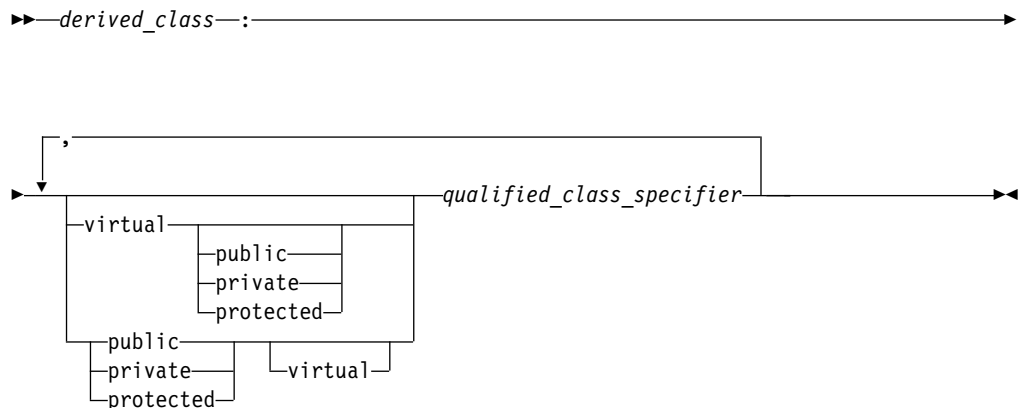

In the declaration of a derived class, you list the base classes of the derived class. The derived class inherits its members from these base classes.

The *qualified_class_specifier* must be a class that has been previously declared in a class declaration.

An *access specifier* is one of `public`, `private`, or `protected`.

The `virtual` keyword can be used to declare virtual base classes.

The following example shows the declaration of the derived class `D` and the base classes `V`, `B1`, and `B2`. The class `B1` is both a base class and a derived class because it is derived from class `V` and is a base class for `D`:

```
class V { /* ... */ };
class B1 : virtual public V { /* ... */ };
class B2 { /* ... */ };
class D : public B1, private B2 { /* ... */ };
```

Classes that are declared but not defined are not allowed in base lists.

For example:

```
class X;

// error
class Y: public X { };
```

The compiler will not allow the declaration of class `Y` because `X` has not been defined.

When you derive a class, the derived class inherits nonstatic data members of the base class. You can refer to inherited members (base class members) as if they were members of the derived class. The derived class can also add new class members. For example:

```
class Base {
public:
    int a,b;
};

class Derived : public Base {
public:
    int c;
};

int main() {
    Derived d;
    d.a = 1;    // Base::a
    d.b = 2;    // Base::b
    d.c = 3;    // Derived::c
}
```

In the above example, the two inherited members, *a* and *b*, of the derived class *d*, in addition to the derived class member *c*, are assigned values.

The derived class can also declare class members with the same name as existing base class members. You can refer to the base class members by using the `::` (scope resolution) operator. For example:

```
#include <iostream>
using namespace std;

class Base {
public:
    char* name;
    void display() {
        cout << name << endl;
    }
};

class Derived: public Base {
public:
    char* name;
    void display() {
        cout << name << ", " << Base::name << endl;
    }
};

int main() {
    Derived d;
    d.name = "Derived Class";
    d.Base::name = "Base Class";

    // call Derived::display()
    d.display();

    // call Base::display()
    d.Base::display();
}
```

The following is the output of the above example:

```
Derived Class, Base Class
Base Class
```

You can manipulate a derived class object as if it were a base class object. You can use a pointer or a reference to a derived class object in place of a pointer or reference to its base class. For example, you can pass a pointer or reference to a derived class object D to a function expecting a pointer or reference to the base class of D. You do not need to use an explicit cast to achieve this; a standard conversion is performed. You can implicitly convert a pointer to a derived class to point to an accessible unambiguous base class. You can also implicitly convert a reference to a derived class to a reference to a base class.

The following example demonstrates a standard conversion from a pointer to a derived class to a pointer to a base class:

```
#include <iostream>
using namespace std;

class Base {
public:
    char* name;
    void display() {
        cout << name << endl;
    }
};

class Derived: public Base {
public:
    char* name;
    void display() {
        cout << name << ", " << Base::name << endl;
    }
};

int main() {
    Derived d;
    d.name = "Derived Class";
    d.Base::name = "Base Class";

    Derived* dptr = &d;

    // standard conversion from Derived* to Base*
    Base* bptr = dptr;

    // call Base::display()
    bptr->display();
}
```

The following is the output of the above example:

```
Base Class
```

The statement `Base* bptr = dptr` converts a pointer of type `Derived` to a pointer of type `Base`.

The reverse case is not allowed. You cannot implicitly convert a pointer or a reference to a base class object to a pointer or reference to a derived class. For example, the compiler will not allow the following code if the classes `Base` and `Class` are defined as in the above example:

```
int main() {
    Base b;
    b.name = "Base class";

    Derived* dptr = &b;
}
```

The compiler will not allow the statement `Derived* dptr = &b` because the statement is trying to implicitly convert a pointer of type `Base` to a pointer of type `Derived`.

If a member of a derived class has the same name as a base class, the base class name is hidden in the derived class.

Related reference:

“Virtual base classes” on page 371

“Inherited member access”

“Incomplete class declarations” on page 330

“Scope resolution operator `::` (C++ only)” on page 166

Inherited member access

The following sections discuss the access rules affecting a protected nonstatic base class member and how to declare a derived class using an access specifier:

- “Protected members”
- “Access control of base class members” on page 365

Related reference:

“Member access” on page 349

Protected members

A protected nonstatic base class member can be accessed by members and friends of any classes derived from that base class by using one of the following:

- A pointer to a directly or indirectly derived class
- A reference to a directly or indirectly derived class
- An object of a directly or indirectly derived class

If a class is derived privately from a base class, all protected base class members become private members of the derived class.

If you reference a protected nonstatic member `x` of a base class `A` in a friend or a member function of a derived class `B`, you must access `x` through a pointer to, reference to, or object of a class derived from `A`. However, if you are accessing `x` to create a pointer to member, you must qualify `x` with a nested name specifier that names the derived class `B`. The following example demonstrates this:

```
class A {
public:
protected:
    int i;
};

class B : public A {
    friend void f(A*, B*);
    void g(A*);
};

void f(A* pa, B* pb) {
    // pa->i = 1;
    pb->i = 2;

    // int A::* point_i = &A::i;
    int A::* point_i2 = &B::i;
}
```

```

void B::g(A* pa) {
// pa->i = 1;
    i = 2;

// int A::* point_i = &A::i;
    int A::* point_i2 = &B::i;
}

void h(A* pa, B* pb) {
// pa->i = 1;
// pb->i = 2;
}

int main() { }

```

Class A contains one protected data member, an integer `i`. Because B derives from A, the members of B have access to the protected member of A. Function `f()` is a friend of class B:

- The compiler would not allow `pa->i = 1` because `pa` is not a pointer to the derived class B.
- The compiler would not allow `int A::* point_i = &A::i` because `i` has not been qualified with the name of the derived class B.

Function `g()` is a member function of class B. The previous list of remarks about which statements the compiler would and would not allow apply for `g()` except for the following:

- The compiler allows `i = 2` because it is equivalent to `this->i = 2`.

Function `h()` cannot access any of the protected members of A because `h()` is neither a friend or a member of a derived class of A.

Access control of base class members

When you declare a derived class, an access specifier can precede each base class in the base list of the derived class. This does not alter the access attributes of the individual members of a base class as seen by the base class, but allows the derived class to restrict the access control of the members of a base class.

You can derive classes using any of the three access specifiers:

- In a `public` base class, `public` and `protected` members of the base class remain `public` and `protected` members of the derived class.
- In a `protected` base class, `public` and `protected` members of the base class are `protected` members of the derived class.
- In a `private` base class, `public` and `protected` members of the base class become `private` members of the derived class.

In all cases, `private` members of the base class remain `private`. `Private` members of the base class cannot be used by the derived class unless friend declarations within the base class explicitly grant access to them.

In the following example, class D is derived publicly from class B. Class B is declared a `public` base class by this declaration.

```

class B { };
class D : public B // public derivation
{ };

```

You can use both a structure and a class as base classes in the base list of a derived class declaration:

- If the derived class is declared with the keyword `class`, the default access specifier in its base list specifiers is `private`.
- If the derived class is declared with the keyword `struct`, the default access specifier in its base list specifiers is `public`.

See the following example:

```
struct B{
};

class D : B {          // private derivation
};

struct E : B{         // public derivation
};
```

Members and friends of a class can implicitly convert a pointer to an object of that class to a pointer to either:

- A direct private base class
- A protected base class (either direct or indirect)

Related reference:

“Member access” on page 349

“Member scope” on page 339

The using declaration and class members

A `using` declaration in a definition of a class `A` allows you to introduce a *name* of a data member or member function from a base class of `A` into the scope of `A`.

You would need a `using` declaration in a class definition if you want to create a set of member functions from base and derived classes, or you want to change the access of a class member.

using declaration syntax

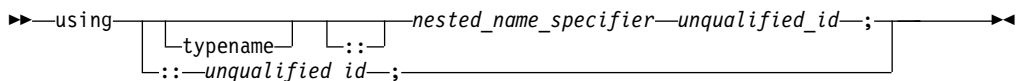

A `using` declaration in a class `A` may name one of the following options:

- A member of a base class of `A`
- A member of an anonymous union that is a member of a base class of `A`
- An enumerator for an enumeration type that is a member of a base class of `A`

The following example demonstrates this:

```
struct Z {
    int g();
};

struct A {
    void f();
    enum E { e };
    union { int u; };
};

struct B : A {
    using A::f;
```



```

    using A::e;
    using A::u;
    // using Z::g;
};

```

The compiler would not allow the using declaration `using Z::g` because `Z` is not a base class of `A`.

A using declaration cannot name a template. For example, the compiler will not allow the following:

```

struct A {
    template<class T> void f(T);
};

struct B : A {
    using A::f<int>;
};

```

Every instance of the name mentioned in a using declaration must be accessible. The following example demonstrates this:

```

struct A {
private:
    void f(int);
public:
    int f();
protected:
    void g();
};

struct B : A {
    // using A::f;
    using A::g;
};

```

The compiler would not allow the using declaration `using A::f` because `void A::f(int)` is not accessible from `B` even though `int A::f()` is accessible.

Related reference:

“Scope of class names” on page 329

“The using declaration and namespaces” on page 298

Overloading member functions from base and derived classes

A member function named `f` in a class `A` will hide all other members named `f` in the base classes of `A`, regardless of return types or arguments. The following example demonstrates this:

```

struct A {
    void f() { }
};

struct B : A {
    void f(int) { }
};

int main() {
    B obj_B;
    obj_B.f(3);
    // obj_B.f();
}

```

The compiler would not allow the function call `obj_B.f()` because the declaration of `void B::f(int)` has hidden `A::f()`.

To overload, rather than hide, a function of a base class A in a derived class B, you introduce the name of the function into the scope of B with a using declaration. The following example is the same as the previous example except for the using declaration using A::f:

```
struct A {
    void f() { }
};

struct B : A {
    using A::f;
    void f(int) { }
};

int main() {
    B obj_B;
    obj_B.f(3);
    obj_B.f();
}
```

Because of the using declaration in class B, the name f is overloaded with two functions. The compiler will now allow the function call obj_B.f().

Suppose that you introduce a function f from a base class A into a derived class B with a using declaration, and there exists a function named B::f that has the same parameter types as A::f. Function B::f will hide, rather than conflict with, function A::f. The following example demonstrates this:

```
#include <iostream>
using namespace std;

struct A {
    void f() { }
    void f(int) { cout << "void A::f(int)" << endl; }
};

struct B : A {
    using A::f;
    void f(int) { cout << "void B::f(int)" << endl; }
};

int main() {
    B obj_B;
    obj_B.f(3);
}
```

See the following output of the above example:

```
void B::f(int)
```

You can overload virtual functions with a using declaration. For example:

```
#include <iostream>
using namespace std;

struct A {
    virtual void f() { cout << "void A::f()" << endl; }
    virtual void f(int) { cout << "void A::f(int)" << endl; }
};

struct B : A {
    using A::f;
    void f(int) { cout << "void B::f(int)" << endl; }
};

int main() {
```

```

    B obj_B;
    A* pa = &obj_B;
    pa->f(3);
    pa->f();
}

```

In this example, `B::f(int)` is a virtual function and overrides `A::f(int)` even with the `using A::f;` declaration. The output is as below:

```

void B::f(int)
void A::f()

```

Related reference:

Chapter 11, “Overloading (C++ only),” on page 305

“Name hiding (C++ only)” on page 10

“The using declaration and class members” on page 366

Changing the access of a class member

Suppose class B is a direct base class of class A. To restrict access of class B to the members of class A, derive B from A using either the access specifiers `protected` or `private`.

To increase the access of a member `x` of class A inherited from class B, use a `using` declaration. You cannot restrict the access to `x` with a `using` declaration. You may increase the access of the following members:

- A member inherited as `private`. (You cannot increase the access of a member declared as `private` because a `using` declaration must have access to the member's name.)
- A member either inherited or declared as `protected`

The following example demonstrates this:

```

struct A {
protected:
    int y;
public:
    int z;
};

struct B : private A { };

struct C : private A {
public:
    using A::y;
    using A::z;
};

struct D : private A {
protected:
    using A::y;
    using A::z;
};

struct E : D {
    void f() {
        y = 1;
        z = 2;
    }
};

struct F : A {
public:
    using A::y;

```

```

private:
    using A::z;
};

int main() {
    B obj_B;
    // obj_B.y = 3;
    // obj_B.z = 4;

    C obj_C;
    obj_C.y = 5;
    obj_C.z = 6;

    D obj_D;
    // obj_D.y = 7;
    // obj_D.z = 8;

    F obj_F;
    obj_F.y = 9;
    obj_F.z = 10;
}

```

The compiler would not allow the following assignments from the above example:

- `obj_B.y = 3` and `obj_B.z = 4`: Members `y` and `z` have been inherited as private.
- `obj_D.y = 7` and `obj_D.z = 8`: Members `y` and `z` have been inherited as private, but their access have been changed to protected.

The compiler allows the following statements from the above example:

- `y = 1` and `z = 2` in `D::f()`: Members `y` and `z` have been inherited as private, but their access have been changed to protected.
- `obj_C.y = 5` and `obj_C.z = 6`: Members `y` and `z` have been inherited as private, but their access have been changed to public.
- `obj_F.y = 9`: The access of member `y` has been changed from protected to public.
- `obj_F.z = 10`: The access of member `z` is still public. The private using declaration using `A::z` has no effect on the access of `z`.

Related reference:

“Member access” on page 349

“Inherited member access” on page 364

Multiple inheritance

You can derive a class from any number of base classes. Deriving a class from more than one direct base class is called *multiple inheritance*.

In the following example, classes `A`, `B`, and `C` are direct base classes for the derived class `X`:

```

class A { /* ... */ };
class B { /* ... */ };
class C { /* ... */ };
class X : public A, private B, public C { /* ... */ };

```

The following *inheritance graph* describes the inheritance relationships of the above example. An arrow points to the direct base class of the class at the tail of the arrow:

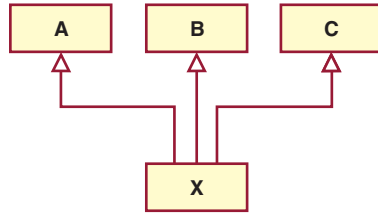

The order of derivation is relevant only to determine the order of default initialization by constructors and cleanup by destructors.

A direct base class cannot appear in the base list of a derived class more than once:

```

class B1 { /* ... */ }; // direct base class
class D : public B1, private B1 { /* ... */ }; // error
  
```

However, a derived class can inherit an indirect base class more than once, as shown in the following example:

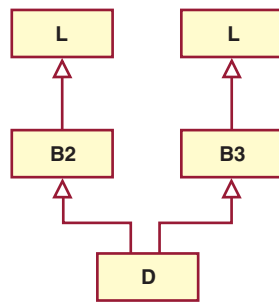

```

class L { /* ... */ }; // indirect base class
class B2 : public L { /* ... */ };
class B3 : public L { /* ... */ };
class D : public B2, public B3 { /* ... */ }; // valid
  
```

In the above example, class D inherits the indirect base class L once through class B2 and once through class B3. However, this may lead to ambiguities because two subobjects of class L exist, and both are accessible through class D. You can avoid this ambiguity by referring to class L using a qualified class name. For example:

B2::L

or

B3::L.

You can also avoid this ambiguity by using the base specifier `virtual` to declare a base class, as described in “Derivation” on page 361.

Virtual base classes

Suppose you have two derived classes B and C that have a common base class A, and you also have another class D that inherits from B and C. You can declare the base class A as *virtual* to ensure that B and C share the same subobject of A.

In the following example, an object of class D has two distinct subobjects of class L, one through class B1 and another through class B2. You can use the keyword `virtual` in front of the base class specifiers in the *base lists* of classes B1 and B2 to indicate that only one subobject of type L, shared by class B1 and class B2, exists.

For example:

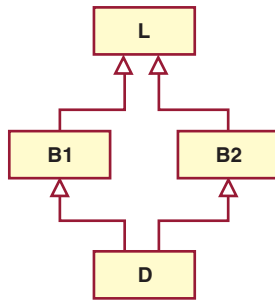

```
class L { /* ... */ }; // indirect base class
class B1 : virtual public L { /* ... */ };
class B2 : virtual public L { /* ... */ };
class D : public B1, public B2 { /* ... */ }; // valid
```

Using the keyword `virtual` in this example ensures that an object of class `D` inherits only one subobject of class `L`.

A derived class can have both virtual and nonvirtual base classes. For example:

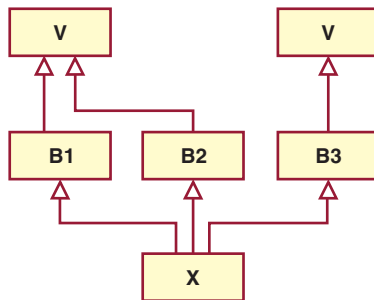

```
class V { /* ... */ };
class B1 : virtual public V { /* ... */ };
class B2 : virtual public V { /* ... */ };
class B3 : public V { /* ... */ };
class X : public B1, public B2, public B3 { /* ... */ };
```

In the above example, class `X` has two subobjects of class `V`, one that is shared by classes `B1` and `B2` and one through class `B3`.

Related reference:

“Derivation” on page 361

Multiple access

In an inheritance graph containing virtual base classes, a name that can be reached through more than one path is accessed through the path that gives the most access.

For example:

```
class L {
public:
    void f();
};

class B1 : private virtual L { };
```

```

class B2 : public virtual L { };

class D : public B1, public B2 {
public:
    void f() {
        // L::f() is accessed through B2
        // and is public
        L::f();
    }
};

```

In the above example, the function `f()` is accessed through class `B2`. Because class `B2` is inherited publicly and class `B1` is inherited privately, class `B2` offers more access.

Related reference:

“Member access” on page 349

“Protected members” on page 364

“Access control of base class members” on page 365

Ambiguous base classes

When you derive classes, ambiguities can result if base and derived classes have members with the same names. Access to a base class member is ambiguous if you use a name or qualified name that does not refer to a unique function or object. The declaration of a member with an ambiguous name in a derived class is not an error. The ambiguity is only flagged as an error if you use the ambiguous member name.

For example, suppose that two classes named `A` and `B` both have a member named `x`, and a class named `C` inherits from both `A` and `B`. An attempt to access `x` from class `C` would be ambiguous. You can resolve ambiguity by qualifying a member with its class name using the scope resolution (`::`) operator.

```

class B1 {
public:
    int i;
    int j;
    void g(int) { }
};

class B2 {
public:
    int j;
    void g() { }
};

class D : public B1, public B2 {
public:
    int i;
};

int main() {
    D dobj;
    D *dptr = &dobj;
    dptr->i = 5;
    // dptr->j = 10;
    dptr->B1::j = 10;
    // dobj.g();
    dobj.B2::g();
}

```

The statement `dptr->j = 10` is ambiguous because the name `j` appears both in `B1` and `B2`. The statement `dobj.g()` is ambiguous because the name `g` appears both in `B1` and `B2`, even though `B1::g(int)` and `B2::g()` have different parameters.

The compiler checks for ambiguities at compile time. Because ambiguity checking occurs before access control or type checking, ambiguities may result even if only one of several members with the same name is accessible from the derived class.

Name hiding

Suppose two subobjects named `A` and `B` both have a member name `x`. The member name `x` of subobject `B` *hides* the member name `x` of subobject `A` if `A` is a base class of `B`. The following example demonstrates this:

```
struct A {
    int x;
};

struct B: A {
    int x;
    void f() { x = 0; }
};

int main() {
    B b;
    b.f();
}
```

The assignment `x = 0` in function `B::f()` is not ambiguous because the declaration `B::x` has hidden `A::x`.

A base class declaration can be hidden along one path in the inheritance graph and not hidden along another path. The following example demonstrates this:

```
struct A { int x; };
struct B { int y; };
struct C: A, virtual B { };
struct D: A, virtual B {
    int x;
    int y;
};
struct E: C, D { };

int main() {
    E e;
    // e.x = 1;
    e.y = 2;
}
```

The assignment `e.x = 1` is ambiguous. The declaration `D::x` hides `A::x` along the path `D::A::x`, but it does not hide `A::x` along the path `C::A::x`. Therefore the variable `x` could refer to either `D::x` or `A::x`. The assignment `e.y = 2` is not ambiguous. The declaration `D::y` hides `B::y` along both paths `D::B::y` and `C::B::y` because `B` is a virtual base class.

Ambiguity and using declarations

Suppose you have a class named `C` that inherits from a class named `A`, and `x` is a member name of `A`. If you use a using declaration to declare `A::x` in `C`, then `x` is also a member of `C`; `C::x` does not hide `A::x`. Therefore using declarations cannot resolve ambiguities due to inherited members. The following example demonstrates this:

```

struct A {
    int x;
};

struct B: A { };

struct C: A {
    using A::x;
};

struct D: B, C {
    void f() { x = 0; }
};

int main() {
    D i;
    i.f();
}

```

The compiler will not allow the assignment `x = 0` in function `D::f()` because it is ambiguous. The compiler can find `x` in two ways: as `B::x` or as `C::x`.

Unambiguous class members

The compiler can unambiguously find static members, nested types, and enumerators defined in a base class `A` regardless of the number of subobjects of type `A` an object has. The following example demonstrates this:

```

struct A {
    int x;
    static int s;
    typedef A* Pointer_A;
    enum { e };
};

int A::s;

struct B: A { };

struct C: A { };

struct D: B, C {
    void f() {
        s = 1;
        Pointer_A pa;
        int i = e;
        // x = 1;
    }
};

int main() {
    D i;
    i.f();
}

```

The compiler allows the assignment `s = 1`, the declaration `Pointer_A pa`, and the statement `int i = e`. There is only one static variable `s`, only one typedef `Pointer_A`, and only one enumerator `e`. The compiler would not allow the assignment `x = 1` because `x` can be reached either from class `B` or class `C`.

Pointer conversions

Conversions (either implicit or explicit) from a derived class pointer or reference to a base class pointer or reference must refer unambiguously to the same accessible

base class object. (An *accessible base class* is a publicly derived base class that is neither hidden nor ambiguous in the inheritance hierarchy.) For example:

```
class W { /* ... */ };
class X : public W { /* ... */ };
class Y : public W { /* ... */ };
class Z : public X, public Y { /* ... */ };
int main ()
{
    Z z;
    X* xptr = &z;      // valid
    Y* yptr = &z;      // valid
    W* wptr = &z;      // error, ambiguous reference to class W
                        // X's W or Y's W ?
}
```

You can use virtual base classes to avoid ambiguous reference. For example:

```
class W { /* ... */ };
class X : public virtual W { /* ... */ };
class Y : public virtual W { /* ... */ };
class Z : public X, public Y { /* ... */ };
int main ()
{
    Z z;
    X* xptr = &z;      // valid
    Y* yptr = &z;      // valid
    W* wptr = &z;      // valid, W is virtual therefore only one
                        // W subobject exists
}
```

A pointer to a member of a base class can be converted to a pointer to a member of a derived class if the following conditions are true:

- The conversion is not ambiguous. The conversion is ambiguous if multiple instances of the base class are in the derived class.
- A pointer to the derived class can be converted to a pointer to the base class. If this is the case, the base class is said to be *accessible*.
- Member types must match. For example suppose class A is a base class of class B. You cannot convert a pointer to member of A of type `int` to a pointer to member of type B of type `float`.
- The base class cannot be virtual.

Overload resolution

Overload resolution takes place *after* the compiler unambiguously finds a given function name. The following example demonstrates this:

```
struct A {
    int f() { return 1; }
};

struct B {
    int f(int arg) { return arg; }
};

struct C: A, B {
    int g() { return f(); }
};
```

The compiler will not allow the function call to `f()` in `C::g()` because the name `f` has been declared both in `A` and `B`. The compiler detects the ambiguity error before overload resolution can select the base match `A::f()`.

Related reference:

“Scope resolution operator :: (C++ only)” on page 166

“Virtual base classes” on page 371

Virtual functions

By default, C++ matches a function call with the correct function definition at compile time. This is called *static binding*. You can specify that the compiler match a function call with the correct function definition at run time; this is called *dynamic binding*. You declare a function with the keyword `virtual` if you want the compiler to use dynamic binding for that specific function.

The following examples demonstrate the differences between static and dynamic binding. The first example demonstrates static binding:

```
#include <iostream>
using namespace std;

struct A {
    void f() { cout << "Class A" << endl; }
};

struct B: A {
    void f() { cout << "Class B" << endl; }
};

void g(A& arg) {
    arg.f();
}

int main() {
    B x;
    g(x);
}
```

The following is the output of the above example:

```
Class A
```

When function `g()` is called, function `A::f()` is called, although the argument refers to an object of type B. At compile time, the compiler knows only that the argument of function `g()` is an lvalue reference to an object derived from A; it cannot determine whether the argument is an lvalue reference to an object of type A or type B. However, this can be determined at run time. The following example is the same as the previous example, except that `A::f()` is declared with the `virtual` keyword:

```
#include <iostream>
using namespace std;

struct A {
    virtual void f() { cout << "Class A" << endl; }
};

struct B: A {
    void f() { cout << "Class B" << endl; }
};

void g(A& arg) {
    arg.f();
}
```

```
int main() {
    B x;
    g(x);
}
```

The following is the output of the above example:

```
Class B
```

The `virtual` keyword indicates to the compiler that it should choose the appropriate definition of `f()` not by the type of lvalue reference, but by the type of object that the lvalue reference refers to.

Therefore, a *virtual function* is a member function you may redefine for other derived classes, and can ensure that the compiler will call the redefined virtual function for an object of the corresponding derived class, even if you call that function with a pointer or reference to a base class of the object.

A class that declares or inherits a virtual function is called a *polymorphic class*.

You redefine a virtual member function, like any member function, in any derived class. Suppose you declare a virtual function named `f` in a class `A`, and you derive directly or indirectly from `A` a class named `B`. If you declare a function named `f` in class `B` with the same name and same parameter list as `A::f`, then `B::f` is also virtual (regardless whether or not you declare `B::f` with the `virtual` keyword) and it *overrides* `A::f`. However, if the parameter lists of `A::f` and `B::f` are different, `A::f` and `B::f` are considered different, `B::f` does not override `A::f`, and `B::f` is not virtual (unless you have declared it with the `virtual` keyword). Instead `B::f` *hides* `A::f`. The following example demonstrates this:

```
#include <iostream>
using namespace std;

struct A {
    virtual void f() { cout << "Class A" << endl; }
};

struct B: A {
    virtual void f(int) { cout << "Class B" << endl; }
};

struct C: B {
    void f() { cout << "Class C" << endl; }
};

int main() {
    B b; C c;
    A* pa1 = &b;
    A* pa2 = &c;
    // b.f();
    pa1->f();
    pa2->f();
}
```

The following is the output of the above example:

```
Class A
Class C
```

The function `B::f` is not virtual. It hides `A::f`. Thus the compiler will not allow the function call `b.f()`. The function `C::f` is virtual; it overrides `A::f` even though `A::f` is not visible in `C`.

If you declare a base class destructor as virtual, a derived class destructor will override that base class destructor, even though destructors are not inherited.

The return type of an overriding virtual function may differ from the return type of the overridden virtual function. This overriding function would then be called a *covariant virtual function*. Suppose that `B::f` overrides the virtual function `A::f`. The return types of `A::f` and `B::f` may differ if all the following conditions are met:

- The function `B::f` returns a pointer or a reference to a class of type `T`, and `A::f` returns a pointer or a reference to an unambiguous direct or indirect base class of `T`.
- The `const` or `volatile` qualification of the pointer or reference returned by `B::f` has the same or less `const` or `volatile` qualification of the pointer or reference returned by `A::f`.
- The return type of `B::f` must be complete at the point of declaration of `B::f`, or it can be of type `B`.
- `A::f` returns an lvalue reference if and only if `B::f` returns an lvalue reference.

The following example demonstrates this:

```
#include <iostream>
using namespace std;

struct A { };

class B : private A {
    friend class D;
    friend class F;
};

A global_A;
B global_B;

struct C {
    virtual A* f() {
        cout << "A* C::f()" << endl;
        return &global_A;
    }
};

struct D : C {
    B* f() {
        cout << "B* D::f()" << endl;
        return &global_B;
    }
};

struct E;

struct F : C {

    // Error:
    // E is incomplete
    // E* f();
};

struct G : C {

    // Error:
    // A is an inaccessible base class of B
    // B* f();
};

int main() {
    D d;
```

```

C* cp = &d;
D* dp = &d;

A* ap = cp->f();
B* bp = dp->f();
};

```

The following is the output of the above example:

```

B* D::f()
B* D::f()

```

The statement `A* ap = cp->f()` calls `D::f()` and converts the pointer returned to type `A*`. The statement `B* bp = dp->f()` calls `D::f()` as well but does not convert the pointer returned; the type returned is `B*`. The compiler would not allow the declaration of the virtual function `F::f()` because `E` is not a complete class. The compiler would not allow the declaration of the virtual function `G::f()` because class `A` is not an accessible base class of `B` (unlike friend classes `D` and `F`, the definition of `B` does not give access to its members for class `G`).

A virtual function cannot be global or static because, by definition, a virtual function is a member function of a base class and relies on a specific object to determine which implementation of the function is called. You can declare a virtual function to be a friend of another class.

If a function is declared virtual in its base class, you can still access it directly using the scope resolution (`::`) operator. In this case, the virtual function call mechanism is suppressed and the function implementation defined in the base class is used. In addition, if you do not override a virtual member function in a derived class, a call to that function uses the function implementation defined in the base class.

C++11 A function that has a deleted definition cannot override a function that does not have a deleted definition. Likewise, a function that does not have a deleted definition cannot override a function with a deleted definition. **C++11**

A virtual function must be one of the following:

- Defined
- Declared pure
- Defined and declared pure

A class containing one or more pure virtual member functions is called an *abstract class*.

Related reference:

“Abstract classes” on page 382

“Deleted functions” on page 250

Ambiguous virtual function calls

You cannot override one virtual function with two or more ambiguous virtual functions. This can happen in a derived class that inherits from two nonvirtual bases that are derived from a virtual base class.

For example:

```

class V {
public:
    virtual void f() { }
};

```

```

class A : virtual public V {
    void f() { }
};

class B : virtual public V {
    void f() { }
};

// Error:
// Both A::f() and B::f() try to override V::f()
class D : public A, public B { };

int main() {
    D d;
    V* vptr = &d;

    // which f(), A::f() or B::f()?
    vptr->f();
}

```

The compiler will not allow the definition of class D. In class A, only A::f() will override V::f(). Similarly, in class B, only B::f() will override V::f(). However, in class D, both A::f() and B::f() will try to override V::f(). This attempt is not allowed because it is not possible to decide which function to call if a D object is referenced with a pointer to class V, as shown in the above example. Only one function can override a virtual function.

A special case occurs when the ambiguous overriding virtual functions come from separate instances of the same class type. In the following example, class D has two separate subobjects of class A:

```

#include <iostream>
using namespace std;

struct A {
    virtual void f() { cout << "A::f()" << endl; };
};

struct B : A {
    void f() { cout << "B::f()" << endl; };
};

struct C : A {
    void f() { cout << "C::f()" << endl; };
};

struct D : B, C { };

int main() {
    D d;

    B* bp = &d;
    A* ap = bp;
    D* dp = &d;

    ap->f();
    // dp->f();
}

```

Class D has two occurrences of class A, one inherited from B, and another inherited from C. Therefore there are also two occurrences of the virtual function A::f. The statement ap->f() calls D::B::f. However the compiler would not allow the statement dp->f() because it could either call D::B::f or D::C::f.

Virtual function access

The access for a virtual function is specified when it is declared. The access rules for a virtual function are not affected by the access rules for the function that later overrides the virtual function. In general, the access of the overriding member function is not known.

If a virtual function is called with a pointer or reference to a class object, the type of the class object is not used to determine the access of the virtual function. Instead, the type of the pointer or reference to the class object is used.

In the following example, when the function `f()` is called using a pointer having type `B*`, `bptr` is used to determine the access to the function `f()`. Although the definition of `f()` defined in class `D` is executed, the access of the member function `f()` in class `B` is used. When the function `f()` is called using a pointer having type `D*`, `dptr` is used to determine the access to the function `f()`. This call produces an error because `f()` is declared private in class `D`.

```
class B {
public:
    virtual void f();
};

class D : public B {
private:
    void f();
};

int main() {
    D dobj;
    B* bptr = &dobj;
    D* dptr = &dobj;

    // valid, virtual B::f() is public,
    // D::f() is called
    bptr->f();

    // error, D::f() is private
    dptr->f();
}
```

Abstract classes

An *abstract class* is a class that is designed to be specifically used as a base class. An abstract class contains at least one *pure virtual function*. You declare a pure virtual function by using a *pure specifier* (`= 0`) in the declaration of a virtual member function in the class declaration.

The following is an example of an abstract class:

```
class AB {
public:
    virtual void f() = 0;
};
```

Function `AB::f` is a pure virtual function. A function declaration cannot have both a pure specifier and a definition. For example, the compiler will not allow the following:

```
struct A {
    virtual void g() { } = 0;
};
```

You cannot use an abstract class as a parameter type, a function return type, or the type of an explicit conversion, nor can you declare an object of an abstract class. You can, however, declare pointers and references to an abstract class. The following example demonstrates this:

```
struct A {
    virtual void f() = 0;
};

struct B : A {
    virtual void f() { }
};

// Error:
// Class A is an abstract class
// A g();

// Error:
// Class A is an abstract class
// void h(A);
A& i(A&);

int main() {

// Error:
// Class A is an abstract class
// A a;

    A* pa;
    B b;

// Error:
// Class A is an abstract class
// static_cast<A>(b);
}
```

Class A is an abstract class. The compiler would not allow the function declarations `A g()` or `void h(A)`, declaration of object `a`, nor the static cast of `b` to type A.

Virtual member functions are inherited. A class derived from an abstract base class will also be abstract unless you override each pure virtual function in the derived class.

For example:

```
class AB {
public:
    virtual void f() = 0;
};

class D2 : public AB {
    void g();
};

int main() {
    D2 d;
}
```

The compiler will not allow the declaration of object `d` because `D2` is an abstract class; it inherited the pure virtual function `f()` from `AB`. The compiler will allow the declaration of object `d` if you define function `D2::f()`, as this overrides the inherited pure virtual function `AB::f()`. Function `AB::f()` needs to be overridden if you want to avoid the abstraction of `D2`.

Note that you can derive an abstract class from a nonabstract class, and you can override a non-pure virtual function with a pure virtual function.

You can call member functions from a constructor or destructor of an abstract class. However, the results of calling (directly or indirectly) a pure virtual function from its constructor are undefined. The following example demonstrates this:

```
struct A {
    A() {
        direct();
        indirect();
    }
    virtual void direct() = 0;
    virtual void indirect() { direct(); }
};
```

The default constructor of A calls the pure virtual function `direct()` both directly and indirectly (through `indirect()`).

The compiler issues a warning for the direct call to the pure virtual function, but not for the indirect call.

Related reference:

“Virtual functions” on page 377

“Virtual function access” on page 382

Chapter 15. Special member functions (C++ only)

The default constructors, destructors, copy constructors, and copy assignment operators are *special member functions*. These functions create, destroy, convert, initialize, and copy class objects.

► C++11 A special member function is user-provided if it is user-declared but not explicitly defaulted, or deleted on its first declaration. C++11 ◀

Overview of constructors and destructors

Because classes have complicated internal structures, including data and functions, object initialization and cleanup for classes is much more complicated than it is for simple data structures. Constructors and destructors are special member functions of classes that are used to construct and destroy class objects. Construction may involve memory allocation and initialization for objects. Destruction may involve cleanup and deallocation of memory for objects.

Like other member functions, constructors and destructors are declared within a class declaration. They can be defined inline or external to the class declaration. Constructors can have default arguments. Unlike other member functions, constructors can have member initialization lists. The following restrictions apply to constructors and destructors:

- Constructors and destructors do not have return types nor can they return values.
- References and pointers cannot be used on constructors and destructors because their addresses cannot be taken.
- Constructors cannot be declared with the keyword `virtual`.
- Constructors and destructors cannot be declared `static`, `const`, or `volatile`.
- Unions cannot contain class objects that have constructors or destructors.

Constructors and destructors obey the same access rules as member functions. For example, if you declare a constructor with protected access, only derived classes and friends can use it to create class objects.

The compiler automatically calls constructors when defining class objects and calls destructors when class objects go out of scope. A constructor does not allocate memory for the class object its `this` pointer refers to, but may allocate storage for more objects than its class object refers to. If memory allocation is required for objects, constructors can explicitly call the `new` operator. During cleanup, a destructor may release objects allocated by the corresponding constructor. To release objects, use the `delete` operator.

Derived classes do not inherit or overload constructors or destructors from their base classes, but they do call the constructor and destructor of base classes. Destructors can be declared with the keyword `virtual`.

Constructors are also called when local or temporary class objects are created, and destructors are called when local or temporary objects go out of scope.

You can call member functions from constructors or destructors. You can call a virtual function, either directly or indirectly, from a constructor or destructor of a class A. In this case, the function called is the one defined in A or a base class of A, but not a function overridden in any class derived from A. This avoids the possibility of accessing an unconstructed object from a constructor or destructor. The following example demonstrates this:

```
#include <iostream>
using namespace std;

struct A {
    virtual void f() { cout << "void A::f()" << endl; }
    virtual void g() { cout << "void A::g()" << endl; }
    virtual void h() { cout << "void A::h()" << endl; }
};

struct B : A {
    virtual void f() { cout << "void B::f()" << endl; }
    B() {
        f();
        g();
        h();
    }
};

struct C : B {
    virtual void f() { cout << "void C::f()" << endl; }
    virtual void g() { cout << "void C::g()" << endl; }
    virtual void h() { cout << "void C::h()" << endl; }
};

int main() {
    C obj;
}
```

The following is the output of the above example:

```
void B::f()
void A::g()
void A::h()
```

The constructor of B does not call any of the functions overridden in C because C has been derived from B, although the example creates an object of type C named obj.

You can use the typeid or the dynamic_cast operator in constructors or destructors, as well as member initializers of constructors.

Related reference:

“new expressions (C++ only)” on page 207

Constructors

A *constructor* is a member function with the same name as its class. For example:

```
class X {
public:
    X();    // constructor for class X
};
```

Constructors are used to create, and can initialize, objects of their class type.

You cannot declare a constructor as `virtual` or `static`, nor can you declare a constructor as `const`, `volatile`, or `const volatile`.

You do not specify a return type for a constructor. A return statement in the body of a constructor cannot have a return value.

Default constructors

A *default constructor* is a constructor that either has no parameters, or if it has parameters, *all* the parameters have default values.

If no user-defined constructor exists for a class *A* and one is needed, the compiler implicitly *declares* a default parameterless constructor `A::A()`. This constructor is an inline public member of its class. The compiler will implicitly *define* `A::A()` when the compiler uses this constructor to create an object of type *A*. The constructor will have no constructor initializer and a null body.

The compiler first implicitly defines the implicitly declared [C++11](#) or explicitly defaulted [C++11](#) constructors of the base classes and nonstatic data members of a class *A* before defining the implicitly declared [C++11](#) or explicitly defaulted [C++11](#) constructor of *A*. No default constructor is created for a class that has any constant or reference type members.

A constructor of a class *A* is *trivial* if all the following are true:

- It is implicitly declared [C++11](#) or explicitly defaulted [C++11](#).
- *A* has no virtual functions and no virtual base classes
- All the direct base classes of *A* have trivial constructors
- The classes of all the nonstatic data members of *A* have trivial constructors

If any of the above are false, then the constructor is *nontrivial*.

A union member cannot be of a class type that has a nontrivial constructor.

Like all functions, a constructor can have default arguments. They are used to initialize member objects. If default values are supplied, the trailing arguments can be omitted in the expression list of the constructor. Note that if a constructor has any arguments that do not have default values, it is not a default constructor.

The following example defines a class with one constructor and two default constructors.

```
class X {
public:
    X();                // Default constructor with no arguments
    X(int = 0);        // Default constructor with one default argument
    X(int, int , int = 0); // Constructor
};
```

Note: [C++11](#) You can declare default constructors as explicitly defaulted functions or deleted functions. For more information, see “Explicitly defaulted functions” on page 249 and “Deleted functions” on page 250. [C++11](#)

Related reference:

“Copy constructors” on page 406

Chapter 15, “Special member functions (C++ only),” on page 385

Delegating constructors (C++11)

Note: IBM supports selected features of C++11, known as C++0x before its ratification. IBM will continue to develop and implement the features of this

standard. The implementation of the language level is based on IBM's interpretation of the standard. Until IBM's implementation of all the C++11 features is complete, including the support of a new C++11 standard library, the implementation might change from release to release. IBM makes no attempt to maintain compatibility, in source, binary, or listings and other compiler interfaces, with earlier releases of IBM's implementation of the new C++11 features.

Before C++11, common initializations in multiple constructors of the same class could not be concentrated in one place in a robust, maintainable manner. To partially alleviate this problem in the existing C++ programs, you could use *assignment* instead of initialization or add a common initialization function.

With the delegating constructors feature, you can concentrate common initializations and post initializations in one constructor named *target constructor*. Delegating constructors can call the target constructor to do the initialization. A delegating constructor can also be used as the *target constructor* of one or more delegating constructors. You can use this feature to make programs more readable and maintainable.

Delegating constructors and target constructors present the same interface as other constructors. Target constructors do not need special handling to become the target of a delegating constructor. They are selected by overload resolution or template argument deduction. After the target constructor completes execution, the delegating constructor gets control back.

In the following example, `X(int x, int y)` and `X(int x, int y, int z)` both delegate to `X(int x)`. This example demonstrates a typical usage of placing common initializations in a single constructor.

```
#include <cstdio>

struct X {
    const int i;
    X(int x, int y) : X(x+y) { }
    X(int x, int y, int z) : X(x*y*z) {}
    X(int x) : i(x) { }
};

int main(void){
    X var1(55,11);
    X var2(2,4,6);
    std::printf("%d, %d\n", var1.i, var2.i);
    return 0;
}
```

The output of the example is:

66,48

A delegating constructor can be a target constructor of another delegating constructor, thus forming a delegating chain. The first constructor invoked in the construction of an object is called *principal constructor*. A constructor cannot delegate to itself directly or indirectly. The compiler can detect this violation if the constructors involved in a recursive chain of delegation are all defined in one translation unit. Consider the following example:

```
struct A{
    int x,y;
    A():A(42){}
    A(int x_):A() {x = x_;}
};
```

In the example, there is an infinitely recursive cycle that constructor `A()` delegates to constructor `A(int x_)`, and `A(int x_)` also delegates to `A()`. The compiler issues an error to indicate the violation.

You can use the delegating constructors feature interacting with other existing techniques:

- When several constructors have the same name, name and overload resolution can determine which constructor is the target constructor.
- When using delegating constructors in a template class, the deduction of template parameters works normally.

Related reference:

“C++11 compatibility” on page 519

Constexpr constructors (C++11)

Note: IBM supports selected features of C++11, known as C++0x before its ratification. IBM will continue to develop and implement the features of this standard. The implementation of the language level is based on IBM's interpretation of the standard. Until IBM's implementation of all the C++11 features is complete, including the support of a new C++11 standard library, the implementation might change from release to release. IBM makes no attempt to maintain compatibility, in source, binary, or listings and other compiler interfaces, with earlier releases of IBM's implementation of the new C++11 features.

A constructor that is declared with a `constexpr` specifier is a `constexpr` constructor. Previously, only expressions of built-in types could be valid constant expressions. With `constexpr` constructors, objects of user-defined types can be included in valid constant expressions.

Definitions of `constexpr` constructors must satisfy the following requirements:

- The containing class must not have any virtual base classes.
- Each of the parameter types is a literal type.
- Its function body is `= delete` or `= default`; otherwise, it must satisfy the following constraints:
 - It is not a function try block.
 - The compound statement in it must contain only the following statements:
 - null statements
 - `static_assert` declarations
 - typedef declarations that do not define classes or enumerations
 - using directives
 - using declarations
- Each nonstatic data member and base class subobject is initialized.
- Each constructor that is used for initializing nonstatic data members and base class subobjects is a `constexpr` constructor.
- Initializers for all nonstatic data members that are not named by a member initializer identifier are constant expressions.
- When initializing data members, all implicit conversions that are involved in the following context must be valid in a constant expression:
 - Calling any constructors
 - Converting any expressions to data member types

The implicitly defined default constructor performs the set of initializations of the class that would be performed by a user-written default constructor for that class with no initializer and an empty compound-statement. If that user-defined default constructor would satisfy the requirements of a constexpr constructor, the implicitly defined default constructor is a constexpr constructor.

A constexpr constructor is implicitly inline.

The following examples demonstrate the usage of constexpr constructors:

```
struct BASE {
};

struct B2 {
    int i;
};

//NL is a non-literal type.
struct NL {
    virtual ~NL() {
    }
};

int i = 11;

struct D1 : public BASE {
    //OK, the implicit default constructor of BASE is a constexpr constructor.
    constexpr D1() : BASE(), mem(55) { }

    //OK, the implicit copy constructor of BASE is a constexpr constructor.
    constexpr D1(const D1& d) : BASE(d), mem(55) { }

    //OK, all reference types are literal types.
    constexpr D1(NL &n) : BASE(), mem(55) { }

    //The conversion operator is not constexpr.
    operator int() const { return 55; }

private:
    int mem;
};

struct D2 : virtual BASE {
    //error, D2 must not have virtual base class.
    constexpr D2() : BASE(), mem(55) { }

private:
    int mem;
};

struct D3 : B2 {
    //error, D3 must not be a function try block.
    constexpr D3(int) try : B2(), mem(55) { } catch(int) { }

    //error, illegal statement is in body.
    constexpr D3(char) : B2(), mem(55) { mem = 55; }

    //error, initializer for mem is not a constant expression.
    constexpr D3(double) : B2(), mem(i) { }

    //error, implicit conversion is not constexpr.
    constexpr D3(const D1 &d) : B2(), mem(d) { }

    //error, parameter NL is a non-literal type.
    constexpr D3(NL) : B2(), mem(55) { }
```



```
private:
    int mem;
};
```

Related reference:

- “Generalized constant expressions (C++11)” on page 167
- “The constexpr specifier (C++11)” on page 96
- “Type specifiers” on page 61
- “Explicitly defaulted functions” on page 249
- “Deleted functions” on page 250

Explicit initialization with constructors

A class object with a constructor must be explicitly initialized or have a default constructor. Except for aggregate initialization, explicit initialization using a constructor is the only way to initialize non-static constant and reference class members.

A class object that has only implicitly declared [C++11](#) or explicitly defaulted [C++11](#) constructors, and has no virtual functions, no private or protected non-static data members, and no base classes is called an *aggregate*. Examples of aggregates are C-style structures and unions.

You explicitly initialize a class object when you create that object. There are two ways to initialize a class object:

- Using a parenthesized expression list. The compiler calls the constructor of the class using this list as the constructor's argument list.
- Using a single initialization value and the = operator. Because this type of expression is an initialization, not an assignment, the assignment operator function, if one exists, is not called. The type of the single argument must match the type of the first argument to the constructor. If the constructor has remaining arguments, these arguments must have default values.

Initializer syntax

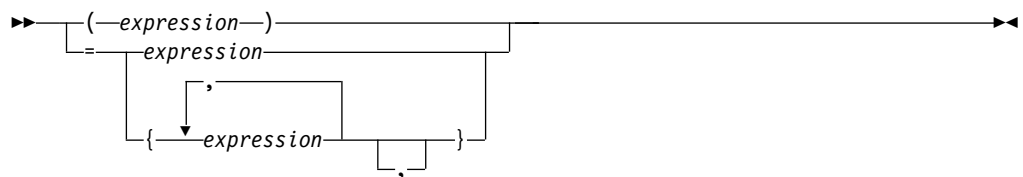

The following example shows the declaration and use of several constructors that explicitly initialize class objects:

```
// This example illustrates explicit initialization
// by constructor.
#include <iostream>
using namespace std;

class complx {
    double re, im;
public:

    // default constructor
    complx() : re(0), im(0) { }
```

```

// copy constructor
complx(const complx& c) { re = c.re; im = c.im; }

// constructor with default trailing argument
complx( double r, double i = 0.0) { re = r; im = i; }

void display() {
    cout << "re = " << re << " im = " << im << endl;
}
};

int main() {

    // initialize with complx(double, double)
    complx one(1);

    // initialize with a copy of one
    // using complx::complx(const complx&)
    complx two = one;

    // construct complx(3,4)
    // directly into three
    complx three = complx(3,4);

    // initialize with default constructor
    complx four;

    // complx(double, double) and construct
    // directly into five
    complx five = 5;

    one.display();
    two.display();
    three.display();
    four.display();
    five.display();
}

```

The above example produces the following output:

```

re = 1 im = 0
re = 1 im = 0
re = 3 im = 4
re = 0 im = 0
re = 5 im = 0

```

Related reference:

“Initializers” on page 124

Chapter 15, “Special member functions (C++ only),” on page 385

Initialization of base classes and members

Constructors can initialize their members in two different ways. A constructor can use the arguments passed to it to initialize member variables in the constructor definition:

```
complx(double r, double i = 0.0) { re = r; im = i; }
```

Or a constructor can have an *initializer list* within the definition but prior to the constructor body:

```
complx(double r, double i = 0) : re(r), im(i) { /* ... */ }
```

Both methods assign the argument values to the appropriate data members of the class.

Initializer list syntax

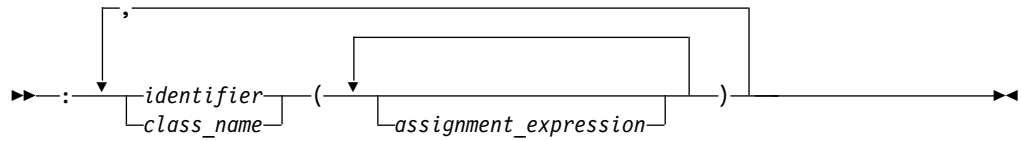

Include the initialization list as part of the constructor definition, not as part of the constructor declaration. For example:

```
#include <iostream>
using namespace std;

class B1 {
    int b;
public:
    B1() { cout << "B1::B1()" << endl; };

    // inline constructor
    B1(int i) : b(i) { cout << "B1::B1(int)" << endl; }
};

class B2 {
    int b;
protected:
    B2() { cout << "B2::B2()" << endl; }

    // noninline constructor
    B2(int i);
};

// B2 constructor definition including initialization list
B2::B2(int i) : b(i) { cout << "B2::B2(int)" << endl; }

class D : public B1, public B2 {
    int d1, d2;
public:
    D(int i, int j) : B1(i+1), B2(), d1(i) {
        cout << "D1::D1(int, int)" << endl;
        d2 = j;
    }
};

int main() {
    D obj(1, 2);
}
```

The output of this example:

```
B1::B1(int)
B2::B2()
D1::D1(int, int)
```

If you do not explicitly initialize a base class or member that has constructors by calling a constructor, the compiler automatically initializes the base class or member with a default constructor. In the above example, if you leave out the call `B2()` in the constructor of class `D` (as shown below), a constructor initializer with an empty expression list is automatically created to initialize `B2`. The constructors for class `D`, shown above and below, result in the same construction of an object of class `D`:

```
class D : public B1, public B2 {
    int d1, d2;
public:
```

```

// call B2() generated by compiler
D(int i, int j) : B1(i+1), d1(i) {
    cout << "D1::D1(int, int)" << endl;
    d2 = j;}
};

```

In the above example, the compiler will automatically call the default constructor for B2().

Note that you must declare constructors as public or protected to enable a derived class to call them. For example:

```

class B {
    B() { }
};

class D : public B {

    // error: implicit call to private B() not allowed
    D() { }
};

```

The compiler does not allow the definition of D::D() because this constructor cannot access the private constructor B::B().

You must initialize the following cases with an initializer list: base classes with no default constructors, reference data members, non-static const data members, or a class type which contains a constant data member. The following example demonstrates this:

```

class A {
public:
    A(int) { }
};

class B : public A {
    static const int i;
    const int j;
    int &k;
public:
    B(int& arg) : A(0), j(1), k(arg) { }
};

int main() {
    int x = 0;
    B obj(x);
};

```

The data members j and k, as well as the base class A must be initialized in the initializer list of the constructor of B.

You can use data members when initializing members of a class. The following example demonstrate this:

```

struct A {
    int k;
    A(int i) : k(i) { }
};

struct B: A {
    int x;
    int i;
    int j;
    int& r;
    B(int i): r(x), A(i), j(this->i), i(i) { }
};

```

The constructor `B(int i)` initializes the following items:

- `B::r` to refer to `B::x`
- Class `A` with the value of the argument to `B(int i)`
- `B::j` with the value of `B::i`
- `B::i` with the value of the argument to `B(int i)`

You can also call member functions (including virtual member functions) or use the operators `typeid` or `dynamic_cast` when initializing members of a class. However if you perform any of these operations in a member initialization list before all base classes have been initialized, the behavior is undefined. The following example demonstrates this:

```
#include <iostream>
using namespace std;

struct A {
    int i;
    A(int arg) : i(arg) {
        cout << "Value of i: " << i << endl;
    }
};

struct B : A {
    int j;
    int f() { return i; }
    B();
};

B::B() : A(f()), j(1234) {
    cout << "Value of j: " << j << endl;
}

int main() {
    B obj;
}
```

The output of the above example would be similar to the following result:

```
Value of i: 8
Value of j: 1234
```

The behavior of the initializer `A(f())` in the constructor of `B` is undefined. The run time will call `B::f()` and try to access `A::i` even though the base `A` has not been initialized.

The following example is the same as the previous example except that the initializers of `B::B()` have different arguments:

```
#include <iostream>
using namespace std;

struct A {
    int i;
    A(int arg) : i(arg) {
        cout << "Value of i: " << i << endl;
    }
};

struct B : A {
    int j;
    int f() { return i; }
    B();
};
```

```

B::B() : A(5678), j(f()) {
    cout << "Value of j: " << j << endl;
}

int main() {
    B obj;
}

```

See the output of the above example:

```

Value of i: 5678
Value of j: 5678

```

The behavior of the initializer `j(f())` in the constructor of `B` is well-defined. The base class `A` is already initialized when `B::j` is initialized.

> C++11

If the delegating constructors feature is enabled, initialization can only be done within the non-delegating constructor. In other words, a delegating constructor cannot both delegate and initialize. Consider the following example:

```

struct A{
    int x,y;
    A(int x):x(x),y(0){}

    /* the following statement is not allowed */
    A():y(0),A(42) {}
}

```

Constructor `A()` delegates to `A(int x)`, but `A()` also does the initialization, which is not permitted. The compiler issues an error to indicate the violation.

For more information, see “Delegating constructors (C++11)” on page 387

C++11 <

Related reference:

“The typeid operator (C++ only)” on page 174

“The dynamic_cast operator (C++ only)” on page 204

Constructor execution order for class objects

When a class object is created using constructors, the execution order of constructors is:

1. Constructors of Virtual base classes are executed, in the order that they appear in the base list.
2. Constructors of nonvirtual base classes are executed, in the declaration order.
3. Constructors of class members are executed in the declaration order (regardless of their order in the initialization list).
4. The body of the constructor is executed.

The following example demonstrates these:

```

#include <iostream>
using namespace std;
struct V {
    V() { cout << "V()" << endl; }
};
struct V2 {
    V2() { cout << "V2()" << endl; }
};

```

```

struct A {
    A() { cout << "A()" << endl; }
};
struct B : virtual V {
    B() { cout << "B()" << endl; }
};
struct C : B, virtual V2 {
    C() { cout << "C()" << endl; }
};
struct D : C, virtual V {
    A obj_A;
    D() { cout << "D()" << endl; }
};
int main() {
    D c;
}

```

The following is the output of the above example:

```

V()
V2()
B()
C()
A()
D()

```

The above output lists the order in which the C++ run time calls the constructors to create an object of type D.

► C++11

When the construction of a class object is done through a delegating constructor, the body of the delegating constructor is processed after the execution of its target constructor. The rule also applies to the target constructor if the target constructor is another delegating constructor.

Example:

```

#include <cstdio>
using std::printf;

class X{
public:
    int i,j;
    X();
    X(int x);
    X(int x, int y);
    ~X();
}

X::X(int x):i(x),j(23) {printf("X:X(int)\n");}
X::X(int x, int y): X(x+y) { printf("X::X(int,int)\n");}
X::X():X(44,11) {printf("X:X()\n");}
X::~~X() {printf("X::~~X()\n");}

int main(void){
    X x;
}

```

The output of the example is:

```

X::X(int)
X::X(int,int)
X:X()
X::~~X()

```

For more information, see “Delegating constructors (C++11)” on page 387

C++11 <

Related reference:

“Virtual base classes” on page 371

Destructors

Destructors are usually used to deallocate memory and do other cleanup for a class object and its class members when the object is destroyed. A destructor is called for a class object when that object passes out of scope or is explicitly deleted.

A destructor is a member function with the same name as its class prefixed by a ~ (tilde). For example:

```
class X {
public:
    // Constructor for class X
    X();
    // Destructor for class X
    ~X();
};
```

A destructor takes no arguments and has no return type. Its address cannot be taken. Destructors cannot be declared `const`, `volatile`, `const volatile` or `static`. A destructor can be declared `virtual` or `pure virtual`.

If no user-defined destructor exists for a class and one is needed, the compiler implicitly declares a destructor. This implicitly declared destructor is an inline public member of its class.

The compiler will implicitly define an implicitly declared destructor when the compiler uses the destructor to destroy an object of the destructor's class type. Suppose a class `A` has an implicitly declared destructor. The following is equivalent to the function the compiler would implicitly define for `A`:

```
A::~~A() { }
```

The compiler first implicitly defines the implicitly declared > C++11 or explicitly defaulted < C++11 destructors of the base classes and nonstatic data members of a class `A` before defining the implicitly declared > C++11 or explicitly defaulted < C++11 destructor of `A`.

A destructor of a class `A` is *trivial* if all the following are true:

- It is implicitly declared > C++11 or explicitly defaulted < C++11 .
- All the direct base classes of `A` have trivial destructors.
- The classes of all the nonstatic data members of `A` have trivial destructors.

If any of the above are false, then the destructor is *nontrivial*.

A union member cannot be of a class type that has a nontrivial destructor.

Class members that are class types can have their own destructors. Both base and derived classes can have destructors, although destructors are not inherited. If a base class `A` or a member of `A` has a destructor, and a class derived from `A` does not declare a destructor, a default destructor is generated.

The default destructor calls the destructors of the base class and members of the derived class.

The destructors of base classes and members are called in the reverse order of the completion of their constructor:

1. The destructor for a class object is called before destructors for members and bases are called.
2. Destructors for nonstatic members are called before destructors for base classes are called.
3. Destructors for nonvirtual base classes are called before destructors for virtual base classes are called.

When an exception is thrown for a class object with a destructor, the destructor for the temporary object thrown is not called until control passes out of the catch block.

Destructors are implicitly called when an automatic object (a local object that has been declared `auto` or `register`, or not declared as `static` or `extern`) or temporary object passes out of scope. They are implicitly called at program termination for constructed external and static objects. Destructors are invoked when you use the `delete` operator for objects created with the `new` operator.

For example:

```
#include <string>

class Y {
private:
    char * string;
    int number;
public:
    // Constructor
    Y(const char*, int);
    // Destructor
    ~Y() { delete[] string; }
};

// Define class Y constructor
Y::Y(const char* n, int a) {
    string = strcpy(new char[strlen(n) + 1 ], n);
    number = a;
}

int main () {
    // Create and initialize
    // object of class Y
    Y yobj = Y("somestring", 10);

    // ...

    // Destructor ~Y is called before
    // control returns from main()
}
```

You can use a destructor explicitly to destroy objects, although this practice is not recommended. However to destroy an object created with the placement `new` operator, you can explicitly call the object's destructor. The following example demonstrates this:

```
#include <new>
#include <iostream>
using namespace std;
```

```

class A {
public:
    A() { cout << "A::A()" << endl; }
    ~A() { cout << "A::~~A()" << endl; }
};
int main () {
    char* p = new char[sizeof(A)];
    A* ap = new (p) A;
    ap->A::~~A();
    delete [] p;
}

```

The statement `A* ap = new (p) A` dynamically creates a new object of type `A` not in the free store but in the memory allocated by `p`. The statement `delete [] p` will delete the storage allocated by `p`, but the run time will still believe that the object pointed to by `ap` still exists until you explicitly call the destructor of `A` (with the statement `ap->A::~~A()`).

Note: ▶ C++11 You can declare destructors as explicitly defaulted functions or deleted functions. For more information, see “Explicitly defaulted functions” on page 249 and “Deleted functions” on page 250. ▶ C++11 ◀

Related reference:

Chapter 15, “Special member functions (C++ only),” on page 385

Pseudo-destructors

A *pseudo-destructor* is a destructor of a nonclass type.

Pseudo-destructor syntax

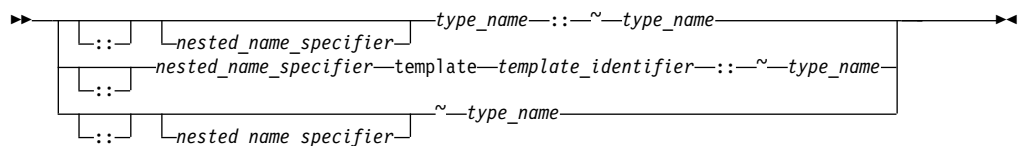

The following example calls the pseudo destructor for an integer type:

```

typedef int I;
int main() {
    I x = 10;
    x.I::~~I();
    x = 20;
}

```

The call to the pseudo destructor, `x.I::~~I()`, has no effect at all. Object `x` has not been destroyed; the assignment `x = 20` is still valid. Because pseudo destructors require the syntax for explicitly calling a destructor for a nonclass type to be valid, you can write code without having to know whether or not a destructor exists for a given type.

Related reference:

Chapter 13, “Class members and friends (C++ only),” on page 335

“Scope of class names” on page 329

User-defined conversions

User-defined conversions allow you to specify object conversions with constructors or with conversion functions. User-defined conversions are implicitly used in addition to standard conversions for conversion of initializers, functions arguments, function return values, expression operands, expressions controlling iteration, selection statements, and explicit type conversions.

There are two types of user-defined conversions:

- Conversion constructors
- Conversion functions

The compiler can use only one user-defined conversion (either a conversion constructor or a conversion function) when implicitly converting a single value. The following example demonstrates this:

```
class A {
    int x;
public:
    operator int() { return x; };
};

class B {
    A y;
public:
    operator A() { return y; };
};

int main () {
    B b_obj;
    // int i = b_obj;
    int j = A(b_obj);
}
```

The compiler would not allow the statement `int i = b_obj`. The compiler would have to implicitly convert `b_obj` into an object of type `A` (with `B::operator A()`), then implicitly convert that object to an integer (with `A::operator int()`). The statement `int j = A(b_obj)` explicitly converts `b_obj` into an object of type `A`, then implicitly converts that object to an integer.

User-defined conversions must be unambiguous, or they are not called. A conversion function in a derived class does not hide another conversion function in a base class unless both conversion functions convert to the same type. Function overload resolution selects the most appropriate conversion function. The following example demonstrates this:

```
class A {
    int a_int;
    char* a_carp;
public:
    operator int() { return a_int; }
    operator char*() { return a_carp; }
};

class B : public A {
    float b_float;
    char* b_carp;
public:
    operator float() { return b_float; }
    operator char*() { return b_carp; }
};
```

```

int main () {
    B b_obj;
    // long a = b_obj;
    char* c_p = b_obj;
}

```

The compiler would not allow the statement `long a = b_obj`. The compiler could either use `A::operator int()` or `B::operator float()` to convert `b_obj` into a `long`. The statement `char* c_p = b_obj` uses `B::operator char*()` to convert `b_obj` into a `char*` because `B::operator char*()` hides `A::operator char*()`.

When you call a constructor with an argument and you have not defined a constructor accepting that argument type, only standard conversions are used to convert the argument to another argument type acceptable to a constructor for that class. No other constructors or conversions functions are called to convert the argument to a type acceptable to a constructor defined for that class. The following example demonstrates this:



```

class A {
public:
    A() { }
    A(int) { }
};

int main() {
    A a1 = 1.234;
    // A moocow = "text string";
}

```

The compiler allows the statement `A a1 = 1.234`. The compiler uses the standard conversion of converting 1.234 into an `int`, then implicitly calls the converting constructor `A(int)`. The compiler would not allow the statement `A moocow = "text string"`; converting a text string to an integer is not a standard conversion.

Note:  You can declare user-defined conversions as deleted functions. For more information, see “Deleted functions” on page 250. 

Conversion constructors

A *conversion constructor* is a single-parameter constructor that is declared without the function specifier `explicit`. The compiler uses conversion constructors to convert objects from the type of the first parameter to the type of the conversion constructor's class. The following example demonstrates this:

```

class Y {
    int a, b;
    char* name;
public:
    Y(int i) { };
    Y(const char* n, int j = 0) { };
};

void add(Y) { };

int main() {

    // equivalent to
    // obj1 = Y(2)
    Y obj1 = 2;

    // equivalent to
    // obj2 = Y("somestring",0)
    Y obj2 = "somestring";
}

```

```

// equivalent to
// obj1 = Y(10)
obj1 = 10;

// equivalent to
// add(Y(5))
add(5);
}

```

The above example has the following two conversion constructors:

- `Y(int i)` which is used to convert integers to objects of class `Y`.
- `Y(const char* n, int j = 0)` which is used to convert pointers to strings to objects of class `Y`.

The compiler will not implicitly convert types as demonstrated above with constructors declared with the `explicit` keyword. The compiler will only use explicitly declared constructors in new expressions, the `static_cast` expressions and explicit casts, and the initialization of bases and members. The following example demonstrates this:

```

class A {
public:
    explicit A() { };
    explicit A(int) { };
};

int main() {
    A z;
    // A y = 1;
    A x = A(1);
    A w(1);
    A* v = new A(1);
    A u = (A)1;
    A t = static_cast<A>(1);
}

```

The compiler would not allow the statement `A y = 1` because this is an implicit conversion; class `A` has no conversion constructors.

A copy constructor is a conversion constructor.

Related reference:

“new expressions (C++ only)” on page 207

“The `static_cast` operator (C++ only)” on page 199

Explicit conversion constructors

The `explicit` function specifier controls unwanted implicit type conversions. It can only be used in declarations of constructors within a class declaration. For example, except for the default constructor, the constructors in the following class are conversion constructors.

```

class A
{ public:
    A();
    A(int);
    A(const char*, int = 0);
};

```

The following declarations are legal.

```

A c = 1;
A d = "Venditti";

```

The first declaration is equivalent to `A c = A(1)`.

If you declare the constructor of the class with the `explicit` keyword, the previous declarations would be illegal.

For example, if you declare the class as:

```
class A
{
public:
    explicit A();
    explicit A(int);
    explicit A(const char*, int = 0);
};
```

You can only assign values that match the values of the class type.

For example, the following statements are legal:

```
A a1;
A a2 = A(1);
A a3(1);
A a4 = A("Venditti");
A* p = new A(1);
A a5 = (A)1;
A a6 = static_cast<A>(1);
```

Related reference:

“Conversion constructors” on page 402

Conversion functions

You can define a member function of a class, called a *conversion function*, that converts from the type of its class to another specified type.

Conversion function syntax

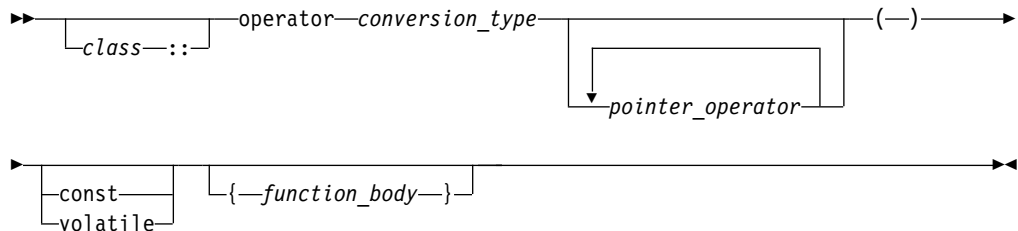

A conversion function that belongs to a class `X` specifies a conversion from the class type `X` to the type specified by the *conversion_type*. The following code fragment shows a conversion function called `operator int()`:

```
class Y {
    int b;
public:
    operator int();
};
Y::operator int() {
    return b;
}
void f(Y obj) {
    int i = int(obj);
    int j = (int)obj;
    int k = i + obj;
}
```

All three statements in function `f(Y)` use the conversion function `Y::operator int()`.

Classes, enumerations, typedef names, function types, or array types cannot be declared or defined in the *conversion_type*. You cannot use a conversion function to convert an object of type `A` to type `A`, to a base class of `A`, or to `void`.

Conversion functions have no arguments, and the return type is implicitly the conversion type. Conversion functions can be inherited. You can have virtual conversion functions but not static ones.

Related reference:

“Conversion constructors” on page 402

Explicit conversion operators (C++11)

Note: IBM supports selected features of C++11, known as C++0x before its ratification. IBM will continue to develop and implement the features of this standard. The implementation of the language level is based on IBM's interpretation of the standard. Until IBM's implementation of all the C++11 features is complete, including the support of a new C++11 standard library, the implementation might change from release to release. IBM makes no attempt to maintain compatibility, in source, binary, or listings and other compiler interfaces, with earlier releases of IBM's implementation of the new C++11 features.

You can apply the explicit function specifier to the definition of a user-defined conversion function to inhibit unintended implicit conversions from being applied. Such conversion functions are called explicit conversion operators.

Explicit conversion operator syntax

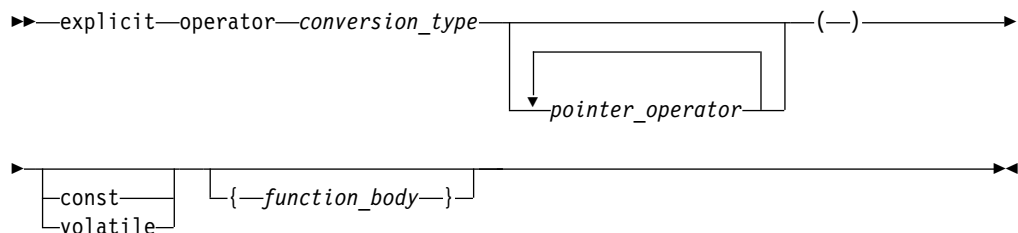

The following example demonstrates both intended and unintended implicit conversions through a user-defined conversion function, which is not qualified with the explicit function specifier.

Example 1

```
#include <iostream>

template <class T> struct S {
    operator bool() const; // conversion function
};

void func(S<int>& s) {

    // The compiler converts s to the bool type implicitly through
    // the conversion function. This conversion might be intended.
    if (s) { }
}
```

```

void bar(S<int>& p1, S<float>& p2) {
    // The compiler converts both p1 and p2 to the bool type implicitly
    // through the conversion function. This conversion might be unintended.
    std::cout << p1+p2 << std::endl;

    // The compiler converts both p1 and p2 to the bool type implicitly
    // through the conversion function and compares results.
    // This conversion might be unintended.
    if (p1==p2) { }
}

```

To inhibit unintended implicit conversions from being applied, you can define an explicit conversion operator by qualifying the conversion function in Example 1 with the `explicit` function specifier:

```
explicit operator bool() const;
```

If you compile the same code as Example 1 but with the explicit conversion operator, the compiler issues error messages for the following statements:

```
// Error: The call does not match any parameter list for "operator+".
std::cout << p1+p2 << std::endl;
```

```
// Error: The call does not match any parameter list for "operator==".
if(p1==p2)
```

If you intend to apply the conversion through the explicit conversion operator, you must call the explicit conversion operator explicitly as in the following statements, and then you can get the same results as Example 1.

```
std::cout << bool(p1)+bool(p2) << std::endl;
```

```
if(bool(p1)==bool(p2))
```

In contexts where a Boolean value is expected, such as when `&&`, `||`, or the conditional operator is used, or when the condition expression of an `if` statement is evaluated, an explicit `bool` conversion operator can be implicitly invoked. So when you compile Example 1 with the previous explicit conversion operator, the compiler also converts `s` in the `func` function to the `bool` type through the explicit `bool` conversion operator implicitly. Example 2 also demonstrates this:

Example 2

```

struct T {
    explicit operator bool(); //explicit bool conversion operator
};

int main() {
    T t1;
    bool t2;

    // The compiler converts t1 to the bool type through
    // the explicit bool conversion operator implicitly.
    t1 && t2;

    return 0;
}

```

Copy constructors

The *copy constructor* lets you create a new object from an existing one by initialization. A copy constructor of a class `A` is a non-template constructor in which the first parameter is of type `A&`, `const A&`, `volatile A&`, or `const volatile A&`, and the rest of its parameters (if there are any) have default values.

If you do not declare a copy constructor for a class A, the compiler will implicitly declare one for you, which will be an inline public member.

The following example demonstrates implicitly defined and user-defined copy constructors:

```
#include <iostream>
using namespace std;

struct A {
    int i;
    A() : i(10) { }
};

struct B {
    int j;
    B() : j(20) {
        cout << "Constructor B(), j = " << j << endl;
    }

    B(B& arg) : j(arg.j) {
        cout << "Copy constructor B(B&), j = " << j << endl;
    }

    B(const B&, int val = 30) : j(val) {
        cout << "Copy constructor B(const B&, int), j = " << j << endl;
    }
};

struct C {
    C() { }
    C(C&) { }
};

int main() {
    A a;
    A a1(a);
    B b;
    const B b_const;
    B b1(b);
    B b2(b_const);
    const C c_const;
    // C c1(c_const);
}
```

The following is the output of the above example:

```
Constructor B(), j = 20
Constructor B(), j = 20
Copy constructor B(B&), j = 20
Copy constructor B(const B&, int), j = 30
```

The statement `A a1(a)` creates a new object from `a` with an implicitly defined copy constructor. The statement `B b1(b)` creates a new object from `b` with the user-defined copy constructor `B::B(B&)`. The statement `B b2(b_const)` creates a new object with the copy constructor `B::B(const B&, int)`. The compiler would not allow the statement `C c1(c_const)` because a copy constructor that takes as its first parameter an object of type `const C&` has not been defined.

The implicitly declared copy constructor of a class A will have the form `A::A(const A&)` if the following are true:

- The direct and virtual bases of A have copy constructors whose first parameters have been qualified with `const` or `const volatile`

- The nonstatic class type or array of class type data members of A have copy constructors whose first parameters have been qualified with `const` or `const volatile`

If the above are not true for a class A, the compiler will implicitly declare a copy constructor with the form `A::A(A&)`.

A program is ill-formed if it includes a class A whose copy constructor is implicitly defined [C++11](#) or explicitly defaulted [C++11](#) when one or more of the following conditions are true:

- Class A has a nonstatic data member of a type which has an inaccessible or ambiguous copy constructor.
- Class A is derived from a class which has an inaccessible or ambiguous copy constructor.

The compiler will implicitly define an implicitly declared [C++11](#) or explicitly defaulted [C++11](#) constructor of a class A if you initialize an object of type A or an object derived from class A.

An implicitly defined [C++11](#) or explicitly defaulted [C++11](#) copy constructor will copy the bases and members of an object in the same order that a constructor would initialize the bases and members of the object.

Note: [C++11](#) You can declare copy constructors as explicitly defaulted functions or deleted functions. For more information, see “Explicitly defaulted functions” on page 249 and “Deleted functions” on page 250. [C++11](#)

Related reference:

“Overview of constructors and destructors” on page 385

Chapter 15, “Special member functions (C++ only),” on page 385

Copy assignment operators

The *copy assignment operator* lets you create a new object from an existing one by initialization. A copy assignment operator of a class A is a nonstatic non-template member function that has one of the following forms:

- `A::operator=(A)`
- `A::operator=(A&)`
- `A::operator=(const A&)`
- `A::operator=(volatile A&)`
- `A::operator=(const volatile A&)`

If you do not declare a copy assignment operator for a class A, the compiler will implicitly declare one for you that is inline public.

The following example demonstrates implicitly defined and user-defined copy assignment operators:

```
#include <iostream>
using namespace std;

struct A {
    A& operator=(const A&) {
        cout << "A::operator=(const A&)" << endl;
        return *this;
    }
}
```

```

    A& operator=(A&) {
        cout << "A::operator=(A&)" << endl;
        return *this;
    }

};
class B {
    A a;
};

struct C {
    C& operator=(C&) {
        cout << "C::operator=(C&)" << endl;
        return *this;
    }
    C() { }
};

int main() {
    B x, y;
    x = y;

    A w, z;
    w = z;

    C i;
    const C j();
    // i = j;
}

```

See the output of the above example:

```

A::operator=(const A&)
A::operator=(A&)

```

The assignment `x = y` calls the implicitly defined copy assignment operator of `B`, which calls the user-defined copy assignment operator `A::operator=(const A&)`. The assignment `w = z` calls the user-defined operator `A::operator=(A&)`. The compiler will not allow the assignment `i = j` because an operator `C::operator=(const C&)` has not been defined.

The implicitly declared copy assignment operator of a class `A` will have the form `A& A::operator=(const A&)` if the following statements are true:

- A direct or virtual base `B` of class `A` has a copy assignment operator whose parameter is of type `const B&`, `const volatile B&`, or `B`.
- A non-static class type data member of type `X` that belongs to class `A` has a copy constructor whose parameter is of type `const X&`, `const volatile X&`, or `X`.

If the above are not true for a class `A`, the compiler will implicitly declare a copy assignment operator with the form `A& A::operator=(A&)`.

The implicitly declared copy assignment operator returns an lvalue reference to the operator's argument.



The copy assignment operator of a derived class hides the copy assignment operator of its base class.

The compiler cannot allow a program in which a copy assignment operator for a class `A` is implicitly defined [➤ C++11](#) or explicitly defaulted [C++11 ◀](#) when one or more of the following conditions are true:

- Class `A` has a nonstatic data member of a `const` type or a reference type

- Class A has a nonstatic data member of a type which has an inaccessible copy assignment operator
- Class A is derived from a base class with an inaccessible copy assignment operator.

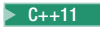
An implicitly defined copy assignment operator of a class A will first assign the direct base classes of A in the order that they appear in the definition of A. Next, the implicitly defined copy assignment operator will assign the nonstatic data members of A in the order of their declaration in the definition of A.

Note:  You can declare copy assignment operators as explicitly defaulted functions or deleted functions. For more information, see “Explicitly defaulted functions” on page 249 and “Deleted functions” on page 250. 

Related reference:

“Assignment operators” on page 181

Chapter 16. Templates (C++ only)

A *template* describes a set of related classes or set of related functions in which a list of parameters in the declaration describe how the members of the set vary. The compiler generates new classes or functions when you supply arguments for these parameters; this process is called *template instantiation*, and is described in detail in “Template instantiation” on page 433. This class or function definition generated from a template and a set of template parameters is called a *specialization*, as described in “Template specialization” on page 438.

Template declaration syntax

► `[export] template <—template_parameter_list—> —declaration—` ►

The compiler accepts and silently ignores the `export` keyword on a template.

The *template_parameter_list* is a comma-separated list of template parameters, which are described in “Template parameters” on page 412.

The *declaration* is one of the following options:

- a declaration or definition of a function or a class
- a definition of a member function or a member class of a class template
- a definition of a static data member of a class template
- a definition of a static data member of a class nested within a class template
- a definition of a member template of a class or class template

The *identifier* of a *type* is defined to be a *type_name* in the scope of the template declaration. A template declaration can appear as a namespace scope or class scope declaration.

The following example demonstrates the use of a class template:

```
template<class T> class Key
{
    T k;
    T* kptr;
    int length;
public:
    Key(T);
    // ...
};
```

Suppose the following declarations appear later:

```
Key<int> i;
Key<char*> c;
Key<mytype> m;
```

The compiler would create three instances of class `Key`. The following table shows the definitions of these three class instances if they were written out in source form as regular classes, not as templates:

<code>class Key<int> i;</code>	<code>class Key<char*> c;</code>	<code>class Key<mytype> m;</code>
<pre>class Key { int k; int * kptr; int length; public: Key(int); // ... };</pre>	<pre>class Key { char* k; char** kptr; int length; public: Key(char*); // ... };</pre>	<pre>class Key { mytype k; mytype* kptr; int length; public: Key(mytype); // ... };</pre>

Note that these three classes have different names. The arguments contained within the angle braces are not just the arguments to the class names, but part of the class names themselves. `Key<int>` and `Key<char*>` are class names.

Template parameters

There are three kinds of template parameters:

- “Type template parameters”
- “Non-type template parameters”
- “Template template parameters” on page 413

► C++11

Template parameter packs can also be a kind of template parameter. For more information, see “Variadic templates (C++11)” on page 446.

◀ C++11

You can interchange the keywords `class` and `typename` in a template parameter declaration. You cannot use storage class specifiers (`static` and `auto`) in a template parameter declaration.

Related reference:

“Type qualifiers” on page 98

“Lvalues and rvalues” on page 159

Type template parameters

Type template parameter declaration syntax

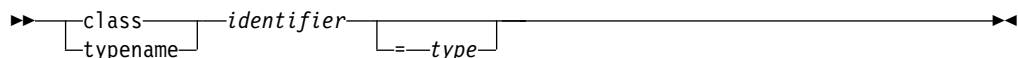

The *identifier* is the name of a type.

Related reference:

“The `typename` keyword” on page 459

Non-type template parameters

The syntax of a non-type template parameter is the same as a declaration of one of the following types:

- integral or enumeration
- pointer to object or pointer to function

- lvalue reference to object or lvalue reference to function
- pointer to member
- `std::nullptr_t`

Non-type template parameters that are declared as arrays are converted to pointers, and that are declared as functions are converted to pointers to functions. The following example demonstrates these rules:

```
template<int a[4]> struct A { };
template<int f(int)> struct B { };

int i;
int g(int) { return 0;}

A<&i> x;
B<&g> y;
```

The type of `&i` is `int *`, and the type of `&g` is `int (*)(int)`.

You can qualify a non-type template parameter with `const` or `volatile`.

You cannot declare a non-type template parameter as a floating point, class, or void type.

Non-type non-reference template parameters are not lvalues.

Related reference:

- “Type qualifiers” on page 98
- “Lvalues and rvalues” on page 159
- “References (C++ only)” on page 123

Template template parameters

Template template parameter declaration syntax

```
template<template-parameter-list> class identifier = id-expression
```

The following example demonstrates a declaration and use of a template template parameter:

```
template<template <class T> class X> class A { };
template<class T> class B { };

A<B> a;
```

Default arguments for template parameters

Template parameters may have default arguments. The set of default template arguments accumulates over all declarations of a given template. The following example demonstrates this:

```
template<class T, class U = int> class A;
template<class T = float, class U> class A;

template<class T, class U> class A {
public:
    T x;
```

```

        U y;
};
A<> a;

```

The type of member `a.x` is `float`, and the type of `a.y` is `int`.

You cannot give default arguments to the same template parameters in different declarations in the same scope. The compiler will not allow the following example:

```

template<class T = char> class X;
template<class T = char> class X { };

```

If one template parameter has a default argument, then all template parameters following it must also have default arguments. For example, the compiler will not allow the following:

```

template<class T = char, class U, class V = int> class X { };

```

Template parameter `U` needs a default argument or the default for `T` must be removed.

The scope of a template parameter starts from the point of its declaration to the end of its template definition. This implies that you may use the name of a template parameter in other template parameter declarations and their default arguments. The following example demonstrates this:

```

template<class T = int> class A;
template<class T = float> class B;
template<class V, V obj> class C;
// a template parameter (T) used as the default argument
// to another template parameter (U)
template<class T, class U = T> class D { };

```

Naming template parameters as friends (C++11)

Note: IBM supports selected features of C++11, known as C++0x before its ratification. IBM will continue to develop and implement the features of this standard. The implementation of the language level is based on IBM's interpretation of the standard. Until IBM's implementation of all the C++11 features is complete, including the support of a new C++11 standard library, the implementation might change from release to release. IBM makes no attempt to maintain compatibility, in source, binary, or listings and other compiler interfaces, with earlier releases of IBM's implementation of the new C++11 features.

In the C++11 standard, the extended friend declarations feature is introduced, with which you can declare template parameters as friends. This makes friend declarations inside templates easier to use.

If a friend declaration resolves to a template parameter, then you cannot use an elaborated-type-specifier in this friend declaration; otherwise, the compiler issues an error.

Related reference:

“Friends” on page 351

Template arguments

There are three kinds of template arguments corresponding to the three types of template parameters:

- “Template type arguments”
- “Template non-type arguments” on page 416
- “Template template arguments” on page 418

A template argument must match the type and form specified by the corresponding parameter declared in the template.

> C++11

When a parameter declared in a template is a template parameter pack, it corresponds to zero or more template arguments. For more information, see “Variadic templates (C++11)” on page 446

C++11 <

To use the default value of a template parameter, you omit the corresponding template argument. However, even if all template parameters have defaults, you still must use the angle brackets <>. For example, the following will yield a syntax error:

```
template<class T = int> class X { };
X<> a;
X b;
```

The last declaration, `X b`, will yield an error.

Related reference:

“Block/local scope” on page 6

“No linkage” on page 12

Bit field members

“typedef definitions” on page 86

Template type arguments

You cannot use one of the following types as a template argument for a type template parameter:

- a local type
- a type with no linkage
- an unnamed type
- a type compounded from any of the above types

If it is ambiguous whether a template argument is a type or an expression, the template argument is considered to be a type. The following example demonstrates this:

```
template<class T> void f() { };
template<int i> void f() { };

int main() {
    f<int>(>());
}
```

The function call `f<int()>()` calls the function with `T` as a template argument – the compiler considers `int()` as a type – and therefore implicitly instantiates and calls the first `f()`.

Related reference:

“Block/local scope” on page 6

“No linkage” on page 12

Bit field members

“typedef definitions” on page 86

Template non-type arguments

A non-type template argument provided within a template argument list is an expression whose value can be determined at compile time. Such arguments must be constant expressions, addresses of functions or objects with external linkage, or addresses of static class members. Non-type template arguments are normally used to initialize a class or to specify the sizes of class members.

For non-type integral arguments, the instance argument matches the corresponding template parameter as long as the instance argument has a value and sign appropriate to the parameter type.

For non-type address arguments, the type of the instance argument must be of the form *identifier* or *&identifier*, and the type of the instance argument must match the template parameter exactly, except that a function name is changed to a pointer to function type before matching.

The resulting values of non-type template arguments within a template argument list form part of the template class type. If two template class names have the same template name and if their arguments have identical values, they are the same class.

In the following example, a class template is defined that requires a non-type template `int` argument as well as the type argument:

```
template<class T, int size> class Myfilebuf
{
    T* filepos;
    static int array[size];
public:
    Myfilebuf() { /* ... */ }
    ~Myfilebuf();
    advance(); // function defined elsewhere in program
};
```

In this example, the template argument `size` becomes a part of the template class name. An object of such a template class is created with both the type argument `T` of the class and the value of the non-type template argument `size`.

An object `x`, and its corresponding template class with arguments `double` and `size=200`, can be created from this template with a value as its second template argument:

```
Myfilebuf<double,200> x;
```

`x` can also be created using an arithmetic expression:

```
Myfilebuf<double,10*20> x;
```

The objects created by these expressions are identical because the template arguments evaluate identically. The value 200 in the first expression could have been represented by an expression whose result at compile time is known to be equal to 200, as shown in the second construction.

Note: Arguments that contain the < symbol or the > symbol must be enclosed in parentheses to prevent either symbol from being parsed as a template argument list delimiter when it is in fact being used as a relational operator. For example, the arguments in the following definition are valid:

```
Myfilebuf<double, (75>25)> x;          // valid
```

The following definition, however, is not valid because the greater than operator (>) is interpreted as the closing delimiter of the template argument list:

```
Myfilebuf<double, 75>25> x;          // error
```

If the template arguments do not evaluate identically, the objects created are of different types:

```
Myfilebuf<double,200> x;              // create object x of class
                                     // Myfilebuf<double,200>
Myfilebuf<double,200.0> y;            // error, 200.0 is a double,
                                     // not an int
```

The instantiation of `y` fails because the value `200.0` is of type `double`, and the template argument is of type `int`.

The following two objects:

```
Myfilebuf<double, 128> x
Myfilebuf<double, 512> y
```

are objects of separate template specializations. Referring either of these objects later with `Myfilebuf<double>` is an error.

A class template does not need to have a type argument if it has non-type arguments. For example, the following template is a valid class template:

```
template<int i> class C
{
    public:
        int k;
        C() { k = i; }
};
```

This class template can be instantiated by declarations such as:

```
class C<100>;
class C<200>;
```

Again, these two declarations refer to distinct classes because the values of their non-type arguments differ.

Related reference:

“Integer constant expressions” on page 162

“References (C++ only)” on page 123

“External linkage” on page 12

“Static members” on page 344

Template template arguments

A template argument for a template template parameter is the name of a class template.

When the compiler tries to find a template to match the template template argument, it only considers primary class templates. (A *primary template* is the template that is being specialized.) The compiler will not consider any partial specialization even if their parameter lists match that of the template template parameter. For example, the compiler will not allow the following code:

```
template<class T, int i> class A {
    int x;
};

template<class T> class A<T, 5> {
    short x;
};

template<template<class T> class U> class B1 { };

B1<A> c;
```

The compiler will not allow the declaration `B1<A> c`. Although the partial specialization of `A` seems to match the template template parameter `U` of `B1`, the compiler considers only the primary template of `A`, which has different template parameters than `U`.

The compiler considers the partial specializations based on a template template argument once you have instantiated a specialization based on the corresponding template template parameter. The following example demonstrates this:

```
#include <iostream>
#include <typeinfo>

using namespace std;

template<class T, class U> class A {
public:
    int x;
};

template<class U> class A<int, U> {
public:
    short x;
};

template<template<class T, class U> class V> class B {
    V<int, char> i;
    V<char, char> j;
};

B<A> c;

int main() {
    cout << typeid(c.i.x).name() << endl;
    cout << typeid(c.j.x).name() << endl;
}
```

The following is the output of the above example:

```
short
int
```

The declaration `V<int, char> i` uses the partial specialization while the declaration `V<char, char> j` uses the primary template.

Related reference:

“Partial specialization” on page 443

“Template instantiation” on page 433

Class templates

The relationship between a class template and an individual class is like the relationship between a class and an individual object. An individual class defines how a group of objects can be constructed, while a class template defines how a group of classes can be generated.

Note the distinction between the terms *class template* and *template class*:

Class template

is a template used to generate template classes. You cannot declare an object of a class template.

Template class

is an instance of a class template.

A template definition is identical to any valid class definition that the template might generate, except for the following:

- The class template definition is preceded by

```
template< template-parameter-list >
```

where *template-parameter-list* is a comma-separated list of one or more of the following kinds of template parameters:

- type
 - non-type
 - template
- Types, variables, constants and objects within the class template can be declared using the template parameters as well as explicit types (for example, `int` or `char`).

> C++11

Template parameter packs can also be a kind of parameter for class templates. For more information, see “Variadic templates (C++11)” on page 446.

C++11 <

A class template can be declared without being defined by using an elaborated type specifier. For example:

```
template<class L, class T> class Key;
```

This reserves the name as a class template name. All template declarations for a class template must have the same types and number of template arguments. Only one template declaration containing the class definition is allowed.

> C++11

By using template parameter packs, template declarations for a class template can have fewer or more arguments than the number of parameters specified in the

class template.

C++11 <

Note: When you have nested template argument lists, you must have a separating space between the > at the end of the inner list and the > at the end of the outer list. Otherwise, there is an ambiguity between the extraction operator >> and two template list delimiters >.

```
template<class L, class T> class Key { /* ... */};
template<class L> class Vector { /* ... */ };

int main ()
{
    class Key <int, Vector<int> > my_key_vector;
    // implicitly instantiates template
}
```

> C++11

When the right angle bracket feature is enabled, the >> token is treated as two consecutive > tokens if both the following conditions are true:

- The >> token is in a context where one or more left angle brackets are active. A left angle bracket is active when it is not yet matched by a right angle bracket.
- The >> token is not nested within a delimited expression context.

If the first > token is in the context of a `template_parameter_list`, it is treated as the ending delimiter for the `template_parameter_list`. Otherwise, it is treated as the greater-than operator. The second > token terminates an enclosing `template_id` construct or a different construct, such as the `const_cast`, `dynamic_cast`, `reinterpret_cast`, or `static_cast` operator. For example:

```
template<typename T> struct list {};
template<typename T>

struct vector
{
    operator T() const;
};

int main()
{
    // Valid, same as vector<vector<int> > v;
    vector<vector<int>> v;

    // Valid, treat the >> token as two consecutive > tokens.
    // The first > token is treated as the ending delimiter for the
    // template_parameter_list, and the second > token is treated as
    // the ending delimiter for the static_cast operator.
    const vector<int> vi = static_cast<vector<int>>(v);
}
```

A parenthesized expression is a delimited expression context. To use a bitwise shift operator inside `template-argument-list`, use parentheses to enclose the operator. For example:

```
template <int i> class X {};
template <class T> class Y {};

Y<X<(6>>1)>> y;           //Valid: 6>>1 uses the right shift operator
```

C++11 <

Objects and function members of individual template classes can be accessed by any of the techniques used to access ordinary class member objects and functions. Given a class template:

```
template<class T> class Vehicle
{
public:
    Vehicle() { /* ... */ } // constructor
    ~Vehicle() {}; // destructor
    T kind[16];
    T* drive();
    static void roadmap();
    // ...
};
```

and the declaration:

```
Vehicle<char> bicycle; // instantiates the template
```

the constructor, the constructed object, and the member function `drive()` can be accessed with any of the following (assuming the standard header file `string.h` is included in the program file):

constructor	<code>Vehicle<char> bicycle;</code> <code>// constructor called automatically,</code> <code>// object bicycle created</code>
object bicycle	<code>strcpy (bicycle.kind, "10 speed");</code> <code>bicycle.kind[0] = '2';</code>
function <code>drive()</code>	<code>char* n = bicycle.drive();</code>
function <code>roadmap()</code>	<code>Vehicle<char>::roadmap();</code>

Related reference:

“Declaring class types” on page 325

“Scope of class names” on page 329

“Member functions” on page 337

“The `static_cast` operator (C++ only)” on page 199

“The `dynamic_cast` operator (C++ only)” on page 204

“The `const_cast` operator (C++ only)” on page 202

“The `reinterpret_cast` operator (C++ only)” on page 200

Class template declarations and definitions

A class template must be declared before any instantiation of a corresponding template class. A class template definition can only appear once in any single translation unit. A class template must be defined before any use of a template class that requires the size of the class or refers to members of the class.

In the following example, the class template `Key` is declared before it is defined. The declaration of the pointer `keyiptr` is valid because the size of the class is not needed. The declaration of `keyi`, however, causes an error.

```
template <class L> class Key; // class template declared,
                             // not defined yet
                             //
class Key<int> *keyiptr; // declaration of pointer
                             //
class Key<int> keyi; // error, cannot declare keyi
```

```

// without knowing size
//
template <class L> class Key // now class template defined
{ /* ... */ };

```

If a template class is used before the corresponding class template is defined, the compiler issues an error. A class name with the appearance of a template class name is considered to be a template class. In other words, angle brackets are valid in a class name only if that class is a template class.

The previous example uses the elaborated type specifier `class` to declare the class template `key` and the pointer `keyiptr`. The declaration of `keyiptr` can also be made without the elaborated type specifier.

```

template <class L> class Key; // class template declared,
// not defined yet
//
Key<int> *keyiptr; // declaration of pointer
//
Key<int> keyi; // error, cannot declare keyi
// without knowing size
//
template <class L> class Key // now class template defined
{ /* ... */ };

```

Related reference:

“Class templates” on page 419



See `-qtmplparse` in the XL C/C++ Compiler Reference

Static data members and templates

Each class template instantiation has its own copy of any static data members. The static declaration can be of template argument type or of any defined type.

You must separately define static members. The following example demonstrates this:

```

template <class T> class K
{
public:
    static T x;
};
template <class T> T K<T> ::x;

int main()
{
    K<int>::x = 0;
}

```

The statement `template T K::x` defines the static member of class `K`, while the statement in the `main()` function assigns a value to the data member for `K <int>`.

Related reference:

“Static members” on page 344

Member functions of class templates

You may define a template member function outside of its class template definition.

When you call a member function of a class template specialization, the compiler will use the template arguments that you used to generate the class template. The following example demonstrates this:

```

template<class T> class X {
public:
    T operator+(T);
};

template<class T> T X<T>::operator+(T arg1) {
    return arg1;
};

int main() {
    X<char> a;
    X<int> b;
    a + 'z';
    b + 4;
}

```

The overloaded addition operator has been defined outside of class `X`. The statement `a + 'z'` is equivalent to `a.operator+'z')`. The statement `b + 4` is equivalent to `b.operator+(4)`.

► C++11

You can use trailing return types for template member functions, including those that have the following kinds of return types:

- Return types depending on the types of the function arguments
- Complicated return types

For more information, see “Trailing return type (C++11)” on page 266.

► C++11 ◀

Related reference:

“Member functions” on page 337

Friends and templates

There are four kinds of relationships between classes and their friends when templates are involved:

- *One-to-many*: A non-template function may be a friend to all template class instantiations.
- *Many-to-one*: All instantiations of a template function may be friends to a regular non-template class.
- *One-to-one*: A template function instantiated with one set of template arguments may be a friend to one template class instantiated with the same set of template arguments. This is also the relationship between a regular non-template class and a regular non-template friend function.
- *Many-to-many*: All instantiations of a template function may be a friend to all instantiations of the template class.

The following example demonstrates these relationships:

```

class B{
    template<class V> friend int j();
}

template<class S> g();

template<class T> class A {
    friend int e();
}

```

```

    friend int f(T);
    friend int g<T>();
    template<class U> friend int h();
};

```

- Function e() has a one-to-many relationship with class A. Function e() is a friend to all instantiations of class A.
- Function f() has a one-to-one relationship with class A. The compiler will give you a warning for this kind of declaration similar to the following:
The friend function declaration "f" will cause an error when the enclosing template class is instantiated with arguments that declare a friend function that does not match an existing definition. The function declares only one function because it is not a template but the function type depends on one or more template parameters.
- Function g() has a one-to-one relationship with class A. Function g() is a function template. It must be declared before here or else the compiler will not recognize g<T> as a template name. For each instantiation of A there is one matching instantiation of g(). For example, g<int> is a friend of A<int>.
- Function h() has a many-to-many relationship with class A. Function h() is a function template. For all instantiations of A all instantiations of h() are friends.
- Function j() has a many-to-one relationship with class B.

These relationships also apply to friend classes.

Related reference:

“Friends” on page 351

Function templates

A *function template* defines how a group of functions can be generated.

A non-template function is not related to a function template, even though the non-template function may have the same name and parameter profile as those of a specialization generated from a template. A non-template function is never considered to be a specialization of a function template.

The following example implements the quicksort algorithm with a function template named quicksort:

```

#include <iostream>
#include <cstdlib>
using namespace std;

template<class T> void quicksort(T a[], const int& leftarg, const int& rightarg)
{
    if (leftarg < rightarg) {

        T pivotvalue = a[leftarg];
        int left = leftarg - 1;
        int right = rightarg + 1;

        for(;;) {

            while (a[--right] > pivotvalue);
            while (a[++left] < pivotvalue);

            if (left >= right) break;

            T temp = a[right];
            a[right] = a[left];
            a[left] = temp;
        }
    }
}

```

```

        int pivot = right;
        quicksort(a, leftarg, pivot);
        quicksort(a, pivot + 1, rightarg);
    }
}

int main(void) {
    int sortme[10];

    for (int i = 0; i < 10; i++) {
        sortme[i] = rand();
        cout << sortme[i] << " ";
    };
    cout << endl;

    quicksort<int>(sortme, 0, 10 - 1);

    for (int i = 0; i < 10; i++) cout << sortme[i] << "
";
    cout << endl;
    return 0;
}

```

The above example will have output similar to the following:

```

16838 5758 10113 17515 31051 5627 23010 7419 16212 4086
4086 5627 5758 7419 10113 16212 16838 17515 23010 31051

```

This quicksort algorithm will sort an array of type `T` (whose relational and assignment operators have been defined). The template function takes one template argument and three function arguments:

- the type of the array to be sorted, `T`
- the name of the array to be sorted, `a`
- the lower bound of the array, `leftarg`
- the upper bound of the array, `rightarg`

In the above example, you can also call the `quicksort()` template function with the following statement:

```
quicksort(sortme, 0, 10 - 1);
```

You may omit any template argument if the compiler can deduce it by the usage and context of the template function call. In this case, the compiler deduces that `sortme` is an array of type `int`.

> C++11

Template parameter packs can be a kind of template parameter for function templates, and *function parameter packs* can be a kind of function parameter for function templates. For more information, see “Variadic templates (C++11)” on page 446.

You can use trailing return types for function templates, include those that have the following kinds of return types:

- Return types depending on the types of the function arguments
- Complicated return types

For more information, see “Trailing return type (C++11)” on page 266.

Template argument deduction

When you call a template function, you may omit any template argument that the compiler can determine or *deduce* by the usage and context of that template function call.

The compiler tries to deduce a template argument by comparing the type of the corresponding template parameter with the type of the argument used in the function call. The two types that the compiler compares (the template parameter and the argument used in the function call) must be of a certain structure in order for template argument deduction to work. The following lists these type structures:

```
T
const T
volatile T
T&
T&&
T*
T[10]
A<T>
C(*) (T)
T(*) ()
T(*) (U)
T C::*
C T::*
T U::*
T (C::* )()
C (T::* )()
D (C::* ) (T)
C (T::* ) (U)
T (C::* ) (U)
T (U::* ) ()
T (U::* ) (V)
E[10][i]
B<i>
TT<T>
TT<i>
TT<C>
```

- T, U, and V represent a template type argument
- 10 represents any integer constant
- i represents a template non-type argument
- [i] represents an array bound of a reference or pointer type, or a non-major array bound of a normal array.
- TT represents a template template argument
- (T), (U), and (V) represents an argument list that has at least one template type argument
- () represents an argument list that has no template arguments
- <T> represents a template argument list that has at least one template type argument
- <i> represents a template argument list that has at least one template non-type argument
- <C> represents a template argument list that has no template arguments dependent on a template parameter

The following example demonstrates the use of each of these type structures. The example declares a template function using each of the above structures as an

argument. These functions are then called (without template arguments) in order of declaration. The example outputs the same list of type structures:

```
#include <iostream>
using namespace std;

template<class T> class A { };
template<int i> class B { };

class C {
public:
    int x;
};

class D {
public:
    C y;
    int z;
};

template<class T> void f (T)           { cout << "T" << endl; };
template<class T> void f1(const T)     { cout << "const T" << endl; };
template<class T> void f2(volatile T) { cout << "volatile T" << endl; };
template<class T> void g (T*)         { cout << "T*" << endl; };
template<class T> void g (T&)         { cout << "T&" << endl; };
template<class T> void g1(T[10])      { cout << "T[10]" << endl; };
template<class T> void h1(A<T>)       { cout << "A<T>" << endl; };

void test_1() {
    A<char> a;
    C c;

    f(c);   f1(c);   f2(c);
    g(c);   g(&c);   g1(&c);
    h1(a);
}

template<class T>          void j(C*(T)) { cout << "C(*) (T)" << endl; };
template<class T>          void j(T*( )) { cout << "T(*) ( )" << endl; };
template<class T, class U> void j(T*(U)) { cout << "T(*) (U)" << endl; };

void test_2() {
    C (*c_pfunct1)(int);
    C (*c_pfunct2)(void);
    int (*c_pfunct3)(int);
    j(c_pfunct1);
    j(c_pfunct2);
    j(c_pfunct3);
}

template<class T>          void k(T C::*) { cout << "T C::*" << endl; };
template<class T>          void k(C T::*) { cout << "C T::*" << endl; };
template<class T, class U> void k(T U::*) { cout << "T U::*" << endl; };

void test_3() {
    k(&C::x);
    k(&D::y);
    k(&D::z);
}

template<class T>          void m(T (C::*)() )
    { cout << "T (C::*)()" << endl; };
template<class T>          void m(C (T::*)() )
    { cout << "C (T::*)()" << endl; };
template<class T>          void m(D (C::*)(T))
    { cout << "D (C::*)(T)" << endl; };
template<class T, class U> void m(C (T::*)(U))
```

```

    { cout << "C (T::*)(U)" << endl; };
template<class T, class U> void m(T (C::*)(U))
    { cout << "T (C::*)(U)" << endl; };
template<class T, class U> void m(T (U::*)() )
    { cout << "T (U::*)()" << endl; };
template<class T, class U, class V> void m(T (U::*)(V))
    { cout << "T (U::*)(V)" << endl; };

void test_4() {
    int (C::*f_membp1)(void);
    C (D::*f_membp2)(void);
    D (C::*f_membp3)(int);
    m(f_membp1);
    m(f_membp2);
    m(f_membp3);

    C (D::*f_membp4)(int);
    int (C::*f_membp5)(int);
    int (D::*f_membp6)(void);
    m(f_membp4);
    m(f_membp5);
    m(f_membp6);

    int (D::*f_membp7)(int);
    m(f_membp7);
}

template<int i> void n(C[10][i]) { cout << "E[10][i]" << endl; };
template<int i> void n(B<i>) { cout << "B<i>" << endl; };

void test_5() {
    C array[10][20];
    n(array);
    B<20> b;
    n(b);
}

template<template<class> class TT, class T> void p1(TT<T>)
    { cout << "TT<T>" << endl; };
template<template<int> class TT, int i> void p2(TT<i>)
    { cout << "TT<i>" << endl; };
template<template<class> class TT> void p3(TT<C>)
    { cout << "TT<C>" << endl; };

void test_6() {
    A<char> a;
    B<20> b;
    A<C> c;
    p1(a);
    p2(b);
    p3(c);
}

int main() { test_1(); test_2(); test_3(); test_4(); test_5(); test_6(); }

```

Deducing type template arguments

The compiler can deduce template arguments from a type composed of several of the listed type structures. The following example demonstrates template argument deduction for a type composed of several type structures:

```

template<class T> class Y { };

template<class T, int i> class X {
public:
    Y<T> f(char[20][i]) { return x; };
    Y<T> x;
};

```

```

};

template<template<class> class T, class U, class V, class W, int i>
    void g( T<U> (V::*)(W[20][i]) ) { };

int main()
{
    Y<int> (X<int, 20>::*p)(char[20][20]) = &X<int, 20>::f;
    g(p);
}

```

The type `Y<int> (X<int, 20>::*p)(char[20][20])T<U> (V::*)(W[20][i])` is based on the type structure `T (U::*)(V)`:

- T is `Y<int>`
- U is `X<int, 20>`
- V is `char[20][20]`

If you qualify a type with the class to which that type belongs, and that class (a *nested name specifier*) depends on a template parameter, the compiler will not deduce a template argument for that parameter. If a type contains a template argument that cannot be deduced for this reason, all template arguments in that type will not be deduced. The following example demonstrates this:

```

template<class T, class U, class V>
    void h(typename Y<T>::template Z<U>, Y<T>, Y<V>) { };

int main() {
    Y<int>::Z<char> a;
    Y<int> b;
    Y<float> c;

    h<int, char, float>(a, b, c);
    h<int, char>(a, b, c);
    // h<int>(a, b, c);
}

```

The compiler will not deduce the template arguments T and U in `typename Y<T>::template Z<U>` (but it will deduce the T in `Y<T>`). The compiler would not allow the template function call `h<int>(a, b, c)` because U is not deduced by the compiler.

The compiler can deduce a function template argument from a pointer to function or pointer to member function argument given several overloaded function names. However, none of the overloaded functions may be function templates, nor can more than one overloaded function match the required type. The following example demonstrates this:

```

template<class T> void f(void(*) (T,int)) { };

template<class T> void g1(T, int) { };

void g2(int, int) { };
void g2(char, int) { };

void g3(int, int, int) { };
void g3(float, int) { };

int main() {
    // f(&g1);
    // f(&g2);
    f(&g3);
}

```

The compiler would not allow the call `f(&g1)` because `g1()` is a function template. The compiler would not allow the call `f(&g2)` because both functions named `g2()` match the type required by `f()`.

The compiler cannot deduce a template argument from the type of a default argument. The following example demonstrates this:

```
template<class T> void f(T = 2, T = 3) { };

int main() {
    f(6);
    // f();
    f<int>();
}
```

The compiler allows the call `f(6)` because the compiler deduces the template argument (`int`) by the value of the function call's argument. The compiler would not allow the call `f()` because the compiler cannot deduce template argument from the default arguments of `f()`.

The compiler cannot deduce a template type argument from the type of a non-type template argument. For example, the compiler will not allow the following:

```
template<class T, T i> void f(int[20][i]) { };

int main() {
    int a[20][30];
    f(a);
}
```

The compiler cannot deduce the type of template parameter `T`.

> C++11

If a template type parameter of a function template is a cv-unqualified rvalue reference, but the argument in the function call is an lvalue, the corresponding lvalue reference is used instead of the rvalue reference. However, if the template type parameter is a cv-qualified rvalue reference, and the argument in the function call is an lvalue, the template instantiation fails. For example:

```
template <class T> double func1(T&&);
template <class T> double func2(const T&&);

int var;

// The compiler calls func1<int&>(int&)
double a = func1(var);

// The compiler calls func1<int>(int&&)
double b = func1(1);

// error
double c = func2(var);

// The compiler calls func2<int>(const int&&)
double d = func2(1);
```

In this example, the template type parameter of the function template `func1` is a cv-unqualified rvalue reference, and the template type parameter of the function template `func2` is a cv-qualified rvalue reference. In the initialization of variable `a`, the template argument `var` is an lvalue, so the lvalue reference type `int&` is used in the instantiation of the function template `func1`. In the initialization of variable `b`,

the template argument 1 is an rvalue, so the rvalue reference type `int&&` remains in the template instantiation. In the initialization of `c`, the template type parameter `T&&` is cv-qualified, but `var` is an lvalue, so `var` cannot be bound to the rvalue reference `T&&`.

C++11 <

Deducing non-type template arguments

The compiler cannot deduce the value of a major array bound unless the bound refers to a reference or pointer type. Major array bounds are not part of function parameter types. The following code demonstrates this:

```
template<int i> void f(int a[10][i]) { };
template<int i> void g(int a[i]) { };
template<int i> void h(int (&a)[i]) { };

int main () {
    int b[10][20];
    int c[10];
    f(b);
    // g(c);
    h(c);
}
```

The compiler would not allow the call `g(c)`; the compiler cannot deduce template argument `i`.

The compiler cannot deduce the value of a non-type template argument used in an expression in the template function's parameter list. The following example demonstrates this:

```
template<int i> class X { };

template<int i> void f(X<i - 1>) { };

int main () {
    X<0> a;
    f<1>(a);
    // f(a);
}
```

To call function `f()` with object `a`, the function must accept an argument of type `X<0>`. However, the compiler cannot deduce that the template argument `i` must be equal to 1 in order for the function template argument type `X<i - 1>` to be equivalent to `X<0>`. Therefore the compiler would not allow the function call `f(a)`.

If you want the compiler to deduce a non-type template argument, the type of the parameter must match exactly the type of value used in the function call. For example, the compiler will not allow the following:

```
template<int i> class A { };
template<short d> void f(A<d>) { };

int main() {
    A<1> a;
    f(a);
}
```

The compiler will not convert `int` to `short` when the example calls `f()`.

However, deduced array bounds may be of any integral type.

➤ C++11

Template argument deduction also applies to the variadic templates feature. For more information, see “Variadic templates (C++11)” on page 446.

C++11 ◀

Related reference:

“References (C++ only)” on page 123

“Lvalues and rvalues” on page 159

Overloading function templates

You may overload a function template either by a non-template function or by another function template.

If you call the name of an overloaded function template, the compiler will try to deduce its template arguments and check its explicitly declared template arguments. If successful, it will instantiate a function template specialization, then add this specialization to the set of *candidate functions* used in overload resolution. The compiler proceeds with overload resolution, choosing the most appropriate function from the set of candidate functions. Non-template functions take precedence over template functions. The following example describes this:

```
#include <iostream>
using namespace std;

template<class T> void f(T x, T y) { cout << "Template" << endl; }

void f(int w, int z) { cout << "Non-template" << endl; }

int main() {
    f( 1, 2 );
    f('a', 'b');
    f( 1, 'b');
}
```

The following is the output of the above example:

```
Non-template
Template
Non-template
```

The function call `f(1, 2)` could match the argument types of both the template function and the non-template function. The non-template function is called because a non-template function takes precedence in overload resolution.

The function call `f('a', 'b')` can only match the argument types of the template function. The template function is called.

Argument deduction fails for the function call `f(1, 'b')`; the compiler does not generate any template function specialization and overload resolution does not take place. The non-template function resolves this function call after using the standard conversion from `char` to `int` for the function argument `'b'`.

Related reference:

“Overload resolution” on page 315

Partial ordering of function templates

A function template specialization might be ambiguous because template argument deduction might associate the specialization with more than one of the overloaded definitions. The compiler will then choose the definition that is the most specialized. This process of selecting a function template definition is called *partial ordering*.

A template X is more specialized than a template Y if every argument list that matches the one specified by X also matches the one specified by Y, but not the other way around. The following example demonstrates partial ordering:

```
template<class T> void f(T) { }
template<class T> void f(T*) { }
template<class T> void f(const T*) { }

template<class T> void g(T) { }
template<class T> void g(T&) { }

template<class T> void h(T) { }
template<class T> void h(T, ...) { }

int main() {
    const int *p;
    f(p);

    int q;
    // g(q);
    // h(q);
}
```

The declaration `template<class T> void f(const T*)` is more specialized than `template<class T> void f(T*)`. Therefore, the function call `f(p)` calls `template<class T> void f(const T*)`. However, neither `void g(T)` nor `void g(T&)` is more specialized than the other. Therefore, the function call `g(q)` would be ambiguous.

Ellipses do not affect partial ordering. Therefore, the function call `h(q)` would also be ambiguous.

The compiler uses partial ordering in the following cases:

- Calling a function template specialization that requires overload resolution.
- Taking the address of a function template specialization.
- When a friend function declaration, an explicit instantiation, or explicit specialization refers to a function template specialization.
- Determining the appropriate deallocation function that is also a function template for a given placement operator `new`.

Related reference:

“Template specialization” on page 438

“new expressions (C++ only)” on page 207

Template instantiation

The act of creating a new definition of a function, class, or member of a class from a template declaration and one or more template arguments is called *template instantiation*. The definition created from a template instantiation to handle a specific set of template arguments is called a *specialization*.

Template instantiation has two forms: explicit instantiation and implicit instantiation.

Related reference:

“Template specialization” on page 438

Explicit instantiation

You can explicitly tell the compiler when it should generate a definition from a template. This is called *explicit instantiation*. Explicit instantiation includes two forms: *explicit instantiation declaration* and *explicit instantiation definition*.

C++11

Note: IBM supports selected features of C++11, known as C++0x before its ratification. IBM will continue to develop and implement the features of this standard. The implementation of the language level is based on IBM's interpretation of the standard. Until IBM's implementation of all the C++11 features is complete, including the support of a new C++11 standard library, the implementation might change from release to release. IBM makes no attempt to maintain compatibility, in source, binary, or listings and other compiler interfaces, with earlier releases of IBM's implementation of the new C++11 features.

Explicit instantiation declaration

The explicit instantiation declarations feature is introduced in the C++11 standard. With this feature, you can suppress the implicit instantiation of a template specialization or its members. The `extern` keyword is used to indicate explicit instantiation declaration. The usage of `extern` here is different from that of a storage class specifier.

Explicit instantiation declaration syntax

►► `extern` `template` `template_declaration` ◄◄

You can provide an explicit instantiation declaration for a template specialization if an explicit instantiation definition of the template exists in other translation units or later in the same file. If one translation unit contains the explicit instantiation definition, other translation units can use the specialization without having the specialization instantiated multiple times. The following example demonstrates this concept:

```
//sample1.h:
template<typename T, T val>
union A{
    T func();
};
extern template union A<int, 55>;

template<class T, T val>
T A<T,val>::func(void){
    return val;
}

//sampleA.C"
#include "sample1.h"

template union A<int,55>;
```

```
//sampleB.C:
#include "sample1.h"

int main(void){
    return A<int, 55>().func();
}
```

sampleB.C uses the explicit instantiation definition of `A<int, 55>().func()` in sampleA.C.

If an explicit instantiation declaration of a function or class is declared, but there is no corresponding explicit instantiation definition anywhere in the program, the compiler issues an error message. See the following example:

```
// sample2.C
template <typename T, T val>
struct A{
    virtual T func();
    virtual T bar();
}

extern template int A<int,55>::func();

template <class T, T val>
T A<T,val>::func(void){
    return val;
}

template <class T, T val>
T A<T,val>::bar(void){
    return val;
}

int main(void){
    return A<int,55>().bar();
}
```

When you use explicit instantiation declaration, pay attention to the following restrictions:

- You can name a static class member in an explicit instantiation declaration, but you cannot name a static function because a static function cannot be accessed by name in other translation units.
- The explicit instantiation declaration of a class is not equivalent to the explicit instantiation declaration of each of its members.

C++11 ◀

Explicit instantiation definition

An explicit instantiation definition is an instantiation of a template specialization or its members.

Explicit instantiation definition syntax

▶—`template—template_declaration`—▶

Here is an example of explicit instantiation definition:

```

template<class T> class Array { void mf(); };
template class Array<char>;      /* explicit instantiation definition */
template void Array<int>::mf();  /* explicit instantiation definition */

template<class T> void sort(Array<T>& v) { }
template void sort(Array<char>&); /* explicit instantiation definition */

namespace N {
    template<class T> void f(T&) { }
}

template void N::f<int>(int&);
// The explicit instantiation definition is in namespace N.

int* p = 0;
template<class T> T g(T = &p);
template char g(char);          /* explicit instantiation definition */

template <class T> class X {
    private:
        T v(T arg) { return arg; };
};

template int X<int>::v(int);    /* explicit instantiation definition */

template<class T> T g(T val) { return val; }
template<class T> void Array<T>::mf() { }

```

An explicit instantiation definition of a template is in the same namespace where you define the template.

Access checking rules do not apply to the arguments in the explicit instantiation definitions. Template arguments in an explicit instantiation definition can be private types or objects. In this example, you can use the explicit instantiation definition `template int X<int>::v(int)` even though the member function is declared to be private.

The compiler does not use default arguments when you explicitly instantiate a template. In this example, you can use the explicit instantiation definition `template char g(char)` even though the default argument is an address of the type `int`.

Note: You cannot use the `inline` or `> C++11 constexpr C++11 <` specifier in an explicit instantiation of a function template or a member function of a class template.

> C++11

Explicit instantiation and inline namespace definitions

Inline namespace definitions are namespace definitions with an initial `inline` keyword. Members of an inline namespace can be explicitly instantiated or specialized as if they were also members of the enclosing namespace. For more information, see “Inline namespace definitions (C++11)” on page 300.

C++11 <

Related reference:

“C++11 compatibility” on page 519

Implicit instantiation

Unless a template specialization has been explicitly instantiated or explicitly specialized, the compiler will generate a specialization for the template only when it needs the definition. This is called *implicit instantiation*.

> C++11

The compiler does not need to generate the specialization for nonclass, noninline entities when an explicit instantiation declaration is present.

C++11 <

If the compiler must instantiate a class template specialization and the template is declared, you must also define the template.

For example, if you declare a pointer to a class, the definition of that class is not needed and the class will not be implicitly instantiated. The following example demonstrates when the compiler instantiates a template class:

```
template<class T> class X {
public:
    X* p;
    void f();
    void g();
};

X<int>* q;
X<int> r;
X<float>* s;
r.f();
s->g();
```

The compiler requires the instantiation of the following classes and functions:

- `X<int>` when the object `r` is declared
- `X<int>::f()` at the member function call `r.f()`
- `X<float>` and `X<float>::g()` at the class member access function call `s->g()`

Therefore, the functions `X<T>::f()` and `X<T>::g()` must be defined in order for the above example to compile. (The compiler will use the default constructor of class `X` when it creates object `r`.) The compiler does not require the instantiation of the following definitions:

- class `X` when the pointer `p` is declared
- `X<int>` when the pointer `q` is declared
- `X<float>` when the pointer `s` is declared

The compiler will implicitly instantiate a class template specialization if it is involved in pointer conversion or pointer to member conversion. The following example demonstrates this:

```
template<class T> class B { };
template<class T> class D : public B<T> { };

void g(D<double>* p, D<int>* q)
{
    B<double>* r = p;
    delete q;
}
```

The assignment `B<double>* r = p` converts `p` of type `D<double>*` to a type of `B<double>*`; the compiler must instantiate `D<double>*`. The compiler must instantiate `D<int>` when it tries to delete `q`.

If the compiler implicitly instantiates a class template that contains static members, those static members are not implicitly instantiated. The compiler will instantiate a static member only when the compiler needs the static member's definition. Every instantiated class template specialization has its own copy of static members. The following example demonstrates this:

```
template<class T> class X {
public:
    static T v;
};

template<class T> T X<T>::v = 0;

X<char*> a;
X<float> b;
X<float> c;
```

Object `a` has a static member variable `v` of type `char*`. Object `b` has a static variable `v` of type `float`. Objects `b` and `c` share the single static data member `v`.

An implicitly instantiated template is in the same namespace where you defined the template.

If a function template or a member function template specialization is involved with overload resolution, the compiler implicitly instantiates a declaration of the specialization.

Template specialization

The act of creating a new definition of a function, class, or member of a class from a template declaration and one or more template arguments is called *template instantiation*. The definition created from a template instantiation is called a *specialization*. A *primary template* is the template that is being specialized.

Related reference:

“Template instantiation” on page 433

Explicit specialization

When you instantiate a template with a given set of template arguments the compiler generates a new definition based on those template arguments. You can override this behavior of definition generation. You can instead specify the definition the compiler uses for a given set of template arguments. This is called *explicit specialization*. You can explicitly specialize any of the following templates:

- Function template
- Class template
- Member function of a class template
- Static data member of a class template
- Member class of a class template
- Member function template of a class template
- Member class template of a class template

Explicit specialization declaration syntax

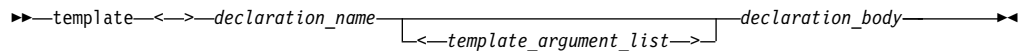

The `template<>` prefix indicates that the following template declaration takes no template parameters. The `declaration_name` is the name of a previously declared template. Note that you can forward-declare an explicit specialization so the `declaration_body` is optional, at least until the specialization is referenced.

The following example demonstrates explicit specialization:

```
using namespace std;

template<class T = float, int i = 5> class A
{
    public:
        A();
        int value;
};

template<> class A<> { public: A(); };
template<> class A<double, 10> { public: A(); };

template<class T, int i> A<T, i>::A() : value(i) {
    cout << "Primary template, "
         << "non-type argument is " << value << endl;
}

A<>::A() {
    cout << "Explicit specialization "
         << "default arguments" << endl;
}

A<double, 10>::A() {
    cout << "Explicit specialization "
         << "<double, 10>" << endl;
}

int main() {
    A<int,6> x;
    A<> y;
    A<double, 10> z;
}
```

See the output of the above example:

```
Primary template non-type argument is: 6
Explicit specialization default arguments
Explicit specialization <double, 10>
```

This example declared two explicit specializations for the *primary template* (the template which is being specialized) class A. Object x uses the constructor of the primary template. Object y uses the explicit specialization `A<>::A()`. Object z uses the explicit specialization `A<double, 10>::A()`.

Definition and declaration of explicit specializations

The definition of an explicitly specialized class is unrelated to the definition of the primary template. You do not have to define the primary template in order to define the specialization (nor do you have to define the specialization in order to define the primary template). See the following example:

```

template<class T> class A;
template<> class A<int>;

template<> class A<int> { /* ... */ };

```

The primary template is not defined, but the explicit specialization is.

You can use the name of an explicit specialization that has been declared but not defined the same way as an incompletely defined class. The following example demonstrates this:

```

template<class T> class X { };
template<> class X<char>;
X<char>* p;
X<int> i;
// X<char> j;

```

The compiler does not allow the declaration `X<char> j` because the explicit specialization of `X<char>` is not defined.

Explicit specialization and scope

A declaration of a primary template must be in scope at the *point of declaration* of the explicit specialization. In other words, an explicit specialization declaration must appear after the declaration of the primary template. For example, the compiler will not allow the following code:

```

template<> class A<int>;
template<class T> class A;

```

An explicit specialization is in the same namespace as the definition of the primary template.

Class members of explicit specializations

A member of an explicitly specialized class is not implicitly instantiated from the member declaration of the primary template. You have to explicitly define members of a class template specialization. You define members of an explicitly specialized template class as you would normal classes, without the `template<>` prefix. In addition, you can define the members of an explicit specialization inline; no special template syntax is used in this case. The following example demonstrates a class template specialization:

```

template<class T> class A {
    public:
        void f(T);
};

template<> class A<int> {
    public:
        int g(int);
};

int A<int>::g(int arg) { return 0; }

int main() {
    A<int> a;
    a.g(1234);
}

```

The explicit specialization `A<int>` contains the member function `g()`, which the primary template does not.

If you explicitly specialize a template, a member template, or the member of a class template, then you must declare this specialization before that specialization is implicitly instantiated. For example, the compiler will not allow the following code:

```
template<class T> class A { };

void f() { A<int> x; }
template<> class A<int> { };

int main() { f(); }
```

The compiler will not allow the explicit specialization `template<> class A<int> { };` because function `f()` uses this specialization (in the construction of `x`) before the specialization.

Explicit specialization of function templates

In a function template specialization, a template argument is optional if the compiler can deduce it from the type of the function arguments. The following example demonstrates this:

```
template<class T> class X { };
template<class T> void f(X<T>);
template<> void f(X<int>);
```

The explicit specialization `template<> void f(X<int>)` is equivalent to `template<> void f<int>(X<int>)`.

You cannot specify default function arguments in a declaration or a definition for any of the following cases:

- Explicit specialization of a function template
- Explicit specialization of a member function template

For example, the compiler will not allow the following code:

```
template<class T> void f(T a) { };
template<> void f<int>(int a = 5) { };

template<class T> class X {
    void f(T a) { }
};
template<> void X<int>::f(int a = 10) { };
```

Explicit specialization of members of class templates

Each instantiated class template specialization has its own copy of any static members. You may explicitly specialize static members. The following example demonstrates this:

```
template<class T> class X {
public:
    static T v;
    static void f(T);
};

template<class T> T X<T>::v = 0;
template<class T> void X<T>::f(T arg) { v = arg; }

template<> char* X<char*>::v = "Hello";
template<> void X<float>::f(float arg) { v = arg * 2; }

int main() {
```

```

    X<char*> a, b;
    X<float> c;
    c.f(10);
}

```

This code explicitly specializes the initialization of static data member `X::v` to point to the string "Hello" for the template argument `char*`. The function `X::f()` is explicitly specialized for the template argument `float`. The static data member `v` in objects `a` and `b` point to the same string, "Hello". The value of `c.v` is equal to 20 after the call function call `c.f(10)`.

You can nest member templates within many enclosing class templates. If you explicitly specialize a template nested within several enclosing class templates, you must prefix the declaration with `template<>` for every enclosing class template you specialize. You may leave some enclosing class templates unspecialized, however you cannot explicitly specialize a class template unless its enclosing class templates are also explicitly specialized. The following example demonstrates explicit specialization of nested member templates:

```

#include <iostream>
using namespace std;

template<class T> class X {
public:
    template<class U> class Y {
    public:
        template<class V> void f(U,V);
        void g(U);
    };
};

template<class T> template<class U> template<class V>
void X<T>::Y<U>::f(U, V) { cout << "Template 1" << endl; }

template<class T> template<class U>
void X<T>::Y<U>::g(U) { cout << "Template 2" << endl; }

template<> template<>
void X<int>::Y<int>::g(int) { cout << "Template 3" << endl; }

template<> template<> template<class V>
void X<int>::Y<int>::f(int, V) { cout << "Template 4" << endl; }

template<> template<> template<>
void X<int>::Y<int>::f<int>(int, int) { cout << "Template 5" << endl; }

// template<> template<class U> template<class V>
// void X<char>::Y<U>::f(U, V) { cout << "Template 6" << endl; }

// template<class T> template<>
// void X<T>::Y<float>::g(float) { cout << "Template 7" << endl; }

int main() {
    X<int>::Y<int> a;
    X<char>::Y<char> b;
    a.f(1, 2);
    a.f(3, 'x');
    a.g(3);
    b.f('x', 'y');
    b.g('z');
}

```

See the output of the above program:

Template 5
Template 4
Template 3
Template 1
Template 2

- The compiler would not allow the template specialization definition that would output "Template 6" because it is attempting to specialize a member (function `f()`) without specialization of its containing class (`Y`).
- The compiler would not allow the template specialization definition that would output "Template 7" because the enclosing class of class `Y` (which is class `X`) is not explicitly specialized.

A friend declaration cannot declare an explicit specialization.

C++11 ◀

Explicit specialization and inline namespace definitions

Inline namespace definitions are namespace definitions with an initial `inline` keyword. Members of an inline namespace can be explicitly instantiated or specialized as if they were also members of the enclosing namespace. For more information, see "Inline namespace definitions (C++11)" on page 300.

C++11 ◀

Related reference:

"Function templates" on page 424

"Class templates" on page 419

"Member functions of class templates" on page 422

"Static data members and templates" on page 422

"Deleted functions" on page 250

Partial specialization

When you instantiate a class template, the compiler creates a definition based on the template arguments you have passed. Alternatively, if all those template arguments match those of an explicit specialization, the compiler uses the definition defined by the explicit specialization.

A *partial specialization* is a generalization of explicit specialization. An explicit specialization only has a template argument list. A partial specialization has both a template argument list and a template parameter list. The compiler uses the partial specialization if its template argument list matches a subset of the template arguments of a template instantiation. The compiler will then generate a new definition from the partial specialization with the rest of the unmatched template arguments of the template instantiation.

You cannot partially specialize function templates.

Partial specialization syntax

▶ template <template_parameter_list> declaration_name →

►<template_argument_list>—declaration_body—————►

The *declaration_name* is a name of a previously declared template. Note that you can forward-declare a partial specialization so that the *declaration_body* is optional.

The following demonstrates the use of partial specializations:

```
#include <iostream>
using namespace std;

template<class T, class U, int I> struct X
    { void f() { cout << "Primary template" << endl; } };

template<class T, int I> struct X<T, T*, I>
    { void f() { cout << "Partial specialization 1" << endl; } };

template<class T, class U, int I> struct X<T*, U, I>
    { void f() { cout << "Partial specialization 2" << endl; } };

template<class T> struct X<int, T*, 10>
    { void f() { cout << "Partial specialization 3" << endl; } };

template<class T, class U, int I> struct X<T, U*, I>
    { void f() { cout << "Partial specialization 4" << endl; } };

int main() {
    X<int, int, 10> a;
    X<int, int*, 5> b;
    X<int*, float, 10> c;
    X<int, char*, 10> d;
    X<float, int*, 10> e;
    // X<int, int*, 10> f;
    a.f(); b.f(); c.f(); d.f(); e.f();
}
```

The following is the output of the above example:

```
Primary template
Partial specialization 1
Partial specialization 2
Partial specialization 3
Partial specialization 4
```

The compiler would not allow the declaration `X<int, int*, 10> f` because it can match template `struct X<T, T*, I>`, template `struct X<int, T*, 10>`, or template `struct X<T, U*, I>`, and none of these declarations are a better match than the others.

Each class template partial specialization is a separate template. You must provide definitions for each member of a class template partial specialization.

Template parameter and argument lists of partial specializations

Primary templates do not have template argument lists; this list is implied in the template parameter list.

Template parameters specified in a primary template but not used in a partial specialization are omitted from the template parameter list of the partial

specialization. The order of a partial specialization's argument list is the same as the order of the primary template's implied argument list.

In a template argument list of a partial template parameter, you cannot have an expression that involves non-type arguments unless that expression is only an identifier. In the following example, the compiler will not allow the first partial specialization, but will allow the second one:

```
template<int I, int J> class X { };

// Invalid partial specialization
template<int I> class X <I * 4, I + 3> { };

// Valid partial specialization
template <int I> class X <I, I> { };
```

The type of a non-type template argument cannot depend on a template parameter of a partial specialization. The compiler will not allow the following partial specialization:

```
template<class T, T i> class X { };

// Invalid partial specialization
template<class T> class X<T, 25> { };
```

A partial specialization's template argument list cannot be the same as the list implied by the primary template.

You cannot have default values in the template parameter list of a partial specialization.

Matching of class template partial specializations

The compiler determines whether to use the primary template or one of its partial specializations by matching the template arguments of the class template specialization with the template argument lists of the primary template and the partial specializations:

- If the compiler finds only one specialization, then the compiler generates a definition from that specialization.
- If the compiler finds more than one specialization, then the compiler tries to determine which of the specializations is the most specialized. A template *X* is more specialized than a template *Y* if every argument list that matches the one specified by *X* also matches the one specified by *Y*, but not the other way around. If the compiler cannot find the most specialized specialization, then the use of the class template is ambiguous; the compiler will not allow the program.
- If the compiler does not find any matches, then the compiler generates a definition from the primary template.

> C++11

Partial specialization also applies to the variadic templates feature. For more information, see “Variadic templates (C++11)” on page 446

Related reference:

“Template parameters” on page 412

“Template arguments” on page 415

Variadic templates (C++11)

Note: IBM supports selected features of C++11, known as C++0x before its ratification. IBM will continue to develop and implement the features of this standard. The implementation of the language level is based on IBM's interpretation of the standard. Until IBM's implementation of all the C++11 features is complete, including the support of a new C++11 standard library, the implementation might change from release to release. IBM makes no attempt to maintain compatibility, in source, binary, or listings and other compiler interfaces, with earlier releases of IBM's implementation of the new C++11 features.

Before C++11, templates had a fixed number of parameters that must be specified in the declaration of the templates. Templates could not directly express a class or function template that had a variable number of parameters. To partially alleviate this problem in the existing C++ programs, you could use overloaded function templates that had a different number of parameters or extra defaulted template parameters.

With the variadic templates feature, you can define class or function templates that have any number (including zero) of parameters. To achieve this goal, this feature introduces a kind of parameter called *parameter pack* to represent a list of zero or more parameters for templates.

The variadic template feature also introduces *pack expansion* to indicate that a parameter pack is expanded.

Two existing techniques, *template argument deduction* and *partial specialization*, can also apply to templates that have parameter packs in their parameter lists.

Parameter packs

A *parameter pack* can be a type of parameter for templates. Unlike previous parameters, which can only bind to a single argument, a parameter pack can pack multiple parameters into a single parameter by placing an ellipsis to the left of the parameter name.

In the template definition, a parameter pack is treated as a single parameter. In the template instantiation, a parameter pack is expanded and the correct number of the parameters are created.

According to the context where a parameter pack is used, the parameter pack can be either a *template parameter pack* or a *function parameter pack*.

Template parameter packs

A *template parameter pack* is a template parameter that represents any number (including zero) of template parameters. Syntactically, a template parameter pack is a template parameter specified with an ellipsis. Consider the following example.

```
template<class...A> struct container{};
template<class...B> void func();
```

In this example, A and B are template parameter packs.

According to the type of the parameters contained in a template parameter pack, there are three kinds of template parameter packs:

- Type parameter packs

- Non-type parameter packs
- Template template parameter packs

A type parameter pack represents zero or more type template parameters. Similarly, a non-type parameter pack represents zero or more non-type template parameters.

Note: Template template parameter packs are not supported in XL C/C++ V13.1.2.

The following example shows a type parameter pack:

```
template<class...T> class X{};

X<> a;           // the parameter list is empty
X<int> b;        // the parameter list has one item
X<int, char, float> c; // the parameter list has three items
```

In this example, the type parameter pack T is expanded into a list of zero or more type template parameters.

The following example shows a non-type parameter pack:

```
template<bool...A> class X{};

X<> a;           // the parameter list is empty
X<true> b;        // the parameter list has one item
X<true, false, true> c; // the parameter list has three items
```

In this example, the non-type parameter pack A is expanded into a list of zero or more non-type template parameters.

In a context where template arguments can be deduced; for example, function templates and class template partial specializations, a template parameter pack does not need to be the last template parameter of a template. In this case, you can declare more than one template parameter pack in the template parameter list. However, if template arguments cannot be deduced, you can declare at most one template parameter pack in the template parameter list, and the template parameter pack must be the last template parameter. Consider the following example:

```
// error
template<class...A, class...B>struct container1{};

// error
template<class...A,class B>struct container2{};
```

In this example, the compiler issues two error messages. One error message is for class template container1 because container1 has two template parameter packs A and B that cannot be deduced. The other error message is for class template container2 because template parameter pack A is not the last template parameter of container2, and A cannot be deduced.

Default arguments cannot be used for a template parameter pack. Consider the following example:

```
template<typename...T=int> struct foo1{};
```

In this example, the compiler issues an error message because the template parameter pack T is given a default argument int.

Function parameter packs

A *function parameter pack* is a function parameter that represents zero or more function parameters. Syntactically, a function parameter pack is a function parameter specified with an ellipsis.

In the definition of a function template, a function parameter pack uses a template parameter pack in the function parameters. The template parameter pack is expanded by the function parameter pack. Consider the following example:

```
template<class...A> void func(A...args)
```

In this example, *A* is a template parameter pack, and *args* is a function parameter pack. You can call the function with any number (including zero) of arguments:

```
func();           // void func();
func(1);         // void func(int);
func(1,2,3,4,5); // void func(int,int,int,int,int);
func(1,'x', aWidget); // void func(int,char,widget);
```

A function parameter pack is a *trailing function parameter pack* if it is the last function parameter of a function template. Otherwise, it is a *non-trailing function parameter pack*. A function template can have trailing and non-trailing function parameter packs. A non-trailing function parameter pack can be deduced only from the explicitly specified arguments when the function template is called. If the function template is called without explicit arguments, the non-trailing function parameter pack must be empty, as shown in the following example:

```
#include <cassert>

template<class...A, class...B> void func(A...arg1,int sz1, int sz2, B...arg2)
{
    assert( sizeof...(arg1) == sz1);
    assert( sizeof...(arg2) == sz2);
}

int main(void)
{
    //A:(int, int, int), B:(int, int, int, int, int)
    func<int,int,int>(1,2,3,3,5,1,2,3,4,5);

    //A: empty, B:(int, int, int, int, int)
    func(0,5,1,2,3,4,5);
    return 0;
}
```

In this example, function template *func* has two function parameter packs *arg1* and *arg2*. *arg1* is a non-trailing function parameter pack, and *arg2* is a trailing function parameter pack. When *func* is called with three explicitly specified arguments as *func<int,int,int>(1,2,3,3,5,1,2,3,4,5)*, both *arg1* and *arg2* are deduced successfully. When *func* is called without explicitly specified arguments as *func(0,5,1,2,3,4,5)*, *arg2* is deduced successfully and *arg1* is empty. In this example, the template parameter packs of function template *func* can be deduced, so *func* can have more than one template parameter pack.

Pack expansion

A *pack expansion* is an expression that contains one or more parameter packs followed by an ellipsis to indicate that the parameter packs are expanded.

Consider the following example:

```
template<class...T> void func(T...a){};
template<class...U> void func1(U...b){
    func(b...);
}
```

In this example, T... and U... are the corresponding pack expansions of the template parameter packs T and U, and b... is the pack expansion of the function parameter pack b.

A pack expansion can be used in the following contexts:

- Expression list
- Initializer list
- Base specifier list
- Member initializer list
- Template argument list
- Exception specification list

Expression list

Example:

```
#include <cstdio>
#include <cassert>

template<class...A> void func1(A...arg){
    assert(false);
}

void func1(int a1, int a2, int a3, int a4, int a5, int a6){
    printf("call with(%d,%d,%d,%d,%d,%d)\n",a1,a2,a3,a4,a5,a6);
}

template<class...A> int func(A...args){
    int size = sizeof...(A);
    switch(size){
        case 0: func1(99,99,99,99,99,99);
            break;
        case 1: func1(99,99,args...,99,99,99);
            break;
        case 2: func1(99,99,args...,99,99);
            break;
        case 3: func1(args...,99,99,99);
            break;
        case 4: func1(99,args...,99);
            break;
        case 5: func1(99,args...);
            break;
        case 6: func1(args...);
            break;
        default:
            func1(0,0,0,0,0,0);
    }
    return size;
}

int main(void){
    func();
    func(1);
    func(1,2);
    func(1,2,3);
    func(1,2,3,4);
    func(1,2,3,4,5);
    func(1,2,3,4,5,6);
    func(1,2,3,4,5,6,7);
    return 0;
}
```

The output of this example:

```

call with (99,99,99,99,99,99)
call with (99,99,1,99,99,99)
call with (99,99,1,2,99,99)
call with (1,2,3,99,99,99)
call with (99,1,2,3,4,99)
call with (99,1,2,3,4,5)
call with (1,2,3,4,5,6)
call with (0,0,0,0,0,0)

```

In this example, the switch statement shows the different positions of the pack expansion `args...` within the expression lists of the function `func1`. The output shows each call of the function `func1` to indicate the expansion.

Initializer list

Example:

```

#include <iostream>
using namespace std;

void printarray(int arg[], int length){
    for(int n=0; n<length; n++){
        printf("%d ",arg[n]);
    }
    printf("\n");
}

template<class...A> void func(A...args){
    const int size = sizeof...(args) +5;
    printf("size %d\n", size);
    int res[sizeof...(args)+5]={99,98,args...,97,96,95};
    printarray(res,size);
}

int main(void)
{
    func();
    func(1);
    func(1,2);
    func(1,2,3);
    func(1,2,3,4,5,6,7,8,9,10,11,12,13,14,15,16,17,18,19,20);
    return 0;
}

```

The output of this example:

```

size 5
99 98 97 96 95
size 6
99 98 1 97 96 95
size 7
99 98 1 2 97 96 95
size 8
99 98 1 2 3 97 96 95
size 25
99 98 1 2 3 4 5 6 7 8 9 10 11 12 13 14 15 16 17 18 19 20 97 96 95

```

In this example, the pack expansion `args...` is in the initializer list of the array `res`.

Base specifier list

Example:

```

#include <iostream>
using namespace std;

struct a1{};
struct a2{};
struct a3{};
struct a4{};

template<class X> struct baseC{
    baseC() {printf("baseC primary ctor\n");}
};
template<> struct baseC<a1>{
    baseC() {printf("baseC a1 ctor\n");}
};
template<> struct baseC<a2>{
    baseC() {printf("baseC a2 ctor\n");}
};
template<> struct baseC<a3>{
    baseC() {printf("baseC a3 ctor\n");}
};
template<> struct baseC<a4>{
    baseC() {printf("baseC a4 ctor\n");}
};

template<class...A> struct container : public baseC<A>...{
    container(){
        printf("container ctor\n");
    }
};

int main(void){
    container<a1,a2,a3,a4> test;
    return 0;
}

```

The output of this example:

```

baseC a1 ctor
baseC a2 ctor
baseC a3 ctor
baseC a4 ctor
container ctor

```

In this example, the pack expansion `baseC<A>...` is in the base specifier list of the class template `container`. The pack expansion is expanded into four base classes `baseC<a1>`, `baseC<a2>`, `baseC<a3>`, and `baseC<a4>`. The output shows that all the four base class templates are initialized before the instantiation of the class template `container`.

Member initializer list

Example:

```

#include <iostream>
using namespace std;

struct a1{};
struct a2{};
struct a3{};
struct a4{};

template<class X> struct baseC{
    baseC(int a) {printf("baseC primary ctor: %d\n", a);}
};
template<> struct baseC<a1>{
    baseC(int a) {printf("baseC a1 ctor: %d\n", a);}
};

```

```

};
template<> struct baseC<a2>{
    baseC(int a) {printf("baseC a2 ctor: %d\n", a);}
};
template<> struct baseC<a3>{
    baseC(int a) {printf("baseC a3 ctor: %d\n", a);}
};
template<> struct baseC<a4>{
    baseC(int a) {printf("baseC a4 ctor: %d\n", a);}
};

template<class...A> struct container : public baseC<A>...{
    container(): baseC<A>(12)...{
        printf("container ctor\n");
    }
};

int main(void){
    container<a1,a2,a3,a4> test;
    return 0;
}

```

The output of this example:

```

baseC a1 ctor:12
baseC a2 ctor:12
baseC a3 ctor:12
baseC a4 ctor:12
container ctor

```

In this example, the pack expansion `baseC<A>(12)...` is in the member initializer list of the class template `container`. The constructor initializer list is expanded to include the call for each base class `baseC<a1>(12)`, `baseC<a2>(12)`, `baseC<a3>(12)`, and `baseC<a4>(12)`.

Template argument list

Example:

```

#include <iostream>
using namespace std;

template<int val> struct value{
    operator int(){return val;}
};

template <typename...I> struct container{
    container(){
        int array[sizeof...(I)]={I()...};
        printf("container<");
        for(int count = 0; count<sizeof...(I); count++){
            if(count>0){
                printf(",");
            }
            printf("%d", array[count]);
        }
        printf(">\n");
    }
};

template<class A, class B, class...C> void func(A arg1, B arg2, C...arg3){
    container<A,B,C...> t1; // container<99,98,3,4,5,6>
    container<C...,A,B> t2; // container<3,4,5,6,99,98>
    container<A,C...,B> t3; // container<99,3,4,5,6,98>
}

```

```

int main(void){
    value<99> v99;
    value<98> v98;
    value<3> v3;
    value<4> v4;
    value<5> v5;
    value<6> v6;
    func(v99,v98,v3,v4,v5,v6);
    return 0;
}

```

The output of this example:

```

container<99,98,3,4,5,6>
container<3,4,5,6,99,98>
container<99,3,4,5,6,98>

```

In this example, the pack expansion `C...` is expanded in the context of template argument list for the class template `container`.

Exception specification list

Example:

```

struct a1{};
struct a2{};
struct a3{};
struct a4{};
struct a5{};
struct stuff{};

template<class...X> void func(int arg) throw(X...){
    a1 t1;
    a2 t2;
    a3 t3;
    a4 t4;
    a5 t5;
    stuff st;

    switch(arg){
        case 1:
            throw t1;
            break;
        case 2:
            throw t2;
            break;
        case 3:
            throw t3;
            break;
        case 4:
            throw t4;
            break;
        case 5:
            throw t5;
            break;
        default:
            throw st;
            break;
    }
}

int main(void){
    try{
        // if the throw specification is correctly expanded, none of
        // these calls should trigger an exception that is not expected
        func<a1,a2,a3,a4,a5,stuff>(1);
        func<a1,a2,a3,a4,a5,stuff>(2);
    }
}

```

```

        func<a1,a2,a3,a4,a5,stuff>(3);
        func<a1,a2,a3,a4,a5,stuff>(4);
        func<a1,a2,a3,a4,a5,stuff>(5);
        func<a1,a2,a3,a4,a5,stuff>(99);
    }
    catch(...){
        return 0;
    }
    return 1;
}

```

In this example, the pack expansion `X...` is expanded in the context of exception specification list for the function template `func`.

If a parameter pack is declared, it must be expanded by a pack expansion. An appearance of a name of a parameter pack that is not expanded is incorrect. Consider the following example:

```

template<class...A> struct container;
template<class...B> struct container<B>{}

```

In this example, the compiler issues an error message because the template parameter pack `B` is not expanded.

Pack expansion cannot match a parameter that is not a parameter pack. Consider the following example:

```

template<class X> struct container{};

template<class A, class...B>
// Error, parameter A is not a parameter pack
void func1(container<A>...args){};

template<class A, class...B>
// Error, 1 is not a parameter pack
void func2(1...){};

```

If more than one parameter pack is referenced in a pack expansion, each expansion must have the same number of arguments expanded from these parameter packs. Consider the following example:

```

struct a1{}; struct a2{}; struct a3{}; struct a4{}; struct a5{};

template<class...X> struct baseC{};
template<class...A1> struct container{};
template<class...A, class...B, class...C>
struct container<baseC<A,B,C...>...>:public baseC<A,B...,C>{};

int main(void){
    container<baseC<a1,a4,a5,a5,a5>, baseC<a2,a3,a5,a5,a5>,
        baseC<a3,a2,a5,a5,a5>,baseC<a4,a1,a5,a5,a5> > test;
    return 0;
}

```

In this example, the template parameter packs `A`, `B`, and `C` are referenced in the same pack expansion `baseC<A,B,C...>...`. The compiler issues an error message to indicate that the lengths of these three template parameter packs are mismatched when expanding them during the template instantiation of the class template `container`.

Partial specialization

Partial specialization is a fundamental part of the variadic templates feature. A basic partial specialization can be used to access the individual arguments of a parameter pack. The following example shows how to use partial specialization for variadic templates:

```
// primary template
template<class...A> struct container;

// partial specialization
template<class B, class...C> struct container<B,C...>{};
```

When the class template `container` is instantiated with a list of arguments, the partial specialization is matched in all cases where there are one or more arguments. In that case, the template parameter `B` holds the first parameter, and the pack expansion `C...` contains the rest of the argument list. In the case of an empty list, the partial specialization is not matched, so the instantiation matches the primary template.

A pack expansion must be the last argument in the argument list for a partial specialization. Consider the following example:

```
template<class...A> struct container;

// partial specialization
template<class B, class...C> struct container<C...,B>{};
```

In this example, the compiler issues an error message because the pack expansion `C...` is not the last argument in the argument list for the partial specialization.

A partial specialization can have more than one template parameter pack in its parameter list. Consider the following example:

```
template<typename T1, typename T2> struct foo{};
template<typename...T> struct bar{};

// partial specialization
template<typename...T1,typename...T2> struct bar<foo<T1,T2>...>{};
```

In this example, the partial specialization has two template parameter packs `T1` and `T2` in its parameter list.

To access the arguments of a parameter pack, you can use partial specialization to access one member of the parameter pack in the first step, and recursively instantiate the remainder of the argument list to get all the elements, as shown in the following example:

```
#include<iostream>
using namespace std;

struct a1{}; struct a2{}; struct a3{}; struct a4{}; struct a5{};
struct a6{}; struct a7{}; struct a8{}; struct a9{}; struct a10{};

template<typename X1, typename X2> struct foo{foo();};
template<typename X3, typename X4> foo<X3,X4>::foo(){cout<<"primary foo"<<endl;};
template<> struct foo<a1,a2>{foo(){cout<<"ctor foo<a1,a2>"<<endl;}};
template<> struct foo<a3,a4>{foo(){cout<<"ctor foo<a3,a4>"<<endl;}};
template<> struct foo<a5,a6>{foo(){cout<<"ctor foo<a5,a6>"<<endl;}};
template<> struct foo<a7,a8>{foo(){cout<<"ctor foo<a7,a8>"<<endl;}};
template<> struct foo<a9,a10>{foo(){cout<<"ctor foo<a9,a10>"<<endl;}};

template<typename...T>struct bar{bar(){cout<<"bar primary"<<endl;}};
```

```

template<typename A, typename B, typename...T1, typename...T2>
struct bar<foo<A,B>,foo<T1,T2>...>{
    foo<A,B> data;
    bar<foo<T1,T2>...>data1;
};

template<> struct bar<foo<a9,a10> > {bar(){cout<<"ctor bar<foo<a9,a10>>"<<endl;}};

int main(){
    bar<foo<a1,a2>,foo<a3,a4>,foo<a5,a6>,foo<a7,a8>,foo<a9,a10> > t2;
    return 0;
}

```

The output of the example:

```

ctor foo<a1,a2>
ctor foo<a3,a4>
ctor foo<a5,a6>
ctor foo<a7,a8>
ctor bar<foo<a9,a10>

```

Template argument deduction

Parameter packs can be deduced by template argument deduction in the same way as other normal template parameters. The following example shows how template argument deduction expands packs from a function call:

```

template<class...A> void func(A...args){}

int main(void){
    func(1,2,3,4,5,6);
    return 0;
}

```

In this example, the function argument list is (1,2,3,4,5,6). Each function argument is deduced to the type `int`, so the template parameter pack `A` is deduced to the following list of types: (int,int,int,int,int,int). With all the expansions, the function template `func` is instantiated as `void func(int,int,int,int,int,int)`, which is the template function with the expanded function parameter pack.

In this example, if you change the function call statement `func(1,2,3,4,5,6)` to `func()`, template argument deduction deduces that the template parameter pack `A` is empty:

```

template<class...A> void func(A...args){}

int main(void){
    func();
    return 0;
}

```

Template argument deduction can expand packs from a template instantiation, as shown in the following example:

```

#include <cstdio>

template<int...A> struct container{
    void display(){printf("YIKES\n");}
};

template<int B, int...C> struct container<B,C...>{
    void display(){
        printf("spec %d\n",B);
        container<C...>test;
        test.display();
    }
};

```

```

    }
};

template<int C> struct container<C>{
    void display(){printf("spec %d\n",C);}
};

int main(void)
{
    printf("start\n\n");
    container<1,2,3,4,5,6,7,8,9,10> test;
    test.display();
    return 0;
}

```

The output of this example:

```

start

spec 1
spec 2
spec 3
spec 4
spec 5
spec 6
spec 7
spec 8
spec 9
spec 10

```

In this example, the partial specialization of the class template `container` is `template<int B, int...C> struct container<B,C...>`. The partial specialization is matched when the class template is instantiated to `container<1,2,3,4,5,6,7,8,9,10>`. Template argument deduction deduces the template parameter pack `C` and the parameter `B` from the argument list of the partial specialization. Template argument deduction then deduces the parameter `B` to be `1`, the pack expansion `C...` to a list: `(2,3,4,5,6,7,8,9,10)`, and the template parameter pack `C` to the following list of types: `(int,int,int,int,int,int,int,int)`.

If you change the statement `container<1,2,3,4,5,6,7,8,9,10> test` to `container<1> test`, template argument deduction deduces that the template parameter pack `C` is empty.

Template argument deduction can expand packs after the explicit template arguments are found. Consider the following example:

```

#include <cassert>

template<class...A> int func(A...arg){
    return sizeof...(arg);
}

int main(void){
    assert(func<int>(1,2,3,4,5) == 5);
    return 0;
}

```

In this example, the template parameter pack `A` is deduced to a list of types: `(int,int,int,int,int)` using the explicit argument list and the arguments in the function call.

Related reference:

“The `sizeof` operator” on page 176

“Template parameters” on page 412
“Template arguments” on page 415
“Class templates” on page 419
“Function templates” on page 424
“Template argument deduction” on page 426
“Partial specialization” on page 443
“C++11 compatibility” on page 519

Name binding and dependent names

Name binding is the process of finding the declaration for each name that is explicitly or implicitly used in a template. The compiler might bind a name in the definition of a template, or it might bind a name at the instantiation of a template.

A *dependent name* is a name that depends on the type or the value of a template parameter. For example:

```
template<class T> class U : A<T>
{
    typename T::B x;
    void f(A<T>& y)
    {
        *y++;
    }
};
```

The dependent names in this example are the base class `A<T>`, the type name `T::B`, and the variable `y`.

The compiler binds dependent names when a template is instantiated. The compiler binds non-dependent names when a template is defined. Consider the following example:

```
#include <iostream>
using namespace std;

void f(double) { cout << "Function f(double)" << endl; }

template <class A> struct container{ // point of definition of container
    void member1(){
        // This call is not template dependent,
        // because it does not make any use of a template parameter.
        // The name is resolved at the point of definition, so f(int) is not visible.
        f(1);
    }
    void member2(A arg);
};

void f(int) { cout << "Function f(int)" << endl; }

void h(double) { cout << "Function h(double)" << endl; }

template <class A> void container<A>::member2(A arg){
    // This call is template dependent, so qualified name lookup only finds
    // names visible at the point of instantiation.
    ::h(arg);
}

template struct container<int>; // point of instantiation of container<int>

void h(int) { cout << "Function h(int)" << endl; }
```

```
int main(void){
    container<int> test;
    test.member1();
    test.member2(10);
    return 0;
}
```

The output of this example:

```
Function f(double)
Function h(double)
```

The *point of definition* of a template is located immediately before its definition. In this example, the point of definition of the template `container` is located immediately before the keyword `template`. Because the function call `f(1)` does not depend on a template parameter, the compiler considers names declared before the definition of the template `container`. Therefore, the function call `f(1)` calls `f(double)`. Although `f(int)` is a better match, it is not in scope at the point of definition of `container`.

The *point of instantiation* of a template is located immediately before the declaration that encloses its use. In this example, the point of instantiation of `container<int>` is the location of the explicit instantiation. Because the qualified function call `::h(arg)` depends on the template argument `arg`, the compiler considers names declared before the instantiation of `container<int>`. Therefore, the function call `h(arg)` calls `h(double)`. It does not consider `h(int)`, because this function is not in scope at the point of instantiation of `container<int>`.

Point of instantiation binding implies the following:

- A template parameter cannot depend on any local name or class member.
- An unqualified name in a template cannot depend on a local name or class member.

► C++11

The `decltype` feature can interact with template dependent names. If the operand *expression* in the `decltype(expression)` type specifier is dependent on template parameters, the compiler cannot determine the validity of *expression* before the template instantiation, as shown in the following example:

```
template <class T, class U> int h(T t, U u, decltype(t+u) v);
```

In this example, the compiler issues an error message if the operand `t+u` is invalid after the instantiation of the function template `h`.

For more information, see “The `decltype(expression)` type specifier (C++11)” on page 90

◀ C++11

Related reference:

“Template instantiation” on page 433

The typename keyword

Use the keyword `typename` if you have a qualified name that refers to a type and depends on a template parameter. Only use the keyword `typename` in template declarations and definitions. Consider the following example:

```

template<class T> class A
{
    T::x(y);
    typedef char C;
    A::C d;
}

```

The statement `T::x(y)` is ambiguous. It could be a call to function `x()` with a nonlocal argument `y`, or it could be a declaration of variable `y` with type `T::x`. C++ compiler interprets this statement as a function call. In order for the compiler to interpret this statement as a declaration, you must add the keyword `typename` to the beginning of `T::x(y)`. The statement `A::C d;` is ill-formed. The class `A` also refers to `A<T>` and thus depends on a template parameter. You must add the keyword `typename` to the beginning of this declaration:

```

typename A::C d;

```

You can also use the keyword `typename` in place of the keyword `class` in the template parameter declarations.

Related reference:

“Template parameters” on page 412

The template keyword as qualifier

Use the keyword `template` as a qualifier to distinguish member templates from other entities. The following example illustrates when you must use `template` as a qualifier:

```

class A
{
    public:
        template<class T> T function_m() { };
};

template<class U> void function_n(U argument)
{
    char object_x = argument.function_m<char>(); // ill-formed
}

```

In this example, the definition of the variable `object_x` is ill-formed. The compiler assumes that the symbol `<` is a less-than operator. In order for the compiler to recognize the template function call, you must add the `template` qualifier:

```

char object_x = argument.template function_m<char>();

```

If the name of a member template specialization appears after a `.`, `->`, or `::` operator, and that name has explicitly qualified template parameters, prefix the member template name with the keyword `template`. The following example demonstrates this use of the keyword `template`:

```

#include <iostream>
using namespace std;

class X {
    public:
        template <int j> struct S {
            void h() {
                cout << "member template's member function: " << j << endl;
            }
        };
        template <int i> void f() {
            cout << "Primary: " << i << endl;
        }
}

```

```

};

template<> void X::f<20>() {
    cout << "Specialized, non-type argument = 20" << endl;
}

template<class T> void g(T* p) {
    p->template f<100>();
    p->template f<20>();
    typename T::template S<40> s; // use of scope operator on a member template
    s.h();
}

int main()
{
    X temp;
    g(&temp);
}

```

See the output of this example:

```

Primary: 100
Specialized, non-type argument = 20
member template's member function: 40

```

If you do not use the keyword `template` in these cases, the compiler will interpret the `<` as a less-than operator. For example, the following line of code is ill-formed:

```
p->f<100>();
```

The compiler interprets `f` as a non-template member, and the `<` as a less-than operator.

Chapter 17. Exception handling (C++ only)

Exception handling is a mechanism that separates code that detects and handles exceptional circumstances from the rest of your program. Note that an exceptional circumstance is not necessarily an error.

When a function detects an exceptional situation, you represent this with an object. This object is called an *exception object*. In order to deal with the exceptional situation you *throw the exception*. This passes control, as well as the exception, to a designated block of code in a direct or indirect caller of the function that threw the exception. This block of code is called a *handler*. In a handler, you specify the types of exceptions that it may process. The C++ run time, together with the generated code, will pass control to the first appropriate handler that is able to process the exception thrown. When this happens, an exception is *caught*. A handler may *rethrow* an exception so it can be caught by another handler.

The exception handling mechanism is made up of the following elements:

- try blocks
- catch blocks
- throw expressions
- “Exception specifications” on page 476

try blocks

You use a *try block* to indicate which areas in your program that might throw exceptions you want to handle immediately. You use a *function try block* to indicate that you want to detect exceptions in the entire body of a function.

try block syntax



Function try block syntax

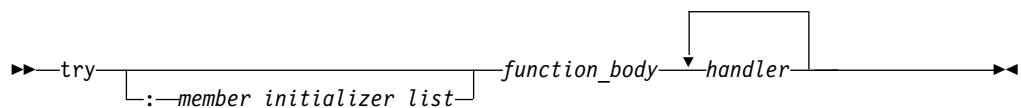

The following code is an example of a function try block with a member initializer, a function try block and a try block:

```
#include <iostream>
using namespace std;

class E {
public:
    const char* error;
    E(const char* arg) : error(arg) { }
};
```

```

class A {
public:
    int i;

    // A function try block with a member
    // initializer
    A() try : i(0) {
        throw E("Exception thrown in A()");
    }
    catch (E& e) {
        cout << e.error << endl;
    }
};

// A function try block
void f() try {
    throw E("Exception thrown in f()");
}
catch (E& e) {
    cout << e.error << endl;
}

void g() {
    throw E("Exception thrown in g()");
}

int main() {
    f();

    // A try block
    try {
        g();
    }
    catch (E& e) {
        cout << e.error << endl;
    }
    try {
        A x;
    }
    catch(...) { }
}

```

See the following output of the above example:

```

Exception thrown in f()
Exception thrown in g()
Exception thrown in A()

```

The constructor of class A has a function try block with a member initializer. Function f() has a function try block. The main() function contains a try block.

Related reference:

“Initialization of base classes and members” on page 392

Nested try blocks

When try blocks are nested and a throw occurs in a function called by an inner try block, control is transferred outward through the nested try blocks until the first catch block is found whose argument matches the argument of the throw expression.

For example:

```

try
{
    func1();
}

```

```

    try
    {
        func2();
    }
    catch (spec_err) { /* ... */ }
    func3();
}
catch (type_err) { /* ... */ }
// if no throw is issued, control resumes here.

```

In the above example, if `spec_err` is thrown within the inner try block (in this case, from `func2()`), the exception is caught by the inner catch block, and, assuming this catch block does not transfer control, `func3()` is called. If `spec_err` is thrown after the inner try block (for instance, by `func3()`), it is not caught and the function `terminate()` is called. If the exception thrown from `func2()` in the inner try block is `type_err`, the program skips out of both try blocks to the second catch block without invoking `func3()`, because no appropriate catch block exists following the inner try block.

You can also nest a try block within a catch block.

catch blocks

catch block syntax

►► catch (—*exception_declaration*—) {—*statements*—} ◀◀

You can declare a handler to catch many types of exceptions. The objects that a function can catch are declared in the parentheses following the catch keyword (the *exception_declaration*). You can catch both scalar and class objects. You can also catch cv-qualified objects. An exception declaration can declare an lvalue reference, in which case the exception object is passed by reference to the catch handler. The *exception_declaration* cannot be an incomplete type, abstract class type, ► C++11 lvalue reference type ◀ C++11, or a reference or pointer to an incomplete type other than the following types:

- `void*`
- `const void*`
- `volatile void*`
- `const volatile void*`

You cannot define a type in an *exception_declaration*.

You can also use the `catch(...)` form of the handler to catch all thrown exceptions that have not been caught by a previous catch block. The ellipsis in the catch argument indicates that any exception thrown can be handled by this handler.

If an exception is caught by a `catch(...)` block, there is no direct way to access the object thrown. Information about an exception caught by `catch(...)` is very limited.

You can declare an optional variable name if you want to access the thrown object in the catch block.

A catch block can only catch accessible objects. The object caught must have an accessible copy constructor.

Related reference:

“Type qualifiers” on page 98

“Member access” on page 349

“References (C++ only)” on page 123

Function try block handlers

The scope and lifetime of the parameters of a function or constructor extend into the handlers of a function try block. The following example demonstrates this:

```
void f(int &x) try {
    throw 10;
}
catch (const int &i)
{
    x = i;
}

int main() {
    int v = 0;
    f(v);
}
```

The value of `v` after `f()` is called is 10.

A function try block on `main()` does not catch exceptions thrown in destructors of objects with static storage duration, or constructors of namespace scope objects.

The following example throws an exception from a destructor of a static object. This example is intended to show that the exception in `~B()` is caught by the function try block of `main()`, but that the exception in `~A()` is not caught because `~A()` is executed after `main()` has completed.

```
#include <iostream>
using namespace std;

class E {
public:
    const char* error;
    E(const char* arg) : error(arg) { }
};

class A {
public: ~A() { throw E("Exception in ~A()"); }
};

class B {
public: ~B() { throw E("Exception in ~B()"); }
};

int main() try {
    cout << "In main" << endl;
    static A cow;
    B bull;
}
catch (E& e) {
    cout << e.error << endl;
}
```

See the output of the above example:

```
In main
Exception in ~B()
```

The run time will not catch the exception thrown when object `cow` is destroyed at the end of the program.

The following example throws an exception from a constructor of a namespace scope object:

```
#include <iostream>
using namespace std;

class E {
public:
    const char* error;
    E(const char* arg) : error(arg) { }
};

namespace N {
    class C {
    public:
        C() {
            cout << "In C()" << endl;
            throw E("Exception in C()");
        }
    };

    C calf;
};

int main() try {
    cout << "In main" << endl;
}
catch (E& e) {
    cout << e.error << endl;
}
```

See the output of the above example:

```
In C()
```

The compiler will not catch the exception thrown when object `calf` is created.

In a function try block's handler, you cannot have a jump into the body of a constructor or destructor.

A return statement cannot appear in a function try block's handler of a constructor.

When the function try block's handler of an object's constructor or destructor is entered, fully constructed base classes and members of that object are destroyed. The following example demonstrates this:

```
#include <iostream>
using namespace std;

class E {
public:
    const char* error;
    E(const char* arg) : error(arg) { };
};

class B {
public:
    B() { };
    ~B() { cout << "~B() called" << endl; };
};

class D : public B {
```

```

    public:
        D();
        ~D() { cout << "~D() called" << endl; };
};

D::~D() try : B() {
    throw E("Exception in D()");
}
catch(E& e) {
    cout << "Handler of function try block of D(): " << e.error << endl;
};

int main() {
    try {
        D val;
    }
    catch(...) { }
}

```

See the output of the above example:

```

~B() called
Handler of function try block of D(): Exception in D()

```

When the function try block's handler of D() is entered, the run time first calls the destructor of the base class of D, which is B. The destructor of D is not called because val is not fully constructed.

The run time will rethrow an exception at the end of a function try block's handler of a constructor or destructor. All other functions will return once they have reached the end of their function try block's handler. The following example demonstrates this:

```

#include <iostream>
using namespace std;

class E {
    public:
        const char* error;
        E(const char* arg) : error(arg) { };
};

class A {
    public:
        A() try { throw E("Exception in A()"); }
        catch(E& e) { cout << "Handler in A(): " << e.error << endl; }
};

int f() try {
    throw E("Exception in f()");
    return 0;
}
catch(E& e) {
    cout << "Handler in f(): " << e.error << endl;
    return 1;
}

int main() {
    int i = 0;
    try { A a; }
    catch(E& e) {
        cout << "Handler in main(): " << e.error << endl;
    }

    try { i = f(); }
    catch(E& e) {

```

```

        cout << "Another handler in main(): " << e.error << endl;
    }

    cout << "Returned value of f(): " << i << endl;
}

```

See the output of the above example:

```

Handler in A(): Exception in A()
Handler in main(): Exception in A()
Handler in f(): Exception in f()
Returned value of f(): 1

```

> C++11

If the delegating process exists and an exception occurs in the body of a target constructor, the exception can be caught by an appropriate handler in the try block of the delegating constructor. The following example demonstrates this:

```

#include <cstdio>
using std::printf;

int global_argc;

struct A{
    int _x;
    A();
    A(int);
};

A::A(int x):_x((printf("In A::A(int) initializer for A::_x.\n"),x)){
    printf("In A::A(int) constructor body.\n");

    if(global_argc % 2 !=0){
        printf("Will throw.\n");
        throw 0;
    }
    printf("Will not throw.\n");
}

A::A() try:A((printf("In A::A() initializer for delegating to A::A(int).\n"),42)){
    printf("In A::A() function-try-block body.\n");
}
catch(...){
    printf("In catch(...) handler for A::A() function-try-block.\n");
}

int main(int argc, char **argv){
    printf("In main().\n");
    global_argc = argc;
    try{
        A a;
        printf("Back in main().\n");
    }
    catch(...){
        printf("In catch(...) handler for try-block in main().\n");
    }
    return 0;
}

```

The example can produce different output depending on how many arguments are passed on the invocation of the resulting program. With an even number of arguments, the exception is thrown. The output is:

```

In main().
In A::A() initializer for delegating to A::A(int).
In A::A(int) initializer for A::_x.

```

In A::A(int) constructor body.
Will throw.
In catch(...) handler for A::A() function-try-block.
In catch(...) handler for try-block in main().

With an odd number of arguments, there is no exception thrown. The output is:

In main().
In A::A() initializer for delegating to A::A(int).
In A::A(int) initializer for A::_x.
In A::A(int) constructor body.
Will not throw.
In A::A() function-try-block body.
Back in main().

For more information, see “Delegating constructors (C++11)” on page 387

C++11 ◀

Related reference:

“The main() function” on page 279
“The static storage class specifier” on page 55
Chapter 10, “Namespaces (C++ only),” on page 293
“Destructors” on page 398

Arguments of catch blocks

If you specify a class type for the argument of a catch block (the *exception_declaration*), the compiler uses a copy constructor to initialize that argument. If that argument does not have a name, the compiler initializes a temporary object and destroys it when the handler exits.

The ISO C++ specifications do not require the compiler to construct temporary objects in cases where they are redundant. The compiler takes advantage of this rule to create more efficient, optimized code. Take this into consideration when debugging your programs, especially for memory problems.

Matching between exceptions thrown and caught

An argument in the catch argument of a handler matches an argument in the *assignment_expression* of the throw expression (throw argument) if any of the following conditions is met:

- The catch argument type matches the type of the thrown object.
- The catch argument is a public base class of the thrown class object.
- The catch specifies a pointer type, and the thrown object is a pointer type that can be converted to the pointer type of the catch argument by standard pointer conversion.

Note: If the type of the thrown object is `const` or `volatile`, the catch argument must also be a `const` or `volatile` for a match to occur. However, a `const`, `volatile`, or reference type catch argument can match a nonconstant, nonvolatile, or nonreference object type. A nonreference catch argument type matches a reference to an object of the same type.

Related reference:

“Pointer conversions” on page 156
“Type qualifiers” on page 98
“References (C++ only)” on page 123

Order of catching

If the compiler encounters an exception in a try block, it will try each handler in order of appearance.

If a catch block for objects of a base class precedes a catch block for objects of a class derived from that base class, the compiler issues a warning and continues to compile the program despite the unreachable code in the derived class handler.

A catch block of the form `catch(...)` must be the last catch block following a try block or an error occurs. This placement ensures that the `catch(...)` block does not prevent more specific catch blocks from catching exceptions intended for them.

If the run time cannot find a matching handler in the current scope, the run time will continue to find a matching handler in a dynamically surrounding try block. The following example demonstrates this:

```
#include <iostream>
using namespace std;

class E {
public:
    const char* error;
    E(const char* arg) : error(arg) { };
};

class F : public E {
public:
    F(const char* arg) : E(arg) { };
};

void f() {
    try {
        cout << "In try block of f()" << endl;
        throw E("Class E exception");
    }
    catch (F& e) {
        cout << "In handler of f()";
        cout << e.error << endl;
    }
};

int main() {
    try {
        cout << "In main" << endl;
        f();
    }
    catch (E& e) {
        cout << "In handler of main: ";
        cout << e.error << endl;
    };
    cout << "Resume execution in main" << endl;
}
```

The following is the output of the above example:

```
In main
In try block of f()
In handler of main: Class E exception
Resume execution in main
```

In function `f()`, the run time could not find a handler to handle the exception of type `E` thrown. The run time finds a matching handler in a dynamically surrounding try block: the try block in the `main()` function.

If the run time cannot find a matching handler in the program, it calls the `terminate()` function.

Related reference:

“try blocks” on page 463

throw expressions

You use a *throw expression* to indicate that your program has encountered an exception.

throw expression syntax

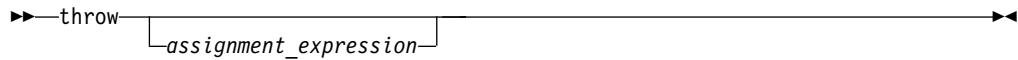

The type of *assignment_expression* cannot be an incomplete type, abstract class type, or a pointer to an incomplete type other than the following types:

- `void*`
- `const void*`
- `volatile void*`
- `const volatile void*`

The *assignment_expression* is treated the same way as a function argument in a call or the operand of a return statement.

If the *assignment_expression* is a class object, the copy constructor and destructor of that object must be accessible. For example, you cannot throw a class object that has its copy constructor declared as private. The constructor used to copy `> C++11` or move `< C++11` that object is chosen by overload resolution.

If the *assignment_expression* is an integral constant expression of integer type that evaluates to zero, this *assignment_expression* does not match a handler of pointer or pointer to member type.

Related reference:

Incomplete types

Rethrowing an exception

If a catch block cannot handle the particular exception it has caught, you can rethrow the exception. The rethrow expression (`throw` without *assignment_expression*) causes the originally thrown object to be rethrown.

Because the exception has already been caught at the scope in which the rethrow expression occurs, it is rethrown out to the next dynamically enclosing try block. Therefore, it cannot be handled by catch blocks at the scope in which the rethrow expression occurred. Any catch blocks for the dynamically enclosing try block have an opportunity to catch the exception.

The following example demonstrates rethrowing an exception:

```
#include <iostream>
using namespace std;

struct E {
    const char* message;
```

```

    E() : message("Class E") { }
};

struct E1 : E {
    const char* message;
    E1() : message("Class E1") { }
};

struct E2 : E {
    const char* message;
    E2() : message("Class E2") { }
};

void f() {
    try {
        cout << "In try block of f()" << endl;
        cout << "Throwing exception of type E1" << endl;
        E1 myException;
        throw myException;
    }
    catch (E2& e) {
        cout << "In handler of f(), catch (E2& e)" << endl;
        cout << "Exception: " << e.message << endl;
        throw;
    }
    catch (E1& e) {
        cout << "In handler of f(), catch (E1& e)" << endl;
        cout << "Exception: " << e.message << endl;
        throw;
    }
    catch (E& e) {
        cout << "In handler of f(), catch (E& e)" << endl;
        cout << "Exception: " << e.message << endl;
        throw;
    }
}

int main() {
    try {
        cout << "In try block of main()" << endl;
        f();
    }
    catch (E2& e) {
        cout << "In handler of main(), catch (E2& e)" << endl;
        cout << "Exception: " << e.message << endl;
    }
    catch (...) {
        cout << "In handler of main(), catch (...)" << endl;
    }
}

```

The following is the output of the above example:

```

In try block of main()
In try block of f()
Throwing exception of type E1
In handler of f(), catch (E1& e)
Exception: Class E1
In handler of main(), catch (...)

```

The try block in the main() function calls function f(). The try block in function f() throws an object of type E1 named myException. The handler catch (E1 &e) catches myException. The handler then rethrows myException with the statement throw to the next dynamically enclosing try block: the try block in the main() function. The handler catch(...) catches myException.

Stack unwinding

When an exception is thrown and control passes from a try block to a handler, the C++ run time calls destructors for all automatic objects constructed since the beginning of the try block. This process is called *stack unwinding*. The automatic objects are destroyed in reverse order of their construction. (Automatic objects are local objects that have been declared auto or register, or not declared static or extern. An automatic object *x* is deleted whenever the program exits the block in which *x* is declared.)

If an exception is thrown during construction of an object consisting of subobjects or array elements, destructors are only called for those subobjects or array elements successfully constructed before the exception was thrown. A destructor for a local static object will only be called if the object was successfully constructed.

If during stack unwinding a destructor throws an exception and that exception is not handled, the `terminate()` function is called. The following example demonstrates this:

```
#include <iostream>
using namespace std;

struct E {
    const char* message;
    E(const char* arg) : message(arg) { }
};

void my_terminate() {
    cout << "Call to my_terminate" << endl;
};

struct A {
    A() { cout << "In constructor of A" << endl; }
    ~A() {
        cout << "In destructor of A" << endl;
        throw E("Exception thrown in ~A()");
    }
};

struct B {
    B() { cout << "In constructor of B" << endl; }
    ~B() { cout << "In destructor of B" << endl; }
};

int main() {
    set_terminate(my_terminate);

    try {
        cout << "In try block" << endl;
        A a;
        B b;
        throw("Exception thrown in try block of main()");
    }
    catch (const char* e) {
        cout << "Exception: " << e << endl;
    }
    catch (...) {
        cout << "Some exception caught in main()" << endl;
    }

    cout << "Resume execution of main()" << endl;
}
```

The output of this example:

```
In try block
In constructor of A
In constructor of B
In destructor of B
In destructor of A
Call to my_terminate
```

In the try block, two automatic objects are created: a and b. The try block throws an exception of type `const char*`. The handler `catch (const char* e)` catches this exception. The C++ run time unwinds the stack, calling the destructors for a and b in reverse order of their construction. The destructor for a throws an exception. Since there is no handler in the program that can handle this exception, the C++ run time calls `terminate()`. (The function `terminate()` calls the function specified as the argument to `set_terminate()`. In this example, `terminate()` has been specified to call `my_terminate()`.)

> C++11

When the delegating constructors feature is enabled, if an exception is thrown in the body of a delegating constructor, the destructors of the objects constructed through target constructor will be invoked automatically. The destructors must be called in such a way that it calls the destructors of subobjects as appropriate. In particular, it should call the destructors for virtual base classes if the virtual base classes are created through the target constructor.

If an exception is thrown in the body of a delegating constructor, the destructor is invoked for the object created by the target constructor. If an exception escapes from a non-delegating constructor, the unwinding mechanism will call the destructors for the completely constructed subobjects. The following example demonstrates this:

```
class D{
    D():D('a') { printf("D:D().\n");}

    D:D(char) try: D(55){
        printf("D::D(char). Throws.\n");
        throw 0;
    }
    catch(...){
        printf("D::D(char).Catch block.\n");
    }

    D:D(int i):i(i_) {printf("D::D(int).\n");}

    D::~D() {printf("D::~D().\n");}
}

int main(void){
    D d;
}
```

The output of the example is:

```
D::D(int).
D::D(char).Throws.
D::~D().
D::D(char).Catch block.
```

In this example, an exception occurs in the delegating constructor `D:D(char)`, so destructor `D::~D()` is invoked for object `d`.

For more information, see “Delegating constructors (C++11)” on page 387

C++11 <

Exception specifications

C++ provides a mechanism to ensure that a given function is limited to throw only a specified list of exceptions. An exception specification at the beginning of any function acts as a guarantee to the function's caller that the function will throw only the exceptions contained in the exception specification.

For example, a function:

```
void translate() throw(unknown_word,bad_grammar) { /* ... */ }
```

explicitly states that it will only throw exception objects whose types are `unknown_word` or `bad_grammar`, or any type derived from `unknown_word` or `bad_grammar`.

Exception specification syntax

► throw (type_id_list) ◀

The *type_id_list* is a comma-separated list of types. In this list you cannot specify an incomplete type, abstract class type, > C++11 rvalue reference type < C++11, or a pointer or reference to an incomplete type other than the following types:

- `void*`
- `const void*`
- `volatile void*`
- `const volatile void*`

You can qualify the types in *type_id_list* with cv-qualifiers, but you cannot define a type in an exception specification.

A function with no exception specification allows all exceptions. A function with an exception specification that has an empty *type_id_list*, `throw()`, does not allow any exceptions to be thrown.

An exception specification is not part of a function's type.

An exception specification may only appear at the end of the top-level function declarator in a declaration or definition of a function, pointer to function, reference to function, or pointer to member function. An exception specification cannot appear in a typedef declaration. The following declarations demonstrate this:

```
void f() throw(int);
void (*g)() throw(int);
void h(void i() throw(int));
// typedef int (*j)() throw(int); This is an error.
```

The compiler would not allow the last declaration, `typedef int (*j)() throw(int)`.

Suppose that class `A` is one of the types in the *type_id_list* of an exception specification of a function. That function may throw exception objects of class `A`, or any class publicly derived from class `A`. The following example demonstrates this:

```

class A { };
class B : public A { };
class C { };

void f(int i) throw (A) {
    switch (i) {
        case 0: throw A();
        case 1: throw B();
        default: throw C();
    }
}

void g(int i) throw (A*) {
    A* a = new A();
    B* b = new B();
    C* c = new C();
    switch (i) {
        case 0: throw a;
        case 1: throw b;
        default: throw c;
    }
}

```

Function `f()` can throw objects of types `A` or `B`. If the function tries to throw an object of type `C`, the compiler will call `unexpected()` because type `C` has not been specified in the function's exception specification, nor does it derive publicly from `A`. Similarly, function `g()` cannot throw pointers to objects of type `C`; the function may throw pointers of type `A` or pointers of objects that derive publicly from `A`.

A function that overrides a virtual function can only throw exceptions specified by the virtual function. The following example demonstrates this:

```

class A {
public:
    virtual void f() throw (int, char);
};

class B : public A{
public: void f() throw (int) { }
};

/* The following is not allowed. */
/*
class C : public A {
public: void f() { }
};

class D : public A {
public: void f() throw (int, char, double) { }
};
*/

```

The compiler allows `B::f()` because the member function may throw only exceptions of type `int`. The compiler would not allow `C::f()` because the member function may throw any kind of exception. The compiler would not allow `D::f()` because the member function can throw more types of exceptions (`int`, `char`, and `double`) than `A::f()`.

Suppose that you assign or initialize a pointer to function named `x` with a function or pointer to function named `y`. The pointer to function `x` can only throw exceptions specified by the exception specifications of `y`. The following example demonstrates this:

```

void (*f)();
void (*g)();
void (*h)() throw (int);

void i() {
    f = h;
    // h = g; This is an error.
}

```

The compiler allows the assignment `f = h` because `f` can throw any kind of exception. The compiler would not allow the assignment `h = g` because `h` can only throw objects of type `int`, while `g` can throw any kind of exception.

Implicitly declared special member functions (default constructors, copy constructors, destructors, and copy assignment operators) have exception specifications. An implicitly declared special member function will have in its exception specification the types declared in the functions' exception specifications that the special function invokes. If any function that a special function invokes allows all exceptions, then that special function allows all exceptions. If all the functions that a special function invokes allow no exceptions, then that special function will allow no exceptions. The following example demonstrates this:

```

class A {
public:
    A() throw (int);
    A(const A&) throw (float);
    ~A() throw();
};

class B {
public:
    B() throw (char);
    B(const A&);
    ~B() throw();
};

class C : public B, public A { };

```

The following special functions in the above example have been implicitly declared:

```

C::C() throw (int, char);
C::C(const C&); // Can throw any type of exception, including float
C::~~C() throw();

```

The default constructor of `C` can throw exceptions of type `int` or `char`. The copy constructor of `C` can throw any kind of exception. The destructor of `C` cannot throw any exceptions.

Related reference:

Incomplete types

“Function declarations and definitions” on page 247

“Pointers to functions” on page 287

Chapter 15, “Special member functions (C++ only),” on page 385

“References (C++ only)” on page 123

Special exception handling functions

Not all thrown errors can be caught and successfully dealt with by a catch block. In some situations, the best way to handle an exception is to terminate the program. Two special library functions are implemented in C++ to process exceptions not properly handled by catch blocks or exceptions thrown outside of a valid try block. These functions are:

- “The `unexpected()` function”
- “The `terminate()` function” on page 480

The `unexpected()` function

When a function with an exception specification throws an exception that is not listed in its exception specification, the C++ run time does the following:

1. The `unexpected()` function is called.
2. The `unexpected()` function calls the function pointed to by `unexpected_handler`. By default, `unexpected_handler` points to the function `terminate()`.

You can replace the default value of `unexpected_handler` with the function `set_unexpected()`.

Although `unexpected()` cannot return, it may throw (or rethrow) an exception. Suppose the exception specification of a function `f()` has been violated. If `unexpected()` throws an exception allowed by the exception specification of `f()`, then the C++ run time will search for another handler at the call of `f()`. The following example demonstrates this:

```
#include <iostream>
using namespace std;

struct E {
    const char* message;
    E(const char* arg) : message(arg) { }
};

void my_unexpected() {
    cout << "Call to my_unexpected" << endl;
    throw E("Exception thrown from my_unexpected");
}

void f() throw(E) {
    cout << "In function f(), throw const char* object" << endl;
    throw("Exception, type const char*, thrown from f()");
}

int main() {
    set_unexpected(my_unexpected);
    try {
        f();
    }
    catch (E& e) {
        cout << "Exception in main(): " << e.message << endl;
    }
}
```

The following is the output of the above example:

```
In function f(), throw const char* object
Call to my_unexpected
Exception in main(): Exception thrown from my_unexpected
```

The `main()` function's try block calls function `f()`. Function `f()` throws an object of type `const char*`. However the exception specification of `f()` allows only objects of type `E` to be thrown. The function `unexpected()` is called. The function `unexpected()` calls `my_unexpected()`. The function `my_unexpected()` throws an object of type `E`. Since `unexpected()` throws an object allowed by the exception specification of `f()`, the handler in the `main()` function may handle the exception.

If `unexpected()` did not throw (or rethrow) an object allowed by the exception specification of `f()`, then the C++ run time does one of two things:

- If the exception specification of `f()` included the class `std::bad_exception`, `unexpected()` will throw an object of type `std::bad_exception`, and the C++ run time will search for another handler at the call of `f()`.
- If the exception specification of `f()` did not include the class `std::bad_exception`, the function `terminate()` is called.

Related reference:

“Special exception handling functions” on page 479

“The `set_unexpected()` and `set_terminate()` functions” on page 481

The `terminate()` function

In some cases, the exception handling mechanism fails and a call to `void terminate()` is made. This `terminate()` call occurs in any of the following situations:

- The exception handling mechanism cannot find a handler for a thrown exception. The following cases are more specific:
 - During stack unwinding, a destructor throws an exception and that exception is not handled.
 - The expression that is thrown also throws an exception, and that exception is not handled.
 - The constructor or destructor of a nonlocal static object throws an exception, and the exception is not handled.
 - A function registered with `atexit()` throws an exception, and the exception is not handled. The following demonstrates this:
- A throw expression without an operand tries to rethrow an exception, and no exception is presently being handled.
- A function `f()` throws an exception that violates its exception specification. The `unexpected()` function then throws an exception which violates the exception specification of `f()`, and the exception specification of `f()` did not include the class `std::bad_exception`.
- The default value of `unexpected_handler` is called.

The following example demonstrates that if a function registered with `atexit()` throws an exception and the exception is not handled, an invocation to `void terminate()` is made.

```
extern "C" printf(char* ...);
#include <exception>
#include <cstdlib>
using namespace std;

void f() {
    printf("Function f()\n");
    throw "Exception thrown from f()";
}

void g() { printf("Function g()\n"); }
```

```

void h() { printf("Function h()\n"); }

void my_terminate() {
    printf("Call to my_terminate\n");
    abort();
}

int main() {
    set_terminate(my_terminate);
    atexit(f);
    atexit(g);
    atexit(h);
    printf("In main\n");
}

```

See the output of the above example:

```

In main
Function h()
Function g()
Function f()
Call to my_terminate

```

To register a function with `atexit()`, you pass a parameter to `atexit()` a pointer to the function you want to register. At normal program termination, `atexit()` calls the functions you have registered with no arguments in reverse order. The `atexit()` function is in the `<cstdlib>` library.

The `terminate()` function calls the function pointed to by `terminate_handler`. By default, `terminate_handler` points to the function `abort()`, which exits from the program. You can replace the default value of `terminate_handler` with the function `set_terminate()`.

A terminate function cannot return to its caller, either by using `return` or by throwing an exception.

Related reference:

“The `set_unexpected()` and `set_terminate()` functions”

The `set_unexpected()` and `set_terminate()` functions

The function `unexpected()`, when invoked, calls the function most recently supplied as an argument to `set_unexpected()`. If `set_unexpected()` has not yet been called, `unexpected()` calls `terminate()`.

The function `terminate()`, when invoked, calls the function most recently supplied as an argument to `set_terminate()`. If `set_terminate()` has not yet been called, `terminate()` calls `abort()`, which ends the program.

You can use `set_unexpected()` and `set_terminate()` to register functions you define to be called by `unexpected()` and `terminate()`. The functions `set_unexpected()` and `set_terminate()` are included in the standard header files. Each of these functions has as its return type and its argument type a pointer to function with a `void` return type and no arguments. The pointer to function you supply as the argument becomes the function called by the corresponding special function: the argument to `set_unexpected()` becomes the function called by `unexpected()`, and the argument to `set_terminate()` becomes the function called by `terminate()`.

Both `set_unexpected()` and `set_terminate()` return a pointer to the function that was previously called by their respective special functions (`unexpected()` and

terminate()). By saving the return values, you can restore the original special functions later so that unexpected() and terminate() will once again call terminate() and abort().

If you use set_terminate() to register your own function, the function should not return to its caller but terminate execution of the program.

If you attempt to return from the function called by terminate(), abort() is called instead and the program ends.

Example using the exception handling functions

The following example shows the flow of control and special functions used in exception handling:

```
#include <iostream>
#include <exception>
using namespace std;

class X { };
class Y { };
class A { };

// pfv type is pointer to function returning void
typedef void (*pfv)();

void my_terminate() {
    cout << "Call to my terminate" << endl;
    abort();
}

void my_unexpected() {
    cout << "Call to my_unexpected()" << endl;
    throw;
}

void f() throw(X,Y, bad_exception) {
    throw A();
}

void g() throw(X,Y) {
    throw A();
}

int main()
{
    pfv old_term = set_terminate(my_terminate);
    pfv old_unex = set_unexpected(my_unexpected);
    try {
        cout << "In first try block" << endl;
        f();
    }
    catch(X) {
        cout << "Caught X" << endl;
    }
    catch(Y) {
        cout << "Caught Y" << endl;
    }
    catch (bad_exception& e1) {
        cout << "Caught bad_exception" << endl;
    }
    catch (...) {
        cout << "Caught some exception" << endl;
    }

    cout << endl;
}
```

```

try {
    cout << "In second try block" << endl;
    g();
}
catch(X) {
    cout << "Caught X" << endl;
}
catch(Y) {
    cout << "Caught Y" << endl;
}
catch (bad_exception& e2) {
    cout << "Caught bad_exception" << endl;
}
catch (...) {
    cout << "Caught some exception" << endl;
}
}

```

The following is the output of the above example:

```

In first try block
Call to my_unexpected()
Caught bad_exception

```

```

In second try block
Call to my_unexpected()
Call to my_terminate

```

The output also includes a memory dump in the core file in the current directory because of a call to the `abort()` function.

At run time, this program behaves as follows:

1. The call to `set_terminate()` assigns to `old_term` the address of the function last passed to `set_terminate()` when `set_terminate()` was previously called.
2. The call to `set_unexpected()` assigns to `old_unex` the address of the function last passed to `set_unexpected()` when `set_unexpected()` was previously called.
3. Within the first try block, function `f()` is called. Because `f()` throws an unexpected exception, a call to `unexpected()` is made. `unexpected()` in turn calls `my_unexpected()`, which prints a message to standard output. The function `my_unexpected()` tries to rethrow the exception of type `A`. Because class `A` has not been specified in the exception specification of function `f()`, and `bad_exception` has been specified, the exception thrown by `my_unexpected()` is replaced by an exception of type `bad_exception`.
4. The handler `catch (bad_exception& e1)` is able to handle the exception.
5. Within the second try block, function `g()` is called. Because `g()` throws an unexpected exception, a call to `unexpected()` is made. `unexpected()` in turn calls `my_unexpected()`, which prints a message to standard output. The function `my_unexpected()` tries to rethrow the exception of type `A`. Because neither class `A` nor `bad_exception` has been specified in the exception specification of function `g()`, `unexpected()` calls `terminate()`, which calls the function `my_terminate()`.
6. `my_terminate()` displays a message then calls `abort()`, which terminates the program.

In addition, the `abort()` function sends a SIGIOT signal, which terminates the process and produces a memory dump in the core file in the current directory.

Chapter 18. Preprocessor directives

Preprocessing is an initial phase to process text before compilation. Preprocessor directives are lines of the source file where the first non-whitespace character is #, which distinguishes them from other lines of text. The effect of each preprocessor directive is a change to the text and the result is a transformation of the text that does not contain the directives nor comments. The compiler can optionally output the preprocessed text to a file that has a .i suffix. Preprocessing is always the initial phase of compilation, even when the text has already been preprocessed.

Preprocessor directives consist of the following:

- “Macro definition directives,” which replace tokens in the current file with specified replacement tokens
- “File inclusion directives” on page 494, which imbed files within the current file
- “Conditional compilation directives” on page 496, which conditionally compile sections of the current file
- “Message generation directives” on page 501, which control the generation of diagnostic messages
-  “Assertion directives (IBM extension)” on page 503, which specify attributes of the system the program is to run on
- “The null directive (#)” on page 504, which performs no action
- “Pragma directives” on page 504, which apply compiler-specific rules to specified sections of code
- “C99 preprocessor features adopted in C++11” on page 506

Preprocessor directives begin with the # token followed by a preprocessor keyword. The # token must appear as the first character that is not white space on a line. The # is not part of the directive name and can be separated from the name with white spaces.

A preprocessor directive ends at the new-line character unless the last character of the line is the \ (backslash) character. If the \ character appears as the last character in the preprocessor line, the preprocessor interprets the \ and the new-line character as a continuation marker. The preprocessor deletes the \ (and the following new-line character) and splices the physical source lines into continuous logical lines. White space is allowed between backslash and the end of line character or the physical end of record. However, this white space is usually not visible during editing.

Except for some #pragma directives, preprocessor directives can appear anywhere in a program.

Macro definition directives

Macro definition directives include the following directives and operators:



The #define directive

A *preprocessor define directive* directs the preprocessor to replace all subsequent occurrences of a macro with specified replacement tokens.

The `#define` directive can contain:

- “Object-like macros”
- “Function-like macros” on page 487

The following are some differences between using a macro for a constant and a declared constant:

- A `const` object is subject to the scoping rules for variables, whereas a constant created using `#define` is not.
- Unlike a `const` object, the value of a macro does not appear in the intermediate representation used by the compiler because they are expanded inline. The inline expansion makes the macro value unavailable to the debugger.
-  A macro can be used in a compile-time constant expression, such as a bit field length, whereas a `const` object cannot.
-  The compiler does not type-check a macro, including macro arguments.

Object-like macros

An *object-like macro definition* replaces a single identifier with the specified replacement tokens. For example, the following object-like definition causes the preprocessor to replace all subsequent instances of the identifier `COUNT` with the constant `1000` :

```
#define COUNT 1000
```

If the statement

```
int arry[COUNT];
```

is after this macro definition and in the same compilation unit, the preprocessor would change the statement to

```
int arry[1000];
```

in the output of the preprocessor.

Other definitions can make reference to the identifier `COUNT`:

```
#define MAX_COUNT COUNT + 100
```

The preprocessor replaces each subsequent occurrence of `MAX_COUNT` with `COUNT + 100`, which the preprocessor then replaces with `1000 + 100`.

If a number that is partially built by a macro expansion is produced, the preprocessor does not consider the result to be a single value. For example, the following will not result in the value `10.2` but in a syntax error.

```
#define a 10
doubl d = a.2
```

 In C++11, the diagnostic for object-like macros in the C99 preprocessor is adopted to provide a common preprocessor interface for C and C++ compilers. The C++11 compiler issues a warning message if there are no white spaces between an object-like macro name and its replacement list in a macro definition. For more information, see “C99 preprocessor features adopted in C++11” on page 506.



Function-like macros

More complex than object-like macros, a function-like macro definition declares the names of formal parameters within parentheses, separated by commas. An empty formal parameter list is legal: such a macro can be used to simulate a function that takes no arguments. C99 adds support for function-like macros with a variable number of arguments. XL C++ supports function-like macros with a variable number of arguments, as a language extension for compatibility with C and as part of C++11. 

Function-like macro definition:

An identifier followed by a parameter list in parentheses and the replacement tokens. The parameters are imbedded in the replacement code. White space cannot separate the identifier (which is the name of the macro) and the left parenthesis of the parameter list. A comma must separate each parameter.

For portability, you should not have more than 31 parameters for a macro. The parameter list may end with an ellipsis (...) as the formal parameter. In this case, the identifier `__VA_ARGS__` may appear in the replacement list.

Function-like macro invocation:

An identifier followed by a comma-separated list of arguments in parentheses. The number of arguments should match the number of parameters in the macro definition, unless the parameter list in the definition ends with an ellipsis. In this latter case, the number of arguments in the invocation should match or exceed the number of parameters in the definition. The excess are called *trailing arguments*. Once the preprocessor identifies a function-like macro invocation, argument substitution takes place. A parameter in the replacement code is replaced by the corresponding argument. If trailing arguments are permitted by the macro definition, they are merged with the intervening commas to replace the identifier `__VA_ARGS__`, as if they were a single argument. Any macro invocations contained in the argument itself are completely replaced before the argument replaces its corresponding parameter in the replacement code.

A macro argument can be empty (consisting of zero preprocessing tokens). For example,

```
#define SUM(a,b,c) a + b + c
SUM(1,,3) /* No error message.
           1 is substituted for a, 3 is substituted for c. */
```

If the parameter list does not end with an ellipsis, the number of arguments in a macro invocation must be the same as the number of parameters in the corresponding macro definition. During parameter substitution, any arguments remaining after all specified arguments have been substituted (including any separating commas) are combined into one argument called the variable argument. The variable argument will replace any occurrence of the identifier `__VA_ARGS__` in the replacement list. The following example illustrates this:

```
#define debug(...) fprintf(stderr, __VA_ARGS__)
debug("flag"); /* Becomes fprintf(stderr, "flag"); */
```

Commas in the macro invocation argument list do not act as argument separators when they are:

- In character constants
- In string literals

- Surrounded by parentheses

The following line defines the macro SUM as having two parameters a and b and the replacement tokens (a + b):

```
#define SUM(a,b) (a + b)
```

This definition would cause the preprocessor to change the following statements (if the statements appear after the previous definition):

```
c = SUM(x,y);  
c = d * SUM(x,y);
```

In the output of the preprocessor, these statements would appear as:

```
c = (x + y);  
c = d * (x + y);
```

Use parentheses to ensure correct evaluation of replacement text. For example, the definition:

```
#define SQR(c) ((c) * (c))
```

requires parentheses around each parameter c in the definition in order to correctly evaluate an expression like:

```
y = SQR(a + b);
```

The preprocessor expands this statement to:

```
y = ((a + b) * (a + b));
```

Without parentheses in the definition, the intended order of evaluation is not preserved, and the preprocessor output is:

```
y = (a + b * a + b);
```

Arguments of the # and ## operators are converted *before* replacement of parameters in a function-like macro.

Once defined, a preprocessor identifier remains defined independent of the scoping rules of the language. The scope of a macro definition begins at the definition and does not end until a corresponding #undef directive is encountered. If there is no corresponding #undef directive, the scope of the macro definition lasts until the end of the translation unit.

A recursive macro is not fully expanded. For example, the definition

```
#define x(a,b) x(a+1,b+1) + 4
```

expands

```
x(20,10)
```

to

```
x(20+1,10+1) + 4
```

rather than trying to expand the macro x over and over within itself. After the macro x is expanded, it is a call to function x().

A definition is not required to specify replacement tokens. The following definition removes all instances of the token debug from subsequent lines in the current file:

```
#define debug
```

You can change the definition of a defined identifier or macro with a second preprocessor `#define` directive only if the second preprocessor `#define` directive is preceded by a preprocessor `#undef` directive. The `#undef` directive nullifies the first definition so that the same identifier can be used in a redefinition.

Within the text of the program, the preprocessor does not scan comments, character constants, or string constants for macro definitions, undefining a macro, or macro invocations.

The following example program contains two macro definitions and a macro invocation that refers to both of the defined macros:

```
/**This example illustrates #define directives.**/  
  
void printf(const char*, ...);  
#define SQR(s) ((s) * (s))  
#define PRNT(a,b) \  
    printf("value 1 = %d\n", a); \  
    printf("value 2 = %d\n", b)  
  
int main(void)  
{  
    int x = 2;  
    int y = 3;  
  
    PRNT(SQR(x),y);  
  
    return(0);  
}
```

After being preprocessed, this program is replaced by code equivalent to the following:

```
void printf(const char*, ...);  
  
int main(void)  
{  
    int x = 2;  
    int y = 3;  
  
    printf("value 1 = %d\n", ( (x) * (x) ) );  
    printf("value 2 = %d\n", y);  
  
    return(0);  
}
```

This program produces the following output:

```
value 1 = 4  
value 2 = 3
```



Variadic macro extensions

Variadic macro extensions refer to two extensions to C99 and Standard C++ related to macros with variable number of arguments. One extension is a mechanism for renaming the variable argument identifier from `__VA_ARGS__` to a user-defined identifier. The other extension provides a way to remove the dangling comma in a variadic macro when no variable arguments are specified. Both extensions have been implemented to facilitate porting programs developed with GNU C and C++.

The following examples demonstrate the use of an identifier in place of `__VA_ARGS__`. The first definition of the macro `debug` exemplifies the usual usage of `__VA_ARGS__`. The second definition shows the use of the identifier `args` in place of `__VA_ARGS__`.

```
#define debug1(format, ...) printf(format, ## __VA_ARGS__)
#define debug2(format, args ...) printf(format, ## args)
```

Invocation	Result of macro expansion
<code>debug1("Hello %s/n", "World");</code>	<code>printf("Hello %s/n", "World");</code>
<code>debug2("Hello %s/n", "World");</code>	<code>printf("Hello %s/n", "World");</code>

The preprocessor removes the trailing comma if the variable arguments to a function macro are omitted or empty and the comma followed by `##` precedes the variable argument identifier in the function macro definition.



C++11 In C++11, the variadic macros feature and changes concerning empty macro arguments are adopted from the C99 preprocessor to provide a common preprocessor interface for C and C++ compilers. Variadic macros and empty macro arguments are supported in C++11. For more information, see “C99 preprocessor features adopted in C++11” on page 506.

Related reference:

- “The const type qualifier” on page 101
- “Operator precedence and associativity” on page 212
- “Parenthesized expressions ()” on page 164

The #undef directive

A *preprocessor undef directive* causes the preprocessor to end the scope of a preprocessor definition.

#undef directive syntax

▶▶ `#undef identifier` ◀◀

If the identifier is not currently defined as a macro, `#undef` is ignored.

The following directives define `BUFFER` and `SQR`:

```
#define BUFFER 512
#define SQR(x) ((x) * (x))
```

The following directives nullify these definitions:

```
#undef BUFFER
#undef SQR
```

Any occurrences of the identifiers `BUFFER` and `SQR` that follow these `#undef` directives are not replaced with any replacement tokens. Once the definition of a macro has been removed by an `#undef` directive, the identifier can be used in a new `#define` directive.

The # operator

The # (single number sign) operator converts a parameter of a function-like macro into a character string literal. For example, if macro ABC is defined using the following directive:

```
#define ABC(x)  #x
```

all subsequent invocations of the macro ABC would be expanded into a character string literal containing the argument passed to ABC. For example:

Invocation	Result of macro expansion
ABC(1)	"1"
ABC>Hello there)	"Hello there"

The # operator should not be confused with the null directive.

Use the # operator in a function-like macro definition according to the following rules:

- A parameter following # operator in a function-like macro is converted into a character string literal containing the argument passed to the macro.
- White-space characters that appear before or after the argument passed to the macro are deleted.
- Multiple white-space characters imbedded within the argument passed to the macro are replaced by a single space character.
- If the argument passed to the macro contains a string literal and if a \ (backslash) character appears within the literal, a second \ character is inserted before the original \ when the macro is expanded.
- If the argument passed to the macro contains a " (double quotation mark) character, a \ character is inserted before the " when the macro is expanded.
- The conversion of an argument into a string literal occurs before macro expansion on that argument.
- If more than one ## operator or # operator appears in the replacement list of a macro definition, the order of evaluation of the operators is not defined.
- If the result of the macro expansion is not a valid character string literal, the behavior is undefined.

The following examples demonstrate the use of the # operator:

```
#define STR(x)      #x
#define XSTR(x)    STR(x)
#define ONE        1
```

Invocation	Result of macro expansion
STR(\n "\n" '\n')	"\n \"\\n\" '\\n' "
STR(ONE)	"ONE"
XSTR(ONE)	"1"
XSTR("hello")	"\"hello\""

Related reference:

"The null directive (#)" on page 504

The ## operator

The ## (double number sign) operator concatenates two tokens in a macro invocation (text and/or arguments) given in a macro definition.

If a macro XY was defined using the following directive:

```
#define XY(x,y)    x##y
```

the last token of the argument for x is concatenated with the first token of the argument for y.

Use the ## operator according to the following rules:

- The ## operator cannot be the very first or very last item in the replacement list of a macro definition.
- The last token of the item in front of the ## operator is concatenated with first token of the item following the ## operator.
- Concatenation takes place before any macros in arguments are expanded.
- If the result of a concatenation is a valid macro name, it is available for further replacement even if it appears in a context in which it would not normally be available.
- If more than one ## operator and/or # operator appears in the replacement list of a macro definition, the order of evaluation of the operators is not defined.

The following examples demonstrate the use of the ## operator:



```
#define ArgArg(x, y)    x##y
#define ArgText(x)     x##TEXT
#define TextArg(x)     TEXT##x
#define TextText      TEXT##text
#define Jitter         1
#define bug             2
#define Jitterbug      3
```

Invocation	Result of macro expansion
ArgArg(lady, bug)	ladybug
ArgText(con)	conTEXT
TextArg(book)	TEXTbook
TextText	TEXTtext
ArgArg(Jitter, bug)	3

Related reference:

“The #define directive” on page 485

Standard predefined macro names

The C compiler provides the following predefined macro names as specified in the ISO C language standard.  The XL C/C++ compiler supports these macros as an extension to be compatible with the C99 standard.  Except for `__FILE__` and `__LINE__`, the value of the predefined macros remains constant throughout the translation unit. The predefined macro names typically start and finish with 2 underscore characters.

`__DATE__`

A character string literal containing the date when the source file was preprocessed.

The value of `__DATE__` changes depending on when the input is preprocessed. The date is in the form:

"Mmm dd yyyy"

where:

- Mmm** Represents the month in an abbreviated form (Jan, Feb, Mar, Apr, May, Jun, Jul, Aug, Sep, Oct, Nov, or Dec).
- dd** Represents the day. If the day is less than 10, the first d is a blank character.
- yyyy** Represents the year.

__FILE__

A character string literal containing the name of the source file.

The value of `__FILE__` changes as included files that are part of the source program are preprocessed. It can be set with the `#line` directive.

__LINE__

An integer representing the current source line number.

The value of `__LINE__` changes during compilation as the compiler processes subsequent lines of your source program. It can be set with the `#line` directive.

__STDC__

For C, the integer 1 (one) indicates that the C compiler supports the ISO standard. If you set the language level to **classic**, this macro is undefined. (When a macro is undefined, it behaves as if it had the integer value 0 when used in a `#if` statement.)

For C++, this macro is predefined to have the value 0 (zero). This indicates that the C++ language is not a proper superset of C, and that the compiler does not conform to ISO C.

__STDC_HOSTED__ (C only)

The value of this C99 macro is 1, indicating that the C compiler is a hosted implementation. Note that this macro is only defined if `__STDC__` is also defined.

__STDC_VERSION__ (C only)

The integer constant of type `long int`: 199409L for the C89 language level, 199901L for C99. Note that this macro is only defined if `__STDC__` is also defined.

__TIME__

A character string literal containing the time when the source file was preprocessed.

The value of `__TIME__` changes as included files that are part of the source program are preprocessed. The time is in the form:

"hh:mm:ss"

where:

- hh** Represents the hour.
- mm** Represents the minutes.
- ss** Represents the seconds.

__cplusplus (C++ only)

For C++ programs, this macro expands to the long integer literal 199711L,

indicating that the compiler is a C++ compiler. For C programs, this macro is not defined. Note that this macro name has no trailing underscores.



Related reference:

“The #line directive” on page 502

Object-like macros

File inclusion directives

File inclusion directives consist of:

- “The #include directive,” which inserts text from another source file
-  “The #include_next directive (IBM extension)” on page 495, which causes the compiler to omit the directory of the including file from the search path when searching for include files. 

The #include directive

A *preprocessor include directive* causes the preprocessor to replace the directive with the contents of the specified file.

#include directive syntax

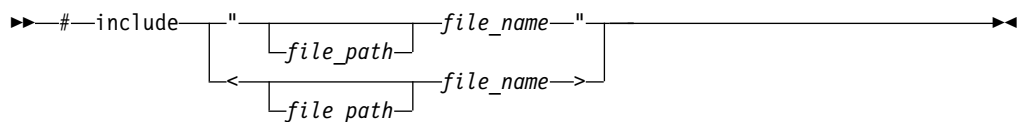

If the *file_name* is enclosed in double quotation marks, for example:

```
#include "payroll.h"
```

it is treated as a user-defined file, and may represent a header or source file.

If the *file_name* is enclosed in angle brackets, for example:

```
#include <stdio.h>
```

it is treated as a system-defined file, and must represent a header file.

The new-line and > characters cannot appear in a file name delimited by < and >. The new-line and " (double quotation marks) characters cannot appear in a file name delimited by " and ", although > can.

The *file_path* can be an absolute or relative path. If the double quotation marks are used, and *file_path* is a relative path, or is not specified, the preprocessor adds the directory of the including file to the list of paths to be searched for the included file. If the double angle brackets are used, and *file_path* is a relative path, or is not specified, the preprocessor does *not* add the directory of the including file to the list of paths to be searched for the included file.

The preprocessor resolves macros contained in an #include directive. After macro replacement, the resulting token sequence consists of a file name enclosed in either double quotation marks or the characters < and >. For example:

```
#define MONTH <july.h>  
#include MONTH
```

Declarations that are used by several files can be placed in one file and included with `#include` in each file that uses them. For example, the following file `defs.h` contains several definitions and an inclusion of an additional file of declarations:

```
/* defs.h */
#define TRUE 1
#define FALSE 0
#define BUFFERSIZE 512
#define MAX_ROW 66
#define MAX_COLUMN 80
extern int hour;
extern int min;
extern int sec;
#include "mydefs.h"
```

You can embed the definitions that appear in `defs.h` with the following directive:

```
#include "defs.h"
```

In the following example, a `#define` combines several preprocessor macros to define a macro that represents the name of the C standard I/O header file. A `#include` makes the header file available to the program.

```
#define C_IO_HEADER <stdio.h>

/* The following is equivalent to:
 * #include <stdio.h>
 */

#include C_IO_HEADER
```

C++11 In C++11, the changes to header and include file names in the C99 preprocessor are adopted to provide a common preprocessor interface for C and C++ compilers. The first character of a header file name in an `#include` directive must not be a digit in C++11. For more information, see “C99 preprocessor features adopted in C++11” on page 506. **C++11**

The `#include_next` directive (IBM extension)

The preprocessor directive `#include_next` behaves like the `#include` directive, except that it specifically excludes the directory of the including file from the paths to be searched for the named file. All search paths up to and including the directory of the including file are omitted from the list of paths to be searched for the included file. This allows you to include multiple versions of a file with the same name in different parts of an application; or to include one header file in another header file with the same name (without the header including itself recursively). Provided that the different file versions are stored in different directories, the directive ensures you can access each version of the file, without requiring that you use absolute paths to specify the file name.

`#include_next` directive syntax

```
▶▶ #include_next "file_name"
                [file_path]
                [file_name]
                [file_path]
```

The directive must only be used in header files, and the file specified by the `file_name` must be a header file. There is no distinction between the use of double quotation marks and angle brackets to enclose the file name.

As an example of how search paths are resolved with the `#include_next` directive, assume that there are two versions of the file `t.h`: the first one, which is included in the source file `t.c`, is located in the subdirectory `path1`; the second one, which is included in the first one, is located in the subdirectory `path2`. Both directories are specified as include file search paths when `t.c` is compiled.

```
/* t.c */

#include "t.h"

int main()
{
    printf(" ret_val);
}

/* t.h in path1 */

#include_next "t.h"

int ret_val = RET;

/* t.h in path2 */

#define RET 55;
```

The `#include_next` directive instructs the preprocessor to skip the `path1` directory and start the search for the included file from the `path2` directory. This directive allows you to use two different versions of `t.h` and it prevents `t.h` from being included recursively.

Conditional compilation directives

A *preprocessor conditional compilation directive* causes the preprocessor to conditionally suppress the compilation of portions of source code. These directives test a constant expression or an identifier to determine which tokens the preprocessor should pass on to the compiler and which tokens should be bypassed during preprocessing. The directives are:

- “The `#if` and `#elif` directives” on page 497, which conditionally include or suppress portions of source code, depending on the result of a constant expression
- “The `#ifdef` directive” on page 498, which conditionally includes source text if a macro name is defined
- “The `#ifndef` directive” on page 499, which conditionally includes source text if a macro name is not defined
- “The `#else` directive” on page 499, which conditionally includes source text if the previous `#if`, `#ifdef`, `#ifndef`, or `#elif` test fails
- “The `#endif` directive” on page 499, which ends conditional text

The preprocessor conditional compilation directive spans several lines:

- The condition specification line (beginning with `#if`, `#ifdef`, or `#ifndef`)
- Lines containing code that the preprocessor passes on to the compiler if the condition evaluates to a nonzero value (optional)
- The `#elif` line (optional)
- Lines containing code that the preprocessor passes on to the compiler if the condition evaluates to a nonzero value (optional)
- The `#else` line (optional)

- Lines containing code that the preprocessor passes on to the compiler if the condition evaluates to zero (optional)
- The preprocessor `#endif` directive

For each `#if`, `#ifdef`, and `#ifndef` directive, there are zero or more `#elif` directives, zero or one `#else` directive, and one matching `#endif` directive. All the matching directives are considered to be at the same nesting level.

Conditional compilation directives can be nested. A `#else`, if present, can be matched unambiguously because of the required `#endif`.

```
#ifndef MACNAME
/* tokens added if MACNAME is defined */
#   if TEST <=10
/* tokens added if MACNAME is defined and TEST <= 10 */
#   else
/* tokens added if MACNAME is defined and TEST > 10 */
#   endif
#else
/* tokens added if MACNAME is not defined */
#endif
```

Each directive controls the block immediately following it. A block consists of all the tokens starting on the line following the directive and ending at the next conditional compilation directive at the same nesting level.

Each directive is processed in the order in which it is encountered. If an expression evaluates to zero, the block following the directive is ignored.

When a block following a preprocessor directive is to be ignored, the tokens are examined only to identify preprocessor directives within that block so that the conditional nesting level can be determined. All tokens other than the name of the directive are ignored.

Only the first block whose expression is nonzero is processed. The remaining blocks at that nesting level are ignored. If none of the blocks at that nesting level has been processed and there is a `#else` directive, the block following the `#else` directive is processed. If none of the blocks at that nesting level has been processed and there is no `#else` directive, the entire nesting level is ignored.



The `#if` and `#elif` directives

The `#if` directive conditionally includes text for preprocessing. If the condition that follows the `#if` directive evaluates to a nonzero value, the text following up to but excluding the associated `#endif` is included as preprocessing input.

The `#elif` (a contraction of else-if) directive, if used, must be contained within a section of text subject to an `#if` directive. This directive optionally includes a section of text based on the evaluation result of the condition that immediately follows the directive. The `#elif` directive evaluates its condition only when the original condition on the `#if` evaluates to false and all conditions associated with preceding `#elif` directives subject to the original `#if` also evaluate to false.

`#if` and `#elif` directive syntax

```
▶ # — if — constant_expression —▶
    └─ elif ─┘
```

All macros are expanded, except macros that are the operand of a defined operator. Any uses of the defined operator are processed, and all remaining keywords and identifiers are replaced with the token 0  except true and false .



The behavior is undefined if expanding the macros resulted in the token defined.

Notes:

- Casts cannot be performed. For example, the following code can be compiled successfully by both the C and C++ compilers.

```
#if static_cast<int>(1)
#error Unexpected
#endif
```

```
int main() {
}
```

- Arithmetic is performed using long int type.  In C++11, arithmetic is performed using long long int type. See “C99 preprocessor features adopted in C++11” on page 506 for detailed information. 
- The *constant_expression* can contain defined macros.
- The *constant_expression* can contain the unary operator defined. This operator can be used only with the preprocessor keyword #if or #elif. The following expressions evaluate to 1 if the *identifier* is defined in the preprocessor, otherwise to 0:

```
defined identifier
defined(identifier)
```

For example:

```
#if defined(TEST1) || defined(TEST2)
```

- The *constant_expression* must be an integral constant expression.

If a macro is not defined, a value of 0 (zero) is assigned to it. In the following example, TEST is a macro identifier.

```
#include <stdio.h>
int main()
{
    #if TEST != 0    // No error even when TEST is not defined.
        printf("Macro TEST is defined to a non-zero value.");
    #endif
}
```

The #ifdef directive

The #ifdef directive checks for the existence of macro definitions.

If the identifier specified is defined as a macro, the lines of code that immediately follow the condition are passed on to the compiler. You must use the #endif directive to end the conditional compilation directive.

#ifdef directive syntax

►► #ifdef *identifier* ◀◀

The following example defines MAX_LEN to be 75 if EXTENDED is defined for the preprocessor. Otherwise, MAX_LEN is defined to be 50.

```
#ifdef EXTENDED
#   define MAX_LEN 75
#else
#   define MAX_LEN 50
#endif
```

The #ifndef directive

The `#ifndef` directive checks whether a macro is not defined.

If the identifier specified is not defined as a macro, the lines of code immediately follow the condition are passed on to the compiler.

#ifndef directive syntax

```
▶▶ #ifndef identifier ▶▶
```

An identifier must follow the `#ifndef` keyword. The following example defines `MAX_LEN` to be 50 if `EXTENDED` is not defined for the preprocessor. Otherwise, `MAX_LEN` is defined to be 75.

```
#ifndef EXTENDED
#   define MAX_LEN 50
#else
#   define MAX_LEN 75
#endif
```

The #else directive

If the condition specified in the `#if`, `#ifdef`, or `#ifndef` directive evaluates to 0, and the conditional compilation directive contains a preprocessor `#else` directive, the lines of code located between the preprocessor `#else` directive and the preprocessor `#endif` directive is selected by the preprocessor to be passed on to the compiler.

#else directive syntax

```
▶▶ #else ▶▶
```

The #endif directive

The preprocessor `#endif` directive ends the conditional compilation directive.

#endif directive syntax

```
▶▶ #endif ▶▶
```

Extension of #endif and #else (IBM extension)

The C and C++ language standards do not support extra text after `#endif` or `#else`. XL C/C++ compiler complies with the standards. When you port code from a compiler that supports extra text after `#endif` or `#else`, you can specify option **-qlanglvl=tafterendif** to suppress the warning message that is emitted.

One use is to comment on what is being tested by the corresponding `#if` or `#ifdef`. For example:

```

#ifdef MY_MACRO
...
#else MY_MACRO not defined
...
#endif MY_MACRO

```

In this case, if you want the compiler to be silent about this deviation from the standards, you can suppress the message by specifying option **-q`langlvl`=`textafterendif`**.

The suboption **textafterendif** can be specified with any of the supported language levels. In almost all cases the default for this suboption is **-q`langlvl`=`notextafterendif`**, indicating that a message will be emitted if there is any extraneous text after `#else` or `#endif`. The one exception is in the C compiler, when the language level is "classic". In this case, the default for the suboption is **-q`langlvl`=`textafterendif`**, because this language level already allows extra text after `#else` or `#endif` without generating a message.

Examples of conditional compilation directives

The following example shows how you can nest preprocessor conditional compilation directives:

```

#ifdef TARGET1
# define SIZEOF_INT 16
# ifdef PHASE2
#   define MAX_PHASE 2
# else
#   define MAX_PHASE 8
# endif
#elif defined(TARGET2)
# define SIZEOF_INT 32
# define MAX_PHASE 16
#else
# define SIZEOF_INT 32
# define MAX_PHASE 32
#endif

```

The following program contains preprocessor conditional compilation directives:

```

/**
** This example contains preprocessor
** conditional compilation directives.
**/

#include <stdio.h>

int main(void)
{
    static int array[ ] = { 1, 2, 3, 4, 5 };
    int i;

    for (i = 0; i <= 4; i++)
    {
        array[i] *= 2;
    }

#ifdef TEST >= 1
    printf("i = %d\n", i);
    printf("array[i] = %d\n",
        array[i]);
#endif

    }
    return(0);
}

```

Message generation directives

Message generation directives include the following ones:

- “The `#error` directive,” which defines text for a compile-time error message
- “The `#warning` directive (IBM extension),” which defines text for a compile-time warning message
- “The `#line` directive” on page 502, which supplies a line number for compiler messages

Related reference:

“Conditional compilation directives” on page 496

The `#error` directive

A *preprocessor error directive* causes the preprocessor to generate an error message and causes the compilation to fail.

#error directive syntax



The `#error` directive is often used in the `#else` portion of a `#if-#elif-#else` construct, as a safety check during compilation. For example, `#error` directives in the source file can prevent code generation if a section of the program is reached that should be bypassed.

For example, the directives

```
#define BUFFER_SIZE 255

#if BUFFER_SIZE < 256
#error "BUFFER_SIZE is too small."
#endif
```

generate the error message:

```
BUFFER_SIZE is too small.
```

The `#warning` directive (IBM extension)

A *preprocessor warning directive* causes the preprocessor to generate a warning message but allows compilation to continue. The argument to `#warning` is not subject to macro expansion.

#warning directive syntax



The preprocessor `#warning` directive is a language extension provided to facilitate handling programs developed with GNU C. The IBM implementation preserves multiple white spaces.

The #line directive

A *preprocessor line control directive* supplies line numbers for compiler messages. It causes the compiler to view the line number of the next source line as the specified number.

#line directive syntax

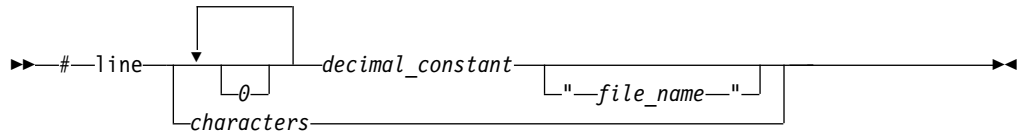

In order for the compiler to produce meaningful references to line numbers in preprocessed source, the preprocessor inserts #line directives where necessary (for example, at the beginning and after the end of included text).

A file name specification enclosed in double quotation marks can follow the line number. If you specify a file name, the compiler views the next line as part of the specified file. If you do not specify a file name, the compiler views the next line as part of the current source file.

In all C and C++ implementations, the token sequence on a #line directive is subject to macro replacement. After macro replacement, the resulting character sequence must consist of a decimal constant, optionally followed by a file name enclosed in double quotation marks.

You can use #line control directives to make the compiler provide more meaningful error messages. The following example program uses #line control directives to give each function an easily recognizable line number:

```
/**
 ** This example illustrates #line directives.
 **/

#include <stdio.h>
#define LINE200 200

int main(void)
{
    func_1();
    func_2();
}

#line 100
func_1()
{
    printf("Func_1 - the current line number is %d\n", __LINE__);
}

#line LINE200
func_2()
{
    printf("Func_2 - the current line number is %d\n", __LINE__);
}
```

This program produces the following output:

```
Func_1 - the current line number is 102
Func_2 - the current line number is 202
```

C++11 In C++11, the increased limit for `#line` directive from the C99 preprocessor are adopted to provide a common preprocessor interface for C and C++ compilers. The upper limit of `#line <integer>` preprocessor directives has been increased from 32,767 to 2,147,483,647 for the C++ preprocessor in conformance with the C99 preprocessor. For more information, see “C99 preprocessor features adopted in C++11” on page 506. **C++11**

Related reference:

 See `__C99_MAX_LINE_NUMBER` in the XL C/C++ Compiler Reference

Assertion directives (IBM extension)

An *assertion directive* is an alternative to a macro definition, used to define the computer or system the compiled program will run on. Assertions are usually predefined, but you can define them with the `#assert` preprocessor directive.

#assert directive syntax

►► `#assert predicate (answer)` ◀◀

The *predicate* represents the assertion entity you are defining. The *answer* represents a value you are assigning to the assertion. You can make several assertions using the same predicate and different answers. All the answers for any given predicate are simultaneously true. For example, the following directives create assertions regarding font properties:

```
#assert font(arial)
#assert font(blue)
```

Once an assertion has been defined, the assertion predicate can be used in conditional directives to test the current system. The following directive tests whether `arial` or `blue` is asserted for `font`:

```
#if #font(arial) || #font(blue)
```

You can test whether any answer is asserted for a predicate by omitting the answer in the conditional:

```
#if #font
```

Assertions can be cancelled with the `#unassert` directive. If you use the same syntax as the `#assert` directive, the directive cancels only the answer you specify. For example, the following directive cancels the `arial` answer for the `font` predicate:

```
#unassert font(arial)
```

An entire predicate is cancelled by omitting the answer from the `#unassert` directive. The following directive cancels the `font` directive altogether:

```
#unassert font
```

Related reference:

“Conditional compilation directives” on page 496

Predefined assertions

The following assertions are predefined for the AIX platform:

Table 40. Predefined assertions for AIX

#machine	#system(unix) #system(aix)	#cpu
----------	-------------------------------	------

The null directive (#)

The *null directive* performs no action. It consists of a single # on a line of its own.

The null directive should not be confused with the # operator or the character that starts a preprocessor directive.

In the following example, if MINVAL is a defined macro name, no action is performed. If MINVAL is not a defined identifier, it is defined 1.

```
#ifdef MINVAL
#
#else
#define MINVAL 1
#endif
```

Related reference:

“The # operator” on page 491

Pragma directives

A *pragma* is an implementation-defined instruction to the compiler. It has the general form:

#pragma directive syntax

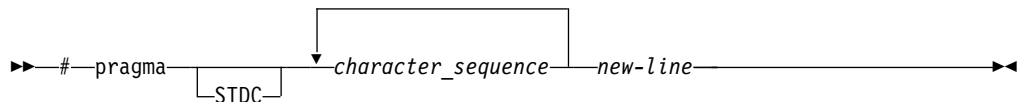



The *character_sequence* is a series of characters giving a specific compiler instruction and arguments, if any. The token STDC indicates a standard pragma; consequently, no macro substitution takes place on the directive. The *new-line* character must terminate a pragma directive.

The *character_sequence* on a pragma is subject to macro substitutions. For example,

```
#define XX_ISO_DATA isolated_call(LG_ISO_DATA)
// ...
#pragma XX_ISO_DATA
```

Note: You can also use the `_Pragma` operator syntax to specify a pragma directive; for details, see “The `_Pragma` preprocessing operator” on page 505.

More than one pragma construct can be specified on a single pragma directive. The compiler ignores unrecognized pragmas.

Standard C pragmas are described in “Standard pragmas.”  Pragmas available for XL C/C++ are described in “General purpose pragmas” in the *XL C/C++ Compiler Reference*. 

The `_Pragma` preprocessing operator

The unary operator `_Pragma`, allows a preprocessor macro to be contained in a pragma directive.

`_Pragma` operator syntax

►► `_Pragma`—(—“—*string_literal*—”——)—————►►

The *string_literal* can be prefixed with `L`, making it a wide-string literal.

The string literal is destringized and tokenized. The resulting sequence of tokens is processed as if it appeared in a pragma directive. For example, the following two statements are equivalent:

```
_Pragma ( "pack(full)" )
#pragma pack(full)
```

 In C++11, the `_Pragma` operator feature of the C99 preprocessor is adopted to provide a common preprocessor interface for C and C++ compilers. The `_Pragma` operator is an alternative method of specifying the `#pragma` directive. For more information, see “C99 preprocessor features adopted in C++11” on page 506.

Standard pragmas

A *standard pragma* is a pragma preprocessor directive for which the C Standard defines the syntax and semantics and for which no macro replacement is performed. A standard pragma must be one of the following:

►► `#pragma`—STDC—

FP_CONTRACT	ON
FENV_ACCESS	OFF
CX_LIMITED_RANGE	DEFAULT

—*new-line*—————►►

 The `FP_CONTRACT` and `FENV_ACCESS` pragmas are recognized and ignored.

`CX_LIMITED_RANGE` is described below.

pragma STDC CX_LIMITED_RANGE

The usual mathematical formulas for complex multiplication, division, and absolute value are problematic because of their treatment of infinities and because of undue overflow and underflow. The usual formulas are as follows:

$$(x + iy) \times (u + iv) = (xu - yv) + i(yu + xv)$$

$$(x + iy)/(u + iv) = [(xu + yv) + i(yu - xv)]/(u^2 + v^2)$$

$$|x + iy| = \text{sqrt}(x^2 + y^2)$$

By default, the compiler uses slightly more complex but mathematically safer algorithms to implement these calculations. Where you determine that the usual mathematical formulas are safe, you can use the STDC `CX_LIMITED_RANGE`

pragma to inform the compiler that, when the state is "on", the formulas are acceptable. In doing so, you allow the compiler to generate faster code for these computations. When the state is "off", the compiler will continue to use the safer algorithms. For details on the implementation of this pragma, see **#pragma STDC cx_limited_range** in the *XL C/C++ Compiler Reference*.

C99 preprocessor features adopted in C++11

Note: IBM supports selected features of C++11, known as C++0x before its ratification. IBM will continue to develop and implement the features of this standard. The implementation of the language level is based on IBM's interpretation of the standard. Until IBM's implementation of all the C++11 features is complete, including the support of a new C++11 standard library, the implementation might change from release to release. IBM makes no attempt to maintain compatibility, in source, binary, or listings and other compiler interfaces, with earlier releases of IBM's implementation of the new C++11 features.

In the C++11 standard, several C99 preprocessor features are adopted to provide a common preprocessor interface for C and C++ compilers. This eases porting C source files to the C++ compiler and eliminates some subtle semantic differences that exist between the old C and C++ preprocessors, thus avoiding preprocessor compatibility issues or diverging preprocessor behaviors.

The following C99 preprocessor features are adopted in C++11:

- Preprocessor arithmetic with extended integer types
- Mixed string literal concatenation
- Diagnostic for header files and include names
- Increased limit for #line directives
- Diagnostic for object-like macro definitions
- The `_Pragma` operator
- Variadic macros and empty macro arguments
- Predefined macros

Preprocessor arithmetic with extended integer types

In the C89, C++98, and C++03 preprocessors, integer literals that have `int` or `unsigned int` type are widened to `long` or `unsigned long`. However, in the C99 and C++11 preprocessors, all signed and unsigned integer types (character types included) are widened to `long long` or `unsigned long long` under normal circumstances in XL C/C++.

If this feature is enabled, and both `-qno1ong1ong` and `-qlanglvl=noc991ong1ong` are set in either `-q32` or `-q64` modes, the preprocessor still uses `long long` or `unsigned long long` representations for all integral and character literals in preprocessor controlling expressions.

The following example is valid on the AIX platform in `-q32` mode where the underlying type of `wchar_t` is `unsigned short`.

```
#if L'\x0' - L'\x1' < 0
#error non-C++11 preprocessor arithmetic.
#else
#error C++11 preprocessor arithmetic! L'\x0' and L'\x1' are widened to\
    unsigned long long
#endif
```

The following example shows a case where the long long support is enabled in **-q32** mode, this feature causes different inclusion branches to be chosen between the non-C++11 preprocessor and the C++11 preprocessor.

```
#if ~0u11 == 0u + ~0u
#error C++11 preprocessor arithmetic! 0u has the same representation as 0u11,\
      hence ~0u11 == 0u + ~0u
#else
#error non-C++11 preprocessor arithmetic. 0u1 does not have the same \
      representation as 0u11, hence ~0u11 != 0u + ~0u
#endif
```

If this feature is disabled and **-qwarn0x** is set, the C++11 preprocessor evaluates the controlling expressions in the **#if** and **#elif** directives, and compares the evaluation results against that of the non-C++11 preprocessor. If they are different, the compiler warns you that the preprocessor controlling expression evaluates differently between C++11 and non-C++11 language levels.

Mixed string literal concatenation

Regular strings can be concatenated with wide-string literals, for example:

```
#include <wchar.h>
#include <stdio.h>

int main()
{
    wprintf(L"Guess what? %ls\n", "I can now concate" L"nate regular strings\
        and wide strings!");
    printf("Guess what? %ls\n", L"I can now concate" "nate strings\
        this way too!");
}
```

This example prints the following output when it is executed:

```
Guess what? I can now concatenate regular strings and wide strings!
Guess what? I can now concatenate strings this way too!
```

Diagnostic for header files and include names

When this feature is enabled, if the first character of a header file name in an **#include** directive is a digit, the compiler issues a warning message. Consider the following example:

```
//inc.C

#include "0x/mylib.h"

int main()
{
    return 0;
}
```

When compiling or preprocessing this example with this feature enabled, the compiler issues the following warning message:

```
"inc.C", line 1.10: 1540-0893 (W) The header file name "0x/mylib.h"
in #include directive shall not start with a digit.
```

Increased limit for #line directives

The upper limit of the **#line <integer>** preprocessor directives has been increased from 32,767 to 2,147,483,647 for the C++11 preprocessor in conformance with the C99 preprocessor.

```
#line 1000000 //Valid in C++11, but invalid in C++98
int main()
{
    return 0;
}
```

Diagnostic for object-like macro definitions

If there is no white space between object-like macro name and its replacement list in a macro definition, the C++11 compiler issues a warning message. Consider the following example:

```
//w.C

//With -qnodollar, '$' is not part of the macro name,
//thus it begins the replacement list
#define A$B c
#define STR2( x ) # x
#define STR( x ) STR2( x )
char x[] = STR( A$B );
```

When compiling or preprocessing this example with this feature enabled and **-qnodollar** is specified, the compiler issues the following warning message:

```
"w.C", line 1.10: 1540-0891 (W) Missing white space between
the identifier "A" and the replacement list.
```

The `_Pragma` operator

The `_Pragma` operator is an alternative method of specifying `#pragma` directives. For example, the following two statements are equivalent:

```
#pragma comment(copyright, "IBM 2010")
_Pragma("comment(copyright, \"IBM 2010\")")
```

The string IBM 2010 is inserted into the C++ object file when the following code is compiled:

```
_Pragma("comment(copyright, \"IBM 2010\")")
int main()
{
    return 0;
}
```

Variadic macros and empty macro arguments

Variadic macros and empty macro arguments are supported in C99 and C++11. For details, see Variadic macros.

Predefined macros

The `__STDC_HOSTED__` macro is predefined to 1, regardless of whether the following macros are defined or not:

- `__STDC__`
- `__STDC_VERSION__`
- `__STDC_ISO_10646__`

Related reference:

“Integer literals” on page 21

“String literals” on page 34

“The `#include` directive” on page 494

"The #line directive" on page 502
"The #define directive" on page 485
"The _Pragma preprocessing operator" on page 505
"C++11 compatibility" on page 519

Chapter 19. The IBM XL C language extensions

The IBM XL C extensions include C features as extensions in the following categories:

- “General IBM extensions”
- “C11 compatibility” on page 512
- “Extensions for GNU C compatibility” on page 512
- “Extensions for Unicode support” on page 516
- “Extensions for vector processing support” on page 516

General IBM extensions

The following features are enabled by default at all extended language levels:

Table 41. General IBM extensions

Language feature	Discussed in:
Allowed types in typedef definitions	“typedef definitions” on page 86
Extended types allowed in bit field structure members	Bit field members

The following features are disabled by default at all language levels. It also can be enabled or disabled by an individual option.

Table 42. General IBM extensions with individual option controls

Language feature	Discussed in:	Individual option controls
<code>__static_assert</code> keyword	“Keywords for language extensions (IBM extension)” on page 16	<code>-q[no]keyword=__static_assert</code>
Extra text after <code>#endif</code> or <code>#else</code>	“Extension of <code>#endif</code> and <code>#else</code> (IBM extension)” on page 499	<code>-q[an]lvl=[no]textafterendif</code>

The following feature is enabled by default with the `xlC`, `xlC++`, `xlC`, `cc` and `c99` invocation commands when the `extc99`, `stdc99`, or `extc1x` language level is not in effect. It can also be enabled or disabled by a specific compiler option, listed in the following table:

Table 43. General IBM extensions with individual option controls

Language feature	Discussed in:	Individual option controls
Non-C99 IBM long long extension	Types of integer literals outside of C99 and C++11	<code>-q[no]longlong</code>

The following feature is enabled by default with the `xlC`, `xlC++`, `xlC`, `cc` and `c99` invocation commands when the `extc99`, `stdc99`, or `extc1x` language level is in effect.

Table 44. General IBM extensions

Language feature	Discussed in:
C99 long long feature with the associated IBM extensions	Types of integer literals in C99 and C++11

Related reference:

 See `-qlonglong` in the XL C/C++ Compiler Reference

C11 compatibility

Note: IBM supports selected features of C11, known as C1X before its ratification. IBM will continue to develop and implement the features of this standard. The implementation of the language level is based on IBM's interpretation of the standard. Until IBM's implementation of all the C11 features is complete, including the support of a new C11 standard library, the implementation may change from release to release. IBM makes no attempt to maintain compatibility, in source, binary, or listings and other compiler interfaces, with earlier releases of IBM's implementation of the C11 features.

The following features are part of a continual phased release process leading towards full compliance with C11. They can be enabled by the `-qlanglvl=extc1x` group option when you compile with the C compiler. Certain C11 features are also available when you compile with the C++ compiler. For further information, see sections that describe individual features.

Table 45. Supported C11 features

Language feature	Discussed in:
<code>_Noreturn</code> function specifier, <code>_Noreturn</code> keyword	"The <code>_Noreturn</code> function specifier" on page 260, "Keywords for language extensions (IBM extension)" on page 16
Anonymous structures	Anonymous structures
Anonymous unions	Anonymous unions
Complex type initializations	"Initialization of complex types (C11)" on page 139
Generic selection	"Generic selection (C11)" on page 165
Static assertions	<code>_Static_assert</code> declaration
typedef redeclarations	"typedef definitions" on page 86

Related reference

`-qlanglvl` in the XL C/C++ Compiler Reference

Extensions for GNU C compatibility

The following feature is enabled by default at all language levels:

Table 46. Default IBM XL C extensions for GNU C compatibility

Language feature	Discussed in:
<code>#include_next</code> preprocessor directive	"The <code>#include_next</code> directive (IBM extension)" on page 495

The following features are enabled by default when you compile with any of the following commands:

- the `xlc` invocation command
- the `-qlanglvl=extc99 | extc89 | extc1x | extended` options

Table 47. Default IBM XL C extensions for GNU C compatibility

Language feature	Discussed in:
<code>__alignof</code> and <code>__alignof__</code> keywords	"The <code>__alignof__</code> operator (IBM extension)" on page 175, "Keywords for language extensions (IBM extension)" on page 16
<code>__align</code> type qualifier	"The <code>__align</code> type qualifier (IBM extension)" on page 99
<code>__alignof__</code> operator	"The <code>__alignof__</code> operator (IBM extension)" on page 175
<code>__attribute</code> and <code>__attribute__</code> keywords	"Variable attributes (IBM extension)" on page 140, "Function attributes (IBM extension)" on page 268, "Keywords for language extensions (IBM extension)" on page 16
<code>__complex__</code> keyword	"Keywords for language extensions (IBM extension)" on page 16
<code>__extension__</code> keyword	"Keywords for language extensions (IBM extension)" on page 16
<code>__imag__</code> and <code>__real__</code> keywords	"The <code>__real__</code> and <code>__imag__</code> operators (IBM extension)" on page 179 "Keywords for language extensions (IBM extension)" on page 16
<code>__imag__</code> and <code>__real__</code> complex type operators	"The <code>__real__</code> and <code>__imag__</code> operators (IBM extension)" on page 179
<code>__inline__</code> keyword	"The inline function specifier" on page 256, "Keywords for language extensions (IBM extension)" on page 16
<code>__label__</code> keyword	"Nested functions (C only) (IBM extension)" on page 289, "Locally declared labels (IBM extension)" on page 220, "Keywords for language extensions (IBM extension)" on page 16
<code>__restrict</code> and <code>__restrict__</code> keywords	"The restrict type qualifier" on page 102, "Keywords for language extensions (IBM extension)" on page 16
<code>__thread</code> keyword	"The <code>__thread</code> storage class specifier (IBM extension) " on page 60, "Keywords for language extensions (IBM extension)" on page 16
<code>__typeof__</code> keyword	"The <code>typeof</code> operator (IBM extension)" on page 178, "Keywords for language extensions (IBM extension)" on page 16
<code>__typeof__</code> operator	"The <code>typeof</code> operator (IBM extension)" on page 178
<code>#assert</code> , <code>#unassert</code> preprocessor directives	"Assertion directives (IBM extension)" on page 503

Table 47. Default IBM XL C extensions for GNU C compatibility (continued)

Language feature	Discussed in:
#warning preprocessor directive	"The #warning directive (IBM extension)" on page 501
Alternate keywords	"Keywords for language extensions (IBM extension)" on page 16
asm labels	"Assembly labels (IBM extension)" on page 19
Cast to a union type	"Cast to union type (C only) (IBM extension)" on page 197
Complex literal suffixes	Complex literals
Computed goto statements	"Computed goto statement (IBM extension)" on page 237
Function attributes	"Function attributes (IBM extension)" on page 268
Generalized lvalues	"Lvalues and rvalues" on page 159
Global register variables	"Variables in specified registers (IBM extension)" on page 59
Initialization of static variables by compound literals	"Compound literal expressions" on page 206
Labels as values	"Labels as values (IBM extension)" on page 220
Linkage of inline functions	"Linkage of inline functions" on page 257
Locally declared labels	"Locally declared labels (IBM extension)" on page 220
Nested functions	"Nested functions (C only) (IBM extension)" on page 289
Placement of flexible array members anywhere in structure or union	Flexible array members
Postfix and unary operators on complex types (increment, decrement, and complex conjugation)	"Increment operator ++" on page 170, "Decrement operator --" on page 170, "Bitwise negation operator ~" on page 171
Statements and declarations in expressions (statement expressions)	"Statement expressions (IBM extension)" on page 223
Static initialization of flexible array members of aggregates	Flexible array members
Structures with flexible array members being members of another structure	Flexible array members
Type attributes	"Type attributes (IBM extension)" on page 104
Variable attributes	"Variable attributes (IBM extension)" on page 140
Variadic macro extensions	Variadic macro extensions(IBM extension)
Zero-extent arrays	Zero-extent array members (IBM extension)

The following features are enabled by default when you compile with any of the following commands:

- the `xlc` invocation command

- the `-qlanglvl=extc99` | `extc89` | `extc1x` | `extended` options

They are also enabled or disabled by specific compiler options, which are listed in the below table:

Table 48. IBM XL C extensions for GNU C compatibility with individual option controls





Language feature	Discussed in:	Individual option controls
asm, and <code>__asm</code> keywords	“Assembly labels (IBM extension)” on page 19, “Inline assembly statements (IBM extension)” on page 238, “Keywords for language extensions (IBM extension)” on page 16	<code>-q[no]keyword=asm</code> , <code>-qasm</code>
asm inline assembly-language statements	“Inline assembly statements (IBM extension)” on page 238	<code>-qasm</code>
typeof keyword	“The typeof operator (IBM extension)” on page 178, “Keywords for language extensions (IBM extension)” on page 16	<code>-q[no]keyword=typeof</code>
typeof operator	“The typeof operator (IBM extension)” on page 178	<code>-q[no]keyword=typeof</code>
Visibility function attribute	“visibility” on page 278	<code>-fvisibility (-qvisibility)</code>
Visibility variable attribute	“The visibility variable attribute” on page 144	<code>-fvisibility (-qvisibility)</code>
<p>Note: You can use the <code>-qvisibility</code> option to specify visibility attributes for variables and functions if they do not get visibility attributes from pragma directives, explicitly specified attributes, or propagation rules. This option cannot be used to disable visibility attributes for variables or functions.</p>		

The following features require compilation with the use of an additional option:

Table 49. IBM XL C extensions for GNU C compatibility, requiring additional compiler options

Language feature	Discussed in:	Required compilation option
<code>__thread</code> storage class specifier	“The <code>__thread</code> storage class specifier (IBM extension)” on page 60	<code>-qtls</code>
Dollar signs in identifiers	“Characters in identifiers” on page 18	<code>-qdollar</code>

Related reference:

-  See `-qkeyword` in the XL C/C++ Compiler Reference
-  See `-qasm` in the XL C/C++ Compiler Reference
-  See `-qtls` in the XL C/C++ Compiler Reference
-  See `-qdollar` in the XL C/C++ Compiler Reference
-  See Invoking the compiler in the XL C/C++ Compiler Reference

Extensions for Unicode support

The following feature requires compilation with the use of an additional option.

Table 50. IBM XL C extensions for unicode support

Language feature	Discussed in:	Required compilation option
UTF-16, UTF-32 literals	"UTF literals (IBM extension)" on page 42	-qutf

Extensions for vector processing support

The vector extensions are only accepted when all of the following conditions are met:

- The **-qarch** option is set to a target architecture that supports vector processing instructions. For example, an architecture that supports the VSX instruction set extensions, such as POWER7, requires **-qarch=power7**.
- The **-qaltivec** option is in effect.

For more information on these options, see the *XL C/C++ Compiler Reference*.

Table 51. IBM XL C extensions to support the AltiVec Application Programming Interface specification

Language feature	Discussed in:
Vector programming language extensions	"Vector types (IBM extension)" on page 66, "Vector literals (IBM extension)" on page 30

The following features are IBM extensions to the AltiVec Application Programming Interface specification:

Table 52. IBM XL C extensions to the AltiVec Application Programming Interface specification

Language extension	Discussed in:
Address operator & and Indirection operator * applied to vector types	"Address operator &" on page 172, "Indirection operator *" on page 173
bool, __pixel, pixel, __vector, and vector keywords	"Keywords for language extensions (IBM extension)" on page 16
Initialization of vectors	"Initialization of vectors (IBM extension)" on page 128
Pointer arithmetic for vector types	"Pointer arithmetic" on page 115
vector types as arguments to the __alignof__, typeof, sizeof, and vec_step	"The __alignof__ operator (IBM extension)" on page 175, "The typeof operator (IBM extension)" on page 178, "The sizeof operator" on page 176, "The vec_step operator (IBM extension)" on page 180
Vector type casts	Chapter 6, "Type conversions," on page 147
Vector subscripting operator []	"Vector subscripting operator [] (IBM extension)" on page 191

Chapter 20. The IBM XL C++ language extensions

The IBM XL C++ extensions include C++ features as extensions in the following categories:

- “General IBM extensions”
- “Extensions for C99 compatibility” on page 518
- “Extensions for C11 compatibility” on page 519
- “C++11 compatibility” on page 519
- “Extensions for GNU C compatibility” on page 521
- “Extensions for GNU C++ compatibility” on page 525
- “Extensions for Unicode support” on page 526
- “Extensions for vector processing support” on page 526

General IBM extensions

The following feature is enabled by default at all extended language levels:

Table 53. General IBM extensions

Language feature	Discussed in:
Allowed types in typedef definitions	“typedef definitions” on page 86

The following feature is disabled by default at all language levels. It also can be enabled or disabled by an individual option.

Table 54. General IBM extensions with individual option controls

Language feature	Discussed in:	Individual option controls
A non-const or volatile lvalue reference bound to an rvalue of a user-defined type	“Initialization of references (C++ only)” on page 135	-qlanglvl=[no]compatrvaluebinding
Extra text after #endif or #else	“Extension of #endif and #else (IBM extension)” on page 499	-qlanglvl=[no]textafterendif



The following feature is enabled with the **-qlanglvl=compat366 | extended** option. It can also be enabled or disabled by a specific compiler option, listed in the following table:

Table 55. General IBM extensions with individual option controls

Language feature	Discussed in:	Individual option controls
Non-C99 IBM long long extension	“Types of integer literals that are supported in pre-C99 and pre-C++11 modes” on page 22	-q[no]longlong

The following feature is enabled with the **-qlanglvl=extended0x** option. It can also be enabled or disabled by specific compiler options, listed in the following table:

Table 56. General IBM extensions with individual option controls

Language feature	Discussed in:	Individual option controls
C99 long long feature with the associated IBM extensions	Types of integer literals in C99 and C++11	 C++11 -q_lang_lv_l=[no]c99longlong  IBM -q_lang_lv_l=[no]extendedintegersafe

Related reference:

 See `-qlonglong` in the XL C/C++ Compiler Reference

Extensions for C99 compatibility

IBM XL C++ adds support for the following C99 language features. All of these features are enabled with the `-qlanglvl=extended` option, which is the default language level.

Table 57. Default C99 features as extensions to Standard C++

Language feature	Discussed in:
Additional predefined macro names	“Standard predefined macro names” on page 492
Duplicate type qualifiers	“Type qualifiers” on page 98
Flexible array members at the end of a structure or union	Flexible array members
C standard pragmas	“Standard pragmas” on page 505

The following features are enabled with the `-qlanglvl=extended` option, which is the default language level. They can also be enabled or disabled by specific compiler options, which are listed in the below table:

Table 58. Default C99 features as extensions to Standard C++, with individual option controls

Language feature	Discussed in:	Individual option controls
<code>_Complex</code> , <code>_Imaginary</code> , and <code>restrict</code> keywords	“Keywords for language extensions (IBM extension)” on page 16	-q[no]keyword=_Complex , -q[no]keyword=_Imaginary , -q[no]keyword=restrict
<code>__func__</code> predefined identifier	“The <code>__func__</code> predefined identifier” on page 19	-q_lang_lv_l=[no]c99__func__
Complex data type	“Complex floating-point types” on page 65	-q_lang_lv_l=[no]c99complex
Compound literals	“Compound literal expressions” on page 206	-q_lang_lv_l=[no]c99compoundliteral
Hexadecimal floating-point literals	Hexadecimal floating-point literals	-q_lang_lv_l=[no]c99hexfloat
<code>restrict</code> type qualifier	“The <code>restrict</code> type qualifier” on page 102	-q[no]keyword=restrict
Variable length arrays	“Variable length arrays” on page 122	-q_lang_lv_l=[no]c99vla

The following feature is only enabled by a specific compiler option, listed in the below table:

Table 59. C99 features as extensions to Standard C++, with individual option controls

Language feature	Discussed in:	Individual option control
Universal character names	"The Unicode standard" on page 41	-q1anglvl=ucs

Related reference:



See `-q1anglvl` in the XL C/C++ Compiler Reference



See `-qkeyword` in the XL C/C++ Compiler Reference

Extensions for C11 compatibility

Note: IBM supports selected features of C11, known as C1X before its ratification. IBM will continue to develop and implement the features of this standard. The implementation of the language level is based on IBM's interpretation of the standard. Until IBM's implementation of all the C11 features is complete, including the support of a new C11 standard library, the implementation may change from release to release. IBM makes no attempt to maintain compatibility, in source, binary, or listings and other compiler interfaces, with earlier releases of IBM's implementation of the C11 features.

IBM XL C++ adds support for the following C11 language feature. This feature can be enabled with the **-q1anglvl=extended** option, which is the default language level.

Table 60. IBM XL C++ language extensions for compatibility with C11

Language feature	Discussed in:
<code>_Noreturn</code> function specifier	"The <code>_Noreturn</code> function specifier" on page 260
Complex type initializations	"Initialization of complex types (C11)" on page 139
Static assertions	<code>_Static_assert</code> declaration
typedef redeclarations	"typedef definitions" on page 86

C++11 compatibility

Note: IBM supports selected features of C++11, known as C++0x before its ratification. IBM will continue to develop and implement the features of this standard. The implementation of the language level is based on IBM's interpretation of the standard. Until IBM's implementation of all the C++11 features is complete, including the support of a new C++11 standard library, the implementation might change from release to release. IBM makes no attempt to maintain compatibility, in source, binary, or listings and other compiler interfaces, with earlier releases of IBM's implementation of the new C++11 features.

The following features are part of a continual phased release process leading towards full compliance with C++11. They can be enabled by using the **-q1anglvl=extended0x** group option. You can also use specific compiler options to enable or disable these features. See the following table.

Table 61. Supported C++11 features

Language feature	Discussed in:	C++11 individual suboption control
Auto type deduction	“The auto type specifier (C++11)” on page 89	-q_{lang}lv1=[no]autotypededuction
C99 long long	“Types of integer literals that are supported in C99 and C++11” on page 23	-q_{lang}lv1=[no]c99longlong  -q_{lang}lv1=[no]extendedintegersafe
C99 preprocessor features adopted in C++11	“C99 preprocessor features adopted in C++11” on page 506	-q_{lang}lv1=[no]c99preprocessor
Decltype	“The <code>decltype(expression)</code> type specifier (C++11)” on page 90	-q_{lang}lv1=[no]decltype
Defaulted and deleted functions	“Explicitly defaulted functions” on page 249 “Deleted functions” on page 250	-q_{lang}lv1=[no]defaultanddelete
Delegating constructors	“Delegating constructors (C++11)” on page 387	-q_{lang}lv1=[no]delegatingctors
Explicit conversion operators	“Explicit conversion operators (C++11)” on page 405	-q_{lang}lv1=[no]explicitconversionoperators
Explicit instantiation declarations	“Explicit instantiation declaration” on page 434	-q_{lang}lv1=[no]externtemplate
Extended friend declarations	“Friends” on page 351	-q_{lang}lv1=[no]extendedfriend
Forward declaration of enumerations	“Enumerations” on page 79	N/A
Generalized constant expressions	“Generalized constant expressions (C++11)” on page 167	-q_{lang}lv1=[no]constexpr
Inline namespace definitions	“Inline namespace definitions (C++11)” on page 300	-q_{lang}lv1=[no]inlinenamespace
<code>nullptr</code>	“Null pointers” on page 118	-q_{lang}lv1=[no]nullptr
Reference collapsing	“Reference collapsing (C++11)” on page 216	-q_{lang}lv1=[no]referencecollapsing
Right angle brackets	“Class templates” on page 419	-q_{lang}lv1=[no]rightanglebracket
Rvalue references	Using rvalue references (C++11)	-q_{lang}lv1=[no]rvaluereferences
Scoped enumerations	“Enumerations” on page 79	-q_{lang}lv1=[no]scopedenum

Table 61. Supported C++11 features (continued)

Language feature	Discussed in:	C++11 individual suboption control
static_assert	“static_assert declaration (C++11)” on page 52	-qlanglvl=[no]static_assert
Trailing comma allowed in enum declarations	“Enumerations” on page 79	-qlanglvl=[no]trailenum
Trailing return type	“Trailing return type (C++11)” on page 266	-qlanglvl=[no]autotypededuction
Variadic templates	“Variadic templates (C++11)” on page 446	-qlanglvl=[no]variadic[templates]

Notes:

- You can also use the **-qlanglvl=extended** group option to enable the explicit instantiation declarations feature.
- If you try to use a C++11 feature when the feature is not enabled, the compiler issues an information message that follows a syntax error message. The information message indicates how to turn on the C++11 feature to recover from the syntax error. The involved C++11 features are listed as follows:
 - C99 preprocessor features adopted in C++11
 - Mixed string literal concatenation
 - The `__STDC_HOSTED__` macro
 - Defaulted and deleted functions
 - Delegating constructors
 - Explicit conversion operators
 - Generalized constant expressions
 - Inline namespace definitions
 - `nullptr`
 - Reference collapsing
 - Right angle brackets
 - Rvalue references
 - Scoped enumerations
 - Variadic templates

Related information in the XL C/C++ Compiler Reference

 `-qlanglvl`

Extensions for GNU C compatibility

The following subset of the GNU C language extensions is enabled with the **-qlanglvl=extended** option, which is the default language level.

Table 62. Default IBM XL C++ extensions for compatibility with GNU C

Language feature	Discussed in:
<code>__align</code> type qualifier	“The <code>__align</code> type qualifier (IBM extension)” on page 99
<code>__alignof__</code> operator	“The <code>__alignof__</code> operator (IBM extension)” on page 175

Table 62. Default IBM XL C++ extensions for compatibility with GNU C (continued)

Language feature	Discussed in:
<code>__imag__</code> and <code>__real__</code> complex type operators	"The <code>__real__</code> and <code>__imag__</code> operators (IBM extension)" on page 179
<code>__typeof__</code> operator	"The <code>typeof</code> operator (IBM extension)" on page 178
asm labels	"Assembly labels (IBM extension)" on page 19
Global register variables	"Variables in specified registers (IBM extension)" on page 59
Initialization of static variables by compound literals	"Compound literal expressions" on page 206
Placement of flexible array members anywhere in structure or union	Flexible array members
Postfix and unary operators on complex types (increment, decrement, and complex conjugation)	"Unary expressions" on page 169
Statements and declarations in expressions (statement expressions)	"Statement expressions (IBM extension)" on page 223
Static initialization of flexible array members of aggregates	Flexible array members
Structures with flexible array members being members of another structure	Flexible array members

The following subset of the GNU C language extensions is enabled with the **-q[no]lvl=extended** option, which is the default language level. These extensions can also be enabled or disabled by specific compiler options, which are listed in the below table:

Table 63. Default IBM XL C++ extensions for compatibility with GNU C, with individual option controls

Language feature	Discussed in:	Individual option controls
<code>__alignof</code> and <code>__alignof__</code> keywords	"The <code>__alignof__</code> operator (IBM extension)" on page 175, "Keywords for language extensions (IBM extension)" on page 16	-q[no]keyword=__alignof , -q[no]keyword=__alignof__
<code>__attribute</code> and <code>__attribute__</code> keywords	"Variable attributes (IBM extension)" on page 140, "Function attributes (IBM extension)" on page 268, "Keywords for language extensions (IBM extension)" on page 16	-q[no]keyword=__attribute , -q[no]keyword=__attribute__
<code>__complex__</code> keyword	"Keywords for language extensions (IBM extension)" on page 16	-q[no]keyword=__complex__
<code>__extension__</code> keyword	"Keywords for language extensions (IBM extension)" on page 16	-q[no]keyword=__extension__

Table 63. Default IBM XL C++ extensions for compatibility with GNU C, with individual option controls (continued)

Language feature	Discussed in:	Individual option controls
<code>__imag__</code> and <code>__real__</code> keywords	“The <code>__real__</code> and <code>__imag__</code> operators (IBM extension)” on page 179, “Keywords for language extensions (IBM extension)” on page 16	<code>-q[no]keyword=__imag__</code> , <code>-q[no]keyword=__real__</code>
<code>__label__</code> keyword	“Nested functions (C only) (IBM extension)” on page 289, “Locally declared labels (IBM extension)” on page 220, “Keywords for language extensions (IBM extension)” on page 16	<code>-q[no]keyword=__label__</code>
<code>__restrict</code> and <code>__restrict__</code> keywords	“The <code>restrict</code> type qualifier” on page 102, “Keywords for language extensions (IBM extension)” on page 16	<code>-q[no]keyword=__restrict</code> , <code>-q[no]keyword=__restrict__</code>
<code>#assert</code> , <code>#unassert</code> preprocessor directives	“Assertion directives (IBM extension)” on page 503	<code>-q[no]gnu_assert</code>
<code>#include_next</code> preprocessor directive	“The <code>#include_next</code> directive (IBM extension)” on page 495	<code>-q[no]gnu_include_next</code>
<code>#warning</code> preprocessor directive	“The <code>#warning</code> directive (IBM extension)” on page 501	<code>-q[no]gnu_warning</code>
Alternate keywords	“Keywords for language extensions (IBM extension)” on page 16	<code>-q[no]keyword=token</code>
<code>asm</code> , and <code>__asm</code> keywords	“Assembly labels (IBM extension)” on page 19, “Inline assembly statements (IBM extension)” on page 238, “Keywords for language extensions (IBM extension)” on page 16	<code>-q[no]keyword=asm</code> , <code>-qasm</code>
<code>asm inline</code> assembly-language statements	“Inline assembly statements (IBM extension)” on page 238	<code>-qasm</code>
Complex literal suffixes	Complex literals	<code>-q[no]gnu_suffixij</code>
Computed goto statements	“Computed goto statement (IBM extension)” on page 237	<code>-q[no]gnu_computedgoto</code>
Function attributes	“Function attributes (IBM extension)” on page 268	<code>-q[no]keyword=__attribute__</code>
Labels as values	“Labels as values (IBM extension)” on page 220	<code>-q[no]gnu_labelvalue</code>

Table 63. Default IBM XL C++ extensions for compatibility with GNU C, with individual option controls (continued)





Language feature	Discussed in:	Individual option controls
Locally declared labels	“Locally declared labels (IBM extension)” on page 220	-q[no]langlvl=[no]gnu_locallabel
typeof and __typeof__ keywords	“The typeof operator (IBM extension)” on page 178, “Keywords for language extensions (IBM extension)” on page 16	-q[no]keyword=__typeof, -q[no]keyword=__typeof__
typeof operator	“The typeof operator (IBM extension)” on page 178	-q[no]keyword=typeof
Type attributes	“Type attributes (IBM extension)” on page 104	-q[no]keyword=__attribute__
Variable attributes	“Variable attributes (IBM extension)” on page 140	-q[no]keyword=__attribute__
Variadic macro extensions	Variadic macro extensions(IBM extension)	-q[no]langlvl=[no]gnu_varargmacros
Visibility function attribute	“visibility” on page 278	-qvisibility
Visibility variable attribute	“The visibility variable attribute” on page 144	-qvisibility
Zero-extent arrays	Zero-extent array members (IBM extension)	-q[no]langlvl=[no]zeroextarray
<p>Note: You can use the -qvisibility option to specify visibility attributes for variables and functions if they do not get visibility attributes from pragma directives, explicitly specified attributes, or propagation rules. This option cannot be used to disable visibility attributes for variables or functions.</p>		

The following feature requires compilation with the use of an additional option, listed in the below table:

Table 64. IBM XL C++ extensions for GNU C compatibility, requiring additional compiler options

Language feature	Discussed in:	Required compilation option
Dollar signs in identifiers	“Characters in identifiers” on page 18	-qdollar

Related reference:

-  See **-qkeyword** in the XL C/C++ Compiler Reference
-  See **-qasm** in the XL C/C++ Compiler Reference
-  See **-qtls** in the XL C/C++ Compiler Reference
-  See **-qdollar** in the XL C/C++ Compiler Reference

Extensions for GNU C++ compatibility

The following GNU C++ language extension is enabled by default. It can also be enabled or disabled by the compiler options that is listed in the following table:

Table 65. IBM XL C++ language extensions for compatibility with GNU C++

Language feature	Discussed in:	Individual option control
<code>__decltype</code> keyword	“Keywords for language extensions (IBM extension)” on page 16	<code>-q[no]keyword=__decltype</code>

The following GNU C++ language extension is enabled with the `-qlanglvl=extended` option, which is the default language level. It can also be enabled or disabled by a specific compiler option, listed in the below table:

Table 66. IBM XL C++ language extensions for compatibility with GNU C++, with individual option controls

Language feature	Discussed in:	Individual option control
Template instantiations declared as extern	“Template instantiation” on page 433	<code>-qlanglvl=[no]gnu_externtemplate</code>
Visibility namespace attribute	“The visibility namespace attribute (IBM extension)” on page 303	<code>-qvisibility</code>
Visibility type attribute	“The visibility type attribute” on page 108	<code>-qvisibility</code>
Notes: <ul style="list-style-type: none"> • • The option <code>-qlanglvl=[no]gnu_externtemplate</code> is deprecated in XL C/C++ V13.1.2. You can use the option <code>-qlanglvl=[no]externtemplate</code> instead to control the explicit instantiation declaration feature which is introduced in the C++11 standard. For more information, see “Explicit instantiation declaration” in the <i>XL C/C++ Language Reference</i>. • You can use the <code>-qvisibility</code> option to specify visibility attributes for types and namespaces if they do not get visibility attributes from pragma directives, explicitly specified attributes, or propagation rules. This option cannot be used to disable visibility attributes for types or namespaces. 		

The following GNU C++ language extension requires compilation with a specific compiler option, listed in the below table:

Table 67. IBM XL C++ language extensions for compatibility with GNU C++, requiring additional options

Language feature	Discussed in:	Individual option control
<code>__thread</code> keyword	“The <code>__thread</code> storage class specifier (IBM extension)” on page 60, “Keywords for language extensions (IBM extension)” on page 16	<code>-qtls</code>

Table 67. IBM XL C++ language extensions for compatibility with GNU C++, requiring additional options (continued)

Language feature	Discussed in:	Individual option control
The <code>__thread</code> storage class specifier	"The <code>__thread</code> storage class specifier (IBM extension) " on page 60	-qtls

Related reference:

 See `-qlanglvl` in the XL C/C++ Compiler Reference

 See `-qtls` in the XL C/C++ Compiler Reference

Extensions for Unicode support

The following feature is enabled with the `-qlanglvl=extended` option, which is the default language level. It can also be enabled or disabled by a specific compiler option, which is listed in the below table:

Table 68. IBM XL C++ extensions for unicode support

Language feature	Discussed in:	Required compilation option
UTF-16, UTF-32 literals	"UTF literals (IBM extension)" on page 42	-qutf

Related reference:

 See `-qutf` in the XL C/C++ Compiler Reference

Extensions for vector processing support

The vector extensions are only accepted when all of the following conditions are met:

- The `-qarch` option is set to a target architecture that supports vector processing instructions. For example, an architecture that supports the VSX instruction set extensions, such as POWER7, requires `-qarch=pwr7`.
- The `-qaltivec` option is in effect.

For more information on these options, see the *XL C/C++ Compiler Reference*.

Table 69. IBM XL C++ extensions to support the AltiVec Application Programming Interface specification

Language feature	Discussed in:
Vector programming language extensions	"Vector types (IBM extension)" on page 66, "Vector literals (IBM extension)" on page 30

The following features are IBM extensions to the AltiVec Application Programming Interface specification:

Table 70. IBM XL C extensions to the AltiVec Application Programming Interface specification

Language extension	Discussed in:
Address operator <code>&</code> and Indirection operator <code>*</code> applied to vector types	"Address operator <code>&</code> " on page 172, "Indirection operator <code>*</code> " on page 173

Table 70. IBM XL C extensions to the AltiVec Application Programming Interface specification (continued)

Language extension	Discussed in:
<code>__pixel</code> , <code>pixel</code> , <code>__vector</code> , and <code>vector</code> keywords	"Keywords for language extensions (IBM extension)" on page 16
Initialization of vectors	"Initialization of vectors (IBM extension)" on page 128
Pointer arithmetic for vector types	"Pointer arithmetic" on page 115
vector types as arguments to the <code>__alignof__</code> , <code>typeof</code> , <code>sizeof</code> , and <code>vec_step</code>	"The <code>__alignof__</code> operator (IBM extension)" on page 175, "The <code>typeof</code> operator (IBM extension)" on page 178, "The <code>sizeof</code> operator" on page 176, "The <code>vec_step</code> operator (IBM extension)" on page 180
Vector type casts	Chapter 6, "Type conversions," on page 147
Vector subscripting operator <code>[]</code>	"Vector subscripting operator <code>[]</code> (IBM extension)" on page 191

Related information

- `-qarch`
- `-qaltivec`

Notices

Programming interfaces: Intended programming interfaces allow the customer to write programs to obtain the services of IBM XL C/C++ for AIX.

This information was developed for products and services offered in the U.S.A. IBM may not offer the products, services, or features discussed in this document in other countries. Consult your local IBM representative for information on the products and services currently available in your area. Any reference to an IBM product, program, or service is not intended to state or imply that only that IBM product, program, or service may be used. Any functionally equivalent product, program, or service that does not infringe any IBM intellectual property right may be used instead. However, it is the user's responsibility to evaluate and verify the operation of any non-IBM product, program, or service.

IBM may have patents or pending patent applications covering subject matter described in this document. The furnishing of this document does not give you any license to these patents. You can send license inquiries, in writing, to:

IBM Director of Licensing
IBM Corporation
North Castle Drive, MD-NC119
Armonk, NY 10504-1785
U.S.A.

For license inquiries regarding double-byte (DBCS) information, contact the IBM Intellectual Property Department in your country or send inquiries, in writing, to:

Intellectual Property Licensing
Legal and Intellectual Property Law
IBM Japan, Ltd.
19-21, Nihonbashi-Hakozakicho, Chuo-ku
Tokyo 103-8510, Japan

The following paragraph does not apply to the United Kingdom or any other country where such provisions are inconsistent with local law:

INTERNATIONAL BUSINESS MACHINES CORPORATION PROVIDES THIS PUBLICATION "AS IS" WITHOUT WARRANTY OF ANY KIND, EITHER EXPRESS OR IMPLIED, INCLUDING, BUT NOT LIMITED TO, THE IMPLIED WARRANTIES OF NON-INFRINGEMENT, MERCHANTABILITY OR FITNESS FOR A PARTICULAR PURPOSE. Some states do not allow disclaimer of express or implied warranties in certain transactions, therefore, this statement may not apply to you.

This information could include technical inaccuracies or typographical errors. Changes are periodically made to the information herein; these changes will be incorporated in new editions of the publication. IBM may make improvements and/or changes in the product(s) and/or the program(s) described in this publication at any time without notice.

Any references in this information to non-IBM websites are provided for convenience only and do not in any manner serve as an endorsement of those

websites. The materials at those websites are not part of the materials for this IBM product and use of those websites is at your own risk.

IBM may use or distribute any of the information you supply in any way it believes appropriate without incurring any obligation to you.

Licensees of this program who want to have information about it for the purpose of enabling: (i) the exchange of information between independently created programs and other programs (including this one) and (ii) the mutual use of the information which has been exchanged, should contact:

Intellectual Property Dept. for Rational Software
IBM Corporation
5 Technology Park Drive
Westford, MA 01886
U.S.A.

Such information may be available, subject to appropriate terms and conditions, including in some cases, payment of a fee.

The licensed program described in this document and all licensed material available for it are provided by IBM under terms of the IBM Customer Agreement, IBM International Program License Agreement or any equivalent agreement between us.

Any performance data contained herein was determined in a controlled environment. Therefore, the results obtained in other operating environments may vary significantly. Some measurements may have been made on development-level systems and there is no guarantee that these measurements will be the same on generally available systems. Furthermore, some measurements may have been estimated through extrapolation. Actual results may vary. Users of this document should verify the applicable data for their specific environment.

Information concerning non-IBM products was obtained from the suppliers of those products, their published announcements or other publicly available sources. IBM has not tested those products and cannot confirm the accuracy of performance, compatibility or any other claims related to non-IBM products. Questions on the capabilities of non-IBM products should be addressed to the suppliers of those products.

All statements regarding IBM's future direction or intent are subject to change or withdrawal without notice, and represent goals and objectives only.

This information contains examples of data and reports used in daily business operations. To illustrate them as completely as possible, the examples include the names of individuals, companies, brands, and products. All of these names are fictitious and any similarity to the names and addresses used by an actual business enterprise is entirely coincidental.

COPYRIGHT LICENSE:

This information contains sample application programs in source language, which illustrates programming techniques on various operating platforms. You may copy, modify, and distribute these sample programs in any form without payment to IBM, for the purposes of developing, using, marketing or distributing application programs conforming to the application programming interface for the operating

platform for which the sample programs are written. These examples have not been thoroughly tested under all conditions. IBM, therefore, cannot guarantee or imply reliability, serviceability, or function of these programs. The sample programs are provided "AS IS", without warranty of any kind. IBM shall not be liable for any damages arising out of your use of the sample programs.

Each copy or any portion of these sample programs or any derivative work, must include a copyright notice as follows:

© (your company name) (year). Portions of this code are derived from IBM Corp. Sample Programs. © Copyright IBM Corp. 1998, 2015.

PRIVACY POLICY CONSIDERATIONS:

IBM Software products, including software as a service solutions, ("Software Offerings") may use cookies or other technologies to collect product usage information, to help improve the end user experience, or to tailor interactions with the end user, or for other purposes. In many cases no personally identifiable information is collected by the Software Offerings. Some of our Software Offerings can help enable you to collect personally identifiable information. If this Software Offering uses cookies to collect personally identifiable information, specific information about this offering's use of cookies is set forth below.

This Software Offering does not use cookies or other technologies to collect personally identifiable information.

If the configurations deployed for this Software Offering provide you as customer the ability to collect personally identifiable information from end users via cookies and other technologies, you should seek your own legal advice about any laws applicable to such data collection, including any requirements for notice and consent.

For more information about the use of various technologies, including cookies, for these purposes, see IBM's Privacy Policy at <http://www.ibm.com/privacy> and IBM's Online Privacy Statement at <http://www.ibm.com/privacy/details> in the section entitled "Cookies, Web Beacons and Other Technologies," and the "IBM Software Products and Software-as-a-Service Privacy Statement" at <http://www.ibm.com/software/info/product-privacy>.

Trademarks

IBM, the IBM logo, and [ibm.com](http://www.ibm.com) are trademarks or registered trademarks of International Business Machines Corp., registered in many jurisdictions worldwide. Other product and service names might be trademarks of IBM or other companies. A current list of IBM trademarks is available on the web at "Copyright and trademark information" at <http://www.ibm.com/legal/copytrade.shtml>.

Adobe and the Adobe logo are either registered trademarks or trademarks of Adobe Systems Incorporated in the United States, other countries, or both.

Index

Special characters

`__align` 99
`__cdecl` 287
`__func__` 18
`__VA_ARGS__` 485
`_Noreturn`
 function specifier 260
 functions 260
`_Pragma` 505
`_thread` storage class specifier 60
- (subtraction operator) 184
- (unary minus operator) 171
-- (decrement operator) 170
-> (arrow operator) 169
, (comma operator) 192
:: (scope resolution operator) 166
! (logical negation operator) 171
!= (not equal to operator) 186
?: (conditional operators) 194
/ (division operator) 183
/= (compound assignment operator) 181
. (dot operator) 168
\$ 18, 38
* (indirection operator) 173
* (multiplication operator) 183
*= (compound assignment operator) 181
\
 continuation character 34, 485
 escape character 40
[] (array subscript operator) 190
[] (vector subscript operator) 191
% (remainder) 183
> (greater than operator) 185
>> (right-shift operator) 185
>>= (compound assignment operator) 181
>= (greater than or equal to operator) 185
< (less than operator) 185
<< (left-shift operator) 185
<<= (compound assignment operator) 181
<= (less than or equal to operator) 185
| (bitwise inclusive OR operator) 188
| (vertical bar), locale 38
|| (logical OR operator) 189
& (address operator) 172
& (bitwise AND operator) 187
& (reference declarator) 123
&& (label value operator) 212, 220
&& (logical AND operator) 189
&= (compound assignment operator) 181
preprocessor directive character 485
preprocessor operator 491
(macro concatenation) 492
+ (addition operator) 184
+ (unary plus operator) 171
++ (increment operator) 170
+= (compound assignment operator) 181

= (simple assignment operator) 181
== (equal to operator) 186
^ (bitwise exclusive OR operator) 188
^ (caret), locale 38
^= (compound assignment operator) 181
~ (bitwise negation operator) 171

A

aborting functions 480
abstract classes 377, 382
access rules
 base classes 365
 class types 325, 349
 friends 357
 members 349
 multiple access 372
 protected members 364
 virtual functions 382
access specifiers 335, 349, 361, 369
 in class derivations 365
accessibility 349, 372
addition operator (+) 184
address operator (&) 172
 GNU C extension 220
aggregate types 47, 391
 initialization 129, 391
alias 123
 function 18
 type-based aliasing 116
alias function attribute 270
alignment 141, 143
 bit fields 70
 structure members 70
 structures 141
 structures and unions 99
alignof operator 175
allocation
 expressions 207
 functions 284
always_inline function attribute 271
ambiguities
 base and derived member names 373
 base classes 370
 resolving 221, 373
 virtual function calls 380
AND operator, bitwise (&) 187
AND operator, logical (&&) 189
argc (argument count) 279
 example 279
arguments
 default 285
 evaluation 287
 macro 485
 main function 279
 of catch blocks 470
 passing 247, 280
 passing by pointer 282
 passing by reference 283
 passing by value 281

arguments (*continued*)
 trailing 485
argv (argument vector) 279
 example 279
arithmetic conversions 148
arithmetic types
 type compatibility 97
arrays
 array-to-pointer conversions 156
 as function parameter 55, 263
 declaration 55, 263, 336
 description 120
 flexible array member 70
 initialization 126
 initializing 133
 multidimensional 120
 subscripting operator 190
 type compatibility 123
 variable length 113, 122
 zero-extent 70
ASCII character codes 40
asm 15
 keyword 18, 58
 labels 18
 statements 238
assembly
 labels 18
 statements 238
assignment operator (=)
 compound 181
 pointers 117
 simple 181
associativity of operators 212
atexit function 480
auto storage class specifier 55

B

base classes
 abstract 382
 access rules 365
 ambiguities 370, 373
 direct 370
 indirect 359, 370
 initialization 392
 multiple access 372
 pointers to 361
 virtual 371, 373
base list 370
basic example, described xiii
best viable function 315
binary expressions and operators 180
binding 135
 direct 135
 dynamic 377
 static 377
 virtual functions 377
bit field
 integral promotion 153
bit fields 70
 as structure member 70

- bit fields (*continued*)
 - type name 178
- bitwise negation operator (~) 171
- block statement 222
- block visibility 6
- bool 66
- Boolean
 - conversions 148
 - data types 63
 - integral promotion 153
 - literals 25
- break statement 233
- built-in data types 47

C

- C++11
 - auto type deduction 89
 - C99 long long 21
 - C99 preprocessor features adopted in C++11
 - Diagnostic for header files and include names 506
 - Diagnostic for object-like macro definitions 506
 - Increased limit for #line directives 506
 - Mixed string literal concatenation 506
 - Preprocessor arithmetic with extended integer types 506
 - string literal concatenation 34
 - The `_Pragma` operator 506
 - Variadic macros and empty macro arguments 506
 - constexpr constructors 389
 - constexpr functions 289
 - decltype 90
 - delegating constructors 387
 - deleted functions 250
 - explicit conversion operators 405
 - explicit instantiation declarations 434
 - explicitly defaulted functions 249
 - extended friend declarations 351
 - generalized constant expressions 167
 - inline namespace definitions 300
 - reference collapsing 216
 - static assertion 52
 - the constexpr specifier 96
 - trailing return type 266
 - variadic templates 446
- C++11 compatibility 519
- C11
 - `_Static assertion` 51
- C11 compatibility 512
- candidate functions 305, 315
- case label 225
- cast expressions 30, 66, 196
 - union type 196
 - vector literal 30
- catch blocks 463, 465
 - argument matching 470
 - order of catching 471
- char type specifier 65
- character
 - data types 65
 - literals 33

- character (*continued*)
 - multibyte 34, 39
- character literals
 - multicharacter literal 33
 - narrow character literal 33
 - ordinary character literal 33
 - universal character name 33
 - wide character literal 33
- character set
 - extended 39
 - source 38
- class members
 - access operators 168
 - access rules 349
 - class member list 335
 - declaration 335
 - initialization 392
 - order of allocation 335
- class templates
 - declaration and definition 421
 - distinction from template class 419
 - member functions 422
 - static data members 422
- classes 328
 - abstract 382
 - access rules 349
 - aggregate 325
 - base 361
 - base list 361
 - class objects 47
 - class specifiers 325
 - class templates 419
 - constructors execution order 396
 - declarations 325
 - incomplete 330, 336
 - derived 361
 - friends 351
 - inheritance 359
 - keywords 325
 - local 332
 - member functions 337
 - member lists 335
 - member scope 339
 - nested 330, 355
 - overview 325
 - polymorphic 325
 - scope of names 329
 - static members 344
 - this pointer 341
 - using declaration 366
 - virtual 371, 377
- comma 192
 - in enumerator list 79
- comments 43
- compatibility
 - data types 47
 - user-defined types 85
 - XL C and GCC 512
 - XL C/C++ and GCC 1
 - XL C++ and C decimal-floating-point types 1
 - XL C++ and C11 519
 - XL C++ and C99 1, 518
 - XL C++ and GCC 521, 525
- compatible functions 252
- compatible types
 - across source files 85

- compatible types (*continued*)
 - arithmetic types 97
 - arrays 123
 - in conditional expressions 194
- complex literals 26
- complex types 64
 - initializing 139
- composite types 47
 - across source files 85
- compound
 - assignment 181
 - expression 181
 - literal 206
 - statement 222
 - types 47
- computed goto 212, 220, 236
- concatenation
 - macros 492
 - multibyte characters 34
 - u-literals, U-literals 41
- conditional compilation directives 496
 - elif preprocessor directive 497
 - else preprocessor directive 499
 - endif preprocessor directive 499
 - examples 500
 - if preprocessor directive 497
 - ifdef preprocessor directive 498
 - ifndef preprocessor directive 499
- conditional expression (? :) 181, 194
- const 66, 101
 - casting away constness 283
 - member functions 338
 - object 159
 - placement in type name 113
 - qualifier 98
 - vs. #define 485
- const function attribute 272
- const_cast 202, 283
- constant 21
- constant expressions 79, 162
- constant initializers 335
- constructors 386
 - constexpr constructors 389
 - converting 402, 403
 - copy 406
 - default constructors 387
 - exception handling 474
 - exception thrown in constructor 466
 - initialization
 - explicit 391
 - nontrivial 398
 - overview 385
 - trivial 398
 - user-provided 385
- continuation character 34, 485
- continue statement 233
- conversion
 - constructors 402
 - function 404
 - implicit conversion sequences 317
- conversion functions
 - explicit conversion operators 405
- conversion sequence
 - ellipsis 317
 - implicit 317
 - standard 317
 - user-defined 317

- conversions
 - arithmetic 148
 - array-to-pointer 156
 - Boolean 148
 - cast 196
 - complex to real 149
 - explicit keyword 403
 - function arguments 158
 - function-to-pointer 156
 - integral 148
 - lvalue-to-rvalue 155, 159, 317
 - pointer 156
 - pointer to derived class 373
 - pointer to member 340
 - references 158
 - standard 147
 - user-defined 401
 - void pointer 157
- copy assignment operators 408
- copy constructors 406
- covariant virtual functions 377
- CPLUSPLUS macro 492
- cv-qualifier 98, 111
 - in parameter type specification 306
 - syntax 98

D

- data declarations 47
- Data declarations 47
- data members
 - description 336
 - scope 339
 - static 345
- data objects 47
- Data objects 47
- data types
 - aggregates 47
 - Boolean 63
 - built-in 47
 - character 65
 - compatible 47
 - complex 64
 - composite 47
 - compound 47
 - enumerated 79
 - floating 64
 - incomplete 47
 - integral 62
 - scalar 47
 - user-defined 47, 69
 - vector 66
 - void 66
- DATE macro 492
- deallocation
 - expressions 211
 - functions 284
- decimal
 - floating constants 26
- decimal integer literals 21
- declaration 247, 438
- declarations
 - classes 325, 330
 - description 49
 - duplicate type qualifiers 98
 - friend specifier in member list 351
 - friends 357

- declarations (*continued*)
 - pointers to members 340
 - resolving ambiguous statements 221
 - syntax 49, 113, 247
 - unsubscripted arrays 120
 - vector types 66
- declarative region 6
- declarators 111
 - description 111
 - examples 113
 - reference 123
- decrement operator (--) 170
- default
 - clause 225
 - label 225
- default constructors 387
 - user-provided 385
- define preprocessor directive 485
- defined unary operator 497
- definitions
 - description 49
 - macro 485
 - member function 337
 - tentative 49
- delegating constructor 387
- delete operator 211
- dependent names 458
- dereferencing operator 173
- derivation 361
 - array type 120
 - public, protected, private 365
- derived classes
 - catch block 471
 - pointers to 361
- designated initializer
 - aggregate types 126
 - union 129
- designator 126
 - designation 126
 - designator list 126
 - union 129
- destructors 398
 - exception handling 474
 - exception thrown in destructor 466
 - overview 385
 - pseudo 400
 - user-provided 385
- digraph characters 42
- direct base class 370
- division operator (/) 183
- do statement 230
- dollar sign 18, 38
- dot operator 168
- double type specifier 64
- downcast 204
- dynamic binding 377
- dynamic_cast 204

E

- EBCDIC character codes 40
- elaborated type specifier 329
- elif preprocessor directive 497
- ellipsis
 - conversion sequence 317
 - in function declaration 263
 - in function definition 263

- ellipsis (*continued*)
 - in macro argument list 485
- else
 - preprocessor directive 499
 - statement 223
- enclosing class 337, 355
- endif preprocessor directive 499
- entry point
 - program 279
- enum
 - keyword 79
- enumerations 79
 - compatibility 85
 - declaration 79
 - initialization 131
 - trailing comma 79
- enumerator 79
- equal to operator (==) 186
- error preprocessor directive 501
- escape character \ 40
- escape sequence 40
 - alarm \a 40
 - backslash \\ 40
 - backspace \b 40
 - carriage return \r 40
 - double quotation mark \" 40
 - form feed \f 40
 - horizontal tab \t 40
 - new-line \n 40
 - question mark \? 40
 - single quotation mark \' 40
 - vertical tab \v 40
- examples
 - block 222
 - conditional expressions 195
 - inline assembly statements 242
 - scope C 8
- exception handling 463
 - argument matching 470
 - catch blocks 465
 - arguments 470
 - constructors 474
 - destructors 474
 - example, C++ 482
 - exception objects 463
 - function try blocks 463
 - handlers 463, 465
 - order of catching 471
 - rethrowing exceptions 472
 - set_terminate 481
 - set_unexpected 481
 - special functions 479
 - stack unwinding 474
 - terminate function 480
 - throw expressions 464, 472
 - try blocks 463
 - try exceptions 466
 - unexpected function 479
- exceptions
 - declaration 465
 - function try block handlers 466
 - specification 476
- exclusive OR operator, bitwise (^) 188
- explicit
 - instantiation, templates 434
 - keyword 402, 403
 - specializations, templates 438

- explicit (*continued*)
 - type conversions 196
- explicit instantiation
 - templates 434
- explicit specializations 438
- exponent 26
- expressions
 - allocation 207
 - assignment 181
 - binary 180
 - cast 196
 - comma 192
 - conditional 194
 - deallocation 211
 - description 159
 - generalized constant expressions 167
 - integer constant 162
 - new initializer 209
 - parenthesized 164
 - pointer to member 193
 - primary 161
 - resolving ambiguous statements 221
 - statement 221
 - throw 212, 472
 - unary 169
- extended friend declarations
 - friends 351
 - template parameters 414
 - typedef names 86
- extensions
 - IBM XL C language
 - C99 511
 - decimal floating-point support 511
 - GNU C 511
 - Unicode support 511
 - vector processing support 511
 - IBM XL C++ language
 - C++11 517
 - C99 517
 - decimal floating-point support 517
 - general 517
 - GNU C 517
 - GNU C++ 517
 - Unicode support 517
 - vector processing support 517
- extern storage class specifier 12, 13, 57, 254
 - with template declaration 433, 434
 - with variable length arrays 122

F

- file inclusion 494, 495
- FILE macro 492
- file scope data declarations
 - unsubscripted arrays 120
- flexible array member 70
- float type specifier 64
- floating point
 - constant 26
 - literals 26
 - promotion 153
- floating-point literals
 - complex 26
 - real 26

- floating-point types 64
- for statement 231
- format function attribute 272
- free store
 - delete operator 211
 - new operator 207
- friend
 - access rules 357
 - implicit conversion of pointers 365
 - member functions 337
 - nested classes 355
 - relationships with classes when templates are involved 423
 - scope 355
 - specifier 351
 - virtual functions 377
- function attribute
 - noinline 276
- function
 - aliases 18
 - definitions 248
- function attribute
 - always_inline 271
 - const 272
 - deprecated 272
 - format 272
 - format_arg 273
 - noreturn 276
 - pure 276
 - weak 277
- function attributes 268
 - alias 270
- function declarators 262
- function definitions 248
- function designator 159
- function specifier
 - explicit 402, 403
- function specifiers 255
- function templates
 - explicit specialization 438
- function try blocks 463
- handlers 466
- function-like macro 485
- functions 247
 - _Noreturn 260
 - allocation 284
 - arguments 247, 280
 - conversions 158
 - attributes 247
 - block 247
 - body 247
 - calling 280
 - calls
 - as lvalue 159
 - class templates 422
 - compatible 252
 - constexpr functions 289
 - conversion function 404
 - deallocation 284
 - declaration 247
 - C++ 338
 - examples 251
 - multiple 253
 - parameter names 263
 - default arguments 285
 - evaluation 287
 - restrictions 286

- functions (*continued*)
 - definition 247
 - examples 252
 - deleted functions 250
 - exception handling 479
 - exception specification 476
 - explicitly defaulted functions 249
 - friends 351
 - function call operator 247
 - function templates 424
 - function-to-pointer conversions 156
 - inline 256, 337
 - library functions 247
 - main 279
 - name 247
 - diagnostic 18
 - nested 289
 - nested functions 247
 - overloading 305
 - parameters 280
 - pointers to 287
 - polymorphic 359
 - predefined identifier 18
 - prototype 247
 - return statements 235
 - return type 247, 261, 262
 - return value 247, 262
 - signature 263
 - specifiable attributes 268
 - specifiers 256, 260
 - template function
 - template argument deduction 426
 - type name 113
 - virtual 338, 377, 380

G

- generic macro 165
- generic selection 165
- global register variables 58
- global variable 7, 12
 - uninitialized 125
- goto statement 236
 - computed goto 236
 - restrictions 236
- greater than operator (>) 185
- greater than or equal to operator (>=) 185

H

- handlers 465
- hexadecimal
 - floating constants 26
- hexadecimal integer literals 21
- hidden names 326, 329

I

- identifiers 18, 162
 - case sensitivity 18
 - id-expression 111, 163
 - labels 219
 - linkage 12
 - namespaces 9
 - predefined 18

- identifiers (*continued*)
 - reserved 15, 18
 - special characters 18, 38
 - truncation 18
- if
 - preprocessor directive 497
 - statement 223
- ifdef preprocessor directive 498
- ifndef preprocessor directive 499
- implicit conversion 147
 - Boolean 148
 - integral 148
 - lvalue 159
 - pointer to derived class 361, 365
 - pointers to base class 361
 - types 147
- implicit conversions
 - complex to real 149
- implicit instantiation
 - templates 437
- include preprocessor directive 494
- include_next preprocessor directive 495
- inclusive OR operator, bitwise (|) 188
- incomplete type 120
 - as structure member 70
 - class declaration 330
- incomplete types 47
- increment operator (++) 170
- indentation of code 485
- indirect base class 359, 370
- indirection operator (*) 66, 173
- information hiding 6, 335, 361
- inheritance
 - multiple 359, 370
 - overview 359
- initialization
 - aggregate types 129
 - auto object 125
 - base classes 392
 - class members 392
 - extern object 125
 - references 158
 - register object 125
 - static data members 345
 - static object 125, 206
 - union member 129
 - vector types 128
- initializer lists 124, 128, 206, 392
- initializers 124
 - aggregate types 126, 129
 - enumerations 131
 - unions 129
 - vector types 128
- inline
 - assembly statements 238
 - function specifier 256
 - functions 256, 337
- integer
 - constant expressions 79, 162
 - data types 62
 - literals 21
- integral
 - conversions 148
 - promotion 153

K

- keywords 15
 - description 18
 - exception handling 463
 - language extension 15
 - template 411, 459, 460
 - underscore characters 15

L

- label
 - as values 220
 - implicit declaration 7
 - in switch statement 225
 - locally declared 220
 - statement 219
- language extensions 1
 - IBM XL C
 - C99 511
 - decimal floating-point support 511
 - GNU C 511
 - Unicode support 511
 - vector processing support 511
 - IBM XL C++
 - C++11 517
 - C99 517
 - decimal floating-point support 517
 - general 517
 - GNU C 517
 - GNU C++ 517
 - Unicode support 517
 - vector processing support 517
- left-shift operator (<<) 185
- less than operator (<) 185
- less than or equal to operator (<=) 185
- lexical element 15
- LINE macro 492
- line preprocessor directive 502
- linkage 5
 - auto storage class specifier 55
 - const cv-qualifier 101
 - extern storage class specifier 13, 57
 - external 12
 - in function definition 254
 - inline member functions 337
 - internal 11, 55, 254
 - language 13
 - multiple function declarations 253
 - none 12
 - program 11
 - register storage class specifier 58
 - specifications 13
 - static storage class specifier 55
 - weak symbols 144
- linking to non-C++ programs 13
- literal constant 21
- literals 21, 162
 - Boolean 25
 - character 33
 - compound 206
 - floating point 26
 - integer 21
 - decimal 21
 - hexadecimal 21

literals (*continued*)

- integer (*continued*)
 - octal 21
 - Pointer 36
 - string 34
 - Unicode 41
 - vector 30
- local
 - classes 332
 - type names 333
- logical operators
 - ! (logical negation) 171
 - || (logical OR) 189
 - && (logical AND) 189
- long double type specifier 64
- long long
 - types of integer literals in C99 and C++11 21
 - types of integer literals outside of C99 and C++11 21
- long long type specifier 62, 66
- long type specifier 62, 66
- LONGNAME compiler option 18
- lvalues 98, 159, 162
 - casting 196
 - conversions 155, 159, 317

M

- macro
 - definition 485
 - typeof operator 178
 - function-like 485
 - invocation 485
 - object-like 485
 - variable argument 485
- main function 279
 - arguments 279
 - example 279
- member functions
 - const and volatile 338
 - definition 337
 - friend 337
 - special 338
 - static 347
 - this pointer 341, 380
- member lists 325, 335
- members
 - access 349
 - access control 369
 - class member access operators 168
 - data 336
 - pointers to 193, 340
 - protected 364
 - scope 339
 - static 330, 344
 - virtual functions 338
- modifiable lvalue 159, 181
- modulo operator (%) 183
- multibyte character 39
 - concatenation 34
- multicharacter literal 33
- multidimensional arrays 120
- multiple
 - access 372
 - inheritance 359, 370
- multiplication operator (*) 183

mutable storage class specifier 58

N

name binding 458
name hiding 10, 166
 accessible base class 373
 ambiguities 373
names
 conflicts 9
 hidden 166, 326, 329
 local type 333
 long name support 18
 mangling 13
 resolution 6, 366, 373
namespaces 293
 alias 293, 294
 associated namespace 300
 class names 329
 context 9
 declaring 293
 defining 293
 explicit access 299
 extending 294
 friends 297
 inline namespace definitions 300
 member definitions 297
 namespace scope object
 exception thrown in
 constructor 466
 of identifiers 9
 overloading 295
 unnamed 295
 user-defined 7
 using declaration 298
 using directive 298
narrow character literal 33
narrow string literal 34
nested classes
 friend scope 355
 scope 330
new operator
 default arguments 286
 description 207
 initializer expression 209
 placement syntax 208
 set_new_handler function 210
NOLONGNAME compiler option 18
non-delegating constructor 387
not equal to operator (!=) 186
null
 character '\0' 34
 pointer 132
 pointer constants 156
 preprocessor directive 504
 statement 237
number sign (#)
 preprocessor directive character 485
 preprocessor operator 491

O

object-like macro 485
objects 159
 class
 declarations 326

objects (*continued*)
 description 47
 lifetime 5
 namespace scope
 exception thrown in
 constructor 466
 restrict-qualified pointer 102
 static
 exception thrown in
 destructor 466
octal integer literals 21
one's complement operator (~) 171
operator functions 307
operators 37
 __real__ and __imag__ 179
 - (subtraction) 184
 - (unary minus) 171
 -- (decrement) 170
 -> (arrow) 169
 ->* (pointer to member) 193
 , (comma) 192
 :: (scope resolution) 166
 ! (logical negation) 171
 != (not equal to) 186
 ?: (conditional) 194
 / (division) 183
 . (dot) 168
 .* (pointer to member) 193
 () (function call) 167, 247
 * (indirection) 173
 * (multiplication) 183
 [] (array subscripting) 190
 [] (vector subscripting) 191
 % (remainder) 183
 > (greater than) 185
 >> (right-shift) 185
 >= (greater than or equal to) 185
 < (less than) 185
 << (left-shift) 185
 <= (less than or equal to) 185
 | (bitwise inclusive OR) 188
 || (logical OR) 189
 & (address) 172
 & (bitwise AND) 187
 && (logical AND) 189
 + (addition) 184
 ++ (increment) 170
 = (simple assignment) 181
 == (equal to) 186
 ^ (bitwise exclusive OR) 188
alternative representations 37
assignment 181
 copy assignment 408
associativity 212
binary 180
bitwise negation operator (~) 171
compound assignment 181
const_cast 202
defined 497
delete 211
dynamic_cast 204
equality 186
new 207
overloading 307, 337
 binary 311
 unary 309
pointer to member 193, 340

operators (*continued*)
 precedence 212
 examples 215
 type names 113
 preprocessor
 # 491
 ## 492
 pragma 505
 reinterpret_cast 200
 relational 185
 scope resolution 361, 373, 377
 sizeof 176
 static_cast 199
 typeid 174
 typeof 178
 unary 169
 unary plus operator (+) 171
OR operator, logical (||) 189
ordinary character literal 33
ordinary string literal 34
overload resolution 315, 373
 resolving addresses of overloaded
 functions 322
overloading
 description 305
 function templates 432
 functions 305, 367
 restrictions 306
 operators 307, 325
 assignment 312
 binary 311
 class member access 315
 decrement 310
 function call 313
 increment 310
 subscripting 314
 unary 309
overriding virtual functions 380
 covariant virtual function 377

P

packed
 structure member 70
 structures 85
 unions 85
 variable attribute 143
parameter packs
 function parameter packs 446
 template parameter packs 446
parenthesized expressions 113, 164
pass by pointer 282
pass by reference 123, 283
pass by value 281
pixel 66
placement syntax 208
Pointer
 literals 36
pointer to member
 conversions 340
 declarations 340
 operators 193, 340
pointers
 conversions 156, 373
 cv-qualified 114
 dereferencing 116
 description 114

- pointers (*continued*)
 - generic 157
 - null 132
 - null pointer constants
 - nullptr 118
 - pointer arithmetic 66, 115
 - restrict-qualified 102
 - this 341
 - to functions 287
 - to members 193, 340
 - type-qualified 114
 - vector types 66
 - void* 156
- polymorphism
 - polymorphic classes 325, 377
 - polymorphic functions 359
- postfix
 - ++ and -- 170
- pound sign (#)
 - preprocessor directive character 485
 - preprocessor operator 491
- pragma operator 505
- pragmas
 - _Pragma 505
 - preprocessor directive 504
 - standard 505
- precedence of operators 212
- predefined identifier 18
- predefined macros
 - CPLUSPLUS 492
 - DATE 492
 - FILE 492
 - LINE 492
 - STDC 492
 - STDC_HOSTED 492
 - STDC_VERSION 492
 - TIME 492
- prefix
 - ++ and -- 170
 - decimal floating constants 26
 - hexadecimal floating constants 26
 - hexadecimal integer literals 21
 - octal integer literals 21
- preprocessor directives 485
 - C99 preprocessor features adopted in C++11 506
 - conditional compilation 496
 - preprocessing overview 485
 - warning 501
- preprocessor operator
 - _Pragma 505
 - # 491
 - ## 492
- primary expressions 161
- principal constructor 387
- promotions
 - integral and floating-point 153
- pseudo-destructors 400
- punctuators 37
 - alternative representations 37
- pure specifier 335, 338, 377, 382
- pure virtual functions 382

Q

- qualified name 166, 330

- qualifiers
 - const 98
 - in parameter type specification 306
 - restrict 102
 - volatile 98, 103

R

- real literals
 - binary floating point 26
 - hexadecimal floating point 26
- reference collapsing 216
- references
 - as return types 262
 - binding 135
 - conversions 158
 - declarator 172
 - description 123
 - initialization 135
- register storage class specifier 58
- register variables 58
- reinterpret_cast 200
- remainder operator (%) 183
- restrict 102
 - in parameter type specification 306
- return statement 235, 262
- return type
 - reference as 262
 - size_t 176
- right-shift operator (>>) 185
- RTTI support 174, 204
- rvalues 159

S

- scalar types 47, 114
- scope 5
 - class 8
 - class names 329
 - description 6
 - enclosing and nested 6
 - friends 355
 - function 7
 - function prototype 7
 - global 7
 - global namespace 7
 - identifiers 9
 - local (block) 6
 - local classes 332
 - macro names 490
 - member 339
 - nested classes 330
- scope resolution operator
 - ambiguous base classes 373
 - description 166
 - inheritance 361
 - virtual functions 377
- sequence point 192
- set_new_handler function 210
- set_terminate function 481
- set_unexpected function 479, 481
- shift operators << and >> 185
- short type specifier 62
- side effect 103
- signed type specifiers
 - char 65

- signed type specifiers (*continued*)
 - int 62
 - long 62
 - long long 62
- size_t 176
- sizeof operator 176
 - with variable length arrays 122
- sizeof... operator 176
- special characters 38
- special member functions 338
- specifiers
 - _Noreturn 260
 - access control 365
 - constexpr 96
 - inline 256
 - pure 338
 - storage class 54
- splice preprocessor directive ## 492
- stack unwinding 474
- standard type conversions 147
- statement expression 223
- statements 219
 - block 222
 - break 233
 - compound 223
 - continue 233
 - do 230
 - expressions 221
 - for 231
 - goto 236
 - if 223
 - inline assembly
 - restrictions 242
 - iteration 229
 - jump 233
 - jump statements 233
 - labels 219
 - null 237
 - resolving ambiguities 221
 - return 235, 262
 - selection 223, 225
 - switch 225
 - while 229
- static 66
 - binding 377
 - data members 345
 - in array declaration 55, 263
 - initialization of data members 345
 - member functions 347
 - members 330, 344
 - storage class specifier 55, 254
 - linkage 55
 - with variable length arrays 122
- static storage class specifier 12
- static_cast 199
- STDC macro 492
- STDC_HOSTED macro 492
- STDC_VERSION macro 492
- storage class specifiers 54
 - _thread 60
 - auto 55
 - extern 57, 254
 - function 254
 - mutable 58
 - register 58
 - static 55, 254
 - tls_model attribute 60

- storage duration 5
 - auto storage class specifier 55
 - extern storage class specifier 57
 - register storage class specifier 58
 - static 55, 254
 - exception thrown in destructor 466
- string
 - literals 34
- string literals
 - narrow string literal 34
 - ordinary string literal 34
 - string concatenation 34
 - wide string literal 34
- stringize preprocessor directive # 491
- struct type specifier 70
- structures 70, 328
 - alignment 99
 - anonymous structures 70
 - as base class 365
 - as class type 325
 - compatibility 85
 - flexible array member 70
 - identifier (tag) 70
 - initialization 129
 - members 70
 - alignment 70
 - incomplete types 70
 - layout in memory 70, 129
 - packed 70
 - padding 70
 - zero-extent array 70
 - namespaces within 9
 - packed 70
 - unnamed members 129
- subscript declarator
 - in arrays 120
- subscripting operator 120, 190, 191
 - in type name 113
- subtraction operator (-) 184
- suffix
 - decimal floating constants 26
 - floating-point literals 26
 - hexadecimal floating constants 26
 - integer literal constants 21
- switch statement 225

T

- tags
 - enumeration 79
 - structure 70
 - union 70
- target constructor 387
- template
 - variadic templates 446
- template arguments 415
 - deduction 426
 - deduction, non-type 426
 - deduction, type 426
 - non-type 416
 - template 418
 - type 415
- template keyword 460
- templates 438
 - arguments
 - non-type 416

- templates (*continued*)
 - arguments (*continued*)
 - type 415
 - class
 - declaration and definition 421
 - distinction from template class 419
 - member functions 422
 - static data members 422
 - declaration 411
 - dependent names 458
 - explicit instantiation
 - explicit instantiation declarations 434
 - explicit instantiation definitions 434
 - explicit specializations 438
 - class members 438
 - definition and declaration 438
 - function templates 438
 - function
 - argument deduction 426
 - overloading 432
 - partial ordering 433
 - function templates 424
 - type template argument deduction 426
 - instantiation 411, 433, 438
 - explicit 434
 - forward declaration 433, 434
 - implicit 437
 - name binding 458
 - parameters 412
 - default arguments 413
 - friends 414
 - non-type 412
 - template 413
 - type 412
 - partial specialization 443
 - matching 443
 - parameter and argument lists 443
 - point of definition 458
 - point of instantiation 458
 - relationship between classes and their friends 423
 - scope 438
 - specialization 411, 433, 438
 - temporary objects 470
 - tentative definition 49
 - terminate function 463, 464, 471, 474, 479, 480
 - set_terminate 481
 - this pointer 341, 380
 - throw expressions 212, 463, 472
 - argument matching 470
 - rethrowing exceptions 472
 - within nested try blocks 464
 - TIME macro 492
 - tls_model attribute 143
 - tokens 15, 485
 - alternative representations for operators and punctuators 37
 - trailing return type 266
 - translation unit 5
 - trigraph sequences 43
 - truncation
 - integer division 183

- try blocks 463
 - nested 464
- try keyword 463
- type attributes 104
 - aligned 105
 - may_alias 106
 - packed 107
 - transparent_union 107
- type name 113
 - local 333
 - qualified 166, 330
 - typename keyword 459
 - typeof operator 178
- type qualifiers
 - const 98, 101
 - const and volatile 111
 - duplicate 98
 - in function parameters 306
 - restrict 98, 102
 - volatile 98
- type specifiers 61
 - _Bool 63
 - auto 89
 - auto type deduction 89
 - bool 63
 - char 65
 - class types 325
 - complex 64
 - decltype(*expression*) 90
 - double 64
 - elaborated 329
 - enumeration
 - scoped enumeration 79
 - unscoped enumeration 79
 - float 64
 - int 62
 - long 62
 - long double 64
 - long long 62
 - overriding 142
 - short 62
 - unsigned 62
 - vector data types 66
 - void 66
 - wchar_t 62, 65
- typedef names
 - friends 86
- typedef specifier 86
 - class declaration 333
 - local type names 333
 - pointers to members 340
 - qualified type name 330
 - with variable length arrays 122
- typeid operator 174
- typename keyword 459
- typeof operator 178
- types
 - class 325
 - conversions 196
 - type-based aliasing 116
 - variably modified 120

U

- u-literal, U-literal 41
- unary expressions 169
- unary operators 169

- unary operators (*continued*)
 - label value 212
 - minus (-) 171
 - plus (+) 171
- undef preprocessor directive 490
- underscore character 15, 18
 - in identifiers 18
- unexpected function 463, 479, 480
 - set_unexpected 481
- Unicode 41
- unions 70
 - as class type 325
 - cast to union type 196
 - compatibility 85
 - designated initializer 126
 - initialization 129
 - specifier 70
 - unnamed members 129
- universal character name 18, 33, 41
- unnamed namespaces 295
- unsigned type specifiers
 - char 65
 - int 62
 - long 62
 - long long 62
 - short 62
- unsubscripted arrays
 - description 120, 263
- user-defined conversions 401
- user-defined data types 47, 69
- user-provided 385
- using declarations 298, 366, 373
 - changing member access 369
 - overloading member functions 367
- using directive 298
- usual arithmetic conversions 151
- UTF-16, UTF-32 41

V

- variable
 - in specified registers 58
- variable attributes 140
- variable length array 47, 122, 236
 - as function parameter 122, 280, 315
 - sizeof 163
 - type name 113
- variably modified types 120, 122, 225
- variadic templates
 - pack expansion 446
 - parameter packs 446
 - partial specialization 446
 - template argument deduction 446
- vector
 - literals 30
 - subscripting operator 191
- vector data types 66
- vector literal
 - cast expressions 30
- vector processing support 1, 516, 526
- vector types 178
 - in typedef declarations 86
 - literals 30
- virtual
 - base classes 361, 371, 373
- virtual functions 338, 377
 - access 382

- virtual functions (*continued*)
 - ambiguous calls 380
 - overriding 380
 - pure specifier 382
- visibility 5, 10
 - block 6
 - class members 349
- visibility attributes
 - class 108
 - enumeration 108
 - function 278
 - namespace 303
 - structure 108
 - union 108
 - variable 144
- void 66
 - in function definition 261, 263
 - pointer 156, 157
- volatile
 - member functions 338
 - qualifier 98, 103

W

- warning preprocessor directive 501
- wchar_t
 - integral promotion 153
- wchar_t type specifier 33, 62, 65
- weak symbol 144
- while statement 229
- white space 15, 43, 485, 491
- wide character literal 33
- wide string literal 34

Z

- zero-extent array 70



Product Number: 5765-J07; 5725-C72

Printed in USA

SC27-4260-01

