

IBM Tivoli Storage Manager HSM for Windows
Version 7.1.2

Administration Guide



IBM Tivoli Storage Manager HSM for Windows
Version 7.1.2

Administration Guide



Note:

Before you use this information and the product it supports, read the information in “Notices” on page 127.

Third edition (April 2015)

This edition applies to version 7, release 1, modification 2 of IBM Tivoli Storage Manager HSM for Windows (product number 5608-E13), and to all subsequent releases and modifications until otherwise indicated in new editions.

© Copyright IBM Corporation 2005, 2015.

US Government Users Restricted Rights – Use, duplication or disclosure restricted by GSA ADP Schedule Contract with IBM Corp.

Contents

Tables	v
-------------------------	----------

About this publication	vii
---	------------

Who should read this publication	vii
Publications	vii
Conventions used in this manual	vii

New for Tivoli Storage Manager HSM for Windows client	ix
--	-----------

Chapter 1. HSM for Windows client overview	1
---	----------

Migration overview	3
Migration types	3
Recall modes	5
Stub files	6
Previously migrated files	7
Retention of migrated files in Tivoli Storage Manager storage	8
Reconciliation overview	8
Client commands and GUI overview	9

Chapter 2. Installation of the HSM for Windows client	11
--	-----------

Planning to install the HSM for Windows client	11
Hardware and software requirements	11
National language environments	11
Compatibility with other software	11
Restrictions for rolling back	13
Preparing for the installation	13
Distributing the installer to the network	13
Installing the HSM for Windows client from the product CD	14
Installing and configuring the HSM for Windows client in a cluster environment	14
HSM in cluster environments	15

Chapter 3. Upgrading the HSM for Windows client	17
--	-----------

Migrating Windows alternate data stream data for files that were migrated before Version 7.1.2	17
--	----

Chapter 4. Configuring the HSM for Windows client	19
--	-----------

Configuring the connection between the HSM for Windows client and the Tivoli Storage Manager server	19
Client password-character restrictions	22
Configuring the HSM client to connect to a secondary Tivoli Storage Manager server	23
Configuring the retention period of migration copies	24
Changing the retention period of migration copies	26

Configuring a new file space	28
Configuring regional settings	28
Excluding Windows alternate data stream names	28
HSM advanced parameters and preferences settings	29
File location preferences	30
Move Settings	30
File recall quotas	31
Recall service settings	35
Tracing preferences	35

Chapter 5. Managing space with HSM for Windows	37
---	-----------

Migration jobs	37
Creating migration jobs	38
Examples of including and excluding files	40
File groups	42
Calculating a migration job's space savings	43
Migration jobs start by a schedule, GUI, or CLI	44
Migration by file list	45
Threshold migration	46
Migration candidates	46
Migration triggers	47
Configuring threshold migration	48
Space management of the system volume	51
Selectively retrieving and recalling migrated files	52
Retrieving migrated files	52
Selectively recalling migrated files	53
Automatic backup before migration	54
Choosing a backup options file	55
Backup and restore of migrated files	55
Options for controlling backup of migrated files	57
Managing backup performance when stub file encryption changes	59
Backing up migrated files separately from resident files	60
Tivoli Storage Manager backup-archive client options for restoring migrated files	60
Reconciliation	62
Changed volume mount-paths	64
Configuring reconciliation with the graphical user interface	65
Space requirements for reconciliation	67
Moving migrated files	67
Migrated data is automatically moved when stub files are moved	68
Stub files in moving state	68
Moving stub files to another location	69
Continuing HSM services when a volume or file server is renamed	70
Mapping volumes	72

Chapter 6. HSM for Windows commands	73
--	-----------

Client return codes	74
<code>dsmclc.exe</code>	75

<code>dsmc1c createfilespace</code>	75
<code>dsmc1c defaults</code>	76
<code>dsmc1c delete</code>	77
<code>dsmc1c legend</code>	79
<code>dsmc1c list</code>	80
<code>dsmc1c listfilespace</code>	83
<code>dsmc1c listmgmtclasses</code>	85
<code>dsmc1c migrate</code>	86
<code>dsmc1c migratelist</code>	88
<code>dsmc1c recall</code>	90
<code>dsmc1c recalllist</code>	93
<code>dsmc1c register</code>	95
<code>dsmc1c retrieve</code>	97
<code>dsmfileinfo.exe</code>	100
<code>dsmfind.exe</code>	101
<code>dsmhsmc1c.exe</code>	103
Managing reconciliation with <code>dsmhsmc1c.exe</code>	103
Managing threshold migration with <code>dsmhsmc1c.exe</code>	108
<code>dsminfo.exe</code>	113
<code>dsmmove.exe</code>	114
<code>dsmquota.exe</code>	117
<code>dsmtool.exe</code>	119

Chapter 7. Troubleshooting the HSM for Windows client 121

Troubleshooting steps and information	121
Previewing files that would be deleted by a reconciliation process	122
Offline stub files are recalled when they are first synchronized	122
Problems with VSS during reconciliation	122
Small migrated files occupy much space on Tivoli Storage Manager server storage	123

Appendix. Accessibility features for the Tivoli Storage Manager product family. 125

Notices 127

Glossary 131

Index 133

Tables

1. Migration jobs compared to threshold migration	4
2. Advanced parameters descriptions	29
3. Tracing preferences: Trace levels.	36
4. Tracing preferences: Trace file size	36
5. Tracing preferences: Log file size settings	36
6. Example base file set	40
7. Interaction of options skipmigrated and checkreparsecontent during incremental backup	58
8. Results of using restoremigstate and restorecheckstubaccess options.	61
9. HSM for Windows client Command Prompt window commands.	73
10. An explanation of client return codes	74
11. Options for dsmfileinfo.exe	100
12. Options for dsminfo.exe	113

About this publication

This publication provides the information to install, configure, monitor, and troubleshoot problems with the IBM® Tivoli® Storage Manager HSM for Windows client.

Who should read this publication

This publication is intended for persons who are responsible for installing, configuring, monitoring, and troubleshooting the IBM Tivoli Storage Manager HSM for Windows client. In this publication, it is assumed that you have a working knowledge of the HSM for Windows client.

Publications

The Tivoli Storage Manager product family includes IBM Tivoli Storage FlashCopy® Manager, IBM Tivoli Storage Manager for Space Management, IBM Tivoli Storage Manager for Databases, and several other storage management products from IBM.

To view IBM product documentation, see www.ibm.com/support/knowledgecenter.

Conventions used in this manual

This manual uses the following typographical conventions:

Example	Description
cancel	Boldface type indicates a parameter or a user interface control.
<i>optionvalue</i>	Italic type indicates a placeholder for information you provide, or for special emphasis in the text.
user input	Monospace type indicates fragments of a program or information as it might appear on a display screen, such as a command example.
plus sign (+)	A plus sign between two keys indicates that you press both keys at the same time.

New for Tivoli Storage Manager HSM for Windows client

Tivoli Storage Manager HSM for Windows Version 7.1.2 is updated with new features, APAR fixes, and defect fixes.

The following features are new in V7.1.2:

Support for Windows alternate data streams

With the new feature for Windows alternate data streams (ADS), you can complete the following tasks:

- You can copy ADS data to Tivoli Storage Manager storage when the HSM for Windows client migrates a file.
- You can back up ADS data when the backup-archive client backs up a stub file.
- You can retrieve ADS data when a migrated file is retrieved by the HSM for Windows client and when a stub file is restored by the backup-archive client.

The new feature also includes these enhancements:

- ADS data is not recalled during a file recall operation.
- ADS data is not deleted from the stub file.

For information about adding support for Windows Alternate Data Stream (ADS) data when you upgrade from an HSM version before V7.1.2, see “Migrating Windows alternate data stream data for files that were migrated before Version 7.1.2” on page 17.

Chapter 1. HSM for Windows client overview

The IBM Tivoli Storage Manager HSM for Windows client provides hierarchical storage management (HSM) for Windows New Technology File System (NTFS) and Resilient File System (Re-FS) file systems.

The figure shows an overview of hierarchical storage management.

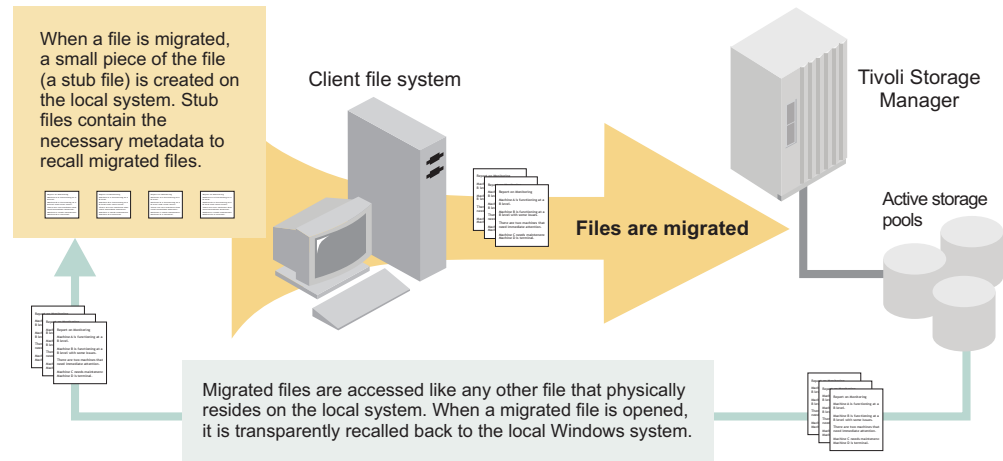

Figure 1. Overview of hierarchical storage management

HSM is a data storage system that automatically moves data between high-cost and low-cost storage media. HSM exists because high-speed storage devices, such as hard disk drives, are more expensive per byte stored than slower devices, such as magnetic tape drives. You can use HSM to store the bulk of your enterprise's data on slower devices, and then copy data to faster disk drives only when needed.

In effect, HSM turns the fast disk drives into caches for the slower mass storage devices. The HSM for Windows client monitors the way files are used and automates policies for migrating files to slower devices.

The HSM for Windows client manages the migration of individual files, files from parts of file systems, or complete file systems, to remote storage in Tivoli Storage Manager. Migrated files can be accessed, opened, and updated by the Windows application corresponding to the file extension.

In addition to the migration and recall of files and the reconciliation of file systems, the HSM for Windows client provides extra functions beyond the scope of traditional HSM:

- An administrator can define migration jobs for each volume. The job can include or exclude files of a certain file type (extension). Files can be included or excluded depending on file age or size. The files that are eligible for each migration job can be stored in separate file spaces in Tivoli Storage Manager storage.

- An administrator can define recall quotas to limit the number of file recalls during a specified time period. Quotas can apply to the entire system, to user groups, or to specific users.
- The HSM for Windows client can also be used for archiving purposes. In this case, files are migrated to Tivoli Storage Manager storage and the original files are either kept on disk or deleted.
- Search and retrieve options are available to the administrator for migrated files. Selected files or complete file spaces can be retrieved either to their original location in the file system or to a different location in the file system.
- When migrated files are recalled and changed by a user, several versions of a migrated file are kept in Tivoli Storage Manager storage until the file system is reconciled. A user recall always accesses the latest version of a file. However, an administrator can retrieve any available version of a file.
- Threshold migration monitors file-system space usage and migrates files when space is needed.
- Threshold migration migrates older and larger files from your file system. You configure whether file age or file size is a better qualifier for migration.
- You can move migrated data without interrupting HSM services.
You can move migrated files to accommodate the changing needs of users, applications, and hardware. For example, if a user moves to another site, you can move the migrated data. If a new or changed application requires that data is moved to another location, you can move the migrated files. You can maintain HSM services without recalling and migrating the files again.
- You can replace or rename a volume or file server and maintain HSM services without recalling and migrating the files again.

The following are some advantages beyond the classical HSM approach:

- The scope of individual migration jobs can be limited by the number of files and data volume.
- Individual jobs can be run at different times.
- Migration jobs can be organized according to the logical structure of a volume (including different parts of the directory structure). Jobs can reflect the structure of an organization or user groups.
- Migration jobs can be organized according to different types of files such as office documents, images, and text files. This organization provides a more logical view on data than traditional HSM.
- Threshold migration can automatically prevent your volumes from running out of free space.
- With threshold migration's age weighting, active files are kept on the volume. Less-active files are migrated to Tivoli Storage Manager storage.
- With threshold migration's size weighting, larger files are migrated to Tivoli Storage Manager storage. Larger files provide a more efficient migration.
- You can implement migration jobs and threshold migration on the same volume. You can build a policy that is based on both file values (migration jobs) and space usage (threshold migration).

The HSM for Windows client comes with a graphical user interface (HSM for Windows client GUI). You can use the HSM for Windows client GUI to define and run migration jobs, threshold migration, reconciliation, searches and file retrieval, and to define general settings. You can also do many of these tasks by using HSM for Windows client commands from a Command Prompt window.

The HSM for Windows client supports local, fixed NTFS and Re-FS file systems. Microsoft Cluster Server (MSCS) cluster volumes are supported, if they are formatted in NTFS or ReFS. Windows File Allocation Table (FAT) partitions, Common Internet File System (CIFS) shared folders, network-attached storage (NAS) drives, and other file systems are not supported.

Migration overview

A migration process copies files from a file system to Tivoli Storage Manager storage. The migrated copies are returned to the file system as required.

There are several ways to migrate files to Tivoli Storage Manager storage, and several ways to get the files back to the file system.

Related concepts:

“Migration jobs” on page 37

“Threshold migration” on page 46

Related tasks:

“Selectively retrieving and recalling migrated files” on page 52

Related reference:

“Automatic backup before migration” on page 54

Migration types

You can configure migration jobs and threshold migration. You can selectively migrate files that are specified in a list file.

Migration jobs and list migrations specify which files can be migrated, but they do not consider the space capacity of the volume. Threshold migration controls space usage of the volume, but allows less control of which files are migrated.

Migration jobs

A migration job defines a set of files and their migration behavior. When you run the job, the files that are specified in the job are copied to Tivoli Storage Manager storage.

A migration job can replace the original file with a stub file, delete the original file, or do nothing to the original file. You configure the action. You configure whether files are backed up before migration.

You can start the migration job immediately with the HSM for Windows client GUI or with an HSM for Windows client command from a Command Prompt window. You can also start the migration job later with a scheduling program acquired from another vendor.

List migrations

A list migration migrates the files that are listed in a text file. A list migration is not affected by disk-space usage or the age and size of files.

A list migration can replace the original file with a stub file, delete the original file, or do nothing to the original file. You configure the action. You configure whether files are backed up before migration.

Start a list migration with the HSM for Windows client **dsmc1c migratelist** command.

Threshold migration

Threshold migration provides migration that is based on space usage. When the used space on a volume reaches a high threshold, migration

begins automatically. Files are migrated to free up space until used space falls to a low threshold. The files that are migrated meet a minimum age and size, and are prioritized for migration. Less dynamic and larger files are migrated before more dynamic and smaller files. With proper configuration, threshold migration can automatically prevent the volume from running out of space.

Threshold migration replaces the original file with a stub file. You configure whether files are backed up before migration.

Configure threshold migration with the HSM for Windows client `dsmhsmc1c configurethresholdmig` command.

The following table summarizes the similarities and differences between migration jobs, list migrations, and threshold migration.

Table 1. Migration jobs compared to threshold migration. The table is a summary of differences and similarities between migration jobs, list migrations, and threshold migration.

Criterion	Migration job and list migration	Threshold migration
Which files are migrated?	<p>Migration job: You configure the path, type (file extension), minimum age, and minimum size of files to migrate. All files that meet the criteria are migrated.</p> <p>List migration: The files are identified in a list file.</p>	You configure the minimum file age and minimum file size, and the importance of file age relative to file size. HSM for Windows client creates a ranked list of migration candidates that are based on the criteria. Files from this list are migrated as needed to meet the space usage targets.
When does migration occur?	You start migration manually, or with a scheduling tool that is provided by another vendor.	HSM for Windows client automatically starts migration when it detects that space usage on the volume reaches the high threshold.
When does migration end?	<p>Migration job: Migration ends when all files that meet the criteria are migrated.</p> <p>List migration: Migration ends when all files in the list are migrated.</p>	Migration ends when space usage on the volume reaches the low threshold, or when there are no more candidates for migration.

Table 1. Migration jobs compared to threshold migration (continued). The table is a summary of differences and similarities between migration jobs, list migrations, and threshold migration.

Criterion	Migration job and list migration	Threshold migration
What remains on the volume from which the files were migrated?	HSM for Windows client can do one of three things, as you configure: Replace the original file with a stub file Leave the original file Delete the original file, create no stub file.	HSM for Windows client replaces the original file with a stub file.
When are files automatically recalled to the originating file system?	If the file system requests an operation that cannot be satisfied by the stub file, the migrated file is automatically and transparently recalled. The stub file provides the information to recall the file.	If the file system requests an operation that cannot be satisfied by the stub file, the migrated file is automatically and transparently recalled. The stub file provides the information to recall the file.
Can I selectively retrieve the migrated files?	Yes, by using the HSM for Windows client GUI or the dsmc1c retrieve command.	Yes, by using the HSM for Windows client GUI or the dsmc1c retrieve command.
Can I selectively recall the migrated files?	Yes, if a stub file exists on the file system. Use the dsmc1c recall command or the dsmc1c recalllist command.	Yes, if a stub file exists on the file system. Use the dsmc1c recall command or the dsmc1c recalllist command.

Related concepts:

“Migration jobs” on page 37

“Migration by file list” on page 45

“Threshold migration” on page 46

Recall modes

Migrated files can be recalled transparently, recalled selectively, and retrieved selectively.

A file is recalled automatically when you or a Windows application accesses the stub file. You can manually return a migrated file to the file system by using the information on the Tivoli Storage Manager server or the information in stub files.

Transparent recall

When you or a Windows application accesses a migrated file stub, the HSM for Windows client automatically recalls the file from Tivoli Storage Manager storage.

|
|
|
|
|

If only the Windows alternate data stream (ADS) data in a stub file is accessed or modified, the file is not recalled. When a file is recalled because the primary data stream (PDS) data is accessed in the stub file, the ADS data is not recalled. The ADS data is stored in the stub file on the file system and does not change when the PDS data is recalled.

Selective recall

You can selectively recall migrated files that were replaced with stubs

when they were migrated. You can search the file system for stub files that match a pattern. You can recall the migrated files that are listed in a text file. The files in the text file must be stub files. Security attributes and ADS data are not recalled with the file.

Selective retrieve

You can selectively retrieve migrated files by using information from the Tivoli Storage Manager server. You can specify whether security attributes and ADS data are retrieved with the file. When you retrieve migrated files, stub files are not required.

Related tasks:

“Selectively retrieving and recalling migrated files” on page 52

Stub files

A stub file is created on the file system from which a file is migrated. The stub file contains information for the HSM for Windows client to recall the original file to the file system.

A stub file contains the same recall information whether it was created by a migration job, a list migration, or a threshold migration.

When you or a Windows application accesses a migrated file stub, the HSM for Windows client automatically recalls the file from Tivoli Storage Manager storage. This automatic recall is called transparent recall.

Restriction: If only the Windows alternate data stream (ADS) data in a stub file is accessed or modified, the file is not recalled. When a file is recalled because the primary data stream (PDS) data is accessed in the stub file, the ADS data is not recalled. The ADS data is stored in the stub file on the file system and does not change when the PDS data is recalled.

A stub file looks and acts like a regular file on the file system, with a few exceptions:

- Files that are migrated are marked.
 - In the Windows Explorer, a migrated file has an overlay icon.
 - On a Command Prompt window, a migrated file is enclosed in brackets.
- Access to migrated files can be slower, if the file operation recalls the migrated file from Tivoli Storage Manager storage.

When a file is migrated, the last access time of the file does not change.

You can selectively recall a file from Tivoli Storage Manager storage if a stub file exists on the file system.

Related tasks:

“Selectively recalling migrated files” on page 53

Previously migrated files

After a file is migrated, it can be migrated again. Whether the file is migrated again depends on how the file was last migrated and how the file is changed.

When a file is recalled, modified, and migrated again, that new version of the file is stored in Tivoli Storage Manager storage. More than one version of the file exists in Tivoli Storage Manager storage until the file system is reconciled. Any file operation that requires the file to be recalled yields the most recently migrated version.

If a file was migrated and replaced with a stub, the subsequent migration of the file depends on how the file changes and the type of migration. A threshold migration does not migrate a stub. For migration types other than threshold migration, the subsequent migration of the stub file depends on how the file changes.

The file content changes

When you change the content of a file, the HSM for Windows client recalls the file from Tivoli Storage Manager storage. The next time that the file is the object of a migration job or a threshold migration, the new version of the file is migrated. The Tivoli Storage Manager server maintains versions of the migrated file until you run reconciliation. The migrated file is bound to the management class that is specified by the last migration job or threshold migration.

Only the file attributes or times (creation time or last modification time) change

When only file attributes or times (creation time or last modification time) change, the file is not migrated again to Tivoli Storage Manager storage. Instead, the attributes or file times are updated in the Tivoli Storage Manager metadata database the next time. The updates are made the next time that the file is the object of a migration job. The management class does not change, even if the migration job specifies a different management class.

Only the file security attributes change

The second migration of the file depends on whether you configured migration of file security attributes.

If you configured migration of file security attributes:

If only the ACL changes, the file is migrated the next time that the file is the object of a migration job or list migration. At the next job or list migration, the file is temporarily recalled, then migrated with the updated ACL. The version number of the file that is tracked by Tivoli Storage Manager does not change. The previous copy of the file in Tivoli Storage Manager storage is deleted. The migrated file is bound to the management class that is specified by the last migration job or threshold migration. If the file is targeted by a threshold migration, the file is not migrated again.

If you configured no migration of file security attributes:

If only the ACL changes, the file is not migrated the next time that the file is the object of a migration job or list migration.

Only the Windows alternate data stream (ADS) data changes

The second migration of the file depends on whether you configured migration of ADS data.

If you configured migration of ADS data:

If only the ADS data changes, the file is migrated the next time

that the file is the object of a migration job or list migration. At the next job or list migration, the file is temporarily recalled, then migrated with the updated ADS data. The version number of the file that is tracked by Tivoli Storage Manager does not change. The previous copy of the file in Tivoli Storage Manager storage is deleted. The migrated file is bound to the management class that is specified by the last migration job or threshold migration. If the file is targeted by a threshold migration, the file is not migrated again.

If you configured no migration of ADS data:

If only the ADS data changes, the file is not migrated the next time that the file is the object of a migration job or list migration.

No changes

Even if a migrated file did not change in any way, it can be migrated again. For example, you can migrate a file; recall the file; and not change the file. When you migrate the file again, the HSM for Windows client replaces the existing file with a stub that points to the existing file copy in Tivoli Storage Manager storage. The management class does not change, even if the migration job specifies a different management class.

You can configure migration with the keep option. The file is migrated to Tivoli Storage Manager storage, but the file is not replaced by a stub file. When you change the file, the HSM for Windows client does not automatically recall the file. The HSM for Windows client does not automatically track the changes to the file on the Tivoli Storage Manager server. The file remains unchanged on Tivoli Storage Manager storage. If you migrate the file again, the file is bound to the management class that is specified by the last migration job or list migration.

Related tasks:

“Retrieving migrated files” on page 52

Retention of migrated files in Tivoli Storage Manager storage

A migrated file is stored in Tivoli Storage Manager storage and managed as an archive copy group.

Attention: The default setting for management classes deletes migrated files from Tivoli Storage Manager storage after 365 days. The files are deleted from storage whether the original file is replaced with a stub, is deleted, or remains on the file system. To store files longer than 365 days, specify a management class that is suitable for retaining the migration copies. Or change the retention period of the default management class. See “Configuring the retention period of migration copies” on page 24.

Reconciliation overview

Reconciliation is the process of synchronizing a file system with the Tivoli Storage Manager server. After the reconciliation cycle completes, exactly one migrated object exists on the Tivoli Storage Manager server for each migrated file.

By removing obsolete objects from Tivoli Storage Manager server storage, reconciliation helps you to reduce your storage and license expenses. Reconciliation also checks that there is a migrated object on the Tivoli Storage Manager server for every stub file on the volume.

The HSM for Windows client reconciles automatically at intervals that are specified with the **reconcileinterval** option you define with the HSM for Windows client GUI or with the **dsmhsmc1c.exe** command. An administrative user can also start reconciliation manually at any time.

Related tasks:

“Configuring reconciliation with the graphical user interface” on page 65

Client commands and GUI overview

After you install and register the HSM for Windows client, you can use the HSM for Windows client GUI (graphical user interface) or run commands from a Command Prompt window.

Start the GUI with the `dsmgui.exe` executable file in the installation directory. After the GUI is started, you can configure, monitor, and administer space management with the controls in the GUI. You can complete all HSM operations with the GUI, but not all operations are supported by the commands.

You must start the HSM for Windows client GUI with administrative rights on the file server on which it is administered. Each file server on which the HSM for Windows client is installed must be administered locally.

Many operations that you complete with the HSM for Windows client GUI, you can also complete with commands from a Command Prompt window. Each command has its own executable file, also in the installation directory.

Related concepts:

Chapter 6, “HSM for Windows commands,” on page 73

Chapter 2. Installation of the HSM for Windows client

The HSM for Windows client uses the Tivoli Storage Manager API, which is installed when you install the Tivoli Storage Manager backup-archive client. Install, configure, and register the Tivoli Storage Manager backup-archive client before you install, configure, and use the HSM for Windows client.

Related information:

Chapter 4, "Configuring the HSM for Windows client," on page 19

Planning to install the HSM for Windows client

Plan the necessary hardware and software, and consider compatibility with other software.

Hardware and software requirements

HSM for Windows client has hardware requirements and software requirements.

For current software and hardware requirements, see "Hardware and software requirements for IBM Tivoli Storage Manager (TSM) HSM for Windows" at <http://www.ibm.com/support/docview.wss?uid=swg21319299> .

National language environments

When you install or uninstall the HSM for Windows client, all languages are installed or uninstalled at the same time. You cannot install the HSM for Windows client to a path that contains national language characters.

Compatibility with other software

There are restrictions with file names length and cluster support.

File name limitations

The length of file names is limited by Tivoli Storage Manager API, and by Windows Explorer when using the HSM for Windows client GUI.

The length of a file name that is migrated by the HSM for Windows client cannot exceed 256 bytes. The path length (the API high-level qualifier) cannot exceed 1024 bytes. A path and file name includes the file server name, the volume, and the directory portion of the full Uniform Naming Convention (UNC) name, for example \\FILESERVER\E:\directory\filename.ext. The Unicode representation of a character can occupy several bytes, so the maximum number of characters that a file name might contain can vary.

When using the HSM for Windows client GUI, path names can be a maximum of 254 characters only. For path names that exceed 254 characters, you must use the **dsmc1c.exe** command from a Command Prompt window.

Cluster environment limitations

There are configuration limitations for the HSM for Windows client in a cluster environment. Migration jobs must be started again manually when a cluster node fails.

The HSM for Windows client supports the following cluster environments:

- A Microsoft cluster (MSCS) environment with the following configurations:
 - Local volumes that are mounted into local volumes
 - Cluster volumes that are mounted into cluster volumes

Note: In these configurations, both cluster volumes belong to the same cluster resource to guarantee that both are always online on the same cluster node.

You cannot use the following configurations because in these configurations HSM for Windows client cannot recall migrated files after failover:

- Cluster volumes that are mounted into local volumes
- Local volumes that are mounted into cluster volumes

When a migration job is running and the cluster node fails, the job is interrupted. You must restart the migration job manually on the next node. When you start the job on the next node, the job continues from the point when the node failed.

Tip: Create a similar job or migration list on the next node in the cluster.

Extended attributes limitations

Extended attributes are not migrated.

Due to a restriction of the NTFS file systems, extended attributes and reparse points are mutually exclusive. Because the HSM for Windows client uses reparse points, files with extended attributes cannot be migrated.

Antivirus software

Although in-depth testing occurs with each HSM for Windows client release in regards to industry leading antivirus programs, there are a several caveats.

Note:

- Be sure a virus scan runs on files before they are migrated.
- Updates of virus signatures and antivirus scan engines can lead to different behavior with the HSM for Windows client. During any troubleshooting, always ask the question "What changed?" and take special consideration of antivirus updates.
- Use antivirus software that supports sparse or offline files. Be sure it has a setting that allows it to skip offline or sparse files to avoid unnecessary recall of migrated files.
- The HSM for Windows client has been successfully tested for compatibility with the following programs with the specified settings:
 - McAfee VirusScan Enterprise 7.0 and 8.0
 - Symantec AntiVirus 8.0 and 9.0 Corporate Edition with the following setting:
 - Under **Scan Advanced Options > Storage migration options**, check **Skip offline and sparse files**.
 - Symantec AntiVirus 10.0 Corporate Edition with the following two settings:
 - Under **Scan Advanced Options > Storage migration options**, check **Skip offline files**.

- Under **Autoprotect Advanced Options > Scan files when**, clear **Opened for backup**.

Restrictions for rolling back

Files that are migrated with one version of the HSM for Windows client might not be compatible with other versions of the HSM for Windows client.

Stub files that are created with V7.1 and later are not compatible with V6.4.0.x and V.6.3.x. The V6.3.x and V6.4.0.x HSM for Windows client cannot recall files from stubs that are created with V7.1. The V7.1 HSM for Windows client can recall files from stubs that are created with earlier versions.

Stub files that are created with V7.1.2 and later are not compatible with earlier versions. Earlier versions of the HSM for Windows client cannot recall files from stubs that are created with V7.1.2. The V7.1.2 HSM for Windows client can recall files from stubs that are created with earlier versions.

Preparing for the installation

You can prepare for installation by distributing the installer to the network.

Distributing the installer to the network

You can distribute the HSM for Windows client installer to a shared drive. Users on the network can then install HSM for Windows client from the shared drive.

About this task

Use the following steps to distribute the HSM for Windows client installer to a shared drive on the network:

Procedure

1. Insert the product CD into a CD drive.
2. Open a Command Prompt window.
3. Change to the directory of the CD drive.
4. Type `msiexec /a "IBM Tivoli Storage Manager HSM for Windows client.msi"` and press **Enter**.
5. Step through the user interface dialogs by typing the necessary information. The file `IBM Tivoli Storage Manager HSM for Windows client.msi` is copied to the assigned network drive.

What to do next

Users on the network can install HSM for Windows client using the `IBM Tivoli Storage Manager HSM for Windows client.msi` executable file from the shared drive.

Installing the HSM for Windows client from the product CD

You can install the HSM for Windows client from the product CD by clicking the setup icon.

About this task

Use the following steps to install the HSM for Windows client from the product CD:

Procedure

1. Insert the product CD into a CD-ROM drive.
2. Open Windows Explorer.
3. Change to the *cd-drive*:\ location, where *cd-drive* is the drive letter of the reader where you placed the installation CD.
4. Double-click the setup.exe file.

What to do next

You must restart the system to load the file system filter driver and complete the installation. Do not configure the HSM for Windows client until after you restart the system.

Related information:

Chapter 4, “Configuring the HSM for Windows client,” on page 19

Installing and configuring the HSM for Windows client in a cluster environment

You can install the HSM for Windows client on a Microsoft cluster server (MSCS). With appropriate configuration, the HSM for Windows client can manage migration during failover and failback processing.

Before you begin

You must install, configure, and register the Tivoli Storage Manager backup-archive client before you configure and use the HSM for Windows client.

You must register the cluster node name with the Tivoli Storage Manager server as a client node.

About this task

Start the HSM for Windows client graphical user interface (GUI) by entering the **dsmgui.exe** command in the HSM for Windows client installation directory.

Procedure

1. Install the Tivoli Storage Manager backup-archive client and the HSM for Windows client on a local drive on each cluster node.
2. Specify the **clusternode** option in the **dsm.opt** client options file of each backup-archive client. Example code in a **dsm.opt** client options file:

```
...
TCPPORT 1500
PASSWORDACCESS GENERATE
NODENAME WS2008R2CLUSTER
CLUSTERNODE YES
...
```

3. Run the HSM for Windows client configuration wizard to configure an HSM client.
 - a. When the Cluster Configuration window opens, copy the Tivoli Storage Manager server administrative command `grant proxynode target=targetname agent=agentname` from the Cluster Configuration window.
 - b. Run the command on the Tivoli Storage Manager server console, operations center command prompt, or administrative client command prompt.
4. Repeat step 3 on each cluster node.

Related concepts:

“HSM in cluster environments”

Related tasks:

“Configuring the connection between the HSM for Windows client and the Tivoli Storage Manager server” on page 19

HSM in cluster environments

Installation, configuration, and use of the HSM for Windows client in a cluster environment requires special considerations.

The HSM for Windows client manages threshold migration and reconciliation during failover and failback.

A migration job that is running when a node fails must be manually started on another node of the cluster. When the job is started on another node, files that were processed before the node failed are not processed again. Only the remaining files are migrated. You can configure the same or similar jobs on several nodes of a cluster.

The HSM for Windows client must be installed on each cluster node on which files are migrated and recalled. For example, assume that you have a three node cluster. You plan to migrate data from one cluster volume. If this cluster volume is available on only node1 and node2, you need to install the HSM for Windows client on only node1 and node2. If the volume can fail over to node3, you must install the HSM for Windows client on node3, too.

Each HSM for Windows client uses its own node name to authenticate with the Tivoli Storage Manager server. By default, the Tivoli Storage Manager node name for the computer is the computer host name. But you can change that name when you run the initial configuration wizard. To access the data from the cluster volumes on all nodes, the data is stored on the Tivoli Storage Manager server under a common node name. This common node name must be the cluster name. You must grant access for each node to the common cluster node name by using the **grant proxynode** command. The configuration wizard shows you the appropriate command to be run on the Tivoli Storage Manager server.

Each HSM for Windows client has its own set of configuration data. The configuration data and the migration jobs and log files are stored by default in subdirectories of the installation directory. You can configure the directory that

contains the jobs file to a common directory that is accessible by other HSM for Windows client nodes in the cluster. Do not configure a common directory for the logs and list files or for the configuration file directory and temporary files directory.

The HSM for Windows client must be installed on each cluster node to a local drive, like the system drive. The HSM executable files must be available at any time. Do not install the HSM for Windows client on a cluster drive.

If you want to use the Tivoli Storage Manager backup-archive client, it must be installed, configured, and registered appropriately for an MSCS cluster environment. If you want files to be backed up before migration, the options file must specify the **clusternode=yes** option. For example, assume that your cluster volume is E and your backup-archive client scheduler is configured to run the daily backup with the option file E:\TIVOLI-TSM\dsm_cluster_E.opt. Select E:\TIVOLI-TSM\dsm_cluster_E.opt as the options file for the backup before migration.

Important: HSM for Windows client stores the cluster name as file recall information in stub files. If you change the cluster name, you must apply the appropriate hardware volume mappings before you continue.

If you remove a volume from a cluster and reconfigure it as a local volume on one node, you must use hardware volume mappings to link the local volume to the old cluster volume name.

When you install the HSM for Windows client on a cluster system, the HSM services require the cluster services. If the cluster services are not running, the HSM services do not start. After you restart the system, the HSM services attempt to start automatically two times. If the cluster services are not running at the second automatic attempt, you must start the HSM services manually.

If you change a cluster name, only the HSM for Windows client GUI starts. Use the GUI to map the new cluster name to the old cluster name. When you confirm the mapping that is created by using the wizard, the HSM for Windows client creates hardware mappings from the new cluster name to the old cluster name. The mappings are replicated over the Tivoli Storage Manager server to other cluster nodes where the HSM for Windows client is installed.

Related concepts:

“File location preferences” on page 30

“Stub files” on page 6

 [Configuring the backup-archive client in a cluster server environment \(http://www.ibm.com/support/knowledgecenter/SSGSG7_7.1.2/com.ibm.itsm.client.doc/c_cfg_clus_windows.html\)](http://www.ibm.com/support/knowledgecenter/SSGSG7_7.1.2/com.ibm.itsm.client.doc/c_cfg_clus_windows.html)

 [Server: Defining agent and target nodes \(https://www.ibm.com/support/knowledgecenter/SSGSG7_7.1.1/com.ibm.itsm.srv.doc/c_mgclinod_defagntgrtnodes.html\)](https://www.ibm.com/support/knowledgecenter/SSGSG7_7.1.1/com.ibm.itsm.srv.doc/c_mgclinod_defagntgrtnodes.html)

Related tasks:

 [Configuring backup-archive clients \(http://www.ibm.com/support/knowledgecenter/SSGSG7_7.1.2/com.ibm.itsm.client.doc/t_cfg_bac.html\)](http://www.ibm.com/support/knowledgecenter/SSGSG7_7.1.2/com.ibm.itsm.client.doc/t_cfg_bac.html)

Chapter 3. Upgrading the HSM for Windows client

Upgrading from an earlier version might require that you complete an upgrade task.

Migrating Windows alternate data stream data for files that were migrated before Version 7.1.2

To use the Tivoli Storage Manager HSM for Windows alternate data streams (ADS) feature on all migrated files, you must migrate all files with the V7.1.2 or later client. Files that contain ADS data and were migrated with an earlier version client must be migrated again with the V7.1.2 or later client.

About this task

With the HSM for Windows ADS feature, you can migrate and retrieve Windows ADS data. ADS data in a stub is backed up and can be restored by the backup-archive client.

If you migrated files that contain ADS data with an earlier version client, the migration copy does not contain ADS data. If the stub was backed up, the stub does not contain ADS data. ADS data is not fully protected in these files. If you want full ADS protection, you must migrate the files that contain ADS data again.

Procedure

1. Plan enough space resources and time to rerun all migration jobs.
2. When HSM for Windows V7.1.2 or later is installed, rerun all migration jobs.

Results

For the stub files that are migrated with HSM for Windows V7.1.2 or later, the migration copies in Tivoli Storage Manager storage contain ADS data. The ADS data that is in stub files is backed up at the next scheduled incremental backup or image backup. After the incremental or image backup, ADS data is fully protected.

Chapter 4. Configuring the HSM for Windows client

This topic indicates when and how to configure the HSM for Windows client.

After installing the HSM for Windows client, you must configure your connection with the Tivoli Storage Manager server before you can use HSM for Windows client. The first time you start the GUI, the configuration wizard guides your choices. After the initial configuring the connection to the Tivoli Storage Manager server, you can use the configuration wizard at any time to change the initial settings.

The HSM for Windows client is installed with default values for regional settings, file recall settings, and the location of configuration, log, and job files. You can change these values at any time with the Preferences window.

You can configure migration jobs, threshold migration, or reconciliation at any time after configuring connection with the Tivoli Storage Manager server.

After adding new hard disks or volumes to a computer that is already running the HSM for Windows client, you must restart the recall service (`hsm.service.exe`) and the monitor service (`hsmmonitor.exe`).

Related concepts:

“Migration jobs” on page 37

“Threshold migration” on page 46

“Reconciliation” on page 62

Configuring the connection between the HSM for Windows client and the Tivoli Storage Manager server

You must configure the connection between the HSM for Windows client and the Tivoli Storage Manager server before you can use the HSM for Windows client.

Before you begin

You must install, configure, and register the Tivoli Storage Manager backup-archive client before you configure and use the HSM for Windows client.

If the computer is a cluster node, you must complete the following tasks:

- Register the cluster node name with the Tivoli Storage Manager server as a client node.
- Add `clusternode yes` to the backup-archive client `dsm.opt` options file.
- For installation and configuration requirements in a cluster environment, see “Installing and configuring the HSM for Windows client in a cluster environment” on page 14

About this task

The first time that you run the HSM for Windows client graphical user interface (GUI), the Configuration wizard displays. The Configuration wizard guides you

through the steps to configure a connection between the HSM for Windows client and the Tivoli Storage Manager server. You can also run the Configuration wizard any time from the **Tools** menu.

Start the HSM for Windows client graphical user interface (GUI) by issuing the **dsmgui.exe** command in the HSM for Windows client installation directory.

Procedure

1. In the Option File Task page, choose whether to create an options file or update an existing options file. If there is no options file, you must create an options file. Click **Next**.

The HSM for Windows client stores configuration information in the `dsm.opt` file that is in the HSM for Windows client installation directory. It does not use the `dsm.opt` file that is used by the Tivoli Storage Manager backup-archive client.

Attention: Use only the HSM for Windows client GUI to change HSM for Windows client options. Editing the HSM for Windows client `dsm.opt` file by another method risks corrupting the file, and can lead to loss of data.

Password and names of file spaces are also stored and managed separately from the backup-archive client. They are stored and managed with the Windows registry entries of the HSM for Windows client.

2. In the TPC/IP Parameters window, enter the server address and port for the Tivoli Storage Manager server. Select TCP/IP options and select **Next**. Each HSM for Windows client can connect to only one Tivoli Storage Manager server for migration. This server can be different from the one that is used by the backup-archive client. If you do not select the box for TCP/IP V4 and TCP/IP V6, the HSM for Windows client uses only TCP/IP V4.
3. In the TSM Authentication window, enter the Tivoli Storage Manager client node name and click **Next**. The node name must be registered with the Tivoli Storage Manager server. If you want to clearly identify the HSM node as distinct from the backup-archive node, choose a different node name for the HSM for Windows client. If the computer is a cluster node, the client node name must be the cluster node name.
4. Optional: Configure the HSM for Windows client for a cluster configuration. If the computer is a cluster node, the Cluster Configuration window is displayed.
 - a. Copy the Tivoli Storage Manager server administrative command `grant proxynode target=targetname agent=agentname` from the Cluster Configuration window.
 - b. Run the command on the Tivoli Storage Manager server console, operations center command line, or administrative client command line. The value of the target parameter (the cluster node name) and the value of the agent parameter (the client node name) must be registered with the Tivoli Storage Manager server as client nodes.
 - c. Click **Next**.
5. In the TSM Password Access window, select the password access option and click **Next**.

If you use **Password Generate**, Tivoli Storage Manager automatically handles the password. As a result, there is no requirement for you to maintain a password or deal with password expiration.

The Tivoli Storage Manager API uses the registry entry of the backup-archive client to store the automatically generated password. If you want to keep the logon parameters of the HSM for Windows client separate from the logon

parameters of the backup-archive client, register the HSM for Windows client under a node name different from the node name that is used by the backup-archive client.

If you select the **Password Prompt** option, you must specify a password to be used by the HSM for Windows client to log on to the Tivoli Storage Manager server. This password is stored and encrypted by the HSM for Windows client and is used automatically for each logon to the Tivoli Storage Manager server. In addition, in **Password Prompt** mode, a password is not required for operations such as running migration jobs or searching a file space.

6. In the Set or Change Password window, type the password for the node and click **Next**. The password was created when the node was registered with the Tivoli Storage Manager server. You can change the password in this panel.
7. In the TSM Server Connection window, verify the values that you configured in the previous windows. Click **Apply**.
8. In the TSM Server Management Class window, select the management class that is the default when you create a migration job or configuration threshold migration and click **Next**. The choice is the default for migration jobs and threshold migration, but you can override the default on each operation. Information in the window indicates the suitability of the management class for archived migration copies.
9. In the default file-security window, specify whether file security attributes (ACL) are migrated and retrieved and click **Next**. The choice is the default for migration jobs, list migrations, selective retrieves, and threshold migrations. You can override the default on each operation in a job file or with a command parameter.
10. In the Alternate Data Streams window, specify whether Windows alternate data stream (ADS) data is migrated or retrieved and click **Next**. The choice is the default for migration jobs, list migrations, selective retrieves, and threshold migrations. You can override the default on each operation in a job file or with a command parameter.
11. In the Backup Before Migration window, configure whether files are backed up before they are migrated and click **Next**. If you choose to back up files before migration, select an options file for the backup. If this option is cleared, the default is to back up before migration. The choice is the default for migration jobs, list migrations, and threshold-migration configurations. You can override the default on each migration job and each threshold-migration configuration.
12. Optional: If no file space was registered, the Initial File Space Registration window is displayed. Enter the name of the default file space to store migrated files from your client node on the Tivoli Storage Manager server, or select the **Skip file space creation** check box. Click **Next**. If you enter the name of a file space that does not yet exist, the HSM for Windows client creates the file space. Select the **Skip file space creation** check box if you want to create a file space when you define a migration job or threshold migration, or start a list migration.
13. Confirm the settings in the Completing the TSM HSM Configuration Wizard window. If all options are correct, click **Finish**. If you must make corrections, click **Back**.

What to do next

When the HSM for Windows client connects successfully to the Tivoli Storage Manager server you can configure migration jobs, threshold migration, and reconciliation.

If the computer is a cluster node, you must repeat the configuration for the HSM client on each node of the cluster.

Related concepts:

“Migration jobs” on page 37

“Threshold migration” on page 46

“Reconciliation” on page 62

“Configuring the retention period of migration copies” on page 24

“HSM in cluster environments” on page 15

Related tasks:

“Configuring a new file space” on page 28

 [Configuring backup-archive clients \(http://www.ibm.com/support/knowledgecenter/SSGSG7_7.1.2/com.ibm.itsm.client.doc/t_cfg_bac.html\)](http://www.ibm.com/support/knowledgecenter/SSGSG7_7.1.2/com.ibm.itsm.client.doc/t_cfg_bac.html)

Related reference:

“Automatic backup before migration” on page 54

 [Backup-Archive Client: commmethod command \(http://www.ibm.com/support/knowledgecenter/SSGSG7_7.1.2/com.ibm.itsm.client.doc/r_opt_commmethod.html\)](http://www.ibm.com/support/knowledgecenter/SSGSG7_7.1.2/com.ibm.itsm.client.doc/r_opt_commmethod.html)

Client password-character restrictions

HSM for Windows client passwords are restricted to certain characters. In some cases, passwords are case-sensitive.

Passwords can be up to 63 character in length. Password constraints vary, depending on where the passwords are stored and managed, and depending on the version of the Tivoli Storage Manager server that your client connects to.

If your Tivoli Storage Manager server is at version 6.3.3 or later, and if you use an LDAP directory server to authenticate passwords

Use any of the following characters to create a password:

```
a b c d e f g h i j k l m n o p q r s t u v w x y z
A B C D E F G H I J K L M N O P Q R S T U V W X Y Z
0 1 2 3 4 5 6 7 8 9
~ ! @ # $ % ^ & * _ - + = ` | ( ) { } [ ] : ; < > , . ? /
```

Passwords are case-sensitive and are subject to more restrictions that can be imposed by LDAP policies.

If your Tivoli Storage Manager server is at version 6.3.3 or later, and if you do not use an LDAP directory server to authenticate passwords

Use any of the following characters to create a password:

```
a b c d e f g h i j k l m n o p q r s t u v w x y z
A B C D E F G H I J K L M N O P Q R S T U V W X Y Z
0 1 2 3 4 5 6 7 8 9
~ ! @ # $ % ^ & * _ - + = ` | ( ) { } [ ] : ; < > , . ? /
```

Passwords are stored in the Tivoli Storage Manager server database and are not case-sensitive.

If your Tivoli Storage Manager server is earlier than version 6.3.3

Use any of the following characters to create a password:

```
a b c d e f g h i j k l m n o p q r s t u v w x y z
A B C D E F G H I J K L M N O P Q R S T U V W X Y Z
0 1 2 3 4 5 6 7 8 9
_ - & + .
```

Passwords are stored in the Tivoli Storage Manager server database and are not case-sensitive.

Remember:

On the command line, enclose a password in quotation marks if the password contains one or more special characters. The quotation marks ensure that the special characters are correctly interpreted as password characters. Without quotation marks, the special characters can be interpreted as shell escape characters, file redirection characters, or other characters that have significance to the operating system.

On Windows systems:

Enclose the password in quotation marks (").

Command line example:

```
-password="secret>shhh"
```

Quotation marks are not required when you type a password with special characters in an options file.

Configuring the HSM client to connect to a secondary Tivoli Storage Manager server

If the primary Tivoli Storage Manager server for the HSM for Windows client is unavailable, you can manually configure the HSM for Windows client to connect to a secondary server. You can recall files from the secondary Tivoli Storage Manager server but cannot migrate files to the secondary server.

Before you begin

The primary Tivoli Storage Manager server for the HSM for Windows client must be one that replicates client node data.

About this task

The Tivoli Storage Manager server that the HSM for Windows client connects to during normal production processes is called the *primary server*. When the primary server is set up for node replication, the data for client nodes can be replicated to the *secondary server*.

The backup-archive client can automatically fail over to the secondary server when it is configured for failover.

The HSM for Windows client, however, does not automatically fail over to the secondary server. You must manually configure the `dsm.opt` file to connect to the secondary server. Any secondary server information in the `replservername` stanza, the `myreplicationserver` option, and the `myprimaryserver` option is ignored by the HSM for Windows client.

You can complete some tasks when connected to the secondary server:

- You can recall and retrieve migrated files from the secondary server by using the HSM for Windows client.
- You can restore a stub file by using the backup-archive client.
- You must not reconcile the file system with the secondary server.

- You must not migrate files to the secondary server.

Procedure

To configure the HSM for Windows client to connect to the secondary server complete the following step:

Edit the `dsm.opt` file to specify information about the secondary server. The following stanza is an example of a secondary server stanza:

```
COMMmethod      TCPip
TCPPort         1500
TCPserveraddress lifeboat.almaden.ibm.com
Passwordaccess  generate
```

What to do next

After you complete this steps, restart the HSM for Windows client.

You can complete some tasks when connected to the secondary Tivoli Storage Manager server:

- You can recall and retrieve migrated files from the secondary server by using the HSM client.
- You can restore a stub file using the backup-archive client.
- You must not reconcile the file system with the secondary server.
- You must not migrate files to the secondary server.

Connect to the primary Tivoli Storage Manager server as soon as it becomes available.

Configuring the retention period of migration copies

You can control the period for which migration copies are stored in Tivoli Storage Manager storage. If you accept the installed-default data management policy, migration copies can be deleted from Tivoli Storage Manager storage in one year.

Files that are migrated by HSM for Windows client are stored as migration copies on a Tivoli Storage Manager server. The migration copies are stored in the storage pool that is defined by the archive copy group of the assigned management class. When migration copies are created in the HSM pool, they are bound to a management class. The migration copies are retained according to the policy specified in the archive copy group of the management class. If the retention period is too short, Tivoli Storage Manager can delete the migration copies on the Tivoli Storage Manager server and leave orphan stubs on the file system. In this case, the migrated files cannot be recalled, and must be restored from backup copies.

If you do not specify a management class for your migration copies, they are bound to the default management class. The default policy values in the archive copy group of the standard management class retain migration copies for only one year.

If the default management class has no archive copy group, the migration copies are retained according to the **ARCHRetention** value defined for the domain.

The archive copy group specifies three attributes that determine the period that migration copies can be retained on the Tivoli Storage Manager server.

- **RETVer** determines the number of days to retain a migration copy.
- **REInit** determines when the **RETVer** attribute is applied.

If **REInit=Event**, the **RETVer** attribute applies when a HSM for Windows client reconciliation process determines that a migration copy is no longer needed.

Migration copies are retained like this:

1. A stub is deleted from the file system.
2. Reconciliation determines that the migration copy on the Tivoli Storage Manager server is no longer needed. Reconciliation sends an event notice to the Tivoli Storage Manager server.
3. When the Tivoli Storage Manager server receives the event notice from the reconciliation process, the retention period specified by **RETVer** begins.
4. When the retention period specified by **RETVer** ends, the Tivoli Storage Manager server marks the file for deletion.
5. When the Tivoli Storage Manager server runs an expiration process, the migration copy is deleted from the Tivoli Storage Manager server.

If **REInit=Creation**, the **RETVer** attribute applies when a migration copy is created. If the **RETVer** period expires before a stub is deleted, Tivoli Storage Manager server deletes the migration copy. This leaves an orphan stub on the file system. If a stub is deleted before the **RETVer** period expires, a migration copy is retained like this:

1. A stub is deleted from the file system.
2. Reconciliation determines that the migration copy on the Tivoli Storage Manager server is no longer needed. Reconciliation sends a deletion notice to the Tivoli Storage Manager server.
3. When the Tivoli Storage Manager server receives the deletion notice from the reconciliation process, the Tivoli Storage Manager server immediately marks the migration copy for deletion.
4. When the Tivoli Storage Manager server runs an expiration process, the migration copy is deleted from the Tivoli Storage Manager server.

After a copy group is defined, the **REInit** value cannot be updated.

- **REMin** determines the minimum period to retain a migration copy after it is created. This attribute applies only when **RETVer=Event**.

Choose a management class with an archive copy group that meets your data retention needs.

When you configure the connection between the HSM for Windows client and the Tivoli Storage Manager server, you can specify a management class. This management class becomes the default management class for new migration jobs and new threshold migration configurations. You can specify a different management class for migration when you configure a job or threshold migration, and when you start a migration using `dsmc1c.exe`. The management class that you specify when you configure a job or threshold migration overrides the default management class for migration. The management class that you specify when you start a migration using `dsmc1c.exe` overrides the configured management class for migration.

Jobs and threshold migration that were configured prior to version 6.1.3 did not specify a management class, and they used the default management class for the policy set. Those jobs and threshold migration continue to use the default

management class for the policy set until you reconfigure them. Note that the default management class for the policy set can be the same as the default management class for new migration jobs and threshold configuration, but is not necessarily the same.

Related information:

For guidelines on implementing policies for client data, see the *Tivoli Storage Manager Administrator's Guide*.

For descriptions of commands to implement policy, see the *Tivoli Storage Manager Administrator's Reference*.

Related concepts:

➤ Server: Policy-based data management (https://www.ibm.com/support/knowledgecenter/SSGSG7_7.1.1/com.ibm.itsm.srv.doc/t_tsmconcepts_policies.html)

Related reference:

➤ Server command: UPDATE COPYGROUP (Update a defined archive copy group) (https://www.ibm.com/support/knowledgecenter/SSGSG7_7.1.1/com.ibm.itsm.srv.ref.doc/r_cmd_copygroup_archive_define.html)

Changing the retention period of migration copies

You can change the retention period of migration copies that are stored on a Tivoli Storage Manager server.

When files are migrated by HSM for Windows client, they are bound to a management class. The retention period of migration copies are determined by the archive copy group settings of that management class. To change the retention period of the migration copies, you must change the archive copy group settings.

There are several ways you can change archive copy group settings. The simplest change is to update the archive copy group settings of the management class that is currently bound to the migration copies. Although the change is simple, the change affects all archive copies that are bound to this management class. This can include copies of files that are archived by the backup-archive client. And you are limited because when you update an archive copy group, you cannot change the **RETInit** value.

A more complex change involves creating a new domain for HSM for Windows client migration copies. Tivoli Storage Manager policy allows many ways to change the archive copy group settings, and you can choose the option that works best for your business. The following recommendations assume that migration copies are currently bound to the default management class. This assumption would be true for migration copies that are created by HSM for Windows Version 6.1.2 and earlier. These suggestions can be modified to account for migration copies that are not currently bound to the default management class.

Define a new policy domain that isolates the HSM for Windows client from other client nodes.

Define a new policy domain just for the HSM for Windows client. Define a policy set for the new domain. Define a new management class with an archive copy group that specifies an appropriate retention period for migration copies. Assign the new management class as the default for the

new policy domain and policy set. Validate and activate the policy set. Update the HSM for Windows client node to become a member of the new policy domain.

As a result, all migration copies on the Tivoli Storage Manager server that are associated with the HSM for Windows client node and that were previously bound to the old default management class are rebound to the new default management class.

If the HSM for Windows client node name is the same as the backup-archive client node name, this change can also affect the archive copies created by the backup-archive client.

This solution works for all versions.

Define a new default management class for the existing domain

Define a new management class with an archive copy group that specifies an appropriate retention period for migration copies. Assign the new management class as the default for the existing policy domain and policy set.

As a result, all migration copies on the Tivoli Storage Manager server that are associated with the existing policy domain and that were previously bound to the old default management class are rebound to the new default management class. This change can affect the migration copies of all nodes that are members of the policy domain.

This solution also works for files that were migrated with HSM for Windows client versions earlier than 6.1.3. Files that were migrated with such earlier HSM for Windows client versions are bound to the default management class.

Recall and remigrate files with a new management class

Define a new management class with an archive copy group that specifies an appropriate retention period for migration copies. The new management class does not have to be the default for the active policy set. Recall all migrated files. Delete the existing file spaces. Migrate the files again, and specify the new management class.

As a result, the migration copies on the Tivoli Storage Manager server that were created by the HSM for Windows client are bound to the new management class. This change does not affect the archive copies that were created by the backup-archive client. This process can cause significant network traffic and use significant local storage resources.

Related reference:

 Server: Creating your own policies (https://www.ibm.com/support/knowledgecenter/SSGSG7_7.1.1/com.ibm.itsm.srv.doc/r_mplmntpol_mkpols.html)

Configuring a new file space

You can create new file spaces on the Tivoli Storage Manager server directly from the HSM for Windows client GUI.

About this task

Use the steps in this task to create a new file space:

Procedure

1. To create a new file space select **Tools > Create New File Space**.
2. Enter a name for the new file space.
3. Select the **OK** button.

Configuring regional settings

Use the **Regional Settings** tab of the Preferences window to set your language, time format, date format, number format, and define if you want log, list, and trace files in Unicode.

Before you begin

Note: You must restart the HSM for Windows client GUI for any changes to become effective.

Procedure

1. Select **Tools > Preferences** and then select the Regional Settings tab.
2. Make changes as needed and select the **OK** button.

Excluding Windows alternate data stream names

You can exclude Windows alternate data stream (ADS) data by name. ADS names in the exclude list are excluded from HSM operations.

About this task

To create a list of Windows alternate data stream names that are excluded from HSM operations, complete the following steps.

Procedure

1. In the HSM for Windows client GUI, click **Tools > ADS Exclude List**. The ADS Exclude List window is displayed.
2. Click **Create**, type an ADS name, and click **OK**.

HSM advanced parameters and preferences settings

Although most parameter default settings are appropriate, you can customize some settings.

Table 2 displays the advanced parameters. For all parameters except the *Timeout* parameter, the Parameter name column shows you the parameter name and Windows registry path from the end of this common path: HKLM\SOFTWARE\IBM\ADSM\CurrentVersion\HsmClient\. The Timeout parameter full path is listed in the Parameter name column.

Table 2. Advanced parameters descriptions

Parameter name	description	Default	Notes
HKLM\SYSTEM\CurrentControlSet\Services\ithsmdrv\Parameters\Timeout	The File System Filter Driver returns an error when this time elapses and a recall process has not yet started. If the recall process starts within this time, no error is returned. The start time is when the recall thread picks up the recall order. Time waiting for a device or reading data is not considered. The end time of the recall process is not considered. The time is measured in seconds.	300	The error is returned when the recall service is too busy, and the recall quota has not been reached. This can occur when many recall processes are running at the same time.
dsmclic\FileAttributesFilter	Configures the registry to prevent files with certain attributes from migration. Affects the dsmclic.exe command.	6 - hidden and system	Change this parameter only on technical advice from IBM.
dsmgui\FileAttributesFilter	Configures the registry to prevent files with certain attributes from migration. Affects the dsmgui.exe command.	6 - hidden and system	Change this parameter only on technical advice from IBM.
hsmmonitor\FileAttributesFilter	Configures the registry to prevent files with certain attributes from migration. Affects the hsmmonitor.exe command.	6 - hidden and system	Change this parameter only on technical advice from IBM.
dsmclic\DirectoryAttributesFilter	Configures directories with certain attributes that are generally not entered for selecting files for migration. Affects the dsmclic.exe command.	6 - hidden and system	Change this parameter only on technical advice from IBM.
dsmgui\DirectoryAttributesFilter	Configures directories with certain attributes that are generally not entered for selecting files for migration. Affects the dsmgui.exe command.	6 - hidden and system	Change this parameter only on technical advice from IBM.

Table 2. Advanced parameters descriptions (continued)

Parameter name	description	Default	Notes
hsmmonitor\ DirectoryAttributesFilter	Configures directories with certain attributes that are generally not entered for selecting files for migration. Affects the hsmmonitor.exe command.	6 - hidden and system	Change this parameter only on technical advice from IBM.

File location preferences

Use the HSM for Windows client GUI Preferences window **Path Configuration** tab to define file locations.

Access the Preferences window **Path Configuration** tab by selecting HSM for Windows client GUI. Select **Tools > Preferences > Path Configuration**.

The **Path Configuration** tab contains fields that indicate the location of the following files:

- Configuration files
- Migration job files
- Move job files
- Temporary files

Move Settings

You can configure the bandwidth that is used for moving stub files. You can also configure how many stub files are identified before a move process begins.

Use the HSM for Windows client GUI Preferences window **Move Settings** tab to configure two move settings:

Bandwidth

The **Bandwidth** value controls what percent of time the HSM for Windows client spends on move operations. For example, if you set **Bandwidth=40%** and a move operation takes 20 milliseconds, the HSM for Windows client pauses for 30 milliseconds before the next move operation starts. The total elapsed time is 50 milliseconds, the move operation is 20 milliseconds (40%) of the elapsed time.

Stub Files

The **Stub Files** value controls how many stub files are identified before a move operation begins. The HSM for Windows client moves the stub files in an optimal order to minimize the number of tape mounts and seeks. When the list of stub files is large, more files can be moved with fewer tape mounts. However, it takes more time for the HSM for Windows client to identify a large number of stub files. A larger value improves the efficiency of the move process, but delays the start of the move operation. The value can be 1 to 50,000. The default is 5,000.

File recall quotas

You can define file recall quotas to limit the number of possible file recalls during a time span. You can define a system-wide default quota and define quotas for particular Windows user and group accounts.

Several quotas can be defined for one user account:

- A user account quota can be defined.
- A user account can be a member of one or more group accounts for which a group account quota is defined.
- A default quota can be defined.

The quota that applies to a user account is the *effective quota*.

User account quotas define the allowed number of file recalls in a time span for an individual user account. If a user account quota is defined, only this quota applies to the user account. Default and group account quotas are overridden by a user account quota.

Group account quotas define the allowed number of file recalls in a time span for each user account in a group. If a user account is a member of two or more groups and has no user account quota, the group with the least restrictive quota applies to the user account.

The default quota applies to user accounts for which no group account quota or user account quota is defined.

You can define quotas for global groups and for universal groups. You cannot define quotas for local domain groups. Local-domain group quotas that were defined in previous versions of HSM for Windows are ignored.

Quotas can be updated at any time with the HSM GUI. The update is effective immediately without restarting the HSM for Windows client. The update is displayed in the **Live Quotas** tab of the **Recall Quotas** window after the user recalls a file.

The HSM for Windows client compares the file recalls quota with the actual file recalls during a time span. The time span is a moving window. For example, assume that you define a quota of five files per 60 seconds. When a user tries to recall a file, the HSM for Windows client compares the file recalls quota with the number of file recalls in the previous 60 seconds. If the user recalled five files in the previous 60 seconds, the user cannot recall another file until more time elapses. When less than five files were recalled in the previous 60 seconds, the user can recall another file.

When a user reaches a file recall quota, a subsequent file recall request is rejected. The HSM for Windows client returns the code `STATUS_FILE_IS_OFFLINE`. The behavior of the calling application depends on the response of the calling application to the return code.

Quotas affect only the recall of migrated files from users that access stub files. Quotas do not have any influence on retrieving files with the HSM for Windows client GUI.

If a user reaches the quota, you can reset the file recall counter. You can reset the file recall counter with the **dsmquota.exe** command or **Live Quotas** tab of the **Recall Quotas** window of the HSM for Windows client GUI.

The quota configuration is stored in the HSM for Windows client installation directory in `\config\quota.cfg`. After you change quotas, a backup of `quota.cfg` is saved in the backup directory `\config\backup\quota.cfg`.

Viewing and changing the default file-recall quota

Use the HSM for Windows client GUI to view and change the default file-recall quota.

Procedure

1. Select **Tools > Recall Quotas** to open the Recall Quotas window.
2. Select the **Default Quota** tab.
3. Optional: Change the quota.
 - a. Select one of the following options:

Unlimited Recalls

There is no limit for file recalls.

No Recalls

No recalls are allowed.

Configure Quota

You must enter the number of files and the time span.

- b. Click **OK** to change the default quota.

Viewing and changing a group file-recall quota

Use the HSM for Windows client GUI to view and change a group account quota.

About this task

The effective quota for a user account is determined by the hierarchy of quota types and from the quota definitions that apply to the user account. Quota types have the following hierarchy:

- A group account quota overrides the default quota.
- The highest group account quota overrides other group account quotas.
- A user account quota overrides a group account quota.

Procedure

Complete the following steps.

1. Select **Tools > Recall Quotas** to open the Recall Quotas window.
2. Select the **Group Quotas** tab.
3. Optional: Filter the group accounts by domain and group account name.
 - a. In the **Look in** list, select a domain.
 - b. In the **Filter** field, type a group account name pattern. You can use wildcard character `*` to replace one or more characters and `?` to replace one character.
 - c. Click **Find Now** to display group accounts that meet the domain and name criteria.
4. Optional: Change a group account quota.
 - a. Select a group account and click **Change Quota**. The Recall Quota Editor window opens.

- b. Select one of the following choices:

No Group Quota Definition

Do not apply this quota definition. The quota definition is not used to calculate the effective quota for a user account.

Unlimited Recalls

There is no limit for file recalls.

No Recalls

No recalls are allowed.

Configure Quota

You must enter the number of files and the time span.

- c. Click **OK**.
d. Click **OK** to change the quota.

Viewing and changing a user file-recall quota

Use the HSM for Windows client GUI to view and change a user account file-recall quota.

About this task

The effective quota for a user account is determined by the hierarchy of quota types and from the quota definitions that apply to the user account. Quota types have the following hierarchy:

- A group account quota overrides the default quota.
- The highest group account quota overrides other group account quotas.
- A user account quota overrides a group account quota.

Procedure

Complete the following steps.

1. Select **Tools > Recall Quotas** to open the Recall Quotas window.
2. Select the **User Quotas** tab.
3. Optional: Filter the user accounts by domain and user name.
 - a. In the **Look in** list, select a domain.
 - b. In the **Filter** field, type a user account name pattern. You can use wildcard characters asterisk (*) and question mark (?).
 - c. Click **Find Now** to display users that meet the domain and name criteria.
4. Optional: Select a user and click **Effective Quota**. The Effective User Recall Quota window shows all quota definitions for the user account and the effective quota for the user account.
5. Optional: Change a user account quota.
 - a. Select a user account and click **Change Quota**. The Recall Quota Editor window opens.
 - b. Select one of the following choices:

No User Quota Definition

Do not apply this quota definition. The quota definition is not used to calculate the effective quota for a user account.

Unlimited Recalls

There is no limit for file recalls.

No Recalls

No recalls are allowed.

Configure Quota

You must enter the number of files and the time span.

- c. Click **OK**.
- d. Click **OK** to change the quota.

Viewing and resetting file-recall counters

Use the HSM for Windows client GUI to view live file-recall counters. You can reset file recall counters.

Before you begin

The IBM TSM HSM Recall Service must be running. If the IBM TSM HSM Recall Service is not running, live quota information is not available.

About this task

Live quota information is periodically refreshed. You can change the frequency at which the view is refreshed in **Tools > Preferences > Recall Service**.

Procedure

1. Select **Tools > Recall Quotas** to open the Recall Quotas window.
2. Select the **Live Quotas** tab.
3. Filter the user accounts by domain and user name.
 - a. In the **Look in** list, select a domain.
 - b. In the **Filter** field, type a user account name pattern. You can use wildcard characters asterisk (*) and question mark (?).
 - c. Click **Refresh**.

The file recall counter and quota are displayed for user accounts for which all of the following are true:

- The user account is found in the domain.
- The user name matches the filter.
- The file recall quota for the user account is finite and greater than 0.
- The file recall counter for the user account is greater than 0. After you change a quota definition, live-quota information for the user account is not displayed until the user recalls a file.

The live quota information is of the format 1 of 3 recalls, where 1 is the recall counter and 3 is the recall quota. The recall counter indicates the file recalls that are within the time span that is defined for the quota. The file recall counter changes as the user recall files and as the time-span window changes. The button name changes from **Refresh** to **Pause**.

4. Optional: Click **Pause**. Live updates are paused.
5. Optional: Select a user account and click **Reset Counter**. The file recall counter is reset to 0 for the user account.
6. Optional: Select a different domain or a different name filter. When live updates are refreshed, user accounts that match the domain and name criteria are displayed.

Recall service settings

Use the HSM for Windows client GUI to define the recall service settings. You can set the number of concurrent connections to the Tivoli Storage Manager and the time period for closing connections and deleting obsolete recall quota counters.

Access the **Recall Service** tab of the Preferences window by selecting **Tools > Preferences > Recall Service**.

Restriction: Change the value of **Threads** only when required by IBM Software Support. The **Threads** value determines the maximum number of concurrent connections for the recall service. The default is 4 and the maximum is 64.

You can set the time to close an idle connection to the Tivoli Storage Manager. The default value is 600 seconds.

Note: If a file is recalled from a tape, the connection is reset to ensure that the tape is not locked after the recall.

You can change the frequency at which the view is refreshed in the Live Quotas window. The default value is 2 seconds.

You can set the interval to delete expired quota entries. To determine file recall quotas, the recall service creates a record for every file recall. Periodically, a collection routine runs to eliminate obsolete table entries. Running the collection routine frequently saves computer memory but requires more computer processing. The default value is 60 minutes. The minimum value is 10 minutes, and the maximum value is 10080 minutes.

The frequency of running the collection routine does not affect recall performance. The collection routine is not a performance tuning tool.

Tracing preferences

HSM for Windows client processing, from both the GUI and the commands, creates several log files, trace files, and list files.

You can set the logging levels, log file sizes, and log file locations in the Trace Preferences window in the HSM for Windows client GUI. You can also set the log levels with HSM for Windows client commands. You cannot set the log file location or the size with HSM for Windows client commands.

In normal production, the defaults log values are sufficient. The default level records warnings and errors and does not record trace-level messages. Increase the logging level only when you must complete advanced diagnostic tasks. The **Severe** and **Error** logging levels are active by default and cannot be deactivated.

When you change log levels in the **hsmervice**, **hsmtasks**, **hsmmonitor** or **dsmgui** tab, you are not required to restart those programs for those settings to become active. Other changes require a restart. You are notified when a restart is required.

There are three types of settings you define for the logs: their recording level, their size, the log file location. To access these settings from the HSM for Windows client GUI, select **Tools > Trace Preferences**.

Table 3 on page 36 describes the trace levels settings.

Table 3. Tracing preferences: Trace levels

Field	Description
Severe	Records HSM Windows messages that are categorized as severe.
Error	Records HSM Windows messages that are categorized as errors.
Warning	If checked, records HSM Windows messages that are categorized as warnings.
Info	If checked, records HSM Windows messages that are categorized as information only.
Trace	If checked, turns on the tracing of program events and is used for advanced diagnostic tasks or for problem analysis.
Debug	If checked, records special debugging information and codes is used for advanced diagnostic tasks or for problem analysis.
Library	If checked, records specific library information and is used for advanced diagnostic tasks or for problem analysis.
Dump	If checked, records more information about issues and is used for advanced diagnostic tasks or for problem analysis.
Events	If checked, records diagnostic information such as function entries and exits.
Flush	If checked, records each message to disk before processing continues instead of buffering them. This records all messages one-by-one but might affect system performance. Use this setting for advanced diagnostic tasks.
Default	Returns the settings in the Trace Levels section of this window to their default values.
Full	Returns all available logging and tracing levels.

Table 4 describes the trace file size settings.

Table 4. Tracing preferences: Trace file size

Field	Description
Maximum file size	Sets a size limit in megabytes for the selected trace file. The default is 10.
File wrapping at	Defines the percentage of the log file that is kept when the Maximum file size value is reached. The default is 66.

Table 5 describes the log file size settings.

Table 5. Tracing preferences: Log file size settings

Field	Description
Maximum file size	Sets a size limit in megabytes for the selected log file. The default is 10.
File wrapping at	Defines the percentage of the log file that is kept when the Maximum file size value is reached. The default is 66.

The **Path Configuration** tab contains three text boxes where you select the path of the three different files: trace files, log files, and list files. Click **Browse** to select an existing directory.

Chapter 5. Managing space with HSM for Windows

You can manage space on Windows file servers by creating and running migration jobs, and by configuring threshold migration.

You can manually retrieve migrated files with the HSM for Windows client or with the Tivoli Storage Manager backup-archive client.

Changes on your file system need to periodically be reconciled with the Tivoli Storage Manager server.

Migration jobs

A migration job specifies which files to migrate and whether to leave a stub file on the originating file system.

You can specify the files to migrate by using the HSM for Windows client GUI or the HSM for Windows client `dsmc1c.exe` command.

With the HSM for Windows client GUI, you can browse local file systems. You can exclude or include parts of the directory structure in a migration job. For each selection, filters can be applied to include or exclude files. The inclusion or exclusion can be based on file criteria:

- File type
- File size
- File creation date
- File modification date
- File access date

Each migration job is stored in an XML structured job file. The actual migration can be scheduled by using any standard scheduler, or it can be started manually from a Command Prompt window. In addition, the HSM for Windows client administrator can start a migration job directly from the HSM for Windows client GUI.

When you decide what files to include in a migration job, consider both the frequency of use of the files and the recall speed. Although most file recall is not noticed by users, network bandwidth, storage repository speed, and file size all determine the file recall speed.

A migration job file can be shared among computers with similar configurations, and can be shared among nodes in a cluster. If some directory structure of two computers is the same, you can use without modification a migration job that specifies the common directory structure on both computers.

Related reference:

“`dsmc1c.exe`” on page 75

Creating migration jobs

Use the HSM for Windows client GUI to define migration jobs. Migration jobs select different file sets to migrate by specifying different include and exclude conditions such as file age, size, subdirectory, and groups on files or directories.

About this task

The length of the path and name of migrated files is limited.

The length of a file name that is migrated by the HSM for Windows client cannot exceed 256 bytes. The path length (the API high-level qualifier) cannot exceed 1024 bytes. A path and file name includes the file server name, the volume, and the directory portion of the full Uniform Naming Convention (UNC) name, for example \\FILESERVER\E:\directory\filename.ext. The Unicode representation of a character can occupy several bytes, so the maximum number of characters that a file name might contain can vary.

When using the HSM for Windows client GUI, path names can be a maximum of 254 characters only. For path names that exceed 254 characters, you must use the **dsmc1c.exe** command from a Command Prompt window.

To complete the following steps to define a migration job, run the HSM for Windows client GUI.

Procedure

1. Select **Job > New Job** or right-click in the window's white space and select **New Job**.
2. Name the new job icon to a name of your choice. You cannot use a directory delimiter in the job name.
3. Double-click the new job icon to display the job creation window.
4. In the **General** tab, use the **File Space** menu to select the name of the file space in which you want to store migrated files.
5. In the **Backup before migration** box, you can specify that files must be backed up before they are migrated. If a job specifies a file that was not backed up, the file is backed up and then it is migrated. If you select this option, you must also indicate an options file for the backup before migration. You can specify an options file, or you can specify that the backup-archive client determines the options file.
6. In the **Management class** panel, select a management class for migrated files. A message at the bottom of the panel indicates the suitability of the management class for retaining the migrated files.
7. In the **Management class** tab, select a management class for migrated files. A message at the bottom of the panel indicates the suitability of the management class for retaining the migrated files.
8. On the **Migration Options** tab, specify whether file security attributes (ACL) and Windows alternate data streams (ADS) data are migrated when the file is migrated. The defaults are the values that you set in the initial configuration wizard.
9. To add a directory, skip to step 10 on page 39. For each file you want to add, follow these substeps:
 - a. Select the Source Files tab's **New File** button.
 - b. Select **Browse**. In the Browse for File window, select the drive that you want and select **OK**.

- c. Use the file selection window that displays to drill down to the file that you want and select **OK**.
- d. Select a migration action. The default **Replace the file with a shortcut to the file space** option migrates the file and creates a stub file. The **Keep the original file** option migrates the file, but the original file remains on the local system. The **Delete the file** option migrates the file and then deletes it from the local system.

Note: Do not run reconciliation on the file spaces that are used for this job, if you select **Delete the file**.

- e. Select the Source File window's **Advanced Conditions** tab and select **New Include**. The following steps use the Include Conditions windows as examples, but you can also choose **New Exclude**, which follows the same convention. And you can combine include and exclude conditions.
 - f. From the **Include Condition** window's top menu, choose the type of condition you want for the selected files, define the settings, and select **OK**.
 - g. Continue to define include and exclude conditions for the selected files and select **OK** when complete.
10. To add directories from the New Job window's **Source Files** tab, select **New Directory** and then **Browse**. Select the directory that you want to add and select **OK**. Continue to add as many directories as required, then follow these substeps to define the details of the migration job:

Note: The migration action and include and exclude conditions that you apply to a subdirectory-based migration job applies to the individual files in the selected subdirectories.

- a. Select a migration action. The default **Replace the file with a shortcut to the file space** option migrates the file and creates a stub file. The **Keep the original file** migrates a copy of the file, but the original file remains on the file system. The **Delete the file** option migrates the file and then deletes it from the file system.

Note: Do not run reconciliation on the file spaces that are used for this job, if you select **Delete the file**.

- b. Select the **Include Subdirectories** check box if you want to include all files in the selected directory's subdirectories.
- c. Select the **Advanced Conditions** tab, and then select the type of include condition that you want to define.

Related concepts:

"Migration jobs start by a schedule, GUI, or CLI" on page 44

Related tasks:

"Configuring a new file space" on page 28

"Creating a new file group" on page 43

"Edit a file group" on page 43

"Calculating a migration job's space savings" on page 43

Related reference:

"Examples of including and excluding files" on page 40

"Automatic backup before migration" on page 54

Examples of including and excluding files

The following examples show the interaction of include and exclude conditions.

Note: The following examples are to help you get started with building your own include and exclude conditions. Test your own conditions thoroughly.

Table 6 lists the base file set used in these include and exclude examples. A base file set includes all files in the selected disk, directories, and, if selected, all subdirectories. The content of the base file set never changes. Include and exclude conditions that you define create a subset of the base files that are valid for the selected operation. This valid subset of files is called the "target set". If you set no conditions, the HSM for Windows client by default includes all files.

Table 6. Example base file set

File name	File size
test.log	1.5 GB
test.html	50 K
test.bmp	250 MB
test.pdf	2.7 GB
test2.pdf	11 GB
test.dwg	100 GB

Example 1: one include condition

```
include all files < 300 MB
```

The exclude condition is evaluated against all files in the base set. The result is all files that are less than 300 MB:

```
test.html (50 KB)
test.bmp (250 MB)
```

Example 2: one exclude condition

```
exclude all files < 300 MB
```

The exclude condition is evaluated against all files in the base set. The result is all files that are 300 MB or greater:

```
test.log (1.5 GB)
test.pdf (2.7 GB)
test2.pdf (11 GB)
test.dwg (8 GB)
```

Example 3: one exclude condition

```
exclude all files < 30 GB
```

The exclude condition is evaluated against all files in the base set. All files match the condition, so all files are excluded.

Example 4: two include conditions

```
include all files < 300 MB
include all files with extension = pdf
```

First, the first include condition is evaluated against all files in the base set. The result is the following files:

```
test.html (50 KB)
test.bmp (250 MB)
```

Next, the second include condition is evaluated against all files in the base set. The result is the following files:

```
test.pdf (2.7 GB)
test2.pdf (11 B)
```

The final result is any file that matches any of the include conditions:

```
test.html (50 KB)
test.bmp (250 MB)
test.pdf (2.7 GB)
test2.pdf (11 GB)
```

Example 5: two exclude conditions

```
exclude all files < 300 MB
exclude all files with extension = pdf
```

First, the first exclude condition is evaluated against all files in the base file set, and the result is the following files:

```
test.log (1.5 GB)
test.pdf (2.7 GB)
test2.pdf (11 GB)
test.dwg (8 GB)
```

Next, the second exclude condition is evaluated against the result of all previous evaluations. The final result is the following files:

```
test.log (1.5 GB)
test.dwg (8 GB)
```

Example 6a: mixed include and exclude conditions

This example coding does not yield a set of only PDF files that are less than 3 GB.

```
exclude all files < 3 GB
include all files with extension = pdf
```

First, the exclude condition is evaluated against all files in the base file set, and the result is the following files:

```
test2.pdf (11 GB)
test.dwg (8 GB)
```

Next, the include condition is evaluated against all files in the base file set. The result of the include condition is the following files:

```
test.pdf (2.7 GB)
test2.pdf (11 GB)
```

The final result is the following files:

```
test.pdf (2.7 GB)
test2.pdf (11 GB)
```

test.dwg (8 GB)

Remember: An include condition is evaluated against all files in the base file set regardless of the preceding include or exclude conditions.

Example 6b: mixed include and exclude conditions

This example coding does yield a set of only PDF files that are less than 3 GB.

```
include all files with extension = pdf
exclude all files < 3 GB
```

First, the include condition is evaluated against all files in the base file set, and the result is the following files:

test.pdf (2.7 GB)
test2.pdf (11 GB)

Next, the exclude condition is evaluated against the set of files that result from all previous evaluations. The final result is the following files:

test2.pdf (11 GB)

Example 7: redundant exclude condition

This example illustrates how an exclude condition can be redundant.

```
include all files with extension = html
exclude all files with extension = log
```

First, the include condition is evaluated against all files in the base file set, and the result is the following files:

test.html (50 KB)

Next, the exclude condition is evaluated against the set of files that result from all previous evaluations. The final result is the following files:

test.html (50 KB)

File groups

To facilitate the grouping of files for migration, you can create and edit file groups in HSM for Windows. You define file groups by file extension types.

You can associate any number of file types to one file group. For example, you can have a group that is called "Image Files" consisting of these file extensions: bmp, jpg, eps, and gif. You can define another file group called "Office Files" consisting of the following file extensions: doc, xls, and ppt.

Note:

- A file group can be used in the definition of migration jobs.
- Every file group is global and any changes to the group changes its definition anywhere that group is used or selected.

Creating a new file group

Use these steps to create a new group using the HSM for Windows client GUI.

About this task

Note: The creation of a new file group is global. The new file type you create here will be included in the lists of types under **Tools > File Groups**.

Procedure

1. Select **Tools > File Groups**.
2. Click the **New file group** button.
3. Enter the name of the file group you want to define.
4. Enter the file extensions you want to be included in this file group, separated by spaces.
5. Click the **OK** button.

Related tasks:

"Edit a file group"

Edit a file group

Use these steps to edit an existing file group using the HSM for Windows client GUI.

About this task

Note: Any changes you make to a file group affect that file group globally, wherever it is used or selected.

Procedure

1. Select **Tools > File Group**.
2. Select the file group you want to edit and select the **Edit** button.
3. Edit the file extensions you want to be included in this file group.

Related tasks:

"Creating a new file group"

Calculating a migration job's space savings

Before finalizing a migration job, you can calculate the amount of space that will be saved by a migration without having to run the migration job.

About this task

To calculate a migration job's space savings perform the following step:

Procedure

Right-click the migration job that you want to calculate and select **Calculate Space Saving**. The HSM for Windows client searches for all files that match the job criteria. If the file system contains many directories and files, the search can take some time. When all files have been searched, you can see three sets of information in both files count and kilobytes:

- Current Disk Usage
- Disk Usage after Migration
- Free Disk space Gain

Migration jobs start by a schedule, GUI, or CLI

Migrations jobs can be started by a standard scheduler, by the HSM for Windows client GUI (graphical user interface), and by the HSM for Windows client CLI (command-line interface).

You can run migrations jobs any of the following ways:

- From the HSM for Windows client GUI
- From the Command Prompt window by using the **dsmc1c** command
- From a scheduled task

Related reference:

“**dsmc1c.exe**” on page 75

Running migration jobs from the HSM for Windows client GUI

After defining migration jobs, you can run them at any time from the HSM for Windows client GUI.

Run migration jobs from the HSM for Windows client GUI by right-clicking on a migration job and selecting **Execute Job Immediately**.

Viewing migration job results

When a migration job finishes, you can view the results.

About this task

When a migration job finishes, an information window displays.

Procedure

1. Click **OK** . The **Task List** window opens.
2. Check the **Display per file details when migration is finished** box. The detailed result is displayed when you close the **Task List** window.
3. Click **Report**. The **Migration Report** window opens.
4. In the **Migration Report** window, click **Close** . The **Migration Report** window closes.
5. In the **Task List** window, click the **Close** button. The **Task List window** closes. The **Result** details window opens.

The **Result** window contains a list of the processed files and a message about the migration result for each file. Click the column headers to sort the **Name** and **Message** columns. Right-click a row to display information filters. Check or uncheck the filters to apply the filters to the list. The Show Stub Files filter is persistent and remains activated or deactivated until the status is changed by the user. The other three filters are activated by default and changes are valid only for the current GUI session.

Scheduling a migration job

You can schedule migration jobs to run automatically by using a scheduler provided by another vendor. Schedule the **dsmc1c.exe** command, specifying the job file as an argument when **dsmc1c.exe** is started.

About this task

You can run only one **dsmc1c.exe** process at a time. You cannot schedule two migrations at the same time, and you cannot schedule two migrations that overlap. The following steps show how to configure the Windows Scheduler to start a migration job weekly:

Procedure

1. From **Windows Start** menu, select **Administrative Tools > Task Scheduler**. The Task Scheduler window opens.
2. Click **Create Basic Task**. The Create Basic Task Wizard window opens.
3. Type a task name and description. Click **Next**. The Trigger window opens.
4. Click weekly (or as often as you want to run the task). Click **Next**. The Weekly window opens.
5. Enter schedule details. Click **Next**. The Action window opens.
6. Check **Start a program**. Click **Next**. The Start a program window opens.
7. Type the path of the **dsmc1c.exe** command in the **Program/script** field. Type the job file name in the **Add arguments (optional)** field. Click **Next**. The Summary window opens.
8. Click **Finish**. Windows creates the scheduled task.

Results

Migration by file list

You can migrate a list of files that are contained in a text file. The text file can be created by any program, but must meet encoding and format criteria.

Migration jobs migrate files that meet a job's selection criteria. Threshold migration uses file size and age to determine which files to migrate, but you cannot specify which files are migrated. If you want to migrate specific files, regardless of age and size, you can do a list migration.

The list file must meet these specifications:

- The file is encoded in the Windows default ANSI system code page or in Unicode. If the file is encoded in Unicode, it must be UCS-2LE, with a Byte Order Mark (BOM) as the first 2 bytes in the file. The BOM (0xFF, 0xFE) is automatically written when you save the file from a Notepad editor and specify Unicode encoding. UCS-2LE supports all languages that are supported by the HSM for Windows client.
- Each line of the file contains the complete path name of one file.
- Each line of the file is separated by carriage return and line feed (CRLF).

You can use another application to create the list file. Start the **dsmc1c.exe** command, specifying the **migratelist** option, and specify the name of the list file.

Related reference:

Threshold migration

You can migrate files from your volumes according to high and low thresholds of space usage. With proper configuration, you can greatly reduce the chance of your volumes running out of space.

Threshold migration provides automatic control of space usage of the volume. You set the high and low space-usage thresholds that trigger the HSM for Windows client to automatically start and stop migration. You configure guidelines for migration candidates. HSM for Windows client uses those guidelines to choose which files to migrate, and when, to meet the space usage settings.

You can configure threshold migration with the Threshold Migration settings window in the GUI, or with the `dsmhsmc1c.exe` command.

Related concepts:

“Configuring the retention period of migration copies” on page 24

Related reference:

“Automatic backup before migration” on page 54

“Managing threshold migration with `dsmhsmc1c.exe`” on page 108

Migration candidates

HSM for Windows client chooses larger and older files as candidates for threshold migration.

Files that are frequently modified or accessed are poor candidates for migration. HSM for Windows client assumes that the last access date or modification date or creation date is an indicator of how dynamic a file is. Hence, HSM for Windows client chooses migration candidates that have a greater age, as measured by access, modification, or creation date. You configure which of these dates (access, modification, or creation) HSM for Windows client uses to determine file age. You also configure the minimum age for a migration candidate. Among files that meet the minimum age, and are the same size, HSM for Windows client migrates only the oldest files.

Small files are also not good candidates for migration because migrating a small file frees up less space than migrating a large file. There is a transaction cost for every file migration and recall. The transaction cost is the same regardless of file size, even though migrating larger files frees up more space. Hence, HSM for Windows client chooses large files for migration candidates. You can configure the minimum size for a migration candidate, but among files with the same age, HSM for Windows client migrates only the largest files.

You can also configure the weight (importance) of age, relative to size, for migration candidates. For example, assume that your volume contains some large files that tend to be dynamic. You can decrease the weight of file size for migration candidates.

To find the migration candidates, HSM for Windows client scans the volume. HSM for Windows client scans all directories in the volume in an orderly manner, but typically not all at once. A scan continues until enough migration candidates are found. The next scan starts where the previous scan finished, until, over time, the

entire volume can be scanned. Further scans traverse the volume again and again. You can configure how often to scan for migration candidates.

If not enough migration candidates are found, HSM for Windows client can scan the entire volume in a single scan. If the entire volume is scanned without yielding sufficient candidates, HSM for Windows client issues a warning. At the next scan, it is possible that the size or age of some files will qualify them for migration.

The size and age of the files in the most recent scan are compared with the files in the migration pool. The comparison yields a new ranked list of migration candidates. The oldest and largest files are the first on the list.

A scan begins in these situations:

- The configured time interval since the last scan elapses.
- You manually start a scan.
- Before a threshold migration, the pool does not contain enough files to reduce the space usage from the high threshold to the low threshold.
- During a threshold migration, the pool of migration candidates becomes empty.

Migration candidates are stored in a pool, ready to be migrated when space usage reaches the high threshold. Before a migration, there must be enough migration candidates in the pool to reduce the space usage from the high threshold to the low threshold.

The pool contains more files than are needed, in case some candidates are no longer valid by the time of the next threshold migration. A file in the pool can lose migration eligibility for several reasons:

- The file was deleted from the file system.
- The file was modified, and it no longer meets the minimum age or the minimum size for migration.
- The configured minimum age or minimum size for migration was increased.

Periodically HSM for Windows client validates the files in the pool. Files that are no longer valid are eliminated from the pool. If the pool does not contain enough files to reduce the space usage from the high threshold to the low threshold, a scan begins. You can configure the frequency of the validation.

Migration triggers

Migration is automatically triggered when the HSM for Windows client detects that space usage reaches the high threshold. You can also start threshold migration manually, any time that space usage is greater than the low threshold.

The IBM TSM HSM Monitor Service monitors space usage on an interval that you configure. Migration is triggered when the IBM TSM HSM Monitor Service detects a high threshold of space usage, and continues until usage reaches the low threshold. The HSM for Windows client can decrease the interval when space usage approaches the high threshold. Nevertheless, if space usage increases rapidly and is not checked frequently enough, it is possible that space usage can exceed the high threshold before migration begins.

Configuring threshold migration

You can configure threshold migration with the graphical user interface (GUI). Files are automatically migrated from the volume when space usage reaches the configured threshold.

About this task

Complete the following steps to configure threshold migration by using the HSM for Windows client GUI.

Tip: You can also configure threshold migration by using the `dsmhsmc1c` command.

Note: Threshold migration requires free disk space to store the names of migration candidates. The space that is required depends on the number of migration candidates and length of the file names. If the files have long file names, about 10 MB of free disk space is required for every 5000 migration candidates. For short file names, less space is required.

Procedure

1. Start the HSM for Windows client GUI. Select **Tools > Threshold Migration**. The Threshold Migration settings window opens. If the volume is configured for threshold migration, the current configuration values are displayed in the fields.
2. Choose values for the threshold migration options and then click **OK**. The following threshold migration options and controls are available:

Mount path

Specify the volume mount path. Because it is possible for a single volume to be mounted by more than one path, always specify that volume by the same mount path. Reconciliation, threshold migration, and migration jobs must all reference the volume by the same path.

The icon indicates the status of the volume:

- Not configured:



- Configured:



- Not configurable:



The volume of this mount path is already configured through another mount path and cannot be configured through the path now selected.

Status

The field displays the current configuration status of the selected volume and whether a migration, scan, or validation process is running. Click **Refresh** to refresh the status.

Configure/Unconfigure button

When the volume is not configured, the button displays **Configure**. Click this button to activate the fields and controls in the window, and populate the fields with default values.

When the volume is configured, the button displays **Unconfigure**. Click this button to remove the configuration of the volume.

Management class

Use this option to configure the management class that is used for threshold migration of this volume. Specify an existing management class with an archive copy group, or specify **DEFAULT** to use the default management class of the active policy set. If the retention period of the selected management class is finite, a warning is issued.

Low threshold (%)

Use this option to configure the disk usage that triggers when to stop threshold migration. After the disk usage reaches this percent of capacity, threshold migration stops. The low threshold must be less than the high threshold. The range of acceptable values is 0 - 99. The default is 80.

High threshold (%)

Use this option to configure the disk usage that triggers when to start threshold migration. After the disk capacity reaches this percent of capacity, threshold migration begins. The range of acceptable values is 1 - 100. The default is 90.

Migrate to file space

Use this option to configure the file space that is used for threshold migration.

Back up files before migration

Use this option to configure whether a file must be backed up before it is migrated. The default is the value that you set in the initial configuration wizard.

Migrate file security (ACL) when a file is migrated

Use this option to configure whether file security attributes are migrated when the file is migrated. The default is the value that you set in the initial configuration wizard.

Migrate alternate data streams (ADS) when a file is migrated

Use this option to configure whether Windows alternate data streams data is migrated when the file is migrated. The default is the value that you set in the initial configuration wizard.

Select a Tivoli Storage Manager options file for backup before migration

Use this option to specify the options file for backup before migration.

Space usage monitor interval (minutes)

Use this option to configure how frequently the HSM monitor service checks space usage on the disk. The time is measured in minutes. If the monitor interval is set to 0, monitoring is deactivated. The range of acceptable values is 0 - 9999. The default is 5.

Migration candidates scanning interval (hours)

Use this option to configure how frequently the HSM monitor service starts the file system scan to find candidates. The time is measured from the end of the last scan to the beginning of the next scan. The time is measured in hours. The range of acceptable values is 1 - 9999. The default is 24.

If a scan yields better quality candidates (older and larger files) than the previous scan, the interval is automatically decreased by a small amount. If a scan yields poorer quality candidates (newer and smaller files) than the previous scan, the interval is automatically increased by a small amount.

Migration candidates validation interval (minutes)

Use this option to configure how frequently the HSM monitor service validates the candidates in the candidates pool. The time is measured from the end of the last validation to the beginning of the next validation. The time is measured in minutes. If the interval is set to zero, validation is deactivated. The range of acceptable values is 0 - 9999. The default is 180.

Migrate now

Use this option to configure an immediate threshold migration. If disk usage is greater than the low threshold, files are migrated until the low threshold is reached. The default is no.

Scan now

Use this option to configure an immediate scan of the volume. The default is no.

Minimum file size (KB)

Use this option to configure minimum file size for a valid migration candidate. The size is measured in kilobytes (KB). The range of acceptable values is 4 - 2147483647 (2 TB). The default is 4.

Minimum file age (days)

Use this option to configure minimum file age for a valid migration candidate. The age is measured in days. The range of acceptable values is 0 - 99999. The default is 360.

File age criteria

Use this option to configure which time stamp is used to calculate the age of a file. Changing this option can make many files in the current pool of migration candidates no longer valid. The choices correspond to the file system time stamps for file creation, file modification, and file access.

Weighting of age criteria (%)

Use this option to configure the importance of file age (relative to file size) when determining migration candidates.

The age weight and size weight of a file are computed relative to the configured minimum age and minimum size. Hence, a file that is twice as old as the minimum age has an age weight of 2. If the file is the minimum size, it has a size weight of 1.

When the importance of age relative to size is considered, the file's weight is computed in this way: $\text{computed weight} = (\text{AGEWeight} * (\text{age weight})) + ((1-\text{AGEWeight}) * (\text{size weight}))$.

For example, when $\text{AGEWeight} = 50$, the file has the same weight $((.5*2)) + ((1-.5)*(1)) = 1.5$ as a file that is only as old as the minimum age, but twice as big as the minimum size $((.5*(1)) + (.5*(2)) = 1.5$). The weight of both files is 1.5.

If the AGEWeight option is not 50%, but 75%, the first file has a computed weight of 1.75 $((.75*2)) + ((1-.75)*(1)) = 1.75$, while for the younger but larger file, the computed weight is 1.25 $((.75*(1)) + ((1-.75)*(2)) = 1.25$).

Specify a value from 0 to 100. The default is 50.

Maximum number of parallel threshold processes

Use this option to configure the number of migration tasks that can occur simultaneously. The option applies to migration, scan, and validation tasks on all volumes. If this number is reached, any pending migration tasks are delayed until one of the running tasks finishes. The range of acceptable values is 1 - 16. The default is 3.

Cleanup

When one or more configured volumes are no longer available, the **Cleanup** button is activated. Click this button to erase the configuration information for each of these volumes.

Refresh

Click **Refresh** to show the latest values. For example, if you added a file space since opening the window, click **Refresh** to show the current file spaces.

Apply

Click **Apply** to apply the configuration to the volume and leave the window open. Use **Apply** to reuse configuration setting when you configure several volumes.

OK

Click **OK** to apply the configuration to the volume and close the window.

Related reference:

"Managing threshold migration with **dsmhsmc1c.exe**" on page 108

Space management of the system volume

You can run migration jobs and list migrations on the Windows system volume. Do not configure threshold migration on the Windows system volume.

Attention: In threshold migration, files are migrated based on age and size. You cannot ensure that critical system files are not migrated. If you configure threshold migration on the system volume, it is possible that some critical files will be migrated. It is possible that the computer will become unusable or will not start.

If you run migration jobs or list migrations on the system volume, do not migrate critical system files.

Selectively retrieving and recalling migrated files

You can return selected migrated files to the originating file system. You do not have to wait for a file to be automatically recalled.

About this task

A file is recalled automatically when you or a Windows application accesses the stub file. You can manually return a migrated file to the file system by using the information on the Tivoli Storage Manager server or the information in stub files.

You retrieve migrated files by using the information in the Tivoli Storage Manager file spaces. If a migrated file exists in Tivoli Storage Manager storage, you can retrieve the file.

You recall migrated files by using the information in stub files on the file system. If a stub file exists on the file system, you can recall the file.

Restriction: You cannot use the Tivoli Storage Manager backup-archive client to retrieve files that were migrated by the HSM for Windows client.

Retrieving migrated files

Search the Tivoli Storage Manager server file spaces to retrieve selected files.

About this task

If you configured the HSM for Windows client to keep or delete the original file on the file system, there is no stub. The migrated file is not automatically recalled when the resident file is accessed on the file system. You can access the migrated copies on the Tivoli Storage Manager server only by retrieving the files.

Tip: You can also use the HSM for Windows client `dsmc1c retrieve` command to retrieve migrated files.

Complete the following steps to search for and retrieve migrated files.

Procedure

1. Open the HSM for Windows client GUI.
2. Select **Migrate Retrieve > Search & Retrieve**.
3. Select values for the **TSM server** and **File Space** fields in which you want to search for files.
4. Specify your search criteria and click **Search**.

You must specify the name of the migrated file in the Tivoli Storage Manager file space. If you renamed the stub file on the file system, the stub file name does not match the name of migrated file in the Tivoli Storage Manager file space.

If you do not specify at least one search criterion, all of the files that are stored in the file space are shown. The **Path** and **Filename** fields are case-sensitive, but the **Volume** field is not case-sensitive. You can use wildcards in any field. An asterisk (*) matches zero or more characters, and a question mark (?) matches a single character. The **Search Results** window opens.

5. Click **Select All** to retrieve all files or select individual files and then click **Retrieve**. The **Retrieve options** window opens.

6. Optional: Choose a version to retrieve. If you selected only one file, you can choose which version to retrieve. If you selected more than one file, the **Version** option is not available.
7. Optional: Indicate whether security information is retrieved. If any of the selected files were migrated with security information, you can retrieve security information when the file is retrieved. If none of the selected files were migrated with security information, the security option is not available. If the security information is not retrieved, the retrieved file inherits the default security attributes of the file system to which it is retrieved.
8. Optional: Indicate whether Windows alternate data stream (ADS) data is retrieved. If any of the selected files were migrated with ADS data, you can retrieve ADS data when the file is retrieved. If none of the selected files were migrated with ADS data, the option is not available.
9. Choose an option for overwriting files on the file system.
10. Click **Retrieve** to retrieve the selected files.

Related tasks:

“Selectively recalling migrated files”

Related reference:

“**dsmc1c retrieve**” on page 97

Selectively recalling migrated files

You can search a file system and selectively recall migrated files.

About this task

You can selectively recall only files that were replaced with stubs when they were migrated. You must recall files with an HSM for Windows client command. You cannot recall files with the HSM for Windows client GUI.

Restriction: When selectively recalling a file, you can recall only the primary data stream data. You cannot selectively recall the Windows alternate data stream (ADS) data.

Procedure

From a DOS prompt, enter the HSM for Windows client **dsmc1c** command. Use the **dsmc1c recall** command to specify a single file path or a pattern with wildcards. Use the **dsmc1c recalllist** command to specify a file that contains a list of stub files. For example, to recall all migrated .xls files in the c:\projects\2013\ directory, issue the following command:

```
dsmc1c recall c:\projects\2013\*.xls
```

Related tasks:

“Retrieving migrated files” on page 52

Related reference:

“**dsmc1c recall**” on page 90

“**dsmc1c recalllist**” on page 93

Automatic backup before migration

To protect your data completely, you must back up your data. The backup-before-migrate feature ensures that there exists a backup copy for every file that you migrate.

You can select whether the backup-before-migrate feature is used as the default option for all new migration jobs and threshold migrations. Use the Backup before migration window in the HSM for Windows client configuration wizard. In each job or threshold migration, you can accept that default or you can specify another option. For every job and threshold migration, you can choose whether to back up files before migration, and which options file to use for the backup. The backup-archive client automatically backs up the necessary files before migration. If the backup is successful, the file is migrated.

By default, the backup-archive client changes the access time stamp of a file when the backup-archive client backs up a file. If a migration job or threshold migration is configured to check a file's access time (-minagetype access), the file might not be migrated after a recent backup operation. Use the preserve`lastaccessdate` option of the backup-archive client to specify whether a backup operation changes the access time stamp.

Even if you schedule regular backups, a file can change and be migrated before a backup operation runs. At the next backup operation, the backup-archive client gets a copy of the migrated file. The migrated file is copied to the staging directory and is backed up. To avoid the file copies during a backup operation, use the backup-before-migrate feature and use the same backup options that are used for the scheduled backup.

The HSM for Windows client backup-before-migrate feature is not a substitute for regularly backing up your files. When you use the backup-before-migrate feature, the HSM for Windows client does not back up files in several cases:

- The HSM for Windows client does not back up stub files.
- The HSM for Windows client does not back up files that do not meet the migration criteria.
- The HSM for Windows client does not back up a file if there exists a current backup copy of the file.

Restriction: The path name length limits differ for migrated files and for files that are backed up before migration. When you back up files before migration, the file name is subject to the limitations of the backup-archive client. When you migrate a file, the file name is subject to the limitations of the API.

Related concepts:

“Options for controlling backup of migrated files” on page 57

 API: Determining size limits (http://www.ibm.com/support/knowledgecenter/SSGSG7_7.1.2/com.ibm.itsm.client.develop.doc/c_size_lmts.html)

 Backup-Archive Client: File specification syntax (http://www.ibm.com/support/knowledgecenter/SSGSG7_7.1.2/com.ibm.itsm.client.doc/c_cmd_filesyntax.html)

Related tasks:

“Creating migration jobs” on page 38

Related reference:

 Backup-Archive Client: preservelastaccessdate command (http://www.ibm.com/support/knowledgecenter/SSGSG7_7.1.2/com.ibm.itm.client.doc/r_opt_preservelastaccessdate.html)

Choosing a backup options file

When files are backed up before migration, you can specify a backup options file, or you can let the backup-archive client determine the options file.

If you do not specify a backup options file for a backup before migration, the backup-archive client will determine the options file. The backup-archive client uses four methods to find an options file. The precedence of the methods is as follows:

1. An options file in a path specified by an environment variable
2. An options file in the directory from which the backup-archive client is invoked
3. An options file in the backup-archive client installation directory

If a file is regularly backed up with the backup-archive client default options file, then backing it up before migration with the backup-archive client default options file maintains a consistent set of backups. However, if a file is regularly backed up with an options file other than the default, you can specify this other options file for backups before migration. Using one options file for regular backups and a different options file for backups before migration can result in backup copies of the same file on two different Tivoli Storage Manager servers.

If you specify a backup options file during the initial configuration of the HSM for Windows client, that options file is the default for all backups before migration. The backup-archive client does not determine the options file. You can specify different options files when you configure migration jobs and threshold migration. You can also specify a backup options file when you start migration using a HSM for Windows client command on the Command Prompt window.

Related tasks:

“Creating migration jobs” on page 38

“Configuring threshold migration” on page 48

Related reference:

“`dsmc1c.exe`” on page 75

“Managing threshold migration with `dsmhsmc1c.exe`” on page 108

Backup and restore of migrated files

Some types of backup can back up a stub or a complete migrated file. Six backup-archive client options control the backup and restore of migrated files.

The backup-archive client and the HSM for Windows client work together. The backup-archive client always maintains a copy of the resident file in the backup pool, whether this file is migrated or not. In other words, for migrated files there are two identical versions of the file on the Tivoli Storage Manager server. One version is in the HSM pool, created by the HSM for Windows client. And one version is the backup copy in the backup pool, created by the backup-archive client. When you restore files, the backup-archive client can always re-create the resident file from the backup copy, even if the copy in the HSM pool was deleted.

The **Skip migrated files** option and the **Check stub file reparse content** option regulate the backup of stub files. The two restore options, **Restore as migrated file**,

and **Restore resident if not accessible**, define how migrated files are restored. The **Reset modified last access date** option determines whether the access time is changed when a file is backed up. The access time can affect migration. The **Staging Directory** option controls where copies of migrated files are temporarily stored by the backup-archive client.

There are some limitations for backing up migrated files:

- You must not use adaptive subfile backup and HSM. You must back up only the entire migrated file. If you use adaptive subfile backup on migrated files, you might not be able to restore migrated files correctly. The backup-archive client does not report any errors or warnings when you do a subfile backup of a migrated file.
- If `skipmigrated=yes`, the backup operation skips the migrated file. The stub is not backed up and the complete file is not backed up.
- If `skipmigrated=no` (the default), some backup types can back up the stub or the complete file. A backup has the following results:

Incremental backup or image backup

Only an incremental backup or image backup can back up a stub. The object that is backed up depends on whether the Tivoli Storage Manager server contains a current backup copy of the complete file.

If the Tivoli Storage Manager server contains a current backup copy of the complete file:

An incremental or image backup backs up the stub.

If the Tivoli Storage Manager server does not contain a current backup copy of the complete file:

An incremental or image backup backs up the complete file.

Incremental-by-date backup

An incremental-by-date backup does not back up the stub or the complete file.

Selective backup or archive

Selective backup or archive does not back up a stub. The complete file is backed up regardless of whether a current backup copy exists on the Tivoli Storage Manager server.

Set the backup and restore options for migrated files in the backup-archive client options file **dsm.opt**. Use the preferences editor or directly edit the backup-archive `dsm.opt` options file. You can also specify an option when you start a backup-archive client command in a Command Prompt window.

Related concepts:

“Options for controlling backup of migrated files” on page 57

“Tivoli Storage Manager backup-archive client options for restoring migrated files” on page 60

Related reference:

“Automatic backup before migration” on page 54

 Server: Managing client option files (https://www.ibm.com/support/knowledgecenter/SSGSG7_7.1.1/com.ibm.itsm.srv.doc/r_mgclinod_manageoptfiles.html)

Options for controlling backup of migrated files

Several options control how the Tivoli Storage Manager backup-archive client backs up migrated files. A backup can skip migrated files, compare stub content, and use a temporary directory that you specify.

skipmigrated

When the **skipmigrated** option is set to yes, the backup-archive client does not back up or archive any stub files.

If the **skipmigrated** option is set to no, the backup-archive client can back up stub files during an incremental backup. The default value of the **skipmigrated** option is no.

checkreparsecontent

The value of **checkreparsecontent** is applied only when you specify the option **skipmigrated=no**. If you specify the option **checkreparsecontent=yes**, the backup-archive client compares reparse point content of the local stub file with the content in Tivoli Storage Manager storage. If the content is the same, the stub file is not backed up again. If the local reparse point content is different from the backed-up content, the local stub file is backed up.

If you specify the option **checkreparsecontent=no**, the backup-archive client does not compare the reparse point content of the local stub file with the content in Tivoli Storage Manager storage. Differences in the reparse point content are not detected, and no backup is created as a result of the reparse point comparison. If a valid stub file does not exist on the Tivoli Storage Manager, you cannot restore a file as a stub file. In this case, you can restore a complete file instead of a stub file.

The **checkreparsecontent** option is one condition that can result in a file backup. Other conditions such as changes in file size or security settings are evaluated independently and can also result in a backup.

The reparse point of stub files that were backed up with the HSM for Windows client version 6.1 and earlier does not contain the same information as stub files that were backed up with later versions of the HSM for Windows client. As a result, all version 6.1 and earlier reparse points appear changed to later versions of the backup-archive client. If you set the option **checkreparsecontent=yes** and **skipmigrated=no**, the first incremental backup with a later-version backup-archive client creates new backup copies of all version 6.1 and earlier stub files. The new backups in Tivoli Storage Manager storage contain the later-version reparse point information. Subsequent incremental backups create new backup copies of stub files only if the reparse point indicates that the file was changed.

When you set this option, Tivoli Storage Manager checks the reparse point content of the local stub file, which increases the time for a backup operation. Set this option on the first time that you do an incremental backup after either of the following events:

- You move migrated files with the **dsmmove.exe** command.
- You change the file space that is used for migration.

Clear this option on subsequent backups.

Table 7. Interaction of options **skipmigrated** and **checkreparsecontent** during incremental backup

	skipmigrated=yes	skipmigrated=no
checkreparsecontent=no	A stub file is not backed up.	A stub file is not backed up if only the reparse-point content changed. A stub file can be backed up if other changes occurred.
checkreparsecontent=yes	A stub file is not backed up.	Reparse point content of the local stub file is compared with content in Tivoli Storage Manager storage. A local stub file is backed up if the content does not match. Also, a stub file can be backed up if other changes occurred.

stagingdirectory

The backup-archive client ensures that whenever a stub is backed up, there is a copy of the complete file in the backup pool. If a complete file was not backed up before migration, the migrated copy is temporarily copied back and is backed up. Tivoli Storage Manager associates the backup copy of the complete file with the backup copy of the stub. After the complete file is backed up, the temporary file is removed by the backup-archive client. You can control the location to which the backup-archive client copies the temporary file by using the **stagingdirectory** option of the backup-archive client. When you use a staging directory for the temporary copy, the stub is not changed. The next backup creates a backup copy of the stub file on the Tivoli Storage Manager server in the backup pool.

If the backup-archive client cannot create a complete backup copy of the migrated file, the backup-archive client does not back up the stub file. For example, if the stub is an orphan with no migrated copy in Tivoli Storage Manager storage, the stub is not backed up.

Tivoli Storage Manager maintains a backup copy of both the complete file and the stub. The backup copy of the complete file does not expire until the backup copy of the stub expires. Either the complete file or the stub can be re-created by using the backup-archive client.

If you set **skipmigrated** no, files that were not backed up before migration are copied to the staging directory when they are backed up. Many files are copied during a backup in the following situations:

- You have many stubs that were backed up with backup-archive client version 5.4 and earlier versions. The files are temporarily copied to the staging directory during backups with backup-archive client version 6.1 and later.
- You changed the backup policies for a volume by including for backup many files that were not previously included.
- You renamed stubs or directories that contain stubs.
- You changed the security settings of stubs or directories that contain stubs, and you configured migration of security attributes.

Related concepts:

“Tivoli Storage Manager backup-archive client options for restoring migrated files” on page 60

Related tasks:

“Managing backup performance when stub file encryption changes”

“Backing up migrated files separately from resident files” on page 60

Related reference:

 Backup-Archive Client: preservelastaccessdate command (http://www.ibm.com/support/knowledgecenter/SSGSG7_7.1.2/com.ibm.itsm.client.doc/r_opt_preservelastaccessdate.html)

 Backup-Archive Client: stagingdirectory command (http://www.ibm.com/support/knowledgecenter/SSGSG7_7.1.2/com.ibm.itsm.client.doc/r_opt_stagingdirectory.html)

Managing backup performance when stub file encryption changes

You can limit the impact to backup performance that is caused by changing the encryption of stub files. Stage the encryption changes and backup operations.

About this task

If you change the encryption of a stub file, the Tivoli Storage Manager backup-archive client copies the migrated file to a staging directory during the next incremental backup operation. If you change the encryption of many files, the backup operation can take a long time for the many temporary file copies.

To avoid temporarily copying many files, set the encryption status of files before you back up the resident files.

If you must change the encryption of an HSM-managed volume, you can stage the encryption change and the backup operation.

Tip: Another option is to first change the encryption of all the files. Then, back up migrated files separately from resident files.

Procedure

1. Change the encryption of the files in one directory of a volume.
2. Run an incremental backup of the changed files in the directory. Stub files with a modified encryption status are temporarily copied and backed up.
3. Repeat steps 1 and 2 for each directory in the volume.

Related tasks:

“Backing up migrated files separately from resident files” on page 60

Backing up migrated files separately from resident files

In some cases, you can limit the impact to backup performance by backing up migrated files separately from resident files.

About this task

The backup-archive client must temporarily copy a migrated file during an incremental backup operation if there is no backup copy, or if the stub file encryption changed. The temporary copies of migrated files can affect the performance of a backup operation. You can limit the impact to performance by backing up migrated files separately from resident files. Use the `skipmigrated` option to exclude migrated files from a backup operation.

When the `skipmigrated` option is set `yes`, the backup-archive client skips migrated files. Permanently skipping the backup of migrated files can prevent you from recovering your data in a disaster. Temporarily skipping migrated files can reduce the time that is required for backup operations.

You can complete backup operations in a reasonable time and protect all your files if you run two types of backup operations. Run one backup operation only on resident files and run one backup operation on all files (resident and migrated files). The two backup operations protect all files.

Procedure

1. For your regular backup operations, set `skipmigrated=yes`. Migrated files are excluded from regular backup operations. The following backup-archive client command runs an incremental backup that skips migrated files:

```
dsmc inc N:\budgets\ -skipmigrated=yes
```
2. Run another backup operation with `skipmigrated=no`. Files that are excluded from your regular backup operation are included. The backup operation makes temporary copies of the migrated files and can take a long time.
3. When the backup in 2 is complete, set `skipmigrated=no` for your regular backup operations. The quantity of migrated files that must be temporarily copied is reduced from 2. All files (resident and migrated) are backed up in your regular backup operations.

Results

All files are backed up. Each backup operation completes in a reasonable time.

Tivoli Storage Manager backup-archive client options for restoring migrated files

Use the **Restore as migrated file** (`restoremigstate`) and **Restore resident if not accessible** (`restorecheckstubaccess`) backup-archive client options to manage how the backup-archive client restores migrated files from Tivoli Storage Manager storage.

For files that are backed up with the backup-archive client, there is a backup copy of a resident file for every corresponding stub file. With the backup-archive client, you can restore the stub file or the resident file.

There are times when the Tivoli Storage Manager HSM pool does not contain a copy of the migrated file, as shown in the following scenario:

1. A resident file is migrated to the Tivoli Storage Manager HSM pool. A stub file remains on the volume.
2. The stub file is backed up. There is a backup copy of the stub file and a backup copy of the resident file in the Tivoli Storage Manager backup pool.
3. The stub file is deleted from the volume.
4. During reconciliation, the migration copy in the Tivoli Storage Manager HSM pool is deleted.

In this case, restoring the stub file can lead to problems because the HSM for Windows client cannot recall the migration copy of the file. If there is no migration copy in Tivoli Storage Manager HSM pool, it would be better to restore the resident file rather than restore the stub. The backup-archive client can check whether a migration copy exists before restoring a stub file. If a migration copy does not exist, the backup-archive client can automatically restore the resident file instead of the stub file.

The **Restore resident if not accessible** (`restorecheckstubaccess`) and **Restore as migrated file** (`restoremigstate`) options configure how migrated files are restored by the backup-archive client. The options yield the restore results that are described in Table 8

Table 8. Results of using `restoremigstate` and `restorecheckstubaccess` options.. This table shows the results of using `restoremigstate` and `restorecheckstubaccess` options.

restorecheckstubaccess value	restoremigstate=no	restoremigstate=yes (the default)
<code>restorecheckstubaccess=no</code>	Restore the resident file; do not restore the stub	Restore the stub. Do not check whether a migration copy exists.
<code>restorecheckstubaccess=yes</code> (the default)	Restore the resident file; do not restore the stub	If a migration copy exists in the HSM pool, restore the stub. If a migration copy does not exist in the HSM pool, restore the resident file from the backup copy pool.

In addition to the preceding options settings, the following conditions must also be true to restore a stub:

- The file was migrated at the time of the last backup
- The HSM for Windows client is installed
- The stub backup copy is an active version backup.
- The original file system and the target file system are of the same type (NTFS)
- The stub is restored to the same path, and the file space name matches the volume name

There are some advantages to restoring a stub without checking that a migration copy exists in the HSM pool:

- Less temporary space is needed during restore
- There is less network traffic during a restore
- The restore is faster

There is a disadvantage to restoring a stub without checking that a migration copy exists in the HSM pool. There might be no migration copy in the HSM pool. If you

restore a stub for which there is no migration copy, you create a stub file orphan. However, you can use reconciliation to report the stubs that are orphans. Then, you can restore the resident files from the backup pool with the option `restoremigstate=no`. If you run reconciliation in emulation mode, the HSM for Windows client creates a list of orphan stubs, but does not delete any files from Tivoli Storage Manager storage.

In the following examples, `N:\file.txt` was migrated, and a stub file remained on the volume. The stub file was backed up with the backup-archive client. Both the stub file and the resident file are available to the backup-archive client. The migrated file is restored by the backup-archive client with the **restore** command.

Task Restore the resident file `N:\file.txt`.

Command: `dsmc rest N:\file.txt -restoremigstate=no`

Task Restore a stub file `N:\file.txt`, regardless of whether a migration copy exists in Tivoli Storage Manager HSM pool.

Command: `dsmc rest N:\file.txt -restoremigstate=yes
-restorecheckstubaccess=no`

Task Restore a stub file `N:\file.txt`, if a migration copy exists in Tivoli Storage Manager HSM pool. If a migration copy does not exist in Tivoli Storage Manager HSM pool, restore the resident file.

Command: `dsmc rest N:\file.txt`

Because the default option values are `-restoremigstate=yes` and `-restorecheckstubaccess=yes`, it is not necessary to specify the options.

Restriction:

- If the HSM for Windows client is not installed, or if the IBM TSM HSM Recall Service is not running, default security attributes are applied to restored files.
- If a backup-archive client restore process is stopped in an unusual way (for example by pressing Ctrl+C or by restarting your system), files might remain in a temporary subdirectory (`\^tsmtemp\`) in the volume root. In this case, you must manually delete the `\^tsmtemp\` directory.

Related concepts:

“Backup and restore of migrated files” on page 55

Related reference:

“Managing reconciliation with `dsmhsmc1c.exe`” on page 103

Reconciliation

Reconciliation synchronizes your file system with the Tivoli Storage Manager server by logging orphan stubs and by deleting obsolete copies of files.

You can use the HSM for Windows client graphical user interface (GUI) and the `dsmhsmc1c.exe` command to both configure and start reconciliation. You can start reconciliation at any time and can define reconciliation to run automatically in defined intervals.

The two main advantages of reconciliation are to reduce costs and to maintain integrity of your file systems. Reconciliation can reduce your costs by removing unnecessary or obsolete migrated objects from the Tivoli Storage Manager server storage. With fewer files, you require less storage. You also require fewer licenses

because the HSM for Windows client is volume-licensed based on the amount of storage space that is used for migrated data on the Tivoli Storage Manager server.

The HSM for Windows client helps you maintain the integrity of your file systems by finding orphan stubs. Orphan stubs are stubs for which there is no migrated copy in Tivoli Storage Manager storage. Those orphans are recorded in the `hsmmonitor-orphan.log`. When you check the log file, you decide whether you want to delete the orphan stub or restore the stub from a backup.

If the reconciliation process finds any orphan stubs, the reconciliation process does not delete any object from Tivoli Storage Manager storage until all orphans are resolved. Resolve orphan stubs either by deleting the stub from the volume or restoring the complete file backup version.

If you delete a file but do not empty the Recycle Bin, the reconciliation process finds the file in the recycle bin. The reconciliation process does not delete the migrated copy from Tivoli Storage Manager storage.

Reconciliation deletes objects on the Tivoli Storage Manager server. For maximum data protection, back up all migrated files before you start reconciliation.

An object is deleted only after two reconciliation processes are run. After a stub is deleted, the first reconciliation marks the object on the Tivoli Storage Manager server. If the stub is not restored before the second reconciliation, the object is deleted from Tivoli Storage Manager server storage. If the stub is restored after the first reconciliation, the object is unmarked on the Tivoli Storage Manager server and is no longer a candidate for deletion.

In previous versions, the reconciliation log file listed files that are deleted during reconciliation. In the current version, the reconciliation log file also lists objects that are marked or unmarked during reconciliation.

Reconciliation supports files that are migrated and replaced with stubs on the file system. Reconciliation is not intended for file spaces or volumes with migration jobs that have the action **Keep the original file** or **Delete the file**.

If files were migrated before a file system image backup was created, the file system image backup can contain stub files. After the image backup, the files can be recalled, and reconciliation can expire migration copies on the Tivoli Storage Manager server. When you restore the file system image, there can be stub files for which there are no corresponding migration copies on the Tivoli Storage Manager server. In this case, you can restore an orphaned stub with the backup copy of the file that was created before the file was migrated.

If files were migrated after a file system image backup was created, the Tivoli Storage Manager server can contain migration copies for which there are no stub files. You can restore the stub files after the file system image restore. Restore the stubs before you run reconciliation. If you run reconciliation before you restore the stub files, the migration copies are deleted from the Tivoli Storage Manager server. Restoring stubs after the migration copies are deleted from the Tivoli Storage Manager server leaves orphan stubs on the file system.

A reconciliation process logs the actions that are taken against the objects on the Tivoli Storage Manager server. The log file is in the directory that is specified in the HSM GUI in the **Tracing Preferences** menu. The file name is

hsmmonitor-delete-YYYYMMDD-hhmmss.log, where YYYYMMDD indicates the date and hhmmss indicates the time when the HSM monitor service was started.

If you run the reconciliation process in emulation mode (**reconcilemode=emulation**), the log file shows what actions would be taken in normal mode.

If the reconciliation process is run in normal mode (**reconcilemode=normal**), the list file contains the name of the obsolete objects. The objects are deleted by the reconciliation process. Normal mode is the default.

Reconciliation uses the name of the volume and the name of the nested volumes to identify files that do not belong to the file system.

If you rename a volume after migrating files, you must create a hardware volume mapping. If you do not create a hardware volume mapping, the reconciliation process can erroneously assume that the files were deleted from the file server. The reconciliation process can delete the files from the Tivoli Storage Manager server. If this situation occurs, use the backup-archive client to restore the complete file space to the renamed volume.

Tip: To improve reconciliation performance and avoid restoring files with the backup-archive client, use separate file spaces for each file system.

Related concepts:

“Options for controlling backup of migrated files” on page 57

“Changed volume mount-paths”

“Continuing HSM services when a volume or file server is renamed” on page 70

Related tasks:

“Creating migration jobs” on page 38

Related reference:

“dsmhsmc1c.exe” on page 103

Changed volume mount-paths

If you change a volume mount point or drive letter or change the file server name, HSM for Windows reconciliation can be affected. You can mitigate many problems by creating hardware volume mappings, and prevent some problems by using unique file space names.

If you change a volume drive letter, mount point, or file server name, you can maintain HSM services by creating a hardware volume mapping. If you do not create a hardware volume mapping, reconciliation processing can delete migration copies in Tivoli Storage Manager storage. If the drive letter, mount point, or file server name does not match the information on the Tivoli Storage Manager server, a reconciliation process marks a migration copy as obsolete. The obsolete object is deleted from Tivoli Storage Manager storage, subject to retention policy. A hardware volume mapping matches the old drive letter, mount point, or file server name with the new drive letter, mount point, or file server name. With a hardware volume mapping, a reconciliation process does not delete migration copies only because the drive letter, mount point, or file server name is changed.

A hardware mapping maintains HSM services for some changes to nested volumes. If you change only the drive letter or file server name, a hardware

mapping continues HSM services. If you move a nested volume to another volume, a hardware mapping does not continue HSM services.

For example, assume that volume `\\MYNODE\E$\nested` is mounted into volume `\\MYNODE\E$`. Files are migrated from both volumes and reconciliation is configured for both volumes.

Assume that you change the drive E to F. Volume `\\MYNODE\E$` is renamed to `\\MYNODE\F$` and volume `\\MYNODE\E$\nested` is renamed to `\\MYNODE\F$\nested`. In this case, a hardware volume mapping continues HSM services, including accurate reconciliation.

Assume that you do not change drive letter E, but you move the nested volume into `\\MYNODE\G$`. The nested volume becomes `\\MYNODE\G$\nested`. In this case, a hardware volume mapping cannot maintain HSM services.

The second case can be mitigated with some planning. You can migrate the files of each volume to a separate file space on the Tivoli Storage Manager server. Reconciliation can then be limited to only this file space. In this case, the Tivoli Storage Manager server query, which is performed at the beginning of the reconciliation for a volume, does not return any objects from other volumes. The Tivoli Storage Manager server does not delete any objects in storage that are from other volumes.

Tip:

- You can manage which file spaces are used during reconciliation with the **FILESPacelist** option of the **dsmsmclc** command or by using the Reconcile settings window of the HSM for Windows client GUI.

If a reconciliation process deletes objects from Tivoli Storage Manager storage, you can restore the files from backup copies that were created by the backup-archive client. You can restore the complete file, even if the migration copy was deleted from Tivoli Storage Manager storage.

Related concepts:

“Tivoli Storage Manager backup-archive client options for restoring migrated files” on page 60

“Continuing HSM services when a volume or file server is renamed” on page 70

Configuring reconciliation with the graphical user interface

Configure reconciliation with the graphical user interface (GUI) with the Reconcile settings window.

About this task

Access the Reconcile settings window by selecting HSM for Windows client GUI. Select **Tools > Reconciliation**.

The Reconcile settings window displays configuration information. If the volume is not configured, the fields display default values. If the volume is configured, the fields display the current configuration.

Mount path

Specify the volume mount path. Because it is possible for a single volume to be mounted by more than one path, always specify that volume by the

same mount path. Reconciliation, threshold migration, and migration jobs must all reference the volume by the same path.

Status

The field displays the current configuration status of the selected volume and whether a reconciliation process is running. Click **Refresh** to refresh the status.

Configure/Unconfigure button

When the volume is not configured, the button displays **Configure**. Click this button to activate the fields and controls in the window, and populate the fields with default values.

When the volume is configured, the button displays **Unconfigure**. Click this button to remove the configuration of the volume.

Next reconcile

Use this option to change the time of the next reconciliation. The field displays the date and time of the next reconciliation. If reconciliation is not configured, the default is the current date and time. If reconciliation is configured, the field displays the date that is calculated by adding the **Reconcile interval (hours)** to the last reconciliation.

Reconcile interval (hours)

Use this option to configure the number of hours between reconciliations. The interval starts when a reconciliation ends. If this option is set to 0, automatic reconciliation is deactivated. The range of acceptable values is 0 - 876000. The default is 720 hours.

Reconcile now

Use this option to reconcile the volume immediately. This action does not affect the **Reconcile interval (hours)** or the **Next reconcile** date.

File spaces used to reconcile

Use this option to configure the file spaces that are used during reconciliation.

You can improve the reconciliation performance by restricting the list to the files spaces that contain migrated files of the volume that you are configuring.

Remote TSM Server Connections used for reconcile

Specify which remote Tivoli Storage Manager server connections are used for reconciliation. By default, no remote Tivoli Storage Manager server is included in reconciliation. If you select a remote Tivoli Storage Manager server, all file spaces of the remote Tivoli Storage Manager server connection are included in the reconciliation process.

If a file is recalled when in moving state, the migrated object is not automatically deleted on the remote Tivoli Storage Manager server. The migrated object remains on the remote Tivoli Storage Manager server until the remote Tivoli Storage Manager server is added to a reconciliation process, and the reconciliation process is run.

Maximum number of parallel reconcile processes

Use this option to configure the number of reconciliation tasks that can run at the same time. If this number is reached, any additional reconciliation tasks are delayed until the running reconciliation task finishes. Specify a value from 1 to 16. The default is 3.

Cleanup

When one or more configured volumes are no longer available, the **Cleanup** button is activated. Click this button to erase the configuration information for each of these volumes.

Refresh

Click **Refresh** to show the latest values. For example, if you added a file space since opening the window, click **Refresh** to show the current file spaces.

Apply

Click **Apply** to apply the configuration to the volume and leave the window open. Use **Apply** to reuse configuration setting when you configure several volumes.

OK

Click **OK** to apply the configuration to the volume and close the window.

Space requirements for reconciliation

Reconciliation uses Windows Volume Shadow Copy Service (VSS) to scan a volume. In addition to the VSS snapshot, VSS requires free disk space for the reconciled volume.

VSS requires space on the volume that is reconciled even if a snapshot is stored on another volume. VSS requires 200 KB of free disk space as a base requirement. Additionally, approximately 10 MB of disk space is required for every 100,000 objects on the reconciled file system.

VSS requires space for a snapshot. The snapshot can be on the reconciled volume or on another volume. Use the **vssadmin add shadowstorage** command to specify the volume for the snapshot. For information about the **vssadmin add shadowstorage** command, see *Vssadmin add shadowstorage* at the Microsoft technical notes library: technet.microsoft.com.

Moving migrated files

You can move migrated files to another volume on the same computer or to a volume on another file server.

You can move migrated files to accommodate the changing needs of users, applications, and hardware. For example, if a user moves to another site, you can move the migrated data. If a new or changed application requires that data is moved to another location, you can move the migrated files. You can maintain HSM services without recalling and migrating the files again.

If you do not plan the movement of migrated files, you can encounter several problems:

- Stub files can become inaccessible
- Many migrated files can be recalled, resulting in out-of-space conditions
- Tapes can be mounted several times

You can move stub files to another location with the **dsmove** command. If the new location is managed by a different Tivoli Storage Manager server, the HSM for Windows client moves migrated file data from the old to the new Tivoli Storage Manager server.

The computer from which stub files are moved away is called the *remote* file server. The stub files on the remote file server are remote stub files. The Tivoli Storage Manager server that manages the remote stub files is the remote Tivoli Storage Manager server.

The computer to which the stub files are moved is called the *local* file server. The stub files on the local file server are local stub files. The Tivoli Storage Manager server that manages the local stub files is the local Tivoli Storage Manager server.

Migrated data is automatically moved when stub files are moved

If you move stub files to a location that is managed by a different Tivoli Storage Manager server, the HSM for Windows client automatically moves the migrated data to the new server.

The **dsmove** command uses the **hsmtasks** service on the local computer to complete the following tasks:

- Move the migrated data from the remote Tivoli Storage Manager server to the local Tivoli Storage Manager server. Only the version of migrated data that corresponds to the moved stub file is moved. The data is copied directly from one Tivoli Storage Manager server to the other. No data is recalled to the file system.
- Remove the migrated data from the remote Tivoli Storage Manager server, subject to the constraints of the retention policy. Only the version of migrated data that corresponds to the moved stub file is removed. Other versions of migrated data remain on the remote Tivoli Storage Manager server. Other versions might belong to other stub files on the remote file server.
- Change the reparse content of the local stub file to point to the local Tivoli Storage Manager server.
- Remove the *moving* state flag from the reparse content of the local stub file.
- Write a list file to the *installation path*\listings directory. The file documents the movement of the migrated data between Tivoli Storage Manager servers.

If the remote file system and the local file system are managed by the same Tivoli Storage Manager server, the migrated data does not move to another Tivoli Storage Manager server.

Stub files in moving state

Stub files can be in moving state until the move is complete. There are restrictions for stub files in the moving state.

If the remote file system and the local file system are not managed by the same Tivoli Storage Manager server, the HSM for Windows client moves the migrated data to the local Tivoli Storage Manager server.

Until the migrated file data is moved to the local Tivoli Storage Manager server, the stubs are in *moving* state. The moving state is indicated by a flag in the reparse content of the local stub file.

The HSM for Windows client GUI indicates the status of the hsmtasks service.

When a migrated file is in moving state, you can search, retrieve, or delete it on the remote Tivoli Storage Manager server. You can include a remote Tivoli Storage Manager server for a reconciliation process.

If a remote stub file in moving state is recalled, retrieved, or renamed before it is moved, the stub cannot be moved. The HSM for Windows client creates a list of stubs that were not moved in the \tasks\error\ directory. Before you delete a connection to a remote server with the HSM for Windows client GUI, a warning message reminds you of the list.

A stub cannot be moved again while it is in the moving state, even if the move is on the same file server.

A stub in moving state depends on the current settings of the corresponding connection, which is stored in the dsm.opt options file in the HSM client installation directory. If you change any of the options in the dsm.opt options file, the stub in the moving state can no longer be accessed.

Moving stub files to another location

You can move stub files to another location. If the other location is managed by another HSM for Windows client or another Tivoli Storage Manager server, the migrated data on the Tivoli Storage Manager server is also moved.

Before you begin

You can move stub files to another location on the same file server and volume. You can move stub files to another volume on the same file server or on a different file server.

The location to which you move the stub files must be managed by a Tivoli Storage Manager server. The Tivoli Storage Manager server must provide HSM services for the location. You can move the stub files only to an NTFS file system.

The location from which you move the stub files must be managed by a Tivoli Storage Manager server. This Tivoli Storage Manager server is required until the move is complete.

All HSM for Windows clients that are involved in the move must be Tivoli Storage Manager Version 6.3 or later.

About this task

To move the stub files complete the following steps:

Procedure

1. Define the connection parameters for the remote Tivoli Storage Manager server. Use the HSM for Windows client that is running on the local file server.
If stub files are moved to a clustered system, you must configure a connection on each node of the cluster. Configuring a connection for each node ensures that stubs that are in *moving* state can be accessed after failover.
 - a. In the HSM for Windows client GUI, click **Menu > Tools > Remote TSM Servers**.

- b. Click **Create**. The remote connections wizard opens.
- c. From the remote connections wizard, enter the connection information in the wizard panels.

If stubs are moved from a clustered system, use the cluster name.

You must grant proxy authority to the remote node and use the **asnodename** option on the remote HSM nodes.

The remote connection wizard tests the connection. If the connection is successful, the HSM for Windows client creates a new options file in the `\config\` directory of the HSM for Windows client installation directory. The file name is constructed from the unique connection pair of server and node, and is file type `.opt`. An example configuration file name is `\config\server1-node1.opt`.

2. Move the stub files by using the **dsmmove** command. Run the **dsmmove** command on the local file server.

The **dsmmove** command moves the stub files to the local file system. If the local file system is managed by a different Tivoli Storage Manager server, the **dsmmove** command moves migrated data to the new server.

Related reference:

“**dsmc1c.exe**” on page 75

“Managing reconciliation with **dsmsmc1c.exe**” on page 103

“**dsmmove.exe**” on page 114

Continuing HSM services when a volume or file server is renamed

You can replace or rename the file server host and storage volumes. To continue HSM services, map the new volumes to the old volumes.

The HSM for Windows client uses the file server host name and drive letters. This information is used to identify the migrated object on the Tivoli Storage Manager server during recall processing. If you change the drive letter of a volume that contains migrated files, Tivoli Storage Manager cannot retrieve files. If you change the file-server host name or cluster name, Tivoli Storage Manager cannot recall or retrieve files. If you change the drive letter, host name, or cluster name, a reconciliation process might mark the migrated objects on the Tivoli Storage Manager as obsolete.

You must map the new volume to the old volume in the following situations:

- You rename the volume drive letter or mount point on a file server
- You replace the file server hardware or change the file server host name or cluster name

Renamed volume drive letters or mount points

You can map a volume drive letter. Any Universal Naming Convention (UNC) path within the mapped drive letter is automatically mapped. Volumes that are nested within the mapped drive letter are automatically mapped.

You cannot create a mapping for an individual nested volume. If you change the mount point of a nested volume, you cannot create a mapping for this individual mount point. You must create a mapping for the underlying drive letter. A mapping of the new drive letter to the old drive letter continues HSM services for some moves of nested volumes, but not for all moves. If you move a nested volume to another volume, a hardware mapping does not continue HSM services.

For example, assume that volume `\\MYNODE\E$\nested` is mounted into volume `\\MYNODE\E$`. Files are migrated from both volumes and reconciliation is configured for both volumes.

Assume that you change the drive E to F. Volume `\\MYNODE\E$` is renamed to `\\MYNODE\F$` and volume `\\MYNODE\E$\nested` is renamed to `\\MYNODE\F$\nested`. In this case, a hardware volume mapping continues HSM services, including accurate reconciliation.

Assume that you do not change drive letter E, but you move the nested volume into `\\MYNODE\G$`. The nested volume becomes `\\MYNODE\G$\nested`. In this case, a hardware volume mapping cannot maintain HSM services.

New file server hardware or a changed file server host name

If you replace or rename a file server, you can attach space-managed volumes from the original file server. To continue HSM services, you must map the volumes on the new system with the volumes on the original system.

Assume that an old file server is replaced by a new file server. The disk drives from the old file server are connected to the new file server. The new file server can have a different name, IP address, Tivoli Storage Manager node name, and drive letters for the disk drives. If you map the volumes on the new system with the volumes on the original system, you can continue HSM services.

Hardware volume mappings

Hardware volume mappings are stored on the Tivoli Storage Manager server in a private file space. The private file space requires a management class that does not expire objects. Changes to the Tivoli Storage Manager server can affect the hardware volume mappings in the following ways:

- When a Tivoli Storage Manager server database is restored, the mappings revert to the level of the restored database.
- If the Tivoli Storage Manager server is changed, you must export and import the data in the private file space.

If a management class that does not expire objects is not available, the hardware volume mapping cannot be saved on the Tivoli Storage Manager server. Not saving the mapping on the Tivoli Storage Manager server has the following consequences:

- Hardware volume mappings cannot be created.
- Hardware volume mappings cannot be changed.
- The hardware volume mappings cannot be automatically replicated to HSM for Windows clients on all nodes of a cluster.
- The hardware volume mapping is not applied when you search for files at a remote Tivoli Storage Manager server connection.

Mapping volumes

To continue HSM services when a volume or file server is renamed, you must create a hardware volume mapping.

About this task

Create a hardware volume mapping by using the following steps:

Procedure

1. In the HSM for Windows client GUI, click **Tools > Volume Mappings**. The Hardware Volume Mappings window lists all local volumes that are assigned a drive letter and all MSCS cluster volumes that are online.
If remote Tivoli Storage Manager server connections exist, you can see the hardware volume mappings that are defined on the remote HSM for Windows client. You can view the remote hardware volume mappings but not change them.
2. Select a volume and click **Create**.
3. Type the old host and volume information and click **OK**. The new mapping is displayed in the Hardware Volume Mapping Definition window. The mapping applies to all nested volumes on the selected drive.
4. After defining all hardware volume mappings, click **Close**. The Reconfirmation window displays all new mappings.
5. Optional: Test the mappings by clicking **Scan for Problems**. This test checks for files on the Tivoli Storage Manager server that is defined with the old mapping. The scan shows whether there are any migrated files at the old mapping. After the new mapping is applied, the migrated files at the old mapping are not accessible.
6. Click **Yes** to apply the changes. All HSM services receive notifications and apply the new mappings. HSM commands apply the new mappings the next time the commands are started.

Chapter 6. HSM for Windows commands

The HSM for Windows client has several commands that you can run from a Command Prompt window. With these commands, you can do most of the tasks that you can do with the GUI.

Table 9 summarizes the HSM commands.

Table 9. HSM for Windows client Command Prompt window commands

Command	Description
dsmc1c.exe	Use this command to run a migration job from the Command Prompt window. You can also list files and file spaces, and set the level of information that is saved in log, trace, and list files.
dsminfo.exe	Use this command to list various settings of your installation. List the version of libraries, actual log level settings, the operating system version, and disk information.
dsmfileinfo.exe	Use this command to list attributes of migrated and non-migrated files.
dsmfind.exe	Use this command to list files that are eligible by a job file or that correspond to a pattern.
dsmhsmc1c.exe	Use this command to manage reconciliation and threshold migration. You can also set the level of information that is saved in log, trace, and list files.
dsmmove.exe	Use this command to move stub files to another location. If the other location is managed by a different Tivoli Storage Manager server, the migrated file data is moved to the new Tivoli Storage Manager server.
dsmquota.exe	Use this command to display user and group quotas or to reset the quota recall counter for one or more users.
dsmtool.exe	Use this command to display the quantity, size, and expiration period of migrated objects in Tivoli Storage Manager storage.

Entering command parameters

Case sensitivity

Command options are not case-sensitive. You can type them in uppercase or lowercase.

Minimum abbreviation

In the syntax diagrams, the minimum abbreviation of a command option is printed in uppercase. For example, if the syntax diagram includes the option **-UNCONFIGUREReconcile**, the minimum abbreviation is **UNCONFIGURER**.

Restriction for running a command again

Wait for a command to finish before you enter that command again. If you enter a command when an instance of that command is running, you can get the following error message:

Could not open log file.
Exiting.

Command parameters override default and job settings

The parameter values that you enter with a command override the values that you set in a job file or by using the configuration wizard.

Client return codes

The HSM for Windows client command-line interface exits with return codes that reflect the success or failure of the operation.

Scripts, batch files, and other automation facilities can use the return code from the command-line interface. For operations that use the Tivoli Storage Manager scheduler, the return codes are shown in the output of the **QUERY EVENT** administrative command. For cases where the return code is not 0, you can examine the `dsmerror.log` file. For scheduled events, you can examine the `dsmsched.log` file.

Return codes have the following meanings:

Table 10. An explanation of client return codes

Code	Explanation
0	All operations completed successfully.
4	The operation completed successfully, but some files were not processed. There were no other errors or warnings. This return code is common. In most cases, files are not processed for the following reasons: <ul style="list-style-type: none">• The file satisfies an entry in an exclude list. Excluded files generate log entries only during selective backups.• The file was in use by another application and could not be accessed by the client.• The file changed during the operation to an extent prohibited by the copy serialization attribute.
8	The operation completed with at least one warning message. Review the <code>dsmerror.log</code> file to determine what warning messages were issued and to assess their effect on the operation.
12	The operation completed with at least one error message (except for error messages for skipped files). For scheduled events, the status is <code>Failed</code> . Review the <code>dsmerror.log</code> file to determine what error messages were issued and to assess their effect on the operation. Generally, this return code means that the error was severe enough to prevent the successful completion of the operation. For example, an error that prevents an entire file system from being processed yields return code 12.

The return code for a client macro is the highest return code issued among the individual commands that comprise the macro. For example, suppose that a macro consists of these commands:

```
selective "/home/devel/*" -subdir=yes  
incremental "/home/devel/TestDriver/*" -subdir=yes  
archive "/home/plan/proj1/*" -subdir=yes
```

If the first command completed with return code 0; the second command completed with return code 8; and the third command completed with return code 4, the return code for the macro is 8.

For information about the **QUERY EVENT** command, see Query event (www.ibm.com/support/knowledgecenter/SSGSG7_7.1.1/com.ibm.itsm.srv.ref.doc/r_cmd_event_query.html).

For more information about the copy serialization attribute, see Copy serialization attribute (www.ibm.com/support/knowledgecenter/SSGSG7_7.1.1/com.ibm.itsm.client.doc/c_mgtc_copyser.html).

Related concepts:

➦ Backup-Archive Client: Copy serialization attribute (http://www.ibm.com/support/knowledgecenter/SSGSG7_7.1.2/com.ibm.itsm.client.doc/c_mgtc_copyser.html)

Related tasks:

➦ Configuring backup-archive clients (http://www.ibm.com/support/knowledgecenter/SSGSG7_7.1.2/com.ibm.itsm.client.doc/t_cfg_bac.html)

dsmc1c.exe

The **dsmc1c.exe** command starts a migration job or a list migration, recalls and retrieves selected migrated files, creates and lists file spaces, lists and deletes migrated files, lists management classes, and creates server connections.

The optional parameters can be entered in any order.

Display help for the command by using the **help** parameter:

```
dsmc1c help
```

dsmc1c createfilespace

The **dsmc1c.exe** command with the **createfilespace** parameter creates a new file space on a Tivoli Storage Manager server. After you create a file space, you can migrate files to that file space.

Syntax

```
▶▶—DSMCLC.exe—CREATEFILESPACE—-g—new_filespace—┌—-l—loglevel—└▶▶
```

Parameters

-g *new_filespace*

Specify a new file space name on Tivoli Storage Manager storage.

-L *loglevel*

Specify the type of information that is to be recorded in logs and trace files. You can specify one or more values with no commas or blank space separators. Severe and error messages are always recorded. The default combination is severe, error, warning, information, and library (SEWIL). The following values are valid:

- C (event)
- D (debug)
- E (error)
- F (flush)
- I (information)

K (driver)
L (library)
S (severe)
T (trace)
U (user)
W (warning)
X (dump)

Examples

Task Create a file space: def-hsm02.

Command: `dsmc1c createfilespace -g def-hsm02`

Task Display help for the **dsmc1c.exe** command.

Command: `dsmc1c help`

Task Change the information that is recorded in log and trace files to the default.

Command: `dsmc1c -l`

dsmc1c defaults

The **dsmc1c.exe** command with the **defaults** parameter displays the default values for **dsmc1c.exe** command options.

Syntax

►►—DSMCLC.exe—DEFAULTS—┐
└─L—loglevel—┘

Parameters

-L *loglevel*

Specify the type of information that is to be recorded in logs and trace files. You can specify one or more values with no commas or blank space separators. Severe and error messages are always recorded. The default combination is severe, error, warning, information, and library (SEWIL). The following values are valid:

C (event)
D (debug)
E (error)
F (flush)
I (information)
K (driver)
L (library)
S (severe)
T (trace)
U (user)
W (warning)
X (dump)

Examples

Task Display the default values for **dsmc1c.exe** command options.

Command: dsmc1c defaults

Task Display help for the **dsmc1c.exe** command.

Command: dsmc1c help

Task Change the information that is recorded in log and trace files to the default.

Command: dsmc1c -l

dsmc1c delete

The **dsmc1c.exe** command with the **delete** parameter deletes migrated files from Tivoli Storage Manager storage.

Syntax

```
►►—DSMCLC.exe—DELETE—-g—filespace—search_pattern—┌──────────┐ ┌──-l—loglevel—┐──►
```

Parameters

-g *filespace*

Specify a file space on Tivoli Storage Manager storage. The file space name is case sensitive.

search_pattern

Specify a pattern for migrated objects. All migrated objects that match the pattern are included in the operation. There are several parts to a search pattern. Some parts are required; some parts are optional. Separate the parts with a blank space. Search pattern elements are case-sensitive. If there is no hardware mapping, you can use wildcard characters asterisk (*) and question mark (?).

volume_pattern

Specify a pattern that matches volume names. The volume pattern is required. If the volume pattern contains blank spaces, enclose the pattern with quotation marks.

If there is a hardware mapping for the volume, you must specify the file-server host name and drive letter without wildcard characters.

directory_pattern

Specify a pattern that matches directory names. The directory pattern is required. If the directory pattern contains blank spaces, enclose the pattern with quotation marks.

file_pattern

Specify a pattern that matches file names. The file pattern is optional. If the volume pattern contains blank spaces, enclose the pattern with quotation marks.

-version *number*

Specify a file version.

The **version** parameter is optional. If you do not specify a version, all versions are deleted.

connection_options

If the operation involves a remote file server, you must specify a Tivoli Storage Manager connection.

You can specify a connection by specifying the two parts of a connection pair or by specifying a shortcut.

Specify the two parts of a connection

Use the **h** and **u** parameters:

-h *TSM_host_name*

Specify the Tivoli Storage Manager server part of a connection pair.

The value of *TSM_host_name* is not case-sensitive. Specify

TSM_host_name with the value of the **TCPSEVERADDRESS** option and the value of the **TCPPORT** option, separated with a colon. For example:

127.0.0.1:1500

-u *node_name*

Specify the Tivoli Storage Manager node part of a connection pair. Use

the same value that you used to define the Tivoli Storage Manager

server connection. If the connection to the Tivoli Storage Manager

server was configured with the **asnodename** option, specify the value of

the **asnodename** option. If the connection was configured without the

asnodename option, specify the value of the **nodename** option. The value

of *node_name* is not case-sensitive.

Specify a connection shortcut

Instead of specifying the host name and node name parts of a connection, you can specify a connection shortcut. Use the **c** parameter to specify a connection shortcut:

-c *shortcut*

The *shortcut* value is one or two characters and is generated by the HSM for Windows client. Connection shortcuts include these examples:

- *l* (local)
- *r1* (remote connection 1)
- *r2* (remote connection 2)

Tip: Run **dsmslcl help** to display connection shortcuts.

-L *loglevel*

Specify the type of information that is to be recorded in logs and trace files.

You can specify one or more values with no commas or blank space separators.

Severe and error messages are always recorded. The default combination is

severe, error, warning, information, and library (SEWIL). The following values

are valid:

C (event)

D (debug)

E (error)

F (flush)

I (information)

K (driver)

L (library)

S (severe)

T (trace)

U (user)
W (warning)
X (dump)

Examples

Task Delete the migrated objects in the `c:\projects\2005\` directory. The migrated objects are in file space `def-hsm01`.

Command: `dsmc1c delete -g def-hsm00 c: \projects\2005`

Task Delete all migrated `*.doc` files in the `\projects\2011\` directory of a remote Tivoli Storage Manager server. The remote Tivoli Storage Manager is identified by connection shortcut `r2`. The migrated files are in file space `def-hsm01`.

Command: `dsmc1c delete -c r2 -g def-hsm01 \\remote_file_server\G$\projects\2011\ *.doc`

Task Display help for the **dsmc1c.exe** command.

Command: `dsmc1c help`

Task Change the information that is recorded in log and trace files to the default.

Command: `dsmc1c -l`

dsmc1c legend

The **dsmc1c.exe** command with the **legend** parameter displays legends for table headers. Some table header text is abbreviated; the legends explain the table headers.

The **legend** parameter displays legends for tables that are output from **dsmc1c.exe** commands.

Syntax

▶▶—DSMCLC.exe—LEGEND—▶▶

Examples

Task Display legends for tables that are output from **dsmc1c.exe** commands.

Command: `dsmc1c legend`

Result:

Table column headers by command:

list, retrieve	
SIZE	file size in KB
V	current file version
S	file security availability
FILENAME	file name
migrate, migratelist, recall, recalllist	
SIZE	file size in KB
V	migrated file version
FILENAME	file name
listfilespace	
NAME	file space name
OCCUPANCY	file space occupancy
listmgmtclasses	
NAME	management class name
POLICY	management class policy

Task Display help for the **dsmclic.exe** command.

Command: dsmclic help

dsmclic list

The **dsmclic.exe** command with the **list** parameter lists files that were migrated to Tivoli Storage Manager storage.

For each migrated file, the following information is displayed:

- File size
- (V) File version number
- (S) Whether security attributes were migrated. A plus sign (+) indicates that security attributes were migrated.
- (D) Whether Windows alternate data stream data was migrated. A plus sign (+) indicates that Windows alternate data stream data was migrated.
- File path

Syntax

```

DSMCLC.exe LIST -g filespace search_pattern [connection_options] [-l loglevel]

```

Parameters

connection_options

If the operation involves a remote file server, you must specify a Tivoli Storage Manager connection.

You can specify a connection by specifying the two parts of a connection pair or by specifying a shortcut.

Specify the two parts of a connection

Use the **h** and **u** parameters:

-h *TSM_host_name*

Specify the Tivoli Storage Manager server part of a connection pair.

The value of *TSM_host_name* is not case-sensitive. Specify *TSM_host_name* with the value of the **TCPSEVERADDRESS** option and the value of the **TCPPORT** option, separated with a colon. For example:
127.0.0.1:1500

-u *node_name*

Specify the Tivoli Storage Manager node part of a connection pair. Use the same value that you used to define the Tivoli Storage Manager server connection. If the connection to the Tivoli Storage Manager server was configured with the **asnodename** option, specify the value of the **asnodename** option. If the connection was configured without the **asnodename** option, specify the value of the **nodename** option. The value of *node_name* is not case-sensitive.

Specify a connection shortcut

Instead of specifying the host name and node name parts of a connection, you can specify a connection shortcut. Use the **c** parameter to specify a connection shortcut:

-c *shortcut*

The *shortcut* value is one or two characters and is generated by the HSM for Windows client. Connection shortcuts include these examples:

- *l* (local)
- *r1* (remote connection 1)
- *r2* (remote connection 2)

Tip: Run **dsmslcl help** to display connection shortcuts.

-g *filespace*

Specify a file space on Tivoli Storage Manager storage. The file space name is case sensitive.

search_pattern

Specify a pattern for migrated objects. All migrated objects that match the pattern are included in the operation. There are several parts to a search pattern. Some parts are required; some parts are optional. Separate the parts with a blank space. Search pattern elements are case-sensitive. If there is no hardware mapping, you can use wildcard characters asterisk (*) and question mark (?).

volume_pattern

Specify a pattern that matches volume names. The volume pattern is required. If the volume pattern contains blank spaces, enclose the pattern with quotation marks.

If there is a hardware mapping for the volume, you must specify the file-server host name and drive letter without wildcard characters.

directory_pattern

Specify a pattern that matches directory names. The directory pattern is required. If the directory pattern contains blank spaces, enclose the pattern with quotation marks.

file_pattern

Specify a pattern that matches file names. The file pattern is optional. If the volume pattern contains blank spaces, enclose the pattern with quotation marks.

-version *number*

Specify a file version.

The **version** parameter is optional. If you do not specify a version, all versions are listed.

-L *loglevel*

Specify the type of information that is to be recorded in logs and trace files. You can specify one or more values with no commas or blank space separators. Severe and error messages are always recorded. The default combination is severe, error, warning, information, and library (SEWIL). The following values are valid:

- C (event)
- D (debug)
- E (error)
- F (flush)
- I (information)
- K (driver)
- L (library)
- S (severe)
- T (trace)
- U (user)
- W (warning)
- X (dump)

-v

Display verbose output.

Examples

Task List all *.doc migrated files in the c:\big projects\2009\ directory. The migrated files are in file space def-hsm01.

Command: dsmc1c list -g def-hsm01 c: "\big projects\2009" *.doc

Task List all migrated *.doc files in the \projects\2011\ directory of a remote Tivoli Storage Manager server. The remote Tivoli Storage Manager is identified by connection shortcut r2. The migrated files are in file space def-hsm01.

Command: dsmc1c list -c r2 -g def-hsm01 \\remote_file_server\G:\projects\2011\ *.doc

Task Display help for the **dsmc1c.exe** command.

Command: dsmc1c help

Task Change the information that is recorded in log and trace files to the default.

Command: dsmc1c -l

dsmc1c listfilespace

The **dsmc1c.exe** command with the **listfilespace** parameter lists file spaces on a Tivoli Storage Manager server. The HSM for Windows client lists all file spaces that you are authorized to see. The command indicates the occupancy of the file space.

The occupancy data that is displayed by the command **dsmc1c listfilespace** is the sum of file sizes of all migrated files for a file space. Occupancy also includes information for managing the migrated files. Compression, data deduplication, and expirations on the Tivoli Storage Manager server are not reflected in the statistics from the **dsmc1c listfilespace** command. The occupancy data is refreshed when you run the **dsmtool** command with the **occupancy** or **statistic** parameters.

Expirations due to copy group settings are explained in IBM technical document 1330160 *TSM HSM for Windows migrated files may expire after 365 days* at <http://www.ibm.com/support/docview.wss?uid=swg21330160>.

Syntax

```
▶▶—DSMCLC.exe—LISTFILESACES—file_space_pattern—connection_options—loglevel—▶▶
```

Parameters

connection_options

If the operation involves a remote file server, you must specify a Tivoli Storage Manager connection.

You can specify a connection by specifying the two parts of a connection pair or by specifying a shortcut.

Specify the two parts of a connection

Use the **h** and **u** parameters:

-h *TSM_host_name*

Specify the Tivoli Storage Manager server part of a connection pair.

The value of *TSM_host_name* is not case-sensitive. Specify

TSM_host_name with the value of the **TCPSEVERADDRESS** option and the value of the **TCPPORT** option, separated with a colon. For example:

127.0.0.1:1500

-u *node_name*

Specify the Tivoli Storage Manager node part of a connection pair. Use the same value that you used to define the Tivoli Storage Manager server connection. If the connection to the Tivoli Storage Manager server was configured with the **asnodename** option, specify the value of the **asnodename** option. If the connection was configured without the **asnodename** option, specify the value of the **nodename** option. The value of *node_name* is not case-sensitive.

Specify a connection shortcut

Instead of specifying the host name and node name parts of a connection, you can specify a connection shortcut. Use the **c** parameter to specify a connection shortcut:

-c *shortcut*

The *shortcut* value is one or two characters and is generated by the HSM for Windows client. Connection shortcuts include these examples:

- *l* (local)
- *r1* (remote connection 1)
- *r2* (remote connection 2)

Tip: Run **dsmc1c help** to display connection shortcuts.

file_space_pattern

Specify a pattern for file spaces. If there is a blank space in the pattern, surround the pattern with quotation marks. Search pattern elements are case-sensitive. You can use wildcard characters * and ?.

-L *loglevel*

Specify the type of information that is to be recorded in logs and trace files. You can specify one or more values with no commas or blank space separators. Severe and error messages are always recorded. The default combination is severe, error, warning, information, and library (SEWIL). The following values are valid:

- C (event)
- D (debug)
- E (error)
- F (flush)
- I (information)
- K (driver)
- L (library)
- S (severe)
- T (trace)
- U (user)
- W (warning)
- X (dump)

Examples

Task List all file spaces that you are authorized to see.

Command: dsmc1c listfilespaces

Task Display help for the **dsmc1c.exe** command.

Command: dsmc1c help

Task Change the information that is recorded in log and trace files to the default.

Command: dsmc1c -l

dsmc1c listmgmtclasses

The **dsmc1c.exe** command with the **listmgmtclasses** parameter lists management classes that contain an archive copy group. (A management class must contain an archive copy group to store files that are migrated.) You can use a pattern to filter management class names.

Syntax

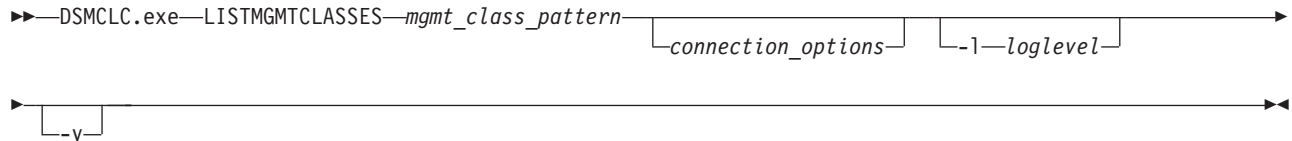

Parameters

mgmt_class_pattern

Specify a pattern for management classes. If there is a blank space in the pattern, surround the pattern with quotation marks. Search pattern elements are case-sensitive. You can use wildcard characters * and ?.

connection_options

If the operation involves a remote file server, you must specify a Tivoli Storage Manager connection.

You can specify a connection by specifying the two parts of a connection pair or by specifying a shortcut.

Specify the two parts of a connection

Use the **h** and **u** parameters:

-h *TSM_host_name*

Specify the Tivoli Storage Manager server part of a connection pair.

The value of *TSM_host_name* is not case-sensitive. Specify

TSM_host_name with the value of the **TCPSERVERADDRESS** option and the value of the **TCPPORT** option, separated with a colon. For example:

127.0.0.1:1500

-u *node_name*

Specify the Tivoli Storage Manager node part of a connection pair. Use the same value that you used to define the Tivoli Storage Manager server connection. If the connection to the Tivoli Storage Manager server was configured with the **asnodename** option, specify the value of the **asnodename** option. If the connection was configured without the **asnodename** option, specify the value of the **nodename** option. The value of *node_name* is not case-sensitive.

Specify a connection shortcut

Instead of specifying the host name and node name parts of a connection, you can specify a connection shortcut. Use the **c** parameter to specify a connection shortcut:

-c *shortcut*

The *shortcut* value is one or two characters and is generated by the HSM for Windows client. Connection shortcuts include these examples:

- *l* (local)
- *r1* (remote connection 1)

- *r2* (remote connection 2)

Tip: Run **dsmc1c help** to display connection shortcuts.

-L loglevel

Specify the type of information that is to be recorded in logs and trace files. You can specify one or more values with no commas or blank space separators. Severe and error messages are always recorded. The default combination is severe, error, warning, information, and library (SEWIL). The following values are valid:

- C (event)
- D (debug)
- E (error)
- F (flush)
- I (information)
- K (driver)
- L (library)
- S (severe)
- T (trace)
- U (user)
- W (warning)
- X (dump)

-v

Display verbose output.

Examples

Task List the properties of the DEFAULT management class.

Command: `dsmc1c listmgmtclasses DEFAULT`

Task Display help for the **dsmc1c.exe** command.

Command: `dsmc1c help`

Task Change the information that is recorded in log and trace files to the default.

Command: `dsmc1c -l`

dsmc1c migrate

The **dsmc1c.exe** command with the **migrate** parameter starts a migration job. You can omit the **migrate** parameter, but you must specify the job file name.

Syntax

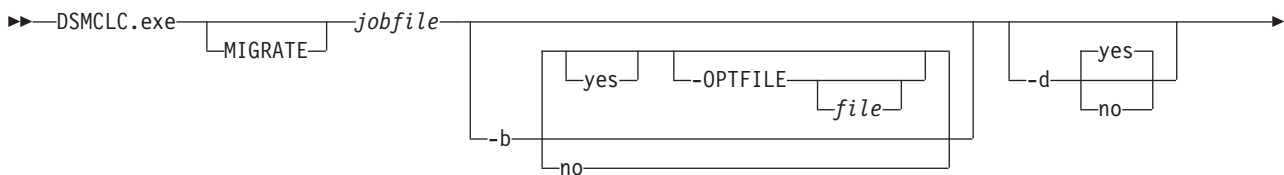

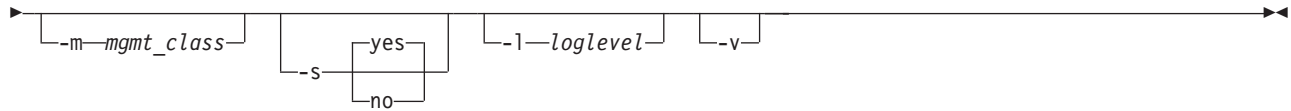

Parameters

jobfile

Specify a migration job file. You can specify a complete path, or only file name and file type, or only the file name. For example, the following commands specify the same job file:

- dsmclc c:\hsmclient\jobs\migrate011.osj
- dsmclc migrate011.osj
- dsmclc migrate011

-b yes|no

Specify whether files are backed up before migration. The default is the value that you set in the initial configuration wizard. If you use the option but do not specify yes or no, files are backed up before migration.

-d yes|no

Specify whether Windows alternate data stream (ADS) data is migrated when the file is migrated. The default is the value that you set in the initial configuration wizard. A yes value means that ADS data is migrated when the file is migrated. A no value means that ADS data is not migrated. If you use the option but do not specify yes or no, a yes value is assumed.

-OPTFILE *file*

Specify the path of an options file for backup before migration.

This option is valid only if you also specify backup before migration.

If *file* is not specified, the backup-archive client uses its default options file. This file value overrides the value that is configured in a migration job file.

-m *mgmt_class*

Specify a management class for the migration job or list migration. This value overrides the management class that is specified when the job was created. Specify DEFAULT to use the Tivoli Storage Manager server default management class of the active policy set.

-s yes|no

Specify whether file security attributes (ACL) are migrated when the file is migrated. The default is the value that you set in the initial configuration wizard. A yes value means that the ACL is migrated when the file is migrated. A no value means that the ACL is not migrated. If you use the option but do not specify yes or no, a yes value is assumed.

-L *loglevel*

Specify the type of information that is to be recorded in logs and trace files. You can specify one or more values with no commas or blank space separators. Severe and error messages are always recorded. The default combination is severe, error, warning, information, and library (SEWIL). The following values are valid:

- C (event)
- D (debug)

- E (error)
- F (flush)
- I (information)
- K (driver)
- L (library)
- S (severe)
- T (trace)
- U (user)
- W (warning)
- X (dump)

-v Display verbose output.

Examples

Task Migrate files with the job that is defined in `c:\hsmclient\jobs\migrate011.osj`.

Command: `dsmc1c c:\hsmclient\jobs\migrate011.osj`

Task Migrate files with the job that is defined in `c:\hsmclient\jobs\migrate011.osj`. Use management class `MC2`. The backup-archive client determine the options file, even if you specified another options file when you configured this job.

Command: `dsmc1c -m MC2 c:\hsmclient\jobs\migrate011.osj -optfile`

Task Display help for the **dsmc1c.exe** command.

Command: `dsmc1c help`

Task Change the information that is recorded in log and trace files to the default.

Command: `dsmc1c -l`

dsmc1c migratelist

The **dsmc1c.exe** command with the **migratelist** parameter migrates files that are listed in a list file.

Syntax

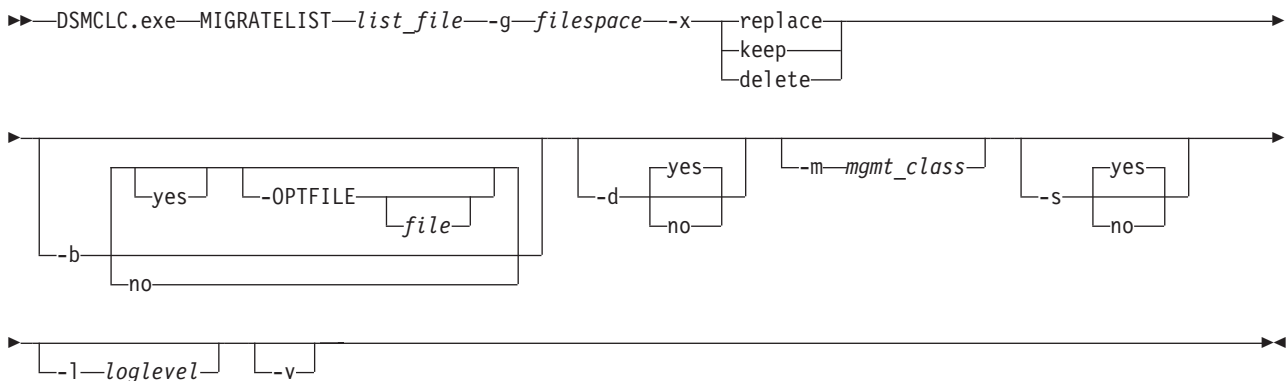

Parameters

list_file

Specify the path of a list file. The list file contains a list of files. Within the list, each file is on a separate line. Each file is identified by a complete path from the root. For example, c:\projects\2009\budget1.xls. The list file is not created by the HSM for Windows client GUI. The list can be encoded in ASCII or Unicode. If Unicode, the first 2 bytes must be the byte order mark (BOM).

-g *filespace*

Specify a file space on Tivoli Storage Manager storage. The file space name is case sensitive.

-x

Specify an action on the file system after the file is migrated to Tivoli Storage Manager storage:

REPLACE

Replace the migrated file with a stub file.

KEEP Keep the complete file on the file system.

DELETE

Delete the file from the file system.

-b *yes|no*

Specify whether files are backed up before migration. The default is the value that you set in the initial configuration wizard. If you use the option but do not specify *yes* or *no*, files are backed up before migration.

-d *yes|no*

Specify whether Windows alternate data stream (ADS) data is migrated when the file is migrated. The default is the value that you set in the initial configuration wizard. A *yes* value means that ADS data is migrated when the file is migrated. A *no* value means that ADS data is not migrated. If you use the option but do not specify *yes* or *no*, a *yes* value is assumed.

-OPTFILE *file*

Specify the path of an options file for backup before migration.

This option is valid only if you also specify backup before migration.

If *file* is not specified, the backup-archive client uses its default options file.

This file value overrides the value that is configured in a migration job file.

-m *mgmt_class*

Specify a management class for the migration job or list migration. This value overrides the management class that is specified when the job was created. Specify **DEFAULT** to use the Tivoli Storage Manager server default management class of the active policy set.

-s *yes|no*

Specify whether file security attributes (ACL) are migrated when the file is migrated. The default is the value that you set in the initial configuration wizard. A *yes* value means that the ACL is migrated when the file is migrated. A *no* value means that the ACL is not migrated. If you use the **-s** option but do not specify *yes* or *no*, the ACL is migrated when the file is migrated.

-L *loglevel*

Specify the type of information that is to be recorded in logs and trace files.

You can specify one or more values with no commas or blank space separators.

Severe and error messages are always recorded. The default combination is severe, error, warning, information, and library (SEWIL). The following values are valid:

- C (event)
- D (debug)
- E (error)
- F (flush)
- I (information)
- K (driver)
- L (library)
- S (severe)
- T (trace)
- U (user)
- W (warning)
- X (dump)

-v
Display verbose output.

Examples

Task Migrate files in the list file `c:\hsmclient\jobs\xlsfiles.txt` to file space `def-hsm01`. Replace the migrated files with stubs. Back up files before migrating. Use options file `d:\backupAdmin\optionsFiles\backup_options_set3.opt`.

Command: `dsmc1c migratelist -g def-hsm01 -x replace c:\hsmclient\jobs\xlsfiles.txt -b -optfile d:\backupAdmin\optionsFiles\backup_options_set3.opt`

Task Display help for the **dsmc1c.exe** command.

Command: `dsmc1c help`

Task Change the information that is recorded in log and trace files to the default.

Command: `dsmc1c -l`

dsmc1c recall

The **dsmc1c.exe** command with the **recall** parameter recalls migrated files by searching for selected stub files on the file system.

The following restrictions apply:

- Hidden files are not recalled if you use wildcard characters to specify file names. You must specify the full path of hidden files.
- Stub files with the system attribute are not recalled. Files with the system attribute are not migrated.
- Windows alternate data stream (ADS) data is not recalled. The ADS data that is in the stub file is not changed when the primary data stream data is recalled.

Syntax

►►—DSMCLC.exe—RECALL—*find_pattern*—connection_options—-n—stub_count—-r—-t—►

Parameters

find_pattern

Specify a stub-file path on the file system. All stub files that match the pattern are included in the operation.

You can use wildcard characters asterisk (*) and question mark (?).

connection_options

Stub files that are in moving state point to a remote Tivoli Storage Manager server. By default, files are recalled from the local Tivoli Storage Manager server and any remote Tivoli Storage Manager server that is indicated in any selected stub file. You can limit the recall operations to a single Tivoli Storage Manager server by specifying a connection.

You can specify a connection by specifying the two parts of a connection pair or by specifying a shortcut.

Specify the two parts of a connection

Use the **h** and **u** parameters:

-h *TSM_host_name*

Specify the Tivoli Storage Manager server part of a connection pair.

The value of *TSM_host_name* is not case-sensitive. Specify

TSM_host_name with the value of the **TCPSEVERADDRESS** option and the value of the **TCPPORT** option, separated with a colon. For example:

127.0.0.1:1500

-u *node_name*

Specify the Tivoli Storage Manager node part of a connection pair. Use the same value that you used to define the Tivoli Storage Manager server connection. If the connection to the Tivoli Storage Manager server was configured with the **asnodename** option, specify the value of the **asnodename** option. If the connection was configured without the **asnodename** option, specify the value of the **nodename** option. The value of *node_name* is not case-sensitive.

Specify a connection shortcut

Instead of specifying the host name and node name parts of a connection, you can specify a connection shortcut. Use the **c** parameter to specify a connection shortcut:

-c *shortcut*

The *shortcut* value is one or two characters and is generated by the HSM for Windows client. Connection shortcuts include these examples:

- *l* (local)
- *r1* (remote connection 1)
- *r2* (remote connection 2)

Tip: Run **dsmslcl help** to display connection shortcuts.

-n *stub_count*

Specify the number of stub files that are processed in a single recall block. The stubs are sorted to optimize recall from tape devices. The Tivoli Storage Manager server locks a sequential storage device while the files in the recall

block are recalled. A smaller value of *stub_count* allows other applications more frequent opportunities to access the device.

The default value is 5000.

A value of 0 specifies an unlimited block size. The Tivoli Storage Manager server locks a sequential storage device until all migrated files in the list file are recalled.

-r

Recurse into subdirectories to search for matching file names.

-t

Test the recall for space requirements. Files are not recalled. The HSM for Windows client calculates the space that is required to recall the files and identifies orphan files. Migration candidates are displayed.

-L *loglevel*

Specify the type of information that is to be recorded in logs and trace files. You can specify one or more values with no commas or blank space separators. Severe and error messages are always recorded. The default combination is severe, error, warning, information, and library (SEWIL). The following values are valid:

- C (event)
- D (debug)
- E (error)
- F (flush)
- I (information)
- K (driver)
- L (library)
- S (severe)
- T (trace)
- U (user)
- W (warning)
- X (dump)

Examples

Task Calculate how much disk space is required to recall all migrated *.xls files in c:\projects\2013\accounting\ and all subdirectories.

Command: dsmc1c recall c:\projects\2013\accounting*.xls -r -t

Task Recall all migrated *.xls files in c:\projects\2013\accounting\ and all subdirectories. Limit recalls to 500 files per block.

Command: dsmc1c recall c:\projects\2013\accounting*.xls -r -n 500

Task Display help for the **dsmc1c.exe** command.

Command: dsmc1c help

Task Change the information that is recorded in log and trace files to the default.

Command: dsmc1c -l

dsmc1c recalllist

The **dsmc1c.exe** command with the **recalllist** parameter recalls migrated files by searching the file system for files that are listed in a list file.

The following restrictions apply:

- Hidden files are not recalled if you use wildcard characters to specify file names. You must specify the full path of hidden files.
- Stub files with the system attribute are not recalled. Files with the system attribute are not migrated.
- Windows alternate data stream (ADS) data is not recalled. The ADS data that is in the stub file is not changed when the primary data stream data is recalled.

Syntax

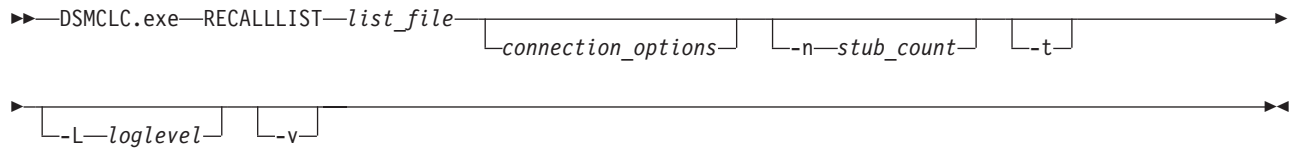

Parameters

list_file

Specify the path of a list file. The list file contains a list of files. Within the list, each file is on a separate line. Each file is identified by a complete path from the root. For example, `c:\projects\2009\budget1.xls`. The list file is not created by the HSM for Windows client GUI. The list can be encoded in ASCII or Unicode. If Unicode, the first 2 bytes must be the byte order mark (BOM).

connection_options

Stub files that are in moving state point to a remote Tivoli Storage Manager server. By default, files are recalled from the local Tivoli Storage Manager server and any remote Tivoli Storage Manager server that is indicated in any selected stub file. You can limit the recall operations to a single Tivoli Storage Manager server by specifying a connection.

You can specify a connection by specifying the two parts of a connection pair or by specifying a shortcut.

Specify the two parts of a connection

Use the **h** and **u** parameters:

-h *TSM_host_name*

Specify the Tivoli Storage Manager server part of a connection pair. The value of *TSM_host_name* is not case-sensitive. Specify *TSM_host_name* with the value of the **TCPSERVERADDRESS** option and the value of the **TCPPORT** option, separated with a colon. For example:
`127.0.0.1:1500`

-u *node_name*

Specify the Tivoli Storage Manager node part of a connection pair. Use the same value that you used to define the Tivoli Storage Manager server connection. If the connection to the Tivoli Storage Manager server was configured with the **asnodename** option, specify the value of

the **asnodename** option. If the connection was configured without the **asnodename** option, specify the value of the **nodename** option. The value of *node_name* is not case-sensitive.

Specify a connection shortcut

Instead of specifying the host name and node name parts of a connection, you can specify a connection shortcut. Use the **c** parameter to specify a connection shortcut:

-c *shortcut*

The *shortcut* value is one or two characters and is generated by the HSM for Windows client. Connection shortcuts include these examples:

- *l* (local)
- *r1* (remote connection 1)
- *r2* (remote connection 2)

Tip: Run **dsmc1c help** to display connection shortcuts.

-n *stub_count*

Specify the number of stub files that are processed in a single recall block. The stubs are sorted to optimize recall from tape devices. The Tivoli Storage Manager server locks a sequential storage device while the files in the recall block are recalled. A smaller value of *stub_count* allows other applications more frequent opportunities to access the device.

The default value is 5000.

A value of 0 specifies an unlimited block size. The Tivoli Storage Manager server locks a sequential storage device until all migrated files in the list file are recalled.

-t

Test the recall for space requirements. Files are not recalled. The HSM for Windows client calculates the space that is required to recall the files and identifies orphan files. Migration candidates are displayed.

-L *loglevel*

Specify the type of information that is to be recorded in logs and trace files. You can specify one or more values with no commas or blank space separators. Severe and error messages are always recorded. The default combination is severe, error, warning, information, and library (SEWIL). The following values are valid:

- C (event)
- D (debug)
- E (error)
- F (flush)
- I (information)
- K (driver)
- L (library)
- S (severe)
- T (trace)
- U (user)
- W (warning)
- X (dump)

Parameters

-p *password*

Specify the password for the node.

connection_options

If the operation involves a remote file server, you must specify a Tivoli Storage Manager connection.

You can specify a connection by specifying the two parts of a connection pair or by specifying a shortcut.

Specify the two parts of a connection

Use the **h** and **u** parameters:

-h *TSM_host_name*

Specify the Tivoli Storage Manager server part of a connection pair.

The value of *TSM_host_name* is not case-sensitive. Specify

TSM_host_name with the value of the **TCPSERVERADDRESS** option and the value of the **TCPPORT** option, separated with a colon. For example:

127.0.0.1:1500

-u *node_name*

Specify the Tivoli Storage Manager node part of a connection pair. Use the same value that you used to define the Tivoli Storage Manager server connection. If the connection to the Tivoli Storage Manager server was configured with the **asnodename** option, specify the value of the **asnodename** option. If the connection was configured without the **asnodename** option, specify the value of the **nodename** option. The value of *node_name* is not case-sensitive.

Specify a connection shortcut

Instead of specifying the host name and node name parts of a connection, you can specify a connection shortcut. Use the **c** parameter to specify a connection shortcut:

-c *shortcut*

The *shortcut* value is one or two characters and is generated by the HSM for Windows client. Connection shortcuts include these examples:

- *l* (local)
- *r1* (remote connection 1)
- *r2* (remote connection 2)

Tip: Run **dsmc1c help** to display connection shortcuts.

-L *loglevel*

Specify the type of information that is to be recorded in logs and trace files. You can specify one or more values with no commas or blank space separators. Severe and error messages are always recorded. The default combination is severe, error, warning, information, and library (SEWIL). The following values are valid:

- C (event)
- D (debug)
- E (error)
- F (flush)
- I (information)
- K (driver)

- L (library)
- S (severe)
- T (trace)
- U (user)
- W (warning)
- X (dump)

Examples

Task Create a connection to a Tivoli Storage Manager server. You created an options file with the following values:

- **tcpserveraddress** HAMBURG_TSM
- **tcpport** 1500
- **commmethod** tcpip
- **passwordaccess** generate
- **nodename** TSMNODE

Command: `dsmc1c register -h HAMBURG_TSM:1500 -u TSMNODE -p password`

Task Display help for the **dsmc1c.exe** command.

Command: `dsmc1c help`

Task Change the information that is recorded in log and trace files to the default.

Command: `dsmc1c -l`

dsmc1c retrieve

The **dsmc1c.exe** command with the **retrieve** parameter retrieves migrated files from the file space of a Tivoli Storage Manager server. Primary data stream (PDS) data and Windows alternate data stream (ADS) data is retrieved.

Syntax

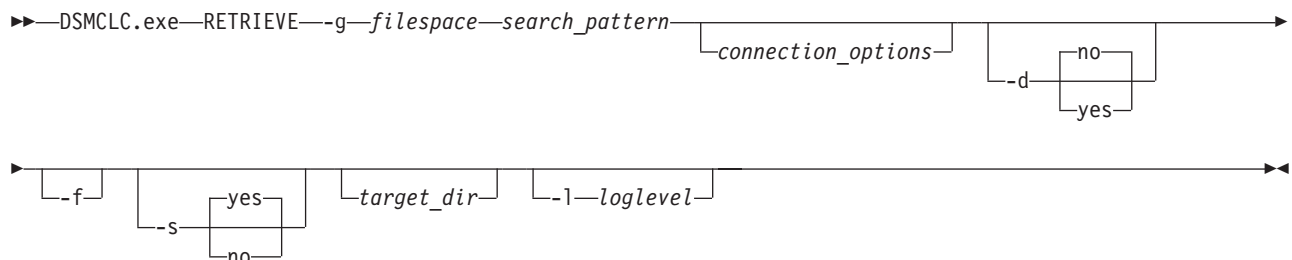

Options

-g filespace

Specify a file space on Tivoli Storage Manager storage. The file space name is case sensitive.

search_pattern

Specify a pattern for migrated objects. All migrated objects that match the pattern are included in the operation. There are several parts to a search pattern. Some parts are required; some parts are optional. Separate the parts

with a blank space. Search pattern elements are case-sensitive. If there is no hardware mapping, you can use wildcard characters asterisk (*) and question mark (?).

volume_pattern

Specify a pattern that matches volume names. The volume pattern is required. If the volume pattern contains blank spaces, enclose the pattern with quotation marks.

If there is a hardware mapping for the volume, you must specify the file-server host name and drive letter without wildcard characters.

directory_pattern

Specify a pattern that matches directory names. The directory pattern is required. If the directory pattern contains blank spaces, enclose the pattern with quotation marks.

file_pattern

Specify a pattern that matches file names. The file pattern is optional. If the volume pattern contains blank spaces, enclose the pattern with quotation marks.

-version *number*

Specify a file version.

The **version** parameter is optional. If you do not specify a version, only the most recent version is retrieved.

connection_options

If the operation involves a remote file server, you must specify a Tivoli Storage Manager connection.

You can specify a connection by specifying the two parts of a connection pair or by specifying a shortcut.

Specify the two parts of a connection

Use the **h** and **u** parameters:

-h *TSM_host_name*

Specify the Tivoli Storage Manager server part of a connection pair.

The value of *TSM_host_name* is not case-sensitive. Specify *TSM_host_name* with the value of the **TCPSERVERADDRESS** option and the value of the **TCPPORT** option, separated with a colon. For example:
127.0.0.1:1500

-u *node_name*

Specify the Tivoli Storage Manager node part of a connection pair. Use the same value that you used to define the Tivoli Storage Manager server connection. If the connection to the Tivoli Storage Manager server was configured with the **asnodename** option, specify the value of the **asnodename** option. If the connection was configured without the **asnodename** option, specify the value of the **nodename** option. The value of *node_name* is not case-sensitive.

Specify a connection shortcut

Instead of specifying the host name and node name parts of a connection, you can specify a connection shortcut. Use the **c** parameter to specify a connection shortcut:

-c *shortcut*

The *shortcut* value is one or two characters and is generated by the HSM for Windows client. Connection shortcuts include these examples:

- *l* (local)
- *r1* (remote connection 1)
- *r2* (remote connection 2)

Tip: Run `dsmlc help` to display connection shortcuts.

-d no|yes

Specify whether Windows alternate data stream (ADS) data is retrieved when the file is retrieved. The default is the value that you set in the initial configuration wizard. A yes value means that ADS data is retrieved when the file is retrieved. ADS data can be retrieved only if ADS data was migrated. A no value means that ADS data is not retrieved. If you use the option but do not specify yes or no, a yes value is assumed.

-f

Force writing the retrieved file if a copy exists on the local volume.

If the stub file on the file system contains Windows alternate data stream (ADS) data, you must use the *f* option to retrieve the file. It is possible that the ADS data that is in the stub file is more recent than the ADS data that was migrated.

-s yes|no

Specify whether file security attributes (ACL) are migrated when the file is migrated. The default is the value that you set in the initial configuration wizard. A yes value means that the ACL is migrated when the file is migrated. A no value means that the ACL is not migrated. If you use the option but do not specify yes or no, a yes value is assumed.

target_dir

Specify a directory for the retrieved file. If you do not specify this option, the file is retrieved to the original path.

-L *loglevel*

Specify the type of information that is to be recorded in logs and trace files. You can specify one or more values with no commas or blank space separators. Severe and error messages are always recorded. The default combination is severe, error, warning, information, and library (SEWIL). The following values are valid:

- C (event)
- D (debug)
- E (error)
- F (flush)
- I (information)
- K (driver)
- L (library)
- S (severe)
- T (trace)
- U (user)
- W (warning)
- X (dump)

Examples

Task Retrieve the migrated .xls files in the c:\big projects\2009\ directory to a new path: c:\projects\spreadsheets\. The migrated copies are in file space def-hsm01.

Command: dsmc1c retrieve -g def-hsm01 c: "\big projects\2009" *.xls c:\projects\spreadsheets.

Spaces separate the three parts of the *search_pattern*: c: "\big projects\2009" *.xls. Because the *directory_pattern* (\big projects\2009) contains a blank space, it is enclosed in quotation marks.

Task Display help for the **dsmc1c.exe** command.

Command: dsmc1c help

Task Change the information that is recorded in log and trace files to the default.

Command: dsmc1c -l

dsmfileinfo.exe

Run the dsmfileinfo.exe program from a Command Prompt window to view file attributes.

Syntax

►► DSMFILEINFO.exe info_options file_path ◀◀

Options

info_options

You can specify any of the following options. Separate options with a blank space.

Table 11. Options for dsmfileinfo.exe

Option	Description
-a	Display information for all options in this table
-d	Show alternate data streams
-i	Show file object ID
-ic	Create file object ID
-m	Calculate MD5 key (complete files only)
-q	Query backend version(s) (stub files only)
-r	Show reparse data (stub files only)
-rb	Show binary reparse data (stub files only)
-s	Show file security data
-sb	Show binary security data
-t	Show file times, size, and attributes (complete files only). This option is the default option.

file_path

Specify the path of a complete file or a stub file. Specify only one file.

Examples

Task Display the access time, creation time, modification time, size, and attributes of the file: c:\projects\2009\budget.xls.

Command: dsmfileinfo c:\projects\2009\budget.xls

Task Create object ID for file c:\projects\2009\budget.xls.

Command: dsmfileinfo -ic c:\projects\2009\budget.xls

Task Display binary security data for c:\projects\2009\budget.xls.

Command: dsmfileinfo -sb c:\projects\2009\budget.xls

Task Display help for **dsmfileinfo.exe** command.

Command: dsmfileinfo

dsmfind.exe

Run the dsmfind.exe program from a Command Prompt window to show files that are described by a job file or by a file path and file attribute filters.

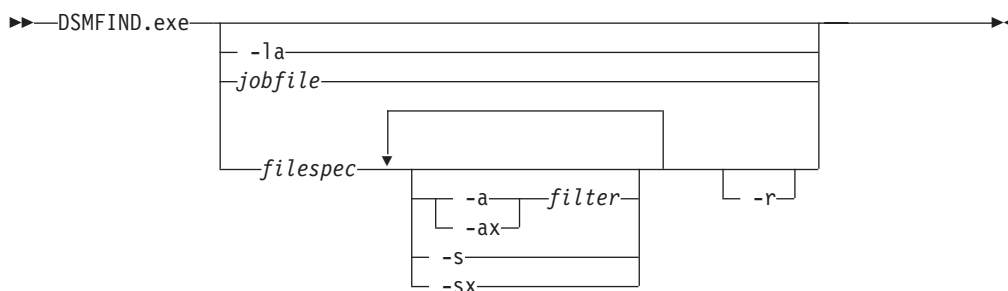
Syntax**Options****-la**

List Windows supported file attributes. Use the listed values to determine the filter for a **dsmfind.exe** command.

jobfile

Specify the path of a migration job file. The command displays all files that meet the criteria that is defined in a migration job file.

filter

Use this option with the attribute options (-a and -ax). Specify a filter for file attributes. The filter must be in the format 0xnxxxxxxx, where n is a hexadecimal number. You can combine file attributes. For example, the filter with value 0x00001600 is a combination of these file attributes:

- 0x00000200 (FILE_ATTRIBUTE_SPARSE_FILE)
- 0x00000400 (FILE_ATTRIBUTE_REPARSE_POINT)
- 0x00001000 (FILE_ATTRIBUTE_OFFLINE)

-a or -ai

Use this option with a filter. This option displays only files that have all attributes defined by the filter.

-ax

Use this option with a filter. This option excludes files that have all attributes defined by the filter.

-s or -si

This option displays stub files only. This is the same as `-a 0x00001600`.

When stub files are created, stub files have these attributes:

- 0x00000200 (FILE_ATTRIBUTE_SPARSE_FILE)
- 0x00000400 (FILE_ATTRIBUTE_REPARSE_POINT)
- 0x00001000 (FILE_ATTRIBUTE_OFFLINE)

Note: Some anti-virus programs can remove the attribute FILE_ATTRIBUTE_OFFLINE from stub files.

-sx

This option excludes stub files. This is the same as `-ax 0x00001600`.

-r The command displays files in all subdirectories.

Invoke the command with no options to display help for the command.

Examples

Task Display all files that meet the criteria that is defined in the job file `c:\hsmclient\jobs\migrate011.osj`.

Command: `dsmfind c:\hsmclient\jobs\migrate011.osj`

Task Display all Excel files in `c:\projects\2009\`.

Command: `dsmfind c:\projects\2009*.xls`

Task Display all Excel files in `c:\projects\` and all subdirectories.

Command: `dsmfind c:\projects*.xls -r`

Task Display all stub files in `c:\projects\` and all subdirectories.

Command: `dsmfind c:\projects\ -r -s`

Task Display all read-only stub files in `c:\projects\` and all subdirectories. Read-only files have attribute FILE_ATTRIBUTE_READONLY (0x00000001). Read-only stub files with other attributes are not displayed. Only files with combined attributes of 0x00001601 are displayed.

Command: `dsmfind c:\projects\ -r -s -a 0x00000001`

Task Display help for the **dsmfind.exe** command.

Command: `dsmfind`

dsmhsmc1c.exe

Use the **dsmhsmc1c.exe** command to set and query the configuration of reconciliation and threshold migration. The settings will be used the next time a reconciliation process or a threshold migration process starts.

Managing reconciliation with dsmhsmc1c.exe

Use the **dsmhsmc1c.exe** command to configure reconciliation on the Command Prompt window.

You can configure reconciliation, deactivate reconciliation, and set the limit for reconciliation processes.

You can choose whether or not reconciliation processing deletes obsolete objects.

Syntax

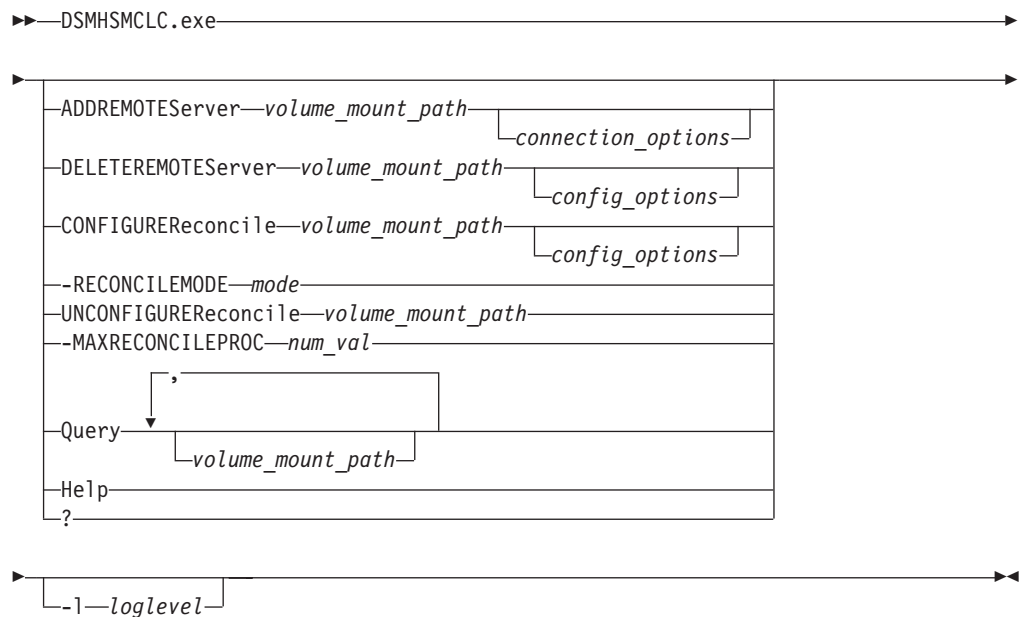

Options

ADDREMOTEserver

Use this option to add a remote Tivoli Storage Manager server to a reconciliation task. Before you can add a remote server, you must configure the volume for reconciliation processing.

If a file is recalled when in moving state, the migrated object is not automatically deleted on the remote Tivoli Storage Manager server. The migrated object remains on the remote Tivoli Storage Manager server until the remote Tivoli Storage Manager server is added to a reconciliation process, and the reconciliation process is run.

DELETEREMOTEserver

Use this option to delete a remote Tivoli Storage Manager server connection from a reconciliation task.

CONFIGUREREconcile

Use this option to configure reconciliation for the specified volume or mount path.

-RECONCILEMODE *mode*

Use this option to choose whether or not the reconciliation process deletes obsolete objects. If you do not specify *mode*, the command displays the current value of *mode*. After you change the value of *mode*, you must restart the HSM monitor service. If you specify *mode*, it must be one of the following values:

NORMal

The reconciliation process marks, unmarks, and deletes objects on the Tivoli Storage Manager server. The marked, unmarked, and deleted objects are recorded in a list file. The list file name is `hsmmonitor-delete-YYYYMMDD-hhmmss.log`, where `YYYYMMDD` indicates the date and `hhmmss` indicates the time when the HSM monitor service was started.

EMULation

The reconciliation process runs in emulation mode. The reconciliation process does not mark, unmark, or delete objects on the Tivoli Storage Manager server. The log output lists the objects that would be marked, unmarked, or deleted if the reconciliation process was run in normal mode. The objects are recorded in the `hsmmonitor-delete-YYYYMMDD-hhmmss.log` list file. `YYYYMMDD` indicates the date and `hhmmss` indicates the time when the HSM monitor service was started.

UNCONFIGUREREconcile

Use this option to remove reconciliation from the specified volume or mount path. When you specify this option, reconciliation is deactivated and all configuration values are erased.

-MAXRECONCILEPROC *num_val*

Use this option to configure the number of reconciliation tasks that can run at the same time. If this number is reached, any additional reconciliation tasks are delayed until the running reconciliation task finishes. Specify a value from 1 to 16. The default is 3.

Query

Use this option to query the threshold migration configuration and reconciliation configuration of one or more volumes. Separate volume names with a comma and no blank space. The default is all configured volumes.

In addition to configuration values, the query can display the following information for each volume, depending on whether threshold migration, reconciliation, or both, are configured for the volume:

- Time of next reconcile process
- Space usage
- Running processes:
 - Reconcile
 - Threshold migration
 - Scan
 - Validation

volume_mount_path

Specify the volume mount path. Because it is possible for a single volume to be mounted by more than one path, always specify that volume by the same mount path. Reconciliation, threshold migration, and migration jobs must all reference the volume by the same path.

connection_options

If the operation involves a remote file server, you must specify a Tivoli Storage Manager connection.

You can specify a connection by specifying the two parts of a connection pair or by specifying a shortcut.

Specify the two parts of a connection

Use the **server** and **user** parameters:

-Server *TSM_host_name*

Specify the Tivoli Storage Manager server part of a connection pair. The value of *TSM_host_name* is not case-sensitive. Specify *TSM_host_name* with the value of the **TCPSEVERADDRESS** option and the value of the **TCPPORT** option, separated with a colon. For example:
127.0.0.1:1500

-User *node_name*

Specify the Tivoli Storage Manager node part of a connection pair. Use the same value that you used to define the Tivoli Storage Manager server connection. If the connection to the Tivoli Storage Manager server was configured with the **asnodename** option, specify the value of the **asnodename** option. If the connection was configured without the **asnodename** option, specify the value of the **nodename** option. The value of *node_name* is not case-sensitive.

Specify a connection shortcut

Use the **connection** parameter:

-COnnection *shortcut*

The *shortcut* value is one or two characters and is generated by the HSM for Windows client. Connection shortcuts include these examples:

- *l* (local)
- *r1* (remote connection 1)
- *r2* (remote connection 2)

config_options

You can specify any of the following configuration options. Specify each option no more than once. If the volume is not configured, omitting the option from the command configures the volume with the default value for the option. If the volume is configured, omitting the option from the command leaves that configuration value unchanged.

-NEXTREConcile *YYYY-MM-DD-hh-mm*

Use this option to configure when the next regular reconciliation occurs. The date and time indicate year (*YYYY*), month (*MM*), day (*DD*), hour (*hh*), and minute (*mm*). Separate each element with a dash (-). The default is the current date and time.

-RECONCILEINTErval *hours*

Use this option to configure the number of hours between reconciliations. The interval starts when a reconciliation ends. If this

option is set to 0, automatic reconciliation is deactivated. The range of acceptable values is 0 - 876000. The default is 720 hours.

-RECONCILENOW no | yes

Use this option to start reconciliation immediately. The default is no.

-FILESPELIST ALL | *file space,file space*

Use this option to configure the file spaces that are used when this volume is reconciled. Separate file space names with a comma and with no blank spaces. If you specify no file space names, or specify ALL, all available file spaces are used for reconciliation.

You can improve the reconciliation performance by restricting the list to the file spaces that contain migrated files of the volume that you are configuring.

-L *loglevel*

Specify the type of information that is to be recorded in logs and trace files. You can specify one or more values with no commas or blank space separators. Severe and error messages are always recorded. The default combination is severe, error, warning, information, and library (SEWIL). The following values are valid:

- C (event)
- D (debug)
- E (error)
- F (flush)
- I (information)
- K (driver)
- L (library)
- S (severe)
- T (trace)
- U (user)
- W (warning)
- X (dump)

Help

Use this option to display help for the command. Entering the command with no options also displays help for the command.

- ? Use this option to display help for the command. Entering the command with no options also displays help for the command.

Examples

Task Volume e:\ is not yet configured for reconciliation. Configure volume e:\ for reconciliation. Accept the default values for all parameters.

Command: dsmhsmclic configurer e:\

Task Configure the next reconciliation to start at midnight on the 1 December 2011 using file spaces filespaceA and filespaceC, with an interval of one year (8760 hours) until the next reconciliation.

Command: dsmhsmclic configurer e:\ -nextrec 2011-12-01-00-00 -filesp filespaceA,filespaceC -reconcileint 8760

Task Volume f:\ is not yet configured for reconciliation. Configure volume f:\ for reconciliation. Accept the default values for all parameters except **reconcileinterval**.

Command: dsmhsmc1c configurer f:\ -reconcileinterval 1000

Task Volume g:\ is already configured for reconciliation. Change only the **reconcileinterval** value for this volume.

Command: dsmhsmc1c configurer g:\ -reconcileint 800

Task Limit reconciliation among all volumes to one reconciliation process at a time.

Command: dsmhsmc1c -maxreconcileproc 1

Task Deactivate automatic reconciliation but do not erase reconciliation configuration of volume e:\.

Command: dsmhsmc1c configurer e:\ -reconcileint 0

Task Deactivate reconciliation and erase reconciliation configuration for volume e:\.

Command: dsmhsmc1c unconfigurer e:\

Task Add a remote server for reconciliation of volume e:\. The remote Tivoli Storage Manager connection shortcut is *r1*.

Command: dsmhsmc1c addremotes e:\ -co r1

Task

All stub files on volume e:\ have been processed by the **hsmtasks** service and all obsolete objects have been removed from the remote Tivoli Storage Manager server at *HAMBURG_TSM*. You want to remove the remote server from reconciliation of volume e:\. You cannot delete the connection file (*HAMBURG_TSM-TSMNODE.opt*) from the configuration directory because you still require the connection for reconciliation of other volumes.

Delete the remote server for reconciliation of volume e:\.

Command: dsmhsmc1c delremotes e:\ -se HAMBURG_TSM:1500 -us TSMNODE

Task Query the configuration of volumes e:\ and g:\.

Command: dsmhsmc1c q e:\,g:\

Task Change the information that is recorded in log and trace files. Record dump and trace information, and (by default) severe and error information.

Command: dsmhsmc1c -l XT

Task Change the information that is recorded in log and trace files to the default.

Command: dsmhsmc1c -l

Task Display help for the **dsmhsmc1c.exe** command (three methods are shown).

Command: dsmhsmc1c ?

Command: dsmhsmc1c help

Command: dsmhsmc1c

Related concepts:

“Tracing preferences” on page 35

Related tasks:

“Configuring reconciliation with the graphical user interface” on page 65

Related reference:

“Managing threshold migration with **dsmhsmc1c.exe**”

Managing threshold migration with **dsmhsmc1c.exe**

Use the **dsmhsmc1c.exe** command to configure threshold migration from the Command Prompt window.

You can configure threshold migration, deactivate threshold migration, set the limit for threshold migration processes, and query the configuration.

Syntax

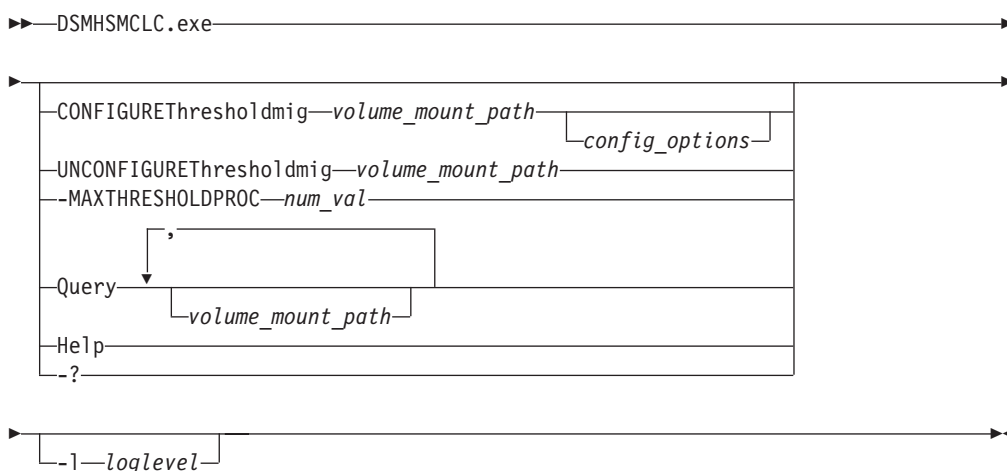

Options

CONFIGUREThresholdmig

Use this option to configure threshold migration for the specified volume or mount path.

UNCONFIGUREThresholdmig

Use this option to remove threshold migration from the specified volume or mount path. When you specify this option, threshold migration is deactivated and all configuration values are erased.

-MAXTHRESHOLDPROC num_val

Use this option to configure the number of migration tasks that can occur simultaneously. The option applies to migration, scan, and validation tasks on all volumes. If this number is reached, any pending migration tasks are delayed until one of the running tasks finishes. The range of acceptable values is 1 - 16. The default is 3.

Query

Use this option to query the threshold migration configuration and reconciliation configuration of one or more volumes. Separate volume names with a comma and no blank space. The default is all configured volumes.

In addition to configuration values, the query can display the following information for each volume, depending on whether threshold migration, reconciliation, or both, are configured for the volume:

- Time of next reconcile process
- Space usage
- Running processes:
 - Reconcile
 - Threshold migration
 - Scan
 - Validation

volume_mount_path

Specify the volume mount path. Because it is possible for a single volume to be mounted by more than one path, always specify that volume by the same mount path. Reconciliation, threshold migration, and migration jobs must all reference the volume by the same path.

config_options

You can specify any of the following configuration options. Specify each option no more than once. If the volume is not configured, omitting the option from the command configures the volume with the default value for the option. If the volume is configured, omitting the option from the command leaves that configuration value unchanged.

-FILESP*ace file space*

Use this option to configure the file space that is used for threshold migration.

On the initial configuration, you must specify a file space. After the initial configuration, this parameter is optional. Until you specify a different file space, files that are migrated from this volume are stored in this file space.

-MGMT*class management class*

Use this option to configure the management class that is used for threshold migration of this volume. Specify an existing management class with an archive copy group, or specify DEFAULT to use the default management class of the active policy set. If the retention period of the selected management class is finite, a warning is issued.

-HIGH*threshold percent*

Use this option to configure the disk usage that triggers when to start threshold migration. After the disk capacity reaches this percent of capacity, threshold migration begins. The range of acceptable values is 1 - 100. The default is 90.

-LOW*threshold percent*

Use this option to configure the disk usage that triggers when to stop threshold migration. After the disk usage reaches this percent of capacity, threshold migration stops. The low threshold must be less than the high threshold. The range of acceptable values is 0 - 99. The default is 80.

-MON*itorinterval minutes*

Use this option to configure how frequently the HSM monitor service checks space usage on the disk. The time is measured in minutes. If the monitor interval is set to 0, monitoring is deactivated. The range of acceptable values is 0 - 9999. The default is 5.

-SCANinterval *hours*

Use this option to configure how frequently the HSM monitor service starts the file system scan to find candidates. The time is measured from the end of the last scan to the beginning of the next scan. The time is measured in hours. The range of acceptable values is 1 - 9999. The default is 24.

If a scan yields better quality candidates (older and larger files) than the previous scan, the interval is automatically decreased by a small amount. If a scan yields poorer quality candidates (newer and smaller files) than the previous scan, the interval is automatically increased by a small amount.

-CHECKCANDidatesinterval *minutes*

Use this option to configure how frequently the HSM monitor service validates the candidates in the candidates pool. The time is measured from the end of the last validation to the beginning of the next validation. The time is measured in minutes. If the interval is set to zero, validation is deactivated. The range of acceptable values is 0 - 9999. The default is 180.

-MINMIGFILESIZE *kilobytes*

Use this option to configure minimum file size for a valid migration candidate. The size is measured in kilobytes (KB). The range of acceptable values is 4 - 2147483647 (2 TB). The default is 4.

-MINMIGFILEAGE *days*

Use this option to configure minimum file age for a valid migration candidate. The age is measured in days. The range of acceptable values is 0 - 99999. The default is 360.

-MINAGETYPE Access | Create | Modify

Use this option to configure which time stamp is used to calculate the age of a file. Changing this option can make many files in the current pool of migration candidates no longer valid. The choices correspond to the file system time stamps for file creation, file modification, and file access.

-AGEWeight *percent*

Use this option to configure the importance of file age (relative to file size) when determining migration candidates.

The age weight and size weight of a file are computed relative to the configured minimum age and minimum size. Hence, a file that is twice as old as the minimum age has an age weight of 2. If the file is the minimum size, it has a size weight of 1.

When the importance of age relative to size is considered, the file's weight is computed in this way: $\text{computed weight} = (\text{AGEWeight} * (\text{age weight})) + ((1 - \text{AGEWeight}) * (\text{size weight}))$.

For example, when $\text{AGEWeight} = 50$, the file has the same weight $((.5 * 2) + ((1 - .5) * 1)) = 1.5$ as a file that is only as old as the minimum age, but twice as big as the minimum size $((.5 * 1) + (.5 * 2)) = 1.5$. The weight of both files is 1.5.

If the `AGEWeight` option is not 50%, but 75%, the first file has a computed weight of 1.75 $((.75*(2)) + ((1-.75)*(1)) = 1.75)$, while for the younger but larger file, the computed weight is 1.25 $((.75*(1)) + ((1-.75)*(2)) = 1.25)$.

Specify a value from 0 to 100. The default is 50.

-BACKUPBEforemigrate yes | no

Use this option to configure whether migration requires backup. The default is the value that you set in the initial configuration wizard. If you use the **-backupbeforemigrate** option but do not specify yes or no, a file is backed up before it is migrated.

-OPTFILE *options_file*

Use this option to specify the options file for backup before migration. If you specify `-OPTFILE=DEFAULT`, the backup-archive client chooses the options file. The backup-archive client chooses the options file even if the volume was previously configured to use another options file. The backup-archive client chooses the options file even if you specified another options file in the initial configuration wizard.

-THRESHOLDMIGNOW yes | no

Use this option to configure an immediate threshold migration. If disk usage is greater than the low threshold, files are migrated until the low threshold is reached. The default is no.

-SCANNOW yes | no

Use this option to configure an immediate scan of the volume. The default is no.

-SECurity yes | no

Use this option to configure whether file security attributes are migrated when the file is migrated. The default is the value that you set in the initial configuration wizard.

-ADStreams no | yes

Use this option to configure whether Windows alternate data streams data is migrated when the file is migrated. The default is the value that you set in the initial configuration wizard.

-L *loglevel*

Specify the type of information that is to be recorded in logs and trace files. You can specify one or more values with no commas or blank space separators. Severe and error messages are always recorded. The default combination is severe, error, warning, information, and library (SEWIL). The following values are valid:

- C (event)
- D (debug)
- E (error)
- F (flush)
- I (information)
- K (driver)
- L (library)
- S (severe)

T (trace)
U (user)
W (warning)
X (dump)

Help

Use this option to display help for the command. Entering the command with no options also displays help for the command.

? Use this option to display help for the command. Entering the command with no options also displays help for the command.

Examples

Task Volume e:\ is not yet configured for threshold migration. Configure volume e:\ for threshold migration. Accept the default values for all parameters. (The file space name must be specified on the initial configuration).

Command: dsmhsmc1c configuret e:\ -files computer10

Task Volume e:\ was configured with default values. Raise the high and low thresholds for volume e:\. Monitor the volume more frequently.

Command: dsmhsmc1c configuret e:\ -high 95 -low 90 -monitor 2

Task Volume e:\ was configured with default values. Change the importance of size (relative to age) when picking migration candidates. Scan the volume for new candidates immediately.

Command: dsmhsmc1c configuret e:\ -agew 25 -scannow yes

Task Immediately begin a migration of volume e:\. Continue migrating files until the disk usage is 40% of capacity.

Command: dsmhsmc1c configuret e:\ -low 40 -migratenow yes

Task Limit threshold migration among all volumes to one threshold migration process at a time.

Command: dsmhsmc1c -maxthresholdproc 1

Task Deactivate threshold migration but do not erase threshold migration configuration of volume e:\.

Command: dsmhsmc1c configuret e:\ -monitorinterval 0

Task Deactivate threshold migration and erase threshold migration configuration for volume e:\.

Command: dsmhsmc1c unconfiguret e:\

Task Set a new management class MC2 for files that are migrated from volume f:\ by threshold migration.

Command: dsmhsmc1c configuret f:\ -mgmt MC2

Task Query the configuration of volumes e:\ and g:\.

Command: dsmhsmc1c q e:\,g:\

Task Change the information that is recorded in log and trace files. Record dump and trace information, and (by default) severe and error information.

Command: dsmhsmc1c -l XT

Task Change the information that is recorded in log and trace files to the default.

Command: `dsmhsmc1c -l`

Task Display help for the `dsmhsmc1c.exe` command (three methods are shown).

Command: `dsmhsmc1c ?`

Command: `dsmhsmc1c help`

Command: `dsmhsmc1c`

Related concepts:

“Tracing preferences” on page 35

“Threshold migration” on page 46

dsminfo.exe

Run the `dsminfo.exe` command from a Command Prompt window to view HSM for Windows client settings.

When you run this command the log file `dsminfo.log` is created.

Syntax



Options

info_options

You can specify any of the following options. Separate options with a space.

Table 12. Options for `dsminfo.exe`

Option	Description
all	Displays information for all options in this table
clclog	Displays the <code>dsmc1c.exe</code> command log level
cluster	Displays cluster information
disk	Displays hard disks information
driver	Displays HSM for Windows file-system driver version
errors	Displays only messages that contain installation errors
files	Displays all files of a valid HSM installation.
filter	Displays the attribute file filter and minimum file size
guilog	Displays the <code>dsmgui.exe</code> command log level
help	Displays the help for the options for this command
infolog	Displays <code>dsminfo.exe</code> command log level
installdir	Displays the installation directory
ip	Displays local computer IP addresses
mappings	Lists the hardware volume mappings

Table 12. Options for `dsminfo.exe` (continued)

Option	Description
save	Saves the output to <code>check_installation.txt</code> (any further run of the command deletes this file)
servicelog	Displays the hsmervice.exe command log level
tivoli	Displays the versions of the Tivoli Storage Manager backup-archive client and API
user	Displays the user name
version	Displays the HSM for Windows client version
win	Displays the Windows version and fix pack
wincp	Displays the Windows default ANSI code page

Help

Use this option to display help for the command. Entering the command with no options also displays help for the command.

Examples

Task Display the version of the HSM for Windows client client.

Command: `dsminfo version`

Task Display the logging level of the following commands: **hsmervice.exe**, **dsmgui.exe**, **dsmc1c.exe**.

Command: `dsminfo servicelog guilog clclog`

Task Display help for the **dsminfo.exe** command (two methods are shown).

Command: `dsminfo help`

Command: `dsminfo`

dsmmove.exe

Run the **dsmmove.exe** command to move stub files to another location. If the other location is managed by a different Tivoli Storage Manager server, the migrated file data is moved to the new Tivoli Storage Manager server.

Run the **dsmmove.exe** command from a Command Prompt window on the local file server.

Syntax

```

▶▶—DSMMOVE.exe—[options]—source_file_pattern—target_directory—▶▶

```

Parameters

options

You can specify any of the following options. Separate options with a blank space.

-d Option **-d** specifies that stub files in retention state are moved. The retention is not restarted on the local Tivoli Storage Manager server. By

default, stub files in retention state are not moved. These files are considered deleted, but kept in the retention state by the Tivoli Storage Manager server.

-f Option **-f** specifies that a moved stub file replaces an existing file of the same name. You are not prompted to confirm replacement. By default, files are not replaced on the local file system and you are not prompted. A warning is logged.

-g *file_space*

Option **-g** specifies the file space in which the content of the stub files will be stored on the local Tivoli Storage Manager server. You must specify option **-g** if files are moved to another file server.

Do not specify this option if stub files are moved within a volume or to another volume on the same file server. For such moves, the migrated content of stub files on the local file server remains in the same file space.

-m *management_class*

Option **-m** specifies a Tivoli Storage Manager server management class. If you do not specify this option, the moved stub files are bound to the default management class.

Do not specify this option if stub files are moved within a volume or to another volume on the same file server. For such moves, no new object is created on the Tivoli Storage Manager server.

-r If option **-r** is specified, the **dsmove.exe** command traverses subdirectories on the remote file server when scanning for stub files to move. When reaching the volume boundary, the **dsmove.exe** command stops. The command does not traverse into nested volumes.

-s If option **-s** is specified, the **dsmove.exe** command applies the security access control list (ACL) of the remote stub file to the local stub file.

This option does not affect the ACLs of local directory objects. The ACLs of the remote directory objects are not applied to the local directory objects.

connection_options

If the operation involves a remote file server, you must specify a Tivoli Storage Manager connection.

You can specify a connection by specifying the two parts of a connection pair or by specifying a shortcut.

Specify the two parts of a connection

Use the **h** and **u** parameters:

-h *TSM_host_name*

Specify the Tivoli Storage Manager server part of a connection pair. The value of *TSM_host_name* is not case-sensitive. Specify *TSM_host_name* with the value of the **TCPSERVERADDRESS** option and the value of the **TCPPORT** option, separated with a colon. For example: 127.0.0.1:1500

-u *node_name*

Specify the Tivoli Storage Manager node part of a connection pair. Use the same value that you used to define the Tivoli Storage Manager server connection. If the connection to the Tivoli Storage Manager server was configured with the **asnodename** option, specify the value of the **asnodename** option. If the connection was

configured without the **asnodename** option, specify the value of the **nodename** option. The value of *node_name* is not case-sensitive.

Specify a connection shortcut

Instead of specifying the host name and node name parts of a connection, you can specify a connection shortcut. Use the **c** parameter to specify a connection shortcut:

-c *shortcut*

The *shortcut* value is one or two characters and is generated by the HSM for Windows client. Connection shortcuts include these examples:

- *l* (local)
- *r1* (remote connection 1)
- *r2* (remote connection 2)

Tip: To display connection shortcuts, run the **dsmmove** command with no parameters. Help for the command is displayed and defined shortcuts are displayed.

source_file_pattern

Specify the location of the stub files. You can use wildcard characters. If stub files are moved to another file server, you must use a UNC (Universal Naming Convention) path name.

You cannot move stub files with the **dsmmove.exe** command if the host name of the remote file server is the same as the host name of the local file server. If the host name is the same, you can move a migrated file by recalling the file, moving the file, and then migrating the file again.

The **dsmmove.exe** command does not traverse into nested volumes, even if option **-r** is specified. To move data from nested volumes, run the **dsmmove.exe** command for each nested volume.

target_directory

Specify where to move the stub files. If the local directory does not exist, the stub moving tool creates the directory with default security settings.

Entering the command with no options displays help for the command. The help displays the command syntax and previously defined connection shortcuts.

Examples

Task: Move migrated files from remote directory \\REMOTE_HOST\dir\ and all subdirectories to local directory E:\new_dir. Indicate the connection with the **-h (*host_name*) and **-u** (*node_name*) parameters. Accept the default management class.** Command:

```
dsmmove -h 123.456.789.1:1505 -u TSMNODE -g tsmospace -r
\\REMOTE_HOST\dir\* E:\new_dir
```

Task: Move migrated PDF files (*.pdf) from remote directory \\REMOTE_HOST\proj1\ to local directory F:\proj1\PDFs. Indicate the connection with the **-c (*shortcut*) parameter. The connection is assigned shortcut value **r2**.**

Command:

```
dsmmove -c r2 -g projects -m DEFAULT \\REMOTE_HOST\proj1\*.pdf
F:\proj1\new_PDFs
```

Task: Move migrated files from local directory G:\proj3\ and all subdirectories to local directory F:\proj3\. Directory G:\proj3\ and directory F:\proj3\ are on the same file server.

Command:

```
dsmmove -r G:\proj3\* F:\proj1
```

dsmquota.exe

Run the **dsmquota.exe** command to display user and group quotas or to reset the quota recall counter for one or more users.

Use the **dsmquota.exe** command to do the following quota tasks:

- Reset the quota recall counter for one or more user accounts
- List HSM quota definitions of user and group accounts
- Query Windows domains
- Query Windows user accounts
- Query Windows group accounts
- Evaluate effective quotas
- Display live quotas

Syntax

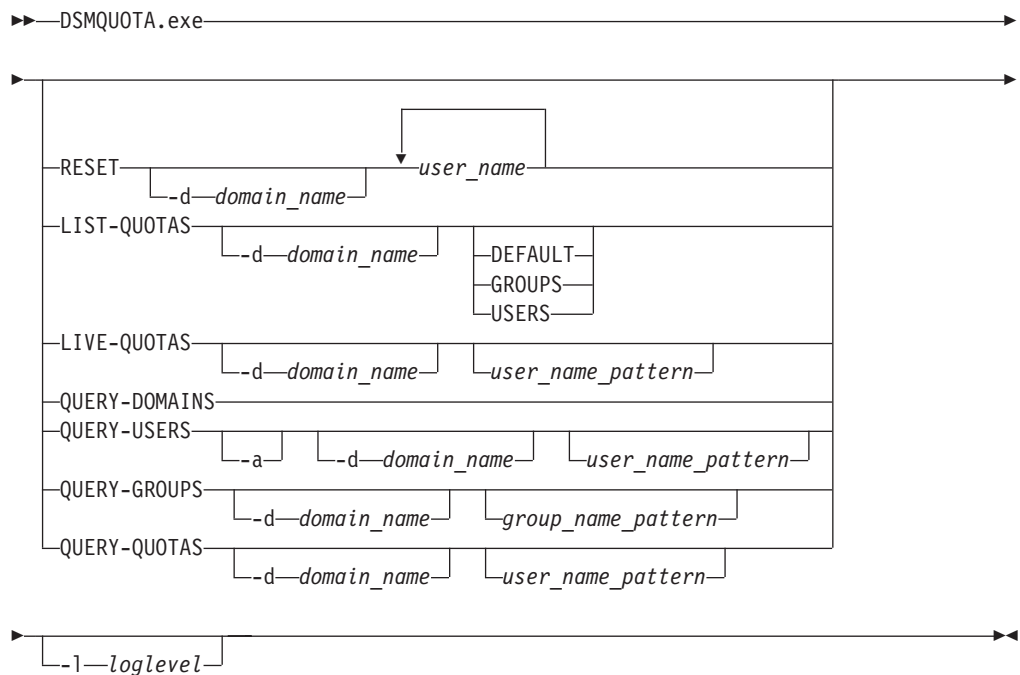

Parameters

RESET

Reset the quota recall counter for one or more user accounts. Separate user account names with a blank space. Each user account name is in the format `domain-name\user_name`. If you omit `domain-name`, the local host is used.

The domain (**-d**) parameter indicates that all user accounts are on the specified domain. After the domain parameter, list only the user account names. For example: `dsmquota reset -d domain1 user1 user2 user3`.

Restriction: If you use the domain parameter, you cannot reset quotas of user accounts on the local host.

LIST-QUOTAS

Display a list of quotas. You can restrict the list to a domain that you specify with the domain (**-d**) parameter. You can restrict the list to only user account quotas with the **users** parameter. You can restrict the list to only group account quotas with the **groups** parameter. You can restrict the list to only default quotas with the **default** parameter.

LIVE-QUOTAS

Display a list of user accounts that have a file recalls counter greater than 0. The record for each user account displays the number of file recalls in the period, and the file recalls quota in parentheses. You can restrict the list to a domain that you specify with the domain (**-d**) parameter.

Enter a value for *user_name_initial_chars* to filter group account names. The command displays all user accounts with a non-zero file recalls counter and that begin with the value.

QUERY-DOMAINS

Display a list of Windows domains.

QUERY-USERS

Display a list of Windows user accounts. You can restrict the list to a domain that you specify with the domain (**-d**) parameter.

Use the **-d** parameter to display more detailed information about user accounts, including group membership.

Enter a value for *user_name_initial_chars* to match user account names. The command displays all user account names that begin with the value.

QUERY-GROUPS

Display a list of Windows account groups. You can restrict the list to a domain that you specify with the domain (**-d**) parameter.

Enter a value for *group_name_initial_chars* to match group account names. The command displays all group account names that begin with the value.

QUERY-QUOTAS

Display the effective user account quota. The HSM for Windows client determines which user account quota, group account quota, and default quota definitions apply to a user account. The HSM for Windows client determines one effective quota for the user account.

The output displays quota information for each user account that matches the query:

- The user name
- The quota definition as file recalls per time span
- The effective quota type:
 - If the user account quota definition is the effective quota, the user account name is listed.
 - If the group account quota definition is the effective quota, the group account name is listed.
 - If the default quota definition is the effective quota, default quota is listed.

You can restrict the list to a domain that you specify with the domain (**-d**) parameter.

Enter *user_name_pattern* to match user account names. You can use wildcard character * to match one or more characters and ? to match one character. The command displays all user account names that match the pattern.

Example

Task Reset the quota recall counter for local user accounts user43 and user78.

Command: `dsmquota reset user43 user78`

Task Reset the quota recall counter for user accounts on different domains.

Command: `dsmquota reset domain5\user16 domain3\user56`

Related concepts:

“File recall quotas” on page 31

dsmtool.exe

Run the **dsmtool.exe** command to display the quantity, size, and expiration period of migrated objects in Tivoli Storage Manager storage.

You can display the occupancy data of migrated files in the following ways:

- Use the Tivoli Storage Manager administrative command **query occupancy**.
- The HSM for Windows client command **dsmclic listfilespace**s
- The HSM for Windows client command **dsmtool occupancy**

The administrative command **query occupancy** determines the amount of storage that a client is using on the Tivoli Storage Manager server. The command displays the space that is used in a Tivoli Storage Manager storage pool. The query can be refined by specifying a node name, file space name and type of data. You must have administrative access to the Tivoli Storage Manager server to use this command.

The occupancy data that is displayed by the command **dsmclic listfilespace**s is the sum of file sizes of all migrated files for a file space. Occupancy also includes information for managing the migrated files. Compression, data deduplication, and expirations on the Tivoli Storage Manager server are not reflected in the statistics from the **dsmclic listfilespace**s command. The occupancy data is refreshed when you run the **dsmtool** command with the **occupancy** or **statistic** parameters.

Expirations due to copy group settings are explained in IBM technical document 1330160 *TSM HSM for Windows migrated files may expire after 365 days* at <http://www.ibm.com/support/docview.wss?uid=swg21330160>.

The **dsmtool occupancy** command displays the size that the migrated objects occupy on the file system. Compressed size and expired objects are not included in the occupancy calculation. Only uncompressed, unexpired objects sizes are calculated.

Syntax

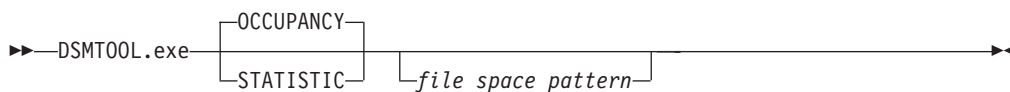

Parameters

OCCUPANCY

Specify the **occupancy** option to display the number of migrated files and their total size. The size is calculated as the size of the resident file on the file system.

The size can be different from the administrative command **query occupancy**.

STATISTIC

Specify the **statistic** option to display the number of migrated files and their total size, and the versions and expiration periods of unexpired migrated files. The **statistic** option also displays the number and size of migrated files that are marked for deletion at the next reconciliation.

file_space_pattern

You can specify a file space. The specification can contain the wildcard character (*). If you do not specify a file space, the command displays information for all file spaces.

Example

Task Display occupancy of all file spaces for the HSM for Windows client node.

Command: `dsmtool occupancy`

Task Display the versions and expiration periods of migrated files on all file spaces that begin with *hsm*.

Command: `dsmtool statistic hsm*`

Chapter 7. Troubleshooting the HSM for Windows client

You can diagnose and fix some common problems, such as those caused by antivirus software.

Troubleshooting steps and information

You can follow some general guidelines on troubleshooting and preparing information for IBM support.

Trying the action again

1. Shut down the IBM TSM HSM Recall Service.
2. Shut down the IBM TSM HSM Tasks Service.
3. Shut down the IBM TSM HSM Monitor Service, if it is installed.
4. Save and delete the log files.
5. Set the log levels to the highest level (**Full**) and ensure that the log file size is sufficiently large..
6. Restart the IBM TSM HSM Recall Service (`hsmervice.exe`) and verify that the service is running.
7. Restart the IBM TSM HSM Tasks Service (`hsmtasks.exe`) and verify that the service is running.
8. Restart the IBM TSM HSM Monitor Service(`hsmmonitor.exe`) and verify that the service is running.
9. Retry the action, if you still have an issue, retry the action using another method, for example:
 - Use the HSM for Windows client GUI instead of the Command Prompt window or vice versa.
 - Check permissions by creating a file in the directory of the stub file you are trying to retrieve.
 - From an application, such as MS Word, open and save the file in question.

Collecting data and files for IBM support

A technical note provides steps for generating and collecting information that can help the IBM Support Center assist you. See IBM technical document 1456651*Collecting Data for IBM Tivoli Storage Manager HSM for Windows* at <http://www.ibm.com/support/docview.wss?uid=swg21456651>.

Related concepts:

“Tracing preferences” on page 35

Previewing files that would be deleted by a reconciliation process

You can create a list of files that would be deleted by a reconciliation process. When you run a reconciliation process in the emulation mode, the files are not deleted.

Use the **reconcilemode** option with the **dsmhsmc1c** command to create a list file of obsolete objects on the Tivoli Storage Manager server. When you specify the option **reconcilemode=emulation**, the reconciliation process does not delete obsolete objects, but writes the file names to the list file `hsmmonitor-delete-YYYYMMDD-hhmmss.log`. `YYYYMMDD` indicates the date and `hhmmss` indicates the time when the HSM monitor service was started.

Related reference:

"dsmhsmc1c.exe" on page 103

Offline stub files are recalled when they are first synchronized

Offline sub files are recalled the first time that Windows synchronizes the offline files.

With the Windows operating system, you can select a network file or folder to make it available offline. Windows synchronizes your offline file with the network copy of the file when you reconnect to the network folder. The HSM for Windows client can migrate an offline file to Tivoli Storage Manager storage. The first time that Windows synchronizes the offline file, the HSM for Windows client recalls the migrated copy. The migrated copy is recalled even if you did not update a local copy after it was migrated to Tivoli Storage Manager storage.

After the system synchronizes the copy, it does not recall the migrated copy the next time that synchronization takes place.

Problems with VSS during reconciliation

The HSM for Windows client uses VSS (Microsoft Volume Shadow Copy Service) during reconciliation. Errors can occur with VSS during reconciliation.

Look for clues to the VSS problem in the `msmmonitor-admin.log` file and in the `hsmmonitor.log` file.

For information about Tivoli Storage Manager and VSS, see the *Tivoli Storage Manager Backup-Archive Clients Installation and User's Guide*.

The *Tivoli Storage Manager Problem Determination Guide* contains the following topics about using VSS:

- Defining VSS transient errors
- Gathering VSS diagnostic information for Microsoft assistance
- Troubleshooting errors using a VSS trace
- Running VSS API calls with the `vsreq.exe` sample program

Small migrated files occupy much space on Tivoli Storage Manager server storage

Small files can occupy much space on Tivoli Storage Manager server storage.

If you are using storage device class FILE on the Tivoli Storage Managerserver, the default minimum block size is 256 KB. Every file that is migrated occupies at least 256 KB in the storage pool. For example, with the default minimum block size, a 50 MB storage volume becomes full with 200 8-KB files.

You can eliminate the default minimum block size if you migrate to a storage pool that is defined with the attribute DATAFORMAT=NONBLOCK. You define storage pool attributes with the Tivoli Storage Manager server command **DEFINE STGPOOL**.

Related reference:

 Server command: DEFINE STGPOOL (https://www.ibm.com/support/knowledgecenter/SSGSG7_7.1.1/com.ibm.itsm.srv.doc/r_cmd_stgpool_psa_define.html)

Appendix. Accessibility features for the Tivoli Storage Manager product family

Accessibility features help users who have a disability, such as restricted mobility or limited vision to use information technology products successfully.

Accessibility features

The IBM Tivoli Storage Manager family of products includes the following accessibility features:

- Keyboard-only operation using standard operating-system conventions
- Interfaces that support assistive technology such as screen readers

The command-line interfaces of all products in the product family are accessible.

Tivoli Storage Manager Operations Center provides the following additional accessibility features when you use it with a Mozilla Firefox browser on a Microsoft Windows system:

- Screen magnifiers and content zooming
- High contrast mode

The Operations Center and the Tivoli Storage Manager Server can be installed in console mode, which is accessible.

The Operations Center help system is enabled for accessibility. For more information, click the question mark icon on the help system menu bar.

Vendor software

The Tivoli Storage Manager product family includes certain vendor software that is not covered under the IBM license agreement. IBM makes no representation about the accessibility features of these products. Contact the vendor for the accessibility information about its products.

IBM and accessibility

See the IBM Human Ability and Accessibility Center (<http://www.ibm.com/able>) for information about the commitment that IBM has to accessibility.

Notices

This information was developed for products and services offered in the U.S.A.

IBM may not offer the products, services, or features discussed in this document in other countries. Consult your local IBM representative for information on the products and services currently available in your area. Any reference to an IBM product, program, or service is not intended to state or imply that only that IBM product, program, or service may be used. Any functionally equivalent product, program, or service that does not infringe any IBM intellectual property right may be used instead. However, it is the user's responsibility to evaluate and verify the operation of any non-IBM product, program, or service.

IBM may have patents or pending patent applications covering subject matter described in this document. The furnishing of this document does not grant you any license to these patents. You can send license inquiries, in writing, to:

*IBM Director of Licensing
IBM Corporation
North Castle Drive, MD-NC119
Armonk, NY 10504-1785
United States of America*

For license inquiries regarding double-byte character set (DBCS) information, contact the IBM Intellectual Property Department in your country or send inquiries, in writing, to:

*Intellectual Property Licensing
Legal and Intellectual Property Law
IBM Japan Ltd.
19-21, Nihonbashi-Hakozakicho, Chuo-ku
Tokyo 103-8510, Japan*

The following paragraph does not apply to the United Kingdom or any other country where such provisions are inconsistent with local law:

INTERNATIONAL BUSINESS MACHINES CORPORATION PROVIDES THIS PUBLICATION "AS IS" WITHOUT WARRANTY OF ANY KIND, EITHER EXPRESS OR IMPLIED, INCLUDING, BUT NOT LIMITED TO, THE IMPLIED WARRANTIES OF NON-INFRINGEMENT, MERCHANTABILITY OR FITNESS FOR A PARTICULAR PURPOSE. Some states do not allow disclaimer of express or implied warranties in certain transactions, therefore, this statement may not apply to you.

This information could include technical inaccuracies or typographical errors. Changes are periodically made to the information herein; these changes will be incorporated in new editions of the publication. IBM may make improvements and/or changes in the product(s) and/or the program(s) described in this publication at any time without notice.

Any references in this information to non-IBM websites are provided for convenience only and do not in any manner serve as an endorsement of those websites. The materials at those websites are not part of the materials for this IBM product and use of those websites is at your own risk.

IBM may use or distribute any of the information you supply in any way it believes appropriate without incurring any obligation to you.

Licensees of this program who want to have information about it for the purpose of enabling: (i) the exchange of information between independently created programs and other programs (including this one) and (ii) the mutual use of the information which has been exchanged, should contact:

*IBM Corporation
2Z4A/101
11400 Burnet Road
Austin, TX 78758
U.S.A.*

Such information may be available, subject to appropriate terms and conditions, including in some cases, payment of a fee.

The licensed program described in this document and all licensed material available for it are provided by IBM under terms of the IBM Customer Agreement, IBM International Program License Agreement or any equivalent agreement between us.

Any performance data contained herein was determined in a controlled environment. Therefore, the results obtained in other operating environments may vary significantly. Some measurements may have been made on development-level systems and there is no guarantee that these measurements will be the same on generally available systems. Furthermore, some measurements may have been estimated through extrapolation. Actual results may vary. Users of this document should verify the applicable data for their specific environment.

Information concerning non-IBM products was obtained from the suppliers of those products, their published announcements or other publicly available sources. IBM has not tested those products and cannot confirm the accuracy of performance, compatibility or any other claims related to non-IBM products. Questions on the capabilities of non-IBM products should be addressed to the suppliers of those products.

This information contains examples of data and reports used in daily business operations. To illustrate them as completely as possible, the examples include the names of individuals, companies, brands, and products. All of these names are fictitious and any similarity to the names and addresses used by an actual business enterprise is entirely coincidental.

COPYRIGHT LICENSE:

This information contains sample application programs in source language, which illustrate programming techniques on various operating platforms. You may copy, modify, and distribute these sample programs in any form without payment to IBM, for the purposes of developing, using, marketing or distributing application programs conforming to the application programming interface for the operating platform for which the sample programs are written. These examples have not been thoroughly tested under all conditions. IBM, therefore, cannot guarantee or imply reliability, serviceability, or function of these programs. The sample programs are provided "AS IS", without warranty of any kind. IBM shall not be liable for any damages arising out of your use of the sample programs.

Each copy or any portion of these sample programs or any derivative work, must include a copyright notice as follows:

Portions of this code are derived from IBM® Corp. Sample Programs.

© Copyright IBM® Corp. _enter the year or years_. All rights reserved.

Trademarks

IBM, the IBM logo, and ibm.com are trademarks or registered trademarks of International Business Machines Corp., registered in many jurisdictions worldwide. Other product and service names might be trademarks of IBM or other companies. A current list of IBM trademarks is available on the Web at "Copyright and trademark information" at www.ibm.com/legal/copytrade.shtml.

Adobe is a registered trademark of Adobe Systems Incorporated in the United States, and/or other countries.

Linear Tape-Open, LTO, and Ultrium are trademarks of HP, IBM Corp. and Quantum in the U.S. and other countries.

Intel and Itanium are trademarks or registered trademarks of Intel Corporation or its subsidiaries in the United States and other countries.

Linux is a registered trademark of Linus Torvalds in the United States, other countries, or both.

Microsoft, Windows, and Windows NT are trademarks of Microsoft Corporation in the United States, other countries, or both.

Java and all Java-based trademarks and logos are trademarks or registered trademarks of Oracle and/or its affiliates.

UNIX is a registered trademark of The Open Group in the United States and other countries.

Terms and conditions for product documentation

Permissions for the use of these publications are granted subject to the following terms and conditions.

Applicability

These terms and conditions are in addition to any terms of use for the IBM website.

Personal use

You may reproduce these publications for your personal, noncommercial use provided that all proprietary notices are preserved. You may not distribute, display or make derivative work of these publications, or any portion thereof, without the express consent of IBM.

Commercial use

You may reproduce, distribute and display these publications solely within your enterprise provided that all proprietary notices are preserved. You may not make derivative works of these publications, or reproduce, distribute or display these publications or any portion thereof outside your enterprise, without the express consent of IBM.

Rights Except as expressly granted in this permission, no other permissions,

licenses or rights are granted, either express or implied, to the publications or any information, data, software or other intellectual property contained therein.

IBM reserves the right to withdraw the permissions granted herein whenever, in its discretion, the use of the publications is detrimental to its interest or, as determined by IBM, the above instructions are not being properly followed.

You may not download, export or re-export this information except in full compliance with all applicable laws and regulations, including all United States export laws and regulations.

IBM MAKES NO GUARANTEE ABOUT THE CONTENT OF THESE PUBLICATIONS. THE PUBLICATIONS ARE PROVIDED "AS-IS" AND WITHOUT WARRANTY OF ANY KIND, EITHER EXPRESSED OR IMPLIED, INCLUDING BUT NOT LIMITED TO IMPLIED WARRANTIES OF MERCHANTABILITY, NON-INFRINGEMENT, AND FITNESS FOR A PARTICULAR PURPOSE.

Privacy policy considerations

IBM Software products, including software as a service solutions, ("Software Offerings") may use cookies or other technologies to collect product usage information, to help improve the end user experience, to tailor interactions with the end user, or for other purposes. In many cases no personally identifiable information is collected by the Software Offerings. Some of our Software Offerings can help enable you to collect personally identifiable information. If this Software Offering uses cookies to collect personally identifiable information, specific information about this offering's use of cookies is set forth below.

This Software Offering does not use cookies or other technologies to collect personally identifiable information.

If the configurations deployed for this Software Offering provide you as customer the ability to collect personally identifiable information from end users via cookies and other technologies, you should seek your own legal advice about any laws applicable to such data collection, including any requirements for notice and consent.

For more information about the use of various technologies, including cookies, for these purposes, see IBM's Privacy Policy at <http://www.ibm.com/privacy> and IBM's Online Privacy Statement at <http://www.ibm.com/privacy/details> in the section entitled "Cookies, Web Beacons and Other Technologies," and the "IBM Software Products and Software-as-a-Service Privacy Statement" at <http://www.ibm.com/software/info/product-privacy>.

Glossary

A glossary is available with terms and definitions for the IBM Tivoli Storage Manager family of products.

See Tivoli Storage Manager glossary (http://www.ibm.com/support/knowledgecenter/SSGSG7_7.1.2/com.ibm.itsm.ic.doc/glossary.html).

To view glossaries for other IBM products, see <http://www.ibm.com/software/globalization/terminology/>.

Index

Special characters

- ADStreams option, **dsmhsmc1c.exe** 108
- ageweight option, **dsmhsmc1c.exe** 108
- Back up Migratable Files option 19
- backupbeforemigrate option, **dsmhsmc1c.exe** 108
- Check stub file reparse content option
 - overview 55
- checkcandidatesinterval option, **dsmhsmc1c.exe** 108
- checkreparsecontent option
 - controlling backups of migrated files 57
- configurereconcile option, **dsmhsmc1c.exe** 103
- configurethresholdmig option, **dsmhsmc1c.exe** 108
- filesystem option
 - dsmhsmc1c.exe** 108
- filespacelist option, **dsmhsmc1c.exe** 103
- help option, **dsmhsmc1c.exe**
 - reconciliation 103
 - threshold migration 108
- highthreshold option, **dsmhsmc1c.exe** 108
- l (log level option)
 - dsmc1c.exe** command
 - createfilesystem** parameter 75
 - defaults** parameter 76, 97
 - delete** parameter 77
 - legend** parameter 79
 - list** parameter 80
 - listfilesystems** parameter 83
 - listmgmtclasses** parameter 85
 - migrate** parameter 86
 - migratelist** parameter 88
 - recall** parameter 90
 - recalllist** parameter 93
 - register** parameter 95
 - dsmhsmc1c.exe** command
 - reconciliation 103
 - threshold migration 108
- lowthreshold option, **dsmhsmc1c.exe** 108
- maxreconcileproc option, **dsmhsmc1c.exe** 103
- maxthresholdproc option, **dsmhsmc1c.exe** 108
- minagetype option, **dsmhsmc1c.exe** 108
- minmigfileage option, **dsmhsmc1c.exe** 108
- minmigfilesize option, **dsmhsmc1c.exe** 108
- monitorinterval option, **dsmhsmc1c.exe** 108
- nextreconcile option, **dsmhsmc1c.exe** 103
- optfile option, **dsmhsmc1c.exe** 108
- query option, **dsmhsmc1c.exe** 103, 108
- reconcileinterval option, **dsmhsmc1c.exe** 103
- reconcilemode option, **dsmhsmc1c.exe** 103
- reconcilenow option, **dsmhsmc1c.exe** 103
- Reset modified last access date option
 - overview 55
- Restore as migrated file option
 - overview 55
 - restoring files 60
- Restore resident if not accessible option
 - overview 55
 - restoring files 60
- restorecheckstubaccess option
 - restoring files 60
- restoremigstate option
 - restoring files 60
- scaninterval option, **dsmhsmc1c.exe** 108
- scannow option, **dsmhsmc1c.exe** 108
- Skip migrated files option
 - overview 55
- skipmigrated option
 - controlling backups of migrated files 57
- Staging Directory option
 - overview 55
- stagingdirectory option
 - controlling location of temporary retrieves 57
- thresholdmignow option, **dsmhsmc1c.exe** 108
- unconfigurereconcile option, **dsmhsmc1c.exe** 103
- unconfigurethresholdmig option, **dsmhsmc1c.exe** 108
- createfilesystem** parameter, **dsmc1c.exe** command 75
- defaults** parameter, **dsmc1c.exe** command 76, 97
- delete** parameter, **dsmc1c.exe** command 77
- dsmc1c.exe** command
 - createfilesystem** parameter 75
 - defaults** parameter 76, 97
 - delete** parameter 77
 - legend** parameter 79
 - list** parameter 80
 - listfilesystems** parameter 83
 - listmgmtclasses** parameter 85
 - migrate** parameter 86
 - migratelist** parameter 88
 - recall** parameter 90
 - recalllist** parameter 93
 - register** parameter 95
 - overview 75
- dsmfileinfo.exe** 100
- dsmfind.exe** 101
- dsmhsmc1c.exe**
 - options
 - configurereconcile 103
 - filespacelist 103
 - help 103
 - l (log level) 103
 - maxreconcileproc 103
 - nextreconcile 103
 - query 103
 - reconcileinterval 103
 - reconcilemode 103
 - reconcilenow 103
 - unconfigurereconcile 103
 - question mark (?) 103
- dsminfo.exe** 113
- dsmmove.exe** 114
- dsmmove** command
 - reference 114
 - tasks 68
 - using 69
- dsmquota.exe** 117
- dsmquota** command
 - reference 117
- dsmtool.exe** 119
- dsmtool** command
 - reference 119
- legend** parameter, **dsmc1c.exe** command 79
- list** parameter, **dsmc1c.exe** command 80
- listfilesystems** parameter, **dsmc1c.exe** command 83

- listmgmtclasses** parameter, **dsmc1c.exe** command 85
- migrate** parameter, **dsmc1c.exe** command 86
- migratelist** parameter, **dsmc1c.exe** command 88
- quota** reset 117
- recall** parameter, **dsmc1c.exe** command 90
- recalllist** parameter, **dsmc1c.exe** command 93
- register** parameter, **dsmc1c.exe** command 95

A

- accessibility features 125
- adding volumes
 - restart IBM TSM HSM Monitor Service 19
 - restart IBM TSM HSM Recall Service 19
- ADS
 - excluding by name 28
- antivirus
 - stub file and recall 12
 - troubleshooting 12

B

- backing up and restoring migrated files 55
- backing up migrated files
 - options 57
- backup before migrate
 - choosing options file 55
- backup options file
 - choosing 55
- backup-archive client
 - backing up and restoring migrated files 55
 - controlling backups of migrated files 57
 - controlling location of temporary retrieves 57
 - controlling restores of migrated files 60
 - limiting temporary file copies 60

C

- calculate migration savings 43
- changing retention of migration copies 26
- closing idle server connections 35
- cluster
 - installation 14
- cluster environment
 - installation planning 12, 15
- command line
 - return codes for operations 74
- commands
 - dsmc1c.exe**
 - createfilepace** parameter 75
 - defaults** parameter 76, 97
 - delete** parameter 77
 - legend** parameter 79
 - list** parameter 80
 - listfilespaces** parameter 83
 - listmgmtclasses** parameter 85
 - migrate** parameter 86
 - migratelist** parameter 88
 - recall** parameter 90
 - recalllist** parameter 93
 - register** parameter 95
 - overview 75
 - dsmfileinfo.exe** 100
 - dsmfind.exe** 101
 - dsmhsmc1c.exe**
 - reconciliation 103

commands (continued)

- dsmhsmc1c.exe** (continued)
 - threshold migration 108
- dsminfo.exe** 113
- dsmmove.exe** 114
- dsmmove**
 - tasks 68
 - using 69
- dsmquota.exe** 117
- dsmtool.exe** 119
- casing 73
- minimum abbreviation 73
- summary 73
- using in executables 74
- using in shell scripts 74
- compatibility with other software 11
- configuration
 - GUI 19
 - cluster environment 14
 - connection to Tivoli Storage Manager server 19
 - initial 19
 - reconciliation
 - dsmhsmc1c.exe** command 103
 - GUI 65
 - threshold migration
 - dsmhsmc1c.exe** command 108
- configuration file
 - setting location 30
- configuration wizard 19
 - cluster environment 14
- configuring HSM client
 - to secondary server 23
- configuring retention of migration copies 24
- connection to Tivoli Storage Manager server 19
 - dsmc1c.exe** command 95
- Connections parameter 29
- ConnectionTimeout parameter 29
- creating file spaces
 - dsmc1c.exe** command 75, 83
 - GUI 28

D

- date format setting 28
- deleting migrated files from storage
 - dsmc1c.exe** command 77, 86
- deleting obsolete quota entries 35
- DirectoryAttributesFilter parameter 29
- disability 125
- display legends for table headers
 - dsmc1c.exe** command 79
- display option defaults
 - dsmc1c.exe** command 76
- downgrade restrictions 13
- drive letters
 - changing
 - reconciliation 64
- dsmhsmc1c.exe
 - options
 - ADStreams 108
 - ageweight 108
 - backupbeforemigrate 108
 - checkcandidatesinterval 108
 - configurethresholdmig 108
 - filepace 108
 - help 108
 - highthreshold 108

- dsmhsmclic.exe (*continued*)
 - options (*continued*)
 - l (log level) 108
 - lowthreshold 108
 - maxthresholdproc 108
 - minagetype 108
 - minmigfileage 108
 - minmigfilesize 108
 - monitorinterval 108
 - optfile 108
 - query 108
 - scaninterval 108
 - scannow 108
 - thresholdmignow 108
 - unconfigurethresholdmig 108

E

- effective quota 33
- emulation mode
 - reconciliation 103
- encryption
 - backup performance 59
- exclude conditions
 - examples 40
 - migration 38
- excluding ADS names 28
- executable file
 - return codes from 74

F

- file group
 - creating 43
 - editing 43
 - overview 42
- file locations 30
- file name limitations 11
- file quota
 - defining 31
- file space
 - configure
 - GUI 28

G

- GUI 19

H

- hardware mapping
 - overview 70
 - task 72
- HSM for Windows client GUI
 - overview 9
- hsmmonitor.exe
 - when to restart 19
- hsmsservice.exe
 - when to restart 19
- hsmtasks service 68

I

- IBM Knowledge Center vii
- IBM Support Assistant 121

- IBM TSM HSM Monitor Service
 - migration trigger 47
 - when to restart 19
- IBM TSM HSM Recall Service
 - backup of stubs 57
 - restoring default security attributes 60
 - when to restart 19
- include conditions
 - examples 40
 - migration jobs 38
- installation
 - cluster environment
 - planning 12, 15
 - network distribution 13
 - user mode 14
- installation planning 11

J

- jobs
 - migration
 - overview 37
 - running 44

K

- keyboard 125
- Knowledge Center vii

L

- language setting 28
- limitations
 - ADS 12
 - file name 11
- limiting temporary file copies 60
- list file
 - settings
 - command 73
 - GUI 35
- list migration
 - overview 45
 - running 88
- listing management class properties
 - dsmclic.exe** command 85
- listing migrated files
 - dsmclic.exe** command 80
- live quota 34
- local file server
 - definition 67
- local stub file
 - definition 67
- local Tivoli Storage Manager server
 - definition 67
- log file
 - settings
 - command 73
 - GUI 35
- log level
 - dsmclic.exe** command
 - createfileospace** parameter 75
 - defaults** parameter 76, 97
 - delete** parameter 77
 - legend** parameter 79
 - list** parameter 80
 - listfilespace** parameter 83

log level *(continued)*

- dsmc1c.exe** command *(continued)*
 - listmgmtclasses** parameter 85
 - migrate** parameter 86
 - migratelist** parameter 88
 - recall** parameter 90
 - recalllist** parameter 93
 - register** parameter 95
- dsmhsmc1c.exe** option
 - reconciliation 103
 - threshold migration 108
- configuring with GUI 30
- Preferences window 30

M

- management class
 - configuring 24, 26
- managing backups
 - migrated files 60
- managing temporary file copies 60
- manually retrieving files
 - GUI 52
- map hardware
 - overview 70
 - task 72
- maximum connections parameter 29
- migrated files
 - backup options 57
 - manually retrieving
 - dsmc1c.exe** command 97
 - GUI 52
 - move
 - details 68
 - overview 67
 - moving
 - task 69
 - restore options 60
- migrating a list of files
 - dsmc1c.exe** command 88
 - description 45
- migration
 - comparison with threshold migration 3
 - defining jobs 38
 - dsmc1c.exe** 44, 45
 - exclude conditions 38
 - include conditions 38
 - jobs 3
 - list 3
 - overview 3
 - retention 8
 - run jobs from HSM for Windows client GUI 44
 - running from command prompt 75
 - running jobs 44
 - scheduling job 45
 - space savings 43
 - threshold
 - candidates 46
 - command 108
 - comparison with migration jobs 3
 - configuring with **dsmhsmc1c.exe** 108
 - migration triggers 47
 - monitoring space usage 47
 - with other input 45
- migration candidates
 - configuration options
 - dsmhsmc1c.exe** 108

migration candidates *(continued)*

- scan 46
 - validation 46
 - weighting 46
- migration copies
 - changing retention 26
 - configuring retention 24
 - migration job files
 - setting location 30
 - migration jobs
 - comparison with threshold migration 3
 - overview 37
 - results 44
 - monitoring space usage 47
 - mount paths
 - changing
 - reconciliation 64
 - move job files
 - setting location 30
 - move migrated files
 - overview 67
 - moving migrated files
 - task 69
 - moving stub files
 - settings 30
 - task 69
 - MSCS cluster
 - installation planning 12, 15
 - msi 13
 - msiexec 13
- ## N
- national language environments 11
 - new features in V7.1.2 ix
 - number format setting 28
- ## O
- offline files 122
 - options
 - Back up Migratable Files 19
 - checkreparsecontent
 - controlling backups of migrated files 57
 - Restore as migrated file
 - restoring files 60
 - Restore resident if not accessible
 - restoring files 60
 - skipmigrated
 - controlling backups of migrated files 57
 - stagingdirectory
 - controlling location of temporary retrieve 57
 - dsmc1c.exe** command
 - createfilepace** 75
 - defaults** 76, 97
 - delete** 77
 - legend** 79
 - list** 80
 - listfilespaces** 83
 - listmgmtclasses** 85
 - migrate** 86
 - migratelist** 88
 - recall** 90
 - recalllist** 93
 - register** 95
 - overview 75

options (*continued*)

- dsmhsmc1c.exe** command
 - ADStreams 108
 - ageweight 108
 - backupbeforemigrate 108
 - checkcandidatesinterval 108
 - configurereconcile 103
 - configurethresholdmig 108
 - filespace 108
 - filespacelist 103
 - help 103,108
 - highthreshold 108
 - l (log level) 103,108
 - lowthreshold 108
 - maxreconcileproc 103
 - maxthresholdproc 108
 - minagetype 108
 - minmigfileage 108
 - minmigfilesize 108
 - monitorinterval 108
 - nextreconcile 103
 - optfile 108
 - query 103,108
 - reconcileinterval 103
 - reconcilemode 103
 - reconcilenow 103
 - scaninterval 108
 - scannow 108
 - thresholdmignow 108
 - unconfigurereconcile 103
 - unconfigurethresholdmig 108
 - question mark (?) option 103, 108
 - reconciliation
 - Reconcile settings window 65
 - threshold migration
 - dsmhsmc1c.exe** command 108
- options file
- backup-archive
 - choosing 55

P

- parameters
 - advanced 29
- password restrictions 22
- Path Configuration 30
- preparing for installation 13
- prerequisites
 - hardware and software 11
- preview reconciliation deletions 122
- previously migrated files 7
- publications vii

Q

- question mark (?) option **dsmhsmc1c.exe** 103
- quotas
 - default 32
 - defining 31
 - resetting 34
 - user
 - live 34
 - viewing and changing 33

R

- recall modes
 - overview 5
- recall quota
 - deleting obsolete quota entries 35
- recall quotas
 - default 32
 - effective user quota 33
 - user 33
 - live 34
- recall service
 - closing idle server connections 35
 - deleting obsolete quota entries 35
 - settings 35
 - threads 35
- recalling a list of stub files
 - dsmc1c.exe** command 93
- recalling selected stub files
 - dsmc1c.exe** command 90
- Reconcile settings window 65
- reconcileinterval
 - option 8
- reconciliation
 - configuration
 - dsmhsmc1c.exe** command 103
 - GUI 65
 - emulation mode 103
 - overview 8
 - Reconcile settings window 65
 - running 62
 - settings 62
 - space requirements 67
- regional settings 28
- registering a connection
 - dsmc1c.exe** command 95
- remote file server
 - definition 67
- remote stub file
 - definition 67
- remote Tivoli Storage Manager server
 - definition 67
- rename file server
 - continue HSM
 - concept 70
 - task 72
- rename volume
 - continue HSM
 - concept 70
 - task 72
- replace file server
 - continue HSM
 - concept 70
 - task 72
- replace volume
 - continue HSM
 - concept 70
 - task 72
- resetting quotas 34
- restoring migrated files
 - backup-archive client
 - options 60
- retention of migrated files 8
- retrieving files
 - dsmc1c.exe** command 97
 - GUI 52
 - Windows alternate data stream (ADS) data 97
- return codes for operations 74

running
migration jobs 44

S

scan for migration candidates 46
search and retrieve files
 dsmc1c.exe command 97
 GUI 52
security attributes
 restoring the default 60
selective recall 5
selective retrieve 5
shell scripts
 return codes from 74
 using commands in 74
Storage space
 small migrated files occupy much space 123
stub files
 backup 57
 move 68
 overview 67
 move settings 30
 moving 69
 overview 6
 selective list recall
 dsmc1c.exe command 93
 selective recall
 dsmc1c.exe command 90
Symantec Antivirus 12
system volume
 space management 51
 threshold migration 51

T

temporary files
 setting location 30
threshold migration
 candidates 46
 comparison with migration jobs 3
 configuration
 dsmhsmc1c.exe command 108
 migration triggers 47
 monitoring space usage 47
 summary 46
 system volume 51
time zone setting 28
Timeout parameter 29
Tivoli Storage Manager server
 configuring connection
 dsmc1c.exe command 95
 cluster environment 14
 GUI 19
trace file
 settings
 command 73
 GUI 35
transparent recall 5
troubleshooting
 antivirus 12
 preview reconciliation deletions 122
 steps 121

U

Unicode setting 28
upgrade from HSM V7.1.1 and earlier 17
user mode installation 14

V

validation of migration candidates 46
view migration job results 44
volume
 changing drive letters
 reconciliation 64
VSS problems 122

W

weighting of migration candidates 46
Windows alternate data stream (ADS) data 17
 new features in V7.1.2 ix
 recall restriction 5
 retrieving 97



Product Number: 5608-E13

Printed in USA